

Premasking and Prespacing Tape for Graphic Films

3M™ Premasking Tape SCPM-3, 3M™ Premasking Tape SCPM-44X

3M™ Prespacing Tape SCPS-2, 3M™ Prespacing Tape SCPS-53X,

3M™ Prespacing Tape 55

Product Description

An application tape is an adhesive-backed translucent material that is used as an aid in applying graphics.

- Typical uses of application tapes are:
 - to add stiffness to make application easier.
 - to protect the film from stretching during application.
 - to protect the graphic image from scratching during application.
 - to aid in the registration of cut graphic parts.
 - to protect applied graphics from damage during other operations.
- Differences between application tapes are described below.
 - Each tape has a different level of adhesion. This ensures that the tape you use has a lower adhesion to the film than the film does to the substrate.
 - Choose the recommended application tape for your application to ensure easy removal. See [3M Instruction Bulletin AT-1](#) for details.
- Determining what type of application tape to use depends on the type of graphic and the last component of the graphic construction (i.e., the top of the graphic). See [3M Instruction Bulletin AT-1](#) for details.

Product Line

- [3M™ Premasking Tape SCPM-3](#)
- [3M™ Premasking Tape SCPM-44X](#)
- [3M™ Prespacing Tape SCPS-2](#)
- [3M™ Prespacing Tape SCPS-53X](#)
- [3M™ Prespacing Tape SCPS-55](#)

Characteristics

These are typical values for unprocessed product. Processing may change the values.

Physical Characteristics

Characteristic	Value
Tape material	Paper
Thickness	4.5–5 mils (0.11–0.12 mm)
Adhesive type and color	Pressure-sensitive, clear
Adhesion to 3M graphic film	0.39–0.77 pounds/inch (69–138 g/cm) Note: Each tape has a different adhesion, designed to work with the films, inks, and graphic protection as recommended in 3M Instruction Bulletin AT-1 .
Tensile strength	5 pounds/inch at 73 °F (0.9kg/cm at 23 °C)
Service temperature range	Same as the film with which it is used

Quick Links

[3M Graphics Warranties](#)
[Technical Information Selector](#)
[Safety Data Sheets \(SDS\)](#)
[Videos](#)

Some of these links lead to web-based resources that are not product-specific.

Warranty Information

Warranty Coverage Overview

The warranty coverage for eligible graphics is based on the user both reading and following all applicable and current 3M Graphics Product and Instruction Bulletins. The warranty period for eligible graphics is as stated in the 3M Graphics Warranties Matrices at the time that the film was purchased. Information found at 3MGraphics.com/warranties includes:

- [3M Graphics Warranties Bulletin](#)
 - This bulletin contains information on limitations and exceptions, and warranty period reductions for 3M Graphics Warranties. The warranty period may be reduced and stipulations may apply for certain constructions, applications, and graphic exposures as covered in this Bulletin.
- [3M Graphics Warranties Selector](#)
 - Use this selector to search for your vertical warranty period by product type, ink type, film name, and/or ink/printer platform.
- [U.S. Desert Southwest Region Map](#)
 - Use this map of hot, arid desert areas to determine if you are subject to reduced warranted durabilities.

The warranties set forth in this Bulletin are made in lieu of all other express or implied warranties, including any implied warranty of merchantability, fitness for a particular purpose, or arising out of a course of dealing, custom, or usage of trade.

3M Basic Product Warranty

3M Graphics Products are warranted to be free of defects in materials and manufacture at the time of shipment and to meet the specifications stated in its applicable 3M Graphics Product Bulletin and as further set forth in the [3M Graphics Warranties Bulletin](#).

Limited Remedy

The limited remedy applicable to each warranty is addressed in the 3M Graphics Warranties Bulletin found at 3MGraphics.com/warranties.

Limitation of Liability

Except where prohibited by law, 3M SHALL NOT UNDER ANY CIRCUMSTANCES BE LIABLE TO PURCHASER OR USER FOR ANY DIRECT (EXCEPT FOR THE LIMITED REMEDY PROVIDED IN THE 3M GRAPHICS WARRANTIES BULLETIN), INDIRECT, SPECIAL, INCIDENTAL, OR CONSEQUENTIAL DAMAGES (INCLUDING, BUT NOT LIMITED TO, LABOR, NON-3M MATERIAL CHARGES, LOSS OF PROFITS, REVENUE, BUSINESS, OPPORTUNITY, OR GOODWILL) RESULTING FROM OR IN ANY WAY RELATED TO 3M'S GRAPHICS PRODUCTS, SERVICES, or THIS BULLETIN. This limitation of liability applies regardless of the legal or equitable theory under which such losses or damages are sought.

Health and Safety

CAUTION

When handling any chemical products, read the manufacturer's container labels and the Safety Data Sheets (SDS) for important health, safety and environmental information. To obtain SDS sheets for 3M products go to 3M.com/SDS, or by mail or in case of an emergency, call 1-800-364-3577 or 1-651-737-6501.

When using any equipment, always follow the manufacturer's instructions for safe operation.

Usage Recommendations

Application tape is not required for all films or types of applications and it is specifically not recommended for certain film or applications. Refer to the most current 3M Product and Instructions Bulletins for information on specific constructions and end use recommendations.

IMPORTANT NOTE

Refer to [3M Instruction Bulletin AT-1](#) for recommended Premasking Tapes and Prespacing Tapes specific to 3M films.

When to Use Premasking Tape

- Use as an application aid to increase stiffness, and prevent stretching and damage during application. See “Application Tape as An Application Aid” on page 3.
- Use when little or no liner is exposed.
- Use if the graphic consists of large letter or wide stroke width.
- Use to protect the graphic when used in combination with spray painted clears. See “Premasking Tape in Overpaint Systems” on page 4.

When to Use Prespacing Tape

- Hold cut and weeded letters or graphics in registration after removing the film liner. See “Prespacing Tape for Cut Graphics” on page 4.
- Protect cut graphic parts from scratching or damage during application.
- Use when large amounts of liner are exposed.
- Use if the graphic consists of small letters or narrow stroke width.

Application Tape as An Application Aid

An application tape can reduce stretching, wrinkling, and air entrapment during hand application of the graphic film to the substrate. The tape increases the stiffness of the graphic, which makes the graphic easier to handle.

An application tape is typically recommended when the graphic meets at least one of these criteria:

- Graphic constructions less than 4 mils thick (film or film and overlamine).
- Graphics that are four square feet (0.4 m²) or larger.
- Striping or intricately-cut graphics.
- Vinyl films printed with solvent-based inkjet inks.
- Graphics applied at high temperatures.

IMPORTANT NOTE

Do not use an application tape on textured substrates such as [3M™ Wrap Film 1080 Carbon Fiber films](#). The graphic may not have enough initial adhesion to the substrate for the application tape to be removed without lifting the graphic.

Premasking Tape in Overpaint Systems

Application tape can protect the graphic from staining when overpainted with most finish paints. This allows you to apply premasked graphics to the prime coat and then apply the finish coat around the graphic. This method effectively edge seals the graphic by embedding the graphic in the paint. The application tape should be removed while the paint is still tacky, but not wet.

Refer to [3M Instruction Bulletin 5.4](#) for complete details.

CAUTION

Before using any equipment, always read the manufacturer's instructions for safe operation.

Prespacing Tape for Cut Graphics

Applying an application tape to prespaced cut graphic parts eliminates the time-consuming layout of individual parts on the application surface.

About Removing Film from Liners

IMPORTANT NOTE

Graphic film with 3M™ Comply™ Adhesive, or 3M™ Controltac™ Graphic Films: Do not remove these films from their liners and then attempt to reapply the film to the liner. The liners on these films play an important role in how the films apply to a substrate. Key application features will be lost if you prematurely remove the liner.

For films with 3M™ Comply™ Adhesive where there is liner exposed, use only 3M™ Prespacing Tape SCPS-55 and with 3M™ Comply™ v3 Adhesive specifically, use this prespacing tape for only large cut graphics. See “When to Use Prespacing Tape” on page 3.

Procedure for Prespacing Graphics

1. Follow the recommended cutting sizes found in each film's 3M Product Bulletin.
2. Make the cut only through film and adhesive. Refer to [3M Instruction Bulletin 4.1](#) for specific recommendations.
3. Weed (remove) the background material that will not be used in the graphic.

IMPORTANT NOTE

Use caution to avoid lifting very narrow characters from the liner.

4. Apply the appropriate application tape specified in [3M Instruction Bulletin AT-1](#). See “Techniques for Applying Application Tape” on page 6.
5. Trim the graphic to size.

IMPORTANT NOTE

Always check for ease of part pick up before releasing the job. This is particularly important if the cut graphics include small letters, narrow stroke letters or intricate designs with narrow stroke widths or if applying prespacing tape to an exposed liner of a film with 3M™ Comply™ Adhesive.

6. If the prespacing tape does not adequately pick up the cut graphic parts or adhere well to the liner, a heat lamp vacuum applicator may be required. Process the graphic with its prespacing tape in a heat lamp vacuum applicator at 150 - 180 °F (66 - 82 °C). The duration of this process is dependent upon the type of equipment used. Typically, a two-minute cycle with little or no dwell time at the peak temperature will provide satisfactory results.

7. If the prespacing tape does not remove all of the prespaced cut graphic parts easily from the liner, reapply the tape using a squeegee to secure the elements back to the liner. Then gently pull the graphic, liner-side down, over the corner edge of a surface. This helps loosen any embedded kiss cut edges. See Figure 1 below.

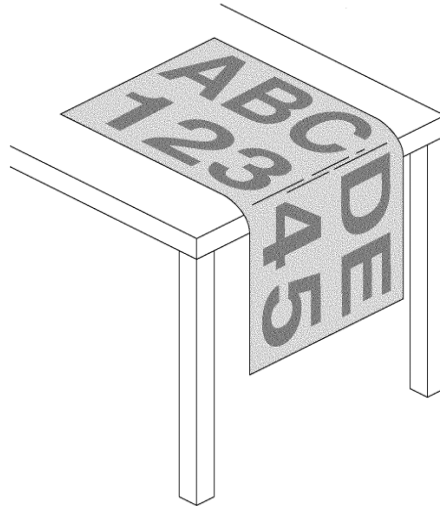

Figure 1. Loosening Prespaced Graphics from a Liner

Printing Instructions on Application Tapes

The surface of the application tape can be printed with application instructions and registry marks that aid in positioning and application. These tapes have been successfully printed using the following methods: screen printing, hand printing/stamping, and press printing. Check with an ink manufacturer for assistance in selecting and using an ink for printing application tape. 3M does not provide an ink for this use.

Refer to the ink container labels and the ink manufacturer's Safety Data Sheet for health, safety, and handling information.

One recommended supplier is Nazdar Inc. at 800-767-9942 or www.nazdar.com (website includes SDS sheets).

Screen Printing

1. Screen print using NazDar® 9700 air dry ink or an equivalent. Use a 200 to 305 tpi (threads per inch) screen or equivalent.
2. Rack and air dry for 30 minutes.

Hand Printing

Hand stamp using the NazDar® 4411 black ink or equivalent.

Press Printing

Use a fast drying halftone black. Avoid heavy ink laydown.

Protecting Graphics During Vehicle Refinishing

To protect existing 3M graphics when a vehicle is being refinished, use the application tape recommended in [3M Instruction Bulletin AT-1](#) for the last applied component of the vehicle's existing graphic.

1. Cover the graphic with a slightly oversized piece of application tape.
2. Cut carefully around the edges with a sharp razor blade.

3. Remove the excess tape.
4. Apply the paint.
5. Remove the application tape while paint is still tacky, but not wet.

Techniques for Applying Application Tape

In addition to other 3M Bulletins specified in this document, the following Bulletins provide details that you may need to successfully apply a graphic.

- [3M Instruction Bulletin 5.1](#) Select and Prepare Substrates for Graphic Application
- [3M Instruction Bulletin 5.37](#) A Guide to Understanding and Applying Graphics to Common Smooth and Textured Wall Surfaces
- [3M Instruction Bulletin 5.5](#) Application, General Procedures for Interior and Exterior Dry Application

Preparation of Printed Graphics Before Applying Application Tape

Be sure that printed graphics are thoroughly dried or cured before applying application tape. For specific recommendations, see the 3M Instruction Bulletin for the inks being used.

If the sheets must be stacked, wrap the stacks with polyethylene and seal to minimize moisture absorption or loss during storage and handling. This can prevent uneven moisture absorption or loss, both of which results in the edges of the sheets waving or curling.

Cutting Films with Application Tape

Certain precautions should be noted when cutting. Refer to [3M Instruction Bulletin 4.1](#) for specific recommendations.

Hand Premasking Procedure

1. Lay an appropriately-sized piece of application tape adhesive-side-up on a table. See Figure 2.

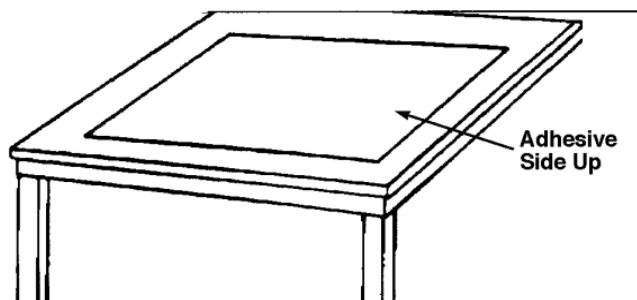

Figure 2. Lay the Application Tape Adhesive-Side-Up

- Align the graphic face-down on the application tape adhesive. See Figure 3.

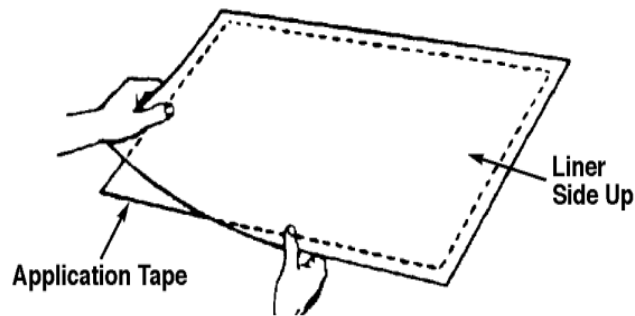

Figure 3. Align the Graphic Face Down

- Squeegee the graphic from the liner side to adhere the application tape. Work from the center out. See Figure 4.

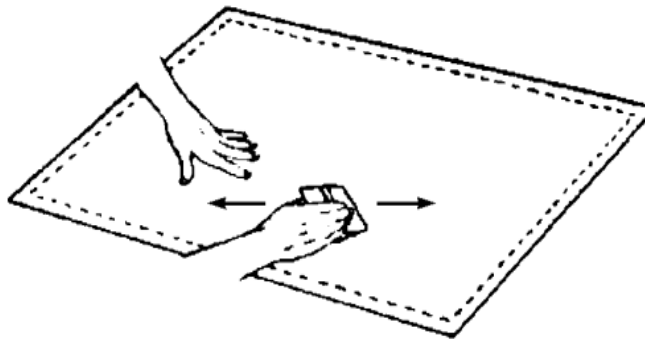

Figure 4. Squeegee the Graphic and Application Tape

- Flip the entire graphic/application tape assembly over and squeegee the application tape side. Again, work from the center out.
- Trim the graphic to size or cut it to shape. See “Cutting Films with Application Tape” on page 6.

Mechanical Lamination

Numerous laminators are available. Figure 5 provides two examples. Follow the manufacturer’s operating and safety procedures.

CAUTION

Before using any equipment, always read the manufacturer’s instructions for safe operation.

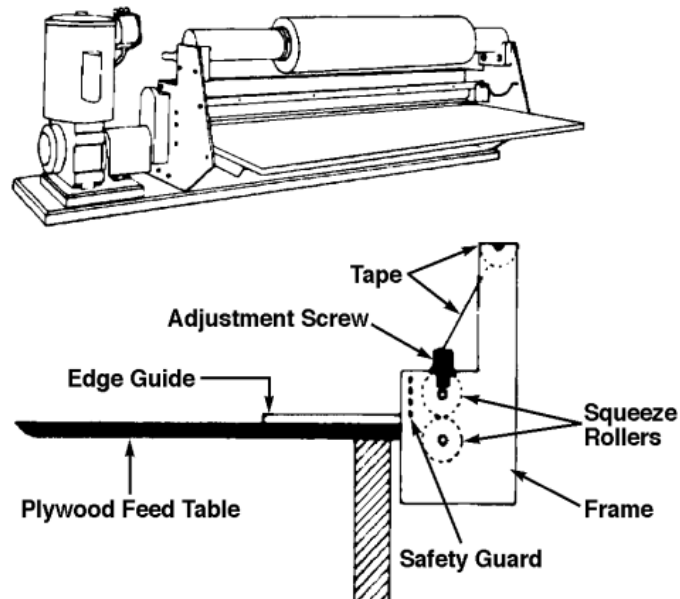

Figure 5. Examples of Mechanical Equipment

Suggestions When Using 3M Application Tapes

- Do not apply brake pressure to the application tape feed roller. Brake pressure stretches the tape during lamination causing the application tape to shrink on the finished graphic.
- The application tape laminator should have at least one rubber squeeze roller at the nip site.
- The recommended nip pressure setting depends on the device used. In general, higher pressures and temperatures will provide higher adhesion of the application tape to the film and exposed liner. Excessive pressure can cause the application tape or the film's liner to curl.
- An edge guide and a feed table can be used to keep the graphic aligned with the application tape.
- After completing a job, the laminator may be left threaded, but remove the pressure from the squeeze rollers. Prolonged pressure flattens the rollers, which can cause lamination problems.
- A heated roller may be used up to a temperature of 200 °F (93 °C).

Techniques for Removing the Liner and Application Tape

- To remove a liner, always peel the liner away from the graphic construction (application tape/graphic film).

i IMPORTANT NOTE

Never peel the graphic construction away from its liner; this can stretch or distort the underlying graphic.

- To remove the application tape after the graphic film is properly applied to the substrate:
 - a. Remove the application tape by peeling it away from the graphic film at a low angle of approximately 180°.
 - b. Resqueegee all edges to ensure good adhesion to the substrate.

Video

Click [here](#) to watch a video on prespacing cut graphics and see how to peel the application tape away from the graphic.

Shelf Life, Storage, Handling

An application tape helps graphics resist normal surface abrasion during storage, handling, and application.

As tape ages or when stored at elevated temperatures, its adhesive becomes more aggressive. Unrolling the tape during mechanical application can cause the tape to stretch resulting in pop-off and curl of the graphic. If the graphic has been improperly stored, the tape can be difficult to remove from finished graphics making removal more difficult and resulting in edge lifting.

Unused Application Tape

- The shelf life is one year from the date of manufacture.
 - The date of manufacture can be found on the packaging by looking at the core tag.



SCPS-2, SCPM-3, SCPS-53X

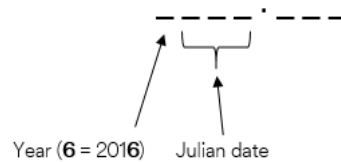

SCPM-44X, SCPS-55

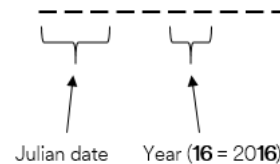

Figure 6. Core Tag Location and Date of Manufacture Key

- Store in a cool, dry place, suspended horizontally from the core.
- Avoid exposure to sunlight.

Graphics with Application Tape Applied

- After the application tape has been applied to the graphic, store in a cool, dry place and avoid exposure to sunlight.
- Most films: Store flat or wrapped onto cores with a minimum diameter of 6 inches (15 cm). Wrap so the side of the film with the application tape faces out.
- [3M™ Scotchlite™ Removable Reflective Graphic Film with Comply™ Adhesive Series 680CR](#) and [3M™ Scotchlite™ Removable Reflective Graphic Film with Comply™ Adhesive IJ680CR-10](#): Finished graphics with exposed liner and application tape, must be shipped lying flat. This method will help prevent the graphics and prespacing tape from popping off the liner.
- Typically, most finished graphics should be applied within one year from the date of its processing or by the total shelf life date of the base film, whichever comes first. Always refer to the base film's 3M Product Bulletin for your specific application.

i IMPORTANT NOTE

After applying application tape, avoid exposing the graphic to sunlight except during application. Sunlight, or UV light, can cause the tape to permanently bond to the film.

Bulletin Change Summary

For the most current 3M Technical Information available to successfully use this product, please view this Bulletin electronically and click on the blue underlined links to view the relevant documents. Please read the entire Bulletin thoroughly.

Release P OCT-2016:

- Updated Shelf-Life to state “date of manufacture”, and added figure. See “Unused Application Tape” on page 9.

Release O JUN-2016:

- Updated Adhesion to 3M graphic film. See “Physical Characteristics” on page 1.

Release N MAR-2016:

- Updated to new format.

Commercial Solutions

3M Center
Building 220-12E-04
St. Paul, MN 55144-1000
Phone 1-800-328-3908
Web 3M.com/Graphics

3M Canada

PO Box 5757
London, ON N6A 4T1
1-800-265-1840
Fax 519-452-6245

3M México S.A. de C.V.

Av. Santa Fe No. 55
Col. Santa Fe, Del. Alvaro
Obregón
México D.F. 01210
General 5255-5270-0400
Fax 5255-5270-2277

3M Puerto Rico, Inc.

350 Chardon Avenue
Suite 1100
San Juan, PR 00918
General 787-620-3000
Fax 787-620-3018

