



Science.
Applied to Life.™



The right choice.

3M™ Abrasives for Right-Angle Systems

Cut, grind, finish and more...
with a world-class abrasive system that
helps you **work smarter, finish faster!**

FEATURING
Advanced Series

Designed for value-priced performance!

Your power team for
metal fabrication
and finishing.

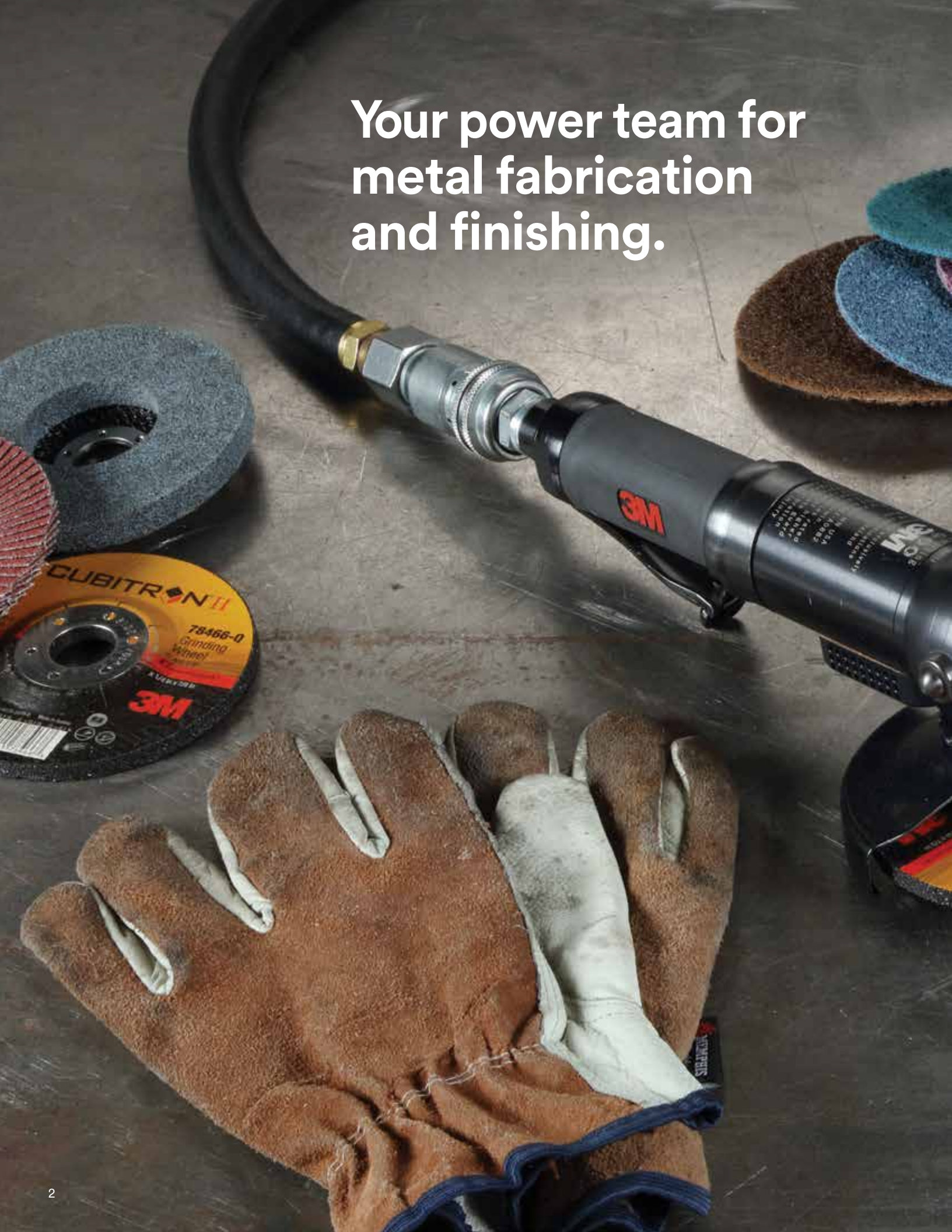



3M™ Abrasive Discs and Wheels offer innovative solutions for tackling a range of applications. Developed with cutting-edge abrasives technology, these products deliver the performance and quality you need. And we offer a variety of brands and grades to fit your budget and application.

Table of Contents



3M™ Cubitron™ II and Advanced Series – Selection Guide	6
Depressed Center Grinding Wheels	10
Fibre Discs	12
Flap Discs	14
Cut & Grind Wheels	18
Cut-Off Wheels	20
Scotch-Brite™ – Selection Guide	22
Light Grinding and Blending Discs	24
Clean & Strip Discs	25
Surface Conditioning Discs	26
Power Tools and Accessories	28
Single Packs	30



General Guidelines

Which portfolio is best for your customer?

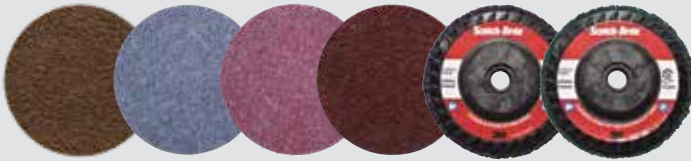
Choose 3M™ Cubitron™ II Abrasives for their legendary speed and long life, or Advanced Series discs and wheels for value-priced performance. Scotch-Brite™ Abrasives deliver consistent, reproducible results, making it easy to ensure quality finishes.

What's most important?	Choose this family of 3M Abrasives
Speed and long life – to improve productivity and lower <u>overall</u> production costs	Premium Series – 3M™ Cubitron™ II Abrasives CUBITRON™ II 
Consistency and ease of use – to improve surfaces without significantly changing the workpiece	Premium Series – Scotch-Brite™ Abrasives Scotch-Brite™ 
Value-priced performance – to minimize abrasive spend while getting the job done efficiently	Advanced Series – 3M™ Abrasives 3M 

Bonded wheel product comparisons

Speed and durability rated on a scale of 1 to 5, with 5 stars being the best.



Attributes	Aluminum oxide	Alumina zirconia	3M™ Silver	3M™ Cubitron™ II
Durability / Life	**	***	*****	*****
Speed of Cut	*	**	***	*****
Feel: Smooth	**	***	****	*****
Contaminant-free* (for stainless/inox)	varies	varies	yes	yes
Abrasive Cost per Job	\$\$\$	\$\$	\$	\$\$
Total Cost of Job (Abrasive, Labor, Processes)	\$\$\$\$	\$\$\$	\$\$	\$

* Contains less than 0.1% Fe, S and Cl

Complete your lineup.

Genuine 3M™ Power Tools *(See page 28)*

These professional grade sanders, grinders and cut-off wheel tools are optimized for use with 3M™ Cubitron™ II Abrasives and 3M™ Abrasives. **Light, rugged and powerful!**



3M Personal Protective Equipment*



Light weight, comfortable welding helmet with advanced auto-darkening optics that adjust to your working conditions.

3M™ Speedglas™ Welding Helmet 9002NC
(PN 04-0100-20NC)



Help protect your forehead and face against sparks, chips and debris.

3M™ Ratchet Headgear Head and Face Protection
(PN 82783-00000)



Comfortable eye protection with anti-fog lenses for a clear view of your workpiece.

3M™ SecureFit™ Protective Eyewear
(PN SF401AF)



Quick, comfortable hearing protection that stays clean, even when your hands are dirty.

3M™ E-A-R™ UltraFit™ Corded Earplugs
(PN 340-4004)

Accessories for 3M™ Right Angle Systems

(See page 29)



3M™ Disc Pad Hub



3M™ Disc Pad Face Plates



3M™ Hook-and-Loop Disc Pad Holders



3M™ Disc Retainer Nuts

*When properly selected and worn according to the User instructions, 3M Personal Protective Equipment (PPE) helps reduce exposure to certain hazards. Before use, Before use, the employer must conduct an appropriate hazard assessment, select and provide appropriate PPE, and the wearer must read and understand the User Instructions provided as a part of the product packaging. Follow all local regulations. Misuse may result in sickness or death. For correct use, consult supervisor and User Instructions, or call 3M Personal Safety Division (PSD) Technical Service in the U.S.A. at 1-800-243-4630. In Canada, call 1-800-267-4414.

Meet the

Premium Series

of right angle abrasives
for unparalleled power
and performance!









Featuring:





- ▶ 3M™ Cubitron™ II Abrasives for an unbeatable combination of speed and long life
- ▶ Scotch-Brite™ Abrasives for ease of use and consistent quality finishes.

Introducing the

Advanced Series

of right angle abrasives
designed for value-priced
performance!

	Product	Weld Prep	Beveling
	3M™ Cubitron™ II Depressed Center Grinding Wheels		◆
	3M™ Cubitron™ II Fibre Discs 982C & 987C		◆
	3M™ Cubitron™ II Flap Discs	◆	◆
	3M™ Cubitron™ II Cut & Grind Wheels		◆
	3M™ Cubitron™ II Cut Off Wheels	◆	
	Scotch-Brite™ Light Grinding & Blending Discs	◆	
	Scotch-Brite™ Clean & Strip XT PRO/Extra Cut Discs	◆	
	Scotch-Brite™ AL Surface Conditioning Discs		
	Scotch-Brite™ Surface Conditioning Discs		

	Product	Weld Prep	Beveling
	3M™ Silver Depressed Center Grinding Wheels		◆
	3M™ Fibre Discs 782C/787C		◆
	3M™ Flap Discs 769F	◆	◆
	3M™ Silver Cut Off Wheels		
	3M™ Cut & Grind Wheels		◆

◆ Recommended application

Heavy Deburring, Slag Removal	Weld Grinding	Blending	Finishing/ Surface Prep	Cutting	Back Gouging	Fillet Weld Removal
◆	◆					
◆	◆					
◆	◆	◆	◆			
	◆			◆	◆	◆
				◆		
		◆	◆			
			◆			
		◆	◆			
		◆	◆			

Heavy Deburring, Slag Removal	Weld Grinding	Blending	Finishing/ Surface Prep	Cutting	Back Gouging	Fillet Weld Removal
◆	◆					
◆	◆					
◆	◆	◆	◆			
				◆		
	◆			◆	◆	◆



Premium Series

Featuring 3M™ Cubitron™ II Abrasives for an unbeatable combination of speed and long life, and Scotch-Brite™ Abrasives for ease of use and consistent quality finishes.

CUBITRON II

Advanced Series

The next-best thing to our Premium Series of 3M™ Cubitron™ II Abrasives, our new Advanced Series harnesses the power of 3M Precision-Shaped Grain and helps minimize your abrasive spend.

3M

Optimized for applications including:

- ▶ Beveling
- ▶ Blending
- ▶ Cutting
- ▶ Deburring
- ▶ Grinding
- ▶ Weld removal

Used in industries such as:

- ▶ Agricultural, industrial and construction machinery
- ▶ General metal fabrication
- ▶ Oil and gas
- ▶ Ship building
- ▶ Stainless steel fabrication
- ▶ Structural steel

The Science of Precision-Shaped Grain

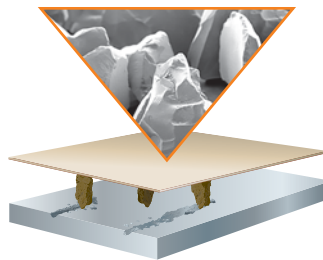

Conventional ceramic abrasive grain tends to “plow” through the metal, causing heat to build up in the workpiece and the abrasive – resulting in a slower cut and shorter abrasive life.

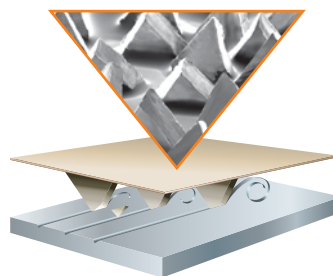

3M precision-shaped grain uses 3M microreplication technology to form sharp peaks that easily “slice” through metal — cutting cooler, faster and lasting longer than conventional abrasive grain.

3M™ Cubitron™ II Depressed Center Grinding Wheels

Go the distance.

3M™ Cubitron™ II Depressed Center Grinding Wheels are fast cutting, long lasting and require less pressure. These cool cutting wheels are ideal for heavy grinding and weld removal. Specially formulated for use on stainless and mild steel. Available with quick change attachment. **DO NOT USE ON TOOLS WITHOUT GUARDS.**

3M™ Cubitron™ II Depressed Center Grinding Wheel – T27

Diameter x Thickness x Arbor Hole (inches)	UPC	Max. RPM	Quantity (Inner/Case)
4 x 1/4 x 3/8	05115-78469-9	15,300	10/20
4 x 1/4 x 5/8	05115-78468-2	15,300	10/20
4 1/2 x 1/4 x 7/8	05115-78466-8	13,300	10/20
5 x 1/4 x 7/8	05115-78467-5	12,250	10/20
6 x 1/4 x 7/8	076308-64314-0	10,200	10/20
7 x 1/4 x 7/8	076308-64315-7	8,500	10/20
9 x 1/4 x 7/8	076308-64316-4	6,650	10/20

3M™ Cubitron™ II Depressed Center Grinding Wheel – T27 Quick Change

Diameter x Thickness x Arbor Hole (inches)	UPC	Max. RPM	Quantity (Inner/Case)
4 1/2 x 1/4 x 5/8-11	076308-64320-1	13,300	10/20
5 x 1/4 x 5/8-11	076308-64317-1	12,250	10/20
6 x 1/4 x 5/8-11	076308-64318-8	10,200	10/20
7 x 1/4 x 5/8-11	076308-64319-5	8,500	10/20
9 x 1/4 x 5/8-11	051125-87153-2	6,650	10/20



3M™ Silver Depressed Center Grinding Wheels

The next-best thing to a 3M™ Cubitron™ II Wheel.
And it still beats the competition, hands down.

3M Silver Depressed Center Grinding Wheels (DCGW) represent a new class of long-lasting right-angle abrasives – powered by the legendary speed and long life of 3M Precision-Shaped Grain and engineered to offer an outstanding value, when abrasive cost takes precedence over reducing total production time. They are an ideal choice for applications like weld removal, beveling, edge chamfering and more – offering a longer life and faster cut than aluminum oxide, alumina zirconia and conventional ceramic abrasives.

3M™ Silver Depressed Center Grinding Wheel – T27

Diameter x Thickness x Arbor Hole (inches)	UPC	Max. RPM	Quantity (Inner/Case)
4 x ¼ x ¾	051125-87455-7	15,300	10/20
4 x ¼ x ¾	051125-87456-4	15,300	10/20
4½ x ¼ x ¾	051125-87453-3	13,300	10/20
5 x ¼ x ¾	051125-87454-0	12,250	10/20
6 x ¼ x ¾	051125-87450-2	10,200	10/20
7 x ¼ x ¾	051125-87451-9	8,500	10/20
9 x ¼ x ¾	051125-87452-6	6,650	10/20

3M™ Silver Depressed Center Grinding Wheel – T27 Quick Change

Diameter x Thickness x Arbor Hole (inches)	UPC	Max. RPM	Quantity (Inner/Case)
4½ x ¼ x ¾-11	051125-87397-0	13,300	10/20
5 x ¼ x ¾-11	051125-87446-5	12,250	10/20
6 x ¼ x ¾-11	051125-87447-2	10,200	10/20
7 x ¼ x ¾-11	051125-87448-9	8,500	10/20
9 x ¼ x ¾-11	051125-87449-6	6,650	10/20



What's the bottom line?

For customers who can see the value in productivity and shop savings, always lead with **Cubitron II Depressed Center Grinding Wheels**.

- ✓ Highest productivity
- ✓ Lowest overall production cost

For customers who are cost-driven, suggest **3M Silver Depressed Center Grinding Wheels** as an alternative with excellent performance.

- ✓ High productivity
- ✓ Lowest overall abrasive spend

3M™ Cubitron™ II Fibre Discs

Grinding reinvented.

Cubitron II Fibre Discs are engineered to cut faster, cooler and with less grinding pressure than conventional abrasives. And they are long lasting for increased productivity!

Choose **Cubitron II Fibre Discs 987C** for cool cutting on stainless steel, high-nickel alloys and superalloys. For carbon steel applications, try our **Cubitron II Fibre Discs 982C**.

3M™ Cubitron™ II Fibre Disc 982C for carbon steel

Diameter* (inches)	Grade	UPC (051141-)	Max. RPM	Min/Case
4½ × ⅞	36+	27400-3	13,300	25/100
	60+	27631-1	13,300	25/100
	80+	27635-9	13,300	25/100
4½ × TN**	36+	27425-6	13,300	25/100
	60+	27639-7	13,300	25/100
	80+	27642-7	13,300	25/100
5 × ⅞	36+	27401-0	12,000	25/100
	60+	27632-8	12,000	25/100
	80+	27636-6	12,000	25/100
5 × TN**	36+	27404-1	12,000	25/100
	60+	27640-3	12,000	25/100
	80+	27643-4	12,000	25/100
5 × GL**	36+	27406-5	12,000	25/100
	80+	27402-7	8,600	25/100
7 × ⅞	60+	27633-5	8,600	25/100
	80+	27637-3	8,600	25/100
	36+	27405-8	8,600	25/100
7 × TN**	60+	27641-0	8,600	25/100
	80+	27644-1	8,600	25/100
	36+	27407-2	8,600	25/100
7 × GL**	60+	27403-4	6,600	25/100
	80+	27638-0	6,600	25/100
9⅞ × ⅞	60+	27634-2	6,600	25/100
	80+	27638-0	6,600	25/100

3M™ Cubitron™ II Fibre Disc 987C for stainless steel and other heat-sensitive alloys

Diameter* (inches)	Grade	UPC (051141-)	Max. RPM	Min/Case
4½ × ⅞	36+	27447-8	13,300	25/100
	60+	27653-3	13,300	25/100
	80+	27657-1	13,300	25/100
4½ × TN**	36+	27469-0	13,300	25/100
	60+	27661-8	13,300	25/100
	80+	27664-9	13,300	25/100
5 × ⅞	36+	27448-5	12,000	25/100
	60+	27654-0	12,000	25/100
	80+	27658-8	12,000	25/100
5 × TN**	36+	27467-6	12,000	25/100
	60+	27662-5	12,000	25/100
	80+	27665-6	12,000	25/100
7 × ⅞	36+	27449-2	8,600	25/100
	60+	27655-7	8,600	25/100
	80+	27659-5	8,600	25/100
7 × TN**	36+	27468-3	8,600	25/100
	60+	27663-2	8,600	25/100
	80+	27666-3	8,600	25/100
9⅞ × ⅞	36+	27450-8	6,600	25/100
	60+	27656-4	6,600	25/100
	80+	27660-1	6,600	25/100

► Tech Tip

Use 3M™ Disc Pad Face Plates – Red Ribbed to optimize product life of Cubitron II Fibre Discs – grade 36+.



► Tech Tip

Use a Disc Pad Hub, Disc Pad Face Plate, and Disc Retainer Nut for ultimate fibre disc performance. See p. 29 for Accessories.



*Other sizes available upon request. **Quick Change Tinneman Nut Attachment

3M™ Fibre Discs 782C and 787C

An unbeatable combination of performance and value.

3M™ Fibre Discs 782C and 787C represent a new class of high-performance, right-angle abrasives – powered by the legendary speed and long life of 3M Precision-Shaped Grain. They are an ideal choice for applications like weld removal, beveling, edge chamfering and more – offering a faster cut and longer life than alumina zirconia (AZ) and conventional ceramic abrasives.

3M™ Fibre Disc 782C is an ideal choice for carbon steel. **3M™ Fibre Disc 787C** is optimized for stainless steel and non-ferrous metals like aluminum.

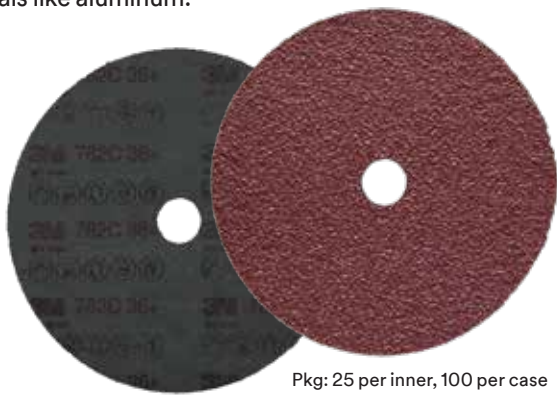

Pkg: 25 per inner, 100 per case

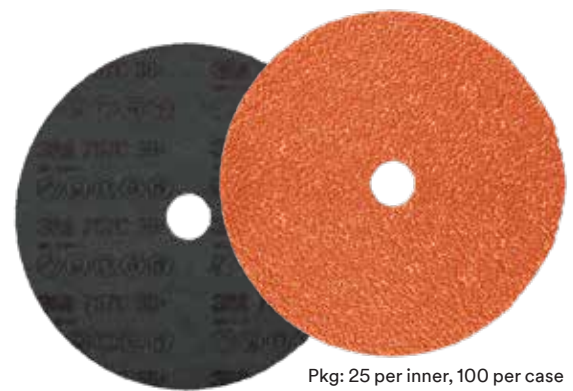

Pkg: 25 per inner, 100 per case

3M™ Fibre Disc 782C for carbon steel

Diameter* (inches)	Grade	UPC (76308-)	Max. RPM
4½ × 7⁄₈	36+	89589-1	13,300
	60+	89598-3	13,300
	80+	89607-2	13,300
5 × 7⁄₈	36+	89590-7	12,000
	60+	89599-0	12,000
	80+	89608-9	12,000
7 × 7⁄₈	36+	89591-4	8,600
	60+	89600-3	8,600
	80+	89609-6	8,600
9½ × 7⁄₈	36+	89592-1	6,600
	60+	89601-0	6,600
	80+	89610-2	6,600
TN Quick Change			
4½ × 5⁄₈-11**	36+	89595-2	13,300
	60+	89604-1	13,300
	80+	89613-3	13,300
5 × 5⁄₈-11**	36+	89596-9	12,000
	60+	89605-8	12,000
	80+	89614-0	12,000
7 × 5⁄₈-11**	36+	89597-6	8,600
	60+	89606-5	8,600
	80+	89615-7	8,600

3M™ Fibre Disc 787C for stainless steel non-ferrous metals

Diameter* (inches)	Grade	UPC (76308-)	Max. RPM
4½ × 7⁄₈	36+	89627-0	13,300
	60+	89636-2	13,300
	80+	89645-4	13,300
	120+	89654-6	13,300
5 × 7⁄₈	36+	89628-7	12,000
	60+	89637-9	12,000
	80+	89646-1	12,000
	120+	89655-3	12,000
7 × 7⁄₈	36+	89629-4	8,600
	60+	89638-6	8,600
	80+	89647-8	8,600
	120+	89656-0	8,600
9½ × 7⁄₈	36+	89630-0	6,600
	60+	89639-3	6,600
	80+	89648-5	6,600
	120+	89657-7	6,600
TN Quick Change			
4½ × 5⁄₈-11**	36+	89633-1	13,000
	60+	89642-3	13,000
	80+	89651-5	13,000
	120+	89658-4	13,000
5 × 5⁄₈-11**	36+	89634-8	12,000
	60+	89643-0	12,000
	80+	89652-2	12,000
	120+	89659-1	12,000
7 × 5⁄₈-11**	36+	89635-5	8,600
	60+	89644-7	8,600
	80+	89653-9	8,600
	120+	89660-7	8,600

*Other sizes available upon request. **Quick Change Tinneman Nut Attachment

3M™ Cubitron™ II Flap Discs

The one-step alternative to bonded wheels and fibre discs.

3M™ Cubitron™ II Flap Discs let you breeze through a wide range of tough jobs around the shop, including grinding, weld removal, deburring and more. These smooth-running wheels are designed to cut with less pressure. They include a grinding aid to help maintain cutting efficiency on heat-sensitive metals. And, because they are made with 3M Precision-Shaped Grain, they keep on cutting – long after other flap discs have called it quits!

3M™ Cubitron™ II Flap Discs 967A

Constructed with a poly-cotton backing that exposes fresh mineral as they wear, for a fast, forgiving cut. Perform well on many common applications, offering a great balance of fast cut and long life.



Product availability

3M™ Cubitron™ II Flap Discs 967A

TYPE 27					TYPE 29				
UPC (051141-) unless otherwise specified	Grade	Dia. × Ctr. Hole (inches)	Max. RPM (MOS)	Qty/Case	UPC (051141-) unless otherwise specified	Grade	Dia. × Ctr. Hole (inches)	Max. RPM (MOS)	Qty/Case
55602-4	40+				55614-7	40+			
55603-1	60+	4½ × ⅝-11	13,300	10	55615-4	60+	4 × ⅜-24	15,000	10
55604-8	80+				55616-1	80+			
55632-1	40+				55617-8	40+			
55633-8	60+	4½ × ⅝-11 GIANT	13,300	10	55618-5	60+	4 × ⅜	15,000	10
55634-5	80+				55619-2	80+			
55605-5	40+				55620-8	40+	4½ × ⅝-11	13,300	10
55606-2	60+	4½ × ⅜	13,300	10	55621-5	60+			
55607-9	80+				55622-2	80+			
55635-2	40+				55644-4	40+			
55636-9	60+	4½ × ⅜ GIANT	13,300	10	55645-1	60+	4½ × ⅝-11 GIANT	13,300	10
55637-6	80+				55646-8	80+			
86715-3	40+				55623-9	40+			
051125-86718-4	60+	5 × ⅜	12,000	10	55624-6	60+	4½ × ⅜	13,300	10
051125-86719-1	80+				55625-3	80+			
55608-6	40+				55647-5	40+			
55609-3	60+	7 × ⅝-11	8,600	5	55648-2	60+	4½ × ⅜ GIANT	13,300	10
55610-9	80+				55649-9	80+			
55638-3	40+				051125-86716-0	40+			
55639-0	60+	7 × ⅝-11 GIANT	8,600	5	051125-86717-7	60+	5 × ⅜	12,000	10
55640-6	80+				051125-86720-7	80+			
55611-6	40+				55626-0	40+			
55612-3	60+	7 × ⅜	8,600	5	55627-7	60+	7 × ⅝-11	8,600	5
55613-0	80+				55628-4	80+			
55641-3	40+				55650-5	40+			
55642-0	60+	7 × ⅜ GIANT	8,600	5	55651-2	60+	7 × ⅝-11 GIANT	8,600	5
55643-7	80+				55652-9	80+			
					55629-1	40+			
					55630-7	60+	7 × ⅜	8,600	5
					55631-4	80+			
					55653-6	40+			
					55654-3	60+	7 × ⅜ GIANT	8,600	5
					55655-0	80+			

More material.
Longer life.



Need more cutting power? Go GIANT!

Our Giant flap discs are 25% thicker, for an aggressive cut with added durability and longer life.

For more information, call 1-866-279-1235 to speak with a 3M abrasive expert.

3M™ Cubitron™ II Flap Discs 969F
 Featuring a tough polyester backing to hold up under demanding applications like heavy grinding, edge deburring and beveling.



Get top results with 3M™ Cubitron™ II Flap Discs.



967A

Medium duty

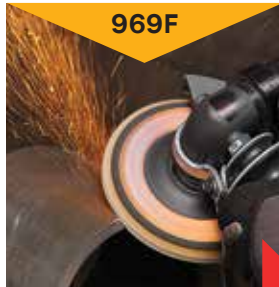

969F

Heavy duty

- ▶ Weld removal
- ▶ Scale removal
- ▶ Oxide removal
- ▶ Surface prep
- ▶ Metal dimensioning
- ▶ Blending
- ▶ Light cleaning
- ▶ Beveling
- ▶ Edge deburring
- ▶ Aggressive weld removal

Product availability

3M™ Cubitron™ II Flap Discs 969F

TYPE 27					TYPE 29				
UPC (076308-) unless otherwise specified	Grade	Dia. × Ctr. Hole (inches)	Max. RPM (MOS)	Qty/Case	UPC (076308-) unless otherwise specified	Grade	Dia. × Ctr. Hole (inches)	Max. RPM (MOS)	Qty/Case
64373-7	40+	4½ × ⅝-11	13,300	10	64385-0	40+	4 × ⅝-24	15,000	10
64374-4	60+				64386-7	60+			
64375-1	80+				64387-4	80+			
64403-1	40+	4½ × ⅝-11 GIANT	13,300	10	64388-1	40+	4 × ⅝	15,000	10
64404-8	60+				64389-8	60+			
64405-5	80+				64390-4	80+			
64376-8	40+	4½ × ⅞	13,300	10	64391-1	40+	4½ × ⅝-11	13,300	10
64377-5	60+				64392-8	60+			
64378-2	80+				64393-5	80+			
64406-2	40+	4½ × ⅞ GIANT	13,300	10	64415-4	40+	4½ × ⅝-11 GIANT	13,300	10
64407-9	60+				64416-1	60+			
64408-6	80+				64417-8	80+			
89844-1	40+	5 × ⅞	12,000	10	64394-2	40+	4½ × ⅞	13,300	10
89847-2	60+				64395-9	60+			
89848-9	80+				64396-6	80+			
64379-9	40+	7 × ⅝-11	8,600	5	64418-5	40+	4½ × ⅞ GIANT	13,300	10
64380-5	60+				64419-2	60+			
64381-2	80+				64420-8	80+			
64409-3	40+	7 × ⅝-11 GIANT	8,600	5	89845-8	40+	5 × ⅞	12,000	10
64410-9	60+				89846-5	60+			
64411-6	80+				89849-6	80+			
64382-9	40+	7 × ⅞	8,600	5	64397-3	40+	7 × ⅝-11	8,600	5
64383-6	60+				64398-0	60+			
64384-3	80+				64399-7	80+			
64412-3	40+	7 × ⅞ GIANT	8,600	5	64421-5	40+	7 × ⅝-11 GIANT	8,600	5
64413-0	60+				64422-2	60+			
64414-7	80+				64423-9	80+			
		7 × ⅞	8,600	5	64400-0	40+	7 × ⅞	8,600	5
					64401-7	60+			
					64402-4	80+			
		7 × ⅞ GIANT	8,600	5	64424-6	40+	7 × ⅞ GIANT	8,600	5
					64425-3	60+			
					64426-0	80+			

▶ Tech Tip

3M™ Cubitron™ II Flap Discs will often produce a finish equivalent to the next-finer grade of a fibre disc (i.e., a 60-grit flap disc will usually leave a finish similar to an 80-grit fibre disc) – saving you time and finishing steps!

3M™ Flap Discs 769F

**Everyday value.
Exceptional performance.**

These value-priced discs harness the power of 3M Precision-Shaped Grain and the versatility of flap discs, all at a price that's affordable for everyday use. Get dependable performance with fewer disc changes – and get more work done over the life of your disc.

Product availability

3M™ Flap Discs 769F



TYPE 27

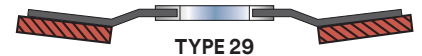

TYPE 29

UPC (0-06-38060-)	Grade	Diameter x Center Hole (inches)	Max. RPM (MOS)	Qty/ Case
05903-6	40+	4.5 x 7/8	13,300	10
05904-3	60+			
05905-0	80+			
05924-1	120+			
05915-9	40+	5 x 7/8	12,000	10
05918-0	60+			
05919-7	80+			
05928-9	120+			
05909-8	40+	7 x 7/8	8,600	5
05910-4	60+			
05911-1	80+			
05926-5	120+			

UPC (0-06-38060-)	Grade	Diameter x Center Hole (inches)	Max. RPM (MOS)	Qty/ Case
05906-7	40+	4.5 x 7/8	13,300	10
05907-4	60+			
05908-1	80+			
05925-8	120+			
05916-6	40+	5 x 7/8	12,000	10
05917-3	60+			
05920-3	80+			
05929-6	120+			
05912-8	40+	7 x 7/8	8,600	5
05913-5	60+			
05914-2	80+			
05927-2	120+			

Fibre Discs vs. Depressed Center Grinding Wheel vs. Flap Disc

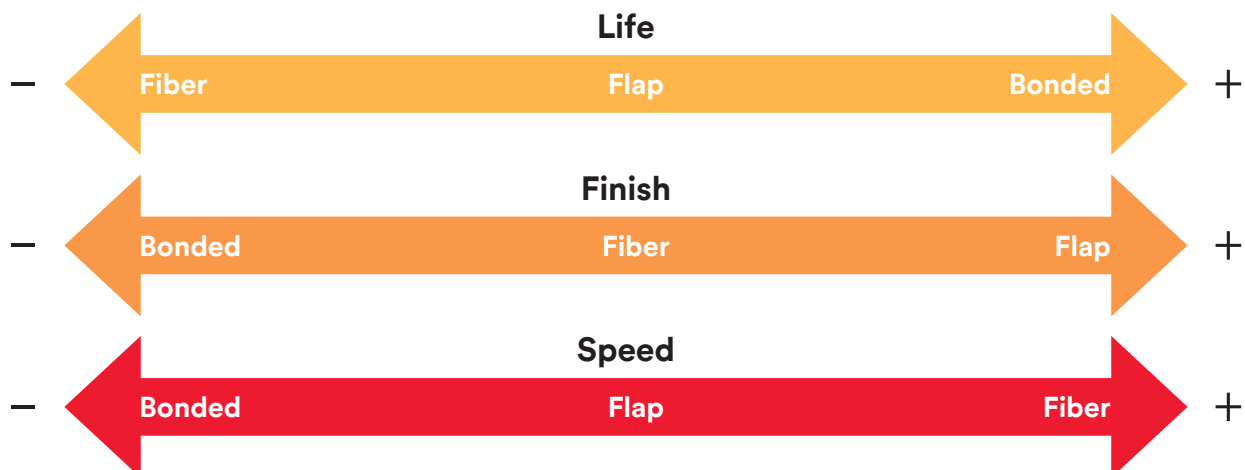

A word about wear.

The life and cut of a flap disc is determined by how quickly the backing wears away to expose new mineral. If it wears too quickly, it can significantly shorten the disc life. But if it doesn't wear properly, the disc might stop cutting altogether. The backing in 3M™ Flap Discs 769F is designed to wear just the right amount to provide consistent cut over a wide range of medium- and heavy-duty applications. Combined with the power of 3M Precision-Shaped Grain, that helps 3M™ Flap Discs 769F outperform the competition – at a value price!



For even faster cut and longer life, try 3M™ Cubitron™ II Flap Discs 967A and 969F. See pages 14-15.

Choose the right flap disc for your job.

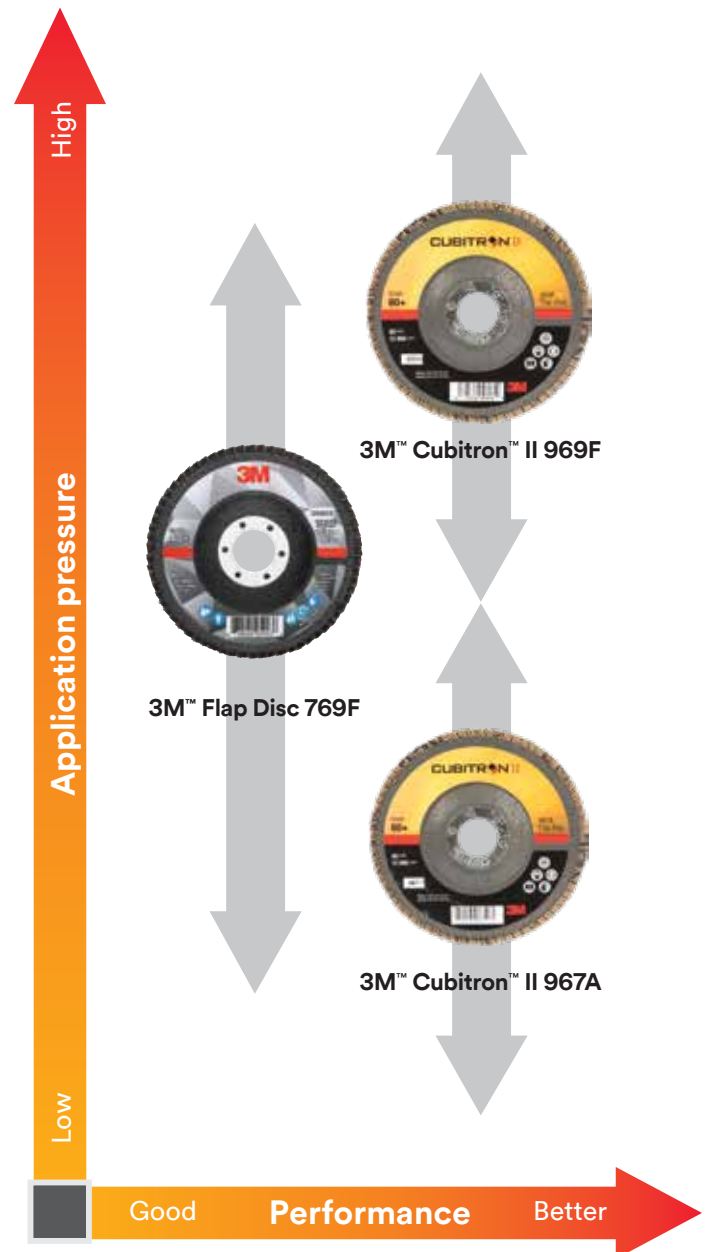

Medium duty

- ▶ Weld removal
- ▶ Scale removal
- ▶ Oxide removal
- ▶ Surface prep
- ▶ Blending
- ▶ Light cleaning

Heavy duty

- ▶ Beveling
- ▶ Edge deburring
- ▶ Aggressive weld removal

3M™ Cubitron™ II Cut & Grind Wheels

Cut. Grind. Done.

These versatile wheels are designed to be used both as a depressed center grinding wheel and as a cut-off wheel – making them ideal for cutting, grinding, gouging and more. After 10 minutes of use, they nearly doubled the output of our closest competitor while removing nearly 2x the material.

3M™ Cubitron™ II Cut & Grind Wheels – T27

Diameter x Thickness x Arbor Hole (inches)	UPC	Max. RPM	Quantity (Inner/Case)
4 x 1/8 x 3/8	4046719-82276-8	15,300	10/20
4 x 1/8 x 3/8	4046719-82277-5	15,300	10/20
5 x 1/8 x 3/8	4046719-82278-2	12,250	10/20
4 1/2 x 1/8 x 3/8	4046719-82279-9	13,300	10/20
6 x 1/8 x 3/8	051141-28758-4	10,200	10/20
7 x 1/8 x 3/8	051141-28760-7	8,500	10/20
9 x 1/8 x 3/8	051141-28761-4	6,650	10/20

3M™ Cubitron™ II Cut & Grind Wheels – T27 Quick Change

Diameter x Thickness x Arbor Hole (inches)	UPC	Max. RPM	Quantity (Inner/Case)
4 1/2 x 1/8 x 3/8-11	051141-28762-1	13,300	10/20
5 x 1/8 x 3/8-11	051141-28763-8	12,250	10/20
6 x 1/8 x 3/8-11	051141-28764-5	10,200	10/20
7 x 1/8 x 3/8-11	051141-28765-2	8,500	10/20
9 x 1/8 x 3/8-11	051141-28766-9	6,650	10/20

3M™ Cubitron™ II Cut & Grind Wheels Cut Faster!

After 10 min., nearly double the output of our closest competitor

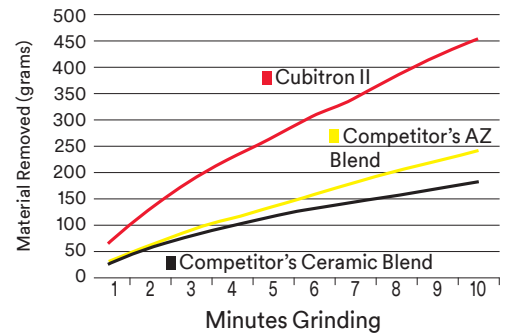

3M™ Cubitron™ II Cut & Grind Wheels Last Longer!

Removes nearly 2x the material, compared to our closest competitor

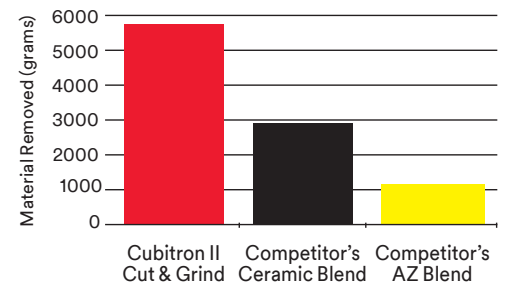

New 3M™ Cut & Grind Wheels

Value and versatility.

The newest addition to our Advanced Series of abrasives, 3M Cut & Grind Wheels are designed for use as both depressed center grinding wheels and cut-off wheels, so you can get more done for your dollar.

3M™ Cut & Grind Wheel (638060-)	Grade	Diameter x Center Hole (inches)	Maximum RPM	Maximum Speed (m/s)	Discs Per Box/Case
06459-7	T1	4 × 1/8 × 3/8	15,300	80	10/20
06460-3	T27	4 × 1/8 × 3/8	15,300	80	10/20
06461-0	T27	4 × 1/8 × 3/8	15,300	80	10/20
06462-7	T27	4 1/2 × 1/8 × 7/8	13,300	80	10/20
06463-4	T27	5 × 1/8 × 7/8	12,500	80	10/20
06469-6	T27	6 × 1/8 × 7/8	10,200	80	10/20
06470-2	T27	7 × 1/8 × 7/8	8,500	80	10/20
06471-9	T27	9 × 1/8 × 7/8	6,650	80	10/20

Quick Change Attachment

06464-1	T27	4 1/2 × 1/8 × 3/8-11	13,300	80	10/20
06465-8	T27	5 × 1/8 × 3/8-11	12,500	80	10/20
06466-5	T27	6 × 1/8 × 3/8-11	10,200	80	10/20
06467-2	T27	7 × 1/8 × 3/8-11	8,500	80	10/20
06468-9	T27	9 × 1/8 × 3/8-11	6,650	80	10/20

Cut & Grind Wheel Wear Comparison

3M™ Cut & Grind wheels wear less and last longer than the competition!

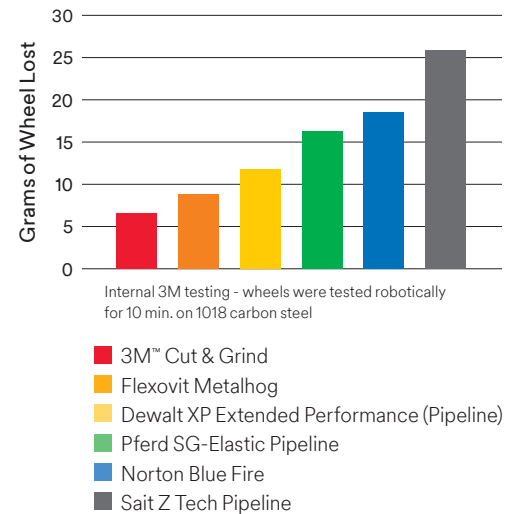

3M™ Cubitron™ II Cut-Off Wheels

Cut to the chase.

Cubitron II Cut-Off Wheels are designed to provide high cut rates on all types of ferrous metals, stainless steels, alloy steels and cast iron. They offer long life to help reduce cost. Plus, their fast, cool cutting action helps make your job easier!



Wheel life

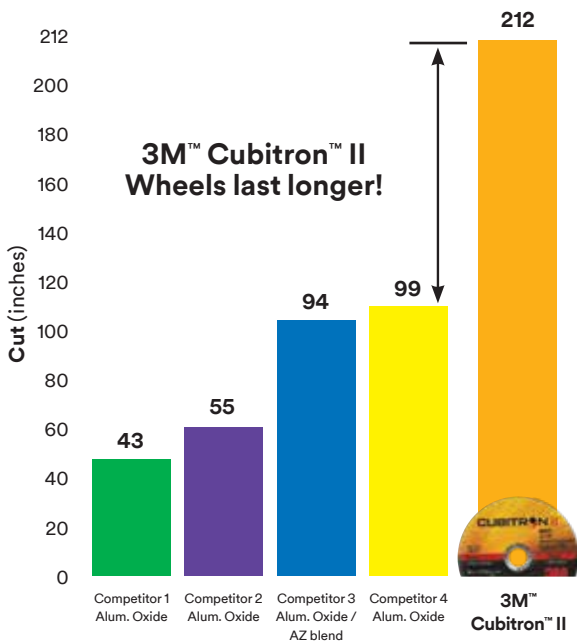

Internal 3M testing on 304L stainless steel sheet (11 gauge) using a 13 amp electric tool.

3M™ Cubitron™ II Cut-Off Wheel – T1

Diameter × Thickness × Arbor Hole (inches)	UPC	Max. RPM	Quantity (Inner/Case)
3 × .035 × ¼	051115-66513-4	25,465	25/50
3 × .035 × ⅜	051115-66514-1	25,465	25/50
3 × .06 × ⅜	051115-66516-5	25,465	25/50
4 × .035 × ⅜	051115-66518-9	19,100	25/50
4 × .06 × ⅜	051115-66520-2	19,100	25/50
4 × .125 × ⅜	051115-66524-0	19,100	25/50
4 ½ × .040 × ⅞	051125-86929-4	13,300	25/50
4 ½ × .045 × ⅞	051115-66525-7	13,300	25/50
5 × .040 × ⅞	051125-86930-0	12,250	25/50
5 × .045 × ⅞	051115-66526-4	12,250	25/50
6 × .045 × ⅞	051115-66527-1	10,200	25/50
7 × .045 × ⅞	051115-66528-8	8,500	25/50

3M™ Cubitron™ II Cut-Off Wheel – T27

Diameter × Thickness × Arbor Hole (inches)	UPC	Max. RPM	Quantity (Inner/Case)
4 ½ × .040 × ⅞	051125-86946-1	13,300	25/50
4 ½ × .045 × ⅞	051115-66531-8	13,300	25/50
4 ½ × .125 × ⅞	051115-66535-6	13,300	25/50
5 × .040 × ⅞	051125-86945-4	12,250	25/50
5 × .045 × ⅞	051115-66537-0	12,250	25/50
5 × .09 × ⅞	051115-66539-4	12,250	25/50
6 × .045 × ⅞	051115-66541-7	10,200	25/50
7 × .09 × ⅞	051115-66543-1	8,500	25/50

3M™ Cubitron™ II Cut-Off Wheel – T27 Quick Change

Diameter × Thickness × Arbor Hole (inches)	UPC	Max. RPM	Quantity (Inner/Case)
4 ½ × .045 × ⅞-11	051115-66530-1	13,300	25/50
4 ½ × .09 × ⅞-11	051115-66532-5	13,300	25/50
4 ½ × .125 × ⅞-11	051115-66534-9	13,300	25/50
6 × .045 × ⅞-11	051115-66540-0	10,200	25/50
7 × .09 × ⅞-11	051115-66542-4	8,500	25/50

3M™ Silver Cut-Off Wheels

A cut above the ordinary.

3M™ Silver Cut-Off Wheels are premium performance wheels designed to be affordable for everyday use. Featuring 3M Precision-Shaped Grain technology, these innovative wheels deliver fast, smooth cutting action on all types of ferrous metals, stainless steels and alloy steels. Plus they last longer than aluminum oxide and alumina zirconia wheels. That means fewer wheel changes and more finished parts per wheel to help improve shop productivity and control your costs.

3M™ Silver Cut-Off Wheels – Type 1

Diameter × Thickness × Arbor Hole (inches)	UPC	Max. RPM	Quantity (Inner/Case)
3 × .035 × ¼	051125-87457-1	25,465	25/50
3 × .035 × ⅜	051125-87458-8	25,465	25/50
3 × .060 × ⅜	051125-87459-5	25,465	25/50
4 × .035 × ¼	051125-87460-1	19,100	25/50
4 × .035 × ⅜	051125-87461-8	19,100	25/50
4 × .060 × ⅜	051125-87462-5	19,100	25/50
4 × .125 × ⅜	051125-87657-5	19,100	25/50
4.5 × .040 × ⅞	051125-87464-9	13,300	25/50
4.5 × .045 × ⅞	051125-87465-6	13,300	25/50
5 × .045 × ⅞	051125-87467-0	12,250	25/50
6 × .045 × ⅞	051125-87469-4	10,200	25/50
7 × .045 × ⅞	051125-87471-7	8,500	25/50

3M™ Silver Cut-Off Wheels – Type 27

Diameter × Thickness × Arbor Hole (inches)	UPC	Max. RPM	Quantity (Inner/Case)
4.5 × .045 × ⅞	051125-87466-3	13,300	25/50
4.5 × .093 × ⅞	051125-87659-9	13,300	25/50
5 × .045 × ⅞	051125-87468-7	12,250	10/20
6 × .045 × ⅞	051125-87470-0	10,200	10/20





QUALITY FINISHES. MADE EASY.

For over 50 years, metalworking professionals have trusted Scotch-Brite™ Abrasives for a wide range of cleaning, deburring and finishing applications on all types of metals. Scotch-Brite products feature an open-web construction that resists loading.

Scotch-Brite products help you improve surfaces without significantly changing the shape or dimension of the workpiece.





CHOOSE THE RIGHT DISC FOR THE JOB.

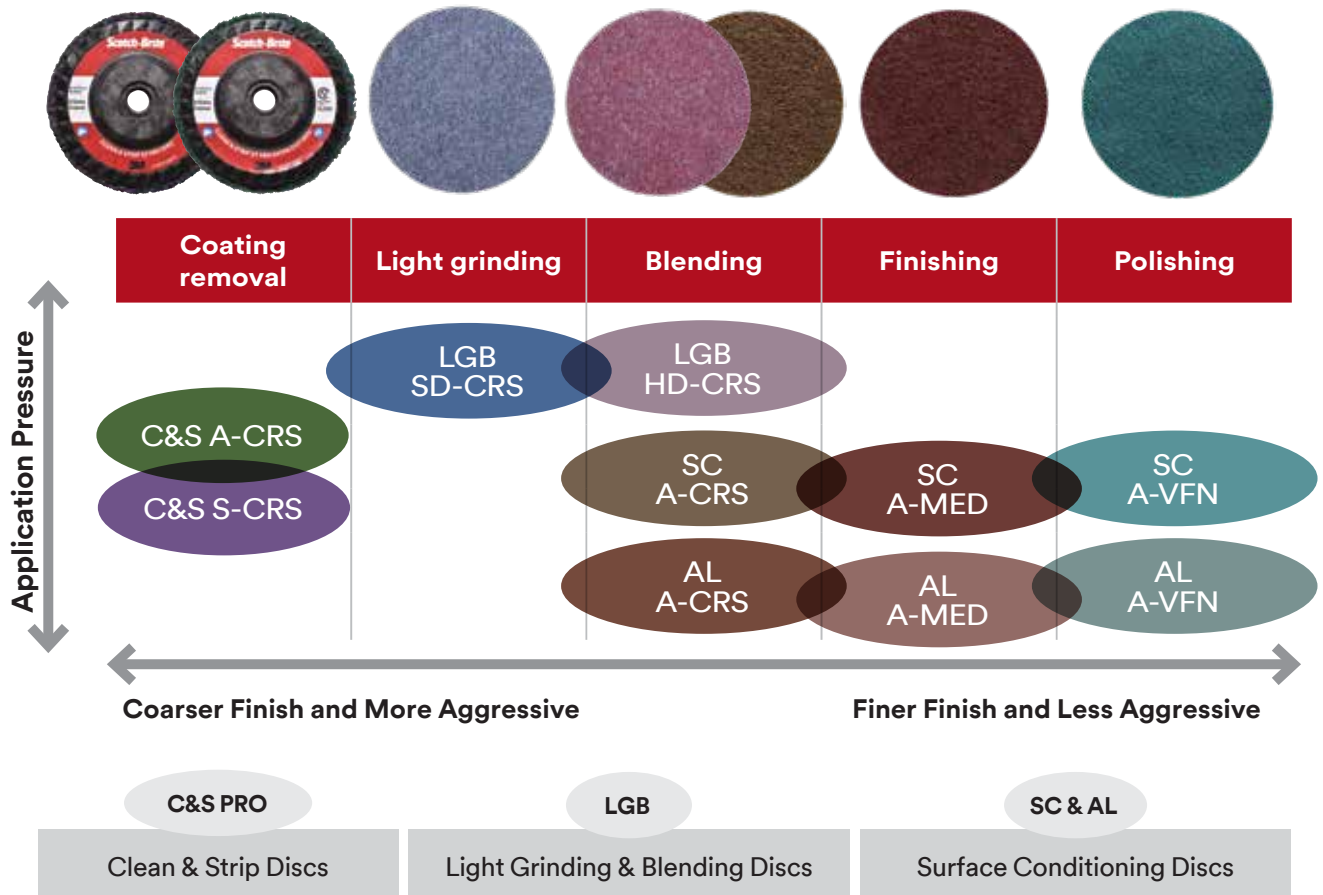

SCOTCH-BRITE™ HAND PADS 7447 PRO & 7448 PRO

Scotch-Brite Hand Pads give you a fast, consistent scuff for everyday surface preparation. Ideal for cleaning parts, deburring, hand blending and scuffing prior to painting. A great alternative to steel wool – no rust or splintering! Hand Pads 7447 PRO and 7448 PRO feature more durable construction, for longer life, and tightly graded abrasive particles for a consistent, uniform scratch throughout the life of the pad.

Product	UPC (048011-)	W × L (inches)	Grade	Color	Qty/Case
7447 PRO	64926-9	6 × 9 Perforated	A VFN	Maroon	60
7448 PRO	64935-1	6 × 9 Perforated	S ULF	Gray	60



PREMIUM SERIES

► Tech Tip

Use for light stock removal and aggressive blending operations.



► Tech Tip

2-Step Weld Removal & Prep for Paint

- ✓ **STEP 1:**
Remove the weld with 3M™ Cubitron™ II Fibre Disc 982C grade 36+
- ✓ **STEP 2:**
Finish with Scotch-Brite LGB SD Disc
- ✓ **READY FOR PAINT**
(>3 mil)

NOTE: For best results, use with red (extra hard) or black (hard) 3M™ Disc Face Plates.

► Tech Tip

Use a Disc Pad Hub, Disc Pad Face Plate, and Disc Retainer Nut for ultimate disc performance. See p. 29 for Accessories.

SCOTCH-BRITE™ LIGHT GRINDING AND BLENDING DISCS

FOR LIGHT GRINDING AND BLENDING

A durable disc constructed with 3M ceramic aluminum oxide blend abrasive grain, for an aggressive cut, long life and consistent finish. Resistant to edge wear. Ideal for light grinding applications to produce a burr-free and paintable finish.

Scotch-Brite™ Light Grinding & Blending Disc – TN Quick Change

Diameter × Center Hole (inches)	UPC (048011-)	Grade	Max. RPM	Qty/Case
4 ½ × ⅝-11*	60349-0	A CRS SD	13,000	50
	60348-3	A CRS HD	13,000	50
5 × ⅝-11*	60351-3	A CRS SD	12,000	50
	60350-6	A CRS HD	12,000	50
7 × ⅝-11*	60353-7	A CRS SD	8,600	25
	60352-0	A CRS HD	8,600	25

*Quick Change Tinneman Nut Attachment

Scotch-Brite™ Light Grinding & Blending Disc – Center Hole Disc

Diameter × Center Hole (inches)	UPC (048011-)	Grade	Max. RPM	Qty/Case
4 ½ × ⅞	60333-9†	A CRS SD	10,000	50
	60332-2†	A CRS HD	10,000	50
5 × ⅞	60341-4	A CRS SD	10,000	50
	60336-0	A CRS HD	10,000	50
7 × ⅞	60344-5	A CRS SD	6,000	25
	60347-6	A CRS HD	6,000	25

†Made-to-Order

SD = Super Duty **HD** = Heavy Duty

PREMIUM SERIES



SCOTCH-BRITE™ CLEAN AND STRIP XT PRO DISCS

SPEED WITHOUT COMPROMISE.

Upgrade to the Scotch-Brite™ Clean and Strip XT Pro or XT Pro Extra Cut for rust and coating removal. Delivering the uncompromising results metalworkers have come to expect from Scotch-Brite™ Clean and Strip discs, with a faster speed rating, convenient quick-change threaded hub and extended life.

Scotch-Brite™ Clean & Strip XT Pro Disc

Diameter x Center Hole (inches)	UPC	Type	Grade	Max. RPM	Qty/Case
4 ½ x ⅝-11	0 06 38060 05574 8	Type 27 Quick Change	S XCS	13,300	10
4 ½ x ⅞	0 06 38060 05586 1	Type 27	S XCS	13,300	10
4 ½ x ⅝-11*	0 06 38060 05588 5	TN Quick Change	S XCS	13,300	10
7 x ⅞	0 06 38060 05587 8	Type 27	S XCS	8,600	5
7 x ⅝-11	0 00 76308 45481 4	Type 27 Quick Change	S XCS	8,600	5

Scotch-Brite™ Roloc™ Clean & Strip XT Pro Disc

3 x NH	0 06 38060 21540 1	TR	S XCS	15,000	10
--------	--------------------	----	-------	--------	----

Scotch-Brite™ Clean & Strip XT Pro Extra Cut Disc

Diameter x Center Hole (inches)	UPC	Type	Grade	Max. RPM	Qty/Case
4 ½ x ⅝-11	0 06 38060 21050 5	Type 27 Quick Change	A XCS	13,300	10
4 ½ x ⅞	0 06 38060 21032 1	Type 27	A XCS	13,300	10
4 ½ x ⅝-11*	0 06 38060 21037 6	TN Quick Change	A XCS	13,300	10
7 x ⅝-11	0 06 38060 21055 0	Type 27 Quick Change	A XCS	8,600	5
7 x ⅞	0 06 38060 21036 9	Type 27	A XCS	8,600	5

Scotch-Brite™ Roloc™ Clean & Strip XT Pro Extra Cut Disc

3 x NH	0 06 38060 21544 9	TR	A XCS	15,000	10
--------	--------------------	----	-------	--------	----

*Quick Change Tinneman Nut Attachment

Choose the disc that's right for you:

XT Pro

- ▶ Rust, paint, light mill scale removal
- ▶ Maintains workpiece shape
- ▶ Low sparking
- ▶ Ideal for surface prep
- ▶ Made with silicon carbide mineral



BOTH

- ▶ Rapid coating removal and surface prep
- ▶ Decreased chunking – extended life
- ▶ Highly conformable
- ▶ High speed rating
- ▶ Quick-change, spin-on thread



XT Pro Extra Cut

- ▶ Heavy rust and rust pit removal without leaving divots
- ▶ Thick paint and coating removal
- ▶ Weld refinement and removing weld discoloration
- ▶ Cuts to bare metal quickly
- ▶ Ideal for adhesion prep
- ▶ Made with aluminum oxide mineral



PREMIUM SERIES

SCOTCH-BRITE™ AL SURFACE CONDITIONING DISCS

► Tech Tip

Specially formulated for use on softer metals, Scotch-Brite AL discs can be used on all metals, especially when loading is an issue.

► Tech Tip

Use a Disc Pad Hub, Disc Pad Face Plate, and Disc Retainer Nut for ultimate disc performance. See p. 29 for Accessories.

FOR BLENDING AND FINISHING SOFT METALS

Designed specifically for fast, consistent blending and finishing of aluminum, oily carbon steel and other soft metals, Scotch-Brite AL Surface Conditioning Discs feature a unique, open-web construction that resists loading. Plus they deliver the same great quality and performance you've come to expect from the Scotch-Brite brand.

Diameter (inches)	UPC (051141-)	Grade	Color	Max. RPM	Qty/Case
4 ½	54219-5	A CRS	Brown	9600	50
	54218-8	A MED	Maroon	9600	50
	54217-1	A VFN	Blue	9600	50
5	54212-6	A CRS	Brown	8500	50
	54215-7	A MED	Maroon	8500	50
	54213-3	A VFN	Blue	8500	50
7	54204-1	A CRS	Brown	6000	25
	54211-9	A MED	Maroon	6000	25
	54214-0	A VFN	Blue	6000	25



PREMIUM SERIES



SCOTCH-BRITE™ SURFACE CONDITIONING DISCS (SC)

FOR GENERAL PURPOSE BLENDING

The ideal choice for general purpose surface conditioning, including finishing, cleaning and light deburring. Helps you achieve a consistent, paintable finish in fewer steps without damaging the base material. Durable open-web construction is designed to resist loading and greatly increase the life of the disc — so you don't have to change discs as often. Easily attaches to and removes from 3M™ Hook-and-Loop Backup Pads.

► Tech Tip

Use for all your general surface conditioning needs. Scotch-Brite SC discs are durable enough for sharp edges, so they are ideal for use on rougher workpieces.

Diameter (inches)	UPC (048011-)	Grade	Color	Max. RPM	Qty/Case
4½	14101-5	A CRS	Brown	13,000	50
	14100-8	A MED	Maroon	13,000	50
	14099-5	A VFN	Blue	13,000	50
5	00750-2	A CRS	Brown	10,000	25
	00643-7	A MED	Maroon	10,000	25
	04303-6	A VFN	Blue	10,000	25
7	00751-9	A CRS	Brown	6,000	25
	00645-1	A MED	Maroon	10,000	25
	04305-0	A VFN	Blue	10,000	25

► Tech Tip

Use a Disc Pad Hub, Disc Pad Face Plate, and Disc Retainer Nut for ultimate disc performance. See p. 29 for Accessories.



3M™ Power Tools and Accessories

3M™ 1.5-HP Power Tools for Right-Angle Systems

Lightweight but rugged, these 1.5-hp power tools are designed with a high power-to-weight ratio to help operators get more work done in less time.



3M™ Grinder 28824
051141-28824-6



3M™ Cut-Off Wheel Tool 28826
051141-28826-0



3M™ Sander 28825
051141-28825-3

NEW! 3M™ 1-HP Power Tools for Right-Angle Systems

These 1-hp power tools feature heavy-duty gear sets requiring no maintenance or lubrication. They are also engineered with a new sealed design that keeps external contaminants out and lubrication in.



3M™ Grinder 28403*
051141-28403-3



3M™ Grinder 28405*
051141-28405-7

*Upgraded



3M™ Cut-Off Wheel Tool 20233
051141-20233-4



3M™ Cut-Off Wheel Tool 28771
051141-28771-3



These tools are optimized for use with 3M™ Cubitron™ II and 3M™ Abrasives

Power Tool Assembly

- ▶ 3M™ Disc Pad Hub
- ▶ 3M™ Disc Pad Face Plate
- ▶ 3M™ Fibre Disc
- ▶ 3M™ Disc Retainer Nut

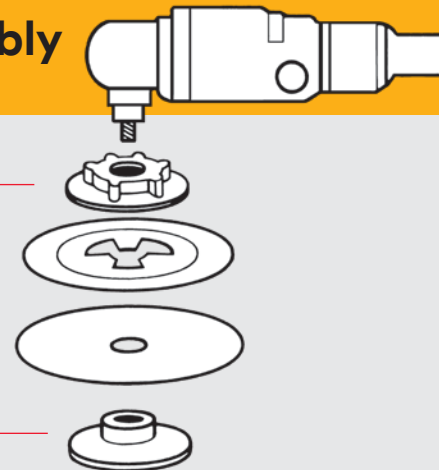



Accessories for 3M™ Right-Angle Systems



Product Name	UPC	Description	Max. RPM	For Use With	Min/Case
3M™ Disc Pad Hub	051144-88743-9	2½" dia., ⅝-11" Metal Insert	N/A	3M™ Disc Pad Face Plates (all sizes, tool shaft length ½" or less)	10
3M™ Disc Pad Face Plates	051141-28443-9	4½" dia., Red, Ribbed, Extra Hard	13,300	Fibre Discs and Scotch-Brite™ Surface Conditioning Discs	10
	051141-14270-5	4½" dia., Black, Smooth, Hard	13,300	Fibre Discs and Scotch-Brite™ Surface Conditioning Discs	10
	051144-81732-0	5" dia., Red, Ribbed, Extra Hard	12,000	Fibre Discs and Scotch-Brite™ Surface Conditioning Discs	10
	051144-81733-7	5" dia., Black, Ribbed, Hard	12,000	Fibre Discs and Scotch-Brite™ Surface Conditioning Discs	10
	051144-80514-3	7" dia., Red, Ribbed, Extra Hard	8,600	Fibre Discs and Scotch-Brite™ Surface Conditioning Discs	10
	051144-80515-0	7" dia., Black, Ribbed, Hard	8,600	Fibre Discs and Scotch-Brite™ Surface Conditioning Discs	10
3M™ Disc Retainer Nuts	051111-51047-5	⅝" Depth; ⅝-11" Thread	N/A	3M™ Disc Pad Face Plates and Disc Pad Hubs	N/A
	051144-05622-4	¾" Depth; ⅝-11" Thread	N/A	3M™ Disc Pad Face Plates and Disc Pad Hubs	N/A
3M™ TN Quick Change Disc Backup Pad	051111-56573-5	4½" dia., ⅝-11" INT	13,300	4½" TN Discs	5
3M™ Hook-and-Loop Disc Pad Holders	051141-20245-7	7" dia., ⅜" Center Post; ⅝-11" INT	8,500	Scotch-Brite™ Light Grinding and Blending Disc Accessories	1
	048011-14111-4	4½" dia., ⅜" Center Hole; ⅛" Thick., ⅝-11" INT, Firm	13,000	Scotch-Brite™ Surface Conditioning Discs	1
	048011-05680-7	5" dia., ⅜" Center Hole; ⅛" Thick., ⅝-11" INT, Firm	10,000	Scotch-Brite™ Surface Conditioning Discs	1
	048011-09450-2	7" dia., ⅜" Center Hole, ⅝" Thick., ⅝-11" INT, Med.	6,000	Scotch-Brite™ Surface Conditioning Discs	1
3M™ Hook & Loop Disc Pad Holder CP (Center Post)	051141-28892-5	4" dia., ⅞" Center Post, ⅝-11" INT	15,000	Scotch-Brite™ Surface Conditioning Discs	1/5
	051141-28891-8	4½" dia., ⅞" Center Post, ⅝-11" INT	13,300		1/5
	051141-28890-1	5" dia., ⅞" Center Post, ⅝-11" INT	12,000		1/5
	051141-28888-8	7" dia., ⅞" Center Post, ⅝-11" INT	8,600		1/5

Single Packs

	Product	Contents	Packaging	UPC
	3M™ Cubitron™ II Flap Disc 967A T27, 4.5 in.	1 Disc 4-½ in. × ⅞ in. Grade 40+	10/case	051125-86855-6
	3M™ Cubitron™ II Flap Disc 969F T27, 4.5 in.	1 Disc 4-½ in. × ⅞-11 Grade 40+	10/case	051125-87258-4
	3M™ Cubitron™ II Fibre Disc 982C, 4.5 in.	1 Disc 4-½ in. × ⅞ in. Grade 36+	10/case	051125-86942-3
	3M™ Cubitron™ II Disc TN Quick Change 982C, 7 in.	1 Disc 7 in. Grade 36+	10/case	051125-87259-1
	3M™ Cubitron™ II Depressed Center Grinding Wheel T27, 4.5 in. - with hub	1 Disc 4-½ in. × ¼ in. × ⅝-11	10/case	051125-87208-9
	3M™ Cubitron™ II Depressed Center Grinding Wheel T27, 4.5 in. - no hub	1 Disc 4-½ in. × ¼ in. × ⅞ in.	10/case	051125-87209-6
	3M™ Cubitron™ II Depressed Center Grinding Wheel T27, 7 in.	1 Disc 7 in. × ¼ in. × ⅞ in.	10/case	051125-87206-5
	3M™ Cubitron™ II Cut-Off Wheel T27, 4.5 in.	1 Disc 4-½ in. × .045 × ⅞ in. Grade 36	10/case	048011-64999-3
	3M™ Cubitron™ II Cut-Off Wheel T27, 6 in.	1 Disc 6 in. × .045 × ⅞ in. Grade 36	10/case	051125-87152-5
	3M™ Fibre Disc 782C, 4.5 in.	1 Disc 4-½ in. × ⅞ in. Grade 36+	10/case	051125-87254-6
	3M™ Fibre Disc 782C, 7 in.	1 Disc 7 in. × ⅞ in. Grade 36+	10/case	051125-87255-3
	3M™ Fibre Disc 787C, 4.5 in.	1 Disc 4-½ in. × ⅞ in. Grade 36+	10/case	051125-87256-0
	3M™ Fibre Disc 787C, 7 in.	1 Disc 7 in. × ⅞ in. Grade 36+	10/case	051125-87257-7



	Product	Contents	Packaging	UPC
	3M™ Flap Disc 769F	1 Disc 4-½ in. x 7/8 in	10/case	638060-29883-1
	Scotch-Brite™ Roloc™ + Clean and Strip XT Pro Extra Cut Disc, TR+	1 Disc 4 in. x 1/2 in. A Extra Coarse	10/case	638060-29917-3
	Scotch-Brite™ Roloc™ + Clean and Strip XT Pro Disc TR+	1 Disc 4 in. x 1/2 in. S Extra Coarse	10/case	638060-29911-1
	Scotch-Brite™ Clean and Strip XT Pro Disc, Type 27 QC	1 Disc 4-½ in. x 5/8 - 11 in. S Extra Coarse	10/case	638060-29900-5
	Scotch-Brite™ Light Grinding & Blending Disc TN QC, 4.5 in.	1 Disc 4-½ in. x NH A Coarse	10/case	048011-65000-5
	Scotch-Brite™ Light Grinding & Blending Disc TN QC, 7 in.	1 Disc 7 in. x NH Super Duty A Coarse	10/case	076308-77124-9
	3M™ Silver Cut-Off Wheel T27, 6 in.	1 Disc 6 in. x .045 x 7/8 in.	10/Case	076308-44539-3
	3M™ Silver Cut-Off Wheel T27, 4.5 in.	1 Disc 4-½ in. x .045 in. x 7/8 in.	10/case	051125-87660-5
	3M™ Silver Depressed Center Grinding Wheel T27 with Quick Change Hub, 4.5 in.	1 Disc 4-½ in. x ¼ x 5/8-11 in.	10/Case	051125-87661-2
	3M™ Silver Depressed Center Grinding Wheel T27, 4.5 in.	1 Disc 4-½ in. x 1/4 in. x 7/8 in.	10/case	076308-44538-6
	3M™ Cut & Grind Wheel	1 Disc 4-½ in. x ¼ x 5/8-11 in.	10/Case	638060-75819-9

Call to speak with a 3M abrasives expert: 1-866-279-1235

Product Selection and Use: Many factors beyond 3M's control and uniquely within user's knowledge and control can affect the use and performance of a 3M product in a particular application. As a result, customer is solely responsible for evaluating the product and determining whether it is appropriate and suitable for customer's application, including conducting a workplace hazard assessment and reviewing all applicable regulations and standards (e.g., OSHA, ANSI, etc.). Failure to properly evaluate, select, and use a 3M product and appropriate safety products, or to meet all applicable safety regulations, may result in injury, sickness, death, and/or harm to property.

Warranty, Limited Remedy, and Disclaimer: Unless a different warranty is specifically stated on the applicable 3M product packaging or product literature (in which case such warranty governs), 3M warrants that each 3M product meets the applicable 3M product specification at the time 3M ships the product. 3M MAKES NO OTHER WARRANTIES OR CONDITIONS, EXPRESS OR IMPLIED, INCLUDING, BUT NOT LIMITED TO, ANY IMPLIED WARRANTY OR CONDITION OF MERCHANTABILITY, FITNESS FOR A PARTICULAR PURPOSE, OR ARISING OUT OF A COURSE OF DEALING, CUSTOM, OR USAGE OF TRADE. If a 3M product does not conform to this warranty, then the sole and exclusive remedy is, at 3M's option, replacement of the 3M product or refund of the purchase price.

Limitation of Liability: Except for the limited remedy stated above, and except to the extent prohibited by law, 3M will not be liable for any loss or damage arising from or related to the 3M product, whether direct, indirect, special, incidental, or consequential (including, but not limited to, lost profits or business opportunity), regardless of the legal or equitable theory asserted, including, but not limited to, warranty, contract, negligence, or strict liability.z



Abrasive Systems Division
3M Center, Building 223-6S-03
St. Paul, MN 55144-1000
1-866-279-1235
www.3M.com/abrasives

Please recycle. Printed in USA.
© 3M 2019. All rights reserved.
Issued: 12/19 16084HB
61-5002-8389-2 Rev. E

3M, Cubitron, Scotch-Brite, SecureFit, E-A-R, Speedglas and UltraFit are trademarks of 3M Company. Used under license by 3M subsidiaries and affiliates.