



ALLIED MACHINE & ENGINEERING CORP



High Performance and Universal Style Catalog

www.alliedmachine.com



Represented by:



Made in the USA

Allied Machine & Engineering Corp is Registered by U.L. to ISO 9001:2008

ALLIED MACHINE & ENGINEERING CORP

Our focus on product excellence, service to the customer, respect for the individual and competitive advantage enables us to deliver outstanding results in a diverse range of manufacturing, production and process engineering industries.

As a result, Allied Machine high performance tooling is helping countless businesses around the world to produce better products with greater accuracy, increased speed and higher quality.

Precision, performance and productivity are core features of Allied Machine tooling. Our commitment to innovation in all aspects of holemaking technology means we continually set new industry standards in production efficiency, tool life and manufacturing cost improvements.

This product catalog provides detailed information on products in a comprehensive, easy to use, and informative single source reference guide. However, we recognize that every company's needs are unique, which is why our customer service and technical support teams are always available to provide help and advice, should you need it.

Whatever your need, Allied Machine & Engineering Corp. delivers high performance tooling on the cutting edge.



⚠ WARNING

Tool failure during use can cause serious injury. Follow safety precautions and instructions that accompany machinery and all tools.

Wear safety glasses and appropriate safety equipment at all times when machinery is operating.





High Performance / Universal Reference Page	Page 4
130° High Performance Drill Inserts (A, B, C Series)	Pages 5-6
130° High Performance Drill Inserts (D, E, F, G, H Series)	Pages 7-9
130° High Performance Drill (Adapter and Blade-Loc Accessories)	Page 10
Universal Drill Inserts (A, B, C Series)	Pages 11-12
Universal Drill Inserts (D, E, F, G, H Series)	Pages 13-16
Standard Straight Shank Holder	Pages 17-19
Standard Taper Shank Holder	Pages 20-22
Standard 50 NMTB Holder	Pages 23-24
Top Mounting Plate and Cylindrical Grinding Fixture	Page 25
High Performance / Universal Technical Information (Speeds & Feeds and Coolant Recommendations)	Pages 26-27
Rotary Coolant Adapter (RCA) Technical Information	Page 28
Deep Hole Drilling Guidelines	Page 29
High Performance / Universal Regrind Charts	Page 30
Warranty	Page 31

SAFETY ALERT

Your safety and the safety of others is very important. This catalog contains important safety messages. Always read and follow all safety precautions.



This triangle is a safety alert symbol. It alerts you to potential safety hazards that can cause tool failure and serious injury. When you see this symbol in the catalog, look for a related safety message that may be near this triangle or referred to in the nearby text.



WARNING

There are safety signal words also used in the catalog. Safety messages follow these words.

WARNING (shown above) means that failure to follow the precautions in this message could result in tool failure and serious injury.

NOTE and **IMPORTANT** are also used. These are important that you read and follow but are not safety-related.

Visit www.alliedmachine.com for the most up-to-date information and procedures.



Made in the USA





High Performance / Universal Reference

High Performance Spade Drill Item Number ↓ Diameters

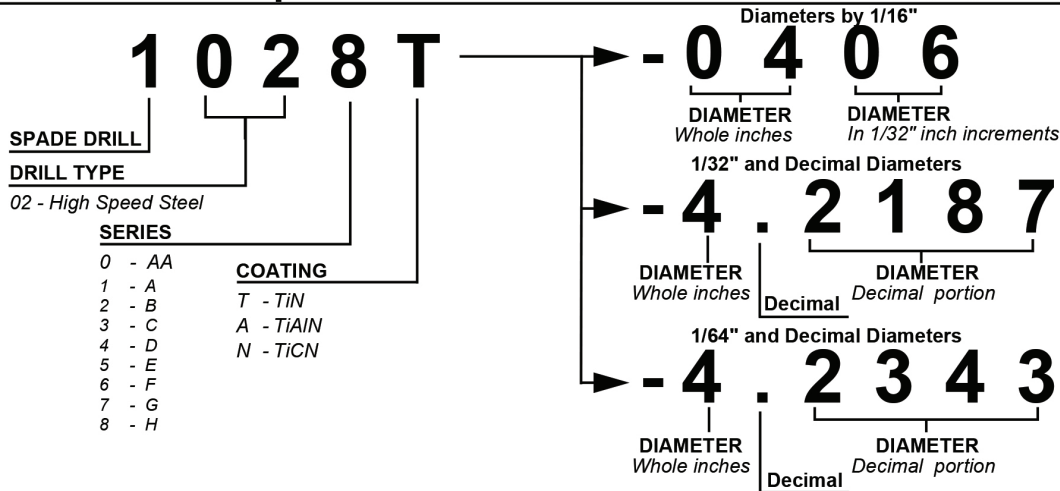

Universal Spade Drill Item Number ↓ Diameters

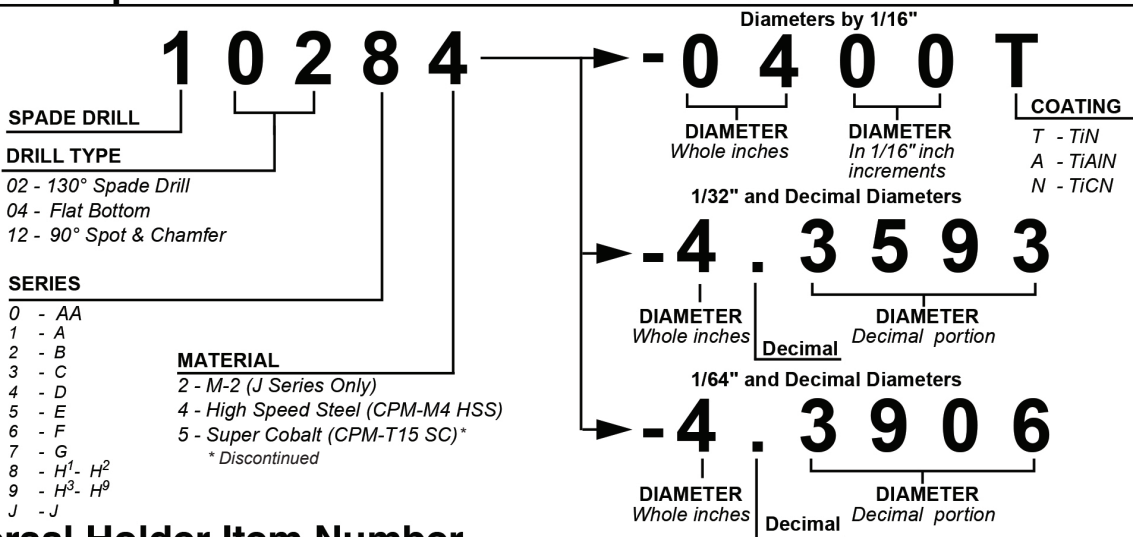

Universal Holder Item Number

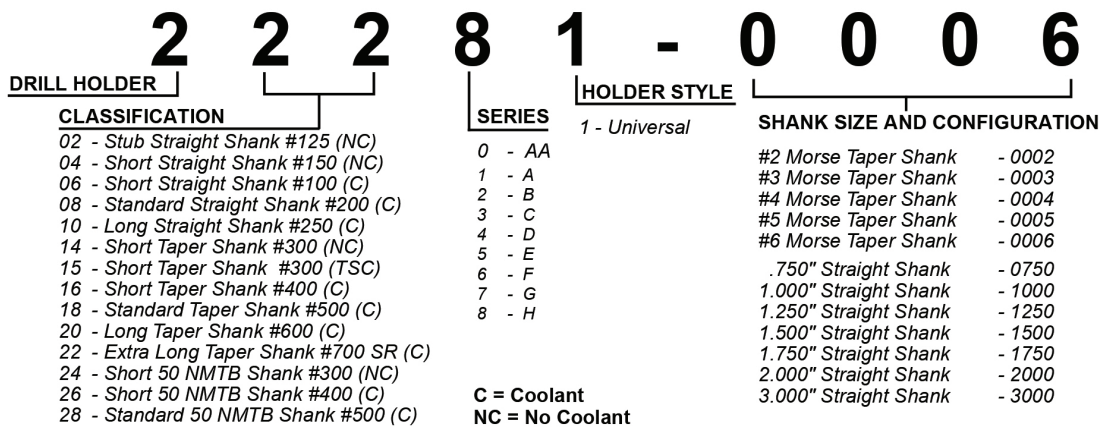

133° High Performance Spade Drills

A-B Series

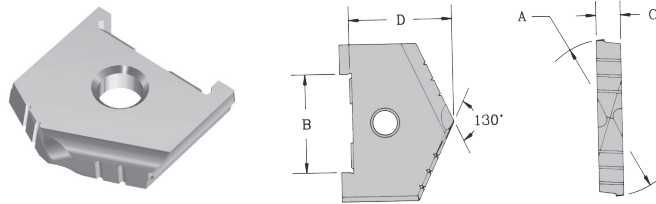

Series	A		Item Number and Coating					B	C	D	
	Inch	Decimal	TiN (HSS)	⓪	TiAlN (HSS)	⓪	TiCN (HSS)	⓪	Locating Area	Thickness	Reference Length
A	31/32"	0.9688"	1021T-0031	⓪	1020A-0031	⓪	1020N-0031	▲	3/4"	3/16"	7/8"
	1"	1.0000"	1021T-0100	⓪	1021A-0100	⓪	1021N-0100	▲			
	1-1/32"	1.0313"	1021T-0101	⓪	1021A-0101	⓪	1021N-0101	▲			
	1-1/16"	1.0625"	1021T-0102	⓪	1021A-0102	⓪	1021N-0102	▲			
	1-3/32"	1.0938"	1021T-0103	⓪	1021A-0103	⓪	1021N-0103	▲			
	1-1/8"	1.1250"	1021T-0104	⓪	1021A-0104	⓪	1021N-0104	▲			
	1-5/32"	1.1563"	1021T-0105	⓪	1021A-0105	⓪	1021N-0105	▲			
	1-3/16"	1.1875"	1021T-0106	⓪	1021A-0106	⓪	1021N-0106	▲			
	1-7/32"	1.2188"	1021T-0107	⓪	1021A-0107	⓪	1021N-0107	▲			
	1-1/4"	1.2500"	1021T-0108	⓪	1021A-0108	⓪	1021N-0108	▲			
A Oversize	1-9/32"	1.2813"	1021T-0109	⓪	1021A-0109	⓪	1021N-0109	▲			
	1-5/16"	1.3125"	1021T-0110	⓪	1021A-0110	⓪	1021N-0110	▲			
	1-11/32"	1.3438"	1021T-0111	⓪	1021A-0111	⓪	1021N-0111	▲			
	1-3/8"	1.3750"	1021T-0112	⓪	1021A-0112	⓪	1021N-0112	▲			
B	1-1/4"	1.2500"	1022T-0108	⓪	1022A-0108	⓪	1022N-0108	▲	1-1/16"	9/32"	1-3/32"
	1-9/32"	1.2813"	1022T-0109	⓪	1022A-0109	⓪	1022N-0109	▲			
	1-5/16"	1.3125"	1022T-0110	⓪	1022A-0110	⓪	1022N-0110	▲			
	1-11/32"	1.3438"	1022T-0111	⓪	1022A-0111	⓪	1022N-0111	▲			
	1-3/8"	1.3750"	1022T-0112	⓪	1022A-0112	⓪	1022N-0112	▲			
	1-13/32"	1.4063"	1022T-0113	⓪	1022A-0113	⓪	1022N-0113	▲			
	1-7/16"	1.4375"	1022T-0114	⓪	1022A-0114	⓪	1022N-0114	▲			
	1-15/32"	1.4688"	1022T-0115	⓪	1022A-0115	⓪	1022N-0115	▲			
1-1/2"	1.5000"	1022T-0116	⓪	1022A-0116	⓪	1022N-0116	▲				

FEATURES

When compared to uncoated Universal Style Spade Drills, TiN, TiCN, and TiAlN Coated High Performance Spade Drills can increase production from 100% to 500%.

Unique tool geometry reduces thrust up to 30% when compared to uncoated Universal Style Spade Drills.

Single piece design in A through C series eliminates the need for adapters ensuring maximum tool performance in these smaller sizes





130° High Performance Spade Drills

B-C Series

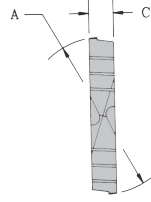
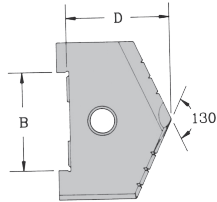
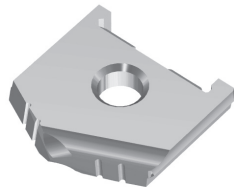

Series	A		Item Number and Coating						B	C	D
	Inch	Decimal	TiN (HSS)	①	TiAlN (HSS)	①	TiCN (HSS)	①	Locating Area	Thickness	Reference Length
B Oversize	1-17/32"	1.5313"	1022T-0117	○	1022A-0117	○	1022N-0117	▲	1-1/16"	9/32"	1-3/32"
	1-9/16"	1.5625"	1022T-0118	○	1022A-0118	○	1022N-0118	▲			
	1-19/32"	1.5938"	1022T-0119	○	1022A-0119	○	1022N-0119	▲			
	1-5/8"	1.6250"	1022T-0120	○	1022A-0120	○	1022N-0120	▲			
	1-21/32"	1.6563"	1022T-0121	○	1022A-0121	○	1022N-0121	▲			
	1-11/16"	1.6875"	1022T-0122	○	1022A-0122	○	1022N-0122	▲			
	1-23/32"	1.7188"	1022T-0123	○	1022A-0123	○	1022N-0123	▲			
	1-3/4"	1.7500"	1022T-0124	○	1022A-0124	○	1022N-0124	▲			
C	1-1/2"	1.5000"	1023T-0116	○	1023A-0116	○	1023N-0116	▲	1-1/4"	5/16"	1-19/64"
	1-17/32"	1.5313"	1023T-0117	○	1023A-0117	○	1023N-0117	▲			
	1-9/16"	1.5625"	1023T-0118	○	1023A-0118	○	1023N-0118	▲			
	1-19/32"	1.5938"	1023T-0119	○	1023A-0119	○	1023N-0119	▲			
	1-5/8"	1.6250"	1023T-0120	○	1023A-0120	○	1023N-0120	▲			
	1-21/32"	1.6563"	1023T-0121	○	1023A-0121	○	1023N-0121	▲			
	1-11/16"	1.6875"	1023T-0122	○	1023A-0122	○	1023N-0122	▲			
	1-23/32"	1.7188"	1023T-0123	○	1023A-0123	○	1023N-0123	▲			
	1-3/4"	1.7500"	1023T-0124	○	1023A-0124	○	1023N-0124	▲			
	1-25/32"	1.7813"	1023T-0125	○	1023A-0125	○	1023N-0125	▲			
	1-13/16"	1.8125"	1023T-0126	○	1023A-0126	○	1023N-0126	▲			
	1-27/32"	1.8438"	1023T-0127	○	1023A-0127	○	1023N-0127	▲			
	1-7/8"	1.8750"	1023T-0128	○	1023A-0128	○	1023N-0128	▲			
	1-29/32"	1.9063"	1023T-0129	○	1023A-0129	○	1023N-0129	▲			
	1-15/16"	1.9375"	1023T-0130	○	1023A-0130	○	1023N-0130	▲			
	1-31/32"	1.9688"	1023T-0131	○	1023A-0131	○	1023N-0131	▲			
2"	2.0000"	1023T-0200	○	1023A-0200	○	1023N-0200	▲				
C Oversize	2-1/32"	2.0313"	1023T-0201	○	1023A-0201	○	1023N-0201	▲			
	2-1/16"	2.0625"	1023T-0202	○	1023A-0202	○	1023N-0202	▲			
	2-3/32"	2.0938"	1023T-0203	○	1023A-0203	○	1023N-0203	▲			
	2-1/8"	2.1250"	1023T-0204	○	1023A-0204	○	1023N-0204	▲			
	2-5/32"	2.1563"	1023T-0205	○	1023A-0205	○	1023N-0205	▲			
	2-3/16"	2.1875"	1023T-0206	○	1023A-0206	○	1023N-0206	▲			
	2-7/32"	2.2188"	1023T-0207	○	1023A-0207	○	1023N-0207	▲			
	2-1/4"	2.2500"	1023T-0208	○	1023A-0208	○	1023N-0208	▲			
	2-9/32"	2.2813"	1023T-0209	○	1023A-0209	○	1023N-0209	▲			
	2-5/16"	2.3125"	1023T-0210	○	1023A-0210	○	1023N-0210	▲			
2-11/32"	2.3438"	1023T-0211	○	1023A-0211	○	1023N-0211	▲				
2-3/8"	2.3750"	1023T-0212	○	1023A-0212	○	1023N-0212	▲				

- ① Availability Codes
- Stocked
- ▲ Non-Stocked - 15 work day lead time

Sizes not shown (Non-Standard) Diameters are available in all coatings.
(Process Fee applies - See High Performance and Universal Price List).

When ordering please follow the examples shown below:
 64^{ths} = 1-33/64" TiN (C Series) = 1023T-1.5156
 Decimals = 1.751" TiAlN (C Series) = 1023A-1.7510



133° High Performance Spade Drills

D-E Series

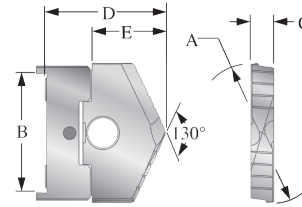
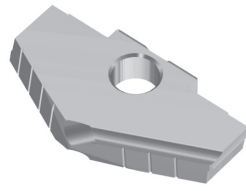

Series	A		Item Number and Coating					B	C	D	E	
	Inch	Decimal	TiN (HSS)	⓪	TiAlN (HSS)	⓪	TiCN (HSS)	⓪	Holder Locating Area	Thickness	Reference Lengths	
			HP w/adaptor	HP								
D	2"	2.0000"	1024T-0200	⓪	1024A-0200	⓪	1024N-0200	▲	1-3/4"	3/8"	1-55/64"	1-3/16"
	2-1/32"	2.0313"	1024T-0201	⓪	1024A-0201	⓪	1024N-0201	▲				
	2-1/16"	2.0625"	1024T-0202	⓪	1024A-0202	⓪	1024N-0202	▲				
	2-3/32"	2.0938"	1024T-0203	⓪	1024A-0203	⓪	1024N-0203	▲				
	2-1/8"	2.1250"	1024T-0204	⓪	1024A-0204	⓪	1024N-0204	▲				
	2-5/32"	2.1563"	1024T-0205	⓪	1024A-0205	⓪	1024N-0205	▲				
	2-3/16"	2.1875"	1024T-0206	⓪	1024A-0206	⓪	1024N-0206	▲				
	2-7/32"	2.2188"	1024T-0207	⓪	1024A-0207	⓪	1024N-0207	▲				
	2-1/4"	2.2500"	1024T-0208	⓪	1024A-0208	⓪	1024N-0208	▲				
	2-9/32"	2.2813"	1024T-0209	⓪	1024A-0209	⓪	1024N-0209	▲				
	2-5/16"	2.3125"	1024T-0210	⓪	1024A-0210	⓪	1024N-0210	▲				
	2-11/32"	2.3438"	1024T-0211	⓪	1024A-0211	⓪	1024N-0211	▲				
	2-3/8"	2.3750"	1024T-0212	⓪	1024A-0212	⓪	1024N-0212	▲				
	2-13/32"	2.4063"	1024T-0213	⓪	1024A-0213	⓪	1024N-0213	▲				
	2-7/16"	2.4375"	1024T-0214	⓪	1024A-0214	⓪	1024N-0214	▲				
	2-15/32"	2.4688"	1024T-0215	⓪	1024A-0215	⓪	1024N-0215	▲				
2-1/2"	2.5000"	1024T-0216	⓪	1024A-0216	⓪	1024N-0216	▲					
D Oversize	2-17/32"	2.5313"	1024T-0217	⓪	1024A-0217	⓪	1024N-0217	▲				
	2-9/16"	2.5625"	1024T-0218	⓪	1024A-0218	⓪	1024N-0218	▲				
	2-19/32"	2.5938"	1024T-0219	⓪	1024A-0219	⓪	1024N-0219	▲				
	2-5/8"	2.6250"	1024T-0220	⓪	1024A-0220	⓪	1024N-0220	▲				
	2-21/32"	2.6563"	1024T-0221	⓪	1024A-0221	⓪	1024N-0221	▲				
	2-11/16"	2.6875"	1024T-0222	⓪	1024A-0222	⓪	1024N-0222	▲				
	2-23/32"	2.7188"	1024T-0223	⓪	1024A-0223	⓪	1024N-0223	▲				
	2-3/4"	2.7500"	1024T-0224	⓪	1024A-0224	⓪	1024N-0224	▲				
	2-25/32"	2.7813"	1024T-0225	⓪	1024A-0225	⓪	1024N-0225	▲				
	2-13/16"	2.8125"	1024T-0226	⓪	1024A-0226	⓪	1024N-0226	▲				
	2-27/32"	2.8438"	1024T-0227	⓪	1024A-0227	⓪	1024N-0227	▲				
2-7/8"	2.8750"	1024T-0228	⓪	1024A-0228	⓪	1024N-0228	▲					
E	2-1/2"	2.5000"	1025T-0216	⓪	1025A-0216	⓪	1025N-0216	▲	2-1/16"	7/16"	2-3/32"	1-7/16"
	2-17/32"	2.5313"	1025T-0217	⓪	1025A-0217	⓪	1025N-0217	▲				
	2-9/16"	2.5625"	1025T-0218	⓪	1025A-0218	⓪	1025N-0218	▲				
	2-19/32"	2.5938"	1025T-0219	⓪	1025A-0219	⓪	1025N-0219	▲				
	2-5/8"	2.6250"	1025T-0220	⓪	1025A-0220	⓪	1025N-0220	▲				
	2-21/32"	2.6563"	1025T-0221	⓪	1025A-0221	⓪	1025N-0221	▲				
	2-11/16"	2.6875"	1025T-0222	⓪	1025A-0222	⓪	1025N-0222	▲				
	2-23/32"	2.7188"	1025T-0223	⓪	1025A-0223	⓪	1025N-0223	▲				
	2-3/4"	2.7500"	1025T-0224	⓪	1025A-0224	⓪	1025N-0224	▲				
	2-25/32"	2.7813"	1025T-0225	⓪	1025A-0225	⓪	1025N-0225	▲				
	2-13/16"	2.8125"	1025T-0226	⓪	1025A-0226	⓪	1025N-0226	▲				
	2-27/32"	2.8438"	1025T-0227	⓪	1025A-0227	⓪	1025N-0227	▲				
	2-7/8"	2.8750"	1025T-0228	⓪	1025A-0228	⓪	1025N-0228	▲				
	2-29/32"	2.9063"	1025T-0229	⓪	1025A-0229	⓪	1025N-0229	▲				
	2-15/16"	2.9375"	1025T-0230	⓪	1025A-0230	⓪	1025N-0230	▲				
	2-31/32"	2.9688"	1025T-0231	⓪	1025A-0231	⓪	1025N-0231	▲				
3"	3.0000"	1025T-0300	⓪	1025A-0300	⓪	1025N-0300	▲					

NOTE: Adapter required for D through H series High Performance Spade Drills - see page 10. Adapter sold separately





130° High Performance Spade Drills

E-F Series

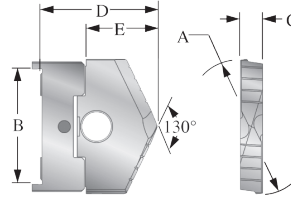
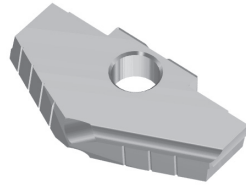

Series	A		Item Number and Coating						B Holder Locating Area	C Thickness	D		E
	Inch	Decimal	TiN (HSS)	①	TiAlN (HSS)	①	TiCN (HSS)	①			Reference Lengths		
											HP w/adaptor	HP	
E Oversize	3-1/32"	3.0313"	1025T-0301	○	1025A-0301	○	1025N-0301	▲	2-1/16"	7/16"	2-3/32"	1-7/16"	
	3-1/16"	3.0625"	1025T-0302	○	1025A-0302	○	1025N-0302	▲					
	3-3/32"	3.0938"	1025T-0303	○	1025A-0303	○	1025N-0303	▲					
	3-1/8"	3.1250"	1025T-0304	○	1025A-0304	○	1025N-0304	▲					
	3-5/32"	3.1563"	1025T-0305	○	1025A-0305	○	1025N-0305	▲					
	3-3/16"	3.1875"	1025T-0306	○	1025A-0306	○	1025N-0306	▲					
	3-7/32"	3.2188"	1025T-0307	○	1025A-0307	○	1025N-0307	▲					
	3-1/4"	3.2500"	1025T-0308	○	1025A-0308	○	1025N-0308	▲					
	3-9/32"	3.2813"	1025T-0309	○	1025A-0309	○	1025N-0309	▲					
	3-5/16"	3.3125"	1025T-0310	○	1025A-0310	○	1025N-0310	▲					
	3-11/32"	3.3438"	1025T-0311	○	1025A-0311	○	1025N-0311	▲					
	3-3/8"	3.3750"	1025T-0312	○	1025A-0312	○	1025N-0312	▲					
F	3"	3.0000"	1026T-0300	○	1026A-0300	○	1026N-0300	▲	2-5/8"	1/2"	2-17/32"	1-13/16"	
	3-1/32"	3.0313"	1026T-0301	○	1026A-0301	○	1026N-0301	▲					
	3-1/16"	3.0625"	1026T-0302	○	1026A-0302	○	1026N-0302	▲					
	3-3/32"	3.0938"	1026T-0303	○	1026A-0303	○	1026N-0303	▲					
	3-1/8"	3.1250"	1026T-0304	○	1026A-0304	○	1026N-0304	▲					
	3-5/32"	3.1563"	1026T-0305	○	1026A-0305	○	1026N-0305	▲					
	3-3/16"	3.1875"	1026T-0306	○	1026A-0306	○	1026N-0306	▲					
	3-7/32"	3.2188"	1026T-0307	○	1026A-0307	○	1026N-0307	▲					
	3-1/4"	3.2500"	1026T-0308	○	1026A-0308	○	1026N-0308	▲					
	3-9/32"	3.2813"	1026T-0309	○	1026A-0309	○	1026N-0309	▲					
	3-5/16"	3.3125"	1026T-0310	○	1026A-0310	○	1026N-0310	▲					
	3-11/32"	3.3438"	1026T-0311	○	1026A-0311	○	1026N-0311	▲					
	3-3/8"	3.3750"	1026T-0312	○	1026A-0312	○	1026N-0312	▲					
	3-13/32"	3.4063"	1026T-0313	○	1026A-0313	○	1026N-0313	▲					
	3-7/16"	3.4375"	1026T-0314	○	1026A-0314	○	1026N-0314	▲					
	3-15/32"	3.4688"	1026T-0315	○	1026A-0315	○	1026N-0315	▲					
3-1/2"	3.5000"	1026T-0316	○	1026A-0316	○	1026N-0316	▲						
F Oversize	3-17/32"	3.5313"	1026T-0317	○	1026A-0317	○	1026N-0317	▲					
	3-9/16"	3.5625"	1026T-0318	○	1026A-0318	○	1026N-0318	▲					
	3-19/32"	3.5938"	1026T-0319	○	1026A-0319	○	1026N-0319	▲					
	3-5/8"	3.6250"	1026T-0320	○	1026A-0320	○	1026N-0320	▲					
	3-21/32"	3.6563"	1026T-0321	○	1026A-0321	○	1026N-0321	▲					
	3-11/16"	3.6875"	1026T-0322	○	1026A-0322	○	1026N-0322	▲					
	3-23/32"	3.7188"	1026T-0323	○	1026A-0323	○	1026N-0323	▲					
	3-3/4"	3.7500"	1026T-0324	○	1026A-0324	○	1026N-0324	▲					
	3-25/32"	3.7813"	1026T-0325	○	1026A-0325	○	1026N-0325	▲					
	3-13/16"	3.8125"	1026T-0326	○	1026A-0326	○	1026N-0326	▲					
3-27/32"	3.8438"	1026T-0327	○	1026A-0327	○	1026N-0327	▲						
3-7/8"	3.8750"	1026T-0328	○	1026A-0328	○	1026N-0328	▲						

NOTE: Adapter required for D through H series High Performance Spade Drills - see page 10. Adapter sold separately

- ① Availability Codes
- Stocked
- ▲ Non-Stocked - 15 work day lead time

Sizes not shown (Non-Standard) Diameters are available in all coatings. (Process Fee applies - See High Performance and Universal Price List).
 When ordering please follow the examples shown below:
 64^{ths} = 3-3/64" TiN (E Series) = 1025T-3.0469
 Decimals = 3.247" TiAlN (F Series) = 1026A-3.2470



130° High Performance Spade Drills

G-H Series

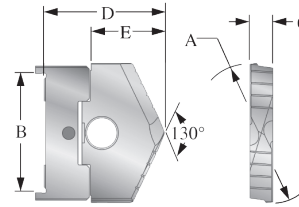
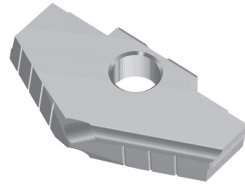

Series	A		Item Number and Coating						B	C	D	E
	Inch	Decimal	TiN (HSS)	①	TiAlN (HSS)	①	TiCN (HSS)	①	Holder Locating Area	Thickness	Reference Lengths	
			HP w/adaptor	HP								
G	3-1/2"	3.5000"	1027T-0316	○	1027A-0316	○	1027N-0316	▲	3-1/16"	5/8"	2-23/32"	1-15/16"
	3-17/32"	3.5313"	1027T-0317	○	1027A-0317	○	1027N-0317	▲				
	3-9/16"	3.5625"	1027T-0318	○	1027A-0318	○	1027N-0318	▲				
	3-19/32"	3.5938"	1027T-0319	○	1027A-0319	○	1027N-0319	▲				
	3-5/8"	3.6250"	1027T-0320	○	1027A-0320	○	1027N-0320	▲				
	3-21/32"	3.6563"	1027T-0321	○	1027A-0321	○	1027N-0321	▲				
	3-11/16"	3.6875"	1027T-0322	○	1027A-0322	○	1027N-0322	▲				
	3-23/32"	3.7188"	1027T-0323	○	1027A-0323	○	1027N-0323	▲				
	3-3/4"	3.7500"	1027T-0324	○	1027A-0324	○	1027N-0324	▲				
	3-25/32"	3.7813"	1027T-0325	○	1027A-0325	○	1027N-0325	▲				
	3-13/16"	3.8125"	1027T-0326	○	1027A-0326	○	1027N-0326	▲				
	3-27/32"	3.8438"	1027T-0327	○	1027A-0327	○	1027N-0327	▲				
	3-7/8"	3.8750"	1027T-0328	○	1027A-0328	○	1027N-0328	▲				
	3-29/32"	3.9063"	1027T-0329	○	1027A-0329	○	1027N-0329	▲				
	3-15/16"	3.9375"	1027T-0330	○	1027A-0330	○	1027N-0330	▲				
3-31/32"	3.9688"	1027T-0331	○	1027A-0331	○	1027N-0331	▲					
4"	4.0000"	1027T-0400	○	1027A-0400	○	1027N-0400	▲					
G Oversize	4-1/16"	4.0625"	1027T-0402	○	1027A-0402	○	1027N-0402	▲				
	4-1/8"	4.1250"	1027T-0404	○	1027A-0404	○	1027N-0404	▲				
	4-3/16"	4.1875"	1027T-0406	○	1027A-0406	○	1027N-0406	▲				
	4-1/4"	4.2500"	1027T-0408	○	1027A-0408	○	1027N-0408	▲				
	4-5/16"	4.3125"	1027T-0410	○	1027A-0410	○	1027N-0410	▲				
	4-3/8"	4.3750"	1027T-0412	○	1027A-0412	○	1027N-0412	▲				
	4-7/16"	4.4375"	1027T-0414	○	1027A-0414	○	1027N-0414	▲				
	4-1/2"	4.5000"	1027T-0416	○	1027A-0416	○	1027N-0416	▲				
H ¹	4"	4.0000"	1028T-0400	○	1028A-0400	○	1028N-0400	▲	3-1/2"	11/16"	3-3/32"	2-3/16"
	4-1/16"	4.0625"	1028T-0402	○	1028A-0402	○	1028N-0402	▲				
	4-1/8"	4.1250"	1028T-0404	○	1028A-0404	○	1028N-0404	▲				
	4-3/16"	4.1875"	1028T-0406	○	1028A-0406	○	1028N-0406	▲				
	4-1/4"	4.2500"	1028T-0408	○	1028A-0408	○	1028N-0408	▲				
	4-5/16"	4.3125"	1028T-0410	○	1028A-0410	○	1028N-0410	▲				
	4-3/8"	4.3750"	1028T-0412	○	1028A-0412	○	1028N-0412	▲				
	4-7/16"	4.4375"	1028T-0414	○	1028A-0414	○	1028N-0414	▲				
4-1/2"	4.5000"	1028T-0416	○	1028A-0416	○	1028N-0416	▲					
H ²	4-9/16"	4.5625"	1028T-0418	○	1028A-0418	○	1028N-0418	▲	3-1/2"	11/16"	3-3/32"	2-3/16"
	4-5/8"	4.6250"	1028T-0420	○	1028A-0420	○	1028N-0420	▲				
	4-11/16"	4.6875"	1028T-0422	○	1028A-0422	○	1028N-0422	▲				
	4-3/4"	4.7500"	1028T-0424	○	1028A-0424	○	1028N-0424	▲				
	4-13/16"	4.8125"	1028T-0426	○	1028A-0426	○	1028N-0426	▲				
	4-7/8"	4.8750"	1028T-0428	○	1028A-0428	○	1028N-0428	▲				
	4-15/16"	4.9375"	1028T-0430	○	1028A-0430	○	1028N-0430	▲				
	5"	5.0000"	1028T-0500	○	1028A-0500	○	1028N-0500	▲				

**NOTE: Adapter required for D through H series High Performance Spade Drills - see page 10.
Adapter sold separately**



High Performance Spade Drills

Adapters and Blade-Loc

Series	Item Number	A	B	C	D	E
		Diameter	Holder Location	Thickness	Reference Length	Blade Location
D	1024U-Adapter	1.995"	1-3/4"	3/8"	43/64"	15/16"
E	1025U-Adapter	2.495"	2-1/16"	7/16"	21/32"	1-3/16"
F	1026U-Adapter	2.995"	2-5/8"	1/2"	23/32"	1-1/4"
G	1027U-Adapter	3.495"	3-1/16"	5/8"	25/32"	1-13/16"
H	1028U-Adapter	3.995"	3-1/2"	11/16"	29/32"	2-1/4"

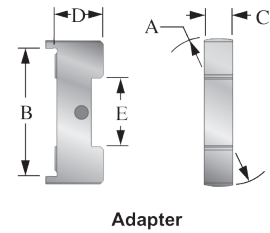

Adapter

Adapter Interchangeability

One each, D through H series, High Performance Adapters and holders allow the use of the complete range of High Performance Spade Drills. Adapters are not needed for A through C series. Our High Performance Spade Drills and Adapters interchange with other Universal Style Drill Holders and are manufactured to ANSI B94.49-1975 TYPE I specifications.

Non-Standard Diameters

The HP diameter range is 31/32" to 5" in .001" increments. Lead time is three weeks. We recommend that you contact your local Allied distributor to discuss a stocking commitment for the non-standard diameters that you will be purchasing repetitively. This will ensure off-the-shelf delivery. Please refer to the Non-Standard Diameter section in our price list for more information.

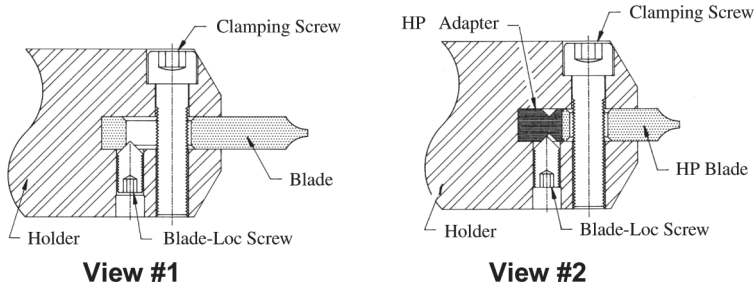
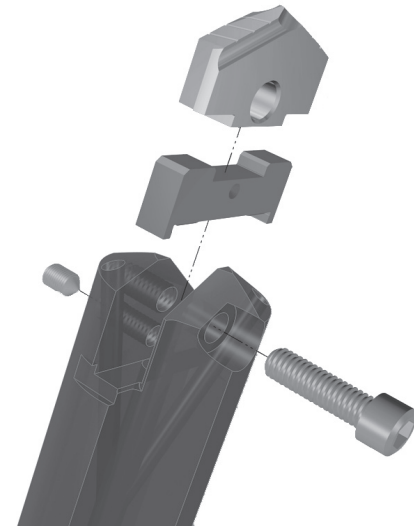

View #1

View #2

Blade-Loc Drill Holders (D through H Series)

The views above illustrate our Blade-Loc feature and how it works with both Universal Style and High Performance Spade Drills.

View #1 shows the Blade-Loc Screw making contact with a Universal Style Spade Drill. Tightening the Blade-Loc Screw helps align the spade drill while locking it in place. This protects against tool movement during the drilling cycle as well as when the tool is being retracted from the hole. The Blade-Loc feature is standard in Allied holders (D - H Series) and makes our product unique!

View #2 shows how the Blade-Loc Screw is used with Allied HP Adapters. This feature secures the adapter to the holder so High Performance Drills can be exchanged without any need to remove, clean and re-insert the adapter.

Series	Clamping Screw	Blade-Loc Screw
A	#10-24 x 5/8"	N/A
B	1/4"-20 x 7/8"	N/A
C	1/4"-20 x 1	N/A
D	3/8"-16 x 1-1/4"	5/16"-18 x 1/2"
E	1/2"-13 x 1-3/4"	5/16"-18 x 1/2"
F	5/8"-10 x 2	5/16"-18 x 1/2"
G	3/4"-10 x 2-1/2"	5/16"-18 x 1/2"
H	3/4"-10 x 2-1/2"	3/8"-16 x 3/4"



Universal Spade Drills

A-B Series



Series	A		Item Number				B	C	D
	Inch	Decimal	130° CPM-M4 (HSS)	130° CPM-T15♦ (Super Cobalt)	Flat Bottom (HSS)	90° Spot and Chamfer (HSS)	Locating Area	Thickness	Reference Length
A	31/32"	0.9688	10214-0031	-	-	* P.O.R.	3/4"	3/16"	1-5/32"
	1"	1.0000"	10214-0100	-	10414-0100	"			
	1-1/32"	1.0313"	10214-0101	-	-	"			
	1-1/16"	1.0625"	10214-0102	10215-0102	10414-0102	"			
	1-3/32"	1.0938"	10214-0103	-	-	"			
	1-1/8"	1.1250"	10214-0104	10215-0104	10414-0104	"			
	1-5/32"	1.1563"	10214-0105	-	-	"			
	1-3/16"	1.1875"	10214-0106	10215-0106	10414-0106	"			
	1-7/32"	1.2188"	10214-0107	-	-	"			
	1-1/4"	1.2500"	10214-0108	-	10414-0108	11214-0108			
A Oversize	1-9/32"	1.2813"	10214-0109	N/A	N/A	N/A			
	1-5/16"	1.3125"	10214-0110						
	1-11/32"	1.3438"	10214-0111						
	1-3/8"	1.3750"	10214-0112						
B	1-1/4"	1.2500"	10224-0108	10225-0108	10424-0108	* P.O.R.	1-1/16"	9/32"	1-13/32"
	1-9/32"	1.2813"	10224-0109	-	-	"			
	1-5/16"	1.3125"	10224-0110	10225-0110	10424-0110	"			
	1-11/32"	1.3438"	10224-0111	-	-	"			
	1-3/8"	1.3750"	10224-0112	-	10424-0112	"			
	1-13/32"	1.4063"	10224-0113	-	-	"			
	1-7/16"	1.4375"	10224-0114	-	10424-0114	"			
	1-15/32"	1.4688"	10224-0115	-	-	"			
	1-1/2"	1.5000"	10224-0116	-	10424-0116	11224-0116			

***P.O.R. - Priced on Request**

♦All 130° CPM-T15 Universal Spade Blades are discontinued items: Items listed are available, subject to prior sale, at list prices until stock is depleted. Once stock is depleted, items are available as quoted specials only.





Universal Spade Drills

B-C Series

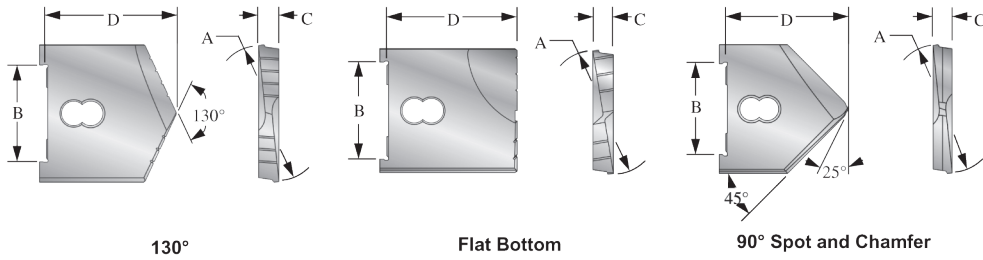

Series	A		Item Number				B	C	D
	Inch	Decimal	130° CPM-M4 (HSS)	130° CPM-T15♦ (Super Cobalt)	Flat Bottom (HSS)	90° Spot and Chamfer (HSS)	Locating Area	Thickness	Reference Length
B Oversize	1-17/32"	1.5313"	10224-0117	N/A	N/A	N/A	1-1/16"	9/32"	1-13/32"
	1-9/16"	1.5625"	10224-0118						
	1-19/32"	1.5938"	10224-0119						
	1-5/8"	1.6250"	10224-0120						
	1-21/32"	1.6563"	10224-0121						
	1-11/16"	1.6875"	10224-0122						
	1-23/32"	1.7188"	10224-0123						
	1-3/4"	1.7500"	10224-0124						
C	1-1/2"	1.5000"	10234-0116	10235-0116	10434-0116	* P.O.R.	1-1/4"	5/16"	2"
	1-17/32"	1.5313"	10234-0117	-	-	"			
	1-9/16"	1.5625"	10234-0118	10235-0118	10434-0118	"			
	1-19/32"	1.5938"	10234-0119	-	-	"			
	1-5/8"	1.6250"	10234-0120	10235-0120	10434-0120	"			
	1-21/32"	1.6563"	10234-0121	-	-	"			
	1-11/16"	1.6875"	10234-0122	10235-0122	10434-0122	"			
	1-23/32"	1.7188"	10234-0123	-	-	"			
	1-3/4"	1.7500"	10234-0124	10235-0124	10434-0124	"			
	1-25/32"	1.7813"	10234-0125	-	-	"			
	1-13/16"	1.8125"	10234-0126	10235-0126	10434-0126	"			
	1-27/32"	1.8438"	10234-0127	-	-	"			
	1-7/8"	1.8750"	10234-0128	10235-0128	10434-0128	"			
	1-29/32"	1.9063"	10234-0129	-	-	"			
	1-15/16"	1.9375"	10234-0130	10235-0130	10434-0130	"			
	1-31/32"	1.9688"	10234-0131	-	-	"			
2"	2.0000"	10234-0200	10235-0200	10434-0200	11234-0200				
C Oversize	2-1/32"	2.0313"	10234-0201	N/A	N/A	N/A			
	2-1/16"	2.0625"	10234-0202						
	2-3/32"	2.0938"	10234-0203						
	2-1/8"	2.1250"	10234-0204						
	2-5/32"	2.1563"	10234-0205						
	2-3/16"	2.1875"	10234-0206						
	2-7/32"	2.2188"	10234-0207						
	2-1/4"	2.2500"	10234-0208						
	2-9/32"	2.2813"	10234-0209						
	2-5/16"	2.3125"	10234-0210						
	2-11/32"	2.3438"	10234-0211						
	2-3/8"	2.3750"	10234-0212						

***P.O.R. - Priced on Request**

Coating Options (Process Fee applies - see High Performance and Universal Price List.) Please add "T", "A", or "N" to the end of the item number to specify coating type when ordering

"T" for TiN - 10224-0116T
"A" for TiAlN - 10224-0116A
"N" for TiCN - 10224-0116N

Sizes not shown (Non-Standard) Diameters are available in all coatings. (Process Fee applies - See High Performance and Universal Price List).

When ordering please follow the examples shown below:

64^{ths} = 1-17/64" 130° CPM-M4 (B Series) = 10224-1.2656
 Decimals = 1.5110" Flat Bottom (C Series) = 10434-1.5110

Please allow 15 working days for TiN, TiAlN, or TiCN coating.

-Non-Standard Diameter delivery is 10 working days.



Universal Spade Drills

D-E Series

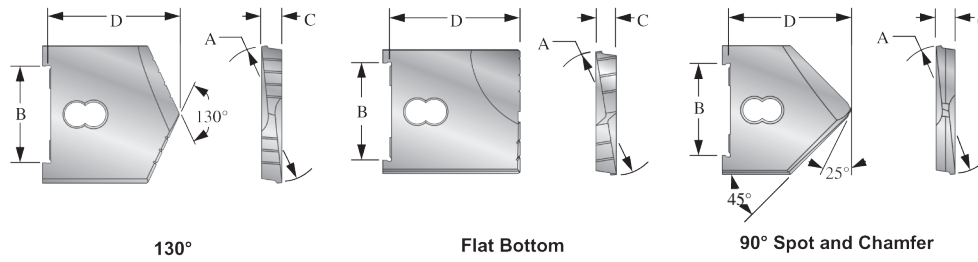

Series	A		Item Number				B	C	D
	Inch	Decimal	130° CPM-M4 (HSS)	130° CPM-T15 (Super Cobalt)	Flat Bottom (HSS)	90° Spot and Chamfer (HSS)	Locating Area	Thickness	Reference Length
D	2"	2.0000"	10244-0200	-	10444-0200	* P.O.R.	1-3/4"	3/8"	2-3/8"
	2-1/32"	2.0313"	10244-0201	-	-	"			
	2-1/16"	2.0625"	10244-0202	10245-0202	10444-0202	"			
	2-3/32"	2.0938"	10244-0203	-	-	"			
	2-1/8"	2.1250"	10244-0204	10245-0204	10444-0204	"			
	2-5/32"	2.1563"	10244-0205	-	-	"			
	2-3/16"	2.1875"	10244-0206	10245-0206	10444-0206	"			
	2-7/32"	2.2188"	10244-0207	-	-	"			
	2-1/4"	2.2500"	10244-0208	10245-0208	10444-0208	"			
	2-9/32"	2.2813"	10244-0209	-	-	"			
	2-5/16"	2.3125"	10244-0210	10245-0210	10444-0210	"			
	2-11/32"	2.3438"	10244-0211	-	-	"			
	2-3/8"	2.3750"	10244-0212	-	10444-0212	"			
	2-13/32"	2.4063"	10244-0213	-	-	"			
	2-7/16"	2.4375"	10244-0214	-	10444-0214	"			
	2-15/32"	2.4688"	10244-0215	-	-	"			
	2-1/2"	2.5000"	10244-0216	-	10444-0216	11244-0216			
D Oversize	2-17/32"	2.5313"	10244-0217	N/A	N/A	N/A			
	2-9/16"	2.5625"	10244-0218						
	2-19/32"	2.5938"	10244-0219						
	2-5/8"	2.6250"	10244-0220						
	2-21/32"	2.6563"	10244-0221						
	2-11/16"	2.6875"	10244-0222						
	2-23/32"	2.7188"	10244-0223						
	2-3/4"	2.7500"	10244-0224						
	2-25/32"	2.7813"	10244-0225						
	2-13/16"	2.8125"	10244-0226						
	2-27/32"	2.8438"	10244-0227						
2-7/8"	2.8750"	10244-0228							
E	2-1/2"	2.5000"	10254-0216	10255-0216	10454-0216	* P.O.R.	2-1/16"	7/16"	2-5/8"
	2-17/32"	2.5313"	10254-0217	-	-	"			
	2-9/16"	2.5625"	10254-0218	10255-0218	10454-0218	"			
	2-19/32"	2.5938"	10254-0219	-	-	"			
	2-5/8"	2.6250"	10254-0220	10255-0220	10454-0220	"			
	2-21/32"	2.6563"	10254-0221	-	-	"			
	2-11/16"	2.6875"	10254-0222	10255-0222	10454-0222	"			
	2-23/32"	2.7188"	10254-0223	-	-	"			
	2-3/4"	2.7500"	10254-0224	10255-0224	10454-0224	"			
	2-25/32"	2.7813"	10254-0225	-	-	"			
	2-13/16"	2.8125"	10254-0226	10255-0226	10454-0226	"			
	2-27/32"	2.8438"	10254-0227	-	-	"			
	2-7/8"	2.8750"	10254-0228	-	10454-0228	"			
	2-29/32"	2.9063"	10254-0229	-	-	"			
	2-15/16"	2.9375"	10254-0230	10255-0230	10454-0230	"			
	2-31/32"	2.9688"	10254-0231	-	-	"			
	3"	3.0000"	10254-0300	10255-0300	10454-0300	11254-0300			

***P.O.R. - Priced on Request**

♦All 130° CPM-T15 Universal Spade Blades are discontinued items: Items listed are available, subject to prior sale, at list prices until stock is depleted. Once stock is depleted, items are available as quoted specials only.





Universal Spade Drills

E-F Series

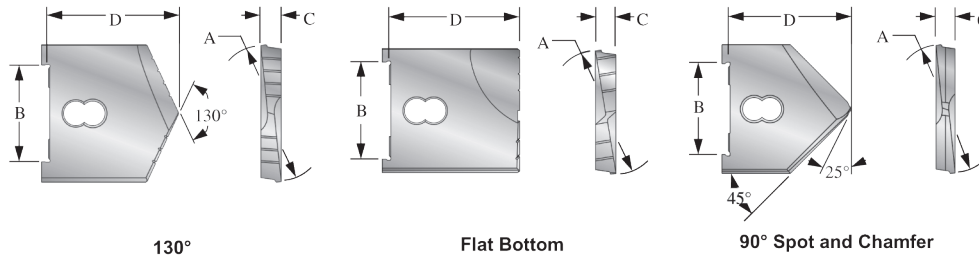

Series	A		Item Number				B Locating Area	C Thickness	D Reference Length
	Inch	Decimal	130° CPM-M4 (HSS)	130° CPM-T15♦ (Super Cobalt)	Flat Bottom (HSS)	90° Spot and Chamfer (HSS)			
E Oversize	3-1/32"	3.0313"	10254-0301	N/A	N/A	N/A	2-1/16"	7/16"	2-5/8"
	3-1/16"	3.0625"	10254-0302						
	3-3/32"	3.0938"	10254-0303						
	3-1/8"	3.1250"	10254-0304						
	3-5/32"	3.1563"	10254-0305						
	3-3/16"	3.1875"	10254-0306						
	3-7/32"	3.2188"	10254-0307						
	3-1/4"	3.2500"	10254-0308						
	3-9/32"	3.2813"	10254-0309						
	3-5/16"	3.3125"	10254-0310						
	3-11/32"	3.3438"	10254-0311						
	3-3/8"	3.3750"	10254-0312						
	F	3"	3.0000"						
3-1/32"		3.0313"	10264-0301	-	10464-0301	"			
3-1/16"		3.0625"	10264-0302	10265-0302	10464-0302	"			
3-3/32"		3.0938"	10264-0303	-	10464-0303	"			
3-1/8"		3.1250"	10264-0304	10265-0304	10464-0304	"			
3-5/32"		3.1563"	10264-0305	-	10464-0305	"			
3-3/16"		3.1875"	10264-0306	10265-0306	10464-0306	"			
3-7/32"		3.2188"	10264-0307	-	10464-0307	"			
3-1/4"		3.2500"	10264-0308	-	10464-0308	"			
3-9/32"		3.2813"	10264-0309	-	10464-0309	"			
3-5/16"		3.3125"	10264-0310	10265-0310	10464-0310	"			
3-11/32"		3.3438"	10264-0311	-	10464-0311	"			
3-3/8"		3.3750"	10264-0312	-	10464-0312	"			
3-13/32"		3.4063"	10264-0313	-	10464-0313	"			
3-7/16"		3.4375"	10264-0314	10265-0314	10464-0314	"			
3-15/32"		3.4688"	10264-0315	-	10464-0315	"			
3-1/2"	3.5000"	10264-0316	-	10464-0316	11264-0316				
F Oversize	3-17/32"	3.5313"	10264-0317	N/A	N/A	N/A	2-5/8"	1/2"	3-1/8"
	3-9/16"	3.5625"	10264-0318						
	3-19/32"	3.5938"	10264-0319						
	3-5/8"	3.6250"	10264-0320						
	3-21/32"	3.6563"	10264-0321						
	3-11/16"	3.6875"	10264-0322						
	3-23/32"	3.7188"	10264-0323						
	3-3/4"	3.7500"	10264-0324						
	3-25/32"	3.7813"	10264-0325						
	3-13/16"	3.8125"	10264-0326						
	3-27/32"	3.8438"	10264-0327						
	3-7/8"	3.8750"	10264-0328						

***P.O.R. - Priced on Request**

Coating Options (Process Fee applies - see High Performance and Universal Price List.) Please add "T", "A", or "N" to the end of the item number to specify coating type when ordering

"T" for TiN - 10254-0302T
"A" for TiAlN - 10254-0302A
"N" for TiCN - 10254-0302N

Sizes not shown (Non-Standard) Diameters are available in all coatings. (Process Fee applies - See High Performance and Universal Price List.)

When ordering please follow the examples shown below:

64^{ths} = 3-5/64" 130° CPM-M4 (F Series) = 10254-3.0781
 Decimals = 3.3910" Flat Bottom (F Series) = 10265-3.3910

Please allow 15 working days for TiN, TiAlN, or TiCN coating.

-Non-Standard Diameter delivery is 10 working days.



Universal Spade Drills

G-H Series

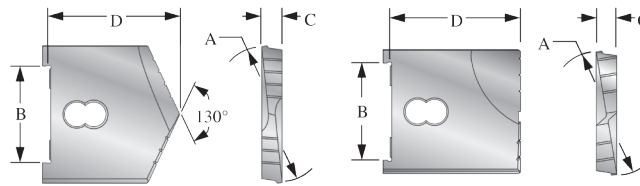

130°

Flat Bottom

Series	A		Item Number			B	C	D
	Inch	Decimal	130° CPM-M4 (HSS)	130° CPM-T15♦ (Super Cobalt)	Flat Bottom (HSS)	Locating Area	Thickness	Reference Length
G	3-1/2"	3.5000"	10274-0316	10275-0316	10474-0316	3-1/16"	5/8"	3-3/8"
	3-17/32"	3.5313"	10274-0317	-	-			
	3-9/16"	3.5625"	10274-0318	10275-0318	10474-0318			
	3-19/32"	3.5938"	10274-0319	-	-			
	3-5/8"	3.6250"	10274-0320	10275-0320	10474-0320			
	3-21/32"	3.6563"	10274-0321	-	-			
	3-11/16"	3.6875"	10274-0322	10275-0322	10474-0322			
	3-23/32"	3.7188"	10274-0323	-	-			
	3-3/4"	3.7500"	10274-0324	10275-0324	10474-0324			
	3-25/32"	3.7813"	10274-0325	-	-			
	3-13/16"	3.8125"	10274-0326	10275-0326	10474-0326			
	3-27/32"	3.8438"	10274-0327	-	-			
	3-7/8"	3.8750"	10274-0328	10275-0328	10474-0328			
	2-29/32"	3.9063"	10274-0329	-	-			
	3-15/16"	3.9375"	10274-0330	10275-0330	10474-0330			
	3-31/32"	3.9688"	10274-0331	-	-			
4"	4.0000"	10274-0400	-	10474-0400				
G Oversize	4-1/16"	4.0625"	10274-0402	N/A	N/A			
	4-1/8"	4.1250"	10274-0404					
	4-3/16"	4.1875"	10274-0406					
	4-1/4"	4.2500"	10274-0408					
	4-5/16"	4.3125"	10274-0410					
	4-3/8"	4.3750"	10274-0412					
	4-7/16"	4.4375"	10274-0414					
	4-1/2"	4.5000"	10274-0416					
H¹	4"	4.0000"	10284-0400	10285-0400	10484-0400	3-1/2"	11/16"	3-11/16"
	4-1/16"	4.0625"	10284-0402	-	-			
	4-1/8"	4.1250"	10284-0404	10285-0404	10484-0404			
	4-3/16"	4.1875"	10284-0406	-	-			
	4-1/4"	4.2500"	10284-0408	-	10484-0408			
	4-5/16"	4.3125"	10284-0410	-	-			
	4-3/8"	4.3750"	10284-0412	-	10484-0412			
	4-7/16"	4.4375"	10284-0414	-	-			
	4-1/2"	4.5000"	10284-0416	10285-0416	10484-0416			
H²	4-9/16"	4.5625"	10284-0418	-	-	3-1/2"	11/16"	3-11/16"
	4-5/8"	4.6250"	10284-0420	-	10484-0420			
	4-11/16"	4.6875"	10284-0422	-	-			
	4-3/4"	4.7500"	10284-0424	-	10484-0424			
	4-13/16"	4.8125"	10284-0426	-	-			
	4-7/8"	4.8750"	10284-0428	-	10484-0428			
	4-15/16"	4.9375"	10284-0430	-	-			
	5"	5.0000"	10284-0500	10285-0500	10484-0500			

♦All 130° CPM-T15 Universal Spade Blades are discontinued items: Items listed are available, subject to prior sale, at list prices until stock is depleted. Once stock is depleted, items are available as quoted specials only.





Universal Spade Drills

H Series

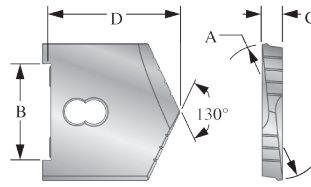

130°

Series	A		Item Number	B	C	D
	Inch	Decimal	130° CPM-M4 (HSS)	Locating Area	Thickness	Reference Length
H ³	5-1/8"	5.1250"	10294-0504	3-1/2"	11/16"	3-11/16"
	5-1/4"	5.2500"	10294-0508			
	5-3/8"	5.3750"	10294-0512			
	5-1/2"	5.5000"	10294-0516			
H ⁴	5-5/8"	5.6250"	10294-0520	3-1/2"	11/16"	3-11/16"
	5-3/4"	5.7500"	10294-0524			
	5-7/8"	5.8750"	10294-0528			
	6"	6.0000"	10294-0600			
H ⁵	6-1/8"	6.1250"	10294-0604	3-1/2"	11/16"	3-11/16"
	6-1/4"	6.2500"	10294-0608			
	6-3/8"	6.3750"	10294-0612			
	6-1/2"	6.5000"	10294-0616			
H ⁶	6-5/8"	6.6250"	10294-0620	3-1/2"	11/16"	3-11/16"
	6-3/4"	6.7500"	10294-0624			
	6-7/8"	6.8750"	12094-0628			
	7"	7.0000"	10294-0700			
H ⁷	7-1/8"	7.1250"	10294-0704	3-1/2"	11/16"	3-11/16"
	7-1/4"	7.250"	10294-0708			
	7-3/8"	7.3750"	10294-0712			
	7-1/2"	7.5000"	10294-0716			
H ⁸	7-5/8"	7.6250"	10294-0720	3-1/2"	11/16"	3-11/16"
	7-3/4"	7.7500"	10294-0724			
	7-7/8"	7.8750"	10294-0728			
	8"	8.0000"	10294-0800			
H ⁹	8-1/8"	8.1250"	10294-0804	3-1/2"	11/16"	3-11/16"
	8-1/4"	8.2500"	10294-0808			
	8-3/8"	8.3750"	10294-0812			
	8-1/2"	8.5000"	10294-0816			

Coating Options (Process Fee applies - see High Performance and Universal Price List.) Please add "T", "A", or "N" to the end of the item number to specify coating type when ordering

"T" for TiN - 10294-0620T

"A" for TiAlN - 10294-0620A

"N" for TiCN - 10264-0620N

Please allow 15 working days for TiN, TiAlN, or TiCN coating.

Sizes not shown (Non-Standard) Diameters are available in all coatings. (Process Fee applies - See High Performance and Universal Price List).

When ordering please follow the examples shown below:

64^{ths} = 7-63/64" 130° CPM-M4 (H⁸ Series) = 10294-7.9843

Decimals = 6.391" 130° CPM-M4 (H⁵ Series) = 10294-6.3910

-Non-Standard Diameter delivery is 10 working days.



High Performance / Universal Holders

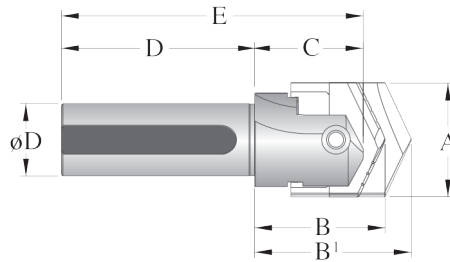

Stub Straight Shank Holder #125 (No Coolant)

Series	Item Number	A	B	B1	C	D		Overall Length
		Blade Diameter Cutting Range	HP Reference Length	Universal Reference Length	Flute Length	Shank		
						Diameter	Length	
C	20231-1500	1-1/2" - 2-3/8"	2-19/64"	3"	2"	1-1/2"	4"	6"
D	20241-1500	2" - 2-7/8"	2-47/64"	3-1/4"	2-1/4"	1-1/2"	4"	6-1/4"
E	20251-2000	2-1/2" - 3-3/8"	3-1/32"	3-9/16"	2-1/2"	2"	4"	6-1/2"
F	20261-2500	3" - 3-7/8"	3-13/32"	4"	2-3/4"	2-3/4"	4"	6-3/4"

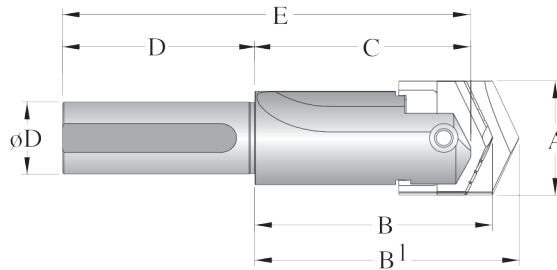

Short Straight Shank Holder #150 (No Coolant)

Series	Item Number	A	B	B1	C	D		Overall Length
		Blade Diameter Cutting Range	HP Reference Length	Universal Reference Length	Flute Length	Shank		
						Diameter	Length	
A	20411-0750	31/32" - 1-3/8"	3-1/4"	3-17/32"	3"	3/4"	3-1/2"	6-1/2"
	20411-1000	31/32" - 1-3/8"	3-1/4"	3-17/32"	3"	1"	3-1/2"	6-1/2"
B	20421-1000	1-1/4" - 1-3/4"	3-25/32"	4-3/32"	3-1/2"	1"	3-1/2"	7"
C	20431-1250	1-1/2" - 2-3/8"	4-19/64"	5"	4"	1-1/4"	4"	8"
D	20441-1500	2" - 2-7/8"	4-63/64"	5-1/2"	4-1/2"	1-1/2"	4"	8-1/2"
E	20451-1750	2-1/2" - 3-3/8"	5-17/32"	6-1/16"	5"	1-3/4"	4"	9"
F	20461-2000	3" - 3-7/8"	6-5/32"	6-3/4"	5-1/2"	2"	4"	9-1/2"

NOTE: Adapter required for D through H series High Performance Spade Drills - see page 10. Adapter sold separately





High Performance / Universal Holders

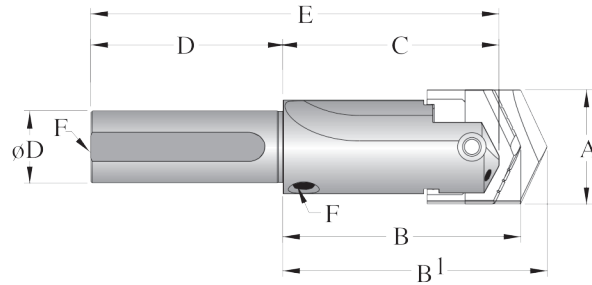

Short Straight Shank Holder #100 (Coolant)

Series	Item Number	A	B	B1	C	D		E	F
		Blade Diameter Cutting Range	HP Reference Length	Universal Reference Length	Flute Length	Shank		Overall Length	Pipe Tap
						Diameter	Length		
A	20611-1000	31/32" - 1-3/8"	3-1/4"	3-17/32"	3"	1"	3-1/2"	6-1/2"	1/8"
	20611-1500	31/32" - 1-3/8"	3-1/4"	3-17/32"	3"	1-1/2"	3-1/2"	6-1/2"	1/8"
B	20621-1000	1-1/4" - 1-3/4"	3-25/32"	4-3/32"	3-1/2"	1"	3-1/2"	7"	1/4"
	20621-1250	1-1/4" - 1-3/4"	3-25/32"	4-3/32"	3-1/2"	1-1/4"	3-1/2"	7"	1/4"
	20621-1500	1-1/4" - 1-3/4"	3-25/32"	4-3/32"	3-1/2"	1-1/2"	3-1/2"	7"	1/4"
C	20631-1250	1-1/2" - 2-3/8"	4-19/64"	5"	4"	1-1/4"	4"	8"	1/4"
	20631-1500	1-1/2" - 2-3/8"	4-19/64"	5"	4"	1-1/2"	4"	8"	1/4"
D	20641-1500	2" - 2-7/8"	4-63/64"	5-1/2"	4-1/2"	1-1/2"	4"	8-1/2"	1/4"
E	20651-1750	2-1/2" - 3-3/8"	5-17/32"	6-1/16"	5"	1-3/4"	4"	9"	1/2"
F	20661-2000	3" - 3-7/8"	6-5/32"	6-3/4"	5-1/2"	2"	4"	9-1/2"	1/2"
	20661-2500	3" - 3-7/8"	6-5/32"	6-3/4"	5-1/2"	2-1/2"	4"	9-1/2"	1/2"
G	20671-2500	3-1/2" - 4-1/2"	6-25/32"	7-7/16"	6"	2-1/2"	5"	11"	1/2"
	•20671-3000	3-1/2" - 4-1/2"	6-25/32"	7-7/16"	6"	3"	5"	11"	1/2"
H	20681-2500	4" - 8-1/2"	7-31/32"	7-31/32"	7"	2-1/2"	6"	13"	1/2"



High Performance / Universal Holders

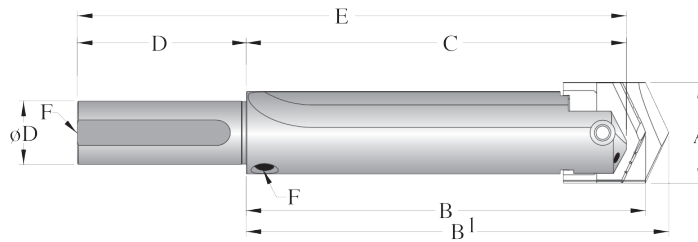

Standard Straight Shank Holder #200 (Coolant)

Series	Item Number	A	B	B1	C	D		E	F
		Blade Diameter Cutting Range	HP Reference Length	Universal Reference Length	Flute Length	Shank Diameter Length		Overall Length	Pipe Tap
A	20811-0750	31/32" - 1-3/8"	8"	8-9/32"	7-3/4"	3/4"	3-1/2"	11-1/4"	1/8"
	20811-1000	31/32" - 1-3/8"	8"	8-9/32"	7-3/4"	1"	3-1/2"	11-1/4"	1/8"
	20811-1500	31/32" - 1-3/8"	8"	8-9/32"	7-3/4"	1-1/2"	3-1/2"	11-1/4"	1/8"
B	20821-1000	1-1/4" - 1-3/4"	8-13/32"	8-23/32"	8-1/8"	1"	3-1/2"	11-5/8"	1/4"
	20821-1250	1-1/4" - 1-3/4"	8-13/32"	8-23/32"	8-1/8"	1-1/4"	3-1/2"	11-5/8"	1/4"
	20821-1500	1-1/4" - 1-3/4"	8-13/32"	8-23/32"	8-1/8"	1-1/2"	3-1/2"	11-5/8"	1/4"
C	20831-1250	1-1/2" - 2-3/8"	8-51/64"	9-1/2"	8-1/2"	1-1/4"	4"	12-1/2"	1/4"
	20831-1500	1-1/2" - 2-3/8"	8-51/64"	9-1/2"	8-1/2"	1-1/2"	4"	12-1/2"	1/4"
D	20841-1500	2" - 2-7/8"	9-31/64"	10"	9"	1-1/2"	4"	13"	1/4"
E	20851-2000	2-1/2" - 3-3/8"	10-17/32"	11-1/16"	10"	2"	4"	14"	1/2"
F	20861-2000	3" - 3-7/8"	12-5/32"	12-3/4"	11-1/2"	2"	4"	15-1/2"	1/2"
G	20871-2500	3-1/2" - 4-1/2"	13-25/32"	14-7/16"	13"	2-1/2"	5"	18"	1/2"
H	20881-2500	4" - 8-1/2"	15-31/32"	16-9/16"	15"	2-1/2"	6"	21"	1/2"



Long Straight Shank Holder #250 (Coolant)

Series	Item Number	A	B	B1	C	D		E	F
		Blade Diameter Cutting Range	HP Reference Length	Universal Reference Length	Flute Length	Shank Diameter Length		Overall Length	Pipe Tap
A	⚠ 21011-1000	31/32" - 1-3/8"	15-1/4"	15-17/32"	15"	1"	3-1/2"	18-1/2"	1/8"
B	⚠ 21021-1250	1-1/4" - 1-3/4"	15-9/32"	15-19/32"	15"	1-1/4"	3-1/2"	18-1/2"	1/4"
C	⚠ 21031-1500	1-1/2" - 2-3/8"	18-19/64"	19"	18"	1-1/2"	4"	22"	1/4"
D	⚠ 21041-1500	2" - 2-7/8"	18-31/64"	19"	18"	1-1/2"	4"	22"	1/4"
E	⚠ 21051-2000	2-1/2" - 3-3/8"	20-17/32"	21-1/16"	20"	2"	4"	24"	1/2"
F	⚠ 21061-2500	3" - 3-7/8"	20-21/32"	21-1/4"	20"	2-1/2"	4"	24"	1/2"

NOTE: Adapter required for D through H series High Performance Spade Drills - see page 10. Adapter sold separately

⚠ WARNING Refer to Speed and Feed charts for recommended adjustments to speeds and feeds. Refer to page 29 for Deep Hole Drilling Guidelines in Technical Reference section of catalog. Visit www.alliedmachine.com/deepholeguidelines.aspx for the most up-to-date information and procedures. Factory technical assistance is available for your specific applications through our Application Engineering Team.





High Performance / Universal Holders

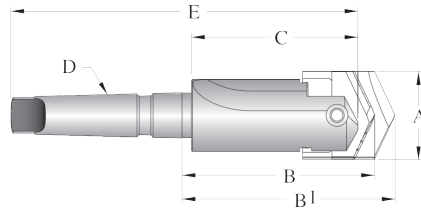

Short Taper Shank Holder #300 (No Coolant)

Series	Item Number	A	B	B1	C	D		E
		Blade Diameter Cutting Range	HP Reference Length	Universal Reference Length	Flute Length	Shank MT	Shank Length	
A	21411-0003	31/32" - 1-3/8"	3-7/16"	3-7/16"	3"	#3	3-7/8"	6-7/8"
	21411-0004	31/32" - 1-3/8"	3-1/2"	3-1/2"	3"	#4	4-7/8"	7-7/8"
B	21421-0003	1-1/4" - 1-3/4"	3-31/32"	3-31/32"	3-1/2"	#3	3-7/8"	7-3/8"
	21421-0004	1-1/4" - 1-3/4"	4-1/32"	4-1/32"	3-1/2"	#4	4-7/8"	8-3/8"
C	21431-0004	1-1/2" - 2-3/8"	4-35/64"	4-35/64"	4"	#4	4-7/8"	8-7/8"
D	21441-0004	2" - 2-7/8"	5-15/64"	5-15/64"	4-1/2"	#4	4-7/8"	9-3/8"
	21441-0005	2" - 2-7/8"	5-15/64"	5-15/64"	4-1/2"	#5	6-1/8"	10-5/8"
E	21451-0004	2-1/2" - 3-3/8"	5-25/32"	5-25/32"	5"	#4	4-7/8"	9-7/8"
	21451-0005	2-1/2" - 3-3/8"	5-25/32"	5-25/32"	5"	#5	6-1/8"	11-1/8"
F	21461-0005	3" - 3-7/8"	6-13/32"	6-13/32"	5-1/2"	#5	6-1/8"	11-5/8"
G	21471-0005	3-1/2" - 4-1/2"	7-1/32"	7-1/32"	6"	#5	6-1/8"	12-1/8"
H	21481-0005	4" - 8-1/2"	8-7/32"	8-7/32"	7"	#5	6-1/8"	13-1/8"

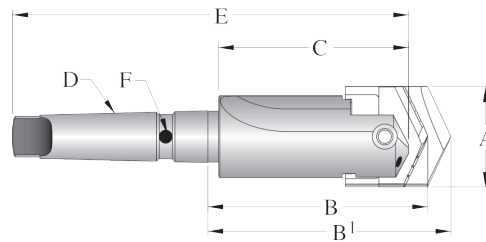

Short Taper Shank Holder #300TSC (Thru Shank Coolant)

Series	Item Number	A	B	B1	C	D		E	F
		Blade Diameter Cutting Range	HP Reference Length	Universal Reference Length	Flute Length	Shank MT	Shank Length	Overall Length	Coolant Inlet Dia.
A	21511-0003	31/32" - 1-3/8"	3-7/16"	3-23/32"	3"	#3	3-7/8"	6-7/8"	1/4"
B	21521-0004	1-1/4" - 1-3/4"	4-1/32"	4-11/32"	3-1/2"	#4	4-7/8"	8-3/8"	5/16"
C	21531-0004	1-1/2" - 2-3/8"	4-35/64"	5-1/4"	4"	#4	4-7/8"	8-7/8"	5/16"
	21531-0005	1-1/2" - 2-3/8"	4-35/64"	5-1/4"	4"	#5	6-1/8"	10-1/8"	3/8"
D	21541-0004	2" - 2-7/8"	5-15/64"	5-3/4"	4-1/2"	#4	4-7/8"	9-3/8"	5/16"
E	21551-0005	2-1/2" - 3-3/8"	3-25/32"	6-5/16"	5"	#5	6-1/8"	11-1/8"	3/8"
F	21561-0005	3" - 3-7/8"	6-13/32"	7"	5-1/2"	#5	6-1/8"	11-5/8"	3/8"
G	21571-0005	3-1/2" - 4-1/2"	7-1/32"	7-11/16"	6"	#5	6-1/8"	12-1/8"	3/8"

NOTE: Adapter required for D through H series High Performance Spade Drills - see page 10. Adapter sold separately



High Performance / Universal Holders

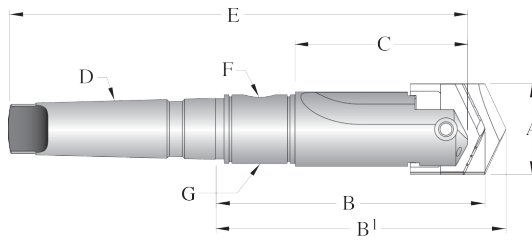

Short Taper Shank Holder #400SR (Coolant)

Series	Item Number	A	B	B1	C	D		E	F	G
		Blade Diameter Cutting Range	HP Reference Length	Universal Reference Length	Flute Length	Shank				
						MT	Length			
A	21611-0004	31/32" - 1/3/8"	5-3/16"	5-15/32"	3"	#4	4-7/8"	9-9/16"	1/4"	2T-4SR
B	21621-0004	1-1/4" - 1-3/4"	5-23/32"	6-1/32"	3-1/2"	#4	4-7/8"	10-1/16"	1/4"	2T-4SR
C	21631-0004	1-1/2" - 2-3/8"	6-15/64"	6-15/16"	4"	#4	4-7/8"	10-9/16"	1/4"	2T-4SR
D	21641-0004	2" - 2-7/8"	6-59/64"	7-7/16"	4-1/2"	#4	4-7/8"	11-1/16"	1/4"	2T-4SR
E	21651-0005	2-1/2" - 3-3/8"	8-3/32"	8-5/8"	5"	#5	6-1/8"	13-7/16"	1/2"	2T-6SR
F	21661-0005	3" - 3-7/8"	8-23/32"	9-5/16"	5-1/2"	#5	6-1/8"	13-15/16"	1/2"	2T-6SR
G	21671-0005	3-1/2" - 4-1/2"	9-11/32"	10"	6"	#5	6-1/8"	14-7/16"	1/2"	2T-6SR
H	21681-0005	4" - 8-1/2"	10-17/32"	11-1/8"	7"	#5	6-1/8"	15-7/16"	1/2"	2T-6SR

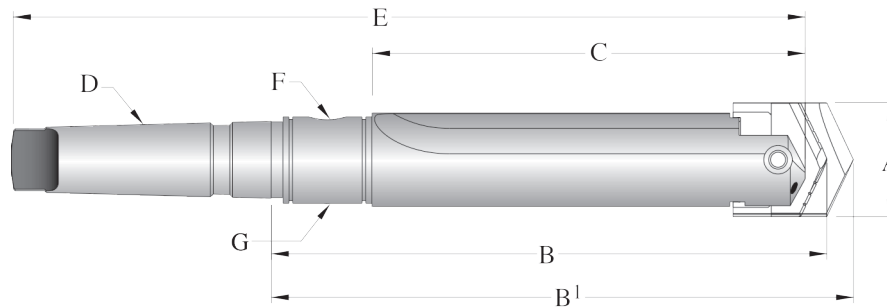

Standard Taper Shank Holder #500SR (Coolant)

Series	Item Number	A	B	B1	C	D		E	F	G
		Blade Diameter Cutting Range	HP Reference Length	Universal Reference Length	Flute Length	Shank				
						MT	Length			
A	21811-0004	31/32" - 1-3/8"	9-15/16"	10-7/32"	7-3/4"	#4	4-7/8"	14-5/16"	1/4"	2T-4SR
B	21821-0004	1-1/4" - 1-3/4"	10-11/32"	10-21/32"	8-1/8"	#4	4-7/8"	14-11/16"	1/4"	2T-4SR
C	21831-0004	1-1/2" - 2-3/8"	10-47/64"	11-7/16"	8-1/2"	#4	4-7/8"	15-1/16"	1/4"	2T-4SR
	21831-0005	1-1/2" - 2-3/8"	10-47/64"	11-7/16"	8-1/2"	#5	6-1/8"	16-5/16"	1/4"	2T-5SR
D	21841-0004	2" - 2-7/8"	11-27/64"	11-15/16"	9"	#4	4-7/8"	15-9/16"	1/4"	2T-4SR
	21841-0005	2" - 2-7/8"	11-27/64"	11-15/16"	9"	#5	6-1/8"	16-13/16"	1/4"	2T-5SR
E	21851-0005	2-1/2" - 3-3/8"	13-3/32"	13-5/8"	10"	#5	6-1/8"	18-7/16"	1/2"	2T-6SR
F	21861-0005	3" - 3-7/8"	14-23/32"	15-5/16"	11-1/2"	#5	6-1/8"	19-15/16"	1/2"	2T-6SR
G	21871-0005	3-1/2" - 4-1/2"	16-11/32"	17"	13"	#5	6-1/8"	21-7/16"	1/2"	2T-6SR
H	21881-0005	4" - 8-1/2"	18-17/32"	19-1/8"	15"	#5	6-1/8"	23-7/16"	1/2"	2T-6SR
	21881-0006	4" - 8-1/2"	18-19/32"	19-3/16"	15"	#6	8-9/16"	25-7/8"	1/2"	2T-55SR

NOTE: Adapter required for D through H series High Performance Spade Drills - see page 10. Adapter sold separately





High Performance / Universal Holders

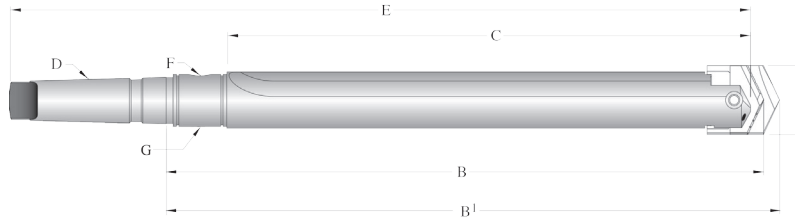

Long Taper Shank Holder #600 SR (Coolant)

Series	Item Number	A	B	B1	C	D		E	F	G
		Blade Diameter Cutting Range	HP Reference Length	Universal Reference Length	Flute Length	Shank		Overall Length	Pipe Tap	RCA
						MT	Length			
A	⚠ 22011-0004	31/32" - 1-3/8"	17-3/16"	17-15/32"	15"	#4	4-7/8"	21-9/16"	1/4"	2T-4SR
B	⚠ 22021-0004	1-1/4" - 1-3/4"	17-7/32"	17-17/32"	15"	#4	4-7/8"	21-9/16"	1/4"	2T-4SR
C	⚠ 22031-0004	1-1/2" - 2-3/8"	20-15/64"	20-5/16"	18"	#4	4-7/8"	24-9/16"	1/4"	2T-4SR
	⚠ 22031-0005	1-1/2" - 2-3/8"	20-15/64"	20-5/16"	18"	#5	6-1/8"	25-13/16"	1/4"	2T-5SR
D	⚠ 22041-0004	2" - 2-7/8"	20-27/64"	20-15/16"	18"	#4	4-7/8"	24-9/16"	1/4"	2T-4SR
	⚠ 22041-0005	2" - 2-7/8"	20-27/64"	20-15/16"	18"	#5	6-1/8"	25-13/16"	1/4"	2T-5SR
E	⚠ 22051-0005	2-1/2" - 3-3/8"	23-3/32"	23-5/8"	20"	#5	6-1/8"	28-7/16"	1/2"	2T-6SR
F	⚠ 22061-0005	3" - 3-7/8"	23-7/32"	23-13/16"	20"	#5	6-1/8"	28-7/16"	1/2"	2T-6SR
G	⚠ 22071-0005	3-1/2" - 4-1/2"	27-11/32"	28"	24"	#5	6-1/8"	32-7/16"	1/2"	2T-6SR
H	⚠ 22081-0006	4" - 8-1/2"	27-19/32"	28-3/16"	24"	#6	8-9/16"	34-7/8"	1/2"	2T-55SR

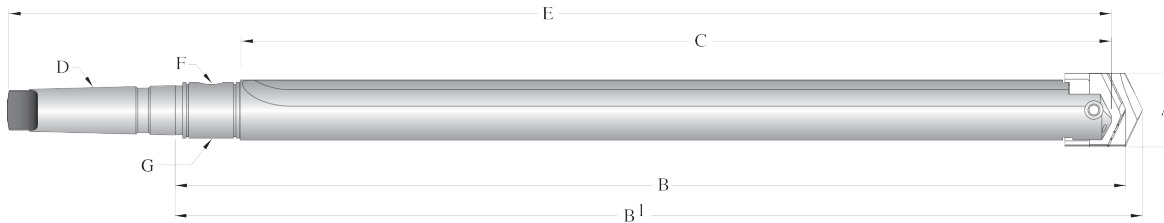

Extra Long Taper Shank Holder #700 SR (Coolant)

Series	Item Number	A	B	B1	C	D		E	F	G
		Blade Diameter Cutting Range	HP Reference Length	Universal Reference Length	Flute Length	Shank		Overall Length	Pipe Tap	RCA
						MT	Length			
A	⚠ 22211-0004	31/32" - 1-3/8"	23-3/16"	23-15/32"	21"	#4	4-7/8"	27-9/16"	1/4"	2T-4SR
B	⚠ 22221-0004	1-1/4" - 1-3/4"	24-7/32"	24-17/32"	22"	#4	4-7/8"	28-9/16"	1/4"	2T-4SR
C	⚠ 22231-0004	1-1/2" - 2-3/8"	28-15/64"	28-15/16"	26"	#4	4-7/8"	32-9/16"	1/4"	2T-4SR
	⚠ 22231-0005	1-1/2" - 2-3/8"	28-15/64"	28-15/16"	26"	#5	6-1/8"	33-13/16"	1/4"	2T-5SR
D	⚠ 22241-0004	2" - 2-7/8"	30-27/64"	30-15/16"	28"	#4	4-7/8"	34-9/16"	1/4"	2T-4SR
	⚠ 22241-0005	2" - 2-7/8"	30-27/64"	30-15/16"	28"	#5	6-1/8"	35-13/16"	1/4"	2T-5SR
E	⚠ 22251-0005	2-1/2" - 3-3/8"	33-3/32"	33-5/8"	30"	#5	6-1/8"	38-7/16"	1/2"	2T-6SR
F	⚠ 22261-0005	3" - 3-7/8"	36-7/32"	36-13/16"	33"	#5	6-1/8"	41-7/16"	1/2"	2T-6SR
G	⚠ 22271-0005	3-1/2" - 4-1/2"	40-11/32"	41"	37"	#5	6-1/8"	45-7/16"	1/2"	2T-6SR
H	⚠ 22281-0006	4" - 8-1/2"	43-19/32"	44-3/16"	40"	#6	8-9/16"	50-7/8"	1/2"	2T-55SR

NOTE: Adapter required for D through H series High Performance Spade Drills - see page 10. Adapter sold separately

⚠ WARNING Refer to Speed and Feed charts for recommended adjustments to speeds and feeds. Refer to page 29 for Deep Hole Drilling Guidelines in Technical Reference section of catalog. Visit www.alliedmachine.com/deepholeguidelines.aspx for the most up-to-date information and procedures. Factory technical assistance is available for your specific applications through our Application Engineering Team.



High Performance / Universal Holders

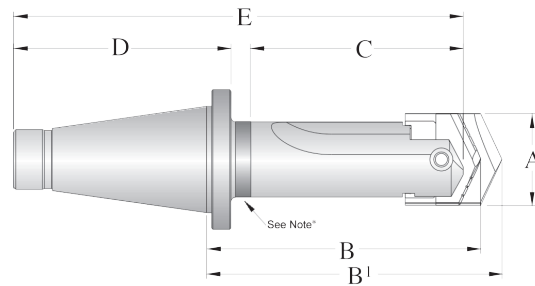

Short 50 NMTB Shank Holder #300 (No Coolant)

Series	Item Number	A	B	B1	C	D		E
		Blade Diameter Cutting Range	HP Reference Length	Universal Reference Length		Shank		
						NMTB	Length	
B	♦22421-0050	1-1/4" - 1-3/4"	5-13/32"	5-23/32"	4"	50	5-5/8"	10-1/8"
C	♦22431-0050	1-1/2" - 2-3/8"	5-27/64"	6-1/8"	4"	50	5-5/8"	10-1/8"
F	♦22461-0050	3" - 3-7/8"	7-9/32"	7-7/8"	5-1/2"	50	5-5/8"	11-5/8"
G	♦22471-0050	3-1/2" - 4-1/2"	8-29/32"	9-9/16"	7"	50	5-5/8"	13-1/8"

*NOTE: Clearance is provided for a quick change locknut so this product can be modified for those applications.

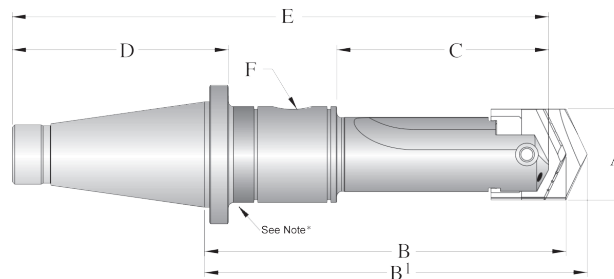

Short 50 NMTB Shank Holder #400 (Coolant)

Series	Item Number	A	B	B1	C	D		E	F	
		Blade Diameter Cutting Range	HP Reference Length	Universal Reference Length		Shank		Overall Length	RCA	Inlet Hole
						NMTB	Length			
B	♦22621-0050	1-1/4" - 1-3/4"	7-3/32"	7-13/32"	4"	50	5-5/8"	11-13/16"	2T-5SR	3/8"
C	♦22631-0050	1-1/2" - 2-3/8"	7-7/64"	7-13/16"	4"	50	5-5/8"	11-13/16"	2T-5SR	3/8"
D	♦22641-0050	2" - 2-7/8"	9-27/64"	9-15/16"	5-1/2"	50	5-5/8"	13-15/16"	2T-55SR	3/8"
E	♦22651-0050	2-1/2" - 3-3/8"	9-15/32"	10"	5-1/2"	50	5-5/8"	13-15/16"	2T-55SR	5/8"
F	♦22661-0050	3" - 3-7/8"	9-19/32"	10-3/16"	5-1/2"	50	5-5/8"	13-15/16"	2T-60SR	5/8"
G	♦22671-0050	3-1/2" - 4-1/2"	11-7/32"	11-7/8"	7"	50	5-5/8"	15-7/16"	2T-65SR	5/8"

NOTE: Adapter required for D through H series High Performance Spade Drills - see page 10.

Adapter sold separately

*NOTE: Clearance is provided for a quick change locknut so this product can be modified for those applications.

♦All NMTB Shank Holders are discontinued items: Items listed are available, subject to prior sale, at list prices until stock is depleted. Once stock is depleted, items are available as quoted specials only.



High Performance / Universal Holders

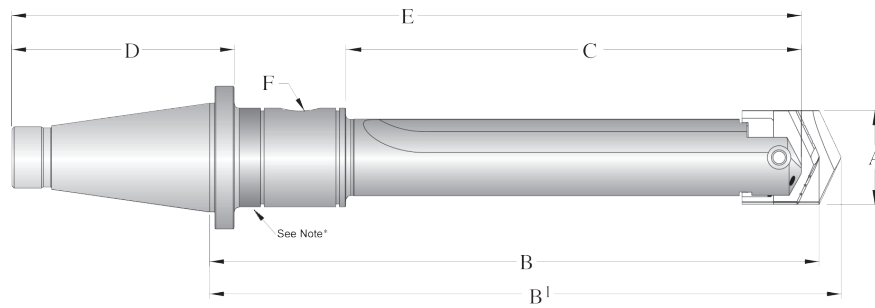

Short 50 NMTB Shank Holder #500 (Coolant)

Series	Item Number	A	B	B1	C	D		E	F	Inlet Hole
		Blade Diameter Cutting Range	HP Reference Length	Universal Reference Length	Flute Length	Shank		Overall Length	RCA	
						NMTB	Length			
B	♦22821-0050	1-1/4" - 1-3/4"	11-19/32"	11-29/32"	8-1/2"	50	5-5/8"	16-5/16"	2T-5SR	3/8"
C	♦22831-0050	1-1/2" - 2-3/8"	11-39/64"	12-5/16"	8-1/2"	50	5-5/8"	16-5/16"	2T-5SR	3/8"
D	♦22841-0050	2" - 2-7/8"	15-27/64"	15-15/16"	11-1/2"	50	5-5/8"	19-15/16"	2T-55SR	3/8"
E	♦22851-0050	2-1/2" - 3-3/8"	15-15/32"	16"	11-1/2"	50	5-5/8"	19-15/16"	2T-55SR	5/8"
F	♦22861-0050	3" - 3-7/8"	15-19/32"	16-3/16"	11-1/2"	50	5-5/8"	19-15/16"	2T-60SR	5/8"
G	♦22881-0050	4" - 8-1/2"	19-13/32"	20"	15"	50	5-5/8"	23-7/16"	2T-65SR	5/8"

♦All NMTB Shank Holders are discontinued items: Items listed are available, subject to prior sale, at list prices until stock is depleted. Once stock is depleted, items are available as quoted specials only.

*NOTE: Clearance is provided for a quick change locknut so this product can be modified for those applications.



High Performance / Universal Holders

Accessories and Features

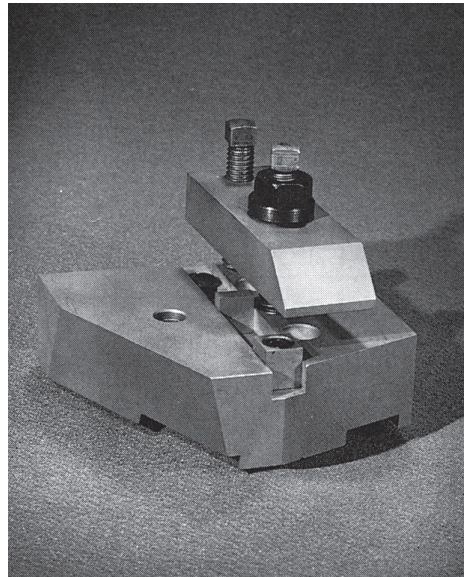

Top Mounting Plate Item Number: 25000-2505

Top Mounting Plate only. It is available for those that already have a Universal Grinding Fixture or may wish to adapt it to some other device. The plate comes complete with all the hardware required to locate and clamp any series Universal Style Spade Drill to the Plate.

Cylindrical Grinding Fixture

Series	Item Number	Diameter Range
A	24410-2560	15/16" - 1-3/8"
B	24420-2565	1-1/4" - 1-3/4"
C	24430-2570	1-1/2" - 2-3/8"
D	24440-2575	2" - 2-7/8"
E	24450-2580	2-1/2" - 3-3/8"
F	24460-2585	3" - 3-7/8"
G	24470-2590	3-1/2" - 4-1/2"
*H	24480-2595	4" - 8-1/2"

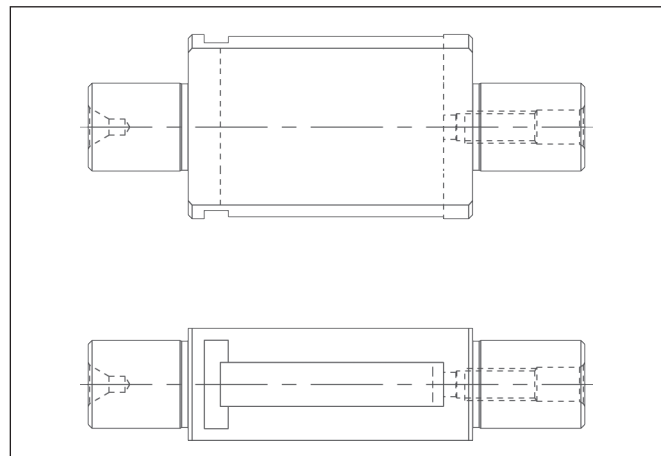

Items included with Cylindrical Grinding Fixture: (1) Set Screw, (1) Slip Pin.

*Applies to drills with a reference length of 3-11/16". Cylindrical Grinding Fixtures for drills with a 4-11/16" reference length will be quoted upon request.



High Performance / Universal Holders

Speeds & Feeds

IMPORTANT: The speeds and feeds listed below are a general starting point for all applications. Refer to the Coolant Recommendation charts for coolant requirements to run at the recommended speeds and feeds. Factory technical assistance is also available through our Application Engineering Team. See adjustment examples at bottom of Speed & Feed charts.

Material	Material Hardness (BHN)	High Performance Spade Drills							Uncoated Universal Style Spade Drills				
		TiN SFM	** TiAlN SFM	TiCN SFM	FEED (IPR)				SFM	FEED (IPR)			
					1" to 1-1/4"	1-1/4" to 2"	2" to 3"	3" to 5"		1" to 1-1/4"	1-1/4" to 2"	2" to 3"	3" to 5"
Free Machining Steel 1118, 1215, 1214, etc.	100 - 150	200	280	260	.016	.020	.023	.028	100	.014	.016	.020	.024
	150 - 200	180	260	235	.016	.020	.023	.028	90	.013	.015	.019	.022
	200 - 250	160	240	210	.016	.020	.023	.028	80	.012	.014	.018	.020
Low Carbon Steel 1010, 1020, 1025, 1522, 1144, etc.	85 - 125	170	250	220	.015	.019	.023	.027	80	.012	.015	.018	.020
	125 - 175	160	240	210	.015	.019	.023	.027	75	.012	.014	.017	.020
	175 - 225	150	225	195	.014	.018	.021	.024	60	.010	.014	.016	.018
	225 - 275	140	210	180	.014	.018	.021	.024	55	.010	.013	.016	.018
Medium Carbon Steel 1030, 1040, 1050, 1527, 1140, etc.	125 - 175	160	240	210	.015	.019	.023	.027	65	.010	.014	.018	.020
	175 - 225	150	225	195	.014	.018	.021	.024	60	.010	.014	.016	.020
	225 - 275	140	210	180	.014	.018	.021	.024	50	.008	.013	.016	.018
	275 - 325	130	195	170	.012	.016	.019	.022	*45	.008	.012	.014	.016
Alloy Steel 4140, 5140, 8640, etc.	125 - 175	150	210	195	.014	.017	.019	.022	60	.010	.014	.018	.020
	175 - 225	140	195	180	.014	.017	.019	.022	55	.010	.014	.016	.020
	225 - 275	130	180	170	.014	.017	.019	.022	45	.008	.013	.016	.018
	275 - 325	120	170	155	.012	.015	.017	.020	*35	.008	.012	.014	.016
	235 - 375	110	155	145	.012	.015	.017	.020	*30	.008	.012	.014	.016
High Strength Alloy 4340, 4330V, 300M, etc.	225 - 300	80	110	100	.010	.014	.017	.020	*40	.008	.012	.014	.016
	300 - 350	60	85	80	.010	.014	.017	.020	*30	.006	.010	.014	.016
	350 - 400	50	70	65	.009	.012	.015	.018	*25	.006	.008	.014	.016
Structural Steel A36, A285, A516, etc.	100 - 150	140	200	180	.014	.018	.021	.026	70	.012	.016	.018	.020
	150 - 250	120	170	155	.012	.016	.019	.024	60	.010	.014	.016	.018
	250 - 350	100	140	130	.010	.014	.017	.020	50	.008	.012	.014	.016
High Temp Alloy Hastelloy B, Inconel 600, etc.	140 - 220	30	40	35	.010	.012	.015	-	*20	.008	.010	.012	-
	220 - 310	25	35	30	.008	.010	.012	-	*15	.007	.009	.011	-
Stainless Steel 303, 416, 420, 17-4 PH, etc.	135 - 185	75	105	95	.011	.014	.016	.020	45	.008	.012	.015	.018
	185 - 275	60	90	80	.010	.012	.014	.018	35	.007	.010	.013	.016
Tool Steel H-13, H-21, A-4, O-2, S-3, etc.	150 - 200	80	110	105	.010	.012	.015	.017	50	.009	.011	.014	.016
	200 - 250	60	90	85	.010	.012	.015	.017	40	.008	.010	.013	.015
Aluminum	30	600	850	750	.020	.022	.025	.025	275	.018	.026	.032	.042
	180	300	450	400	.018	.022	.025	.025	200	.018	.026	.032	.042
Cast Iron	120 - 150	170	250	220	.020	.024	.027	.030	100	.016	.020	.022	.025
	150 - 200	150	225	195	.018	.022	.025	.028	80	.015	.018	.020	.022
	200 - 220	130	195	170	.016	.018	.021	.024	70	.011	.014	.018	.020
	220 - 260	110	165	145	.012	.014	.017	.020	*60	.008	.012	.015	.017
	260 - 320	90	135	120	.009	.012	.014	.016	*45	.008	.010	.012	.014

Formulas: $IPM = (RPM) (IPR)$

$SFM = RPM \cdot 0.262 \cdot DIA$

$RPM = SFM \cdot 3.82 / DIA$

WARNING

Tool failure can cause serious injury. To prevent:

- When using holders without support bushing, use a short length holder to establish an initial hole that is a minimum of 2 diameters deep.
- Do not rotate tool holders more than 50 RPM unless it is engaged with workpiece or fixture

Refer to page 29 for Deep hole Drilling Guidelines in Technical Reference section of catalog. Visit www.alliedmachine.com/deepholeguidelines.aspx for the most up-to-date information and procedures. Factory technical assistance is also available for your specific applications.

Deep Hole Drilling Speed & Feed Adjustment

Holder	Long	Extra Long
SPEED	⚠ 0.90	⚠ 0.80
FEED	-	⚠ 0.90

RECOMMENDED SPEED AND FEED EXAMPLE: If recommended speed and feed is 200 SFM and 0.016 IPR for a Standard length holder, then the speed and feed using a Extra Long holder in the same application would be 160 SFM and 0.014 IPR.

$200 \cdot .80 = 160 SFM$

$.016 \cdot 0.90 = .014 IPR$



High Performance / Universal Holders

Coolant Recommendations



IMPORTANT: The coolant pressure and flow rate recommendation below represents a good approximation to obtain optimum tool life and chip evacuation at Allied recommended speeds and feeds. If lower coolant capabilities exist in a drilling application, the HP / Universal drilling system will still function at reduced penetration rates. Contact our Application Engineering Department for a more specific recommendation of coolant requirements and/or speeds and feeds.

Material	Material Hardness (BHN)	Coolant Pressure (psi)							
		Coolant Volumetric Flowrate (GPM)							
		High Performance				Universal Uncoated			
		1" to 1-1/4"	1-1/4" to 2"	2" to 3"	3" to 5"	1" to 1-1/4"	1-1/4" to 2"	2" to 3"	3" to 5"
Free Machining Steel 1118, 1215, 1214, etc.	100 - 250	105 - 150 6.3 - 7.6	55 - 75 15 - 18	45 - 60 31 - 36	35 - 45 47 - 53	40 3.9	25 10	25 23	20 35
Low Carbon Steel 1010, 1020, 1025, 1522, 1144, etc.	85 - 275	80 - 115 5.5 - 6.6	45 - 55 14 - 15	35 - 45 28 - 31	30 - 35 43 - 46	30 3.4	20 9	20 21	20 35
Medium Carbon Steel 1030, 1040, 1050, 1527, 1140, etc.	125 - 325	70 - 100 5.2 - 6.2	40 - 50 13 - 15	35 - 40 28 - 30	30 - 35 43 - 46	25 3.1	20 9	20 21	20 35
Alloy Steel 4140, 5140, 8640, etc.	125 - 375	60 - 85 4.8 - 5.7	30 - 40 11 - 13	30 - 35 26 - 28	25 - 30 39 - 43	20 2.8	20 9	20 21	20 35
High Strength Alloy 4340, 4330V, 300M, etc.	225 - 400	25 - 30 3.1 - 3.4	20 - 25 9 - 10	20 - 25 21 - 23	20 - 25 35 - 39	25 3.1	20 9	20 21	20 35
Structural Steel A36, A285, A516, etc.	100 - 350	50 - 70 4.4 - 5.2	30 - 35 11 - 12	25 - 30 23 - 26	25 - 30 39 - 43	25 3.1	20 9	20 21	20 35
High Temp Alloy Hastealloy B, Inconel 600, etc.	140 - 310	35 - 40 3.6 - 3.9	25 - 30 10 - 11	25 - 30 23 - 26	-	25 3.1	20 9	20 21	20 35
Stainless Steel 303, 416, 420, 17-4 PH, etc.	135 - 275	50 - 65 4.4 - 5.0	30 - 35 11 - 12	25 - 30 23 - 26	25 - 30 39 - 43	25 3.1	25 10	20 21	20 35
Tool Steel H-13, H-21, A-4, O-2, S-3, etc.	150 - 250	25 - 30 3.1 - 3.4	20 - 25 9 - 10	20 - 25 21 - 23	20 - 25 35 - 43	25 3.1	20 9	20 21	20 35
Aluminum	30 - 180	150 - 220 7.6 - 9.1	80 - 115 19 - 22	60 - 80 36 - 42	55 - 70 59 - 66	55 4.6	35 12	30 26	30 40
Cast Iron	120 - 320	40 - 50 3.9 - 4.4	25 - 30 10 - 11	25 - 30 23 - 26	20 - 25 35 - 43	25 3.1	20 9	20 21	20 35

Deep Hole Drilling Coolant Adjustment

Holder	Long	Extra Long
Pressure & Flow	1.3	2

COOLANT RECOMMENDATION EXAMPLE: If the recommended pressure and flow is 150 PSI and 6.3 GPM for a standard length holder, the adjusted pressure and flow would be 300 PSI and 12.6 GPM respectively for the Extra Long holder.

$$150 \bullet 2 = 300 \text{ PSI}$$

$$6.3 \bullet 2 = 12.6 \text{ GPM}$$





RCA Assembly

Rotary Coolant Adapters and Accessories

* Item Number	A I.D.	B O.D.	C Length	D Thread for Driving Rod	E Pipe Thread	** Repair Kits	*** RCA O-Ring Replacement	Max Recommended RPM
⚠ 2T-3SR	1"	2-1/8"	1-1/8"	5/16" - NC	1/8"	2T1-3SR	2T1-3OR-10	2500
⚠ 2T-4SR	1-1/4"	2-1/2"	1-3/8"	3/8" - NC	1/4"	2T1-4SR	2T1-4OR-10	2000
⚠ 2T-5SR	1-3/4"	3"	1-3/8"	3/8" - NC	1/4"	2T1-5SR	2T1-5OR-10	1500
⚠ 2T-6SR	2-1/4"	3-3/4"	1-3/4"	1/2" - NC	1/2"	2T1-6SR	2T1-6OR-10	1100
⚠ 2T-55SR	2-1/2"	4"	1-3/4"	1/2" - NC	1/2"	2T1-55SR	2T1-55OR-10	1100
⚠ 2T-60SR	3"	4-1/2"	1-3/4"	1/2" - NC	1/2"	2T1-60SR	2T1-60OR-10	900
⚠ 2T-65SR	3-3/4"	5-1/2"	1-3/4"	1/2" - NC	1/2"	2T1-65SR	2T1-65OR-10	700

* Rotary Coolant Adapter comes complete with: (1) RCA, (2) O-Rings, (2) Snap Rings, and (2) Thrust Washers

** Repair Kit includes: (2) O-Rings, (2) Snap Rings, and (2) Thrust Washers

*** Rotary Coolant Adapter O-Ring Replacement: 10 pieces per package

NOTE: Max recommended pressure is 600 PSI (42 bar)

NOTE: Recommendations above are based on water and oil based coolants

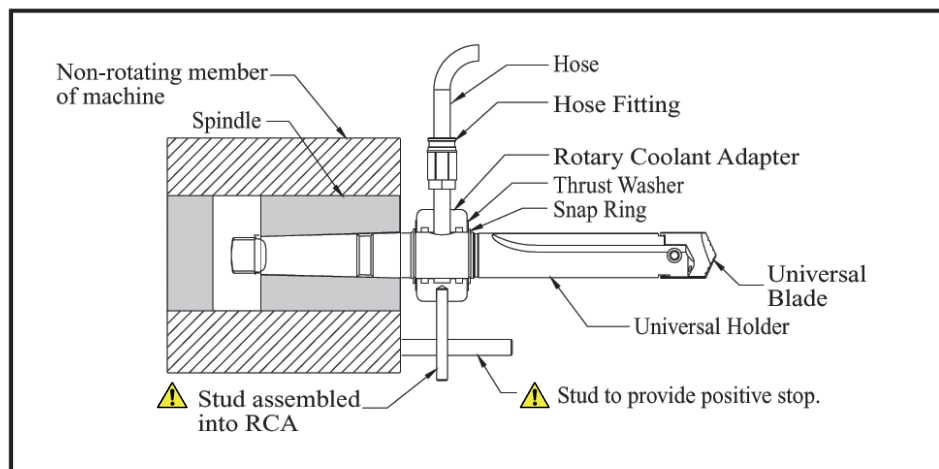
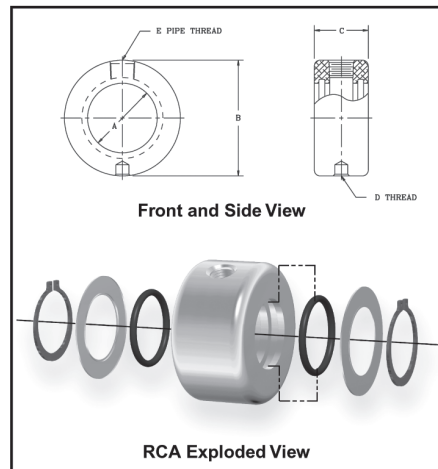

Sample application of a Rotary Coolant Adapter.

⚠ WARNING

RCA rotation during drilling can cause hose and/or hose fitting failure, machinery damage and/or serious injury. To prevent, use RCA and positive stop studs when drilling.

Factory technical assistance is also available for your specific applications.



Deep Hole Drilling Guidelines

For use with AMEC Drills greater than 9xD (Depths to Diameter), including Long, Extra Long, and Special Length



- 1) Pilot Hole
100% RPM
100% IPR (mm/rev)

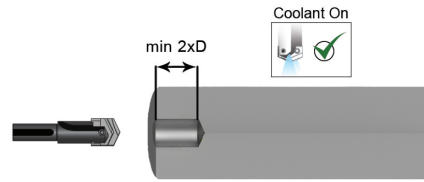

- Establish the pilot hole using the same diameter short drill to a depth of a 2xD minimum
- Utilize a pilot drill with the same or larger included point angle

- 2) Feed In
50 RPM Max
12 IPM (300mm/min)

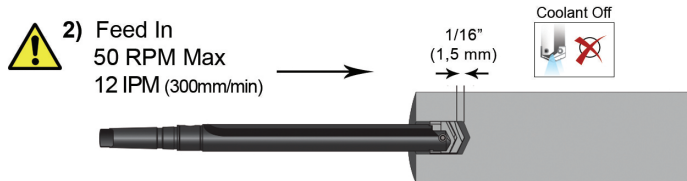

- Feed the longer drill within 1/16" (1,5 mm) short of the established pilot hole bottom at a **maximum of 50 RPM** and 12 IPM (300 mm/min) feed rate

- 3) Deep Hole Transition Drilling
50% RPM
75% IPR (mm/rev)

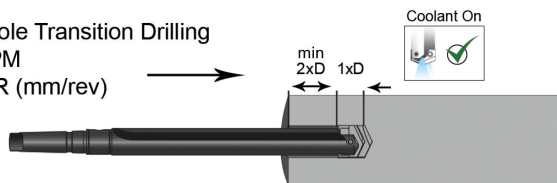

- Drill additional 1xD past bottom of pilot hole at 50% reduction of recommended speed and 25% reduction of recommended feed
- Minimum of 1 second dwell is required to meet full speed before feeding

- 4) Deep Hole Drilling - Blind
100% RPM
100% IPR (mm/rev)

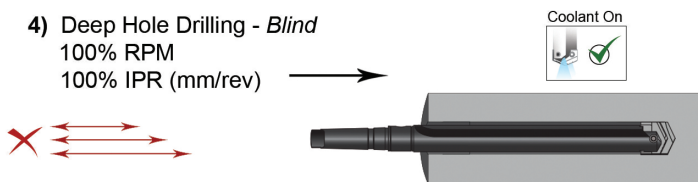

- Drill to full depth at recommended speed and feed for longer drills, according to Allied speed and feed charts

No peck cycle recommended

- 5) Deep Hole Drilling - At Breakout
50% RPM
75% IPR (mm/rev)

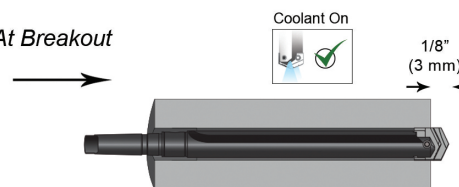

For Through Holes Only

- Reduce speed by 50% and feed by 25% prior to breakout
- Do not breakout more than 1/8" (3 mm) past the full diameter of drill

- 6) Drill Retract
50 RPM Max

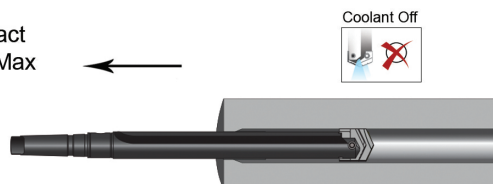

- Reduce speed to **maximum of 50 RPM** before retracting from hole

WARNING

Tool failure can cause serious injury. To prevent:

- When using holders without support bushing, use a short length holder to establish an initial hole that is a minimum of 2 diameters deep.
- Do not rotate tool holders more than 50 RPM unless it is engaged with workpiece or fixture

Visit www.alliedmachine.com/deepholeguidelines.aspx for the most up-to-date information and procedures. Factory technical assistance is also available for your specific applications.



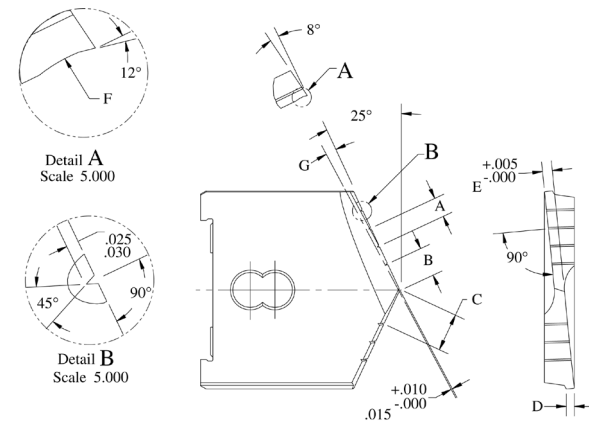
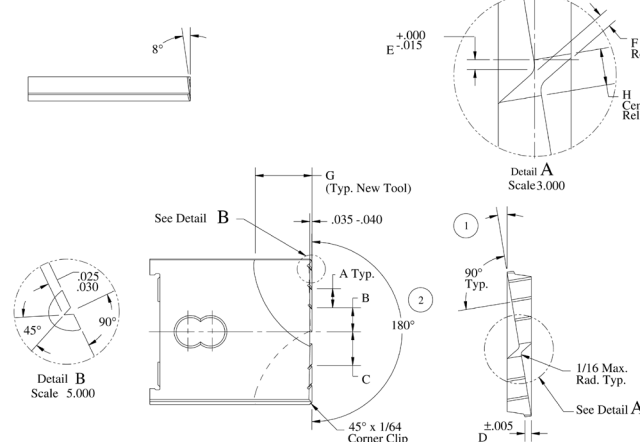

Universal Regrind Charts

Universal Style	Flat Bottom
 <p>Notes:</p> <ol style="list-style-type: none"> Maintain cutting edges of the tool within .001" T.I.R. 	 <p>Notes:</p> <ol style="list-style-type: none"> Grind cutting edge .005" above center line at the center of new tool. Maintain flatness and height across the cutting edges of the tool within .001" T.I.R.

Universal Style Spade Drills										Flat Bottom Spade Drills								
Series	Blade Thickness	Size Range	A	B	C	D	E	F	G	Size Range	A	B	C	D	E	F	G	H
AA	1/4"	1" - 1-3/8"	.125	.156	.218	.065	.070	1/4"	3°	1" - 1-1/4"	.150	.250	.325	.065	1/64" - 1/32"	.075	7/16"	1/8"
A	3/16"	31/32" - 1-3/8"	.125	.156	.218	.065	.065	1/4"	3°	31/32" - 1-1/4"	.150	.250	.325	.065	1/64" - 1/32"	.075	7/16"	1/8"
B	9/32"	1-1/4" - 1-3/4"	.150	.250	.325	.070	.090	5/16"	3°	1-1/4" - 1-1/2"	.200	.250	.350	.070	1/64" - 1/32"	.075	1/2"	1/8"
C	5/16"	1-1/2" - 2-3/8"	.200	.250	.350	.080	.100	5/16"	3°	1-1/2" - 2"	.200	.250	.350	.080	1/32" - 3/64"	.075	5/8"	1/8"
D	3/8"	2" - 2-7/8"	.250	.375	.500	.100	.120	3/8"	3°	2" - 2-1/2"	.300	.375	.525	.100	1/32" - 3/64"	.129	7/8"	3/16"
E	7/16"	2-1/2" - 3-3/8"	.300	.437	.587	.100	.140	3/8"	3°	2-1/2" - 3"	.300	.375	.525	.100	1/32" - 1/16"	.129	1-1/8"	3/16"
F	1/2"	3" - 3-7/8"	.350	.437	.612	.125	.170	3/8"	3°	3" - 3-1/2"	.300	.500	.650	.125	1/32" - 1/16"	.156	1-1/4"	1/4"
G	5/8"	3-1/2" - 4-1/2"	.350	.500	.675	.140	.200	3/8"	3°	3-1/2" - 4"	.400	.500	.700	.140	1/32" - 1/16"	.156	1-1/2"	1/4"
H ¹ - H ²	11/16"	4" - 5"	.400	.500	.700	.165	.225	1/2"	3°	4" - 5"	.500	.500	.750	.165	1/32" - 1/16"	.156	1-1/2"	1/4"
H ³	11/16"	5-1/8" - 5-1/2"	.500	.500	.750	.185	.250	1/2"	3°	-	-	-	-	-	-	-	-	-
H ⁴ - H ⁹	11/16"	5-5/8" - 8-1/2"	.500	.500	.750	.185	.250	1/2"	2°	-	-	-	-	-	-	-	-	-

High Performance Regrinds

High Performance Drills should be reground and coated by Allied before returning them to production. The real economy of HP Spade Drills is their improved production rates (100% to 500%) and increased tool life (3 to 20 times). Factory regrounding and coating provides LIKE-NEW TOOL PERFORMANCE. Our factory service reduces your total cost per hole.



Warranty Information

Allied Machine & Engineering Corp. warrants to original equipment manufacturers, distributors, industrial and commercial users of its products that each new product manufactured or supplied by Allied Machine shall be free from defects in material and workmanship.

Allied's obligation under this warranty is limited to furnishing without additional charge for a replacement, or the option of repairing or issuing credit for any product which shall within one year from the date of sale be returned freight prepaid to the plant designated by an Allied representative and which upon inspection is determined by Allied to be defective in materials or workmanship.

Complete information as to operating conditions, machine, set-up, and application of cutting fluid should accompany any product returned for inspection. The provisions of this warranty shall not apply to any Allied products which have been subjected to misuse, improper operating conditions, machine set-up or application of cutting fluid or which have been repaired or altered if such repair or alteration in the judgment of Allied would adversely affect performance of the product.

THIS WARRANTY IS IN LIEU OF ALL OTHER WARRANTIES, EXPRESS OR IMPLIED, INCLUDING ANY IMPLIED WARRANTY OF MERCHANTABILITY OR FITNESS FOR A PARTICULAR PURPOSE. Allied shall have no liability or responsibility on any claim of any kind, whether in contract, tort or otherwise, for any loss or damage arising out of, connected with, or resulting from the manufacture, sale, delivery or use of any product sold hereunder, in excess of the cost of replacement or repair as provided herein.

ALL PRICES, DELIVERIES, DESIGNS, AND MATERIALS ARE SUBJECT TO CHANGE WITHOUT NOTICE.



120 Deeds Drive
Dover, OH 44622
Ph. (330) 343-4283
Toll Free USA & Canada (800) 321-5537
Fax. (330) 602-3400
Toll Free USA & Canada (800) 223-5140
International Country Code: 01
Website: www.alliedmachine.com
Email: info@alliedmachine.com



Regional Distribution Warehouse Locations

USA

Allied Machine & Engineering Corp.
120 Deeds Drive - PO Box 36
Dover, Ohio 44622-0036

Ph: (330) 343-4283
(800) 321-5537 (Toll Free USA & Canada)
Fax: (330) 602-3400
(800) 223-5140 (Toll Free USA & Canada)
(330) 364-7666 (Engineering)

Europe

Allied Maxcut Engineering Co. Limited
93 Vantage Point, Pensnett Estate
Kingswinford, West Midlands
DY6 7FR ENGLAND

Ph: 011 -44-1384-400900
Fax: 011 -44-1384-400105

Singapore

Allied Machine & Engineering Corp.
1 Ubi View
#3-18 Focus One
Singapore SG 408555

Ph: (330) 343-4283
Fax: (330) 602-3400
(330) 364-7666 (Engineering)
Email: exports@alliedmachine.com



Allied Machine & Engineering Corp.
Registered to ISO 9001:2008
10001329

Also available

Allied Drilling Products Catalog

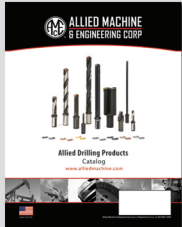

Allied Drilling Products are designed and manufactured by Allied Machine & Engineering Corp. The combination of premium materials, along with unique geometry and coatings allows for the finest drilling systems in the metal cutting industry, resulting in the lowest cost per hole.

Literature Order Number: ADP

Allied Threadmilling Catalog



AccuThread 856® specific Threadmills conform with J1926 and SAE AS5202 and have a thicker core and a helical flute which offers increased strength and rigidity when cutting forces are applied. AccuThread 856 provides superior thread forms compared to other competitive threadmills and taps.

Literature Order Number: TMC

Allied Criterion Boring Systems



Allied Criterion products offer a wide variety of options that can cover a range of .050" in diameter. Products include CB Style Boring Head, Cri-Twin®, Cri-Bore®, LCB1500, and CBER®. Ideal for close tolerance precision boring.

Literature Order Number: CRIT-14

ALVAN® Reamers



The ALVAN product line includes monobloc, ring style, and replaceable head reamers, offered with carbide, cermet, PCD, and CBN cutting edges.

Literature Order Number: ALV

