



ALLIED MACHINE & ENGINEERING

Holemaking Solutions for Today's Manufacturing



Drilling



Boring



Reaming



Threading



Specials



EcoCut

► *MULTIFUNCTION TOOLING*

North America

Allied Machine
120 Deeds Drive
Dover, OH 44622
United States

Allied Machine
485 West 3rd Street
Dover, OH 44622
United States

ThreadMills USA™

4185 Crosstowne Ct #B
Evans, GA 30809
United States

Superion™

1285 S Patton St.
Xenia, OH 45385
United States

Europe

Allied Machine Europe
93 Vantage Point
Pensnett Estate
Kingswinford
West Midlands
DY6 7FR, United Kingdom

Wohlhaupter® GmbH

Maybachstrasse 4
Postfach 1264
72636 Frickenhausen
Germany

Asia

Wohlhaupter® India
B-23, 2nd Floor
B Block Community Centre
Janakpuri, New Delhi - 110058
India



Allied Machine & Engineering is a worldwide leader in holemaking and finishing solutions. We are committed to providing practical and dependable solutions to our customers through innovative designs and superior customer and technical support.

We continue to expand our product offering in order to provide new and different solutions. With Field Sales Engineers located around the world, we position ourselves to provide technical support on site, right at your spindle.



www.alliedmachine.com



ALLIED MACHINE & ENGINEERING

Holemaking Solutions for Today's Manufacturing

EcoCut

The Foundation

Since 1941, Allied Machine & Engineering has provided dependable and practical holemaking solutions to the world. What was once a small job shop in Ohio is now a worldwide leader in cutting tool technology. With three manufacturing facilities in Ohio, one in Georgia, another in Germany, and headquarters in both the United States and Europe, Allied Machine is positioned to bring innovative solutions and technical expertise directly to the customers' hands.



The Beginning

Harold E. Stokey founded Allied Machine & Engineering to aid the war effort, manufacturing taper bearing lock nuts for the production of M1 tanks. Years later, after a sales meeting gone wrong, Stokey possessed a warehouse stocked with spade drill inserts. He set forth into the industry that would become Allied Machine's thriving identity: holemaking.



The T-A®

When Harold's son, William H. Stokey, became the president and CEO, he developed the Throw Away, or T-A, spade drill insert system. The T-A revolutionized the holemaking industry, launching Allied Machine ahead of the competition. Since then, numerous innovations and advancements have been created from the T-A's inspiration.



The Innovation

Since the development of the T-A, Allied Machine has expanded its product offering to support a vast range of customer applications, including large diameter and deep hole drilling, boring, reaming, burnishing, porting, and threading.

The People

Allied Machine understands that high quality products are only one facet of success. Our customer support is crucial to what we do, and that's why we make sure the best engineers and customer service associates are in place to assist our customers around the world.

The Future

With over 75 years of experience, Allied Machine has encountered the challenges of growth and success. By investing in cutting edge technology and the brightest and sharpest minds, our knowledge and capabilities continue to expand and grow every day.



Steve Stokey
Executive Vice President

William H. Stokey
President and CEO

Mike Stokey
Executive Vice President



WOHLHAUPTER®



SUPERION™

CRITERION™

Replaceable Insert Drills

- Reduce costs by decreasing set-up time and utilizing a single holder for the lives of multiple inserts
- Provide flexibility to quickly switch between inserts with different geometries
- Products:
 - GEN3SYS® XT | GEN3SYS® XT Pro
 - Original T-A® | GEN2 T-A®
 - High Performance | Universal



Indexable Insert Drills

- Protect your investment and reduce your inventory with replaceable cartridges that allow the same holder to be used repeatedly
- Indexable inserts increase productivity and tool life while reducing costs
- Products:
 - 4TEX™ Drill
 - Revolution Drill®
 - Opening Drill®



Replaceable / Indexable Insert Drills

- Allow for higher spindle speeds and take advantage of the power curve on modern CNC machines
- Achieve maximum penetration rates in deep hole drilling applications
- Holders cover a range of sizes with the replaceable heads determining the cutting diameter
- Products:
 - APX Drill



Solid Carbide Drills

- Offer greater strength and stability when drilling tougher materials
- Available in diameters from 3mm - 20mm
- Can be made-to-order specifically for your application (Superion™ quoted specials)
 - ASC 320®
 - Superion™





Structural Steel Solutions

- Deliver outstanding performance and durability in structural steel applications
- Designed to produce optimal results in difficult-to-machine materials
- Available in multiple lengths and diameters
- T-A® style drills have different insert geometry options to improve performance depending on material
- Products:
 - Original T-A® | GEN2 T-A®
 - GEN3SYS® XT Pro

BTA (STS) Machining Solutions

- The internal ejection system flushes chips and debris from the hole with no interference to the cutting process
- Utilizes the advantages of the T-A® drill insert
- Designed to significantly increase penetration rates over brazed heads and traditional gun drills
- Products:
 - BT-A Drill



Hydraulic Port Contour Cutters

- Save significant time and money by performing four processes in one step
- Replaceable insert design reduces costs, inventory, and set-up times
- Available in 4 industry specifications:
 - Imperial: SAE J-1926
 - Metric: ISO 6149-1:2006
 - Military: SAE AS5202
 - John Deere: JDS-G173.1
- Products:
 - AccuPort 432®



Enhanced Special Drilling Capabilities

- Allied Machine Engineers are available to meet with you to evaluate your application and recommend the best solution for you
- Special drilling solutions can incorporate advanced features such as adjustable diameter locations, multiple steps, additional coolant designs, special lengths and diameters, and more
- Special drills can drastically reduce your cost-per-hole and increase your overall productivity by eliminating multiple processes and increasing tool life



WOHLHAUPTER®

High Precision Boring Systems

- Designs available for high volume applications that increase rigidity to improve performance
- Versatile boring heads that are flexible with changing applications while maintaining excellent performance
- Provides high precision with absolute repeatability to ensure every part is held to tolerance
- Offers an industry leading modular shank connection that maintains rigidity and reduces inventory on your boring system
- Available with both digital and analog settings
- Products:
 - Wohlhaupter® Boring Tools



3E TECH



CRITERION™

Modular Boring Systems

- The modular capabilities are ideal for use across multiple different projects
- Offers versatile boring heads suitable for all job shops and tooling rooms
- Provides an economical solution for low volume and/or short-term production applications
- Offers both rough and finish boring solutions
- Products:
 - Criterion™ Boring Tools

S.C.A.M.I.®

Expandable Reaming Solutions

- Expandable cutting diameters accommodate for wear, which extends tool life
- Replaceable cutting heads and rings reduce waste and improve production time versus solid high speed steel and carbide reamers
- Hold tight tolerances to ensure processes are performed to accurate specifications
- Reduce tooling costs because many items are available for recondition
- Products:
 - ALVAN® Reamers



S.C.A.M.I.®

Roller Burnishing Solutions

- Produce excellent surface finishes
- Provide accurate size control
- Increase surface hardness
- Solutions for both through hole and blind hole applications
- Products:
 - S.C.A.M.I.® Roller Burnishing Tools



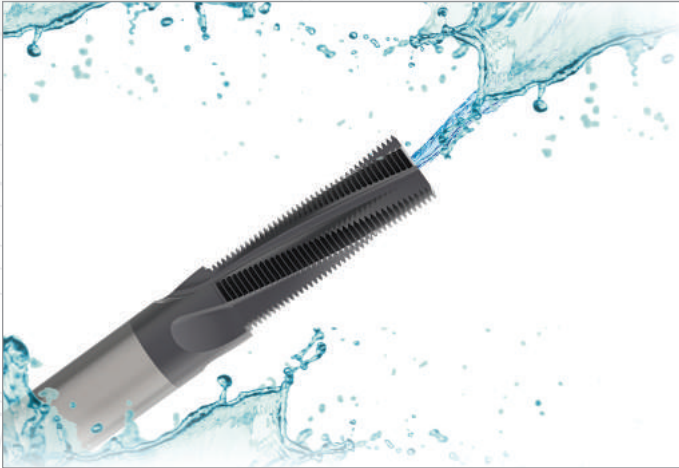

Solid Carbide Thread Mills

- Available with coolant through options
- Cover a wide range of thread forms
- Provide optimal solutions for both high production projects and short-run applications
- Products
 - AccuThread™ 856
 - AccuThread™ T3
 - ThreadMills USA



Replaceable Insert Thread Mills

- 3 insert lengths are available that cover a wide range of thread forms
- Holders can utilize inserts with different pitches and thread forms
- Repeatability is achieved by both the bolt-in style and the pin style locking systems
- Increase tool life by 25 - 50% with Allied Machine's AM210® coating
- Products
 - AccuThread™ 856: Bolt-in Style
 - AccuThread™ 856: Pin Style



SPECIAL CAPABILITIES

When it comes to designing and developing special solutions for customers, Allied Machine is the top choice. If your application requires special tooling, give us a call. Our engineered specials are developed by the brightest engineers in the industry. Most of our standard tooling can be altered as specials, or we can create entirely new concepts for particularly unique applications.

One special tooling solution is Insta-Quote™, the online system that allows you to design your own special tooling 24/7. Receive a quote and drawings within minutes just by following the steps.

And with the addition of Superior™ technology and capabilities, we can customize made-to-order solid carbide tools to achieve optimal results for your applications.

Whatever your application, Allied Machine has the answer.



Insta-Quote™ 

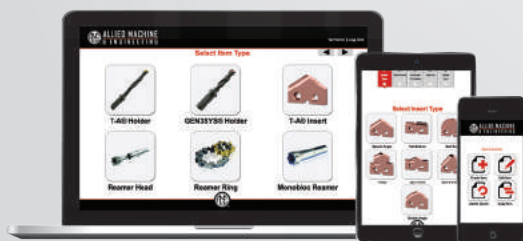

 SUPERION™





The Original Multifunction Tool

EcoCut unites the capabilities of tools for the machining of internal and external profiles as well as for drilling. The reduced number of tools frees up additional turret positions on the machine. Simultaneously, the setting and programming time is reduced.

The EcoCut product line includes the "Classic" tools with indexable inserts and the solid carbide tools, "Mini." This allows drilling diameters from 4 - 32mm.

Creates fine surface finishes	Increases wear and corrosion resistance	Eliminates other processes and saves you money
-------------------------------	---	--

Applicable Industries

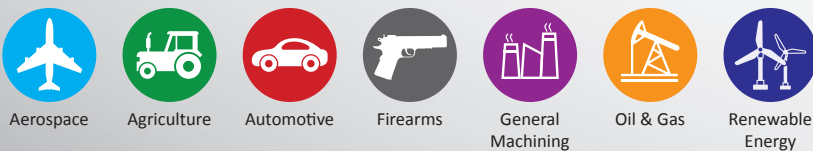

Your safety and the safety of others is very important. This catalog contains important safety messages. Always read and follow all safety precautions.



This triangle is a safety hazard symbol. It alerts you to potential safety hazards that can cause tool failure and serious injury.

When you see this symbol in the catalog, look for a related safety message that may be near this triangle or referred to in the nearby text.

There are safety signal words also used in the catalog. Safety messages follow these words.

⚠ WARNING

WARNING (shown above) means that failure to follow the precautions in this message could result in tool failure and serious injury.

NOTICE means that failure to follow the precautions in this message could result in damage to the tool or machine but not result in personal injury.

NOTE and **IMPORTANT** are also used. These are important that you read and follow but are not safety-related.

Visit www.alliedmachine.com for the most up-to-date information and procedures.

Reference Icons

The following icons will appear throughout the catalog to help you navigate between products.



Recommended Applications
Information regarding correct and incorrect operations

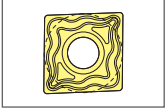

Inserts
Refers to the insert options available for each tool

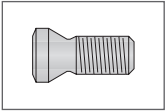

Accessories
Refers to the screws and drivers needed for each tool

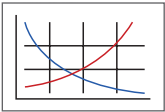

Recommended Cutting Data
Speed and feed recommendations for optimum and safe machining

Introduction Information

Product Overview 2
 Grade Overview 3
 Productivity 4
 Product Nomenclature 5

EcoCut Mini

Solid Carbide Tools 6
 Adapters 7

EcoCut Classic

8mm Tools 8
 10mm Tools 9
 12mm Tools 10
 14mm Tools 11
 16mm Tools 12
 18mm Tools 13
 20mm Tools 14
 25mm Tools 15
 32mm Tools 16

EcoCut Rebore 17

Inserts 18 - 20

Accessories 21

Recommended Cutting Data 22 - 23

Drilling Depths / Feed Charts

EcoCut Mini 24 - 25
 EcoCut Classic 26 - 28
 EcoCut Rebore 29

Application Recommendations 30 - 33

Guaranteed Demo Application 34



Allied Machine & Engineering offers EcoCut through a supply agreement with Ceratzit

EcoCut (distributed in North America by Allied Machine) offers a versatile line of lathe tools that can perform up to four machining operations. A single EcoCut tool can be used for drilling, boring, facing, and standard turning operations. EcoCut tools can improve cycle times while reducing both tooling costs and tool storage problems. They also offer the benefit of shorter set-up times for many lathe applications.

The EcoCut product line is divided into three basic styles:

- **Mini:** solid carbide version available in diameters 4 - 8mm
- **Classic:** indexable version available in diameters 8 - 32mm
- **Rebore:** indexable 3-flute boring tool available in two diameters 40mm and 60mm

Product Overview

4 Operations in 1 TOOL

1. Drilling (into solid materials with flat bottom holes)
2. Boring applications
3. Turning of face profiles
4. External turning applications



A
DRILLING

B
BORING

C
REAMING

D
BURNISHING

E
THREADING

X
SPECIALS



Conventional



EcoCut



EcoCut Advantages	
✓	Reduces inventory and tooling costs
✓	Simplifies programming
✓	Produces a flat bottom hole
✓	Reduces set-up times and pre-setting times



EcoCut Mini

Diameter Range: 4 - 8mm

Features of EcoCut Mini

- ✓ Drilling Ø from 4 - 8mm
- ✓ Lengths of 2.25xD and 4xD
- ✓ 2 grades for a variety of applications
- ✓ Solid carbide
- ✓ Left or right hand cutting



EcoCut Classic

Diameter Range: 8 - 32mm

Features of EcoCut Classic

- ✓ Drilling Ø from 8 - 32mm
- ✓ Lengths of 1.5xD, 2.25xD, 3xD
- ✓ 3xD bodies are made from densimet
- ✓ Left or right hand cutting
- ✓ Available in inch and metric shanks

Productivity

Breakdown of Workpiece Costs

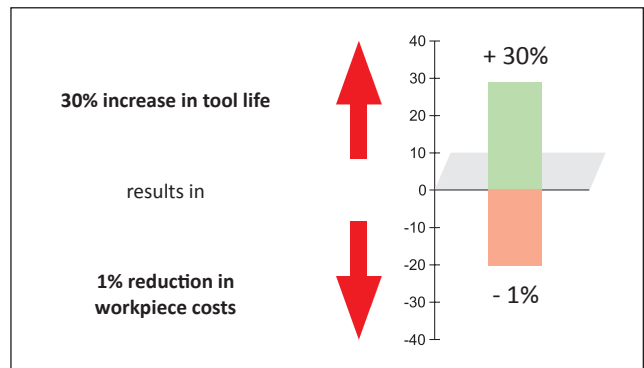
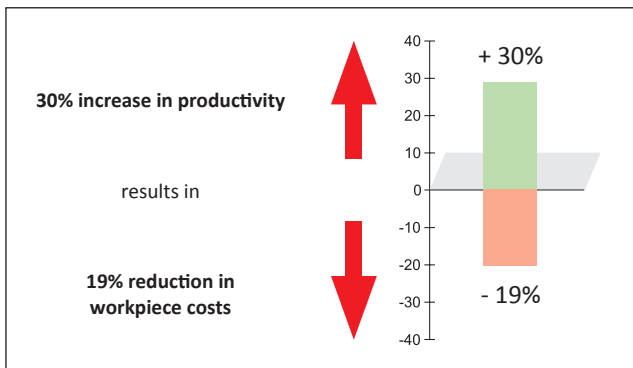
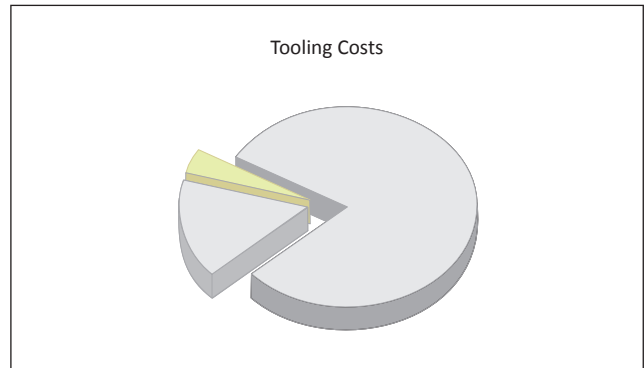
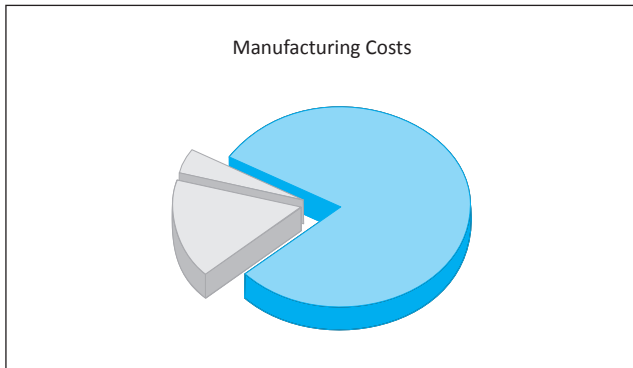
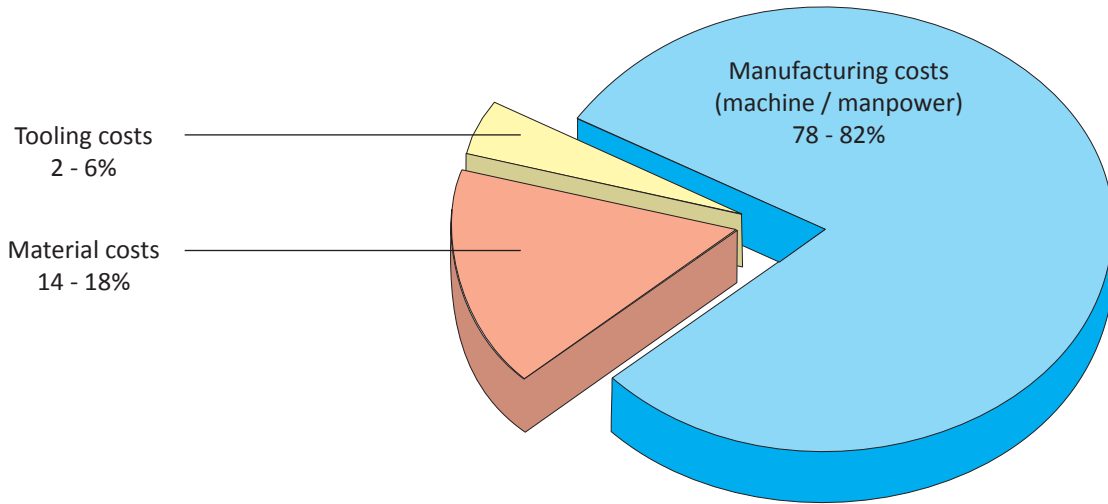

Increase in productivity (parts produced per time unit)

Improved utilization of the available machine capacity leads to considerable cost reduction per workpiece. In this context, EcoCut tooling makes a decisive contribution through:

- Fewer tool changes
- Increase of speed
- Increase of feed
- Decrease of cycle time

As the average tool costs amount to only 2 - 6% of the workpiece costs, prolonging tool life typically can only reduce total costs minimally.

A DRILLING
B BORING
C REAMING
D BURISHING
E THREADING
X SPECIALS

Product Nomenclature

EcoCut Mini

ECM	04	L	2.25D	27	CTWN425
1	2	3	4	5	6

1. Style ECM = EcoCut Mini	2. Nominal Diameter (mm) 04 = 04 series 05 = 05 series 06 = 06 series 07 = 07 series 08 = 08 series	3. Cutting Direction L = Left handed R = Right handed	4. Maximum Drilling Depth 2.25D = 2.25xD 4.00D = 4.00xD
5. Features 27 = Master Finish	6. Grade CTPP435 CTWN425		

EcoCut Classic

ECC	32	R	3.0D	17	H	-	E
1	2	3	4	5	6		7

1. Style EC = EcoCut Classic (inch) ECC = EcoCut Classic (metric)	2. Nominal Diameter (mm) 08 = 08 series 14 = 14 series 20 = 20 series 10 = 10 series 16 = 16 series 25 = 25 series 12 = 12 series 18 = 18 series 32 = 32 series	3. Cutting Direction L = Left handed R = Right handed
4. Maximum Drilling Depth 1.5D = 1.50xD 2.25D = 2.25xD 3.0D = 3.00xD	5. Insert Size (Cutting Edge Length) 04 = 4mm 07 = 7mm 10 = 10mm 05 = 5mm 08 = 8mm 13 = 13mm 06 = 6mm 09 = 9mm 17 = 17mm	6. Features H = Densimet
		7. Shank Blank = Metric E = Imperial

Reference Key

Symbol	Attribute
D1	Nominal drill diameter
D2	Shank diameter
D3	Flange diameter (2.25xD holders)
L1	Overall length
L2	Tool reference length
L3	Maximum length of cut
L8	Insert width
P1	Pipe tap

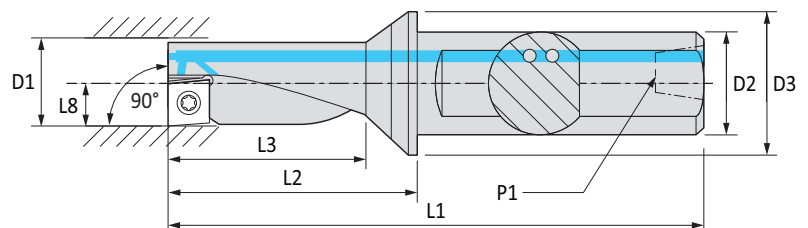

EcoCut Mini

Solid Carbide | Diameter Range: 0.157" - 0.315" (4.00mm - 8.00mm)



Left hand tool shown

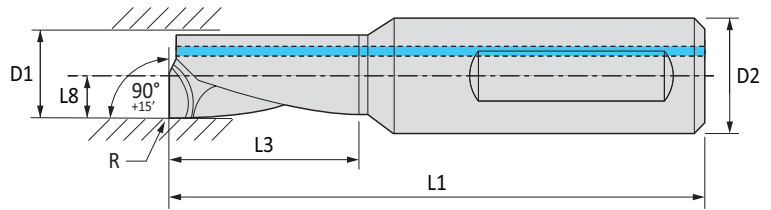

Cutting Action	D1	Body				Shank	Part No.	Description - Grade	MasterGuide					
		L3	L8	L1	R				D2	P	S	M	H	K
Left	4.00	9.00	2.00	35.00	0.20	6.00	11831130	ECM 04L-2.25D CTPP435	●	●	●		○	○
Left	4.00	9.00	2.00	35.00	0.20	6.00	11830752	ECM 04L-2.25D-27 CTWN425						●
Left	4.00	16.00	2.00	41.00	0.20	6.00	11831155	ECM 04L-4.00D CTPP435	●	●	●		○	○
Left	4.00	16.00	2.00	41.00	0.20	6.00	11830779	ECM 04L-4.00D-27 CTWN425						●
Right	4.00	9.00	2.00	35.00	0.20	6.00	11831177	ECM 04R-2.25D CTPP435	●	●	●		○	○
Right	4.00	9.00	2.00	35.00	0.20	6.00	11830786	ECM 04R-2.25D-27 CTWN425						●
Right	4.00	16.00	2.00	41.00	0.20	6.00	11831183	ECM 04R-4.00D CTPP435	●	●	●		○	○
Right	4.00	16.00	2.00	41.00	0.20	6.00	11830804	ECM 04R-4.00D-27 CTWN425						●
Left	5.00	11.25	2.50	37.00	0.20	6.00	11831187	ECM 05L-2.25D CTPP435	●	●	●		○	○
Left	5.00	11.25	2.50	37.00	0.20	6.00	11830808	ECM 05L-2.25D-27 CTWN425						●
Left	5.00	20.00	2.50	45.00	0.20	6.00	11831190	ECM 05L-4.00D CTPP435	●	●	●		○	○
Left	5.00	20.00	2.50	45.00	0.20	6.00	11830811	ECM 05L-4.00D-27 CTWN425						●
Right	5.00	11.25	2.50	37.00	0.20	6.00	11831417	ECM 05R-2.25D CTPP435	●	●	●		○	○
Right	5.00	11.25	2.50	37.00	0.20	6.00	11830814	ECM 05R-2.25D-27 CTWN425						●
Right	5.00	20.00	2.50	45.00	0.20	6.00	11831427	ECM 05R-4.00D CTPP435	●	●	●		○	○
Right	5.00	20.00	2.50	45.00	0.20	6.00	11830822	ECM 05R-4.00D-27 CTWN425						●
Left	6.00	13.50	3.00	38.00	0.20	8.00	11831428	ECM 06L-2.25D CTPP435	●	●	●		○	○
Left	6.00	13.50	3.00	38.00	0.20	8.00	11830826	ECM 06L-2.25D-27 CTWN425						●
Left	6.00	24.00	3.00	49.00	0.20	8.00	11831434	ECM 06L-4.00D CTPP435	●	●	●		○	○
Left	6.00	24.00	3.00	49.00	0.20	8.00	11830829	ECM 06L-4.00D-27 CTWN425						●
Right	6.00	13.50	3.00	38.00	0.20	8.00	11831445	ECM 06R-2.25D CTPP435	●	●	●		○	○
Right	6.00	13.50	3.00	38.00	0.20	8.00	11830832	ECM 06R-2.25D-27 CTWN425						●
Right	6.00	24.00	3.00	49.00	0.20	8.00	11831453	ECM 06R-4.00D CTPP435	●	●	●		○	○
Right	6.00	24.00	3.00	49.00	0.20	8.00	11831090	ECM 06R-4.00D-27 CTWN425						●
Left	7.00	15.75	3.50	42.00	0.20	8.00	11831458	ECM 07L-2.25D CTPP435	●	●	●		○	○
Left	7.00	15.75	3.50	42.00	0.20	8.00	11831091	ECM 07L-2.25D-27 CTWN425						●
Left	7.00	28.00	3.50	53.00	0.20	8.00	11831473	ECM 07L-4.00D CTPP435	●	●	●		○	○
Left	7.00	28.00	3.50	53.00	0.20	8.00	11831093	ECM 07L-4.00D-27 CTWN425						●
Right	7.00	15.75	3.50	42.00	0.20	8.00	11831477	ECM 07R-2.25D CTPP435	●	●	●		○	○
Right	7.00	15.75	3.50	42.00	0.20	8.00	11831101	ECM 07R-2.25D-27 CTWN425						●
Right	7.00	28.00	3.50	53.00	0.20	8.00	11831478	ECM 07R-4.00D CTPP435	●	●	●		○	○
Right	7.00	28.00	3.50	53.00	0.20	8.00	11831108	ECM 07R-4.00D-27 CTWN425						●
Left	8.00	18.00	4.00	45.00	0.20	8.00	11831480	ECM 08L-2.25D CTPP435	●	●	●		○	○
Left	8.00	18.00	4.00	45.00	0.20	8.00	11831109	ECM 08L-2.25D-27 CTWN425						●
Left	8.00	32.00	4.00	56.00	0.20	8.00	11831483	ECM 08L-4.00D CTPP435	●	●	●		○	○
Left	8.00	32.00	4.00	56.00	0.20	8.00	11831111	ECM 08L-4.00D-27 CTWN425						●
Right	8.00	18.00	4.00	45.00	0.20	8.00	11831484	ECM 08R-2.25D CTPP435	●	●	●		○	○
Right	8.00	18.00	4.00	45.00	0.20	8.00	11831112	ECM 08R-2.25D-27 CTWN425						●
Right	8.00	32.00	4.00	56.00	0.20	8.00	11831491	ECM 08R-4.00D CTPP435	●	●	●		○	○
Right	8.00	32.00	4.00	56.00	0.20	8.00	11831114	ECM 08R-4.00D-27 CTWN425						●

NOTE: Cutting action refers to whether the tool is left handed or right handed.

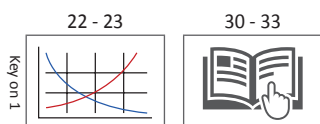

i = Imperial (in)
m = Metric (mm)

EcoCut Mini Adapters

Diameter Range: 0.157" - 0.315" (4.00mm - 8.00mm)

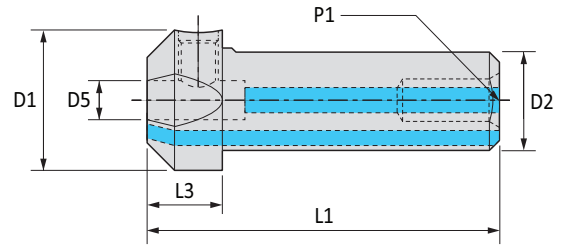
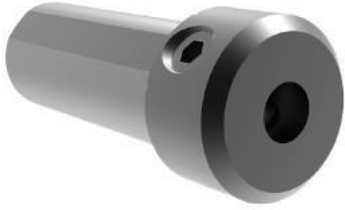

	Adapter						Part No.	Description	 Set Screw
	D5	D1	L3	L1	D2	P1			
i	0.236	0.984	0.550	2.500	0.750	1/8" -27 NPT	11160654	EC-ADX12-06-E	310720
	0.315	0.984	0.550	2.500	0.750	1/8" -27 NPT	11147398	EC-ADX12-08-E	310720
m	6	25.00	18.00	65.00	20.00	-	11155590	EC-ADX20-06	310720
	8	25.00	18.00	65.00	20.00	-	11108076	EC-ADX20-08	310720

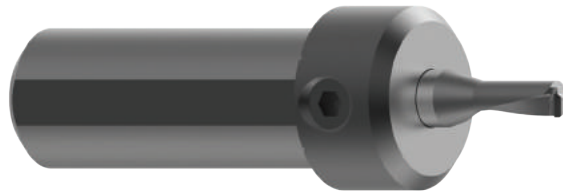

EcoCut Classic

8mm Tools

A DRILLING
B BORING
C REAMING
D BURNISHING
E THREADING
X SPECIALS



1.50xD

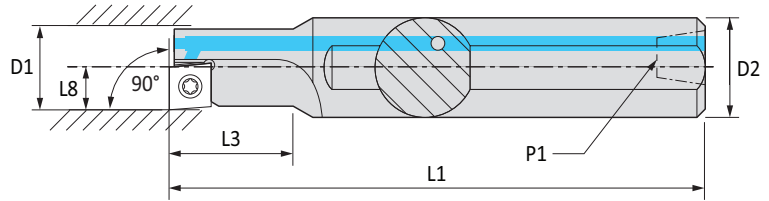

2.25xD

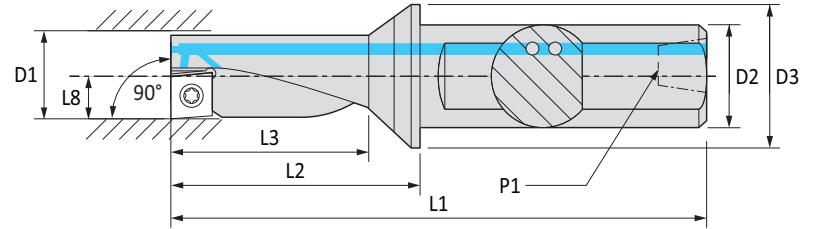

3.00xD

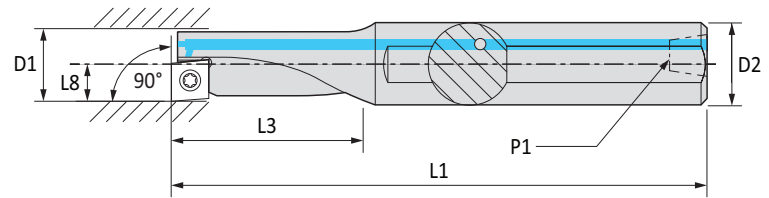

Left hand tools shown

Cutting Action	Body					Shank			Part No.	Description	Insert	Screw	Driver	
	D1	L2	L3	L8	L1	D2	D3	P1						
i	Left	0.315	-	0.47	0.157	3.15	0.500	-	1/16" -27 NPT	11065068	EC 08L-1.5D 04-E	XC.. 0401..	11807484	11843205
	Left	0.315	0.870	0.71	0.157	2.37	0.375	0.472	1/8" *	11065200	EC 08L-2.25D 04-E	XC.. 0401..	11807484	11843205
	Left	0.315	-	0.94	0.157	3.15	0.500	-	1/16" -27 NPT	11147310	EC 08L-3.0D 04 H-E	XC.. 0401..	11807484	11843205
	Right	0.315	-	0.47	0.157	3.15	0.500	-	1/16" -27 NPT	11065069	EC 08R-1.5D 04-E	XC.. 0401..	11807484	11843205
	Right	0.315	0.870	0.71	0.157	2.37	0.375	0.472	1/8" *	11065201	EC 08R-2.25D 04-E	XC.. 0401..	11807484	11843205
	Right	0.315	-	0.94	0.157	3.15	0.500	-	1/16" -27 NPT	11147327	EC 08R-3.0D 04 H-E	XC.. 0401..	11807484	11843205
m	Left	8	-	12	4	80	12	-	-	11837869	EC 08L-1.5D 04	XC.. 0401..	11807484	11843205
	Left	8	22	18	4	60	10	12	-	11837911	EC 08L-2.25D 04	XC.. 0401..	11807484	11843205
	Left	8	-	24	4	80	12	-	-	11837989	EC 08L-3.0D 04 H	XC.. 0401..	11807484	11843205
	Right	8	-	12	4	80	12	-	-	11837870	EC 08R-1.5D 04	XC.. 0401..	11807484	11843205
	Right	8	22	18	4	60	10	12	-	11837912	EC 08R-2.25D 04	XC.. 0401..	11807484	11843205
	Right	8	-	24	4	80	12	-	-	11837990	EC 08R-3.0D 04 H	XC.. 0401..	11807484	11843205

*1/8" = through hole only

NOTE: Cutting action refers to whether the tool is left handed or right handed.



i = Imperial (in)
m = Metric (mm)

HOLDERS ARE SUPPLIED WITH 3 INSERT CLAMPING SCREWS.
 INSERTS AND INSERT DRIVERS SOLD SEPARATELY.

EcoCut Classic

10mm Tools



1.50xD







2.25xD

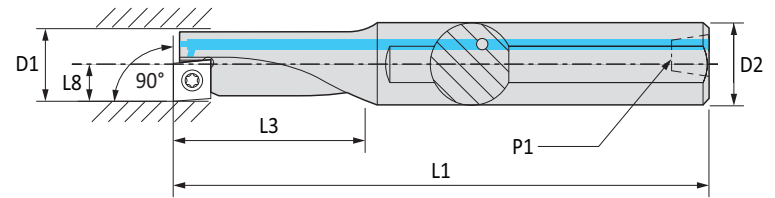
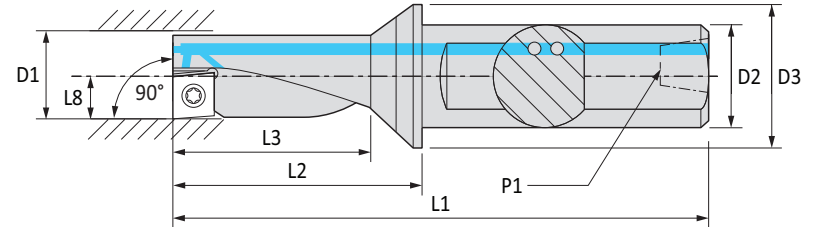
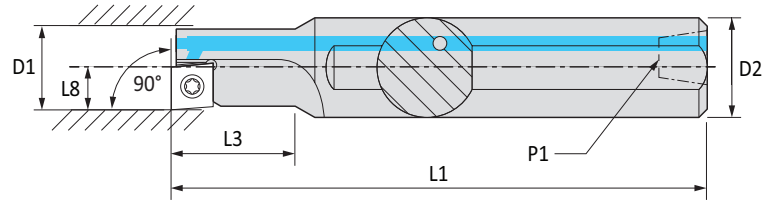

3.00xD

Left hand tools shown



Cutting Action	Body					Shank			Part No.	Description	Insert 	Screw 	Driver 	
	D1	L2	L3	L8	L1	D2	D3	P1						
i	Left	0.394	-	0.59	0.197	3.54	0.500	-	1/16" -27 NPT	11065070	EC 10L-1.5D 05-E	XC.. 0502..	11807480	11843205
	Left	0.394	1.085	0.89	0.197	2.71	0.500	0.630	1/16" -27 NPT	11065202	EC 10L-2.25D 05-E	XC.. 0502..	11807480	11843205
	Left	0.394	-	1.18	0.197	3.35	0.500	-	1/16" -27 NPT	11147311	EC 10L-3.0D 05 H-E	XC.. 0502..	11807480	11843205
	Right	0.394	-	0.59	0.197	3.54	0.500	-	1/16" -27 NPT	11065071	EC 10R-1.5D 05-E	XC.. 0502..	11807480	11843205
	Right	0.394	1.085	0.89	0.197	2.71	0.500	0.630	1/16" -27 NPT	11065203	EC 10R-2.25D 05-E	XC.. 0502..	11807480	11843205
	Right	0.394	-	1.18	0.197	3.35	0.500	-	1/16" -27 NPT	11147328	EC 10R-3.0D 05 H-E	XC.. 0502..	11807480	11843205
m	Left	10	-	15	5	90	12	-	-	11837873	EC 10L-1.5D 05	XC.. 0502..	11807480	11843205
	Left	10	27.5	22.5	5	69.5	12	16	-	11837915	EC 10L-2.25D 05	XC.. 0502..	11807480	11843205
	Left	10	-	30	5	85	12	-	-	11837991	EC 10L-3.0D 05 H	XC.. 0502..	11807480	11843205
	Right	10	-	15	5	90	12	-	-	11837881	EC 10R-1.5D 05	XC.. 0502..	11807480	11843205
	Right	10	27.5	22.5	5	69.5	12	16	-	11837917	EC 10R-2.25D 05	XC.. 0502..	11807480	11843205
	Right	10	-	30	5	85	12	-	-	11837993	EC 10R-3.0D 05 H	XC.. 0502..	11807480	11843205

NOTE: Cutting action refers to whether the tool is left handed or right handed.
NOTE: Holder shipped with 3 insert clamping screws. Inserts and hand drivers sold separately.

Key on 1

22 - 23



30 - 33



18 - 20



21



i = Imperial (in)
 m = Metric (mm)

Holders are supplied with 3 insert clamping screws. Inserts and insert drivers sold separately.

EcoCut Classic

12mm Tools

A DRILLING



1.50xD

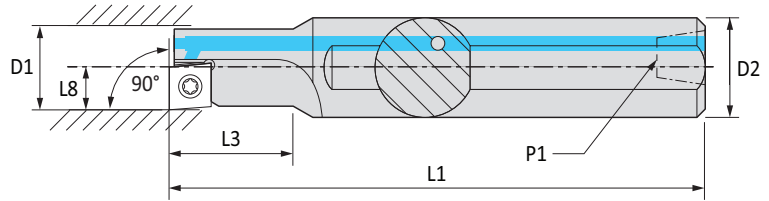

B BORING



2.25xD

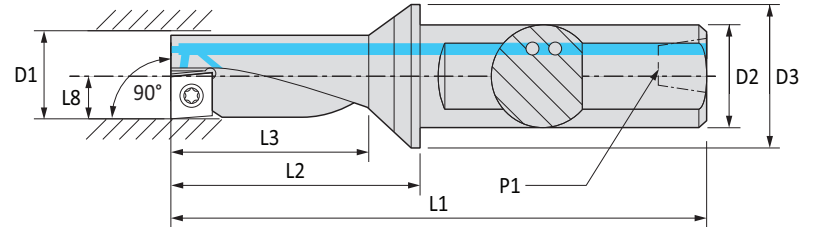

C REAMING

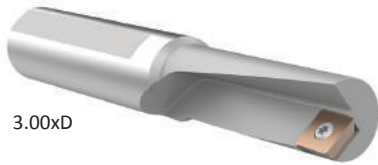

3.00xD

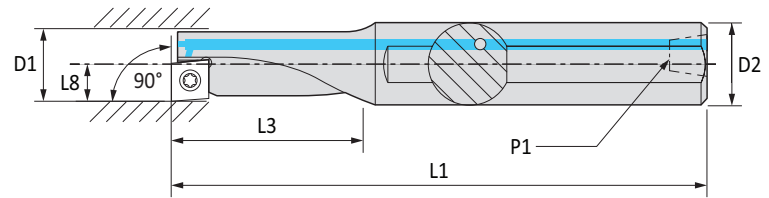

Left hand tools shown

Cutting Action	Body					Shank			Part No.	Description	Insert	Screw	Driver
	D1	L2	L3	L8	L1	D2	D3	P1					
Left	0.472	-	0.71	0.236	3.94	0.625	-	1/8" -27 NPT	11065073	EC 12L-1.5D 06-E	XC.. 0602..	11684214	11488748
Left	0.472	1.300	1.06	0.236	3.05	0.625	0.787	1/8" -27 NPT	11065204	EC 12L-2.25D 06-E	XC.. 0602..	11684214	11488748
Left	0.472	-	1.42	0.236	3.74	0.625	-	1/8" -27 NPT	11147313	EC 12L-3.0D 06 H-E	XC.. 0602..	11684214	11488748
Right	0.472	-	0.71	0.236	3.94	0.625	-	1/8" -27 NPT	11065074	EC 12R-1.5D 06-E	XC.. 0602..	11684214	11488748
Right	0.472	1.300	1.06	0.236	3.05	0.625	0.787	1/8" -27 NPT	11065205	EC 12R-2.25D 06-E	XC.. 0602..	11684214	11488748
Right	0.472	-	1.42	0.236	3.74	0.625	-	1/8" -27 NPT	11147329	EC 12R-3.0D 06 H-E	XC.. 0602..	11684214	11488748
Left	12	-	18	6	100	16	-	-	11837886	EC 12L-1.5D 06	XC.. 0602..	11684214	11488748
Left	12	33	27	6	78	16	20	-	11837918	EC 12L-2.25D 06	XC.. 0602..	11684214	11488748
Left	12	-	36	6	95	16	-	-	11837994	EC 12L-3.0D 06 H	XC.. 0602..	11684214	11488748
Right	12	-	18	6	100	16	-	-	11837887	EC 12R-1.5D 06	XC.. 0602..	11684214	11488748
Right	12	33	27	6	78	16	20	-	11837919	EC 12R-2.25D 06	XC.. 0602..	11684214	11488748
Right	12	-	36	6	95	16	-	-	11837995	EC 12R-3.0D 06 H	XC.. 0602..	11684214	11488748

NOTE: Cutting action refers to whether the tool is left handed or right handed.

NOTE: Holder shipped with 3 insert clamping screws. Inserts and hand drivers sold separately.

D BURNISHING

F THREADING

X SPECIALS



i = Imperial (in)
m = Metric (mm)

HOLDERS ARE SUPPLIED WITH 3 INSERT CLAMPING SCREWS.
 INSERTS AND INSERT DRIVERS SOLD SEPARATELY.

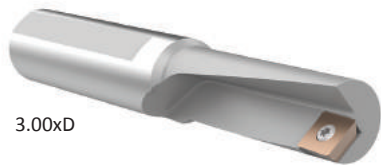

EcoCut Classic

14mm Tools

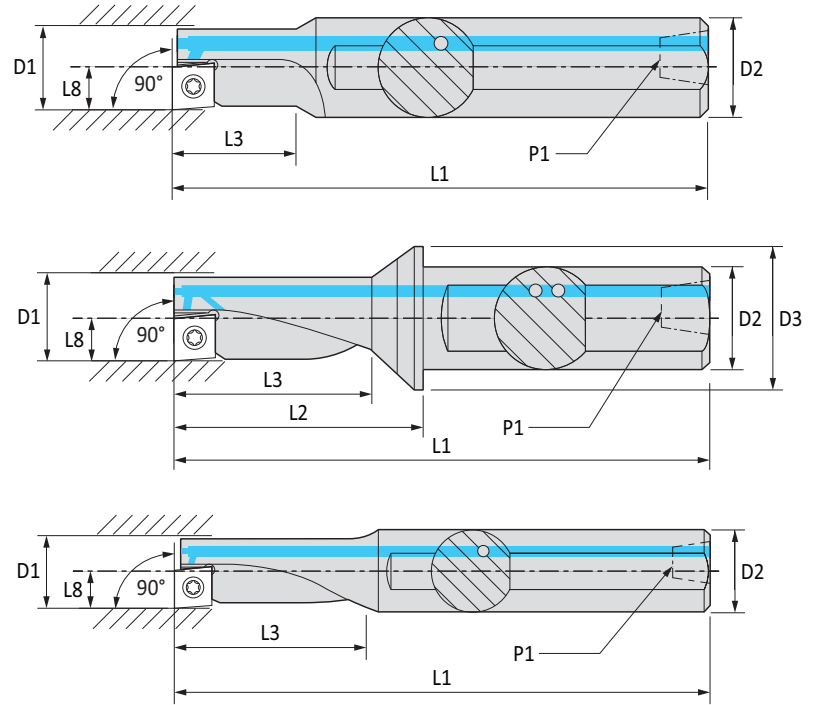

Left hand tools shown



Cutting Action	Body					Shank			Part No.	Description	Insert 	Screw 	Driver 	
	D1	L2	L3	L8	L1	D2	D3	P1						
i	Left	0.551	-	0.83	0.276	4.33	0.625	-	1/8" -27 NPT	11065075	EC 14L-1.5D 07-E	XC.. 0703..	11684216	11206195
	Left	0.551	1.520	1.24	0.276	3.27	0.625	0.787	1/8" -27 NPT	11065207	EC 14L-2.25D 07-E	XC.. 0703..	11684216	11206195
	Left	0.551	-	1.65	0.276	3.94	0.625	-	1/8" -27 NPT	11147314	EC 14L-3.0D 07 H-E	XC.. 0703..	11684216	11206195
	Right	0.551	-	0.83	0.276	4.33	0.625	-	1/8" -27 NPT	11065076	EC 14R-1.5D 07-E	XC.. 0703..	11684216	11206195
	Right	0.551	1.520	1.24	0.276	3.27	0.625	0.787	1/8" -27 NPT	11065228	EC 14R-2.25D 07-E	XC.. 0703..	11684216	11206195
	Right	0.551	-	1.65	0.276	3.94	0.625	-	1/8" -27 NPT	11147330	EC 14R-3.0D 07 H-E	XC.. 0703..	11684216	11206195
m	Left	14	-	21	7	110	16	-	-	11837888	EC 14L-1.5D 07	XC.. 0703..	11684216	11206195
	Left	14	38.5	31.5	7	83.5	16	20	-	11837920	EC 14L-2.25D 07	XC.. 0703..	11684216	11206195
	Left	14	-	42	7	100	16	-	-	11837996	EC 14L-3.0D 07 H	XC.. 0703..	11684216	11206195
	Right	14	-	21	7	110	16	-	-	11837890	EC 14R-1.5D 07	XC.. 0703..	11684216	11206195
	Right	14	38.5	31.5	7	83.5	16	20	-	11837921	EC 14R-2.25D 07	XC.. 0703..	11684216	11206195
	Right	14	-	42	7	100	16	-	-	11837999	EC 14R-3.0D 07 H	XC.. 0703..	11684216	11206195

NOTE: Cutting action refers to whether the tool is left handed or right handed.
NOTE: Holder shipped with 3 insert clamping screws. Inserts and hand drivers sold separately.

Key on 1

22 - 23



30 - 33



18 - 20



21



i = Imperial (in)
 m = Metric (mm)

Holders are supplied with 3 insert clamping screws. Inserts and insert drivers sold separately.

EcoCut Classic

16mm Tools

A DRILLING



1.50xD

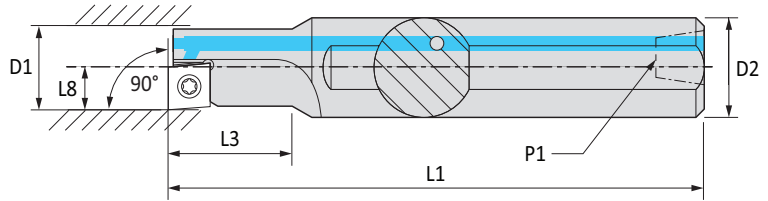

B BORING



2.25xD

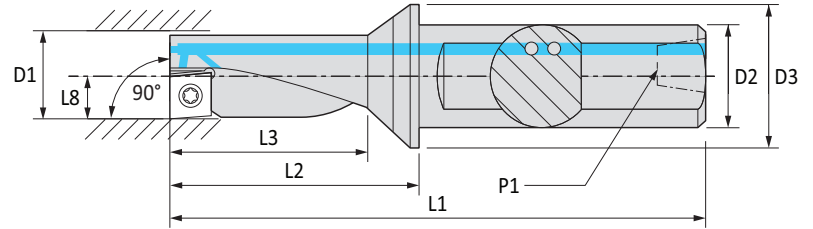

C REAMING



3.00xD

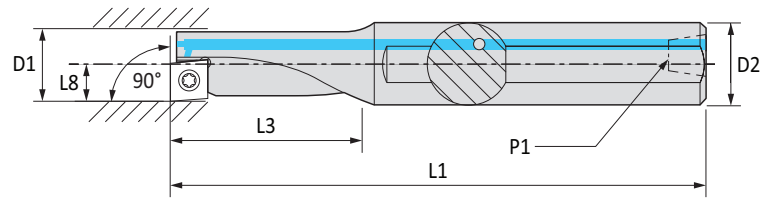

Left hand tools shown

Cutting Action	Body					Shank			Part No.	Description	Insert	Screw	Driver
	D1	L2	L3	L8	L1	D2	D3	P1					
Left	0.630	-	0.94	0.315	4.92	0.750	-	1/8" -27 NPT	11065077	EC 16L-1.5D 08-E	XC.. 0803..	11227305	11843208
Left	0.630	1.730	1.42	0.315	3.73	0.750	0.984	1/8" -27 NPT	11065230	EC 16L-2.25D 08-E	XC.. 0803..	11227305	11843208
Left	0.630	-	1.89	0.315	4.33	0.750	-	1/8" -27 NPT	11147316	EC 16L-3.0D 08 H-E	XC.. 0803..	11227305	11843208
Right	0.630	-	0.94	0.315	4.92	0.750	-	1/8" -27 NPT	11065098	EC 16R-1.5D 08-E	XC.. 0803..	11227305	11843208
Right	0.630	1.730	1.42	0.315	3.73	0.750	0.984	1/8" -27 NPT	11065231	EC 16R-2.25D 08-E	XC.. 0803..	11227305	11843208
Right	0.630	-	1.89	0.315	4.33	0.750	-	1/8" -27 NPT	11147332	EC 16R-3.0D 08 H-E	XC.. 0803..	11227305	11843208
i													
Left	16	-	24	8	125	20	-	-	11837891	EC 16L-1.5D 08	XC.. 0803..	11227305	11843208
Left	16	44	36	8	94	20	25	-	11837922	EC 16L-2.25D 08	XC.. 0803..	11227305	11843208
Left	16	-	48	8	110	20	-	-	11838000	EC 16L-3.0D 08 H	XC.. 0803..	11227305	11843208
Right	16	-	24	8	125	20	-	-	11837893	EC 16R-1.5D 08	XC.. 0803..	11227305	11843208
Right	16	44	36	8	94	20	25	-	11837923	EC 16R-2.25D 08	XC.. 0803..	11227305	11843208
Right	16	-	48	8	110	20	-	-	11838001	EC 16R-3.0D 08 H	XC.. 0803..	11227305	11843208
m													

NOTE: Cutting action refers to whether the tool is left handed or right handed.
NOTE: Holder shipped with 3 insert clamping screws. Inserts and hand drivers sold separately.

F THREADING

X SPECIALS



i = Imperial (in)
m = Metric (mm)

HOLDERS ARE SUPPLIED WITH 3 INSERT CLAMPING SCREWS.
 INSERTS AND INSERT DRIVERS SOLD SEPARATELY.

EcoCut Classic

18mm Tools



1.50xD





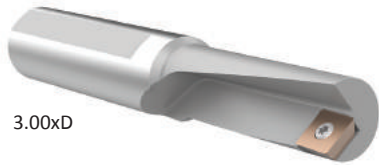

2.25xD

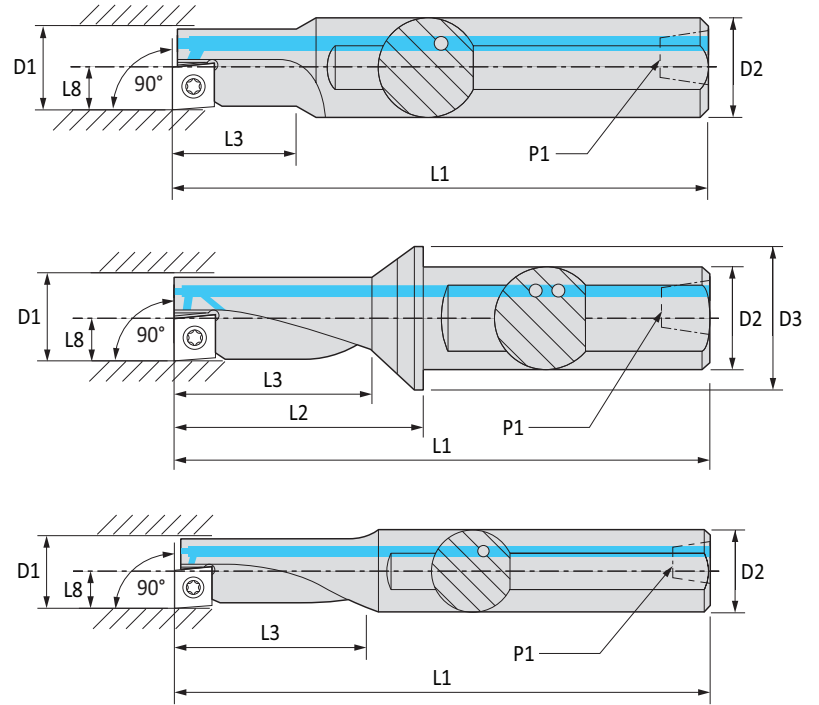

3.00xD

Left hand tools shown



Cutting Action	Body					Shank			Part No.	Description	Insert 	Screw 	Driver 	
	D1	L2	L3	L8	L1	D2	D3	P1						
i	Left	0.709	-	1.06	0.354	5.31	1.000	-	1/4" -18 NPT	11065099	EC 18L-1.5D 09-E	XC.. 09T3..	11227305	11843208
	Left	0.709	2.110	1.59	0.354	4.36	1.000	1.260	1/4" -18 NPT	11065232	EC 18L-2.25D 09-E	XC.. 09T3..	11227305	11843208
	Left	0.709	-	2.12	0.354	5.04	1.000	-	1/4" -18 NPT	11147318	EC 18L-3.0D 09 H-E	XC.. 09T3..	11227305	11843208
	Right	0.709	-	1.06	0.354	5.31	1.000	-	1/4" -18 NPT	11065100	EC 18R-1.5D 09-E	XC.. 09T3..	11227305	11843208
	Right	0.709	2.110	1.59	0.354	4.36	1.000	1.260	1/4" -18 NPT	11065233	EC 18R-2.25D 09-E	XC.. 09T3..	11227305	11843208
	Right	0.709	-	2.12	0.354	5.04	1.000	-	1/4" -18 NPT	11147333	EC 18R-3.0D 09 H-E	XC.. 09T3..	11227305	11843208
m	Left	18	-	27	9	135	25	-	-	11837894	EC 18L-1.5D 09	XC.. 09T3..	11227305	11843208
	Left	18	53.5	40.5	9	109.5	25	32	-	11837924	EC 18L-2.25D 09	XC.. 09T3..	11227305	11843208
	Left	18	-	54	9	125	25	-	-	11838002	EC 18L-3.0D 09 H	XC.. 09T3..	11227305	11843208
	Right	18	-	27	9	135	25	-	-	11837897	EC 18R-1.5D 09	XC.. 09T3..	11227305	11843208
	Right	18	53.5	40.5	9	109.5	25	32	-	11837926	EC 18R-2.25D 09	XC.. 09T3..	11227305	11843208
	Right	18	-	54	9	125	25	-	-	11838003	EC 18R-3.0D 09 H	XC.. 09T3..	11227305	11843208

NOTE: Cutting action refers to whether the tool is left handed or right handed.
NOTE: Holder shipped with 3 insert clamping screws. Inserts and hand drivers sold separately.

Key on 1

22 - 23



30 - 33



18 - 20



21



i = Imperial (in)
 m = Metric (mm)

Holders are supplied with 3 insert clamping screws. Inserts and insert drivers sold separately.

A DRILLING
 B BORING
 C REAMING
 D BURNISHING
 E THREADING
 X SPECIALS

EcoCut Classic

20mm Tools

A DRILLING
B BORING
C REAMING
D BURNISHING
E THREADING
X SPECIALS

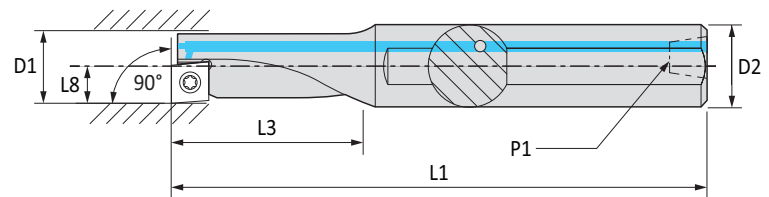
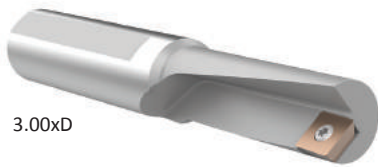
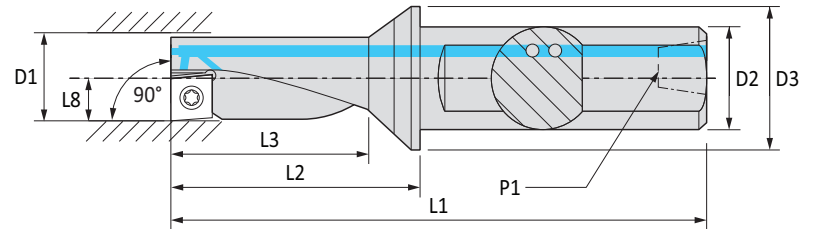
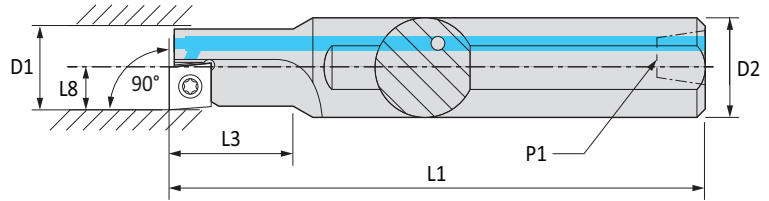

Left hand tools shown

Cutting Action	Body					Shank			Part No.	Description	Insert	Screw	Driver	
	D1	L2	L3	L8	L1	D2	D3	P1						
i	Left	0.787	-	1.18	0.394	5.91	1.000	-	1/4" -18 NPT	11065101	EC 20L-1.5D 10-E	XC.. 10T3..	11610311	11450858
	Left	0.787	2.170	1.77	0.394	4.42	1.000	1.260	1/4" -18 NPT	11065234	EC 20L-2.25D 10-E	XC.. 10T3..	11610311	11450858
	Left	0.787	-	2.36	0.394	5.12	1.000	-	1/4" -18 NPT	11147321	EC 20L-3.0D 10 H-E	XC.. 10T3..	11610311	11450858
	Right	0.787	-	1.18	0.394	5.91	1.000	-	1/4" -18 NPT	11065102	EC 20R-1.5D 10-E	XC.. 10T3..	11610311	11450858
	Right	0.787	2.170	1.77	0.394	4.42	1.000	1.260	1/4" -18 NPT	11065235	EC 20R-2.25D 10-E	XC.. 10T3..	11610311	11450858
	Right	0.787	-	2.36	0.394	5.12	1.000	-	1/4" -18 NPT	11147334	EC 20R-3.0D 10 H-E	XC.. 10T3..	11610311	11450858
m	Left	20	-	30	10	150	25	-	-	11837899	EC 20L-1.5D 10	XC.. 10T3..	11610311	11450858
	Left	20	55	45	10	111	25	32	-	11837927	EC 20L-2.25D 10	XC.. 10T3..	11610311	11450858
	Left	20	-	60	10	130	25	-	-	11838017	EC 20L-3.0D 10 H	XC.. 10T3..	11610311	11450858
	Right	20	-	30	10	150	25	-	-	11837903	EC 20R-1.5D 10	XC.. 10T3..	11610311	11450858
	Right	20	55	45	10	111	25	32	-	11837928	EC 20R-2.25D 10	XC.. 10T3..	11610311	11450858
	Right	20	-	60	10	130	25	-	-	11838019	EC 20R-3.0D 10 H	XC.. 10T3..	11610311	11450858

NOTE: Cutting action refers to whether the tool is left handed or right handed.
NOTE: Holder shipped with 3 insert clamping screws. Inserts and hand drivers sold separately.



i = Imperial (in)
 m = Metric (mm)
 Holders are supplied with 3 insert clamping screws.
 Inserts and insert drivers sold separately.

EcoCut Classic

25mm Tools



1.50xD





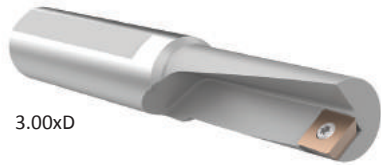

2.25xD

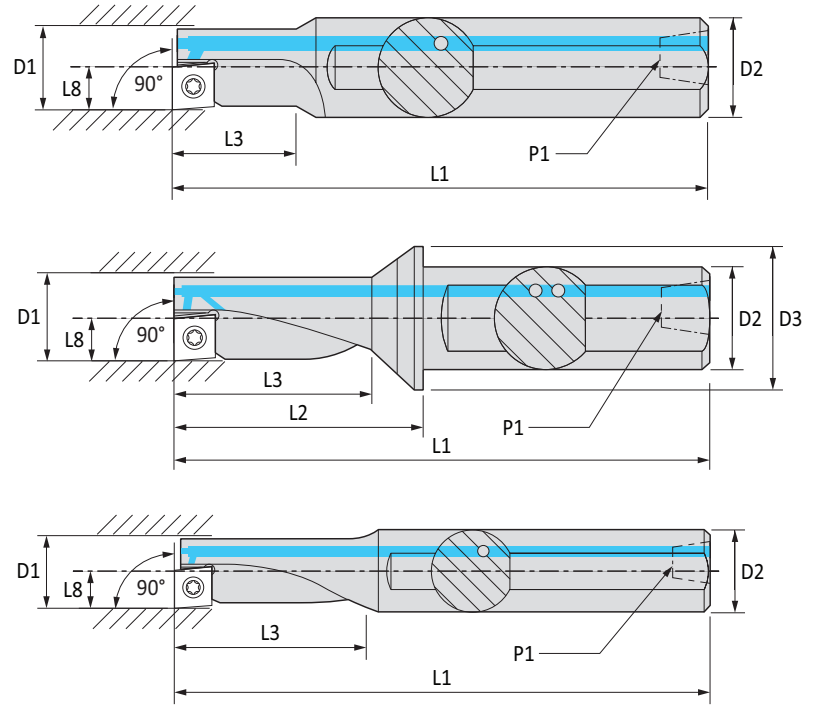

3.00xD

Left hand tools shown



Cutting Action	Body					Shank			Part No.	Description	Insert 	Screw 	Driver 	
	D1	L2	L3	L8	L1	D2	D3	P1						
i	Left	0.984	-	1.48	0.492	7.09	1.250	-	1/4" -18 NPT	11065103	EC 25L-1.5D 13-E	XC.. 1304..	11801441	11816974
	Left	0.984	2.715	2.22	0.492	5.09	1.250	1.575	1/4" -18 NPT	11065236	EC 25L-2.25D 13-E	XC.. 1304..	11801441	11816974
	Left	0.984	-	2.95	0.492	5.91	1.250	-	1/4" -18 NPT	11147323	EC 25L-3.0D 13 H-E	XC.. 1304..	11801441	11816974
	Right	0.984	-	1.48	0.492	7.09	1.250	-	1/4" -18 NPT	11065105	EC 25R-1.5D 13-E	XC.. 1304..	11801441	11816974
	Right	0.984	2.715	2.22	0.492	5.09	1.250	1.575	1/4" -18 NPT	11065238	EC 25R-2.25D 13-E	XC.. 1304..	11801441	11816974
	Right	0.984	-	2.95	0.492	5.91	1.250	-	1/4" -18 NPT	11147335	EC 25R-3.0D 13 H-E	XC.. 1304..	11801441	11816974
m	Left	25	-	37.5	12.5	180	32	-	-	11837905	EC 25L-1.5D 13	XC.. 1304..	11801441	11816974
	Left	25	69	56.5	12.5	129	32	40	-	11837930	EC 25L-2.25D 13	XC.. 1304..	11801441	11816974
	Left	25	-	75	12.5	150	32	-	-	11838021	EC 25L-3.0D 13 H	XC.. 1304..	11801441	11816974
	Right	25	-	37.5	12.5	180	32	-	-	11837908	EC 25R-1.5D 13	XC.. 1304..	11801441	11816974
	Right	25	69	56.5	12.5	129	32	40	-	11837931	EC 25R-2.25D 13	XC.. 1304..	11801441	11816974
	Right	25	-	75	12.5	150	32	-	-	11838022	EC 25R-3.0D 13 H	XC.. 1304..	11801441	11816974

NOTE: Cutting action refers to whether the tool is left handed or right handed.
NOTE: Holder shipped with 3 insert clamping screws. Inserts and hand drivers sold separately.

Key on 1

22 - 23

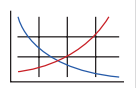

30 - 33



18 - 20



21



i = Imperial (in)
 m = Metric (mm)

Holders are supplied with 3 insert clamping screws. Inserts and insert drivers sold separately.

EcoCut Classic

32mm Tools

A DRILLING



1.50xD

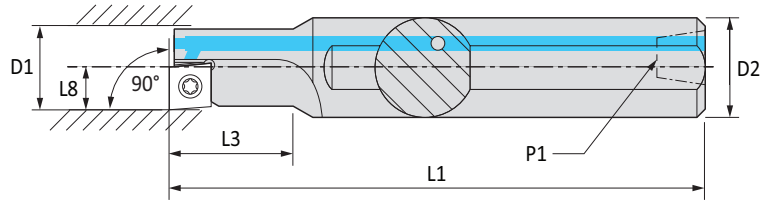

B BORING



2.25xD

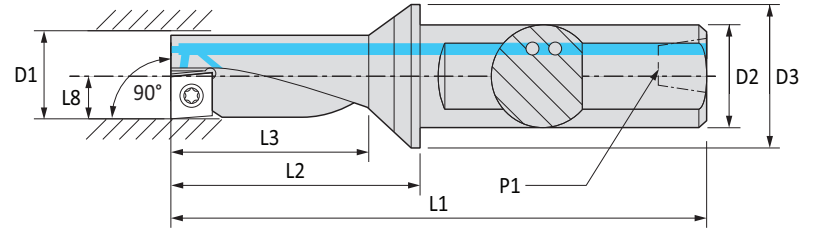

C REAMING

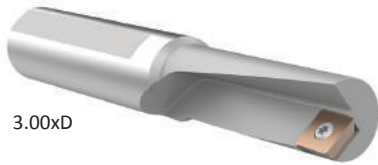

3.00xD

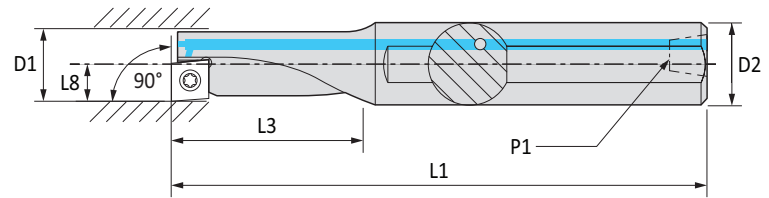

Left hand tools shown

Cutting Action	Body					Shank			Part No.	Description	Insert	Screw	Driver
	D1	L2	L3	L8	L1	D2	D3	P1					
Left	1.260	-	1.89	0.630	7.87	1.500	-	1/4" -18 NPT	11065106	EC 32L-1.5D 17-E	XC.. 1705..	11801441	11816974
Left	1.260	3.460	2.83	0.630	6.21	1.500	1.969	1/4" -18 NPT	11065239	EC 32L-2.25D 17-E	XC.. 1705..	11801441	11816974
Left	1.260	-	3.78	0.630	7.28	1.500	-	1/4" -18 NPT	11147324	EC 32L-3.0D 17 H-E	XC.. 1705..	11801441	11816974
Right	1.260	-	1.89	0.630	7.87	1.500	-	1/4" -18 NPT	11065107	EC 32R-1.5D 17-E	XC.. 1705..	11801441	11816974
Right	1.260	3.460	2.83	0.630	6.21	1.500	1.969	1/4" -18 NPT	11065240	EC 32R-2.25D 17-E	XC.. 1705..	11801441	11816974
Right	1.260	-	3.78	0.630	7.28	1.500	-	1/4" -18 NPT	11147334	EC 32R-3.0D 17 H-E	XC.. 1705..	11801441	11816974
Left	32	-	48	16	200	40	-	-	11837909	EC 32L-1.5D 17	XC.. 1705..	11801441	11816974
Left	32	88	72	16	158	40	50	-	11837937	EC 32L-2.25D 17	XC.. 1705..	11801441	11816974
Left	32	-	96	16	185	40	-	-	11838023	EC 32L-3.0D 17 H	XC.. 1705..	11801441	11816974
Right	32	-	48	16	200	40	-	-	11837910	EC 32R-1.5D 17	XC.. 1705..	11801441	11816974
Right	32	88	72	16	158	40	50	-	11837988	EC 32R-2.25D 17	XC.. 1705..	11801441	11816974
Right	32	-	96	16	185	40	-	-	11838025	EC 32R-3.0D 17 H	XC.. 1705..	11801441	11816974

NOTE: Cutting action refers to whether the tool is left handed or right handed.
NOTE: Holder shipped with 3 insert clamping screws. Inserts and hand drivers sold separately.

D BURNISHING

F THREADING

X SPECIALS

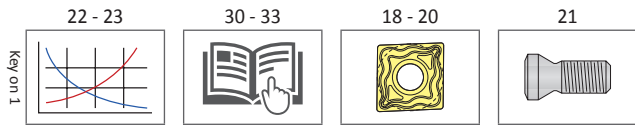

i = Imperial (in)
m = Metric (mm)

HOLDERS ARE SUPPLIED WITH 3 INSERT CLAMPING SCREWS.
 INSERTS AND INSERT DRIVERS SOLD SEPARATELY.



EcoCut Rebore

Diameter Range: 40.00mm - 60.00mm

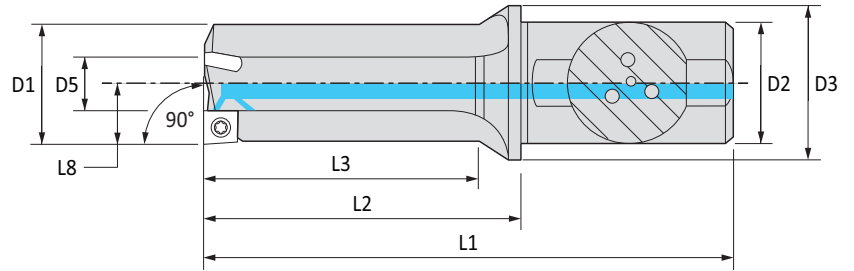

Right hand tool shown



Cutting Action	Body						Shank		Part No.*	Description	Insert			
	D1	D5	L2	L3	L8	L1	D2	D3						
Ⓜ	Left	40	20	105	90	20	175	40	50	11108233	ECR 4020L03-2.25D 10	XC.. 10T3..	11610311	11450858
	Right	40	20	105	90	20	175	40	50	11108235	ECR 4020R03-2.25D 10	XC.. 10T3..	11610311	11450858
	Left	60	32	162	135	30	232	40	70	11108234	ECR 6032L03-2.25D 17	XC.. 1705..	11801441	11816914
	Right	60	32	162	135	30	232	40	70	11108236	ECR 6032R03-2.25D 17	XC.. 1705..	11801441	11816914

***Discontinued. Subject to prior sale.**

NOTE: Cutting action refers to whether the tool is left handed or right handed.

Key on 1

22 - 23



30 - 33



18 - 20



21



Ⓜ = Imperial (in)
Ⓜ = Metric (mm)

A DRILLING
B BORING
C REAMING
D BURNISHING
E THREADING
X SPECIALS

EcoCut Inserts

04 and 05

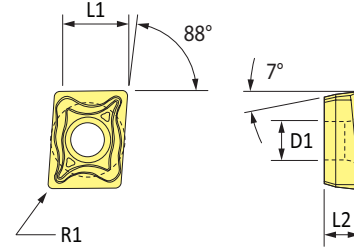
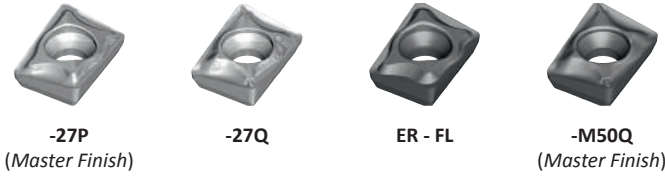

Size	Description	Grade	Cutting Action	Insert					Part No.	P	S	M	H	K	N
				D1	L1	L2	R1	D2		Steel	Heat Resistant	Stainless	Hard Materials	Cast Iron	Non-Ferrous
XC...0401...	XCET 040102FL-27P	H216T	Left	0.177	0.157	0.071	0.008	0.083	11078744					○	●
	XCET 040102FL-27Q	H210T	Left	0.177	0.157	0.071	0.008	0.083	11215226		●	○		○	●
	XCET 040102FR-27P	H216T	Right	0.177	0.157	0.071	0.008	0.083	11078745					○	●
	XCET 040102FR-27Q	H210T	Right	0.177	0.157	0.071	0.008	0.083	11215241		●	○		○	●
	XCNT 040102EL	CTC1425	Left	0.177	0.157	0.071	0.008	0.083	11821270	●		○		●	
	XCNT 040102EL	CTCP435	Left	0.177	0.157	0.071	0.008	0.083	11821661	●		○		●	
	XCNT 040102EL	CTCP430	Left	0.177	0.157	0.071	0.008	0.083	11820940	●	●	●		○	○
	XCNT 040102ER	CTPP425	Right	0.177	0.157	0.071	0.008	0.083	11821277	●		○		●	
	XCNT 040102ER	CTCP435	Right	0.177	0.157	0.071	0.008	0.083	11821676	●		○		●	
	XCNT 040102ER	CTPP430	Right	0.177	0.157	0.071	0.008	0.083	11820944	●	●	●		○	○
	XCET 040104FL-27P	H216T	Left	0.177	0.157	0.071	0.016	0.083	11002560					○	●
	XCET 040104FL-27Q	H210T	Left	0.177	0.157	0.071	0.016	0.083	11215229		●	○		○	●
	XCET 040104FR-27P	H216T	Right	0.177	0.157	0.071	0.016	0.083	11038512					○	●
	XCET 040104FR-27Q	H210T	Right	0.177	0.157	0.071	0.016	0.083	11215243		●	○		○	●
	XCNT 040104EL	CTCP425	Left	0.177	0.157	0.071	0.016	0.083	11821278	●		○		●	
	XCNT 040104EL	CTCP435	Left	0.177	0.157	0.071	0.016	0.083	11821678	●		○		●	
XCNT 040104EL	CTPP430	Left	0.177	0.157	0.071	0.016	0.083	11820956	●	●	●		○	○	
XCNT 040104EL-M50Q	CTCP425	Left	0.177	0.157	0.071	0.016	0.083	11838065	●		○		●		
XCNT 040104ER	CTCP425	Right	0.177	0.157	0.071	0.016	0.083	11821283	●		○		●		
XCNT 040104ER	CTCP435	Right	0.177	0.157	0.071	0.016	0.083	11821681	●		○		●		
XCNT 040104ER	CTPP430	Right	0.177	0.157	0.071	0.016	0.083	11820970	●	●	●		○	○	
XCNT 040104ER-M50Q	CTCP425	Right	0.177	0.157	0.071	0.016	0.083	11838386	●		○		●		
XC...0502...	XCET 050202FN-27P	H216T	Left/Right	0.228	0.197	0.083	0.008	0.089	11078798					○	●
	XCET 050202FN-27Q	H210T	Left/Right	0.228	0.197	0.083	0.008	0.089	11215250		●	○		○	●
	XCNT 050202EN	CTCP425	Left/Right	0.228	0.197	0.083	0.008	0.089	11821288	●		○		●	
	XCNT 050202EN	CTCP435	Left/Right	0.228	0.197	0.083	0.008	0.089	11821687	●	●	●		○	○
	XCNT 050202EN	CTPP430	Left/Right	0.228	0.197	0.083	0.008	0.089	11820986	●		○		●	
	XCET 050204FN-27P	H216T	Left/Right	0.228	0.197	0.083	0.016	0.089	11038705					○	●
	XCET 050204FN-27Q	H210T	Left/Right	0.228	0.197	0.083	0.016	0.089	11215256		●	○		○	●
	XCNT 050204EN	CTCP425	Left/Right	0.228	0.197	0.083	0.016	0.089	11821618	●		○		●	
	XCNT 050204EN	CTCP435	Left/Right	0.228	0.197	0.083	0.016	0.089	11821905	●	●	●		○	○
	XCNT 050204EN	CTPP430	Left/Right	0.228	0.197	0.083	0.016	0.089	11820995	●		○		●	
XCNT 050204EN-M50Q	CTCP425	Left/Right	0.228	0.197	0.083	0.016	0.089	11838388	●		○		●		

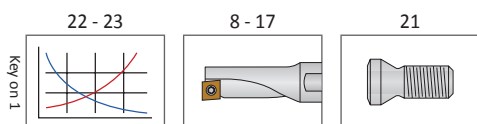

EcoCut Inserts

06, 07, 08, and 09

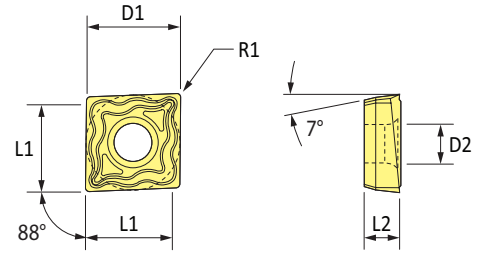
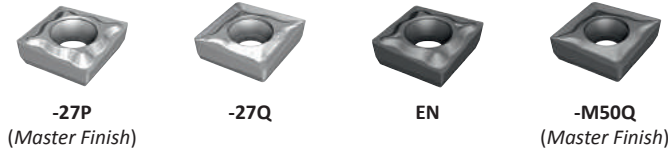

Size	Description	Grade	Cutting Action	Insert					Part No.	P	S	M	H	K	N
				D1	L1	L2	R1	D2		Steel	Heat Resistant	Stainless	Hard Materials	Cast Iron	Non-Ferrous
XC...0602...	XCET 060202FN-27P	H216T	Left/Right	0.256	0.236	0.094	0.008	0.098	11078799					○	●
	XCET 060202FN-27Q	H210T	Left/Right	0.256	0.236	0.094	0.008	0.098	11214549		●	○		○	●
	XCNT 060202EN	CTCP425	Left/Right	0.256	0.236	0.094	0.008	0.098	11821622	●		○		○	●
	XCNT 060202EN	CTCP435	Left/Right	0.256	0.236	0.094	0.008	0.098	11821912	●	●	●		○	○
	XCNT 060202EN	CTPP430	Left/Right	0.256	0.236	0.094	0.008	0.098	11821184	●		○		●	
	XCET 060204FN-27P	H216T	Left/Right	0.256	0.236	0.094	0.016	0.098	11038706					○	●
	XCET 060204FN-27Q	H210T	Left/Right	0.256	0.236	0.094	0.016	0.098	11214551		●	○		○	●
	XCNT 060204EN	CTCP425	Left/Right	0.256	0.236	0.094	0.016	0.098	11821624	●		○		●	
	XCNT 060204EN	CTCP435	Left/Right	0.256	0.236	0.094	0.016	0.098	11821914	●		○		●	
	XCNT 060204EN	CTPP430	Left/Right	0.256	0.236	0.094	0.016	0.098	11821189	●	●	●		○	○
XCNT 060204EN-M50Q	CTCP425	Left/Right	0.256	0.236	0.094	0.016	0.098	11838393	●		○		●		
XC...0703...	XCET 070304FN-27P	H216T	Left/Right	0.299	0.276	0.125	0.016	0.110	11038707					○	●
	XCET 070304FN-27Q	H210T	Left/Right	0.299	0.276	0.125	0.016	0.110	11214569		●	○		○	●
	XCNT 070304EN	CTCP425	Left/Right	0.299	0.276	0.125	0.016	0.110	11821625	●		○		○	●
	XCNT 070304EN	CTCP435	Left/Right	0.299	0.276	0.125	0.016	0.110	11821920	●	●	●		○	○
	XCNT 070304EN	CTPP430	Left/Right	0.299	0.276	0.125	0.016	0.110	11821203	●		○		●	
XCNT 070304EN-M50Q	CTCP425	Left/Right	0.299	0.276	0.125	0.016	0.110	11838406	●		○		●		
XC...0803...	XCET 080304FN-27P	H216T	Left/Right	0.335	0.315	0.125	0.016	0.134	11002562					○	●
	XCET 080304FN-27Q	H210T	Left/Right	0.335	0.315	0.125	0.016	0.134	11210378		●	○		○	●
	XCNT 080304EN	CTCP425	Left/Right	0.335	0.315	0.125	0.016	0.134	11821629	●		○		○	●
	XCNT 080304EN	CTCP435	Left/Right	0.335	0.315	0.125	0.016	0.134	11821923	●	●	●		○	○
	XCNT 080304EN	CTPP430	Left/Right	0.335	0.315	0.125	0.016	0.134	11821204	●		○		●	
	XCNT 080304EN-M50Q	CTCP425	Left/Right	0.335	0.315	0.125	0.016	0.134	11838408	●		○		●	
XC...09T3...	XCET 09T304FN-27P	H216T	Left/Right	0.378	0.354	0.156	0.016	0.134	11038881					○	●
	XCET 09T304FN-27Q	H210T	Left/Right	0.378	0.354	0.156	0.016	0.134	11210380		●	○		○	●
	XCNT 09T304EN	CTCP425	Left/Right	0.378	0.354	0.156	0.016	0.134	11821635	●		○		○	●
	XCNT 09T304EN	CTCP435	Left/Right	0.378	0.354	0.156	0.016	0.134	11821928	●	●	●		○	○
	XCNT 09T304EN	CTPP430	Left/Right	0.378	0.354	0.156	0.016	0.134	11821210	●		○		●	
XCNT 09T304EN-M50Q	CTCP425	Left/Right	0.378	0.354	0.156	0.016	0.134	11838413	●		○		●		

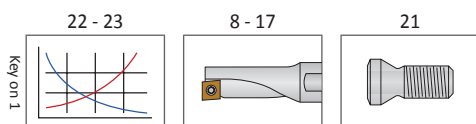

A DRILLING
B BORING
C REAMING
D BURNISHING
E THREADING
X SPECIALS

EcoCut Inserts

10, 13, and 17

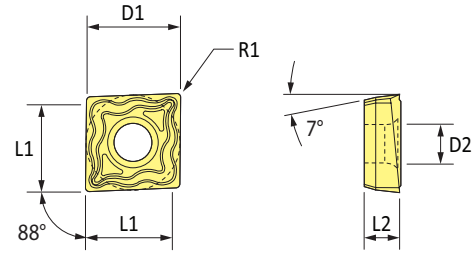
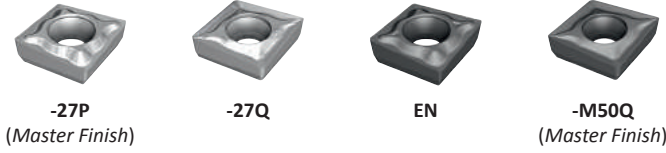

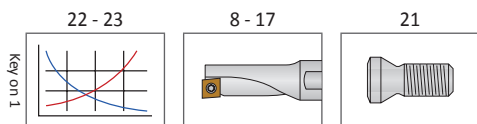

Size	Description	Grade	Cutting Action	Insert					Part No.	P	S	M	H	K	N
				D1	L1	L2	R1	D2		Steel	Heat Resistant	Stainless	Hard Materials	Cast Iron	Non-Ferrous
XC...10T3...	XCET 10T308FN-27P	H216T	Left/Right	0.417	0.394	0.156	0.016	0.173	11038878					○	●
	XCET 10T308FN-27Q	H210T	Left/Right	0.417	0.394	0.156	0.016	0.173	11161897		●	○		○	●
	XCNT 10T304EN	CTCP425	Left/Right	0.417	0.394	0.156	0.016	0.173	11821640	●		○		●	
	XCNT 10T304EN	CTCP435	Left/Right	0.417	0.394	0.156	0.016	0.173	11821931	●	●	●		○	○
	XCNT 10T304EN	CTPP430	Left/Right	0.417	0.394	0.156	0.016	0.173	11821225	●		○		●	
	XCNT 10T304EN-M50Q	CTCP425	Left/Right	0.417	0.394	0.156	0.016	0.173	11838418	●		○		●	
	XCET 10T308FN-27P	H216T	Left/Right	0.417	0.394	0.156	0.031	0.173	11078800					○	●
	XCET 10T308FN-27Q	H210T	Left/Right	0.417	0.394	0.156	0.031	0.173	11161900		●	○		○	●
	XCNT 10T308EN	CTCP425	Left/Right	0.417	0.394	0.156	0.031	0.173	11821647	●		○		●	
	XCNT 10T308EN	CTCP435	Left/Right	0.417	0.394	0.156	0.031	0.173	11821946	●		○		●	
XC...1304...	XCNT 10T308EN	CTPP430	Left/Right	0.417	0.394	0.156	0.031	0.173	11821229	●	●	●		○	○
	XCNT 10T308EN-M50Q	CTCP425	Left/Right	0.417	0.394	0.156	0.031	0.173	11838432	●		○		●	
	XCET 130404FN-27P	H216T	Left/Right	0.531	0.492	0.187	0.016	0.209	11002564					○	●
	XCET 130404FN-27Q	H210T	Left/Right	0.531	0.492	0.187	0.016	0.209	11161904		●	○		○	●
	XCNT 130404EN	CTCP425	Left/Right	0.531	0.492	0.187	0.016	0.209	11821695	●		○		●	
	XCNT 130404EN	CTCP435	Left/Right	0.531	0.492	0.187	0.016	0.209	11821950	●	●	●		○	○
	XCNT 130404EN	CTPP430	Left/Right	0.531	0.492	0.187	0.016	0.209	11821230	●		○		●	
	XCNT 130404EN-M50Q	CTCP425	Left/Right	0.531	0.492	0.187	0.016	0.209	11838442	●		○		●	
	XCET 130408FN-27P	H216T	Left/Right	0.531	0.492	0.187	0.031	0.209	11078801					○	●
	XCET 130408FN-27Q	H210T	Left/Right	0.531	0.492	0.187	0.031	0.209	11161907		●	○		○	●
XC...1705...	XCNT 130408EN	CTCP425	Left/Right	0.531	0.492	0.187	0.031	0.209	11821656	●		○		●	
	XCNT 130408EN	CTCP435	Left/Right	0.531	0.492	0.187	0.031	0.209	11821952	●	●	●		○	○
	XCNT 130408EN	CTPP430	Left/Right	0.531	0.492	0.187	0.031	0.209	11821233	●		○		●	
	XCNT 130408EN-M50Q	CTCP425	Left/Right	0.531	0.492	0.187	0.031	0.209	11838444	●		○		●	
	XCET 170508FN-27P	H216T	Left/Right	0.689	0.630	0.219	0.031	0.209	11038879					○	●
	XCET 170508FN-27Q	H210T	Left/Right	0.689	0.630	0.219	0.031	0.209	11161908		●	○		○	●
	XCNT 170508EN	CTCP425	Left/Right	0.689	0.630	0.219	0.031	0.209	11821658	●		○		●	
	XCNT 170508EN	CTCP435	Left/Right	0.689	0.630	0.219	0.031	0.209	11821953	●	●	●		○	○
	XCNT 170508EN	CTPP430	Left/Right	0.689	0.630	0.219	0.031	0.209	11821239	●		○		●	
	XCNT 170508EN-M50Q	CTCP425	Left/Right	0.689	0.630	0.219	0.031	0.209	11838446	●		○		●	





Accessories

Insert Drivers and Screws

Drivers

	Part No.	Description	Key Size
	11843205	TORX 06IP	Torx® Plus 6IP
	11488748	TORX 07IP	Torx® Plus 7IP
	11206195	TORX 08IP	Torx® Plus 8IP
	11843208	TORX 09IP	Torx® Plus 9IP
	11450858	TORX 15IP	Torx® Plus 15IP
	11816974	TORX 20IP	Torx® Plus 20IP

Screws

	Part No.	Description	Length (mm)	Thread Size	Key Size	Recommended Tightening Torque in-lbs (Nm)
	11807484	M1.8x3.6-06IP	3.6	M1.8	Torx® Plus 6IP	3.6 (0.4)
	11087480	M2.0x4.3-06IP	4.3	M2.0	Torx® Plus 6IP	6.2 (0.7)
	11684214	M2.2x5.0-07IP	5.0	M2.2	Torx® Plus 7IP	8.9 (1.0)
	11684216	M2.5x6.0-08IP	6.0	M2.5	Torx® Plus 8IP	10.6 (1.2)
	11227305	M3.0x7.0-09IP	7.0	M3.0	Torx® Plus 9IP	19.5 (2.2)
	11610311	M3.5x8.6-15IP	8.6	M3.5	Torx® Plus 15IP	28.3 (3.2)
	11801441	M5.5x10.5-20IP	10.5	M4.5	Torx® Plus 20IP	44.4 (5.0)
	310720	M8x1x8 DIN913	8	M8	4mm	-

Screws are sold in quantities of 10.

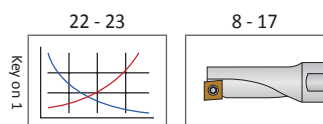

Recommended Cutting Data | Imperial (inch)

EcoCut

ISO	Material	Hardness (BHN)	Type of Treatment / Alloy	
P	Low and Medium Carbon Steel	125	Annealed	≤ 0.15% C
		150 - 250	Annealed	0.15% - 0.45% C
		300	Tempered	≥ 0.45% C
	Alloy Steel	180	Annealed	
		250 - 300	Tempered	
		350	Tempered	
High Strength Alloy	200	Annealed		
	350	Tempered		
S	Heat Resistant Alloys	200		Fe-base
		280		Fe-base
		250		Ni or Co-base
		-		Ni or Co-base 30 - 58 HRC
		-		Ni or Co-base 1500 - 2000 N/mm ²
	Titanium Alloy	R _m 440*		Pure Titanium
	R _m 1050*		Alpha + Beta Alloys	
M	Stainless Steel	200	Annealed	Ferritic / Martensitic
		180	Quenched	Austenitic
		230 - 260	Quenched	Duplex
		330	Hardened	Martensitic / Austenitic
H	Tempered Steel	55 HRC	Hardened and Tempered	
		60 HRC	Hardened and Tempered	
	Chilled Castings	400	Cast	
White Cast Iron	55 HRC	Hardened and Tempered		
K	Grey Cast Iron	180		Perlitic / Ferritic
		260		Perlitic / Martensitic
	Ductile Cast Iron	160		Ferritic
		-		Perlitic
	Tempered Iron	130		Ferritic
230			Perlitic	
N	Aluminum Wrought Alloys	60	Non-hardened	
		100	Hardened	
	Aluminum Cast Alloys	80	Non-hardened	< 12% Si
		90	Hardened	< 12% Si
		130	Non-hardened	< 12% Si
	Copper and Copper Alloys (Bronze, Brass)	-		Machining Alloy Stock (1% Pb)
		-		Brass, Red Bronze
90			Bronze	
100			Lead-free Copper and Electrolytic Copper	
Non-metal Materials	100		Thermosetting Plastics	
	-		Fiber Reinforced Plastics	
	-		Hard Rubber	

IMPORTANT: The speeds and feeds listed on these pages are a general starting point for all applications. Factory technical assistance is available through our Application Engineering department. Please call 1.330.343.4283 x7611 or email appeng@alliedmachine.com.

A
DRILLING
B
BORING
C
REAMING
D
BURNISHING
E
THREADING
X
SPECIALS

EcoCut Mini		Speed (v _c SFM)				
		EcoCut Classic				
CTWN 425	CTPP 435	H210T	H216T	CTCP 425	CTPP 430	CTCP 435
-	200 - 750	-	-	490 - 985	390 - 820	460 - 920
-	200 - 525	-	-	400 - 720	260 - 590	330 - 650
-	160 - 430	-	-	330 - 650	200 - 525	260 - 590
-	200 - 525	-	-	400 - 720	260 - 590	330 - 650
-	160 - 430	-	-	330 - 590	200 - 490	260 - 525
-	160 - 330	-	-	260 - 490	200 - 430	230 - 460
-	200 - 460	-	-	360 - 625	260 - 560	330 - 590
-	130 - 330	-	-	230 - 490	160 - 430	200 - 460
80 - 130	65 - 165	115 - 165	100 - 150	-	65 - 300	65 - 165
65 - 100	65 - 130	80 - 130	65 - 115	-	65 - 300	65 - 130
65 - 100	50 - 65	80 - 130	65 - 115	-	65 - 300	50 - 65
50 - 80	30 - 65	65 - 100	50 - 80	-	65 - 300	30 - 65
50 - 80	30 - 65	50 - 80	50 - 80	-	65 - 300	30 - 65
100 - 330	165 - 400	260 - 460	100 - 330	-	130 - 330	165 - 400
80 - 200	100 - 165	130 - 330	80 - 200	-	100 - 300	100 - 165
-	130 - 650	-	-	390 - 720	160 - 525	330 - 650
-	130 - 590	-	-	330 - 650	160 - 590	330 - 590
-	130 - 330	-	-	-	160 - 430	-
-	130 - 260	-	-	-	160 - 400	-
-	-	-	-	-	-	-
-	-	-	-	-	-	-
-	-	-	-	-	-	-
-	-	-	-	-	-	-
260 - 460	330 - 590	460 - 650	390 - 525	430 - 920	400 - 650	400 - 820
200 - 400	260 - 525	330 - 525	300 - 460	430 - 920	330 - 590	400 - 820
295 - 490	330 - 590	525 - 650	430 - 560	390 - 920	400 - 650	360 - 820
200 - 360	260 - 525	360 - 490	300 - 430	390 - 920	330 - 590	360 - 820
330 - 590	330 - 650	525 - 720	460 - 650	360 - 920	300 - 525	330 - 820
260 - 460	295 - 525	460 - 590	390 - 525	360 - 920	230 - 490	330 - 820
260 - 6500	260 - 6500	400 - 9850	330 - 8200	-	260 - 6500	260 - 6500
260 - 4900	260 - 4900	400 - 8200	330 - 6550	-	260 - 4900	260 - 4900
260 - 4900	260 - 4900	400 - 6550	330 - 4900	-	260 - 4900	260 - 4900
260 - 4250	260 - 4250	400 - 5900	330 - 4900	-	260 - 4250	260 - 4250
260 - 1970	260 - 1970	400 - 3280	330 - 2625	-	260 - 1970	260 - 1970
260 - 1310	260 - 1310	400 - 2625	330 - 1970	-	260 - 1310	260 - 1310
260 - 1310	260 - 1310	400 - 2625	330 - 1970	-	260 - 1310	260 - 1310
260 - 985	260 - 985	400 - 1970	330 - 1310	-	260 - 985	260 - 985
260 - 650	260 - 650	400 - 1310	330 - 985	-	260 - 650	260 - 650
200 - 525	200 - 525	295 - 720	260 - 590	-	200 - 525	200 - 525
165 - 460	165 - 460	260 - 650	200 - 490	-	165 - 460	165 - 450
260 - 650	260 - 650	390 - 985	330 - 820	-	260 - 650	260 - 650

Depth of Cut / Feed Rate

EcoCut Mini

Drilling Feed Rate (IPR)

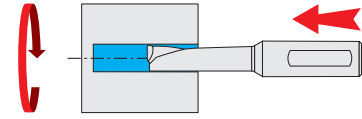

2.25xD

4.00xD

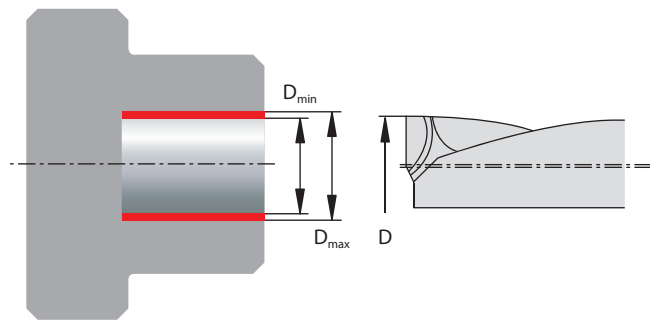
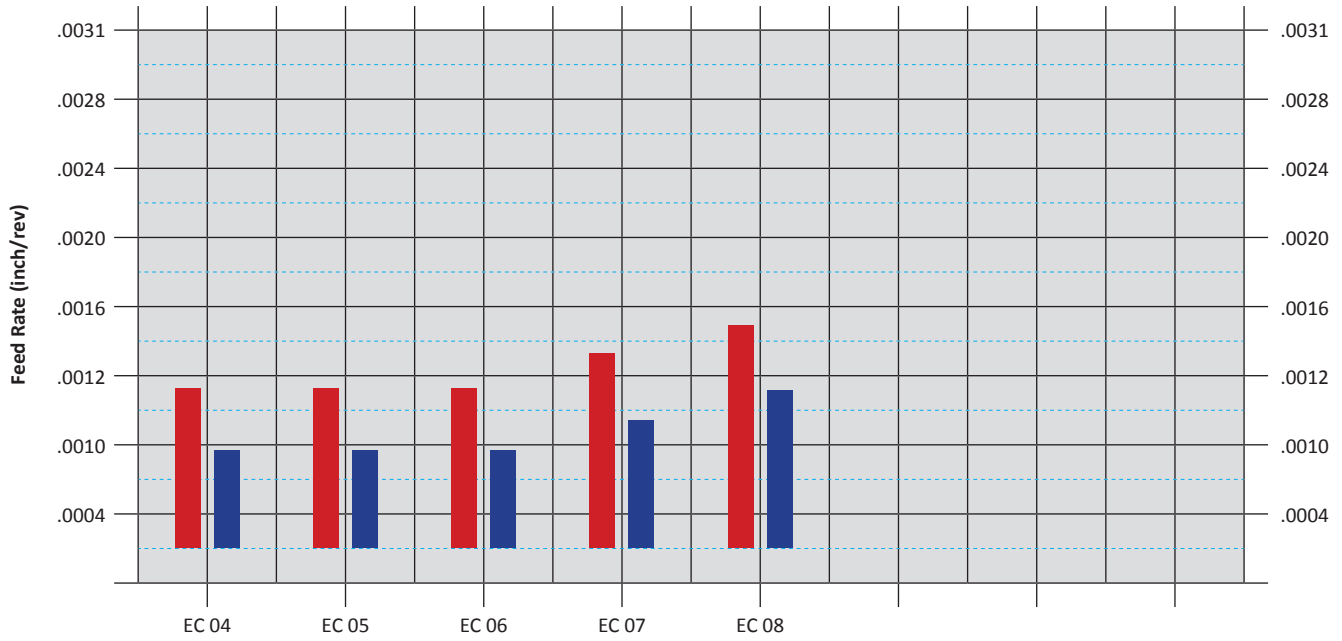
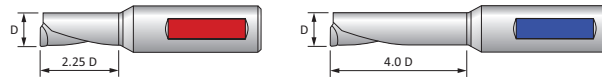

Off-Center Drilling

Off-center drilling is possible due to the special construction of EcoCut tools and inserts. Because of this, the desired deviations from the tool's nominal diameter can be obtained (see table below).

EcoCut Mini	Nominal Tools	Workpiece Bore Diameter	
	D (inch)	D _{min} (inch)	D _{max} (inch)
ECM 04 L/R - 2.25D	0.157	0.154	0.165
ECM 05 L/R - 2.25D	0.197	0.193	0.205
ECM 06 L/R - 2.25D	0.236	0.232	0.244
ECM 07 L/R - 2.25D	0.276	0.272	0.283
ECM 08 L/R - 2.25D	0.315	0.311	0.323

Depth of Cut / Feed Rate

EcoCut Mini

Facing Feed Rate (IPR)

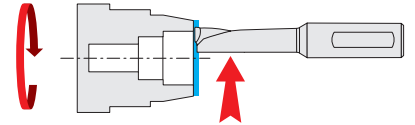

EcoCut Mini	Length Ratio	Depth of Cut (inch)				
		up to .0079	.008-.0157	0.0158-.0236	.0237-.0315	.0316-.0394
EC04	2.25	.0003 - .0028	.0003 - .0028	.0003 - .0028	-	-
	4.00	.0003 - .0020	.0003 - .0020	.0003 - .0020	-	-
EC05	2.25	.0003 - .0028	.0003 - .0028	.0003 - .0028	-	-
	4.00	.0003 - .0020	.0003 - .0020	.0003 - .0020	-	-
EC06	2.25	.0003 - .0028	.0003 - .0028	.0003 - .0028	-	-
	4.00	.0003 - .0020	.0003 - .0020	.0003 - .0020	-	-
EC07	2.25	.0003 - .0031	.0003 - .0031	.0003 - .0031	.0003 - .0031	.0003 - .0031
	4.00	.0003 - .0023	.0003 - .0023	.0003 - .0023	.0003 - .0023	.0003 - .0023
EC08	2.25	.0003 - .0031	.0003 - .0031	.0003 - .0031	.0003 - .0031	.0003 - .0031
	4.00	.0003 - .0023	.0003 - .0023	.0003 - .0023	.0003 - .0023	.0003 - .0023

Turning / Boring Feed Rate (IPR)

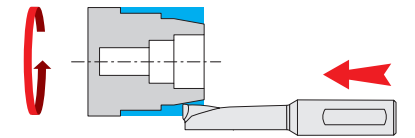

EcoCut Mini	Length Ratio	Depth of Cut (inch)			
		up to .039	.040-.079	.080-.118	.119-.157
EC04	2.25	.0002 - .0039	.0002 - .0020	-	-
	4.00	.0002 - .0031	-	-	-
EC05	2.25	.0002 - .0039	.0002 - .0024	-	-
	4.00	.0002 - .0035	.0002 - .0016	-	-
EC06	2.25	.0002 - .0039	.0002 - .0032	.0002 - .0016	-
	4.00	.0002 - .0035	.0002 - .0016	-	-
EC07	2.25	.0002 - .0039	.0002 - .0039	.0002 - .0024	-
	4.00	.0002 - .0039	.0002 - .0023	-	-
EC08	2.25	.0002 - .0039	.0002 - .0039	.0002 - .0032	.0002 - .0016
	4.00	.0002 - .0039	.0002 - .0031	.0002 - .0016	-

Depth of Cut / Feed Rate

EcoCut Classic

Drilling Feed Rate (IPR)

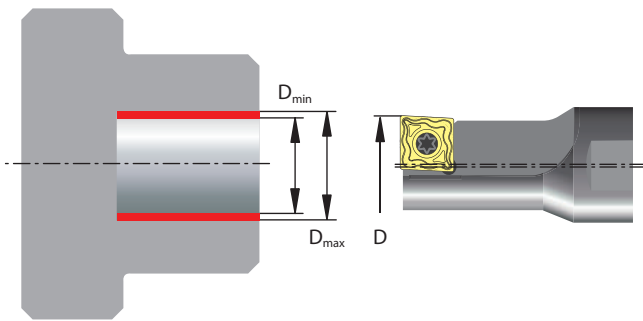
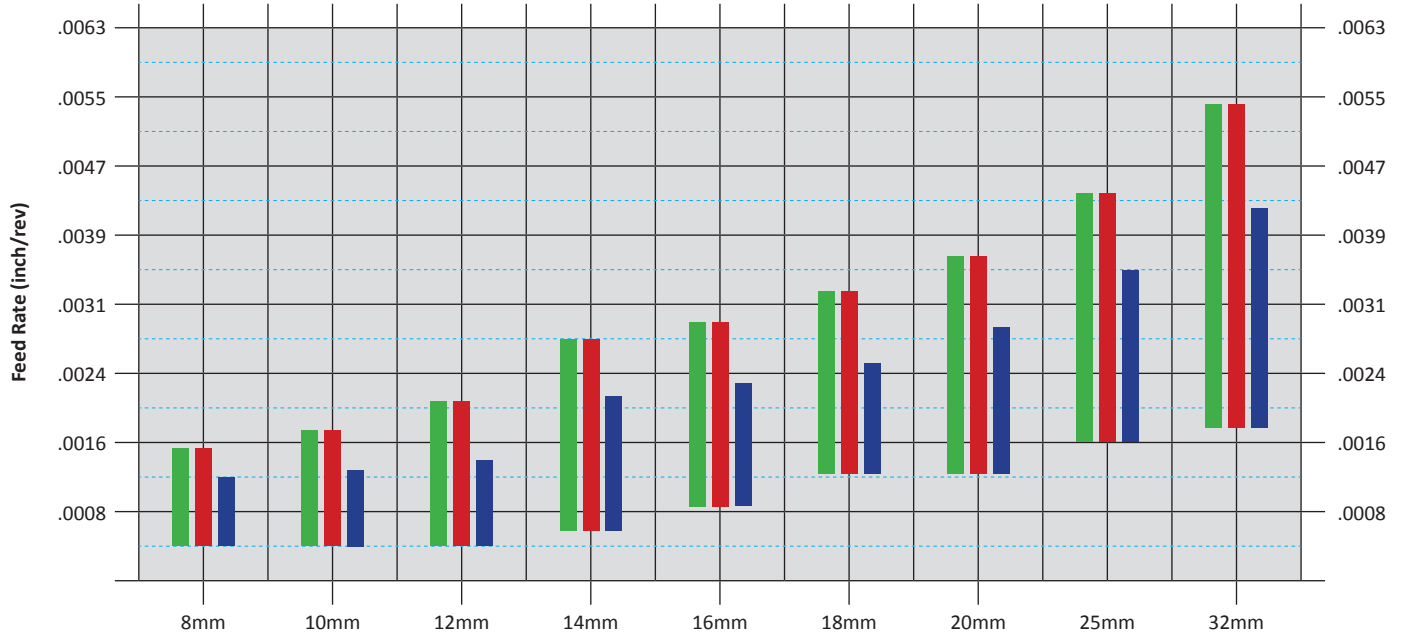
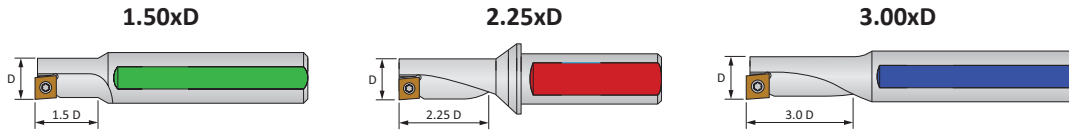
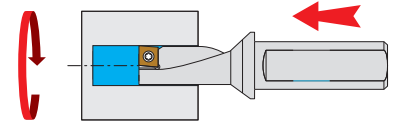

Off-Center Drilling

Off-center drilling is possible due to the special construction of EcoCut tools and inserts. Because of this, the desired deviations from the tool's nominal diameter can be obtained (see table below).

EcoCut Classic	Nominal Tools	Workpiece Bore Diameter	
	D (inch)	D _{min} (inch)	D _{max} (inch)
ECC 08 L/R - ... 04	0.315	0.309	0.327
ECC 10 L/R - ... 05	0.394	0.388	0.413
ECC 12 L/R - ... 06	0.472	0.467	0.492
ECC 14 L/R - ... 07	0.551	0.542	0.571
ECC 16 L/R - ... 08	0.630	0.624	0.650
ECC 18 L/R - ... 09	0.709	0.703	0.728
ECC 20 L/R - ... 10	0.787	0.780	0.807
ECC 25 L/R - ... 13	0.984	0.976	1.016
ECC 32 L/R - ... 17	1.260	1.252	1.299

Depth of Cut / Feed Rate

EcoCut Classic

Facing Feed Rate (IPR)

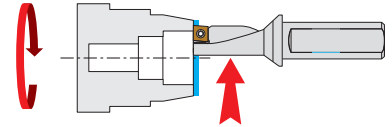

EcoCut Classic	Length Ratio	Depth of Cut (inch)						
		up to .039	.040-.079	.080-.118	.119-.157	.158-.197	.198-.236	.237-.315
8mm	1.50	.0005 - .0037	.0005 - .0037	-	-	-	-	-
	2.25	.0005 - .0037	.0005 - .0037	-	-	-	-	-
	3.00	.0005 - .0030	-	-	-	-	-	-
10mm	1.50	.0005 - .0050	.0005 - .0050	-	-	-	-	-
	2.25	.0005 - .0050	.0005 - .0050	-	-	-	-	-
	3.00	.0005 - .0037	-	-	-	-	-	-
12mm	1.50	.0005 - .0058	.0005 - .0058	-	-	-	-	-
	2.25	.0005 - .0058	.0005 - .0058	-	-	-	-	-
	3.00	.0005 - .0045	-	-	-	-	-	-
14mm	1.50	.0005 - .0065	.0005 - .0065	-	-	-	-	-
	2.25	.0005 - .0065	.0005 - .0065	.0005 - .0065	-	-	-	-
	3.00	.0005 - .0047	-	-	-	-	-	-
16mm	1.50	.0005 - .0073	.0005 - .0073	.0005 - .0073	.0005 - .0073	-	-	-
	2.25	.0005 - .0073	.0005 - .0073	.0005 - .0073	-	-	-	-
	3.00	.0005 - .0062	.0005 - .0062	-	-	-	-	-
18mm	1.50	.0005 - .0080	.0005 - .0080	.0005 - .0080	.0005 - .0080	-	-	-
	2.25	.0005 - .0080	.0005 - .0080	.0005 - .0080	.0005 - .0080	-	-	-
	3.00	.0005 - .0055	.0005 - .0055	-	-	-	-	-
20mm	1.50	.0005 - .0088	.0005 - .0088	.0005 - .0088	.0005 - .0088	-	-	-
	2.25	.0005 - .0085	.0005 - .0085	.0005 - .0085	.0005 - .0085	-	-	-
	3.00	.0005 - .0085	.0005 - .0085	-	-	-	-	-
25mm	1.50	.0005 - .0100	.0005 - .0100	.0005 - .0100	-	-	-	-
	2.25	.0005 - .0095	.0005 - .0095	.0005 - .0095	.0005 - .0095	.0005 - .0095	-	-
	3.00	.0005 - .0073	.0005 - .0073	.0005 - .0073	-	-	-	-
32mm	1.50	.0005 - .0110	.0005 - .0110	.0005 - .0110	.0005 - .0110	.0005 - .0110	.0005 - .0110	.0005 - .0110
	2.25	.0005 - .0108	.0005 - .0108	.0005 - .0108	.0005 - .0108	.0005 - .0108	.0005 - .0108	-
	3.00	.0005 - .0080	.0005 - .0080	.0005 - .0080	-	-	-	-

Depth of Cut / Feed Rate

EcoCut Classic

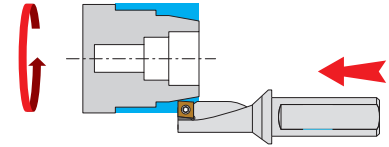

Turning / Boring Feed Rate (IPR)

EcoCut Classic	Length Ratio	Depth of Cut (inch)						
		up to .079	.080-.157	.158-.236	.237-.315	.316-.394	.395-.472	.473-.551
8mm	1.50	.0005 - .0050	.0005 - .0030	-	-	-	-	-
	2.25	.0008 - .0052	.0008 - .0040	-	-	-	-	-
	3.00	.0008 - .0052	.0008 - .0040	-	-	-	-	-
10mm	1.50	.0005 - .0060	.0005 - .0035	-	-	-	-	-
	2.25	.0008 - .0060	.0008 - .0052	.0008 - .0035	-	-	-	-
	3.00	.0008 - .0060	.0008 - .0052	.0008 - .0035	-	-	-	-
12mm	1.50	.0005 - .0065	.0005 - .0055	.0005 - .0040	-	-	-	-
	2.25	.0008 - .0065	.0008 - .0065	.0008 - .0050	.0008 - .0040	-	-	-
	3.00	.0008 - .0065	.0008 - .0065	.0008 - .0050	.0008 - .0040	-	-	-
14mm	1.50	.0007 - .0073	.0007 - .0073	.0007 - .0050	-	-	-	-
	2.25	.0009 - .0072	.0009 - .0072	.0009 - .0058	.0009 - .0045	-	-	-
	3.00	.0009 - .0072	.0009 - .0072	.0009 - .0058	.0009 - .0045	-	-	-
16mm	1.50	.0007 - .0080	.0007 - .0080	.0007 - .0060	.0007 - .0040	-	-	-
	2.25	.0010 - .0080	.0010 - .0080	.0010 - .0070	.0010 - .0055	-	-	-
	3.00	.0010 - .0080	.0010 - .0080	.0010 - .0070	.0010 - .0055	-	-	-
18mm	1.50	.0008 - .0087	.0008 - .0087	.0008 - .0080	.0008 - .0060	-	-	-
	2.25	.0010 - .0085	.0010 - .0085	.0010 - .0080	.0010 - .0065	.0010 - .0050	-	-
	3.00	.0010 - .0085	.0010 - .0085	.0010 - .0080	.0010 - .0065	.0010 - .0050	-	-
20mm	1.50	.0008 - .0095	.0008 - .0095	.0008 - .0090	.0008 - .0075	.0008 - .0060	-	-
	2.25	.0010 - .0095	.0010 - .0095	.0010 - .0095	.0010 - .0080	.0010 - .0065	-	-
	3.00	.0010 - .0095	.0010 - .0095	.0010 - .0095	.0010 - .0080	.0010 - .0065	-	-
25mm	1.50	.0009 - .0105	.0009 - .0105	.0009 - .0105	.0009 - .0095	.0009 - .0080	.0009 - .0063	-
	2.25	.0010 - .0105	.0010 - .0105	.0010 - .0105	.0010 - .0105	.0010 - .0085	.0010 - .0070	-
	3.00	.0010 - .0105	.0010 - .0105	.0010 - .0105	.0010 - .0105	.0010 - .0085	.0010 - .0070	-
32mm	1.50	.0010 - .0120	.0010 - .0120	.0010 - .0120	.0010 - .0120	.0010 - .0103	.0010 - .0088	.0010 - .0073
	2.25	.0010 - .0120	.0010 - .0120	.0010 - .0120	.0010 - .0120	.0010 - .0110	.0010 - .0085	.0010 - .0080
	3.00	.0010 - .0120	.0010 - .0120	.0010 - .0120	.0010 - .0120	.0010 - .0110	.0010 - .0085	.0010 - .0080

Depth of Cut / Feed Rate

EcoCut Rebore

Turning and Boring Feed Rate (IPR)

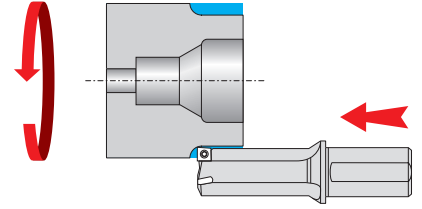

Part No.	Depth of Cut (inch)						
	Up to 0.079	0.08 - 0.157	0.158 - 0.197	0.198 - 0.315	0.316 - 0.394	0.395 - 0.472	0.473 - 0.551
ECR 40..	.0010 - .0160	.0010 - .0150	.0010 - .0120	.0010 - .0090	-	-	-
ECR 60..	.0010 - .0160	.0010 - .0160	.0010 - .0150	.0010 - .0130	.0010 - .0100	.0010 - .0075	.0010 - .0050

Facing Feed Rate (IPR)

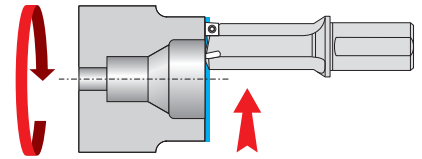

Part No.	Depth of Cut (inch)					
	up to 0.020	0.021 - 0.040	0.041 - 0.060	0.061 - 0.080	0.081 - 0.100	0.101 - 0.120
ECR 40..	.0005 - .0120	.0005 - .0120	.0005 - .0120	.0005 - .0120	-	-
ECR 60..	.0005 - .0120	.0005 - .0120	.0005 - .0120	.0005 - .0120	.0005 - .0120	.0005 - .0120

Counterboring (Existing Hole) Feed Rate (IPR)

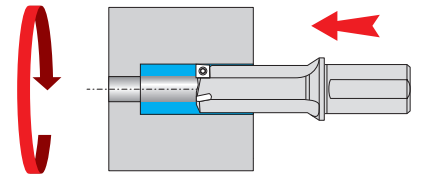

Part No.	Existing Hole Diameter (inch)			
	0.797 - 1.180	1.181 - 1.260	1.261 - 1.968	1.969 - 2.363
ECR 40..	.002 - .016	.002 - .035	-	-
ECR 60..	-	-	.002 - .030	.002 - .045

	Tools	Initial Bore
	ECR 40..	∅ min = .797"
	ECR 60..	∅ min = 1.260"

Application Recommendations

A

DRILLING



Mounting the Insert

- For tools \varnothing 8mm, right-hand or left-hand inserts are required.
- For tools \varnothing 10 -32mm, inserts are neutral and work for left or right handed tools.
- Insert has molded arrow to designate the cutting corner.

B

BORING



Through Hole

- With through holes, a **sharp-edged disk** is created as tool break-out occurs.
- ⚠ Proper personal protective equipment must be used to prevent injury (e.g. wear cut-resistant gloves).

C

REAMING

D

BURNISHING

Axial Displacement of the Machine

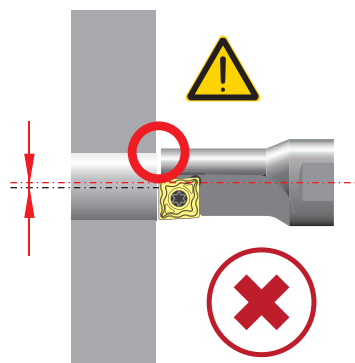

Displacement in x-axis

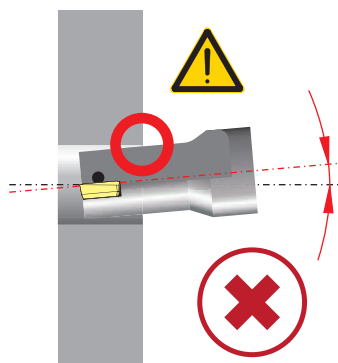

Angular error

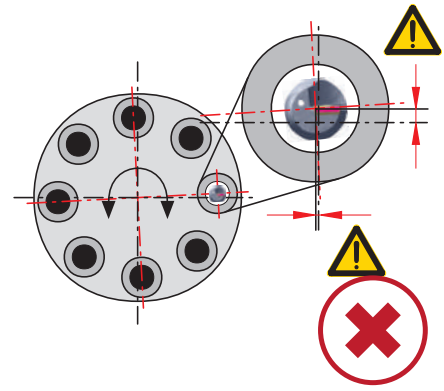

Turret position error



Solution:

Make adjustments or realign turret for proper tool positioning.

E

THREADING

X

SPECIALS

Application Recommendations

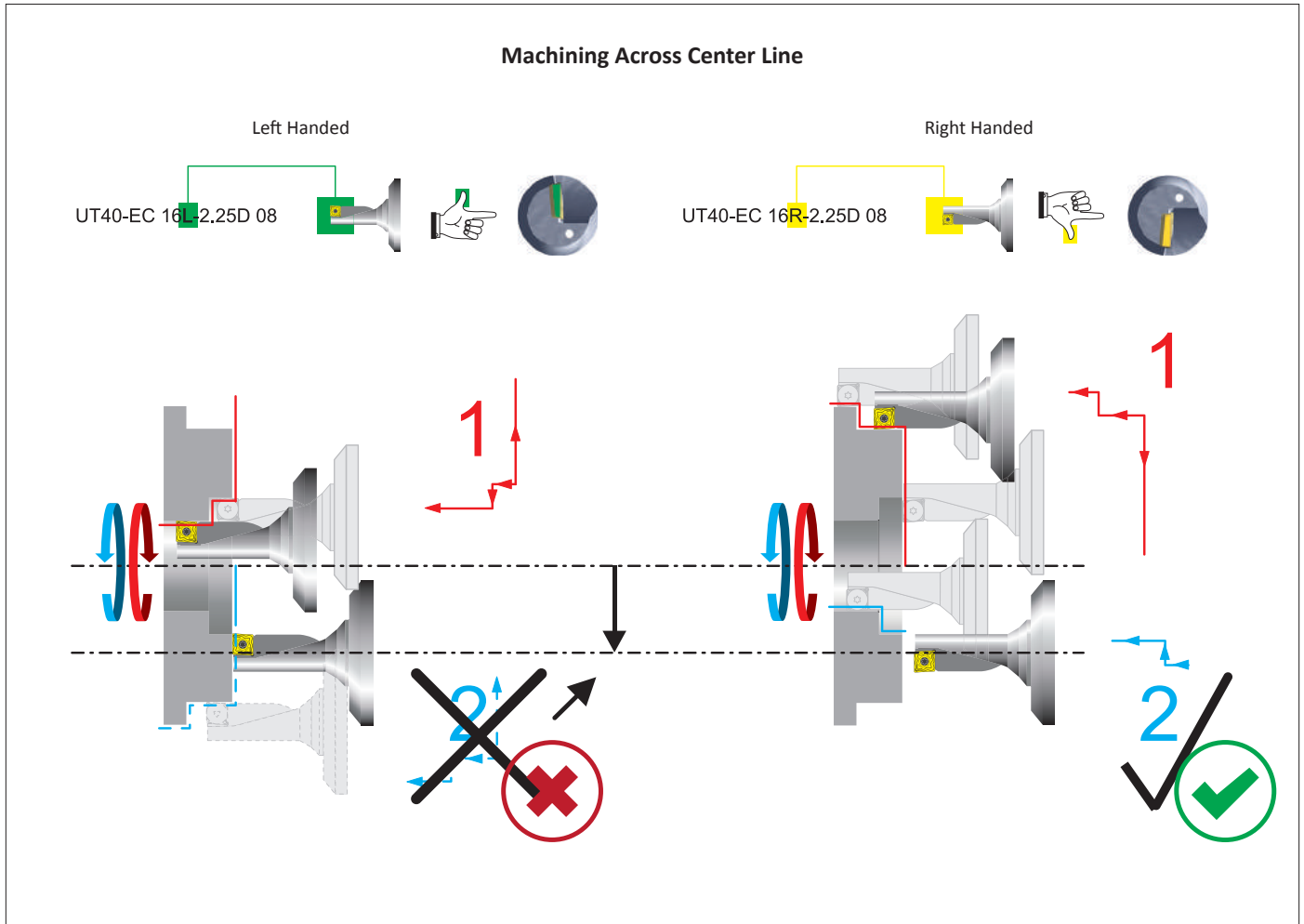

Situation:

In case of insufficient movement of the machine across the center line, the external diameter cannot be machined with the same tool.

Solution:

Use a right-hand EcoCut tool.

A
DRILLING
B
BORING
C
REAMING
D
BURNISHING
E
THREADING
X
SPECIALS

Application Recommendations

A DRILLING
B BORING
C REAMING
D BURNISHING
E THREADING
X SPECIALS

Chip Booster / Coolant Pressure

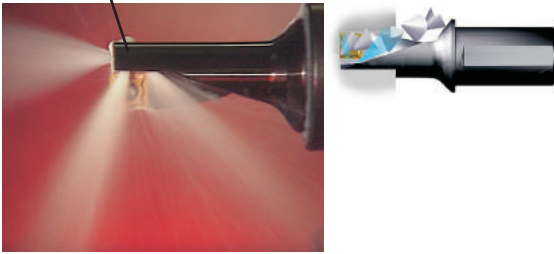
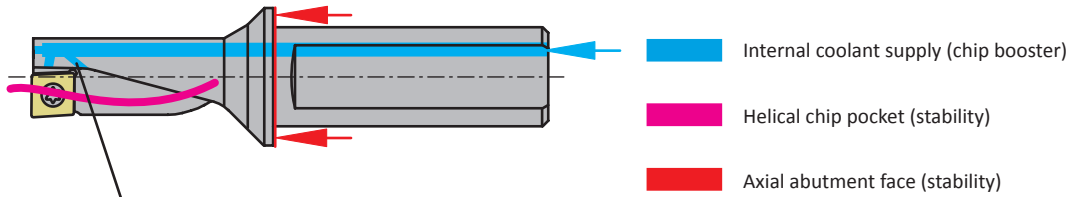

EcoCut offers an innovative detail solution for **range 2.25D**, namely additional bidirectional coolant supply for better chip evacuation. An additional **backwards directed coolant stream** improves chip transportation from the flute area. Minimum coolant pressure required 22 - 44 psi.

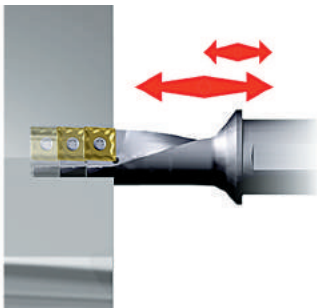

If the necessary coolant pressure is not available, it can be advantageous to interrupt the cutting action in order to clear the bore.

Deep Bores up to 3xD

With a stepped bore approach, EcoCut tools EC...1.5D can be machined with holes of up to three times the nominal diameter (see picture). Operation sequences 1, 2, and 3, respectively, should be followed.

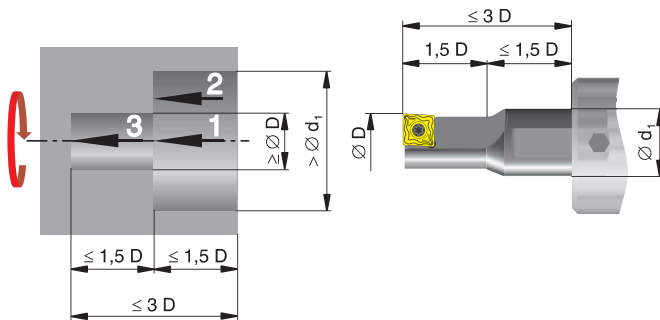

Application Recommendations

The Advantages of DENSIMET Compared to Steel

The new generation of EcoCut 3.00D series with the new designation offers maximized performance. The tools are classified with the new designation **ECC..R/L-3.0D..H** and have particularly been developed for bigger drilling depths and maximum precision requirements. The material used is DENSIMET, a PLANSEE tungsten heavy metal alloy. The high modulus of elasticity as well as density give this alloy very good vibration-dampening properties. The result is high precision, excellent surface quality, and improved tool life.

Material	Nominal Tool \varnothing	
	Modulus of Elasticity (N/mm ²)	Density (g/mm ³)
Steel	210 000	7.85
DENSIMET	360 000	17.50

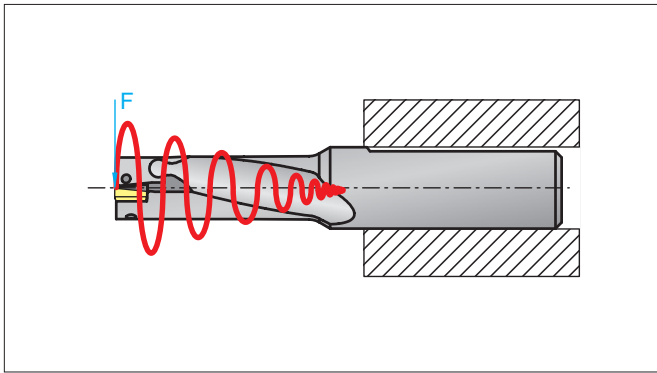

Vibration-dampening

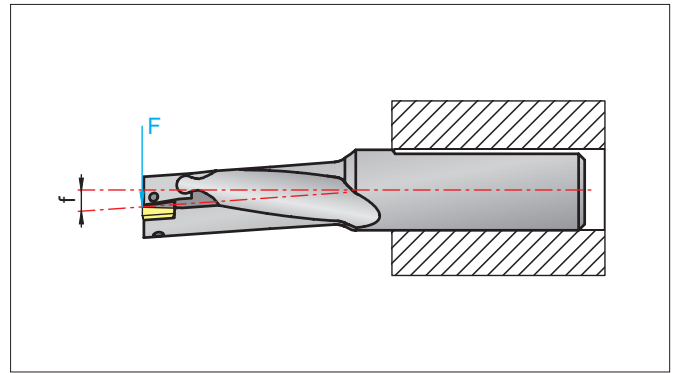

40% lower deflection than steel

The New Chip Flute Design

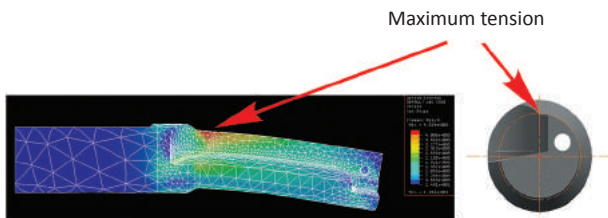

Version with straight chip flute

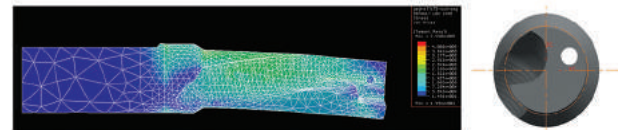

Version with helical chip flute

Up to 50% reduced tensions in the tool through Finite Element Modelling (FEM), optimized chip pocket design

Guaranteed Test / Demo Application Form

Distributor PO # _____

The following must be filled out completely before your test will be considered

IMPORTANT: For processing, send Purchase Order to your Allied Field Sales Engineer (FSE). Please clearly mark the paperwork as "Test Order."

Distributor Information

Company Name: _____
 Contact: _____
 Account Number: _____
 Phone: _____
 Email: _____

End User Information

Company Name: _____
 Contact: _____
 Industry: _____
 Phone: _____
 Email: _____

Current Process List all tooling, coatings, substrates, speeds and feeds, tool life, and any problems you are experiencing

Test Objective List what would make this a successful test (i.e. penetration rate, finish, tool life, hole size, etc.)

Application Information

Hole Diameter: _____ in/mm	Tolerance: _____	Material: _____ (4150 / A36 / Cast Iron / etc.)
Pre-existing Diameter: _____ in/mm	Depth of Cut: _____ in/mm	Hardness: _____ (BHN / Rc)
Required Finish: _____ RMS		State: _____ (Casting / Hot rolled / Forging)

Machine Information

Machine Type: _____ (Lathe / Screw machine / Machine center / etc.)	Builder: _____ (Haas, Mori Seiki, etc.)	Model #: _____
Shank Required: _____ (CAT50 / Morse taper, etc.)		Power: _____ HP/KW
Rigidity: _____	Orientation: _____	Tool Rotating: _____
<input type="checkbox"/> Excellent	<input type="checkbox"/> Vertical	<input type="checkbox"/> Yes
<input type="checkbox"/> Good	<input type="checkbox"/> Horizontal	<input type="checkbox"/> No
<input type="checkbox"/> Poor		Thrust: _____ lbs/N

Coolant Information

Coolant Delivery: _____ (Through tool / Flood)	Coolant Pressure: _____ PSI / bar
Coolant Type: _____ (Air mist, oil, synthetic, water soluble, etc.)	Coolant Volume: _____ GPM / LPM

Requested Tooling

QTY	Item Number	QTY	Item Number



Allied Machine & Engineering
 120 Deeds Drive
 Dover, OH 44622

Telephone: (330) 343-4283
 Toll Free USA & Canada: (800) 321-5537
 Fax: (330) 602-3400
 Email: info@alliedmachine.com

Warranty Information

Allied Machine & Engineering warrants to original equipment manufacturers, distributors, industrial and commercial users of its products that each new product manufactured or supplied by Allied Machine shall be free from defects in material and workmanship.

Allied Machine's obligation under this warranty is limited to furnishing without additional charge a replacement or, at its option repairing or issuing credit for any product which shall within one year from the date of sale be returned freight prepaid to the plant designated by an Allied Machine representative and which upon inspection is determined by Allied Machine to be defective in materials or workmanship.

Complete information as to operating conditions, machine, set-up, and application of cutting fluid should accompany any product returned for inspection. The provisions of this warranty shall not apply to any Allied Machine products which have been subjected to misuse, improper operating conditions, machine set-up or application of cutting fluid or which have been repaired or altered if such repair or alteration in the judgment of Allied Machine would adversely affect performance of the product.

THIS WARRANTY IS IN LIEU OF ALL OTHER WARRANTIES, EXPRESS OR IMPLIED, INCLUDING ANY IMPLIED WARRANTY OF MERCHANTABILITY OR FITNESS FOR A PARTICULAR PURPOSE. Allied Machine shall have no liability or responsibility on any claim of any kind, whether in contract, tort or otherwise, for any loss or damage arising out of, connected with, or resulting from the manufacture, sale, delivery or use of any product sold hereunder, in excess of the cost of replacement or repair as provided herein.

ALL PRICES, DELIVERIES, DESIGNS, AND MATERIALS ARE SUBJECT TO CHANGE WITHOUT NOTICE.



Allied Machine & Engineering
Registered to ISO 9001
10001329

United States

Allied Machine & Engineering

120 Deeds Drive
Dover OH 44622
United States

Phone:
+1.330.343.4283

Fax:
+1.330.602.3400

Toll Free USA and Canada:
800.321.5537

Toll Free USA and Canada:
800.223.5140

Allied Machine & Engineering

485 W Third Street
Dover OH 44622
United States

Phone:
+1.330.343.4283

Fax:
+1.330.364.7666
(Engineering Dept.)

Toll Free USA and Canada:
800.321.5537

Europe

Allied Machine & Engineering Co. (Europe) Ltd.

93 Vantage Point
Pensnett Estate
Kingswinford
West Midlands
DY6 7FR England

Phone:
+44 (0) 1384.400900

Wohlhaupter GmbH

Maybachstrasse 4
Postfach 1264
72636 Frickenhausen
Germany

Phone:
+49 (0) 7022.408.0

Fax:
+49 (0) 7022.408.212

Asia

Wohlhaupter India Pvt. Ltd.

B-23, 2nd Floor
B Block Community Centre
Janakpuri, New Delhi - 110058
India

Phone:
+91 (0) 11.41827044

Your local Allied Machine representative:



www.alliedmachine.com

Allied Machine & Engineering is registered by DQS to ISO 9001 10001329

© 2018 Allied Machine & Engineering
Literature Order Number: EC
Publish Date: May 2018