



**ALLIED MACHINE
& ENGINEERING**

WOHLHAUPTER®

Holemaking Solutions for Today's Manufacturing



Boring



Reaming



Burnishing



Threading

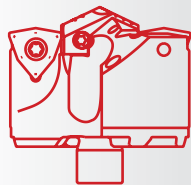

Drilling

▶ APX Drill

Deep Hole / Large Diameter Drilling System



Specials



APX Drill

Deep Hole / Large Diameter Drilling System

► **Diameter Range:** 38.00mm - 101.60mm (1.4961" - 4.0000")



Don't Let Your Machine Slow You Down

The APX deep hole/large diameter drilling system delivers the strength and versatility needed for any deep hole drilling application. The breakthrough geometry is designed to increase penetration rates and tool life. By allowing for higher spindle speeds, the APX drill lets you take advantage of the power curve on modern CNC machines.

Excellent chip control	Improves hole quality and surface finish	Provides maximum durability and stability
------------------------	--	---

Your safety and the safety of others is very important. This catalogue contains important safety messages. Always read and follow all safety precautions.



This triangle is a safety hazard symbol. It alerts you to potential safety hazards that can cause tool failure and serious injury.

When you see this symbol in the catalogue, look for a related safety message that may be near this triangle or referred to in the nearby text.

There are safety signal words also used in the catalogue. Safety messages follow these words.

WARNING

WARNING (shown above) means that failure to follow the precautions in this message could result in tool failure and serious injury.

NOTICE means that failure to follow the precautions in this message could result in damage to the tool or machine but not result in personal injury.

NOTE and **IMPORTANT** are also used. These are important that you read and follow but are not safety-related.

Visit www.alliedmachine.com for the most up-to-date information and procedures.

Applicable Industries



Aerospace



Agriculture



Automotive



Firearms



General Machining



Oil & Gas



Renewable Energy

Reference Icons

The following icons will appear throughout the catalogue to help you navigate between products.



Setup / Assembly Information
Detailed instructions and information regarding the corresponding part(s)

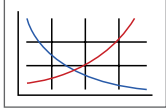

Recommended Cutting Data
Speed and feed recommendations for optimum and safe drilling

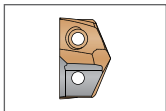

GEN3SYS® Pilot Inserts+
Lists the GEN3SYS®XT pilot insert options for each APX Drill series

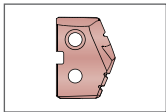

T-A® Pilot Inserts
Lists the T-A® Original and GEN2 T-A® pilot insert options for each APX Drill series

Introduction Information

Drill Selection Guide / Assembly Details 2 - 3
 Pilot Insert Options 4
 Product Nomenclature 5

Drill Series

33 Series 6 - 7
 38 Series 8 - 9
 44 Series 10 - 11
 51 Series 12 - 13
 57 Series 14 - 15
 63 Series 16 - 17
 70 Series 18 - 19
 76 Series 20 - 21
 83 Series 22 - 23
 89 Series 24 - 25
 95 Series 26 - 27

Recommended Cutting Data

Metric (mm) 28
 Imperial (inch) 29
 Deep Hole Drilling Guidelines 30

Series	Diameter Range	
	Metric (mm)	Imperial (inch)
33	33.00 - 37.99	1.2992 - 1.4688
38	38.00 - 43.99	1.4961 - 1.7322
44	44.00 - 50.99	1.7323 - 2.0075
51	51.00 - 56.99	2.0076 - 2.2438
57	57.00 - 62.99	2.2439 - 2.4799
63	63.00 - 69.99	2.4800 - 2.7555
70	70.00 - 75.99	2.7556 - 2.9917
76	76.00 - 82.99	2.9918 - 3.2673
83	83.00 - 88.99	3.2674 - 3.5035
89	89.00 - 94.99	3.5036 - 3.7400
95	95.00 - 101.60	3.7401 - 4.0000



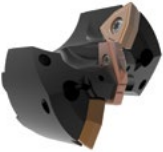

Drill Selection Guide

Series	33	38	44	51	57
Page	6 - 7	8 - 9	10 - 11	12 - 13	14 - 15
D ₅ mm	33.00 - 37.99	38.00 - 43.99	44.00 - 50.99	51.00 - 56.99	57.00 - 62.99
D ₅ inch	1.2992 - 1.4960	1.4961 - 1.7320	1.7323 - 2.0075	2.0076 - 2.2438	2.2439 - 2.4799
ISO Material					
IC Insert Shape					
IC Insert Size	7.94	9.52	9.52, 12.70	12.70, 14.30	14.30
Wear Pads	NO	NO	NO	NO	NO
Holders					
Drill Depth (mm)	112.6 - 378.6	130.5 - 439.9	151.5 - 510.0	161.8 - 570.0	179.9 - 626.9
Drill Depth (inch)	4-7/16 - 14-29/32	5-1/8 - 17-1/4	6 - 20-1/8	6-3/8 - 22-3/8	7-1/8 - 24-3/4
Pilot Insert					
T-A® Series	0, 1	0, 1	1	1	1, 2
GEN3SYS®XT Series	16, 18, 20	15, 17, 18, 20	17, 18, 22	18, 20, 22	22, 24, 26



T-A® Style Pilot Insert Head

- Utilises both T-A® Original and GEN2 T-A® inserts (0 - 2 series)
- Multiple geometry options are available to achieve optimal results in different types of applications





GEN2 T-A® Pilot Inserts
T-A® Original Pilot Inserts





GEN3SYS® XT Style Pilot Insert Head

- Utilises GEN3SYS® XT inserts (15 - 32 series)
- Multiple geometry options are available to achieve optimal results in different types of applications



GEN3SYS®XT Pilot Inserts

Flanged Straight Shank
CAT40 / CAT50 Integral Shank

63	70	76	83	89	95
					
16 - 17	18 - 19	20 - 21	22 - 23	24 - 25	26 - 27
63.00 - 69.99	70.00 - 75.99	76.00 - 82.99	83.00 - 88.99	89.00 - 94.99	95.00 - 101.60
2.4800 - 2.7555	2.7556 - 2.9917	2.9921 - 3.2673	3.2677 - 3.5035	3.5039 - 3.7400	3.7401 - 4.0000
					
					
14.30	9.52	12.70	12.70	14.30	14.30
NO	YES	YES	YES	YES	YES
200.8 - 688.3	218.8 - 709.4	239.9 - 664.0	257.8 - 704.9	275.8 - 701.8	302.0 - 698.5
7-7/8 - 27-1/8	8-3/4 - 27-7/8	9-1/2 - 26-1/8	10-1/8 - 27-3/4	10-7/8 - 27-5/8	11-7/8 - 27-1/2
2	2	2	2	2	2
26, 29, 32	29	29	32	29	32



Step 1:

Lower the APX head assembly onto the APX holder.



Step 2:

Insert the head mounting screws into points A and B. Tighten until the head is properly secured to the holder.

Step 3:

Tighten with the head mounting driver using the torque setting chart below.

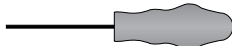
Torque Setting Chart

Series	Screw	Driver	Torque
38 - 63	75020-IP20-1	 8IP-20	678 N-cm (60 in-lb)
70 - 95	78027-IP30-1	 8IP-30B	2825 N-cm (250 in-lb)



Pilot Insert Options

A
DRILLING

B
BORING

C
REAMING

D
BURNISHING

E
THREADING

X
SPECIALS

T-A® Pilot Inserts

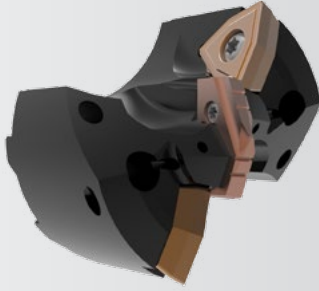

GEN3SYS® XT Pilot Inserts

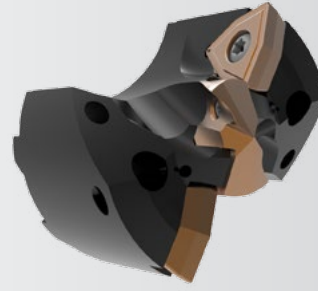

GEN2 T-A® Standard

- Designed for rigid machining applications, primarily used for drilling exotic and high alloy materials
- Ideal for general use when the surface speed needs to be increased



Standard Geometry

- Designed with corner and cutting edge enhancements to deliver more reliability, durability, and productivity
- Increases penetration rates and tool life
- Available in K35 or K20 carbide



GEN2 T-A® High Elasticity(-HE)

- Designed for improved chip formation in elastic materials like low carbon steels
- Maximises performance and increases value



Low Rake Geometry (-LR)

- The toughest XT geometry available
- Designed for harder steels and less than ideal machining applications
- Available in K35 or K20 carbide



T-A® Original Standard

- Excellent choice for general purpose use
- Provides fast penetration rates that produce good hole size and finish
- Combines highly efficient, stable cutting action to minimise power consumption

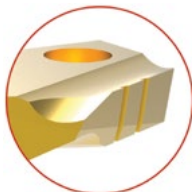

Stainless Steel Geometry (-AS)

- Designed with a specific geometry to provide unmatched chip control and tool life in austenitic and PH stainless steels, as well as high temperature alloys such as Inconel, Hastelloy, and Titanium alloys under 300 BHN Harness
- Available in K20 carbide



T-A® Original Tiny Chip (-TC)

- Unique lip and point design for excellent chip control
- Improved capabilities in long-chipping materials such as low carbon steels and soft alloy steels
- Enhanced performance in lower powered machines for better chip formation at lower feed rates



T-A® Original High Impact (-HI)

- Designed to enhance chip formation in materials with high elasticity/ductility and poor chip forming characteristics
- SK2 corner preparation for increased tool life
- Improves chip formation in structural, cast, and forged steels

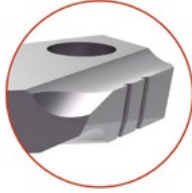

NOTE: For a complete offering of pilot inserts, see sections **A20** (GEN3SYS® Drilling Systems) and **A30** (T-A® Drilling Systems) of our catalogue.

IC Inserts

- The design allows for excellent chip control and aggressive penetration rates
- The proprietary AM300® coating increases tool life above competitors' premium coatings



Insert Application Recommendations

Carbide Grade Options

P35 (C5)	General purpose carbide grade suitable for most applications. ▶ <i>Common application in steels and stainless steels.</i>
K35 (C1)	Toughest carbide grade. Provides the best combination of edge strength and tool life. ▶ <i>Recommended for less rigid applications.</i>

Additional Geometry Option

High Rake (HR)	Provides superior chip control and tool life in long chipping carbon and alloy steels below 200 Bhn.
----------------	--

Product Nomenclature

APX Drill Heads

V	38	15	D	-	0116
1	2	3	4		5

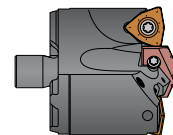

1. APX Head	2. Series	3. Pilot Series																														
V = Head	<table border="0"> <tr> <td>33 = 33 series</td> <td>70 = 70 series</td> </tr> <tr> <td>38 = 38 series</td> <td>76 = 76 series</td> </tr> <tr> <td>44 = 44 series</td> <td>83 = 83 series</td> </tr> <tr> <td>51 = 51 series</td> <td>89 = 89 series</td> </tr> <tr> <td>57 = 57 series</td> <td>95 = 95 series</td> </tr> <tr> <td>63 = 63 series</td> <td></td> </tr> </table>	33 = 33 series	70 = 70 series	38 = 38 series	76 = 76 series	44 = 44 series	83 = 83 series	51 = 51 series	89 = 89 series	57 = 57 series	95 = 95 series	63 = 63 series		<table border="0"> <tr> <th>T-A® Pilot Insert</th> <th colspan="2">GEN3SYS® XT Pilot Insert</th> </tr> <tr> <td>00 = 0 series</td> <td>15 = 15 series</td> <td>24 = 24 series</td> </tr> <tr> <td>01 = 1 series</td> <td>17 = 17 series</td> <td>26 = 26 series</td> </tr> <tr> <td>02 = 2 series</td> <td>18 = 18 series</td> <td>29 = 29 series</td> </tr> <tr> <td></td> <td>20 = 20 series</td> <td>32 = 32 series</td> </tr> <tr> <td></td> <td>22 = 22 series</td> <td></td> </tr> </table>	T-A® Pilot Insert	GEN3SYS® XT Pilot Insert		00 = 0 series	15 = 15 series	24 = 24 series	01 = 1 series	17 = 17 series	26 = 26 series	02 = 2 series	18 = 18 series	29 = 29 series		20 = 20 series	32 = 32 series		22 = 22 series	
33 = 33 series	70 = 70 series																															
38 = 38 series	76 = 76 series																															
44 = 44 series	83 = 83 series																															
51 = 51 series	89 = 89 series																															
57 = 57 series	95 = 95 series																															
63 = 63 series																																
T-A® Pilot Insert	GEN3SYS® XT Pilot Insert																															
00 = 0 series	15 = 15 series	24 = 24 series																														
01 = 1 series	17 = 17 series	26 = 26 series																														
02 = 2 series	18 = 18 series	29 = 29 series																														
	20 = 20 series	32 = 32 series																														
	22 = 22 series																															

4. Effective Cutting	5. Major Diameter
D = Double effective S = Single effective	68 = Metric 0116 = Inch 1.5153 = Decimal

Ordering Non-Stocked Diameters:

Non-stocked diameters are also available. Please refer to the price list for applicable process fees. Follow the ordering examples below:

- Metric: 38 series, T-A® (1 series), 42.15mm = **V3801D-42.15**
- Inch: 38 series, T-A® (1 series), 1.6790" = **V3801D-1.6790**

APX Drill Holders

W	38	05	H	-	50FM
1	2	3	4		5

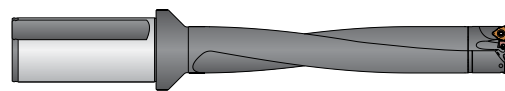

1. APX Holder	2. Series	3. Drill Length	4. Flute Style	5. Shank												
W = Holder	<table border="0"> <tr> <td>33 = 33 series</td> <td>70 = 70 series</td> </tr> <tr> <td>38 = 38 series</td> <td>76 = 76 series</td> </tr> <tr> <td>44 = 44 series</td> <td>83 = 83 series</td> </tr> <tr> <td>51 = 51 series</td> <td>89 = 89 series</td> </tr> <tr> <td>57 = 57 series</td> <td>95 = 95 series</td> </tr> <tr> <td>63 = 63 series</td> <td></td> </tr> </table>	33 = 33 series	70 = 70 series	38 = 38 series	76 = 76 series	44 = 44 series	83 = 83 series	51 = 51 series	89 = 89 series	57 = 57 series	95 = 95 series	63 = 63 series		03 = 3xD 05 = 5xD 08 = 8xD 10 = 10xD	H = Helical	40FM = 40mm flanged straight shank 50FM = 50mm flanged straight shank 150F = 38.10 flanged straight shank 200F = 2" flanged straight shank CV40 = CAT40 integral shank CV50 = CAT50 integral shank
33 = 33 series	70 = 70 series															
38 = 38 series	76 = 76 series															
44 = 44 series	83 = 83 series															
51 = 51 series	89 = 89 series															
57 = 57 series	95 = 95 series															
63 = 63 series																

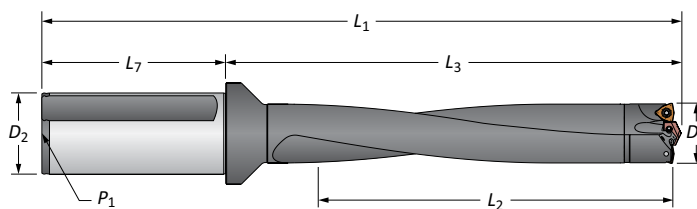
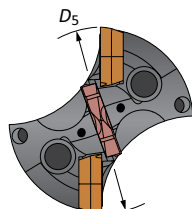
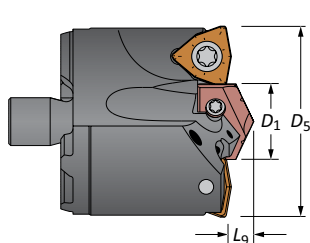

Reference Key

Symbol	Attribute
D₁	Pilot insert diameter
D₅	Major cutting diameter
L₉	Pilot insert length

Reference Key

Symbol	Attribute	Symbol	Attribute
D₂	Shank diameter	L₃	Holder reference length
D₅	Drill diameter range	L₇	Shank length
L₁	Overall length	P₁	Rear pipe tap
L₂	Drill depth		



APX Drill Heads

33 Series | Diameter Range: 33.00mm - 37.99mm (1.2992" - 1.4688")

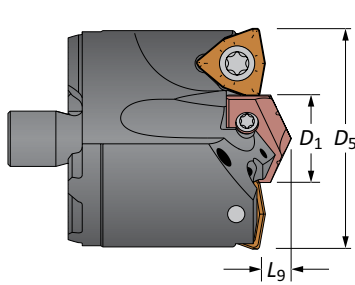

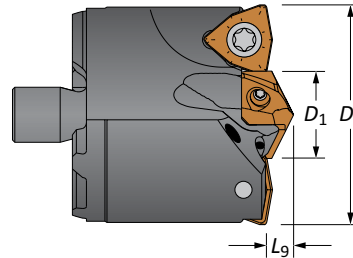
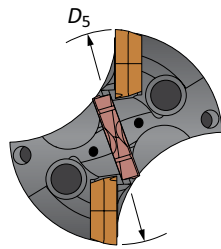

T-A® Head

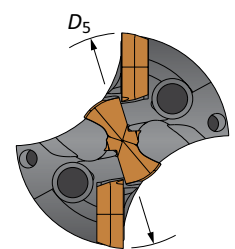

GEN3SYS® XT Head





Heads

Head					T-A® Head			GEN3SYS®XT Head			IC Insert Size
D ₅ mm	D ₅ inch	D ₅ fractional	D ₁	L ₉	Part No.	Pilot Series		Part No.	Pilot Series		
33.00	1.2992	-	16	6.35	V3300D-33	0	4C*0H-16	V3316D-33	16	7C*16P-16	7.94
33.34	1.3125	1-5/16	16	6.35	V3300D-34	0	4C*0H-16	V3316D-34	16	7C*16P-16	7.94
34.00	1.3386	-	18	6.35	V3301D-34	1	4C*1H-18	V3318D-34	18	7C*18P-18	7.94
34.13	1.3438	1-11/32	18	6.35	V3301D-0111	1	4C*1H-18	V3318D-0111	18	7C*18P-18	7.94
34.93	1.3750	1-3/8	18	6.35	V3301D-0112	1	4C*1H-18	V3318D-0112	18	7C*18P-18	7.94
35.00	1.3780	-	18	6.35	V3301D-35	1	4C*1H-18	V3318D-35	18	7C*18P-18	7.94
35.72	1.4063	1-13/32	18	6.35	V3301D-0113	1	4C*1H-18	V3318D-0113	18	7C*18P-18	7.94
36.00	1.4173	-	20	6.35	V3301D-36	1	4C*1H-20	V3320D-36	20	7C*20P-20	7.94
36.51	1.4375	1-7/16	20	6.35	V3301D-0114	1	4C*1H-20	V3320D-0114	20	7C*20P-20	7.94
37.00	1.4567	1.4567	20	6.35	V3301D-37	1	4C*1H-20	V3320D-37	20	7C*20P-20	7.94
37.31	1.4688	1.4688	20	6.35	V3301D-0115	1	4C*1H-20	V3320D-0115	20	7C*20P-20	7.94



*Denotes carbide grade (1 = K35, 2 = K20)

IC Inserts

Coating	Size	Grade	Geometry	 Part No.	 Insert Screw	 Insert Driver	Admissible Tightening Torque*
AM300®	7.94	P35	Standard	OP-05T308-PW	IS-10-1	8IP-10	305 N-cm (27.0 in-lbs)
AM300®	7.94	K35	Standard	OP-05T308-1PW	IS-10-1	8IP-10	305 N-cm (27.0 in-lbs)
AM300®	7.94	P35	High Rake	OP-05T308-PWHR	IS-10-1	8IP-10	305 N-cm (27.0 in-lbs)

*Tightening torques are calculated with a friction coefficient of $\mu = 0.14$ and develop 90% of ultimate yield strength

Pilot Accessories

Pilot Style	Series	 Insert Screws	 Insert Driver	Admissible Tightening Torque*
T-A®	0	72567-IP8-1	8IP-8	175 N-cm (15.5 in-lbs)
T-A®	1	7375-IP9-1	8IP-9	305 N-cm (27.0 in-lbs)
GEN3SYS®	16	72556-IP8-1	8IP-8	175 N-cm (15.5 in-lbs)
GEN3SYS®	18	7375-IP9-1	8IP-9	305 N-cm (27.0 in-lbs)
GEN3SYS®	20	7375-IP9-1	8IP-9	305 N-cm (27.0 in-lbs)

*Tightening torques are calculated with a friction coefficient of $\mu = 0.14$ and develop 90% of ultimate yield strength

Non-stocked diameters are also available. Follow the examples shown below. Surcharge applicable to special diameters.

Metric	38 series, T-A® (1 series), 42.15mm	Part No. = V3801D-42.15
Inch	38 series, T-A® (1 series), 1.6790"	Part No. = V3801D-1.6790

IC inserts sold in multiples of 2 | Insert screws sold in multiples of 10

APX Drill Holders

33 Series | Diameter Range: 33.00mm - 37.99mm (1.2992" - 1.4688")

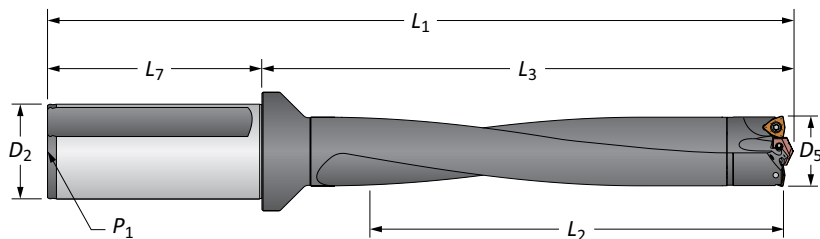

Straight Shank

	Length	D ₅	Body			Shank			Part No.
			L ₂	L ₃	L ₁	L ₇	D ₂	P ₁	
m	3xD	33.00 - 37.99	113	167.4	237.4	70.0	40.0	6.35*	W3303H-40FM
	5xD	33.00 - 37.99	189	243.4	313.4	70.0	40.0	6.35*	W3305H-40FM
	8xD	33.00 - 37.99	303	357.4	427.4	70.0	40.0	6.35*	⚠ W3308H-40FM
	10xD	33.00 - 37.99	379	433.4	503.4	70.0	40.0	6.35*	⚠ W3310H-40FM
i	3xD	1.2992 - 1.4960	4-7/16	6-19/32	9-9/32	2-11/16	1-1/2	1/4	W3303H-150F
	5xD	1.2992 - 1.4960	7-27/64	9-37/64	12-9/32	2-11/16	1-1/2	1/4	W3305H-150F
	8xD	1.2992 - 1.4960	11-59/64	14-5/64	16-3/4	2-11/16	1-1/2	1/4	⚠ W3308H-150F
	10xD	1.2992 - 1.4960	14-29/32	17-1/16	19-3/4	2-11/16	1-1/2	1/4	⚠ W3310H-150F

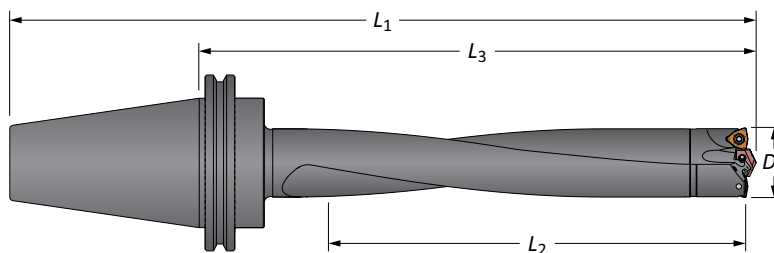

*Thread to BSP and ISO 7-1



CAT Integral Shank

	Length	D ₅		Body			Shank	Part No.
		mm	inch	L ₂	L ₃	L ₁		
i	3xD	33.00 - 37.99	1.2992 - 1.4960	4-7/16	7-3/8	10-3/16	CV40	W3303H-CV40
	5xD	33.00 - 37.99	1.2992 - 1.4960	7-27/64	10-23/64	13-11/64	CV40	W3305H-CV40
	8xD	33.00 - 37.99	1.2992 - 1.4960	11-59/64	14-55/64	17-21/32	CV40	⚠ W3308H-CV40
	10xD	33.00 - 37.99	1.2992 - 1.4960	14-29/32	17-27/32	20-21/32	CV40	⚠ W3310H-CV40
m	3xD	33.00 - 37.99	1.2992 - 1.4960	4-7/16	7-3/8	11-1/2	CV50	W3303H-CV50
	5xD	33.00 - 37.99	1.2992 - 1.4960	7-27/64	10-23/64	14-31/64	CV50	W3305H-CV50
	8xD	33.00 - 37.99	1.2992 - 1.4960	11-59/64	14-55/64	18-31/32	CV50	⚠ W3308H-CV50
	10xD	33.00 - 37.99	1.2992 - 1.4960	14-29/32	17-27/32	21-31/32	CV50	⚠ W3310H-CV50

Connection Accessories

		Admissible Tightening Torque*
75020-IP20-1	8IP-20	678 N-cm (60 in-lb)

*Tightening torques are calculated with a friction coefficient of $\mu = 0.14$ and develop 90% of ultimate yield strength

⚠ WARNING Refer to Speed and Feed charts for recommended adjustments to speeds and feeds. Refer to page A50: 30 for deep hole drilling guidelines in this section of the catalogue. Visit www.alliedmachine.com for the most up-to-date information and procedures. Factory technical assistance is available for your specific applications through our Application Engineering Team.

m = Metric (mm)
i = Imperial (in)

Mounting screws sold in multiples of 4

A DRILLING
B BORING
C REAMING
D BURNISHING
E THREADING
X SPECIALS



38

DRILLING | APX Drill deep hole / large diameter replaceable insert drilling system

APX Drill Heads



38 Series | Diameter Range: 38.00mm - 43.99mm (1.4961" - 1.7322")

Heads

Head					T-A® Head			GEN3SYS®XT Head			IC Insert Size
D ₅ mm	D ₅ inch	D ₅ fractional	D ₁	L ₉	Part No.	Pilot Series	 Pilot Insert	Part No.	Pilot Series	 Pilot Insert	
38.00	1.4961	–	15.50	7.54	V3800D-38	0	4C*0H-15.5	V3815D-38	15	7C*15P-15.5	9.52
38.10	1.5000	1-1/2	15.50	7.54	V3800D-0116	0	4C*0H-15.5	V3815D-0116	15	7C*15P-15.5	9.52
38.90	1.5313	1-17/32	15.50	7.54	V3800D-0117	0	4C*0H-15.5	V3815D-0117	15	7C*15P-15.5	9.52
39.00	1.5354	–	15.50	7.54	V3800D-39	0	4C*0H-15.5	V3815D-39	15	7C*15P-15.5	9.52
39.69	1.5625	1-9/16	15.50	7.54	V3800D-0118	0	4C*0H-15.5	V3815D-0118	15	7C*15P-15.5	9.52
40.00	1.5748	–	17.50	7.54	V3800D-40	0	4C*0H-17.5	V3817D-40	17	7C*17P-17.5	9.52
40.48	1.5938	1-19/32	17.50	7.54	V3800D-0119	0	4C*0H-17.5	V3817D-0119	17	7C*17P-17.5	9.52
41.00	1.6142	–	17.50	7.54	V3800D-41	0	4C*0H-17.5	V3817D-41	17	7C*17P-17.5	9.52
41.28	1.6250	1-5/8	17.50	7.54	V3800D-0120	0	4C*0H-17.5	V3817D-0120	17	7C*17P-17.5	9.52
42.00	1.6535	–	19.50	7.54	V3801D-42	1	4C*0H-19.5	V3818D-42	18	7C*18P-19.5	9.52
42.07	1.6563	1-21/32	19.50	7.54	V3801D-0121	1	4C*0H-19.5	V3818D-0121	18	7C*18P-19.5	9.52
42.86	1.6875	1-11/16	19.50	7.54	V3801D-0122	1	4C*0H-19.5	V3818D-0122	18	7C*18P-19.5	9.52
43.00	1.6929	–	21.00	7.54	V3801D-43	1	4C*0H-21	V3820D-43	20	7C*20P-21	9.52
43.66	1.7188	1-23/32	21.00	7.54	V3801D-0123	1	4C*0H-21	V3820D-0123	20	7C*20P-21	9.52

*Denotes carbide grade (1 = K35, 2 = K20)

IC Inserts

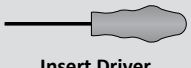

Coating	Size	Grade	Geometry	 Part No.	 Insert Screw	 Insert Driver	Admissible Tightening Torque*
AM300®	9.52	P35	Standard	OP-060408-PW	73595-IP15-1	8IP-15	465 N-cm (41.0 in-lbs)
AM300®	9.52	K35	Standard	OP-060408-1PW	73595-IP15-1	8IP-15	465 N-cm (41.0 in-lbs)
AM300®	9.52	P35	High Rake	OP-060408-PWHR	73595-IP15-1	8IP-15	465 N-cm (41.0 in-lbs)
AM300®	9.52	P35	High Impact	OP-060408-PWHI	73595-IP15-1	8IP-15	465 N-cm (41.0 in-lbs)

*Tightening torques are calculated with a friction coefficient of $\mu = 0.14$ and develop 90% of ultimate yield strength

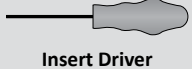
Pilot Accessories

Pilot Style	Series	 Insert Screws	 Insert Driver	Admissible Tightening Torque*
T-A®	0	72567-IP8-1	8IP-8	175 N-cm (15.5 in-lbs)
T-A®	1	7375-IP9-1	8IP-9	305 N-cm (27.0 in-lbs)
GEN3SYS®	15	7247-IP7-1	8IP-7	84 N-cm (7.4 in-lbs)
GEN3SYS®	17	72567-IP8-1	8IP-8	175 N-cm (15.5 in-lbs)
GEN3SYS®	18	7375-IP9-1	8IP-9	305 N-cm (27.0 in-lbs)
GEN3SYS®	20	7375-IP9-1	8IP-9	305 N-cm (27.0 in-lbs)

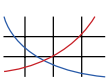
*Tightening torques are calculated with a friction coefficient of $\mu = 0.14$ and develop 90% of ultimate yield strength

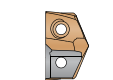
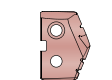
A50: 28 - 29  A50: 2 - 5  Section A20  Section A30 

Non-stocked diameters are also available. Follow the examples shown below. Surcharge applicable to special diameters.

Metric	38 series, T-A® (1 series), 42.15mm	Part No. = V3801D-42.15
Inch	38 series, T-A® (1 series), 1.6790"	Part No. = V3801D-1.6790

IC inserts sold in multiples of 2 | Insert screws sold in multiples of 10

A50: 8

www.alliedmachine.com | +44 (0) 1384 400 900 | enquiries.eu@alliedmachine.com

A DRILLING

B BORING

C REAMING

D BURNISHING

E THREADING

X SPECIALS

APX Drill Holders

38 Series | Diameter Range: 38.00mm - 43.99mm (1.4961" - 1.7322")

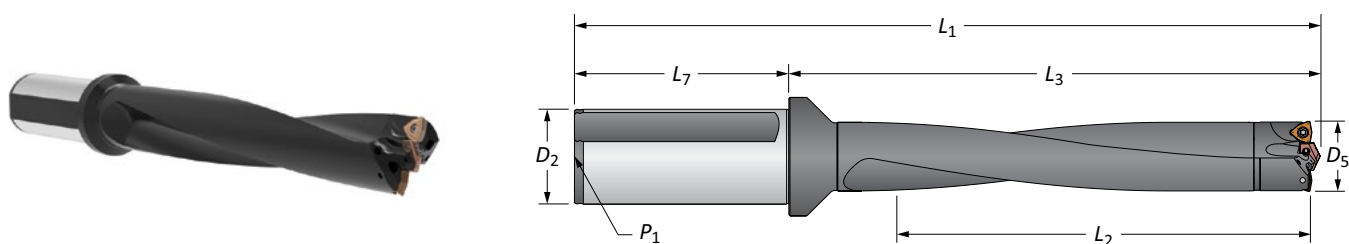

Straight Shank

Metric	Length	D_5		Body			Shank		Part No.		
		mm	inch	L_2	L_3	L_1	L_7	D_2		P_1	
m	3xD	38.00 - 43.99		131	196.5	265.7	70.0	40.0	6.35*	W3803H-40FM	
	5xD	38.00 - 43.99		220	284.5	353.7	70.0	40.0	6.35*	W3805H-40FM	
	8xD	38.00 - 43.99		352	416.5	485.7	70.0	40.0	6.35*	W3808H-40FM	
	10xD	38.00 - 43.99		440	503.9	573.7	70.0	40.0	6.35*	W3810H-40FM	
	3xD	38.00 - 43.99		131	196.5	276.5	80.0	50.0	6.35*	W3803H-50FM	
	5xD	38.00 - 43.99		220	284.5	364.5	80.0	50.0	6.35*	W3805H-50FM	
	8xD	38.00 - 43.99		352	416.5	496.3	80.0	50.0	6.35*	W3808H-50FM	
	10xD	38.00 - 43.99		440	503.9	583.9	80.0	50.0	6.35*	W3810H-50FM	
	i	3xD	1.4961 - 1.7322		5-1/8	7-47/64	10-25/64	2-11/16	1-1/2	1/4	W3803H-150F
		5xD	1.4961 - 1.7322		8-5/8	11-13/64	13-55/64	2-11/16	1-1/2	1/4	W3805H-150F
8xD		1.4961 - 1.7322		13-7/8	16-25/64	19-3/64	2-11/16	1-1/2	1/4	W3808H-150F	
10xD		1.4961 - 1.7322		17-1/4	19-27/32	22-33/64	2-11/16	1-1/2	1/4	W3810H-150F	
3xD		1.4961 - 1.7322		5-1/8	7-47/64	12-15/64	4-1/2	2	1/4	W3803H-200F	
5xD		1.4961 - 1.7322		8-5/8	11-13/64	15-45/64	4-1/2	2	1/4	W3805H-200F	
8xD		1.4961 - 1.7322		13-7/8	16-25/64	20-57/64	4-1/2	2	1/4	W3808H-200F	
10xD		1.4961 - 1.7322		17-1/4	19-27/32	24-59/64	4-1/2	2	1/4	W3810H-200F	

*Thread to BSP and ISO 7-1

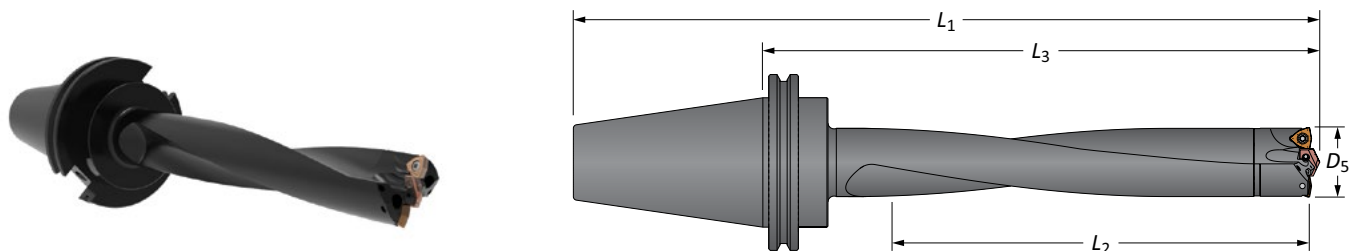

CAT Integral Shank

Metric	Length	D_5		Body			Shank	Part No.
		mm	inch	L_2	L_3	L_1		
i	3xD	38.00 - 43.99	1.4961 - 1.7322	5-1/8	8-5/16	11	CV40	W3803H-CV40
	5xD	38.00 - 43.99	1.4961 - 1.7322	8-5/8	11-49/64	14-29/64	CV40	W3805H-CV40
	8xD	38.00 - 43.99	1.4961 - 1.7322	13-7/8	16-31/32	19-21/32	CV40	W3808H-CV40
	10xD	38.00 - 43.99	1.4961 - 1.7322	17-1/4	20-7/16	23-1/8	CV40	W3810H-CV40
	3xD	38.00 - 43.99	1.4961 - 1.7322	5-1/8	8-5/16	12-5/16	CV50	W3803H-CV50
	5xD	38.00 - 43.99	1.4961 - 1.7322	8-5/8	11-49/64	15-49/64	CV50	W3805H-CV50
	8xD	38.00 - 43.99	1.4961 - 1.7322	13-7/8	16-31/32	20-31/32	CV50	W3808H-CV50
	10xD	38.00 - 43.99	1.4961 - 1.7322	17-1/4	20-7/16	24-7/16	CV50	W3810H-CV50

Connection Accessories

Mounting Screw	Mounting Screw Driver	Admissible Tightening Torque*
75020-IP20-1	8IP-20	678 N-cm (60 in-lb)

*Tightening torques are calculated with a friction coefficient of $\mu = 0.14$ and develop 90% of ultimate yield strength

WARNING Refer to Speed and Feed charts for recommended adjustments to speeds and feeds. Refer to page A50: 30 for deep hole drilling guidelines in this section of the catalogue. Visit www.alliedmachine.com for the most up-to-date information and procedures. Factory technical assistance is available for your specific applications through our Application Engineering Team.

m = Metric (mm)
i = Imperial (in)

Mounting screws sold in multiples of 4

A DRILLING
B BORING
C REAMING
D BURNISHING
E THREADING
X SPECIALS



APX Drill Heads

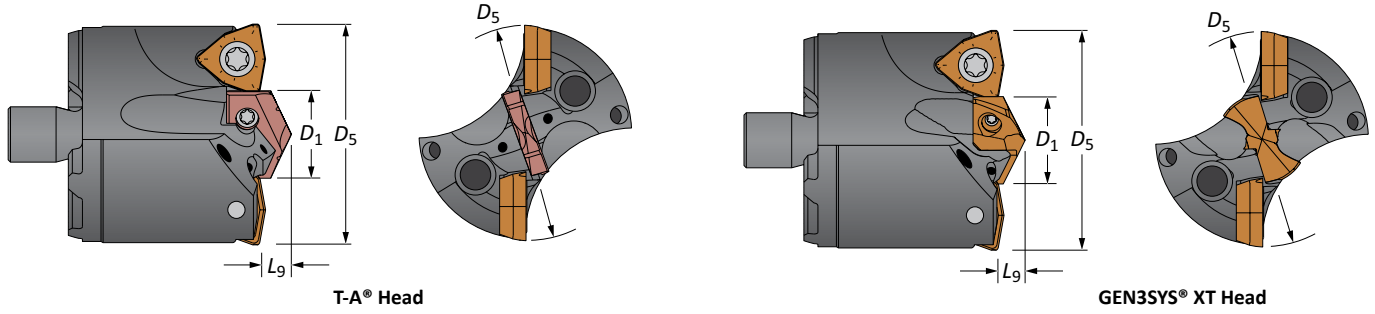

44 Series | Diameter Range: 44.00mm - 50.99mm (1.7323" - 2.0075")



A
DRILLING

B

Heads

Head					T-A Head			GEN3SYS [®] XT Head			IC Insert Size
D ₅ mm	D ₅ inch	D ₅ fractional	D ₁	L ₉	Part No.	Pilot Series		Part No.	Pilot Series		
44.00	1.7323	-	23	8.33	V4401D-44	1	4C*1H-23	V4422D-44	22	7C*22P-23	9.53
44.45	1.7500	1-3/4	23	8.33	V4401D-0124	1	4C*1H-23	V4422D-0124	22	7C*22P-23	9.53
45.00	1.7717	-	23	8.33	V4401D-45	1	4C*1H-23	V4422D-45	22	7C*22P-23	9.53
45.25	1.7813	1-25/32	23	8.33	V4401D-0125	1	4C*1H-23	V4422D-0125	22	7C*22P-23	9.53
46.00	1.8110	-	24	8.33	V4401D-46	1	4C*1H-24	V4422D-46	22	7C*22P-24	9.53
46.04	1.8125	1-13/16	24	8.33	V4401D-0126	1	4C*1H-24	V4422D-0126	22	7C*22P-24	9.53
46.83	1.8438	1-27/32	24	8.33	V4401D-0127	1	4C*1H-24	V4422D-0127	22	7C*22P-24	9.53
47.00	1.8504	-	24	8.33	V4401D-47	1	4C*1H-24	V4422D-47	22	7C*22P-24	9.53
47.63	1.8750	1-7/8	24	8.33	V4401D-0128	1	4C*1H-24	V4422D-0128	22	7C*22P-24	9.53
48.00	1.8898	-	18	8.33	V4401D-48	1	4C*1H-18	V4417D-48	17	7C*17P-18	12.70
48.42	1.9063	1-29/32	18	8.33	V4401D-0129	1	4C*1H-18	V4417D-0129	17	7C*17P-18	12.70
49.00	1.9291	-	18	8.33	V4401D-49	1	4C*1H-18	V4417D-49	17	7C*17P-18	12.70
49.21	1.9375	1-15/16	18	8.33	V4401D-0130	1	4C*1H-18	V4417D-0130	17	7C*17P-18	12.70
50.00	1.9685	-	19	8.33	V4401D-50	1	4C*1H-19	V4418D-50	18	7C*18P-19	12.70
50.01	1.9688	1-31/32	19	8.33	V4401D-0131	1	4C*1H-19	V4418D-0131	18	7C*18P-19	12.70
50.80	2.0000	2	19	8.33	V4401D-0200	1	4C*1H-19	V4418D-0200	18	7C*18P-19	12.70



*Denotes carbide grade (1 = K35, 2 = K20)

BORING

C
REAMING

D



IC Inserts

Coating	Size	Grade	Geometry	 Part No.	 Insert Screw	 Insert Driver	Admissible Tightening Torque*
AM300 [®]	9.53	P35	Standard	OP-060408-PW	73595-IP15-1	8IP-15	465 N-cm (41.0 in-lbs)
AM300 [®]	9.53	K35	Standard	OP-060408-1PW	73595-IP15-1	8IP-15	465 N-cm (41.0 in-lbs)
AM300 [®]	9.53	P35	High Rake	OP-060408-PWHR	73595-IP15-1	8IP-15	465 N-cm (41.0 in-lbs)
AM300 [®]	9.53	P35	High Impact	OP-060408-PWHI	73595-IP15-1	8IP-15	465 N-cm (41.0 in-lbs)
AM300 [®]	12.70	P35	Standard	OP-080508-PW	74012-IP15-1	8IP-15	690 N-cm (61.0 in-lbs)
AM300 [®]	12.70	K35	Standard	OP-080508-1PW	74012-IP15-1	8IP-15	690 N-cm (61.0 in-lbs)
AM300 [®]	12.70	P35	High Rake	OP-080508-PWHR	74012-IP15-1	8IP-15	690 N-cm (61.0 in-lbs)
AM300 [®]	12.70	P35	High Impact	OP-080508-PWHI	74012-IP15-1	8IP-15	690 N-cm (61.0 in-lbs)

*Tightening torques are calculated with a friction coefficient of $\mu = 0.14$ and develop 90% of ultimate yield strength

E

Pilot Accessories

Pilot Style	Series	 Insert Screws	 Insert Driver	Admissible Tightening Torque*
T-A [®]	1	7375-IP9-1	8IP-9	305 N-cm (27.0 in-lbs)
GEN3SYS [®]	17	72567-IP8-1	8IP-8	175 N-cm (15.5 in-lbs)
GEN3SYS [®]	18	7375-IP9-1	8IP-9	305 N-cm (27.0 in-lbs)
GEN3SYS [®]	22	739-IP9-1	8IP-9	305 N-cm (27.0 in-lbs)

*Tightening torques are calculated with a friction coefficient of $\mu = 0.14$ and develop 90% of ultimate yield strength

THREADING

X

SPECIALS

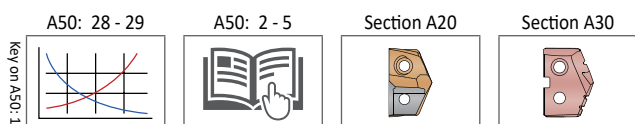

Non-stocked diameters are also available. Follow the examples shown below. Surcharge applicable to special diameters.

Metric	38 series, T-A [®] (1 series), 42.15mm	Part No. = V3801D-42.15
Inch	38 series, T-A [®] (1 series), 1.6790"	Part No. = V3801D-1.6790

IC inserts sold in multiples of 2 | Insert screws sold in multiples of 10

APX Drill Holders

44 Series | Diameter Range: 44.00mm - 50.99mm (1.7323" - 2.0075")

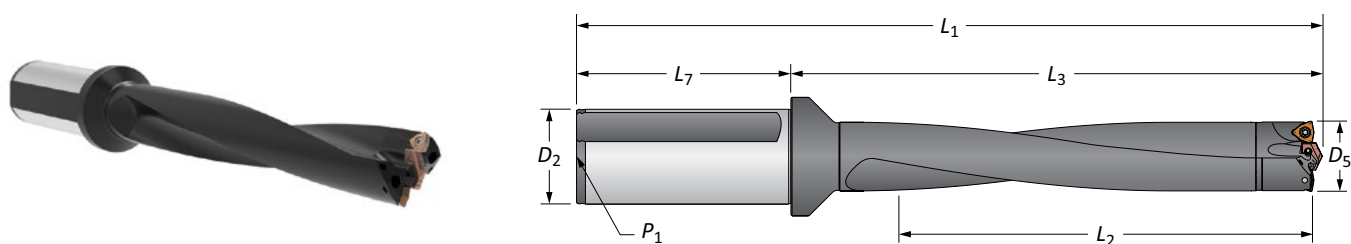

Straight Shank

	Length	D ₅	Body			Shank			Part No.
			L ₂	L ₃	L ₁	L ₇	D ₂	P ₁	
m	3xD	44.00 - 50.99	152	216.7	286.7	70.0	40.0	6.35*	W4403H-40FM
	5xD	44.00 - 50.99	254	318.7	388.7	70.0	40.0	6.35*	W4405H-40FM
	8xD	44.00 - 50.99	406	471.9	541.9	70.0	40.0	6.35*	W4408H-40FM
	10xD	44.00 - 50.99	510	573.9	643.9	70.0	40.0	6.35*	W4410H-40FM
	3xD	44.00 - 50.99	152	216.7	296.7	80.0	50.0	6.35*	W4403H-50FM
	5xD	44.00 - 50.99	254	318.7	398.7	80.0	50.0	6.35*	W4405H-50FM
	8xD	44.00 - 50.99	406	471.9	551.9	80.0	50.0	6.35*	W4408H-50FM
	10xD	44.00 - 50.99	510	573.9	653.9	80.0	50.0	6.35*	W4410H-50FM
i	3xD	1.7323 - 2.0075	6	8-17/32	11-15/64	2-11/16	1-1/2	1/4	W4403H-150F
	5xD	1.7323 - 2.0075	10	12-35/64	15-1/4	2-11/16	1-1/2	1/4	W4405H-150F
	8xD	1.7323 - 2.0075	16	18-37/64	21-17/64	2-11/16	1-1/2	1/4	W4408H-150F
	10xD	1.7323 - 2.0075	20-1/8	22-19/32	25-9/32	2-11/16	1-1/2	1/4	W4410H-150F
	3xD	1.7323 - 2.0075	6	8-33/64	13-1/32	4-1/2	2	1/4	W4403H-200F
	5xD	1.7323 - 2.0075	10	12-35/64	17-3/64	4-1/2	2	1/4	W4405H-200F
	8xD	1.7323 - 2.0075	16	18-37/64	23-5/64	4-1/2	2	1/4	W4408H-200F
	10xD	1.7323 - 2.0075	20-1/8	22-19/32	27-3/32	4-1/2	2	1/4	W4410H-200F

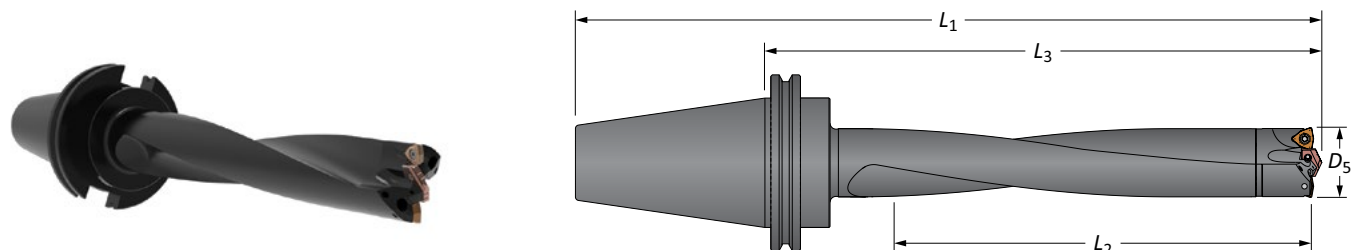

*Thread to BSP and ISO 7-1



CAT Integral Shank

	Length	D ₅		Body			Shank	Part No.
		mm	inch	L ₂	L ₃	L ₁		
i	3xD	44.00 - 50.99	1.7323 - 2.0075	6	9-1/4	11-15/16	CV40	W4403H-CV40
	5xD	44.00 - 50.99	1.7323 - 2.0075	10	13-17/64	15-61/64	CV40	W4405H-CV40
	8xD	44.00 - 50.99	1.7323 - 2.0075	16	19-19/64	21-63/64	CV40	W4408H-CV40
	10xD	44.00 - 50.99	1.7323 - 2.0075	20-1/8	23-5/16	26	CV40	W4410H-CV40
i	3xD	44.00 - 50.99	1.7323 - 2.0075	6	9-1/4	13-1/4	CV50	W4403H-CV50
	5xD	44.00 - 50.99	1.7323 - 2.0075	10	13-17/64	17-17/64	CV50	W4405H-CV50
	8xD	44.00 - 50.99	1.7323 - 2.0075	16	19-19/64	23-19/64	CV50	W4408H-CV50
	10xD	44.00 - 50.99	1.7323 - 2.0075	20	23-5/16	27-5/16	CV50	W4410H-CV50

Connection Accessories

		Admissible Tightening Torque*
75020-IP20-1	8IP-20	

*Tightening torques are calculated with a friction coefficient of $\mu = 0.14$ and develop 90% of ultimate yield strength

WARNING Refer to Speed and Feed charts for recommended adjustments to speeds and feeds. Refer to page A50: 30 for deep hole drilling guidelines in this section of the catalogue. Visit www.alliedmachine.com for the most up-to-date information and procedures. Factory technical assistance is available for your specific applications through our Application Engineering Team.

m = Metric (mm)
i = Imperial (in)

Mounting screws sold in multiples of 4



APX Drill Heads

51 Series | Diameter Range: 51.00mm - 56.99mm (2.0076" - 2.2438")

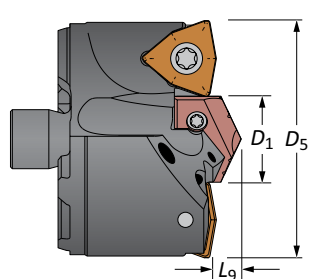

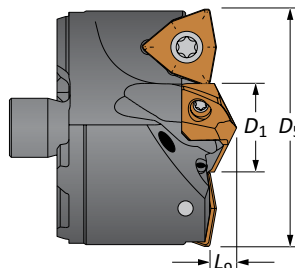
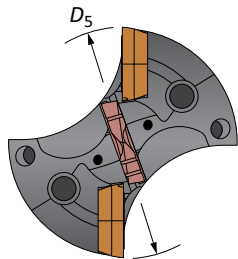

T-A® Head

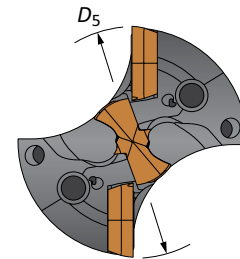

GEN3SYS® XT Head





Heads

Head					T-A® Head			GEN3SYS®XT Head			
D ₅ mm	D ₅ inch	D ₅ fractional	D ₁	L ₉	Part No.	Pilot Series		Part No.	Pilot Series		IC Insert Size
51.00	2.0079	-	20	8.73	V5101D-51	1	4C*1H-19.8	V5118D-51	18	7C*18P-20	12.70
51.59	2.0313	2-1/32	20	8.73	V5101D-0201	1	4C*1H-19.8	V5118D-0201	18	7C*18P-20	12.70
52.00	2.0472	-	20	8.73	V5101D-52	1	4C*1H-19.8	V5118D-52	18	7C*18P-20	12.70
52.39	2.0625	2-1/16	20	8.73	V5101D-0202	1	4C*1H-19.8	V5118D-0202	18	7C*18P-20	12.70
53.00	2.0866	-	21.5	8.73	V5101D-53	1	4C*1H-21.5	V5120D-53	20	7C*20P-21.5	12.70
53.18	2.0938	2-3/32	21.5	8.73	V5101D-0203	1	4C*1H-21.5	V5120D-0203	20	7C*20P-21.5	12.70
53.98	2.1250	2-1/8	21.5	8.73	V5101D-0204	1	4C*1H-21.5	V5120D-0204	20	7C*20P-21.5	12.70
54.00	2.1260	-	24	8.73	V5101D-54	1	4C*1H-24	V5122D-54	22	7C*22P-24	12.70
54.77	2.1563	2-5/32	24	8.73	V5101D-0205	1	4C*1H-24	V5122D-0205	22	7C*22P-24	12.70
55.00	2.1654	-	24	8.73	V5101D-55	1	4C*1H-24	V5122D-55	22	7C*22P-24	12.70
55.56	2.1875	2-3/16	24	8.73	V5101D-0206	1	4C*1H-24	V5122D-0206	22	7C*22P-24	12.70
56.00	2.2047	-	24	8.73	V5101D-56	1	4C*1H-24	V5122D-56	22	7C*22P-24	12.70
56.36	2.2188	2-7/32	21	8.73	V5101D-0207	1	4C*1H-21	V5120D-0207	20	7C*20P-21	14.29

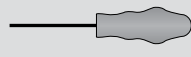

*Denotes carbide grade (1 = K35, 2 = K20)

IC Inserts

Coating	Size	Grade	Geometry	 Part No.	 Insert Screw	 Insert Driver	Admissible Tightening Torque*
AM300®	12.70	P35	Standard	OP-080508-PW	74012-IP15-1	8IP-15	690 N-cm (61.0 in-lbs)
AM300®	12.70	K35	Standard	OP-080508-1PW	74012-IP15-1	8IP-15	690 N-cm (61.0 in-lbs)
AM300®	12.70	P35	High Rake	OP-080508-PWHR	74012-IP15-1	8IP-15	690 N-cm (61.0 in-lbs)
AM300®	12.70	P35	High Impact	OP-080508-PWHI	74012-IP15-1	8IP-15	690 N-cm (61.0 in-lbs)
AM300®	14.29	P35	Standard	OP-090608-PW	75014-IP20-1	8IP-20	1370 N-cm (121.0 in-lbs)
AM300®	14.29	K35	Standard	OP-090608-1PW	75014-IP20-1	8IP-20	1370 N-cm (121.0 in-lbs)
AM300®	14.29	P35	High Rake	OP-090608-PWHR	75014-IP20-1	8IP-20	1370 N-cm (121.0 in-lbs)
AM300®	14.29	P35	High Impact	OP-090608-PWHI	75014-IP20-1	8IP-20	1370 N-cm (121.0 in-lbs)

*Tightening torques are calculated with a friction coefficient of $\mu = 0.14$ and develop 90% of ultimate yield strength

Pilot Accessories

Pilot Style	Series	 Insert Screws	 Insert Driver	Admissible Tightening Torque*
T-A®	1	7375-IP9-1	8IP-9	305 N-cm (27.0 in-lbs)
GEN3SYS®	18	7375-IP9-1	8IP-9	305 N-cm (27.0 in-lbs)
GEN3SYS®	20	7375-IP9-1	8IP-9	305 N-cm (27.0 in-lbs)
GEN3SYS®	22	739-IP9-1	8IP-9	305 N-cm (27.0 in-lbs)

*Tightening torques are calculated with a friction coefficient of $\mu = 0.14$ and develop 90% of ultimate yield strength

A50: 28 - 29

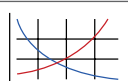

A50: 2 - 5



Section A20

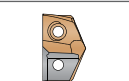

Section A30

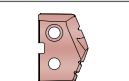

Non-stocked diameters are also available. Follow the examples shown below. Surcharge applicable to special diameters.

Metric	38 series, T-A® (1 series), 42.15mm	Part No. = V3801D-42.15
Inch	38 series, T-A® (1 series), 1.6790"	Part No. = V3801D-1.6790

IC inserts sold in multiples of 2 | Insert screws sold in multiples of 10

APX Drill Holders

51 Series | Diameter Range: 51.00mm - 56.99mm (2.0076" - 2.2438")

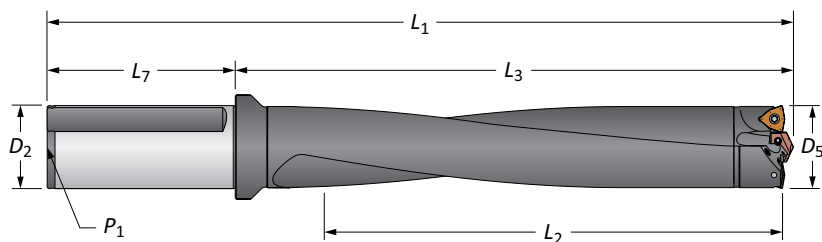

Straight Shank

	Length	D ₅	Body			Shank			Part No.
			L ₂	L ₃	L ₁	L ₇	D ₂	P ₁	
Ⓜ	3xD	51.00 - 56.99	162	225.5	305.5	80.0	50.0	6.35*	W5103H-50FM
	5xD	51.00 - 56.99	285	339.6	419.6	80.0	50.0	6.35*	W5105H-50FM
	8xD	51.00 - 56.99	456	510.4	590.4	80.0	50.0	6.35*	⚠ W5108H-50FM
	10xD	51.00 - 56.99	570	624.6	704.6	80.0	50.0	6.35*	⚠ W5110H-50FM
Ⓜ	3xD	2.0076 - 2.2438	6-3/8	8-7/8	13-3/8	4-1/2	2	1/4	W5103H-200F
	5xD	2.0076 - 2.2438	11-1/8	13-3/8	17-7/8	4-1/2	2	1/4	W5105H-200F
	8xD	2.0076 - 2.2438	17-7/8	20-3/32	24-19/32	4-1/2	2	1/4	⚠ W5108H-200F
	10xD	2.0076 - 2.2438	22-3/8	24-19/32	29-3/32	4-1/2	2	1/4	⚠ W5110H-200F

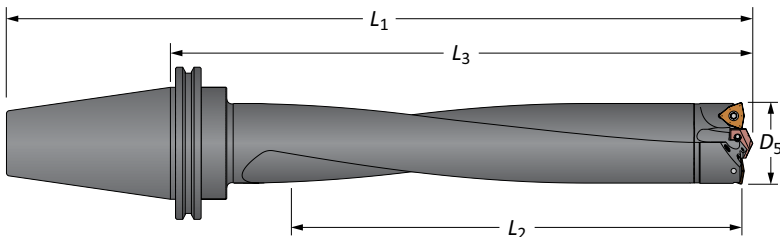

*Thread to BSP and ISO 7-1



CV50 Shank

	Length	D ₅		Body			Shank	Part No.
		mm	inch	L ₂	L ₃	L ₁		
Ⓜ	3xD	51.00 - 56.99	2.0076 - 2.2438	6-3/8	9-47/64	13-47/64	CV50	W5103H-CV50
	5xD	51.00 - 56.99	2.0076 - 2.2438	11-1/4	14-7/32	18-7/32	CV50	W5105H-CV50
	8xD	51.00 - 56.99	2.0076 - 2.2438	17-7/8	20-61/64	24-61/64	CV50	⚠ W5108H-CV50
	10xD	51.00 - 56.99	2.0076 - 2.2438	22-3/8	25-7/16	29-7/16	CV50	⚠ W5110H-CV50

Connection Accessories

		Admissible Tightening Torque*
Mounting Screw 75020-IP20-1	Mounting Screw Driver 8IP-20	678 N-cm (60 in-lb)

*Tightening torques are calculated with a friction coefficient of $\mu = 0.14$ and develop 90% of ultimate yield strength

⚠ WARNING Refer to Speed and Feed charts for recommended adjustments to speeds and feeds. Refer to page A50: 30 for deep hole drilling guidelines in this section of the catalogue. Visit www.alliedmachine.com for the most up-to-date information and procedures. Factory technical assistance is available for your specific applications through our Application Engineering Team.

Ⓜ = Metric (mm)
Ⓜ = Imperial (in)

Mounting screws sold in multiples of 4



APX Drill Heads

57 Series | Diameter Range: 57.00mm - 62.99mm (2.2439" - 2.4799")

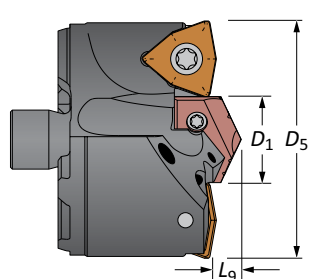

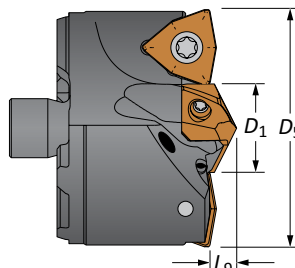
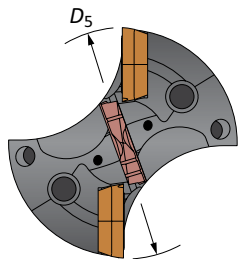

T-A® Head

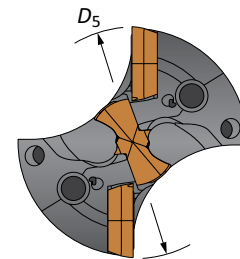

GEN3SYS® XT Head





Heads

Head					T-A® Head			GEN3SYS®XT Head			IC Insert Size
D ₅ mm	D ₅ inch	D ₅ fractional	D ₁	L ₉	Part No.	Pilot Series		Part No.	Pilot Series		
57.00	2.2441	-	23	9.92	V5701D-57	1	4C*1H-23	V5722D-57	22	7C*22P-23	14.29
57.15	2.2500	2-1/4	23	9.92	V5701D-0208	1	4C*1H-23	V5722D-0208	22	7C*22P-23	14.29
57.94	2.2813	2-9/32	23	9.92	V5701D-0209	1	4C*1H-23	V5722D-0209	22	7C*22P-23	14.29
58.00	2.2835	-	23	9.92	V5701D-58	1	4C*1H-23	V5722D-58	22	7C*22P-23	14.29
58.74	2.3125	2-5/16	23	9.92	V5701D-0210	1	4C*1H-23	V5722D-0210	22	7C*22P-23	14.29
59.00	2.3228	-	24	9.92	V5701D-59	1	4C*1H-24	V5722D-59	22	7C*22P-24	14.29
59.53	2.3438	2-11/32	24	9.92	V5701D-0211	1	4C*1H-24	V5722D-0211	22	7C*22P-24	14.29
60.00	2.3622	-	24	9.92	V5701D-60	1	4C*1H-24	V5722D-60	22	7C*22P-24	14.29
60.33	2.3750	2-3/8	24	9.92	V5701D-0212	1	4C*1H-24	V5722D-0212	22	7C*22P-24	14.29
61.00	2.4016	-	25.5	9.92	V5702D-61	2	4C*2H-25.5	V5724D-61	24	7C*24P-25.5	14.29
61.12	2.4063	2-13/32	25.5	9.92	V5702D-0213	2	4C*2H-25.5	V5724D-0213	24	7C*24P-25.5	14.29
61.91	2.4375	2-7/16	25.5	9.92	V5702D-0214	2	4C*2H-25.5	V5724D-0214	24	7C*24P-25.5	14.29
62.00	2.4409	-	27	9.92	V5702D-62	2	4C*2H-27	V5726D-62	26	7C*26P-27	14.29
62.71	2.4688	2-15/32	27	9.92	V5702D-0215	2	4C*2H-27	V5726D-0215	26	7C*26P-27	14.29

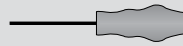

*Denotes carbide grade (1 = K35, 2 = K20)

IC Inserts

Coating	Size	Grade	Geometry	 Part No.	 Insert Screw	 Insert Driver	Admissible Tightening Torque*
AM300®	14.29	P35	Standard	OP-090608-PW	75014-IP20-1	8IP-20	1370 N-cm (121.0 in-lbs)
AM300®	14.29	K35	Standard	OP-090608-1PW	75014-IP20-1	8IP-20	1370 N-cm (121.0 in-lbs)
AM300®	14.29	P35	High Rake	OP-090608-PWHR	75014-IP20-1	8IP-20	1370 N-cm (121.0 in-lbs)
AM300®	14.29	P35	High Impact	OP-090608-PWHI	75014-IP20-1	8IP-20	1370 N-cm (121.0 in-lbs)

*Tightening torques are calculated with a friction coefficient of $\mu = 0.14$ and develop 90% of ultimate yield strength

Pilot Accessories

Pilot Style	Series	 Insert Screws	 Insert Driver	Admissible Tightening Torque*
T-A®	1	7375-IP9-1	8IP-9	305 N-cm (27.0 in-lbs)
T-A®	2	7495-IP15-1	8IP-15	690 N-cm (61.0 in-lbs)
GEN3SYS®	22	739-IP9-1	8IP-9	305 N-cm (27.0 in-lbs)
GEN3SYS®	24	739-IP9-1	8IP-9	305 N-cm (27.0 in-lbs)
GEN3SYS®	26	7495-IP15-1	8IP-15	690 N-cm (61.0 in-lbs)

*Tightening torques are calculated with a friction coefficient of $\mu = 0.14$ and develop 90% of ultimate yield strength

A50: 28 - 29

A50: 2 - 5

Section A20

Section A30

Key on A50:1

Non-stocked diameters are also available. Follow the examples shown below. Surcharge applicable to special diameters.

Metric	38 series, T-A® (1 series), 42.15mm	Part No. = V3801D-42.15
Inch	38 series, T-A® (1 series), 1.6790"	Part No. = V3801D-1.6790

IC inserts sold in multiples of 2 | Insert screws sold in multiples of 10

APX Drill Holders

57 Series | Diameter Range: 57.00mm - 62.99mm (2.2439" - 2.4799")

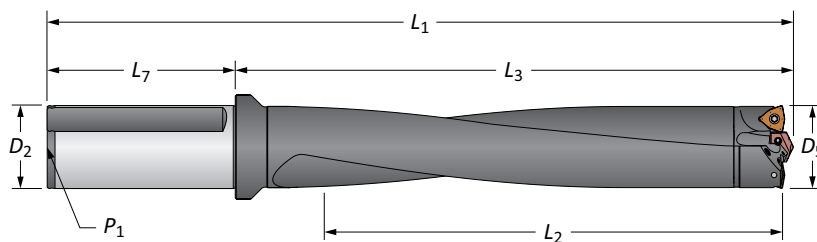

Straight Shank

	Length	D ₅	Body			Shank			Part No.
			L ₂	L ₃	L ₁	L ₇	D ₂	P ₁	
Ⓜ	3xD	57.00 - 62.99	181	242.5	322.5	80.0	50.0	6.35*	W5703H-50FM
	5xD	57.00 - 62.99	314	368.6	448.6	80.0	50.0	6.35*	W5705H-50FM
	8xD	57.00 - 62.99	502	558.0	638.0	80.0	50.0	6.35*	⚠ W5708H-50FM
	10xD	57.00 - 62.99	630	683.8	763.8	80.0	50.0	6.35*	⚠ W5710H-50FM
Ⓢ	3xD	2.2439 - 2.4799	7-1/8	9-35/64	14-1/16	4-1/2	2	1/4	W5703H-200F
	5xD	2.2439 - 2.4799	12-3/8	14-33/64	19-1/64	4-1/2	2	1/4	W5705H-200F
	8xD	2.2439 - 2.4799	19-3/4	21-31/32	26-15/32	4-1/2	2	1/4	⚠ W5708H-200F
	10xD	2.2439 - 2.4799	24-3/4	26-59/64	31-27/64	4-1/2	2	1/4	⚠ W5710H-200F

*Thread to RSP and ISO 7-1

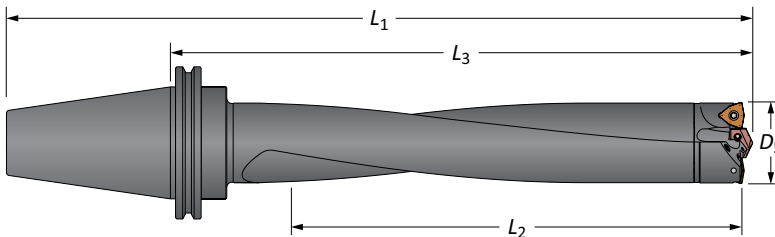

CV50 Shank

	Length	D ₅		Body			Shank	Part No.
		mm	inch	L ₂	L ₃	L ₁		
Ⓢ	3xD	57.00 - 62.99	2.2439 - 2.4799	7-1/8	10-17/32	14-17/32	CV50	W5703H-CV50
	5xD	57.00 - 62.99	2.2439 - 2.4799	12-3/8	15-31/64	19-31/64	CV50	W5705H-CV50
	8xD	57.00 - 62.99	2.2439 - 2.4799	19-7/8	22-15/16	26-15/16	CV50	⚠ W5708H-CV50
	10xD	57.00 - 62.99	2.2439 - 2.4799	24-3/4	27-57/64	31-57/64	CV50	⚠ W5710H-CV50

Connection Accessories

		Admissible Tightening Torque*
Mounting Screw 75020-IP20-1	Mounting Screw Driver 8IP-20	
		678 N-cm (60 in-lb)

*Tightening torques are calculated with a friction coefficient of $\mu = 0.14$ and develop 90% of ultimate yield strength

⚠ WARNING Refer to Speed and Feed charts for recommended adjustments to speeds and feeds. Refer to page A50: 30 for deep hole drilling guidelines in this section of the catalogue. Visit www.alliedmachine.com for the most up-to-date information and procedures. Factory technical assistance is available for your specific applications through our Application Engineering Team.

Ⓜ = Metric (mm)
Ⓢ = Imperial (in)

Mounting screws sold in multiples of 4

A

DRILLING

B

BORING

C

REAMING

D

BURNISHING

F

THREADING

X

SPECIALS



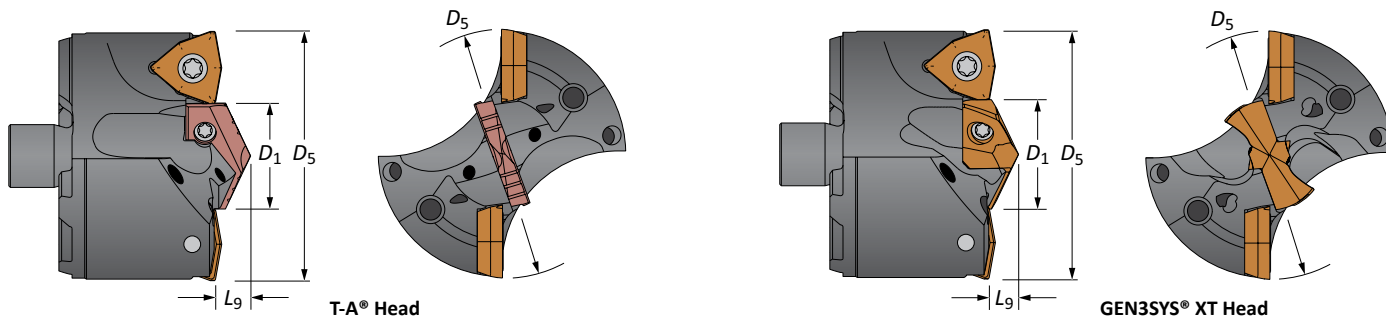

APX Drill Heads

63 Series | Diameter Range: 63.00mm - 69.99mm (2.4800" - 2.755")





Heads

Head					T-A® Head			GEN3SYS®XT Head			IC Insert Size
D ₅ mm	D ₅ inch	D ₅ fractional	D ₁	L ₉	Part No.	Pilot Series	 Pilot Insert	Part No.	Pilot Series	 Pilot Insert	
63.00	2.4803	–	28.5	11.11	V6302D-63	2	4C*2H-28.5	V6326D-63	26	7C*26P-28.5	14.29
63.50	2.5000	2-1/2	28.5	11.11	V6302D-0216	2	4C*2H-28.5	V6326D-0216	26	7C*26P-28.5	14.29
64.00	2.5197	–	28.5	11.11	V6302D-64	2	4C*2H-28.5	V6326D-64	26	7C*26P-28.5	14.29
64.29	2.5313	2-17/32	28.5	11.11	V6302D-0217	2	4C*2H-28.5	V6326D-0217	26	7C*26P-28.5	14.29
65.00	2.5591	–	28.5	11.11	V6302D-65	2	4C*2H-28.5	V6326D-65	26	7C*26P-28.5	14.29
65.09	2.5625	2-9/16	31	11.11	V6302D-0218	2	4C*2H-31	V6329D-0218	29	7C*29P-31	14.29
65.88	2.5938	2-19/32	31	11.11	V6302D-0219	2	4C*2H-31	V6329D-0219	29	7C*29P-31	14.29
66.00	2.5984	–	31	11.11	V6302D-66	2	4C*2H-31	V6329D-66	29	7C*29P-31	14.29
66.68	2.6250	2-5/8	31	11.11	V6302D-0220	2	4C*2H-31	V6329D-0220	29	7C*29P-31	14.29
67.00	2.6378	–	32	11.11	V6302D-67	2	4C*2H-32	V6329D-67	29	7C*29P-32	14.29
67.47	2.6563	2-21/32	32	11.11	V6302D-0221	2	4C*2H-32	V6329D-0221	29	7C*29P-32	14.29
68.00	2.6772	–	32	11.11	V6302D-68	2	4C*2H-32	V6329D-68	29	7C*29P-32	14.29
68.26	2.6875	2-11/16	32	11.11	V6302D-0222	2	4C*2H-32	V6329D-0222	29	7C*29P-32	14.29
69.00	2.7165	–	34	11.11	V6302D-69	2	4C*2H-34	V6332D-69	32	7C*32P-34	14.29
69.06	2.7188	2-23/32	34	11.11	V6302D-0223	2	4C*2H-34	V6332D-0223	32	7C*32P-34	14.29
69.85	2.7500	2-3/4	34	11.11	V6302D-0224	2	4C*2H-34	V6332D-0224	32	7C*32P-34	14.29



*Denotes carbide grade (1 = K35, 2 = K20)

IC Inserts

Coating	Size	Grade	Geometry	 Part No.	 Insert Screw	 Insert Driver	Admissible Tightening Torque*
AM300®	14.29	P35	Standard	OP-090608-PW	75014-IP20-1	8IP-20	1370 N-cm (121.0 in-lbs)
AM300®	14.29	K35	Standard	OP-090608-1PW	75014-IP20-1	8IP-20	1370 N-cm (121.0 in-lbs)
AM300®	14.29	P35	High Rake	OP-090608-PWHR	75014-IP20-1	8IP-20	1370 N-cm (121.0 in-lbs)
AM300®	14.29	P35	High Impact	OP-090608-PWHI	75014-IP20-1	8IP-20	1370 N-cm (121.0 in-lbs)

*Tightening torques are calculated with a friction coefficient of $\mu = 0.14$ and develop 90% of ultimate yield strength

Pilot Accessories

Pilot Style	Series	 Insert Screws	 Insert Driver	Admissible Tightening Torque*
T-A®	2	7495-IP15-1	8IP-15	690 N-cm (61.0 in-lbs)
GEN3SYS®	26	7495-IP15-1	8IP-15	690 N-cm (61.0 in-lbs)
GEN3SYS®	29	7495-IP15-1	8IP-15	690 N-cm (61.0 in-lbs)
GEN3SYS®	32	7495-IP15-1	8IP-15	690 N-cm (61.0 in-lbs)

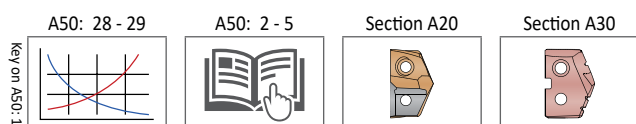
*Tightening torques are calculated with a friction coefficient of $\mu = 0.14$ and develop 90% of ultimate yield strength

Non-stocked diameters are also available. Follow the examples shown below. Surcharge applicable to special diameters.

Metric	38 series, T-A® (1 series), 42.15mm	Part No. = V3801D-42.15
Inch	38 series, T-A® (1 series), 1.6790"	Part No. = V3801D-1.6790

APX Drill Holders

63 Series | Diameter Range: 63.00mm - 69.99mm (2.4800" - 2.755")

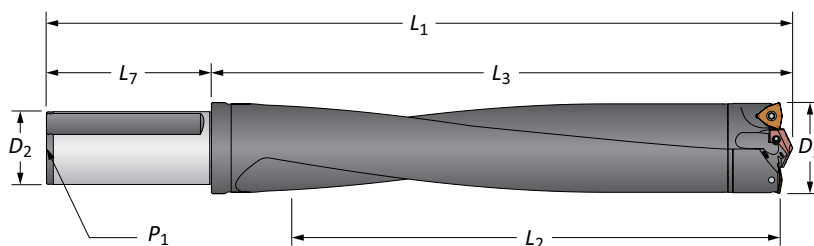

Straight Shank

	Length	D ₅	Body			Shank			Part No.
			L ₂	L ₃	L ₁	L ₇	D ₂	P ₁	
Ⓜ	3xD	63.00 - 69.99	200	262.6	342.6	80.0	50.0	6.35*	W6303H-50FM
	5xD	63.00 - 69.99	350	402.6	482.6	80.0	50.0	6.35*	W6305H-50FM
	8xD	63.00 - 69.99	560	612.6	692.6	80.0	50.0	6.35*	⚠ W6308H-50FM
	10xD	63.00 - 69.99	688	740.9	820.9	80.0	50.0	6.35*	⚠ W6310H-50FM
Ⓜ	3xD	2.4800 - 2.7555	7-7/8	10-11/32	14-27/32	4-1/2	2	1/4	W6303H-200F
	5xD	2.4800 - 2.7555	13-3/4	15-27/32	20-11/32	4-1/2	2	1/4	W6305H-200F
	8xD	2.4800 - 2.7555	22-1/8	24-1/8	28-5/8	4-1/2	2	1/4	⚠ W6308H-200F
	10xD	2.4800 - 2.7555	27-1/8	29-11/64	33-43/64	4-1/2	2	1/4	⚠ W6310H-200F

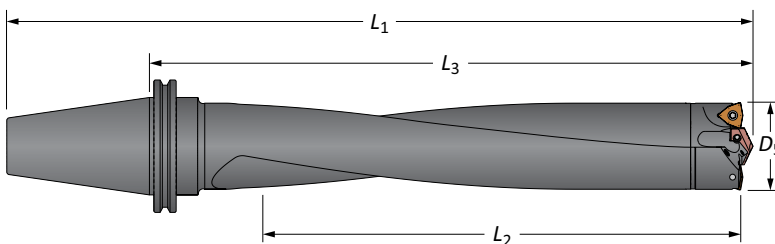

*Thread to BSP and ISO 7-1



CV50 Shank

	Length	D ₅		Body			Shank	Part No.
		mm	inch	L ₂	L ₃	L ₁		
Ⓜ	3xD	63.00 - 69.99	2.4800 - 2.7555	7-7/8	11-7/16	15-7/16	CV50	W6303H-CV50
	5xD	63.00 - 69.99	2.4800 - 2.7555	13-3/4	16-15/16	20-15/16	CV50	W6305H-CV50
	8xD	63.00 - 69.99	2.4800 - 2.7555	22	25-13/64	29-13/64	CV50	⚠ W6308H-CV50
	10xD	63.00 - 69.99	2.4800 - 2.7555	26-1/2	29-43/64	33-43/64	CV50	⚠ W6310H-CV50

Connection Accessories

 Mounting Screw	 Mounting Screw Driver	Admissible Tightening Torque*
75020-IP20-1	8IP-20	678 N-cm (60 in-lb)

*Tightening torques are calculated with a friction coefficient of $\mu = 0.14$ and develop 90% of ultimate yield strength

⚠ WARNING Refer to Speed and Feed charts for recommended adjustments to speeds and feeds. Refer to page A50: 30 for deep hole drilling guidelines in this section of the catalogue. Visit www.alliedmachine.com for the most up-to-date information and procedures. Factory technical assistance is available for your specific applications through our Application Engineering Team.

Ⓜ = Metric (mm)
Ⓜ = Imperial (in)

Mounting screws sold in multiples of 4

A DRILLING
B BORING
C REAMING
D BURNISHING
E THREADING
X SPECIALS



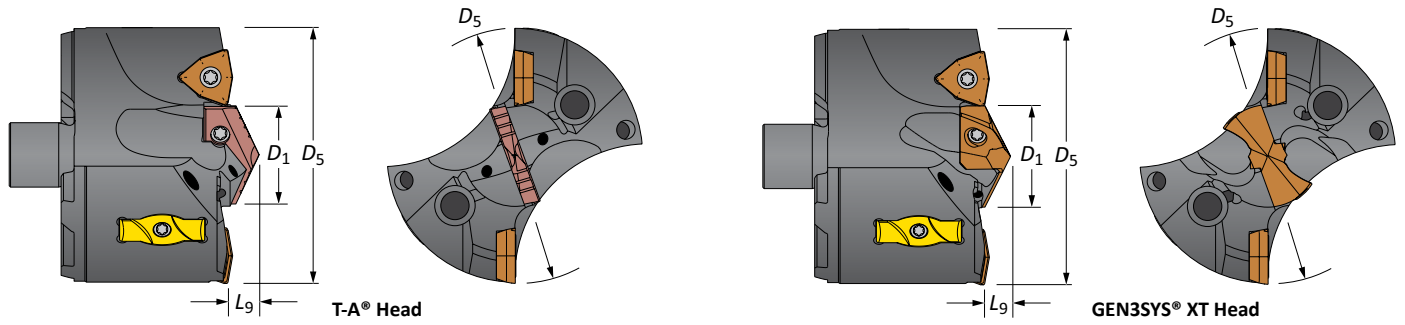

APX Drill Heads

70 Series | Diameter Range: 70.00mm - 75.99mm (2.7556" - 2.9917")





Heads

Head					T-A® Head			GEN3SYS®XT Head			IC Insert Size
D_5 mm	D_5 inch	D_5 fractional	D_1	L_9	Part No.	Pilot Series	 Pilot Insert	Part No.	Pilot Series	 Pilot Insert	
70.00	2.7559	-	31	9.92	V7002S-70	2	4C*2H-31	V7029S-70	29	7C*29P-31	9.53
71.44	2.8125	2-13/16	31	9.92	V7002S-0226	2	4C*2H-31	V7029S-0226	29	7C*29P-31	9.53
72.00	2.8346	-	31	9.92	V7002S-72	2	4C*2H-31	V7029S-72	29	7C*29P-31	9.53
73.03	2.8750	2-7/8	31	9.92	V7002S-0228	2	4C*2H-31	V7029S-0228	29	7C*29P-31	9.53
74.00	2.9134	-	31	9.92	V7002S-74	2	4C*2H-31	V7029S-74	29	7C*29P-31	9.53
74.61	2.9375	2-15/16	31	9.92	V7002S-0230	2	4C*2H-31	V7029S-0230	29	7C*29P-31	9.53



*Denotes carbide grade (1 = K35, 2 = K20)

IC Inserts

Coating	Size	Grade	Geometry	 Part No.	 Insert Screw	 Insert Driver	Admissible Tightening Torque*
AM300®	9.53	P35	Standard	OP-060408-PW	73595-IP15-1	8IP-15	465 N-cm (41.0 in-lbs)
AM300®	9.53	K35	Standard	OP-060408-1PW	73595-IP15-1	8IP-15	465 N-cm (41.0 in-lbs)
AM300®	9.53	P35	High Rake	OP-060408-PWHR	73595-IP15-1	8IP-15	465 N-cm (41.0 in-lbs)
AM300®	9.53	P35	High Impact	OP-060408-PWHI	73595-IP15-1	8IP-15	465 N-cm (41.0 in-lbs)



*Tightening torques are calculated with a friction coefficient of $\mu = 0.14$ and develop 90% of ultimate yield strength

Wear Pads

 Part No.	 Wear Pad Screw	 Wear Pad Driver	Admissible Tightening Torque*
WP7095	7358-IP10-1	8IP-10	300 N-cm (27.0 in-lbs)

*Tightening torques are calculated with a friction coefficient of $\mu = 0.14$ and develop 90% of ultimate yield strength

Pilot Accessories

Pilot Style	Series	 Insert Screws	 Insert Driver	Admissible Tightening Torque*
T-A®	2	7495-IP15-1	8IP-15	690 N-cm (61.0 in-lbs)
GEN3SYS®	29	7495-IP15-1	8IP-15	690 N-cm (61.0 in-lbs)

*Tightening torques are calculated with a friction coefficient of $\mu = 0.14$ and develop 90% of ultimate yield strength

Non-stocked diameters are also available. Follow the examples shown below. Surcharge applicable to special diameters.

Metric	38 series, T-A® (1 series), 42.15mm	Part No. = V3801D-42.15
Inch	38 series, T-A® (1 series), 1.6790"	Part No. = V3801D-1.6790

Wear pads sold in multiples of 2 | Wear pad screws sold in multiples of 4
IC inserts sold in multiples of 2 | Insert screws sold in multiples of 10

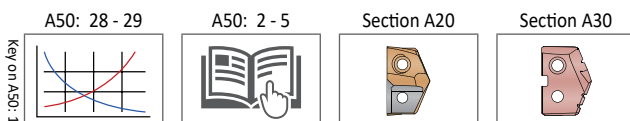

APX Drill Holders

70 Series | Diameter Range: 70.00mm - 75.99mm (2.7556" - 2.9917")

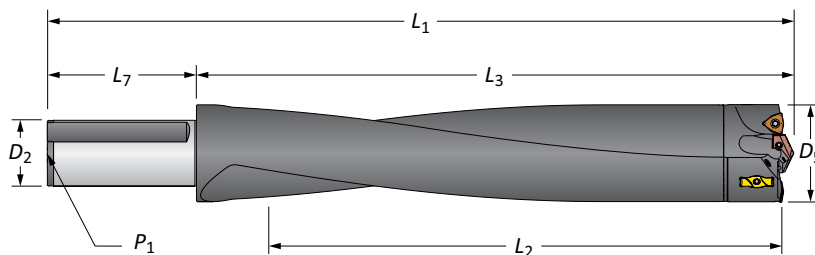

Straight Shank

	Length	D ₅	Body			Shank			Part No.
			L ₂	L ₃	L ₁	L ₇	D ₂	P ₁	
Ⓜ	3xD	70.00 - 75.99	219	269.0	349.0	80.0	50.0	6.35*	W7003H-50FM
	5xD	70.00 - 75.99	380	421.1	501.1	80.0	50.0	6.35*	W7005H-50FM
	8xD	70.00 - 75.99	608	649.0	729.0	80.0	50.0	6.35*	⚠ W7008H-50FM
	10xD	70.00 - 75.99	709	750.3	830.3	80.0	50.0	6.35*	⚠ W7010H-50FM
Ⓜ	3xD	2.7556 - 2.9917	8-3/4	10-19/32	15-3/32	4-1/2	2	1/4	W7003H-200F
	5xD	2.7556 - 2.9917	14-7/8	16-37/64	21-5/64	4-1/2	2	1/4	W7005H-200F
	8xD	2.7556 - 2.9917	23-7/8	25-35/64	30-3/64	4-1/2	2	1/4	⚠ W7008H-200F
	10xD	2.7556 - 2.9917	27-7/8	29-35/64	34-3/64	4-1/2	2	1/4	⚠ W7010H-200F

*Thread to BSP and ISO 7-1

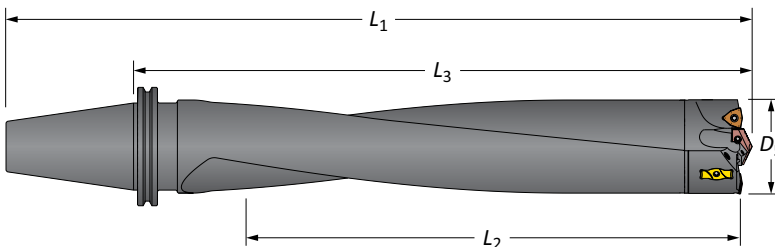

CV50 Shank

	Length	D ₅		Body			Shank	Part No.
		mm	inch	L ₂	L ₃	L ₁		
Ⓜ	3xD	70.00 - 75.99	2.7556 - 2.9917	8-3/4	12-7/32	16-7/32	CV50	W7003H-CV50
	5xD	70.00 - 75.99	2.7556 - 2.9917	14-7/8	18-13/64	22-13/64	CV50	W7005H-CV50
	8xD	70.00 - 75.99	2.7556 - 2.9917	23-7/8	27-5/32	31-5/32	CV50	⚠ W7008H-CV50
	10xD	70.00 - 75.99	2.7556 - 2.9917	26-3/4	29-61/64	33-61/64	CV50	⚠ W7010H-CV50

Connection Accessories

Mounting Screw	Mounting Screw Bit	Admissible Tightening Torque*
78027-IP30-1	8IP-30B	2825 N-cm (250 in-lb)

*Tightening torques are calculated with a friction coefficient of $\mu = 0.14$ and develop 90% of ultimate yield strength

⚠ WARNING Refer to Speed and Feed charts for recommended adjustments to speeds and feeds. Refer to page A50: 30 for deep hole drilling guidelines in this section of the catalogue. Visit www.alliedmachine.com for the most up-to-date information and procedures. Factory technical assistance is available for your specific applications through our Application Engineering Team.

Ⓜ = Metric (mm)
Ⓜ = Imperial (in)

Mounting screws sold in multiples of 4



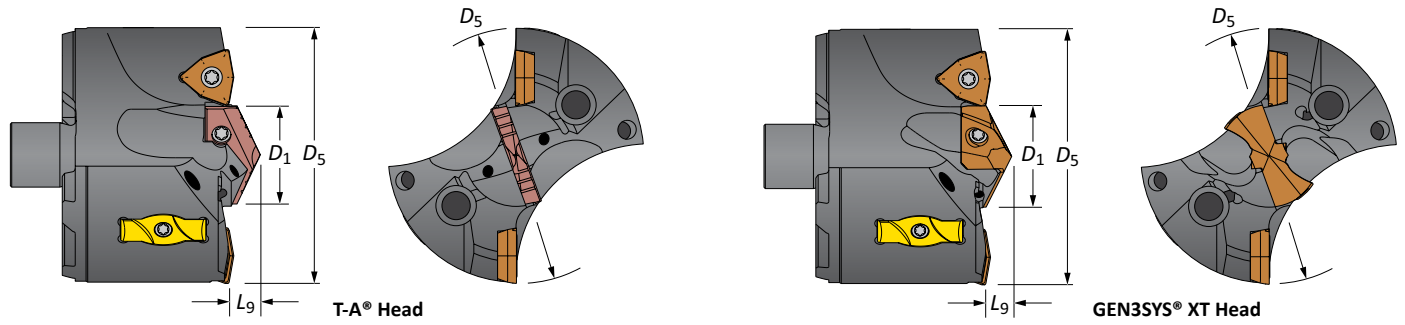

APX Drill Heads

76 Series | Diameter Range: 76.00mm - 82.99mm (2.9918" - 3.2673")





Heads

Head					T-A® Head			GEN3SYS®XT Head			IC Insert Size
D ₅ mm	D ₅ inch	D ₅ fractional	D ₁	L ₉	Part No.	Pilot Series		Part No.	Pilot Series		
76.00	2.9921	-	31	10.32	V7602S-76	2	4C*2H-31	V7629S-76	29	7C*29P-31	12.70
76.20	3.0000	3	31	10.32	V7602S-0300	2	4C*2H-31	V7629S-0300	29	7C*29P-31	12.70
77.79	3.0625	3-1/16	31	10.32	V7602S-0302	2	4C*2H-31	V7629S-0302	29	7C*29P-31	12.70
78.00	3.0709	-	31	10.32	V7602S-78	2	4C*2H-31	V7629S-78	29	7C*29P-31	12.70
79.38	3.1250	3-1/8	31	10.32	V7602S-0304	2	4C*2H-31	V7629S-0304	29	7C*29P-31	12.70
80.00	3.1496	-	31	10.32	V7602S-80	2	4C*2H-31	V7629S-80	29	7C*29P-31	12.70
80.96	3.1875	3-3/16	31	10.32	V7602S-0306	2	4C*2H-31	V7629S-0306	29	7C*29P-31	12.70
82.00	3.2282	-	31	10.32	V7602S-82	2	4C*2H-31	V7629S-82	29	7C*29P-31	12.70
82.55	3.2500	3.2500	31	10.32	V7602S-0308	2	4C*2H-31	V7629S-0308	29	7C*29P-31	12.70



*Denotes carbide grade (1 = K35, 2 = K20)

IC Inserts

Coating	Size	Grade	Geometry	 Part No.	 Insert Screw	 Insert Driver	Admissible Tightening Torque*
AM300®	12.70	P35	Standard	OP-080508-PW	74012-IP15-1	8IP-15	690 N-cm (61.0 in-lbs)
AM300®	12.70	K35	Standard	OP-080508-1PW	74012-IP15-1	8IP-15	690 N-cm (61.0 in-lbs)
AM300®	12.70	P35	High Rake	OP-080508-PWHR	74012-IP15-1	8IP-15	690 N-cm (61.0 in-lbs)
AM300®	12.70	P35	High Impact	OP-080508-PWHI	74012-IP15-1	8IP-15	690 N-cm (61.0 in-lbs)



*Tightening torques are calculated with a friction coefficient of $\mu = 0.14$ and develop 90% of ultimate yield strength

Wear Pads

 Part No.	 Wear Pad Screw	 Wear Pad Driver	Admissible Tightening Torque*
WP7095	7358-IP10-1	8IP-10	300 N-cm (27.0 in-lbs)

*Tightening torques are calculated with a friction coefficient of $\mu = 0.14$ and develop 90% of ultimate yield strength

Pilot Accessories

Pilot Style	Series	 Insert Screws	 Insert Driver	Admissible Tightening Torque*
T-A®	2	7495-IP15-1	8IP-15	690 N-cm (61.0 in-lbs)
GEN3SYS®	29	7495-IP15-1	8IP-15	690 N-cm (61.0 in-lbs)

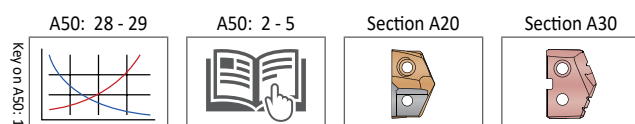
*Tightening torques are calculated with a friction coefficient of $\mu = 0.14$ and develop 90% of ultimate yield strength

Key on A50: 1

Non-stocked diameters are also available. Follow the examples shown below. Surcharge applicable to special diameters.

Metric	38 series, T-A® (1 series), 42.15mm	Part No. = V3801D-42.15
Inch	38 series, T-A® (1 series), 1.6790"	Part No. = V3801D-1.6790

Wear pads sold in multiples of 2 | Wear pad screws sold in multiples of 4
IC inserts sold in multiples of 2 | Insert screws sold in multiples of 10

APX Drill Holders

76 Series | Diameter Range: 76.00mm - 82.99mm (2.9918" - 3.2673")

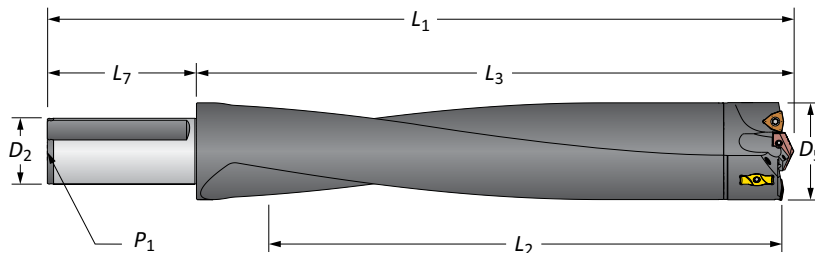

Straight Shank

	Length	D ₅	Body			Shank			Part No.
			L ₂	L ₃	L ₁	L ₇	D ₂	P ₁	
M	3xD	76.00 - 82.99	241	292.4	372.4	80.0	50.0	6.35*	W7603H-50FM
	5xD	76.00 - 82.99	415	458.2	538.2	80.0	50.0	6.35*	W7605H-50FM
	8xD	76.00 - 82.99	664	707.1	787.1	80.0	50.0	6.35*	W7608H-50FM
I	3xD	2.9918 - 3.2673	9-1/2	11-33/64	16-1/64	4-1/2	2	1/4	W7603H-200F
	5xD	2.9918 - 3.2673	16-3/8	18-3/64	22-35/64	4-1/2	2	1/4	W7605H-200F
	8xD	2.9918 - 3.2673	26-1/8	27-27/32	32-11/32	4-1/2	2	1/4	W7608H-200F

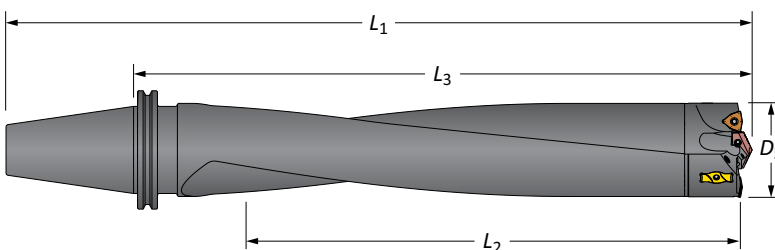

*Thread to BSP and ISO 7-1



CV50 Shank

	Length	D ₅		Body			Shank	Part No.
		mm	inch	L ₂	L ₃	L ₁		
I	3xD	76.00 - 82.99	2.9918 - 3.2673	9-1/2	12-57/64	16-57/64	CV50	W7603H-CV50
	5xD	76.00 - 82.99	2.9918 - 3.2673	16-3/8	19-27/64	23-27/64	CV50	W7605H-CV50
	8xD	76.00 - 82.99	2.9918 - 3.2673	26-1/8	29-7/32	33-7/32	CV50	W7608H-CV50

Connection Accessories

		Admissible Tightening Torque*
78027-IP30-1	8IP-30B	2825 N-cm (250 in-lb)

*Tightening torques are calculated with a friction coefficient of $\mu = 0.14$ and develop 90% of ultimate yield strength

WARNING Refer to Speed and Feed charts for recommended adjustments to speeds and feeds. Refer to page A50: 30 for deep hole drilling guidelines in this section of the catalogue. Visit www.alliedmachine.com for the most up-to-date information and procedures. Factory technical assistance is available for your specific applications through our Application Engineering Team.

M = Metric (mm)
I = Imperial (in)

Mounting screws sold in multiples of 4



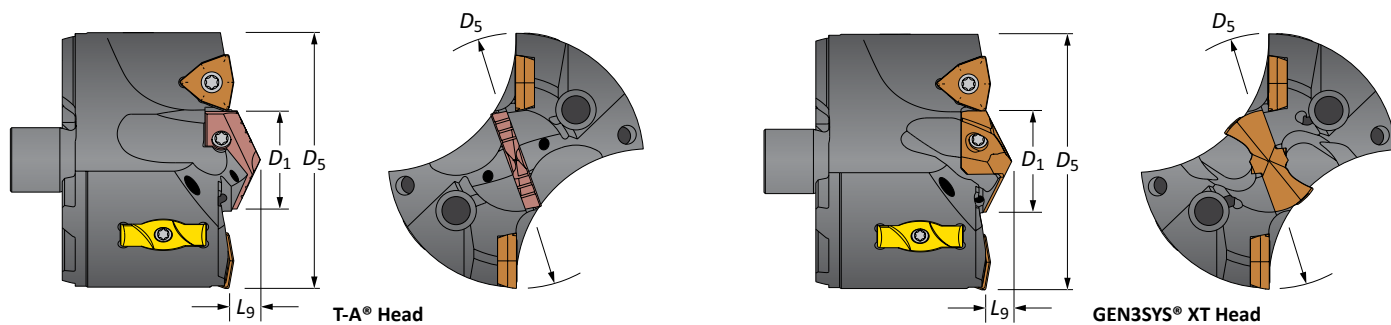

APX Drill Heads

83 Series | Diameter Range: 83.00mm - 88.99mm (3.2674" - 3.5035")





Heads

Head					T-A® Head			GEN3SYS®XT Head			IC Insert Size
D ₅ mm	D ₅ inch	D ₅ fractional	D ₁	L ₉	Part No.	Pilot Series		Part No.	Pilot Series		
84.00	3.3071	–	35	11.11	V8302S-84	2	4C*2H-35	V8332S-84	32	7C*32P-35	12.70
84.14	3.3125	3-5/16	35	11.11	V8302S-0310	2	4C*2H-35	V8332S-0310	32	7C*32P-35	12.70
85.73	3.3750	3-3/8	35	11.11	V8302S-0312	2	4C*2H-35	V8332S-0312	32	7C*32P-35	12.70
86.00	3.3859	–	35	11.11	V8302S-86	2	4C*2H-35	V8332S-86	32	7C*32P-35	12.70
87.31	3.4375	3-7/16	35	11.11	V8302S-0314	2	4C*2H-35	V8332S-0314	32	7C*32P-35	12.70
88.00	3.4646	–	35	11.11	V8302S-88	2	4C*2H-35	V8332S-88	32	7C*32P-35	12.70
88.90	3.5000	3-1/2	35	11.11	V8302S-0316	2	4C*2H-35	V8332S-0316	32	7C*32P-35	12.70

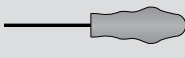

*Denotes carbide grade (1 = K35, 2 = K20)

IC Inserts

Coating	Size	Grade	Geometry	 Part No.	 Insert Screw	 Insert Driver	Admissible Tightening Torque*
AM300®	12.70	P35	Standard	OP-080508-PW	74012-IP15-1	8IP-15	690 N-cm (61.0 in-lbs)
AM300®	12.70	K35	Standard	OP-080508-1PW	74012-IP15-1	8IP-15	690 N-cm (61.0 in-lbs)
AM300®	12.70	P35	High Rake	OP-080508-PWHR	74012-IP15-1	8IP-15	690 N-cm (61.0 in-lbs)
AM300®	12.70	P35	High Impact	OP-080508-PWHI	74012-IP15-1	8IP-15	690 N-cm (61.0 in-lbs)

*Tightening torques are calculated with a friction coefficient of $\mu = 0.14$ and develop 90% of ultimate yield strength

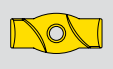
Wear Pads

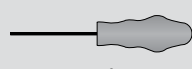
 Part No.	 Wear Pad Screw	 Wear Pad Driver	Admissible Tightening Torque*
WP7095	7358-IP10-1	8IP-10	300 N-cm (27.0 in-lbs)

*Tightening torques are calculated with a friction coefficient of $\mu = 0.14$ and develop 90% of ultimate yield strength

Pilot Accessories

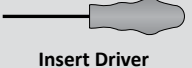
Pilot Style	Series	 Insert Screws	 Insert Driver	Admissible Tightening Torque*
T-A®	2	7495-IP15-1	8IP-15	690 N-cm (61.0 in-lbs)
GEN3SYS®	32	7495-IP15-1	8IP-15	690 N-cm (61.0 in-lbs)

*Tightening torques are calculated with a friction coefficient of $\mu = 0.14$ and develop 90% of ultimate yield strength

Non-stocked diameters are also available. Follow the examples shown below. Surcharge applicable to special diameters.

Metric	38 series, T-A® (1 series), 42.15mm	Part No. = V3801D-42.15
Inch	38 series, T-A® (1 series), 1.6790"	Part No. = V3801D-1.6790

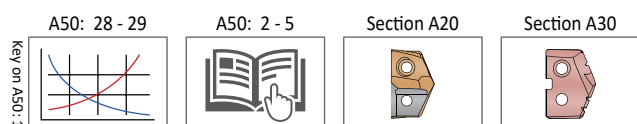

Wear pads sold in multiples of 2 | Wear pad screws sold in multiples of 4
IC inserts sold in multiples of 2 | Insert screws sold in multiples of 10

APX Drill Holders

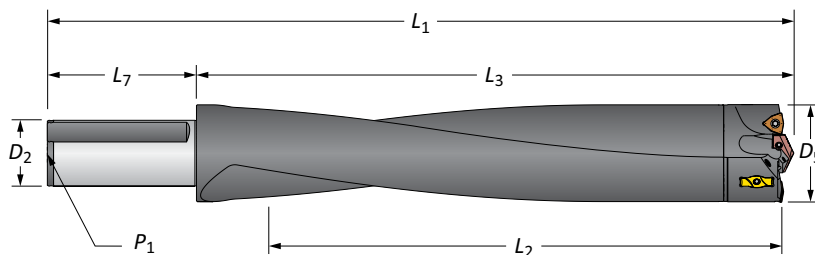
83 Series | Diameter Range: 83.00mm - 88.99mm (3.2674" - 3.5035")



Straight Shank

	Length	D ₅	Body			Shank			Part No.
			L ₂	L ₃	L ₁	L ₇	D ₂	P ₁	
Ⓜ	3xD	83.00 - 88.99	258	312.5	392.6	80.0	50.0	6.35*	W8303H-50FM
	5xD	83.00 - 88.99	445	490.5	570.5	80.0	50.0	6.35*	W8305H-50FM
	8xD	83.00 - 88.99	705	750.3	830.3	80.0	50.0	6.35*	 W8308H-50FM
Ⓢ	3xD	3.2674 - 3.5035	10-1/8	12-5/16	16-13/16	4-1/2	2	1/4	W8303H-200F
	5xD	3.2674 - 3.5035	17-1/2	19-5/16	23-13/16	4-1/2	2	1/4	W8305H-200F
	8xD	3.2674 - 3.5035	27-3/4	29-35/64	34-3/64	4-1/2	2	1/4	 W8308H-200F

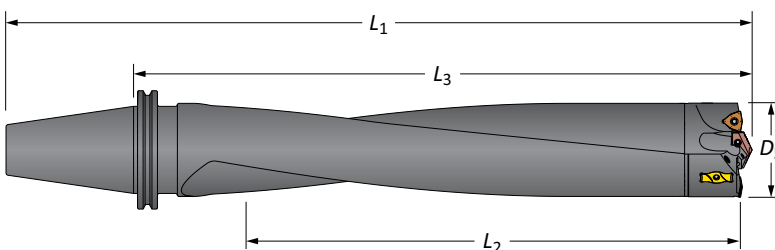

*Thread to BSP and ISO 7-1



CV50 Shank

	Length	D ₅		Body			Shank	Part No.
		mm	inch	L ₂	L ₃	L ₁		
Ⓢ	3xD	83.00 - 88.99	3.2674 - 3.5035	10-1/8	13-11/16	17-11/16	CV50	W8303H-CV50
	5xD	83.00 - 88.99	3.2674 - 3.5035	17-1/2	20-11/16	24-11/16	CV50	W8305H-CV50
	8xD	83.00 - 88.99	3.2674 - 3.5035	26-7/8	30-3/64	34-3/64	CV50	 W8308H-CV50

Connection Accessories

 Mounting Screw	 Mounting Screw Bit	Admissible Tightening Torque*
78027-IP30-1	8IP-30B	2825 N-cm (250 in-lb)

*Tightening torques are calculated with a friction coefficient of $\mu = 0.14$ and develop 90% of ultimate yield strength

 **WARNING** Refer to Speed and Feed charts for recommended adjustments to speeds and feeds. Refer to page A50: 30 for deep hole drilling guidelines in this section of the catalogue. Visit www.alliedmachine.com for the most up-to-date information and procedures. Factory technical assistance is available for your specific applications through our Application Engineering Team.

Ⓜ = Metric (mm)
Ⓢ = Imperial (in)

Mounting screws sold in multiples of 4

A DRILLING
B BORING
C REAMING
D BURNISHING
E THREADING
X SPECIALS

89

DRILLING | APX Drill deep hole / large diameter replaceable insert drilling system

APX Drill Heads

89 Series | Diameter Range: 89.00mm - 94.99mm (3.5036" - 3.7400")

T-A® Head **GEN3SYS® XT Head**

Heads

Head					T-A® Head			GEN3SYS®XT Head			IC Insert Size
D_5 mm	D_5 inch	D_5 fractional	D_1	L_9	Part No.	Pilot Series		Part No.	Pilot Series		
90.00	3.5433	—	32	10.72	V8902S-90	2		V8929S-90	29		
90.49	3.5625	3-9/16	32	10.72	V8902S-0318	2		V8929S-0318	29		
92.00	3.6220	—	32	10.72	V8902S-92	2		V8929S-92	29		
92.08	3.6250	3-5/8	32	10.72	V8902S-0320	2		V8929S-0320	29		
93.66	3.6875	3-11/16	32	10.72	V8902S-0322	2		V8929S-0322	29		
94.00	3.7008	—	32	10.72	V8902S-94	2		V8929S-94	29		

*Denotes carbide grade (1 = K35, 2 = K20)

IC Inserts

Coating	Size	Grade	Geometry	 Part No.	 Insert Screw	 Insert Driver	Admissible Tightening Torque*
AM300®	14.29	P35	Standard	OP-090608-PW	75014-IP20-1	8IP-20	1370 N-cm (121.0 in-lbs)
AM300®	14.29	K35	Standard	OP-090608-1PW	75014-IP20-1	8IP-20	1370 N-cm (121.0 in-lbs)
AM300®	14.29	P35	High Rake	OP-090608-PWHR	75014-IP20-1	8IP-20	1370 N-cm (121.0 in-lbs)
AM300®	14.29	P35	High Impact	OP-090608-PWHI	75014-IP20-1	8IP-20	1370 N-cm (121.0 in-lbs)

 *Tightening torques are calculated with a friction coefficient of $\mu = 0.14$ and develop 90% of ultimate yield strength

Wear Pads

 Part No.	 Wear Pad Screw	 Wear Pad Driver	Admissible Tightening Torque*
WP7095	7358-IP10-1	8IP-10	300 N-cm (27.0 in-lbs)

 *Tightening torques are calculated with a friction coefficient of $\mu = 0.14$ and develop 90% of ultimate yield strength

Pilot Accessories

Pilot Style	Series	 Insert Screws	 Insert Driver	Admissible Tightening Torque*
T-A®	2	7495-IP15-1	8IP-15	690 N-cm (61.0 in-lbs)
GEN3SYS®	29	7495-IP15-1	8IP-15	690 N-cm (61.0 in-lbs)

 *Tightening torques are calculated with a friction coefficient of $\mu = 0.14$ and develop 90% of ultimate yield strength

Non-stocked diameters are also available. Follow the examples shown below. Surcharge applicable to special diameters.

Metric	38 series, T-A® (1 series), 42.15mm	Part No. = V3801D-42.15
Inch	38 series, T-A® (1 series), 1.6790"	Part No. = V3801D-1.6790

 Wear pads sold in multiples of 2 | Wear pad screws sold in multiples of 4
 IC inserts sold in multiples of 2 | Insert screws sold in multiples of 10

Key on A50:1

A50: 28 - 29

A50: 2 - 5

Section A20

Section A30

A50: 24

www.alliedmachine.com | +44 (0) 1384 400 900 | enquiries.eu@alliedmachine.com

APX Drill Holders

89 Series | Diameter Range: 89.00mm - 94.99mm (3.5036" - 3.7400")

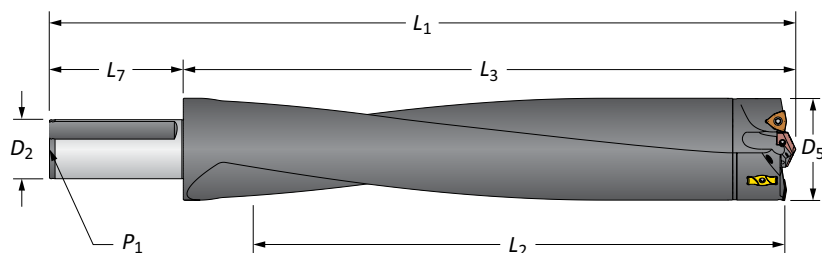

Straight Shank

	Length	D_5		Body			Shank			Part No.
		mm	inch	L_2	L_3	L_1	L_7	D_2	P_1	
M	3xD	89.00 - 94.99		276	333.4	413.4	80.0	50.0	6.35*	W8903H-50FM
	5xD	89.00 - 94.99		475	523.7	603.7	80.0	50.0	6.35*	W8905H-50FM
	8xD	89.00 - 94.99		702	750.5	830.5	80.0	50.0	6.35*	⚠ W8908H-50FM
i	3xD	3.5036 - 3.7400		10-7/8	13-1/8	17-5/8	4-1/2	2	1/4	W8903H-200F
	5xD	3.5036 - 3.7400		18-5/8	20-5/8	25-1/8	4-1/2	2	1/4	W8905H-200F
	8xD	3.5036 - 3.7400		27-5/8	29-35/64	34-3/64	4-1/2	2	1/4	⚠ W8908H-200F

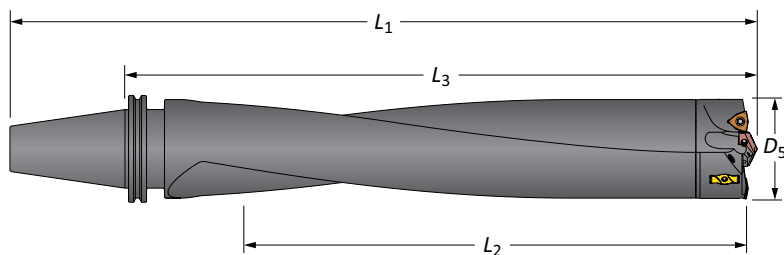

*Thread to BSP and ISO 7-1



CV50 Shank

	Length	D_5		Body			Shank	Part No.
		mm	inch	L_2	L_3	L_1		
i	3xD	89.00 - 94.99	3.5036 - 3.7400	10-7/8	14-33/64	18-33/64	CV50	W8903H-CV50
	5xD	89.00 - 94.99	3.5036 - 3.7400	18-5/8	22	26	CV50	W8905H-CV50
	8xD	89.00 - 94.99	3.5036 - 3.7400	26-3/4	30-1/32	34-1/32	CV50	⚠ W8908H-CV50

Connection Accessories

		Admissible Tightening Torque*
78027-IP30-1	8IP-30B	2825 N-cm (250 in-lb)

*Tightening torques are calculated with a friction coefficient of $\mu = 0.14$ and develop 90% of ultimate yield strength

⚠ WARNING Refer to Speed and Feed charts for recommended adjustments to speeds and feeds. Refer to page A50: 30 for deep hole drilling guidelines in this section of the catalogue. Visit www.alliedmachine.com for the most up-to-date information and procedures. Factory technical assistance is available for your specific applications through our Application Engineering Team.

M = Metric (mm)
i = Imperial (in)

Mounting screws sold in multiples of 4



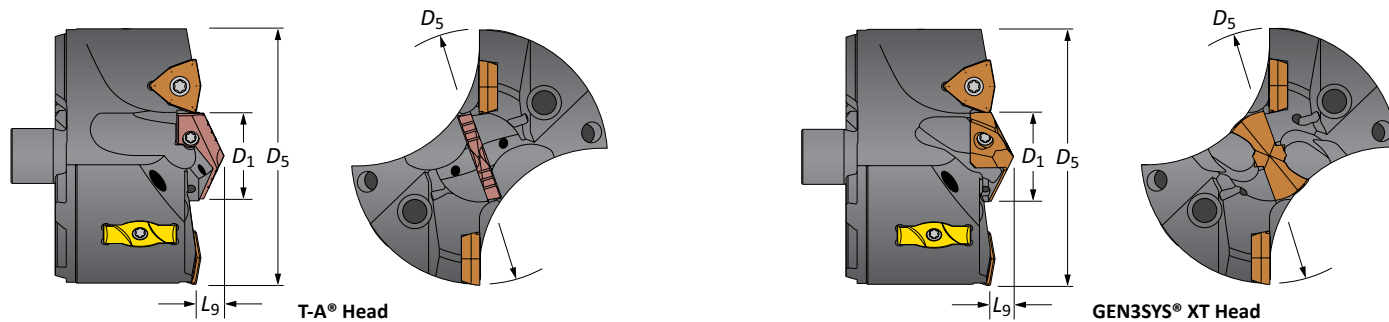

APX Drill Heads

95 Series | Diameter Range: 95.00mm - 101.60mm (3.7401" - 4.0000")





Heads

Head					T-A® Head			GEN3SYS®XT Head			IC Insert Size
D ₅ mm	D ₅ inch	D ₅ fractional	D ₁	L ₉	Part No.	Pilot Series	 Pilot Insert	Part No.	Pilot Series	 Pilot Insert	
95.25	3.7500	3-3/4	35	11.51	V9502S-0324	2	4C*2H-35	V9532S-0324	32	7C*32P-35	14.29
96.00	3.7795	-	35	11.51	V9502S-96	2	4C*2H-35	V9532S-96	32	7C*32P-35	14.29
96.84	3.8125	3-13/16	35	11.51	V9502S-0326	2	4C*2H-35	V9532S-0326	32	7C*32P-35	14.29
98.00	3.8583	-	35	11.51	V9502S-98	2	4C*2H-35	V9532S-98	32	7C*32P-35	14.29
98.43	3.8750	3-7/8	35	11.51	V9502S-0328	2	4C*2H-35	V9532S-0328	32	7C*32P-35	14.29
100.00	3.9370	-	35	11.51	V9502S-100	2	4C*2H-35	V9532S-100	32	7C*32P-35	14.29
100.01	3.9375	3-15/16	35	11.51	V9502S-0330	2	4C*2H-35	V9532S-0330	32	7C*32P-35	14.29
101.60	4.0000	4	35	11.51	V9502S-0400	2	4C*2H-35	V9532S-0400	32	7C*32P-35	14.29

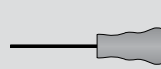

*Denotes carbide grade (1 = K35, 2 = K20)

IC Inserts

Coating	Size	Grade	Geometry	 Part No.	 Insert Screw	 Insert Driver	Admissible Tightening Torque*
AM300®	14.29	P35	Standard	OP-090608-PW	75014-IP20-1	8IP-20	1370 N-cm (121.0 in-lbs)
AM300®	14.29	K35	Standard	OP-090608-1PW	75014-IP20-1	8IP-20	1370 N-cm (121.0 in-lbs)
AM300®	14.29	P35	High Rake	OP-090608-PWHR	75014-IP20-1	8IP-20	1370 N-cm (121.0 in-lbs)
AM300®	14.29	P35	High Impact	OP-090608-PWHI	75014-IP20-1	8IP-20	1370 N-cm (121.0 in-lbs)

*Tightening torques are calculated with a friction coefficient of $\mu = 0.14$ and develop 90% of ultimate yield strength

Wear Pads

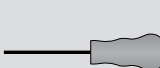
 Part No.	 Wear Pad Screw	 Wear Pad Driver	Admissible Tightening Torque*
WP7095	7358-IP10-1	8IP-10	300 N-cm (27.0 in-lbs)

*Tightening torques are calculated with a friction coefficient of $\mu = 0.14$ and develop 90% of ultimate yield strength

Pilot Accessories

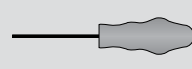
Pilot Style	Series	 Insert Screws	 Insert Driver	Admissible Tightening Torque*
T-A®	2	7495-IP15-1	8IP-15	690 N-cm (61.0 in-lbs)
GEN3SYS®	32	7495-IP15-1	8IP-15	690 N-cm (61.0 in-lbs)

*Tightening torques are calculated with a friction coefficient of $\mu = 0.14$ and develop 90% of ultimate yield strength

Non-stocked diameters are also available. Follow the examples shown below. Surcharge applicable to special diameters.

Metric	38 series, T-A® (1 series), 42.15mm	Part No. = V3801D-42.15
Inch	38 series, T-A® (1 series), 1.6790"	Part No. = V3801D-1.6790

Wear pads sold in multiples of 2 | Wear pad screws sold in multiples of 4
IC inserts sold in multiples of 2 | Insert screws sold in multiples of 10

A50: 28 - 29

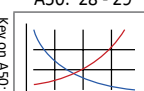

A50: 2 - 5



Section A200



Section A300

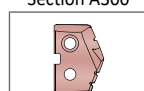

APX Drill Holders

95 Series | Diameter Range: 95.00mm - 101.60mm (3.7401" - 4.0000")

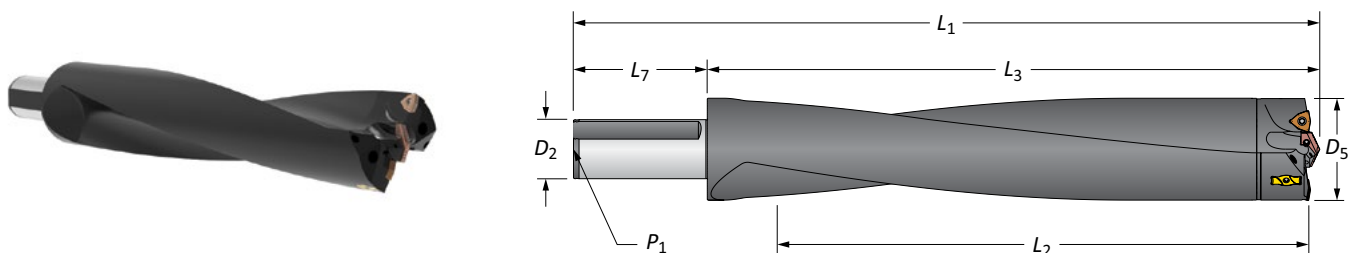

Straight Shank

	Length	D ₅	Body			Shank			Part No.
			L ₂	L ₃	L ₁	L ₇	D ₂	P ₁	
m	3xD	95.00 - 101.60	302	362.8	442.8	80.0	50.0	6.35*	W9503H-50FM
	5xD	95.00 - 101.60	508	566.2	646.2	80.0	50.0	6.35*	W9505H-50FM
	8xD	95.00 - 101.60	699	756.7	836.7	80.0	50.0	6.35*	⚠ W9508H-50FM
i	3xD	3.7401 - 4.0000	11-7/8	14-9/32	18-25/32	4-1/2	2	1/4	W9503H-200F
	5xD	3.7401 - 4.0000	20	22-19/64	26-51/64	4-1/2	2	1/4	W9505H-200F
	8xD	3.7401 - 4.0000	27-1/2	29-51/64	34-19/64	4-1/2	2	1/4	⚠ W9508H-200F

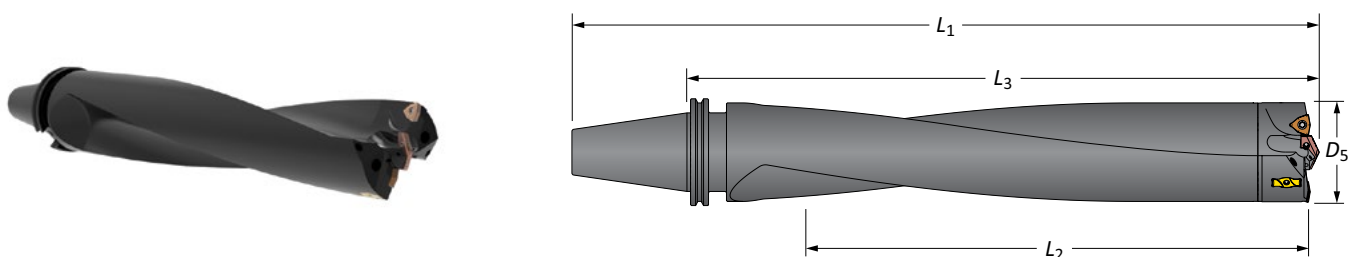

*Thread to BSP and ISO 7-1



CV50 Shank

	Length	D ₅		Body			Shank	Part No.
		mm	inch	L ₂	L ₃	L ₁		
i	3xD	95.00 - 101.60	3.7401 - 4.0000	11-7/8	15-43/64	19-43/64	CV50	W9503H-CV50
	5xD	95.00 - 101.60	3.7401 - 4.0000	20	23-43/64	27-43/64	CV50	W9505H-CV50
	8xD	95.00 - 101.60	3.7401 - 4.0000	26-5/8	30-9/32	34-9/32	CV50	⚠ W9508H-CV50

Connection Accessories

		Admissible Tightening Torque*
78027-IP30-1	8IP-30B	2825 N-cm (250 in-lb)

*Tightening torques are calculated with a friction coefficient of $\mu = 0.14$ and develop 90% of ultimate yield strength

⚠ WARNING Refer to Speed and Feed charts for recommended adjustments to speeds and feeds. Refer to page A50: 30 for deep hole drilling guidelines in this section of the catalogue. Visit www.alliedmachine.com for the most up-to-date information and procedures. Factory technical assistance is available for your specific applications through our Application Engineering Team.

 = Metric (mm)
 = Imperial (in)

Mounting screws sold in multiples of 4



Recommended Drilling Data | Metric (mm)

ISO	Material	Hardness (BHN)	Kg	N/mm ²	Feed Rate (mm/rev) by Diameter								
					Outboard Insert		7.94 IC	9.52 IC	12.70 IC	14.29 IC	9.52 IC	12.70 IC	14.29 IC
					Series		33	38 - 44	44 - 51	51 - 57 - 63	70	76 - 83	89 - 95
					Speed (M/min)	Pilot Style	33.00 - 37.99	38.00 - 47.88	47.89 - 56.13	56.14 - 69.99	70.00 - 75.99	76.00 - 88.99	89.00 - 101.60
P	Free Machining Steel 1118, 1215, 12L14, etc.	100 - 250	38-88	370-870	137 - 229	T-A*/GEN3SYS®	0.15 - 0.28	0.18 - 0.30	0.23 - 0.30	0.23 - 0.30	0.15 - 0.25	0.18 - 0.28	0.18 - 0.30
	Low Carbon Steel 1010, 1020, 1025, 1522, 1144, etc.	85 - 275	30-96	300-940	137 - 229	T-A*/GEN3SYS®	0.15 - 0.28	0.18 - 0.30	0.23 - 0.30	0.23 - 0.30	0.15 - 0.25	0.18 - 0.28	0.18 - 0.30
	Medium Carbon Steel 1030, 1040, 1050, 1527, 1140, 1151, etc.	125 - 325	46-111	450-1090	137 - 229	T-A*/GEN3SYS®	0.15 - 0.28	0.18 - 0.30	0.23 - 0.30	0.23 - 0.30	0.15 - 0.25	0.18 - 0.28	0.18 - 0.30
	Alloy Steel 4140, 5140, 8640, etc.	125 - 375	46-129	450-1265	122 - 213	T-A*/GEN3SYS®	0.13 - 0.18	0.13 - 0.23	0.18 - 0.25	0.18 - 0.28	0.13 - 0.23	0.15 - 0.25	0.15 - 0.25
	High Strength Alloy 4340, 4330V, 300M, etc.	225 - 400	77-139	600-1365	91 - 152	T-A*/GEN3SYS®	0.13 - 0.15	0.13 - 0.18	0.13 - 0.20	0.15 - 0.23	0.13 - 0.18	0.13 - 0.20	0.15 - 0.20
	Structural Steel A36, A285, A516, etc.	100 - 350	38-121	370-1180	137 - 229	T-A*/GEN3SYS®	0.15 - 0.20	0.18 - 0.23	0.20 - 0.25	0.23 - 0.28	0.13 - 0.23	0.15 - 0.25	0.18 - 0.25
	Tool Steel H-13, H-21, A-4, O-2, S-3, etc.	150 - 250	50-88	500-870	91 - 152	T-A*/GEN3SYS®	0.13 - 0.15	0.13 - 0.18	0.18 - 0.23	0.20 - 0.25	0.13 - 0.18	0.15 - 0.23	0.18 - 0.25
S	High Temp Alloy Hastelloy B, Inconel 600, etc.	140 - 310	49-101	480-990	61 - 122	T-A*	0.10 - 0.13	0.10 - 0.18	0.15 - 0.23	0.18 - 0.23	0.10 - 0.15	0.13 - 0.18	0.13 - 0.18
	Titanium Alloy	140 - 310	49-101	480-990	91 - 152	T-A*	0.13 - 0.18	0.15 - 0.20	0.18 - 0.23	0.20 - 0.25	0.10 - 0.15	0.13 - 0.18	0.13 - 0.18
	Aerospace Alloy S82	185 - 350	65-121	640-1180	122 - 183	T-A*	0.10 - 0.15	0.13 - 0.18	0.15 - 0.20	0.15 - 0.20	0.10 - 0.15	0.13 - 0.18	0.13 - 0.18
M	Stainless Steel 400 Series 416, 420, etc.	185 - 350	65-121	91-152	91 - 152	T-A*/GEN3SYS®	0.15 - 0.20	0.18 - 0.23	0.20 - 0.25	0.23 - 0.28	0.13 - 0.18	0.18 - 0.23	0.18 - 0.25
	Stainless Steel 300 Series 304, 316, 17-4PH, etc.	135 - 275	49-96	91-152	91 - 152	T-A*/GEN3SYS®	0.13 - 0.18	0.15 - 0.20	0.18 - 0.23	0.20 - 0.25	0.10 - 0.20	0.15 - 0.25	0.15 - 0.25
	Super Duplex Stainless Steel	135 - 275	49-96	76-137	76 - 137	T-A*/GEN3SYS®	0.10 - 0.15	0.13 - 0.18	0.18 - 0.23	0.18 - 0.23	0.10 - 0.18	0.15 - 0.23	0.18 - 0.25
H	Wear Plate Hardox, AR400, T-1, etc.	400 - 600	139-210	91-152	91 - 152	T-A*	0.07 - 0.13	0.10 - 0.15	0.15 - 0.20	0.18 - 0.23	0.08 - 0.13	0.10 - 0.15	0.10 - 0.15
	Hardened Steel	300 - 500	104-139+	91-152	91 - 152	T-A*	0.10 - 0.13	0.13 - 0.15	0.15 - 0.20	0.15 - 0.20	0.08 - 0.13	0.10 - 0.20	0.10 - 0.20
K	Nodular, Grey, Ductile Cast Iron	120 - 320	44-104	152-244	152 - 244	T-A*/GEN3SYS®	0.13 - 0.23	0.15 - 0.25	0.20 - 0.30	0.25 - 0.30	0.20 - 0.25	0.23 - 0.28	0.25 - 0.30
N	Cast Aluminium	30 - 180	10-62	183-244	183 - 244	T-A*/GEN3SYS®	0.23 - 0.30	0.25 - 0.36	0.30 - 0.40	0.30 - 0.40	0.15 - 0.23	0.20 - 0.28	0.20 - 0.30
	Wrought Aluminium	30 - 180	10-62	183-244	183 - 244	T-A*/GEN3SYS®	0.18 - 0.28	0.20 - 0.30	0.25 - 0.36	0.25 - 0.36	0.15 - 0.23	0.20 - 0.28	0.20 - 0.30
	Aluminium Bronze	100 - 250	38-87	123-213	123 - 213	T-A*/GEN3SYS®	0.13 - 0.18	0.13 - 0.20	0.18 - 0.25	0.23 - 0.28	0.15 - 0.23	0.18 - 0.25	0.20 - 0.30
	Brass	30 - 100	38	244	244	T-A*/GEN3SYS®	0.15 - 0.20	0.18 - 0.23	0.20 - 0.25	0.23 - 0.30	0.15 - 0.20	0.18 - 0.23	0.20 - 0.25
	Copper	60	21	213	213	T-A*/GEN3SYS®	0.05 - 0.13	0.08 - 0.15	0.15 - 0.20	0.20 - 0.25	0.08 - 0.15	0.15 - 0.20	0.15 - 0.20

Coolant Recommendations

Series	Pressure (BAR)	Flow Rate (LPM)
33	24	38
38	21	38
44	19	45
51	17	68
57	16	76
63	14	83
70	10	95
76	7	106
83	7	114
89	7	125
95	7	125

Calculations

Value	Formula
M/min	RPM • 0.003 • Diameter
RPM	(M/min • 318.47) / Diameter
mm/min	RPM • mm/rev

IMPORTANT: The speeds and feeds listed above are a general starting point for all applications. Refer to the Coolant Recommendation charts for coolant requirements to run at the recommended speeds and feeds. Factory technical assistance is also available through our Application Engineering Team.

IMPORTANT: The coolant pressure and flow rate recommendations above represent a good approximation to obtain optimum tool life and chip evacuation at Allied Machine recommended speeds and feeds. If lower coolant capabilities exist in a drilling application, the APX Drilling System will still function at reduced penetration rates. Contact our Application Engineering department for a more specific recommendation of coolant requirements and/or speeds and feeds.

⚠ WARNING Tool failure can cause serious injury. To prevent: For APX holders 8xD or longer, do not rotate tool more than 50 RPM unless it is engaged with workpiece or fixture. Refer to page A50: 30 for Deep Hole Drilling Guidelines in this section of the catalogue. Visit www.alliedmachine.com for the most up-to-date information and procedures. Factory technical assistance is also available for your specific applications.

Recommended Drilling Data | Imperial (inch)

ISO	Material	Hardness (BHN)	Kg	N/mm ²	Outboard Insert	Feed Rate (IPR) by Diameter								
						Speed (SFM)	Pilot Style	7.94 IC	9.52 IC	12.70 IC	14.29 IC	9.52 IC	12.70 IC	14.29 IC
								33	38 - 44	44 - 51	51 - 57 - 63	70	76 - 83	89 - 95
								1.299 - 1.495	1.496 - 1.885	1.886 - 2.210	2.211 - 2.775	2.756 - 2.991	2.992 - 3.502	3.503 - 4.000
P	Free Machining Steel 1118, 1215, 12L14, etc.	100-250	38-88	370-870	450-750	T-A*/GEN3SYS®	.006 - .011	.007 - .012	.009 - .012	.009 - .012	.006 - .010	.007 - .011	.007 - .012	
	Low Carbon Steel 1010, 1020, 1025, 1522, 1144, etc.	85-275	30-96	300-940	450-750	T-A*/GEN3SYS®	.006 - .011	.007 - .012	.009 - .012	.009 - .012	.006 - .010	.007 - .011	.007 - .012	
	Medium Carbon Steel 1030, 1040, 1050, 1527, 1140, 1151, etc.	125-325	46-111	450-1090	450-750	T-A*/GEN3SYS®	.006 - .011	.007 - .012	.009 - .012	.009 - .012	.006 - .010	.007 - .011	.007 - .012	
	Alloy Steel 4140, 5140, 8640, etc.	125-375	46-129	450-1265	400-700	T-A*/GEN3SYS®	.005 - .007	.005 - .009	.007 - .010	.007 - .011	.005 - .009	.006 - .010	.006 - .010	
	High Strength Alloy 4340, 4330V, 300M, etc.	225-400	77-139	600-1365	300-500	T-A*/GEN3SYS®	.005 - .006	.005 - .007	.005 - .008	.006 - .009	.005 - .007	.005 - .008	.006 - .008	
	Structural Steel A36, A285, A516, etc.	100-350	38-121	370-1180	450-750	T-A*/GEN3SYS®	.006 - .008	.007 - .009	.008 - .010	.009 - .011	.005 - .009	.006 - .010	.007 - .010	
	Tool Steel H-13, H-21, A-4, O-2, S-3, etc.	150-250	50-88	500-870	300-500	T-A*/GEN3SYS®	.005 - .006	.005 - .007	.007 - .009	.008 - .010	.005 - .007	.006 - .009	.007 - .010	
S	High Temp Alloy Hastelloy B, Inconel 600, etc.	140-310	49-101	480-990	200-400	T-A*	.004 - .005	.004 - .007	.006 - .009	.007 - .009	.004 - .006	.005 - .007	.005 - .007	
	Titanium Alloy	140-310	49-101	480-990	300-500	T-A*	.005 - .007	.006 - .008	.007 - .009	.008 - .010	.004 - .006	.005 - .007	.005 - .007	
	Aerospace Alloy S82	185-350	65-121	640-1180	400-600	T-A*	.004 - .006	.005 - .007	.006 - .008	.006 - .008	.004 - .006	.005 - .007	.005 - .007	
M	Stainless Steel 400 Series 416, 420, etc.	185-350	65-121	91-152	300-500	T-A*/GEN3SYS®	.006 - .008	.007 - .009	.008 - .010	.009 - .011	.005 - .007	.007 - .009	.007 - .010	
	Stainless Steel 300 Series 304, 316, 17-4PH, etc.	135-275	49-96	91-152	300-500	T-A*/GEN3SYS®	.005 - .007	.006 - .008	.007 - .009	.008 - .010	.004 - .008	.006 - .010	.006 - .010	
	Super Duplex Stainless Steel	135-275	49-96	76-137	250-450	T-A*/GEN3SYS®	.004 - .006	.005 - .007	.007 - .009	.007 - .009	.004 - .007	.006 - .009	.007 - .010	
H	Wear Plate Hardox, AR400, T-1, etc.	400-600	139-210	91-152	300-500	T-A*	.003 - .005	.004 - .006	.006 - .008	.007 - .009	.003 - .005	.004 - .006	.004 - .006	
	Hardened Steel	300-500	104-139+	91-152	300-500	T-A*	.004 - .005	.005 - .006	.006 - .008	.006 - .008	.003 - .005	.004 - .006	.004 - .006	
K	Nodular, Grey, Ductile Cast Iron	120-320	44-104	152-244	500-800	T-A*/GEN3SYS®	.005 - .009	.006 - .010	.008 - .012	.010 - .012	.008 - .010	.009 - .011	.010 - .012	
N	Cast Aluminium	30-180	10-62	183-244	600-800	T-A*/GEN3SYS®	.009 - .012	.010 - .014	.012 - .016	.012 - .016	.006 - .009	.008 - .011	.008 - .012	
	Wrought Aluminium	30-180	10-62	183-244	600-800	T-A*/GEN3SYS®	.007 - .011	.008 - .012	.010 - .014	.010 - .014	.006 - .009	.008 - .011	.008 - .012	
	Aluminium Bronze	100-250	38-87	123-213	400-700	T-A*/GEN3SYS®	.005 - .007	.005 - .008	.007 - .010	.009 - .011	.006 - .009	.007 - .010	.008 - .012	
	Brass	30-100	38	244	800	T-A*/GEN3SYS®	.006 - .008	.007 - .009	.008 - .010	.009 - .012	.006 - .008	.007 - .009	.008 - .010	
	Copper	60	21	213	700	T-A*/GEN3SYS®	.002 - .005	.003 - .006	.006 - .008	.008 - .010	.003 - .006	.006 - .008	.006 - .008	

Coolant Recommendations

Series	Pressure (PSI)	Flow Rate (GPM)
33	350	10
38	300	10
44	275	12
51	250	18
57	225	20
63	200	22
70	150	25
76	100	28
83	100	30
89	100	33
95	100	33

Calculations

Value	Formula
SFM	RPM • 0.262 • Diameter
RPM	(SFM • 3.82) / Diameter
IPM	RPM • IPR

IMPORTANT: The speeds and feeds listed above are a general starting point for all applications. Refer to the Coolant Recommendation charts for coolant requirements to run at the recommended speeds and feeds. Factory technical assistance is also available through our Application Engineering Team.

IMPORTANT: The coolant pressure and flow rate recommendations above represent a good approximation to obtain optimum tool life and chip evacuation at Allied Machine recommended speeds and feeds. If lower coolant capabilities exist in a drilling application, the APX Drilling System will still function at reduced penetration rates. Contact our Application Engineering department for a more specific recommendation of coolant requirements and/or speeds and feeds.

⚠ WARNING Tool failure can cause serious injury. To prevent: For APX holders 8xD or longer, do not rotate tool more than 50 RPM unless it is engaged with workpiece or fixture. Refer to page A50: 30 for Deep Hole Drilling Guidelines in this section of the catalogue. Visit www.alliedmachine.com for the most up-to-date information and procedures. Factory technical assistance is also available for your specific applications.

A
DRILLING
B
BORING
C
REAMING
D
BURNISHING
E
THREADING
X
SPECIALS



Deep Hole Drilling Guidelines

A

DRILLING

B

BORING

C

REAMING

D

BURNISHING

F

THREADING

X

SPECIALS

1. Approach

50 RPM max 
300 mm/min (12 IPM)

Feed the longer drill within 1.5mm (1/16") short of the workpiece at a **maximum of 50 RPM** and 300 mm/min (12 IPM) feed rate.

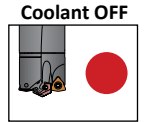
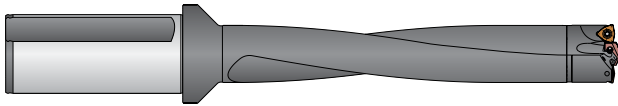

2. Feed-in

Speed at 75% of recommended start
Feed at 50% of recommended start

Drill 20 mm (3/4") deep at 75% recommended speed and 50% recommended feed to establish the hole.

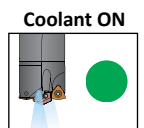
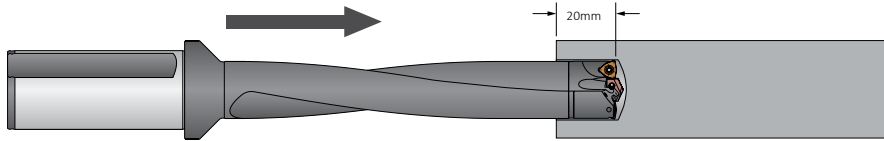

3. Deep Hole Drilling - Blind

100 % RPM
100% mm/rev (IPR)

Drill to full depth at recommended speed and feed for longer drills (according to Allied Machine speed and feed charts).
***No peck cycle recommended.**

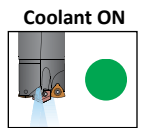
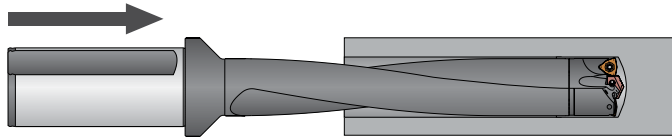
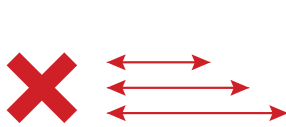

4. Deep Hole Drilling - At Breakout

50% RPM
100% mm/rev (IPR)

***For through holes only:**
Reduce speed by 50% prior to breakout.
Do not breakout more than 3mm (1/8") past the full diameter of the drill.

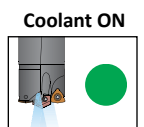
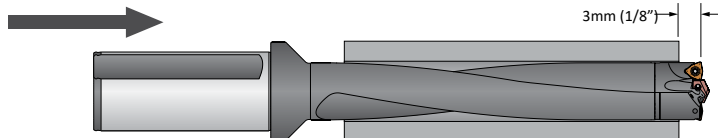

5. Drill Retract

50 RPM max 

Reduce speed to a **maximum of 50 RPM** before retracting from the hole.

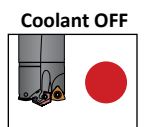
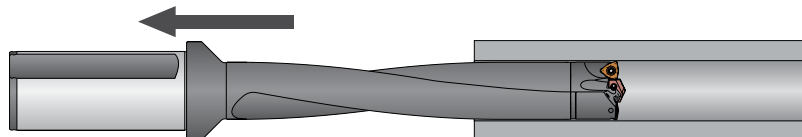

WARNING Tool failure can cause serious injury. To prevent: NEVER rotate these tool holders more than 50 RPM without proper engagement with a workpiece or fixture. Failure to do so could result in tool failure and/or personal injury. Visit www.alliedmachine.com for the most up-to-date information and procedures. Factory technical assistance is also available for your specific applications.