



# ALLIED MACHINE & ENGINEERING

Holemaking Solutions for Today's Manufacturing



Boring



Reaming



Burnishing



Threading

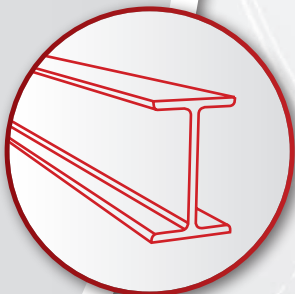

Specials



## Structural Steel Solutions

► *DRILLING*

Replaceable Insert Drills

## North America

**Allied Machine**  
120 Deeds Drive  
Dover, OH 44622  
United States

**Allied Machine**  
485 West 3rd Street  
Dover, OH 44622  
United States

### ThreadMills USA™

4185 Crosstowne Ct #B  
Evans, GA 30809  
United States

### Superion™

1285 S Patton St.  
Xenia, OH 45385  
United States

## Europe

**Allied Machine Europe**  
93 Vantage Point  
Pensnett Estate  
Kingswinford  
West Midlands  
DY6 7FR, United Kingdom

### Wohlhaupter® GmbH

Maybachstrasse 4  
Postfach 1264  
72636 Frickenhausen  
Germany

## Asia

**Wohlhaupter® India**  
B-23, 2nd Floor  
B Block Community Centre  
Janakpuri, New Delhi - 110058  
India



Allied Machine & Engineering is a worldwide leader in holemaking and finishing solutions. We are committed to providing practical and dependable solutions to our customers through innovative designs and superior customer and technical support.

We continue to expand our product offering in order to provide new and different solutions. With Field Sales Engineers located around the world, we position ourselves to provide technical support on site, right at your spindle.



**ALLIED MACHINE**  
**& ENGINEERING**

[www.alliedmachine.com](http://www.alliedmachine.com)

# Structural Steel Solutions

## The Foundation

Since 1941, Allied Machine & Engineering has provided dependable and practical holemaking solutions to the world. What was once a small job shop in Ohio is now a worldwide leader in cutting tool technology. With three manufacturing facilities in Ohio, one in Georgia, another in Germany, and headquarters in both the United States and Europe, Allied Machine is positioned to bring innovative solutions and technical expertise directly to the customers' hands.



## The Beginning

Harold E. Stokey founded Allied Machine & Engineering to aid the war effort, manufacturing taper bearing lock nuts for the production of M1 tanks. Years later, after a sales meeting gone wrong, Stokey possessed a warehouse stocked with spade drill inserts. He set forth into the industry that would become Allied Machine's thriving identity: holemaking.



## The T-A®

When Harold's son, William H. Stokey, became the president and CEO, he developed the Throw Away, or T-A, spade drill insert system. The T-A revolutionized the holemaking industry, launching Allied Machine ahead of the competition. Since then, numerous innovations and advancements have been created from the T-A's inspiration.



## The Innovation

Since the development of the T-A, Allied Machine has expanded its product offering to support a vast range of customer applications, including large diameter and deep hole drilling, boring, reaming, burnishing, porting, and threading.

## The People

Allied Machine understands that high quality products are only one facet of success. Our customer support is crucial to what we do, and that's why we make sure the best engineers and customer service associates are in place to assist our customers around the world.

## The Future

With over 75 years of experience, Allied Machine has encountered the challenges of growth and success. By investing in cutting edge technology and the brightest and sharpest minds, our knowledge and capabilities continue to expand and grow every day.



**Steve Stokey**  
Executive Vice President

**William H. Stokey**  
President and CEO

**Mike Stokey**  
Executive Vice President



## Replaceable Insert Drills

- Reduce costs by decreasing set-up time and utilizing a single holder for the lives of multiple inserts
- Provide flexibility to quickly switch between inserts with different geometries
- Products:
  - GEN3SYS® XT | GEN3SYS® XT Pro
  - Original T-A® | GEN2 T-A®
  - High Performance | Universal



## Indexable Insert Drills

- Protect your investment and reduce your inventory with replaceable cartridges that allow the same holder to be used repeatedly
- Indexable inserts increase productivity and tool life while reducing costs
- Products:
  - 4TEX™ Drill
  - Revolution Drill®
  - Opening Drill®

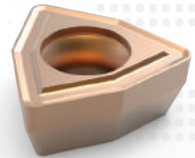

## Replaceable / Indexable Insert Drills

- Allow for higher spindle speeds and take advantage of the power curve on modern CNC machines
- Achieve maximum penetration rates in deep hole drilling applications
- Holders cover a range of sizes with the replaceable heads determining the cutting diameter
- Products:
  - APX Drill



## Solid Carbide Drills

- Offer greater strength and stability when drilling tougher materials
- Available in diameters from 3mm - 20mm
- Can be made-to-order specifically for your application (Superion™ quoted specials)
  - ASC 320®
  - Superion™





## Structural Steel Solutions

- Deliver outstanding performance and durability in structural steel applications
- Designed to produce optimal results in difficult-to-machine materials
- Available in multiple lengths and diameters
- T-A® style drills have different insert geometry options to improve performance depending on material
- Products:
  - Original T-A® | GEN2 T-A®
  - GEN3SYS® XT Pro

## BTA (STS) Machining Solutions

- The internal ejection system flushes chips and debris from the hole with no interference to the cutting process
- Utilizes the advantages of the T-A® drill insert
- Designed to significantly increase penetration rates over brazed heads and traditional gun drills
- Products:
  - BT-A Drill



## Hydraulic Port Contour Cutters

- Save significant time and money by performing four processes in one step
- Replaceable insert design reduces costs, inventory, and set-up times
- Available in 4 industry specifications:
  - Imperial: SAE J-1926
  - Metric: ISO 6149-1:2006
  - Military: SAE AS5202
  - John Deere: JDS-G173.1
- Products:
  - AccuPort 432®



## Enhanced Special Drilling Capabilities

- Allied Machine Engineers are available to meet with you to evaluate your application and recommend the best solution for you
- Special drilling solutions can incorporate advanced features such as adjustable diameter locations, multiple steps, additional coolant designs, special lengths and diameters, and more
- Special drills can drastically reduce your cost-per-hole and increase your overall productivity by eliminating multiple processes and increasing tool life



# WOHLHAUPTER®

## High Precision Boring Systems

- Designs available for high volume applications that increase rigidity to improve performance
- Versatile boring heads that are flexible with changing applications while maintaining excellent performance
- Provides high precision with absolute repeatability to ensure every part is held to tolerance
- Offers an industry leading modular shank connection that maintains rigidity and reduces inventory on your boring system
- Available with both digital and analog settings
- Products:
  - Wohlhaupter® Boring Tools



3E TECH



# CRITERION™

## Modular Boring Systems

- The modular capabilities are ideal for use across multiple different projects
- Offers versatile boring heads suitable for all job shops and tooling rooms
- Provides an economical solution for low volume and/or short-term production applications
- Offers both rough and finish boring solutions
- Products:
  - Criterion™ Boring Tools

# S.C.A.M.I.®

## Expandable Reaming Solutions

- Expandable cutting diameters accommodate for wear, which extends tool life
- Replaceable cutting heads and rings reduce waste and improve production time versus solid high speed steel and carbide reamers
- Hold tight tolerances to ensure processes are performed to accurate specifications
- Reduce tooling costs because many items are available for recondition
- Products:
  - ALVAN® Reamers



# S.C.A.M.I.®

## Roller Burnishing Solutions

- Produce excellent surface finishes
- Provide accurate size control
- Increase surface hardness
- Solutions for both through hole and blind hole applications
- Products:
  - S.C.A.M.I.® Roller Burnishing Tools



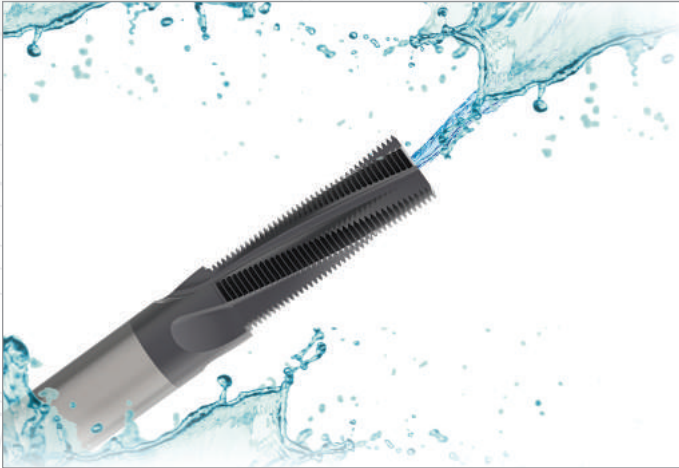

## Solid Carbide Thread Mills

- Available with coolant through options
- Cover a wide range of thread forms
- Provide optimal solutions for both high production projects and short-run applications
- Products
  - AccuThread™ 856
  - AccuThread™ T3
  - ThreadMills USA



## Replaceable Insert Thread Mills

- 3 insert lengths are available that cover a wide range of thread forms
- Holders can utilize inserts with different pitches and thread forms
- Repeatability is achieved by both the bolt-in style and the pin style locking systems
- Increase tool life by 25 - 50% with Allied Machine's AM210® coating
- Products
  - AccuThread™ 856: Bolt-in Style
  - AccuThread™ 856: Pin Style

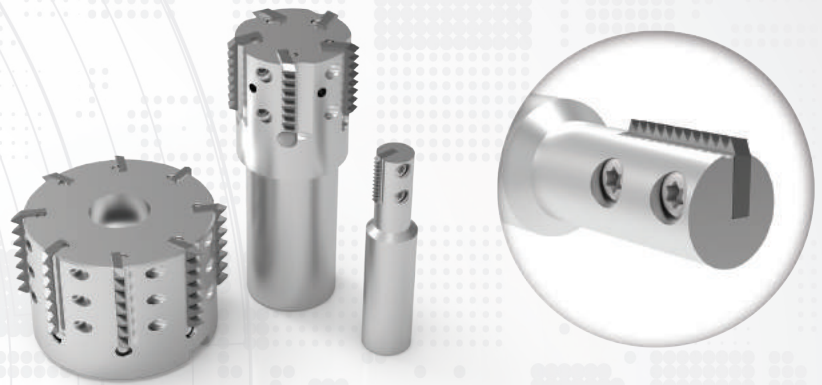

## SPECIAL CAPABILITIES

When it comes to designing and developing special solutions for customers, Allied Machine is the top choice. If your application requires special tooling, give us a call. Our engineered specials are developed by the brightest engineers in the industry. Most of our standard tooling can be altered as specials, or we can create entirely new concepts for particularly unique applications.

One special tooling solution is Insta-Quote™, the online system that allows you to design your own special tooling 24/7. Receive a quote and drawings within minutes just by following the steps.

And with the addition of Superior™ technology and capabilities, we can customize made-to-order solid carbide tools to achieve optimal results for your applications.

Whatever your application, Allied Machine has the answer.



Insta-Quote™ 

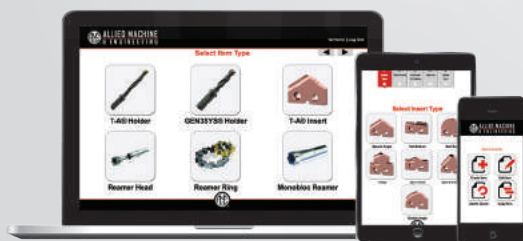

 SUPERION™



# Structural Steel Drilling Solutions

Replaceable Insert Drilling System | GEN3SYS® XT Pro | Original T-A® and GEN2 T-A®

- ▶ GEN3SYS XT Pro Diameter Range: 0.4331" - 1.3780" (11.00mm - 35.00mm)
- ▶ T-A Diameter Range: 0.511" - 1.882" (12.98mm - 47.80mm)



## Take on Tough Drilling

Allied Machine's Structural Steel Drilling System is designed for maximum performance in structural steel materials and applications. These solutions utilize the GEN3SYS XT Pro, Original T-A, and GEN2 T-A designs and capabilities.

With multiple geometries and coatings, you're sure to find the solution that is right for you. Tough drilling is tough no more.

Excellent chip control	Improves hole quality and surface finish	Provides maximum durability and stability
------------------------	--	---

Your safety and the safety of others is very important. This catalog contains important safety messages. Always read and follow all safety precautions.



This triangle is a safety hazard symbol. It alerts you to potential safety hazards that can cause tool failure and serious injury.

When you see this symbol in the catalog, look for a related safety message that may be near this triangle or referred to in the nearby text.

There are safety signal words also used in the catalog. Safety messages follow these words.

### **WARNING**

**WARNING** (shown above) means that failure to follow the precautions in this message could result in tool failure and serious injury.

**NOTICE** means that failure to follow the precautions in this message could result in damage to the tool or machine but not result in personal injury.

**NOTE** and **IMPORTANT** are also used. These are important that you read and follow but are not safety-related.

Visit [www.alliedmachine.com](http://www.alliedmachine.com) for the most up-to-date information and procedures.

## Applicable Industries



Structural Steel



# Structural Steel Drilling Solutions Contents

## Reference Icons

The following icons will appear throughout the catalog to help you navigate between products.

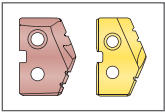

### Corresponding T-A Inserts

Refers to the corresponding T-A insert items that connect with each specific holder series

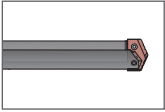

### Corresponding T-A Holders

Refers to the corresponding T-A holder items that connect with each specific insert series



### Setup / Assembly Information

Detailed instructions and information regarding the corresponding part(s)

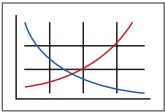

### Recommended Cutting Data

Speed and feed recommendations for optimum and safe drilling

## Introduction Information

Structural Steel Drilling Overview . . . . . 2  
Case Study Example . . . . . 3

## GEN3SYS® XT Pro System

GEN3SYS XT Pro System Overview . . . . . 4  
Product Nomenclature . . . . . 5  
12 - 13 Series . . . . . 6 - 7  
14 - 15 Series . . . . . 8 - 9  
16 - 17 Series . . . . . 10 - 11  
18 - 20 Series . . . . . 12 - 13  
22 - 24 Series . . . . . 14 - 15  
26 - 29 Series . . . . . 16 - 17  
32 Series . . . . . 18

## T-A® Drilling System

T-A System Overview . . . . . 20  
Product Nomenclature . . . . . 21  
0 Series . . . . . 22 - 25  
1 Series . . . . . 26 - 29  
2 Series . . . . . 30 - 33  
3 Series . . . . . 34 - 36  
Deep Hole Drilling Guidelines . . . . . 37

## Recommended Cutting Data

GEN3SYS XT Pro System . . . . . 38 - 39  
T-A System . . . . . 40 - 41

Series	GEN3SYS XT Pro Diameter Range	
	Imperial (inch)	Metric (mm)
12	0.4724 - 0.5117	12.00 - 12.99
13	0.5118 - 0.5511	13.00 - 13.99
14	0.5512 - 0.5905	14.00 - 14.99
15	0.5906 - 0.6298	15.00 - 15.99
16	0.6299 - 0.6692	16.00 - 16.99
17	0.6693 - 0.7086	17.00 - 17.99
18	0.7087 - 0.7873	18.00 - 19.99
20	0.7874 - 0.8660	20.00 - 21.99
22	0.8661 - 0.9448	22.00 - 23.99
24	0.9449 - 1.0235	24.00 - 25.99
26	1.0236 - 1.1416	26.00 - 28.99
29	1.1417 - 1.2597	29.00 - 31.99
32	1.2598 - 1.3780	32.00 - 35.00

Series	T-A Diameter Range	
	Imperial (inch)	Metric (mm)
0	0.511 - 0.695	12.98 - 17.65
1	0.690 - 0.960	17.53 - 24.38
2	0.961 - 1.380	24.41 - 35.05
3	1.353 - 1.882	34.36 - 47.80





## Structural Steel Drilling

### Achieving Optimal Results in Structural Steel

Drilling in structural steel materials can be a difficult process, and achieving optimal results becomes a major issue. Allied Machine's structural steel drilling solutions have been specifically designed to produce the best results in the toughest materials. With solutions in both the T-A® and GEN3SYS® XT Pro product lines, you have multiple options to solve your application problems.

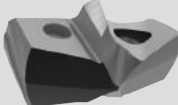

### Insert Style Comparison

	 GEN3SYS® XT Pro Structural Steel	 Original T-A® Thin Wall	 Original T-A® Notch Point®	 Original T-A® 150° Structural Steel	 GEN2 T-A® High Efficiency
High penetration	<input checked="" type="checkbox"/>				
Material less than 7/16" thick		<input checked="" type="checkbox"/>			
Material over 7/16" thick	<input checked="" type="checkbox"/>		<input checked="" type="checkbox"/>	<input checked="" type="checkbox"/>	<input checked="" type="checkbox"/>
Reduced exit burr			<input checked="" type="checkbox"/>	<input checked="" type="checkbox"/>	
Includes Notch Point® geometry			<input checked="" type="checkbox"/>	<input checked="" type="checkbox"/>	<input checked="" type="checkbox"/>
Available from carbide	<input checked="" type="checkbox"/>				<input checked="" type="checkbox"/>
Stocked in common sizes for the Structural Steel industry	<input checked="" type="checkbox"/>	<input checked="" type="checkbox"/>	<input checked="" type="checkbox"/>	<input checked="" type="checkbox"/>	<input checked="" type="checkbox"/>

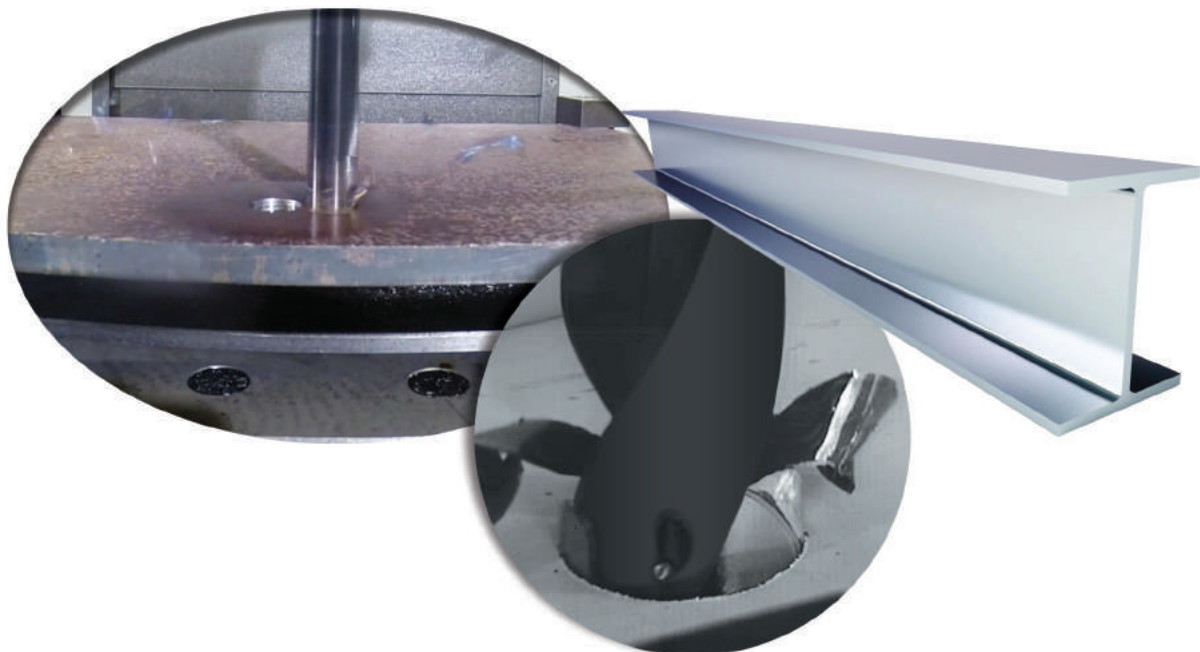

Case Study Example

# CASE STUDY

**Project Profile:** Structural Steel I-Beam Construction  
**Tooling Solution:** T-A® Structural Steel Drilling System

**The Problem:**

Previously, the customer was using a competitor spade drill running at the following parameters:

- 650 RPM
- 0.010 IPR (0.25 mm/rev)
- 6.5 IPM (165.1 mm/min)

The tool drilled a 0.875" (22.23mm) diameter hole to a 0.4375" (11.11mm) depth. The drill had a tool life of **only 20 holes**.

The poor tool performance was brought to the attention of the technician, who was familiar with Allied Machine products. The following day, Allied Machine tooling was brought in for testing. The customer needed improvement in the tool life of the inserts.

**The Solution:**

Allied Machine recommended the T-A Structural Steel Drilling System.

- **Insert** = 151A-0028-TW (#1 series T-A insert with TiAlN coating and Thin Wall geometry)
- **Holder** = 25010H-004IS052 (#1 series T-A holder with #4 Morse Taper shank and helical flute)

The tool ran at the following parameters:

- 440 RPM
- 0.010 IPR (0.25 mm/rev)
- 4.4 IPM (111.7 mm/min)

The tool achieved the desired diameter and depth. But most of all, the tool produced **1,500 holes**.

**Summary:**

The customer was able to take advantage of Allied Machine's vast experience in the structural steel drilling niche. Allied's wide variety of stocked solutions for specific customer problems allows for a remarkable increase in tool life.

The T-A Structural Steel Drilling System defeated the competition, decreasing the total cost-per-hole from \$2.02 to just \$0.22. This reduction resulted in a **savings of 89%** for the customer.

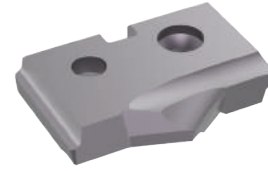

## The PROOF is in the NUMBERS

**Competitor Insert Tool Life**  
(number of holes = 20)



**T-A Structural Steel Insert Tool Life**  
(number of holes = 1,500)

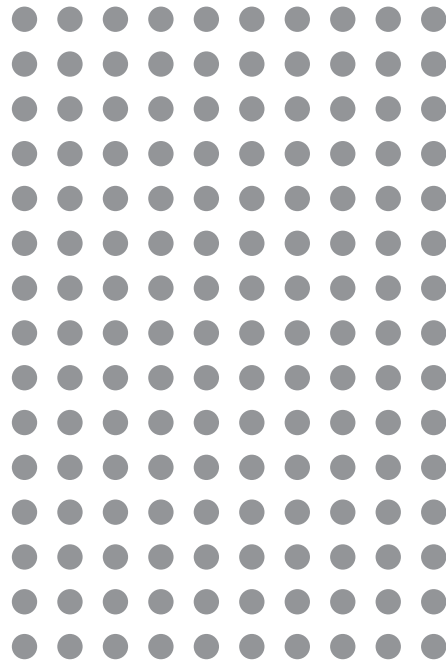

Overall **SAVINGS** of  
89%



**PREMIUM SOLUTION**

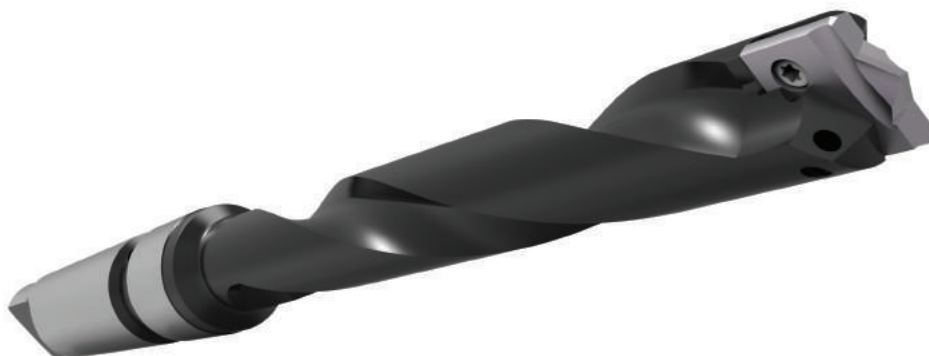

GEN3SYS® XT Pro Structural Steel Drilling System

A  
DRILLING  
B  
BORING  
C  
REAMING  
D  
BURNISHING  
E  
THREADING  
X  
SPECIALS



GEN3SYS® XT Pro **ST**  
STRUCTURAL STEEL ENHANCEMENTS

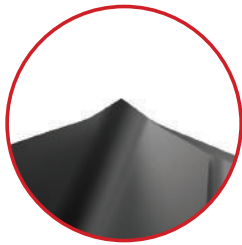
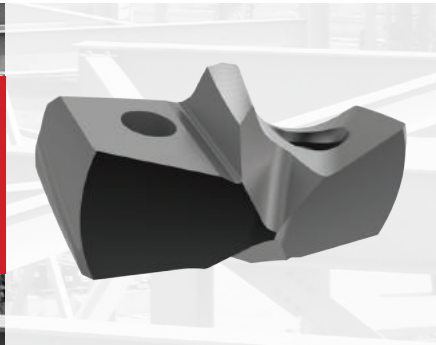

**New Point Design**

Increases stability without hindering penetration

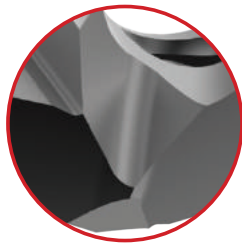

**Redesigned Insert**

Provides consistent performance and adds durability

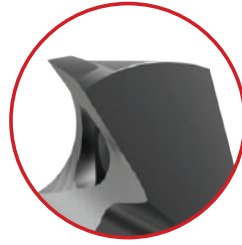

**Improved Geometry**

Extends tool life and increases insert strength without increasing horsepower consumption



**AM420**

**AM420 Coating**

Increases heat threshold and extends tool life

**Get the Consistency You Need**

The challenge of drilling structural steel materials is about to get a whole lot easier. Developed through a rigorous and thorough testing process, the modified and improved XTST insert is a product of innovation.

Achieve the **consistent performance** you need while matching or even exceeding your current parameters.

**Tough Drilling is Tough No More**

Structural steel applications can prove to be difficult to machine, so you need a drill that's been put through the fire to ensure it can conquer those challenging applications.

Rigorous testing and countless hours of design and programming make the XT Pro structural steel insert the optimal drill for structural steel applications.

- Diameter range: 12mm - 35mm
- Holders available in 3xD, 5xD, and 7xD lengths
- Flanged shank with flat



3xD

5xD

7xD



**NOTICE:** Structural Steel GEN3SYS XT holders are specifically designed to be used only with XTST geometry inserts. Using other GEN3SYS XT or XT Pro insert geometries in these holders could lead to chip packing and tool failure. Contact Application Engineering for questions regarding proper use of tools.

## GEN3SYS® XT Pro Drill Nomenclature

### GEN3SYS XT Pro Drill Inserts

<b>XT</b>	<b>ST</b>	<b>20</b>	-	<b>20.00</b>
1	2	3		4

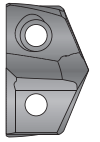

1. XT Pro Drill Insert	2. Geometry	3. Series	4. Diameter (mm)															
XT = XT Pro insert	ST = Structural Steel	<table border="0"> <tr> <td><b>12</b> = 12 series</td> <td><b>17</b> = 17 series</td> <td><b>26</b> = 26 series</td> </tr> <tr> <td><b>13</b> = 13 series</td> <td><b>18</b> = 18 series</td> <td><b>29</b> = 29 series</td> </tr> <tr> <td><b>14</b> = 14 series</td> <td><b>20</b> = 20 series</td> <td><b>32</b> = 32 series</td> </tr> <tr> <td><b>15</b> = 15 series</td> <td><b>22</b> = 22 series</td> <td></td> </tr> <tr> <td><b>16</b> = 16 series</td> <td><b>24</b> = 24 series</td> <td></td> </tr> </table>	<b>12</b> = 12 series	<b>17</b> = 17 series	<b>26</b> = 26 series	<b>13</b> = 13 series	<b>18</b> = 18 series	<b>29</b> = 29 series	<b>14</b> = 14 series	<b>20</b> = 20 series	<b>32</b> = 32 series	<b>15</b> = 15 series	<b>22</b> = 22 series		<b>16</b> = 16 series	<b>24</b> = 24 series		For complete list of diameter ranges by series, see contents page.
<b>12</b> = 12 series	<b>17</b> = 17 series	<b>26</b> = 26 series																
<b>13</b> = 13 series	<b>18</b> = 18 series	<b>29</b> = 29 series																
<b>14</b> = 14 series	<b>20</b> = 20 series	<b>32</b> = 32 series																
<b>15</b> = 15 series	<b>22</b> = 22 series																	
<b>16</b> = 16 series	<b>24</b> = 24 series																	

#### Reference Key

Symbol	Attribute
$D_1$	Insert diameter

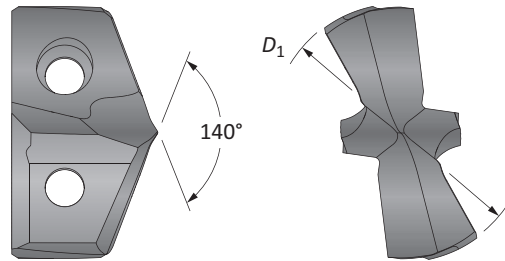

Sizes not shown are available upon request.  
When ordering, please follow the example below:

<b>Imperial:</b>	0.7913", 20 series = use Part No. <b>XTST20-20.10</b>
<b>Metric:</b>	20.10mm, 20 series = use Part No. <b>XTST20-20.10</b>

### GEN3SYS XT Structural Steel Drill Holders

<b>ST</b>	<b>03</b>	<b>12</b>	<b>0</b>	-	<b>20</b>	<b>FM</b>
1	2	3	4		5	6

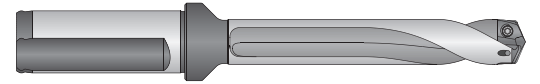

1. Holder	2. Length	3. Series	4. Body Diameter															
ST = Structural steel holder	<b>03</b> = 3x Diameter <b>05</b> = 5x Diameter <b>07</b> = 7x Diameter	<table border="0"> <tr> <td><b>12</b> = 12 series</td> <td><b>17</b> = 17 series</td> <td><b>26</b> = 26 series</td> </tr> <tr> <td><b>13</b> = 13 series</td> <td><b>18</b> = 18 series</td> <td><b>29</b> = 29 series</td> </tr> <tr> <td><b>14</b> = 14 series</td> <td><b>20</b> = 20 series</td> <td><b>32</b> = 32 series</td> </tr> <tr> <td><b>15</b> = 15 series</td> <td><b>22</b> = 22 series</td> <td></td> </tr> <tr> <td><b>16</b> = 16 series</td> <td><b>24</b> = 24 series</td> <td></td> </tr> </table>	<b>12</b> = 12 series	<b>17</b> = 17 series	<b>26</b> = 26 series	<b>13</b> = 13 series	<b>18</b> = 18 series	<b>29</b> = 29 series	<b>14</b> = 14 series	<b>20</b> = 20 series	<b>32</b> = 32 series	<b>15</b> = 15 series	<b>22</b> = 22 series		<b>16</b> = 16 series	<b>24</b> = 24 series		<b>0</b> = Standard <b>5</b> = Oversized
<b>12</b> = 12 series	<b>17</b> = 17 series	<b>26</b> = 26 series																
<b>13</b> = 13 series	<b>18</b> = 18 series	<b>29</b> = 29 series																
<b>14</b> = 14 series	<b>20</b> = 20 series	<b>32</b> = 32 series																
<b>15</b> = 15 series	<b>22</b> = 22 series																	
<b>16</b> = 16 series	<b>24</b> = 24 series																	

5. Shank Diameter	6. Shank Style																
<table border="0"> <thead> <tr> <th colspan="2">Imperial (in)</th> <th colspan="2">Metric (mm)</th> </tr> </thead> <tbody> <tr> <td><b>063</b> = 5/8"</td> <td><b>125</b> = 1-1/4"</td> <td><b>16</b> = 16mm</td> <td><b>32</b> = 32mm</td> </tr> <tr> <td><b>075</b> = 3/4"</td> <td><b>150</b> = 1-1/2"</td> <td><b>20</b> = 20mm</td> <td><b>40</b> = 40mm</td> </tr> <tr> <td><b>100</b> = 1"</td> <td></td> <td><b>25</b> = 25mm</td> <td></td> </tr> </tbody> </table>	Imperial (in)		Metric (mm)		<b>063</b> = 5/8"	<b>125</b> = 1-1/4"	<b>16</b> = 16mm	<b>32</b> = 32mm	<b>075</b> = 3/4"	<b>150</b> = 1-1/2"	<b>20</b> = 20mm	<b>40</b> = 40mm	<b>100</b> = 1"		<b>25</b> = 25mm		<b>F</b> = Flanged with flat <b>FM</b> = Flanged metric with flat <b>C</b> = Cylindrical (no flat) <b>CM</b> = Cylindrical metric (no flat)
Imperial (in)		Metric (mm)															
<b>063</b> = 5/8"	<b>125</b> = 1-1/4"	<b>16</b> = 16mm	<b>32</b> = 32mm														
<b>075</b> = 3/4"	<b>150</b> = 1-1/2"	<b>20</b> = 20mm	<b>40</b> = 40mm														
<b>100</b> = 1"		<b>25</b> = 25mm															

#### Reference Key

Symbol	Attribute
$D_2$	Shank diameter
$L_1$	Overall length
$L_2$	Drill depth
$L_3$	Holder reference length
$L_4$	Holder body length
$L_7$	Shank length
$P_1$	Rear pipe tap

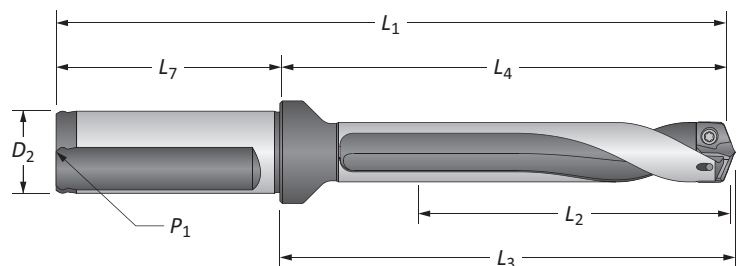

**GEN3SYS® XT Pro Structural Steel Drilling System**

12 Series | Diameter Range: 0.4724" - 0.5117" (12.00mm - 12.99mm)

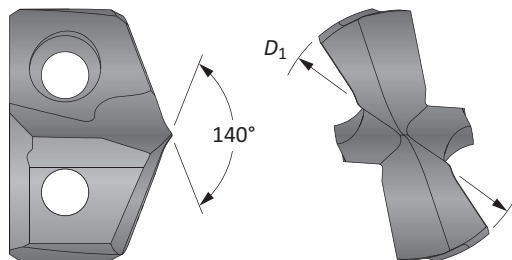
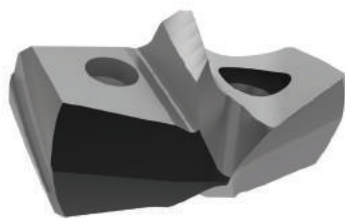
**Inserts**



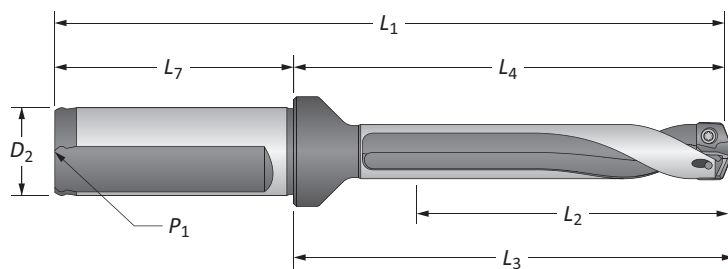

Fractional Equivalent	Insert $D_1$ inch	$D_1$ mm	 XTST Part No.
–	0.4724	12.00	XTST12-12.00

**Holder**

Length	Body				Shank				Part No.
	$L_2$	$L_4$	$L_3$	$L_1$	$L_7$	$D_2$	$P_1$	Flat	
<b>i</b> 3xD	1-17/32	2-5/8	2-45/64	4-21/32	2-1/32	3/4	1/8	YES	<b>ST03120-075F</b>
<b>i</b> 5xD	2-9/16	3-41/64	3-47/64	5-43/64	2-1/32	3/4	1/8	YES	<b>ST05120-075F</b>
<b>i</b> 7xD	3-37/64	4-43/64	4-3/4	6-45/64	2-1/32	3/4	1/8	YES	<b>ST07120-075F</b>
<b>m</b> 3xD	39.0	68.8	68.8	118.8	50	20	1/8*	YES	<b>ST03120-20FM</b>
<b>m</b> 5xD	65.0	94.8	94.8	144.8	50	20	1/8*	YES	<b>ST05120-20FM</b>
<b>m</b> 7xD	90.9	120.8	120.8	170.8	50	20	1/8*	YES	<b>ST07120-20FM</b>

\*Thread to BSP and ISO 7-1

**Connection Accessories**

 Insert Screws	 Nylon Locking Screws	 Insert Driver	 Preset Torque Hand Driver	 Replacement Tips	Admissible Tightening Torque*
7247-IP7-1	7247N-IP7-1	8IP-7	8IP-7TL	8IP-7B	7.4 in-lbs (84 N-cm)

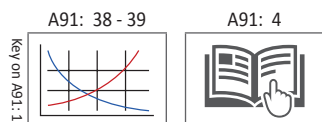
\*Tightening torques are calculated with a friction coefficient of  $\mu = 0.14$  and develop 90% of ultimate yield strength**i** = Imperial (in)  
**m** = Metric (mm)

Inserts sold in multiples of 1 | Screws sold in multiples of 10

**NOTICE:** Structural Steel GEN3SYS XT holders are specifically designed to be used only with XTST geometry inserts. Using other GEN3SYS XT or XT Pro insert geometries in these holders could lead to chip packing and tool failure. Contact Application Engineering for questions regarding proper use of tools.



# GEN3SYS® XT Pro Structural Steel Drilling System

13 Series | Diameter Range: 0.5118" - 0.5511" (13.00mm - 13.99mm)

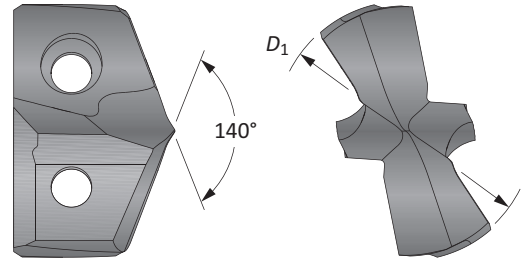
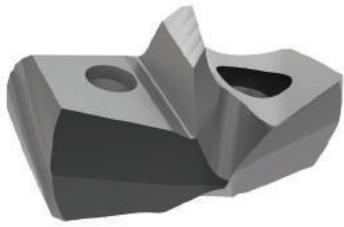

## Inserts

Fractional Equivalent	Insert $D_1$ inch	$D_1$ mm	 XTST Part No.
-	0.5118	13.00	XTST13-13.00

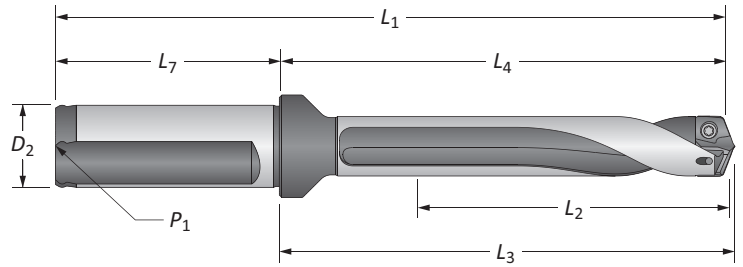





## Holders

	Length	Body				Shank				Part No.
		$L_2$	$L_4$	$L_3$	$L_1$	$L_7$	$D_2$	$P_1$	Flat	
i	3xD	1-21/32	2-23/32	2-13/16	4-3/4	2-1/32	3/4	1/8	YES	ST03130-075F
	5xD	2-3/4	3-53/64	3-29/32	5-55/64	2-1/32	3/4	1/8	YES	ST05130-075F
	7xD	3-55/64	4-15/16	5-1/32	6-31/32	2-1/32	3/4	1/8	YES	ST07130-075F
m	3xD	42.1	69.1	71.3	120.7	50	20	1/8*	YES	ST03130-20FM
	5xD	69.9	97.2	99.4	148.8	50	20	1/8*	YES	ST05130-20FM
	7xD	97.9	125.4	127.6	177.0	50	20	1/8*	YES	ST07130-20FM

\*Thread to BSP and ISO 7-1

## Connection Accessories

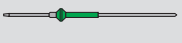
 Insert Screws	 Nylon Locking Screws	 Insert Driver	 Preset Torque Hand Driver	 Replacement Tips	Admissible Tightening Torque*
7247-IP7-1	7247N-IP7-1	8IP-7	8IP-7TL	8IP-7B	7.4 in-lbs (84 N-cm)

\*Tightening torques are calculated with a friction coefficient of  $\mu = 0.14$  and develop 90% of ultimate yield strength

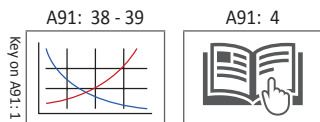

i = Imperial (in)  
m = Metric (mm)

Inserts sold in multiples of 1 | Screws sold in multiples of 10

**NOTICE:** Structural Steel GEN3SYS XT holders are specifically designed to be used only with XTST geometry inserts. Using other GEN3SYS XT or XT Pro insert geometries in these holders could lead to chip packing and tool failure. Contact Application Engineering for questions regarding proper use of tools.

## GEN3SYS® XT Pro Structural Steel Drilling System

14 Series | Diameter Range: 0.5512" - 0.5905" (14.00mm - 14.99mm)

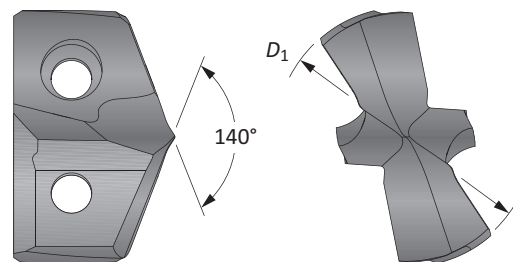
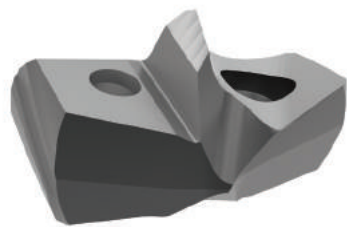

### Inserts

Fractional Equivalent	Insert $D_1$ inch	$D_1$ mm	 XTST Part No.
–	0.5512	14.00	XTST14-14.00
9/16	0.5625	14.29	XTST14-14.29

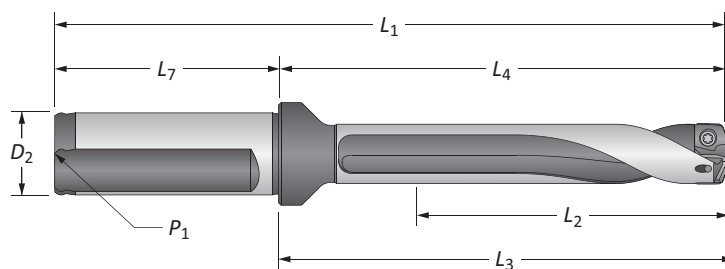





### Holders

Length	Body				Shank				Flat	Part No.
	$L_2$	$L_4$	$L_3$	$L_1$	$L_7$	$D_2$	$P_1$			
<b>i</b> 3xD	1-25/32	2-27/32	2-61/64	4-7/8	2-1/32	3/4	1/8	YES	ST03140-075F	
<b>i</b> 5xD	2-61/64	4-1/32	4-1/8	6-1/16	2-1/32	3/4	1/8	YES	ST05140-075F	
<b>i</b> 7xD	4-9/64	5-13/64	5-5/16	7-15/64	2-1/32	3/4	1/8	YES	ST07140-075F	
<b>m</b> 3xD	45.0	72.4	75.0	122.4	50	20	1/8*	YES	ST03140-20FM	
<b>m</b> 5xD	75.0	102.4	104.9	152.4	50	20	1/8*	YES	ST05140-20FM	
<b>m</b> 7xD	104.9	132.3	134.9	182.3	50	20	1/8*	YES	ST07140-20FM	

\*Thread to BSP and ISO 7-1

### Connection Accessories

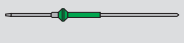
 Insert Screws	 Nylon Locking Screws	 Insert Driver	 Preset Torque Hand Driver	 Replacement Tips	Admissible Tightening Torque*
7247-IP7-1	7247N-IP7-1	8IP-7	8IP-7TL	8IP-7B	7.4 in-lbs (84 N-cm)

\*Tightening torques are calculated with a friction coefficient of  $\mu = 0.14$  and develop 90% of ultimate yield strength

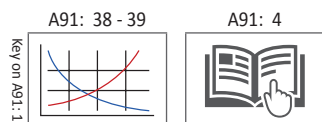

**i** = Imperial (in)  
**m** = Metric (mm)

Inserts sold in multiples of 1 | Screws sold in multiples of 10

**NOTICE:** Structural Steel GEN3SYS XT holders are specifically designed to be used only with XTST geometry inserts. Using other GEN3SYS XT or XT Pro insert geometries in these holders could lead to chip packing and tool failure. Contact Application Engineering for questions regarding proper use of tools.





## GEN3SYS® XT Pro Structural Steel Drilling System

15 Series | Diameter Range: 0.5906" - 0.6298" (15.00mm - 15.99mm)

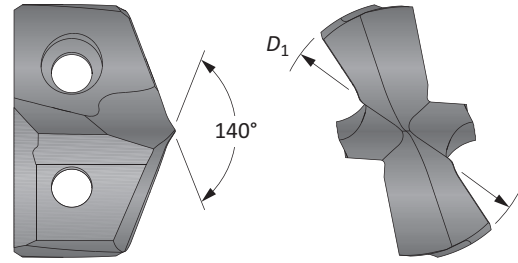
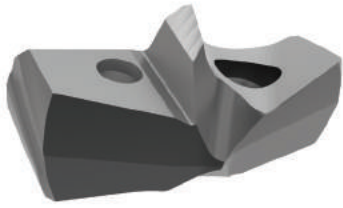

### Inserts

Fractional Equivalent	Insert $D_1$ inch	$D_1$ mm	 XTST Part No.
	0.5906	15.00	XTST15-15.00
5/8	0.6250	15.88	XTST15-15.88

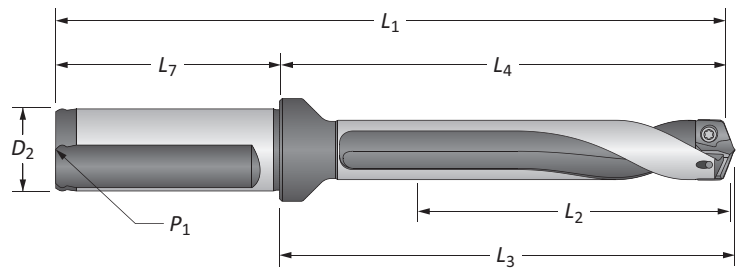





### Holders

	Length	Body				Shank				Flat	Part No.
		$L_2$	$L_4$	$L_3$	$L_1$	$L_7$	$D_2$	$P_1$			
i	3xD	1-57/64	2-61/64	3-3/64	4-63/64	2-1/32	3/4	1/8	YES	ST03150-075F	
	5xD	3-5/32	4-7/32	4-5/16	6-1/4	2-1/32	3/4	1/8	YES	ST05150-075F	
	7xD	4-27/64	5-15/32	5-37/64	7-1/2	2-1/32	3/4	1/8	YES	ST07150-075F	
m	3xD	48.0	75.1	77.6	125.1	50	20	1/8*	YES	ST03150-20FM	
	5xD	80.0	107.0	109.6	157.0	50	20	1/8*	YES	ST05150-20FM	
	7xD	111.9	139.0	141.6	189.0	50	20	1/8*	YES	ST07150-20FM	

\*Thread to BSP and ISO 7-1

### Connection Accessories

 Insert Screws	 Nylon Locking Screws	 Insert Driver	 Preset Torque Hand Driver	 Replacement Tips	Admissible Tightening Torque*
7247-IP7-1	7247N-IP7-1	8IP-7	8IP-7TL	8IP-7B	7.4 in-lbs (84 N-cm)

\*Tightening torques are calculated with a friction coefficient of  $\mu = 0.14$  and develop 90% of ultimate yield strength

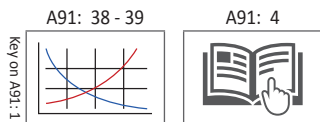

i = Imperial (in)  
m = Metric (mm)

Inserts sold in multiples of 1 | Screws sold in multiples of 10

**NOTICE:** Structural Steel GEN3SYS XT holders are specifically designed to be used only with XTST geometry inserts. Using other GEN3SYS XT or XT Pro insert geometries in these holders could lead to chip packing and tool failure. Contact Application Engineering for questions regarding proper use of tools.

# GEN3SYS® XT Pro Structural Steel Drilling System

16 Series | Diameter Range: 0.6299" - 0.6692" (16.00mm - 16.99mm)

A  
DRILLING

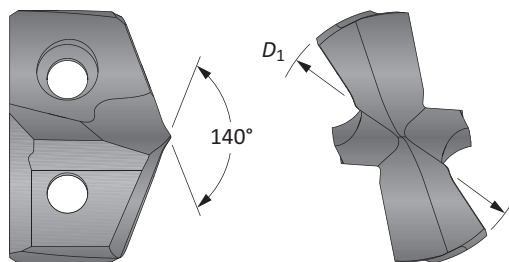
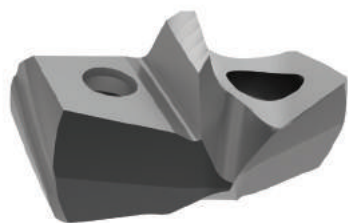

B  
BORING

### Inserts

Fractional Equivalent	Insert $D_1$ inch	$D_1$ mm	 XTST Part No.
–	0.6299	16.00	XTST16-16.00

C  
REAMING

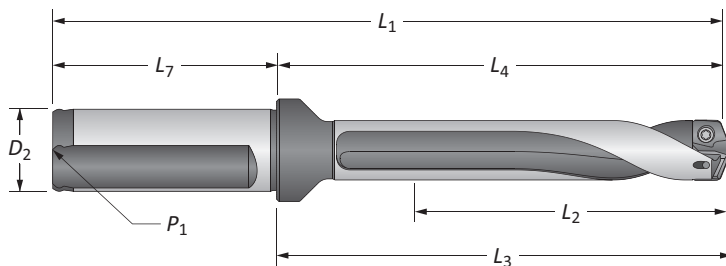

D  
BURNISHING





### Holders

Length	Body					Shank				Flat	Part No.
	$L_2$	$L_4$	$L_3$	$L_1$	$L_7$	$D_2$	$P_1$				
<b>i</b> 3xD	3-1/64	3-13/64	3-5/16	5-15/64	2-1/32	3/4	1/8	YES	ST03160-075F		
<b>i</b> 5xD	3-23/64	4-17/32	4-21/32	6-9/16	2-1/32	3/4	1/8	YES	ST05160-075F		
<b>i</b> 7xD	4-11/16	5-7/8	5-63/64	7-29/32	2-1/32	3/4	1/8	YES	ST07160-075F		
<b>m</b> 3xD	51.0	81.3	84.2	131.3	50	20	1/8*	YES	ST03160-20FM		
<b>m</b> 5xD	84.9	115.3	118.2	165.3	50	20	1/8*	YES	ST05160-20FM		
<b>m</b> 7xD	118.9	149.3	152.2	199.3	50	20	1/8*	YES	ST07160-20FM		

\*Thread to BSP and ISO 7-1

F  
THREADING

### Connection Accessories

 Insert Screws	 Nylon Locking Screws	 Insert Driver	 Preset Torque Hand Driver	 Replacement Tips	Admissible Tightening Torque*
72556-IP8-1	72556N-IP8-1	8IP-8	8IP-8TL	8IP-8B	15.5 in-lbs (175 N-cm)

\*Tightening torques are calculated with a friction coefficient of  $\mu = 0.14$  and develop 90% of ultimate yield strength

X  
SPECIALS

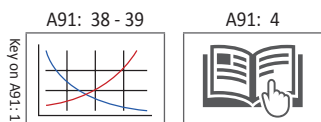

**i** = Imperial (in)  
**m** = Metric (mm)

Inserts sold in multiples of 1 | Screws sold in multiples of 10

**NOTICE:** Structural Steel GEN3SYS XT holders are specifically designed to be used only with XTST geometry inserts. Using other GEN3SYS XT or XT Pro insert geometries in these holders could lead to chip packing and tool failure. Contact Application Engineering for questions regarding proper use of tools.

# GEN3SYS® XT Pro Structural Steel Drilling System

17 Series | Diameter Range: 0.6693" - 0.7086" (17.00mm - 17.99mm)

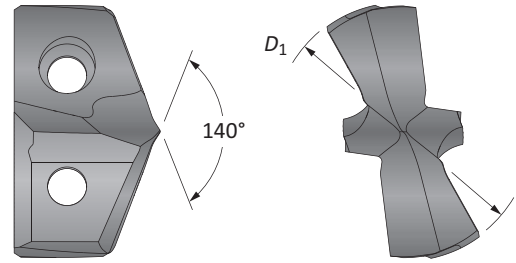
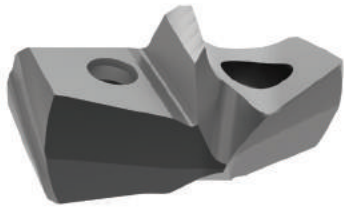

## Inserts

Fractional Equivalent	Insert $D_1$ inch	$D_1$ mm	 XTST Part No.
–	0.6693	17.00	XTST17-17.00
11/16	0.6875	17.46	XTST17-17.46

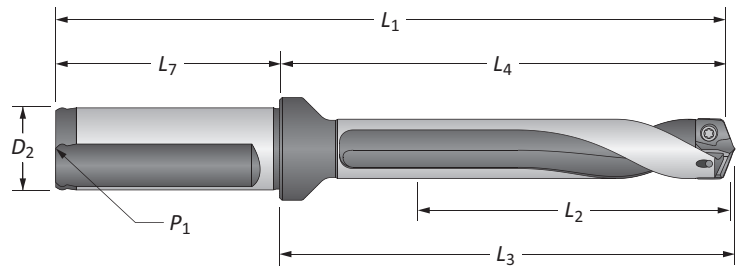





## Holders

Length	Body				Shank				Flat	Part No.
	$L_2$	$L_4$	$L_3$	$L_1$	$L_7$	$D_2$	$P_1$			
<b>i</b> 3xD	2-1/8	3-5/16	3-27/64	5-11/32	2-1/32	3/4	1/8	YES	ST03170-075F	
5xD	3-35/64	4-23/32	4-27/32	6-3/4	2-1/32	3/4	1/8	YES	ST05170-075F	
7xD	4-31/32	6-9/64	6-1/4	8-11/64	2-1/32	3/4	1/8	YES	ST07170-075F	
<b>m</b> 3xD	54.0	84.1	87.0	134.1	50	20	1/8*	YES	ST03170-20FM	
5xD	89.9	120.0	122.9	170.0	50	20	1/8*	YES	ST05170-20FM	
7xD	125.9	156.0	158.9	206.0	50	20	1/8*	YES	ST07170-20FM	

\*Thread to BSP and ISO 7-1

## Connection Accessories

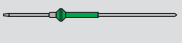
 Insert Screws	 Nylon Locking Screws	 Insert Driver	 Preset Torque Hand Driver	 Replacement Tips	Admissible Tightening Torque*
72567-IP8-1	72567N-IP8-1	8IP-8	8IP-8TL	8IP-8B	15.5 in-lbs (175 N-cm)

\*Tightening torques are calculated with a friction coefficient of  $\mu = 0.14$  and develop 90% of ultimate yield strength

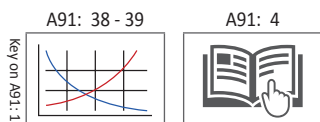

**i** = Imperial (in)  
**m** = Metric (mm)

Inserts sold in multiples of 1 | Screws sold in multiples of 10

**NOTICE:** Structural Steel GEN3SYS XT holders are specifically designed to be used only with XTST geometry inserts. Using other GEN3SYS XT or XT Pro insert geometries in these holders could lead to chip packing and tool failure. Contact Application Engineering for questions regarding proper use of tools.

# GEN3SYS® XT Pro Structural Steel Drilling System

18 Series | Diameter Range: 0.7087" - 0.7873" (18.00mm - 19.99mm)

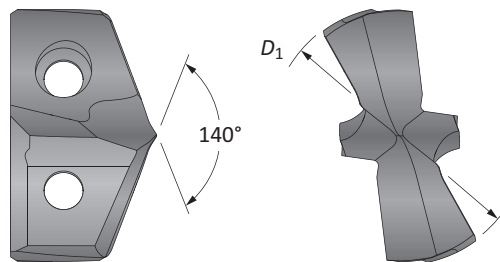
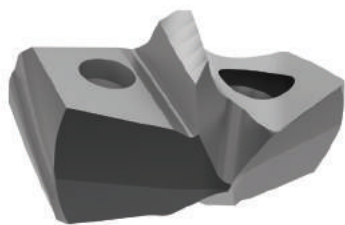

## Inserts

Fractional Equivalent	Insert <i>D</i> <sub>1</sub> inch	<i>D</i> <sub>1</sub> mm	 XTST Part No.
-	0.7087	18.00	XTST18-18.00
-	0.7480	19.00	XTST18-19.00

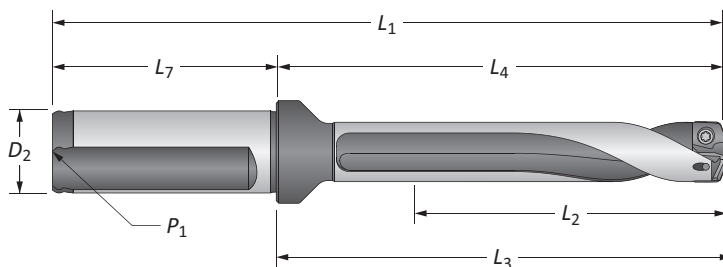



## Holders

Length	Body					Shank				Part No.
	<i>L</i> <sub>2</sub>	<i>L</i> <sub>4</sub>	<i>L</i> <sub>3</sub>	<i>L</i> <sub>1</sub>	<i>L</i> <sub>7</sub>	<i>D</i> <sub>2</sub>	<i>P</i> <sub>1</sub>	Flat		
<b>i</b> 3xD	2-3/8	3-45/64	3-53/64	5-63/64	2-9/32	1	1/8	YES	<b>ST03180-100F</b>	
<b>i</b> 5xD	3-15/16	5-9/32	5-25/64	7-9/16	2-9/32	1	1/8	YES	<b>ST05180-100F</b>	
<b>i</b> 7xD	5-33/64	6-27/32	6-31/32	9-1/8	2-9/32	1	1/8	YES	<b>ST07180-100F</b>	
<b>m</b> 3xD	60.0	94.0	97.1	144.0	50	20	1/8*	YES	<b>ST03180-20FM</b>	
<b>m</b> 5xD	99.9	134.0	137.1	184.0	50	20	1/8*	YES	<b>ST05180-20FM</b>	
<b>m</b> 7xD	139.9	174.0	177.1	224.0	50	20	1/8*	YES	<b>ST07180-20FM</b>	

\*Thread to BSP and ISO 7-1

## Connection Accessories

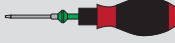
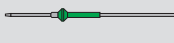
 Insert Screws	 Nylon Locking Screws	 Insert Driver	 Preset Torque Hand Driver	 Replacement Tips	Admissible Tightening Torque*
7375-IP9-1	7375N-IP9-1	8IP-9	8IP-9TL	8IP-9B	27.0 in-lbs (305 N-cm)

\*Tightening torques are calculated with a friction coefficient of  $\mu = 0.14$  and develop 90% of ultimate yield strength

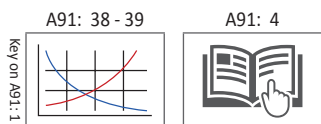

**i** = Imperial (in)  
**m** = Metric (mm)

Inserts sold in multiples of 1 | Screws sold in multiples of 10

**NOTICE:** Structural Steel GEN3SYS XT holders are specifically designed to be used only with XTST geometry inserts. Using other GEN3SYS XT or XT Pro insert geometries in these holders could lead to chip packing and tool failure. Contact Application Engineering for questions regarding proper use of tools.



## GEN3SYS® XT Pro Structural Steel Drilling System

20 Series | Diameter Range: 0.7874" - 0.8660" (20.00mm - 21.99mm)

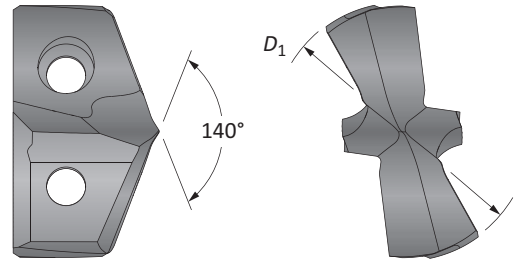
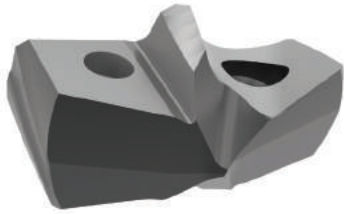

### Inserts

Fractional Equivalent	Insert $D_1$ inch	$D_1$ mm	XTST Part No.
-	0.7874	20.00	<b>XTST20-20.00</b>
13/16	0.8125	20.64	<b>XTST20-20.64</b>
-	0.8268	21.00	<b>XTST20-21.00</b>
-	0.8594	21.82	<b>XTST20-21.82</b>

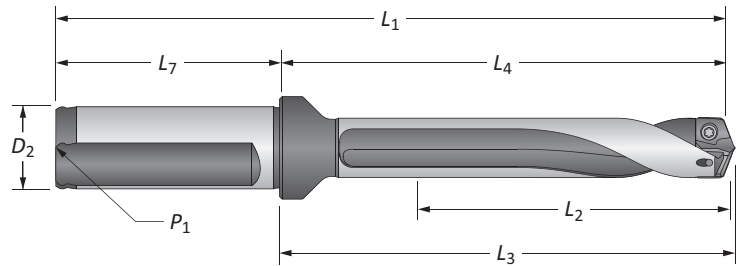

### Holders

Length	Body				Shank				Flat	Part No.
	$L_2$	$L_4$	$L_3$	$L_1$	$L_7$	$D_2$	$P_1$			
<b>i</b> 3xD	2-17/32	3-15/16	4-1/16	6-7/32	2-9/32	1	1/8	YES	<b>ST03200-100F</b>	
5xD	4-11/32	5-43/64	5-51/64	7-61/64	2-9/32	1	1/8	YES	<b>ST05200-100F</b>	
7xD	6-1/16	7-13/32	7-17/32	9-11/16	2-9/32	1	1/8	YES	<b>ST07200-100F</b>	
<b>m</b> 3xD	66.0	100.1	103.3	156.1	56	25	1/8*	YES	<b>ST03200-25FM</b>	
5xD	110.0	144.1	147.2	200.1	56	25	1/8*	YES	<b>ST05200-25FM</b>	
7xD	153.9	188.1	191.2	244.1	56	25	1/8*	YES	<b>ST07200-25FM</b>	

\*Thread to BSP and ISO 7-1

### Connection Accessories

Insert Screws	Nylon Locking Screws	Insert Driver	Preset Torque Hand Driver	Replacement Tips	Admissible Tightening Torque*
7375-IP9-1	7375N-IP9-1	8IP-9	8IP-9TL	8IP-9B	27.0 in-lbs (305 N-cm)

\*Tightening torques are calculated with a friction coefficient of  $\mu = 0.14$  and develop 90% of ultimate yield strength



**i** = Imperial (in)  
**m** = Metric (mm)

Inserts sold in multiples of 1 | Screws sold in multiples of 10

**NOTICE:** Structural Steel GEN3SYS XT holders are specifically designed to be used only with XTST geometry inserts. Using other GEN3SYS XT or XT Pro insert geometries in these holders could lead to chip packing and tool failure. Contact Application Engineering for questions regarding proper use of tools.

## GEN3SYS® XT Pro Structural Steel Drilling System

22 Series | Diameter Range: 0.8661" - 0.9448" (22.00mm - 23.99mm)

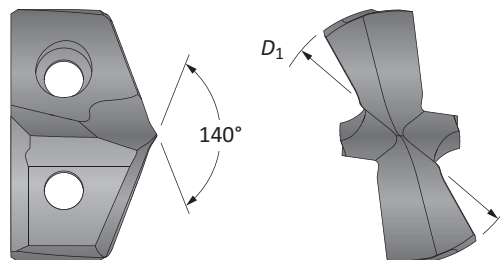
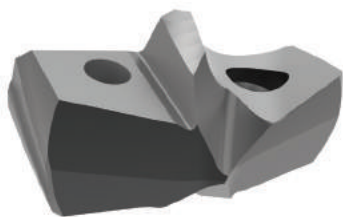

### Inserts

Fractional Equivalent	Insert $D_1$ inch	$D_1$ mm	XTST Part No.
-	0.8661	22.00	XTST22-22.00
7/8	0.8750	22.23	XTST22-22.23
-	0.9055	23.00	XTST22-23.00
15/16	0.9375	23.81	XTST22-23.81

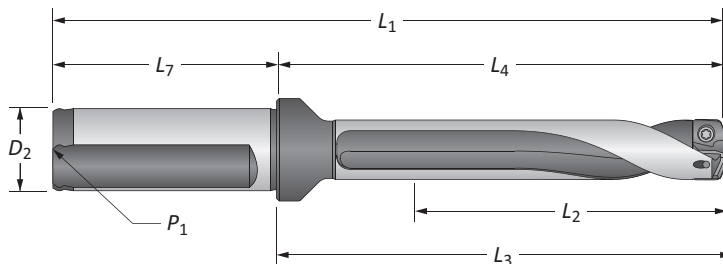

### Holders

Length	Body				Shank				Flat	Part No.
	$L_2$	$L_4$	$L_3$	$L_1$	$L_7$	$D_2$	$P_1$			
3xD	2-53/64	4-9/64	4-9/32	6-27/64	2-9/32	1	1/8	YES	ST03220-100F	
3xD	2-53/64	4-9/64	4-9/32	6-27/64	2-9/32	1	1/8	YES	ST03225-100F**	
5xD	4-23/32	6-1/32	6-11/64	8-5/16	2-9/32	1	1/8	YES	ST05220-100F	
5xD	4-23/32	6-1/32	6-11/64	8-5/16	2-9/32	1	1/8	YES	ST05225-100F**	
7xD	6-39/64	7-59/64	8-1/16	10-13/64	2-9/32	1	1/8	YES	ST07220-100F	
7xD	6-39/64	7-59/64	8-1/16	10-13/64	2-9/32	1	1/8	YES	ST07225-100F**	
3xD	72.0	105.3	108.7	161.3	56	25	1/8*	YES	ST03220-25FM	
3xD	72.0	105.3	108.7	161.3	56	25	1/8*	YES	ST03225-25FM**	
5xD	119.9	153.3	156.7	209.3	56	25	1/8*	YES	ST05220-25FM	
5xD	119.9	153.3	156.7	209.3	56	25	1/8*	YES	ST05225-25FM**	
7xD	167.9	201.3	204.7	257.3	56	25	1/8*	YES	ST07220-25FM	
7xD	167.9	201.3	204.7	257.3	56	25	1/8*	YES	ST07225-25FM**	

\*Thread to BSP and ISO 7-1 | \*\*Oversized body holder (minimum drill diameter = 23mm)

### Connection Accessories

Insert Screws	Nylon Locking Screws	Insert Driver	Preset Torque Hand Driver	Replacement Tips	Admissible Tightening Torque*
739-IP9-1	739N-IP9-1	8IP-9	8IP-9TL	8IP-9B	27.0 in-lbs (305 N-cm)

\*Tightening torques are calculated with a friction coefficient of  $\mu = 0.14$  and develop 90% of ultimate yield strength

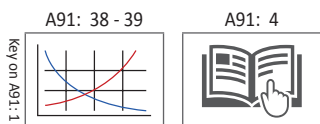

**i** = Imperial (in)  
**m** = Metric (mm)

Inserts sold in multiples of 1 | Screws sold in multiples of 10

**NOTICE:** Structural Steel GEN3SYS XT holders are specifically designed to be used only with XTST geometry inserts. Using other GEN3SYS XT or XT Pro insert geometries in these holders could lead to chip packing and tool failure. Contact Application Engineering for questions regarding proper use of tools.



## GEN3SYS® XT Pro Structural Steel Drilling System

24 Series | Diameter Range: 0.9449" - 1.0235" (24.00mm - 25.99mm)

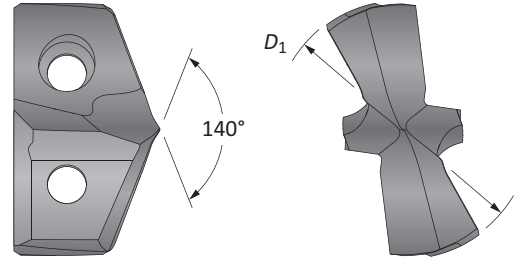
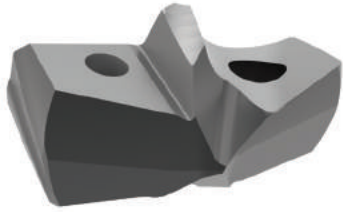

### Inserts

Fractional Equivalent	Insert $D_1$ inch	$D_1$ mm	 XTST Part No.
–	0.9449	24.00	<b>XTST24-24.00</b>
–	0.9685	24.60	<b>XTST24-24.60</b>
1	1.0000	25.40	<b>XTST24-25.40</b>
–	1.0150	25.78	<b>XTST24-25.78</b>

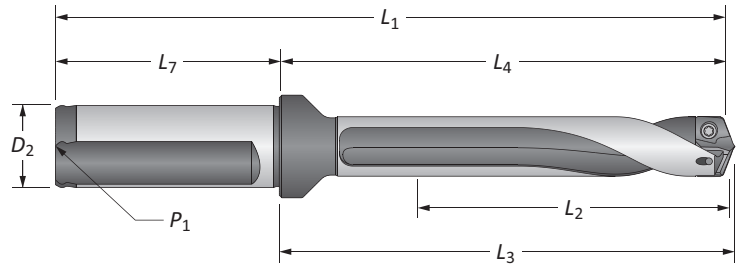





### Holders

Length	Body				Shank				Flat	Part No.
	$L_2$	$L_4$	$L_3$	$L_1$	$L_7$	$D_2$	$P_1$			
<b>i</b> 3xD	3-5/64	4-31/64	4-5/8	6-49/64	2-9/32	1	1/8	YES	<b>ST03240-100F</b>	
5xD	5-1/8	6-17/32	6-21/32	8-13/16	2-9/32	1	1/8	YES	<b>ST05240-100F</b>	
7xD	7-11/64	8-37/64	8-45/64	10-55/64	2-9/32	1	1/8	YES	<b>ST07240-100F</b>	
<b>m</b> 3xD	78.0	113.8	117.3	169.8	56	25	1/8*	YES	<b>ST03240-25FM</b>	
5xD	129.9	165.8	169.2	221.8	56	25	1/8*	YES	<b>ST05240-25FM</b>	
7xD	181.9	217.8	221.2	273.8	56	25	1/8*	YES	<b>ST07240-25FM</b>	

\*Thread to BSP and ISO 7-1

### Connection Accessories

 Insert Screws	 Nylon Locking Screws	 Insert Driver	 Preset Torque Hand Driver	 Replacement Tips	Admissible Tightening Torque*
739-IP9-1	739N-IP9-1	8IP-9	8IP-9TL	8IP-9B	27.0 in-lbs (305 N-cm)

\*Tightening torques are calculated with a friction coefficient of  $\mu = 0.14$  and develop 90% of ultimate yield strength

A91: 38 - 39

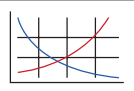

A91: 4



**i** = Imperial (in)  
**m** = Metric (mm)

Inserts sold in multiples of 1 | Screws sold in multiples of 10

**NOTICE:** Structural Steel GEN3SYS XT holders are specifically designed to be used only with XTST geometry inserts. Using other GEN3SYS XT or XT Pro insert geometries in these holders could lead to chip packing and tool failure. Contact Application Engineering for questions regarding proper use of tools.

## GEN3SYS® XT Pro Structural Steel Drilling System

26 Series | Diameter Range: 1.0236" - 1.1416" (26.00mm - 28.99mm)

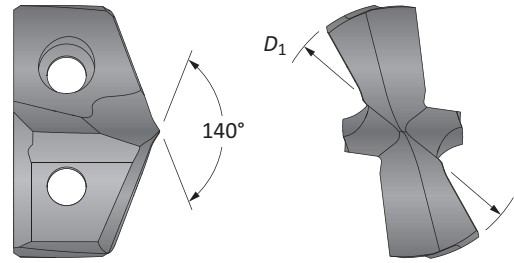
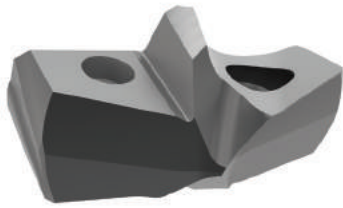

### Inserts

Fractional Equivalent	Insert		 XTST Part No.
	$D_1$ inch	$D_1$ mm	
-	1.0236	26.00	XTST26-26.00
1-1/16	1.0625	26.99	XTST26-26.99
-	1.0630	27.00	XTST26-27.00
-	1.1024	28.00	XTST26-28.00
1-1/8	1.1250	28.58	XTST26-28.58

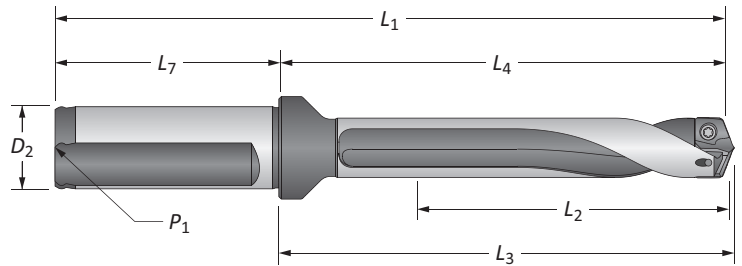





### Holders

Length	Body				Shank				Part No.
	$L_2$	$L_4$	$L_3$	$L_1$	$L_7$	$D_2$	$P_1$	Flat	
<b>i</b> 3xD	3-27/64	5-1/16	5-3/16	7-11/32	2-9/32	1-1/4	1/4	YES	ST03260-125F
<b>i</b> 5xD	5-23/32	7-11/32	7-31/64	9-5/8	2-9/32	1-1/4	1/4	YES	ST05260-125F
<b>i</b> 7xD	7-63/64	9-5/8	9-49/64	11-29/32	2-9/32	1-1/4	1/4	YES	ST07260-125F
<b>m</b> 3xD	87.0	128.1	131.4	188.1	60	32	1/4*	YES	ST03260-32FM
<b>m</b> 5xD	145.0	186.1	189.4	246.1	60	32	1/4*	YES	ST05260-32FM
<b>m</b> 7xD	202.9	244.0	247.4	304.0	60	32	1/4*	YES	ST07260-32FM

\*Thread to BSP and ISO 7-1

### Connection Accessories

 Insert Screws	 Nylon Locking Screws	 Insert Driver	 Preset Torque Hand Driver	 Replacement Tips	Admissible Tightening Torque*
7495-IP15-1	7495N-IP15-1	8IP-15	8IP-15TL	8IP-15B	61.0 in-lbs (690 N-cm)

\*Tightening torques are calculated with a friction coefficient of  $\mu = 0.14$  and develop 90% of ultimate yield strength



**i** = Imperial (in)  
**m** = Metric (mm)

Inserts sold in multiples of 1 | Screws sold in multiples of 10

**NOTICE:** Structural Steel GEN3SYS XT holders are specifically designed to be used only with XTST geometry inserts. Using other GEN3SYS XT or XT Pro insert geometries in these holders could lead to chip packing and tool failure. Contact Application Engineering for questions regarding proper use of tools.



## GEN3SYS® XT Pro Structural Steel Drilling System

29 Series | Diameter Range: 1.1417" - 1.2597" (29.00mm - 31.99mm)

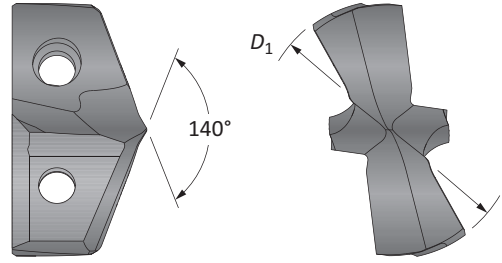
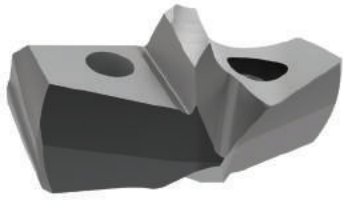

### Inserts

Fractional Equivalent	Insert $D_1$ inch	$D_1$ mm	 XTST Part No.
-	1.1417	29.00	XTST29-29.00
-	1.1811	30.00	XTST29-30.00
1-3/16	1.1875	30.16	XTST29-30.16
-	1.2205	31.00	XTST29-31.00
1-1/4	1.2500	31.75	XTST29-31.75

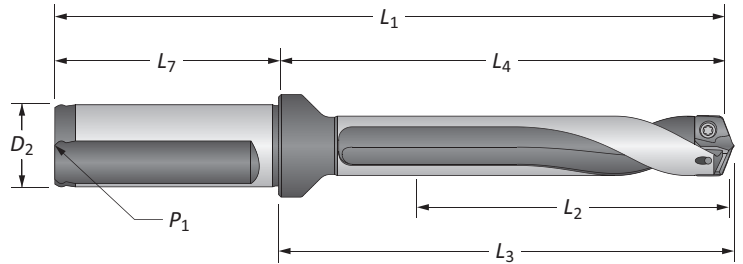





### Holders

	Length	Body				Shank				Part No.
		$L_2$	$L_4$	$L_3$	$L_1$	$L_7$	$D_2$	$P_1$	Flat	
i	3xD	3-25/32	5-3/8	5-33/64	7-21/32	2-9/32	1-1/4	1/4	YES	ST03290-125F
	5xD	6-19/64	7-29/32	8-3/64	10-3/16	2-9/32	1-1/4	1/4	YES	ST05290-125F
	7xD	8-13/16	10-27/64	10-9/16	12-45/64	2-9/32	1-1/4	1/4	YES	ST07290-125F
m	3xD	96.0	136.2	139.7	196.2	60	32	1/4*	YES	ST03290-32FM
	5xD	159.9	200.1	203.7	260.1	60	32	1/4*	YES	ST05290-32FM
	7xD	223.9	264.1	267.7	324.1	60	32	1/4*	YES	ST07290-32FM

\*Thread to BSP and ISO 7-1

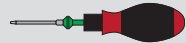
### Connection Accessories

 Insert Screws	 Nylon Locking Screws	 Insert Driver	 Preset Torque Hand Driver	 Replacement Tips	Admissible Tightening Torque*
7495-IP15-1	7495N-IP15-1	8IP-15	8IP-15TL	8IP-15B	61.0 in-lbs (690 N-cm)

\*Tightening torques are calculated with a friction coefficient of  $\mu = 0.14$  and develop 90% of ultimate yield strength

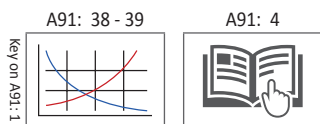

i = Imperial (in)  
m = Metric (mm)

Inserts sold in multiples of 1 | Screws sold in multiples of 10

**NOTICE:** Structural Steel GEN3SYS XT holders are specifically designed to be used only with XTST geometry inserts. Using other GEN3SYS XT or XT Pro insert geometries in these holders could lead to chip packing and tool failure. Contact Application Engineering for questions regarding proper use of tools.

## GEN3SYS® XT Pro Structural Steel Drilling System

32 Series | Diameter Range: 1.2598" - 1.3780" (32.00mm - 35.00mm)

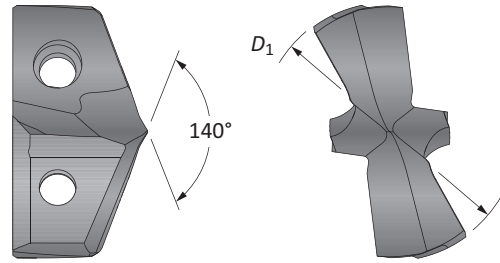
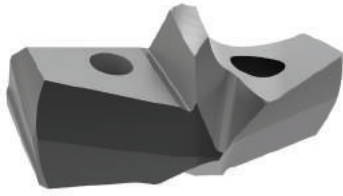

### Inserts

Fractional Equivalent	Insert $D_1$ inch	$D_1$ mm	 XTST Part No.
–	1.2598	32.00	XTST32-32.00
–	1.2992	33.00	XTST32-33.00
1-5/16	1.3125	33.34	XTST32-33.34
–	1.3386	34.00	XTST32-34.00
1-3/8	1.3750	34.93	XTST32-34.93

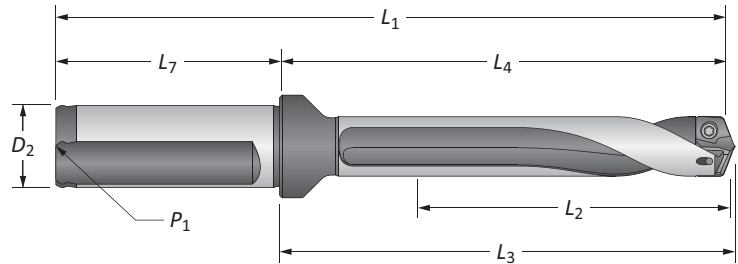





### Holders

Length	Body				Shank				Flat	Part No.
	$L_2$	$L_4$	$L_3$	$L_1$	$L_7$	$D_2$	$P_1$			
<b>i</b> 3xD	4-9/64	6-7/32	6-3/8	8-29/32	2-11/16	1-1/2	1/4	YES	ST03320-150F	
<b>i</b> 5xD	6-59/64	8-31/32	9-1/8	11-21/32	2-11/16	1-1/2	1/4	YES	ST05320-150F	
<b>i</b> 7xD	9-41/64	11-23/32	11-57/64	14-13/32	2-11/16	1-1/2	1/4	YES	ST07320-150F	
<b>m</b> 3xD	105.0	157.7	162.0	217.7	60	32	1/4*	YES	ST03320-32FM	
<b>m</b> 3xD	105.0	157.7	162.0	227.7	70	40	1/4*	YES	ST03320-40FM	
<b>m</b> 5xD	175.0	227.7	232.0	287.7	60	32	1/4*	YES	ST05320-32FM	
<b>m</b> 5xD	175.0	227.7	232.0	297.7	70	40	1/4*	YES	ST05320-40FM	
<b>m</b> 7xD	244.9	297.7	302.2	357.7	60	32	1/4*	YES	ST07320-32FM	
<b>m</b> 7xD	244.9	297.7	302.2	367.7	70	40	1/4*	YES	ST07320-40FM	

\*Thread to BSP and ISO 7-1

### Connection Accessories

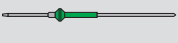
 Insert Screws	 Nylon Locking Screws	 Insert Driver	 Preset Torque Hand Driver	 Replacement Tips	Admissible Tightening Torque*
7495-IP15-1	7495N-IP15-1	8IP-15	8IP-15TL	8IP-15B	61.0 in-lbs (690 N-cm)

\*Tightening torques are calculated with a friction coefficient of  $\mu = 0.14$  and develop 90% of ultimate yield strength



**i** = Imperial (in)  
**m** = Metric (mm)

Inserts sold in multiples of 1 | Screws sold in multiples of 10

**NOTICE:** Structural Steel GEN3SYS XT holders are specifically designed to be used only with XTST geometry inserts. Using other GEN3SYS XT or XT Pro insert geometries in these holders could lead to chip packing and tool failure. Contact Application Engineering for questions regarding proper use of tools.



T-A® Structural Steel Drilling System

A DRILLING

B BORING

C REAMING

D BURNISHING

E THREADING

X SPECIALS

STRUCTURAL STEEL  
**ENHANCEMENTS**

Original T-A & GEN2 T-A

**GEN2 T-A Insert**

Available in AM200® Coating

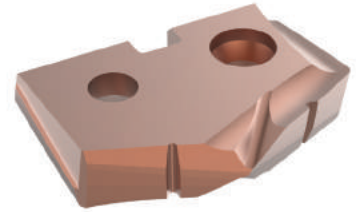

**High Efficiency (-HE)**

- Improves performance
- Improves tool life
- Improves chip formation in structural steel materials

**Original T-A Inserts**

Available in AM200® and TiAlN Coatings

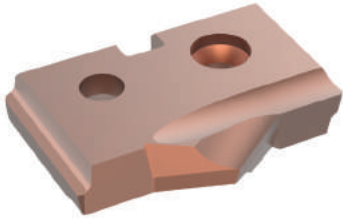

**Thin Wall (-TW)**

- Designed for drilling 7/16" thick or less I-Beam or structural materials
- Increases hole diameter tolerance
- Improves hole roundness
- Decreases material deflection

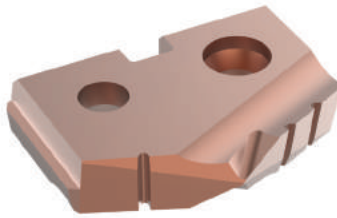

**Notch Point® (-NP)**

- Provides excellent self-centering characteristics
- Reduces bell mouth and tool lead-off
- Reduces axial thrust requirements

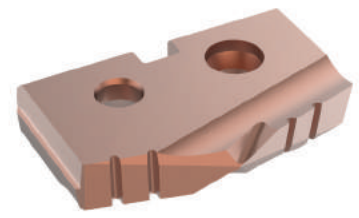

**Structural Steel (-SS)**

- Designed for drilling 7/16" thick or thicker I-Beam or structural materials
- Reduces exit burrs
- Increases stability
- Lowers drilling forces
- Includes Notch Point® web geometry



**Holder Anatomy**

1. Morse Taper Shank
2. Coolant Inlet
3. Flute (straight or helical)
4. Built-up Body Diameter
5. Coolant Outlets



Straight Flute



Helical Flute

## T-A® Drill Nomenclature

### T-A Drill Inserts

<b>4</b>	<b>5</b>	<b>3</b>	<b>H</b>	-	<b>0115</b>	-	<b>HE</b>
1	2	3	4		5		6

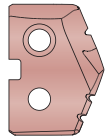

1. Insert	2. Material	3. Series	4. Coating	5. Diameter	6. Geometry
1 = Original T-A 4 = GEN2 T-A	5 = Super cobalt C1 = C1 (K35) carbide	0 = 0 series 1 = 1 series 2 = 2 series 3 = 3 series	H = AM200® A = TiAlN	0017 = Inch .515 = Decimal 13 = Metric	TW = Thin Wall NP = Notch Point® SS = Structural Steel HE = High Efficiency

#### Reference Key

Symbol	Attribute
$D_1$	Insert diameter
$T_1$	Insert thickness

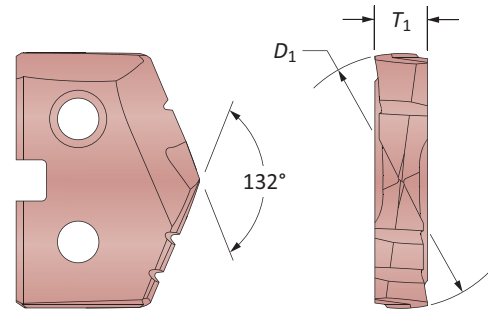

### T-A Drill Holders

<b>2</b>	<b>40</b>	<b>20</b>	<b>S</b>	-	<b>004</b>	<b>IS</b>	<b>060</b>
1	2	3	4		5	6	7



1. Holder	2. Length	3. Series	4. Flute
2 = T-A holder	20 = Short 40 = Standard 50 = Extended 60 = Long	00 = 0 series 05 = 0.5 series 10 = 1 series 15 = 1.5 series 20 = 2 series 25 = 2.5 series 30 = 3 series	S = Straight H = Helical
5. Shank Designator	6. Shank Code	7. Minimum Insert Diameter	
003 = 3MT 004 = 4MT	IS = Imperial Morse taper structural steel	In increments of 1/64 of an inch	

#### Reference Key

Symbol	Attribute	Symbol	Attribute
$D_1$	Drill insert range	$L_4$	Flute length
$L_1$	Overall length	$P_1$	Rear pipe tap
$L_2$	Drill depth	$P_2$	Side pipe tap
$L_3$	Holder reference length	MT	Morse taper size
$L_3^*$	Holder reference length		

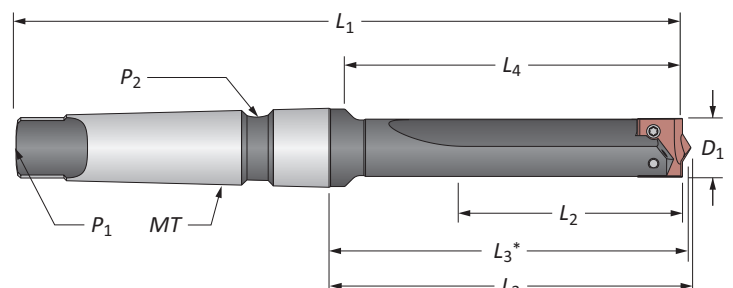

\*If using Structural Steel holder with Notch Point®, GEN2 T-A, or 150° Structural Steel T-A drill insert geometry

0

DRILLING | Structural Steel Replaceable Insert Drilling System

A

**Original T-A® Structural Steel Drill Inserts**

0 Series | Diameter Range: 0.5512" - 0.6875" (14.00mm - 17.46mm)

DRILLING

**Thin Wall**  
 For material up to 7/16" thick

B

BORING

**Notch Point®**  
 For material over 7/16" thick

C

REAMING

**150° Structural Steel**  
 For material over 7/16" thick  
 and for reduced exit burr

D

BURNISHING

**HSS Inserts – Super Cobalt**

Series	Insert				Thin Wall		Notch Point		150° Structural Steel	
	Fractional Equivalent	$D_1$ inch	$D_1$ mm	$T_1$	AM200 Part No.	TiAlN Part No.	AM200 Part No.	TiAlN Part No.	AM200 Part No.	TiAlN Part No.
0	–	0.5512	14.00	1/8	<b>150H-14-TW</b>	<b>150A-14-TW</b>	<b>150H-14-NP</b>	<b>150A-14-NP</b>	<b>150H-14-SS</b>	<b>150A-14-SS</b>
	9/16	0.5625	14.29	1/8	<b>150H-0018-TW</b>	<b>150A-0018-TW</b>	<b>150H-0018-NP</b>	<b>150A-0018-NP</b>	<b>150H-0018-SS</b>	<b>150A-0018-SS</b>
	5/8	0.6250	15.88	1/8	<b>150H-0020-TW</b>	<b>150A-0020-TW</b>	<b>150H-0020-NP</b>	<b>150A-0020-NP</b>	<b>150H-0020-SS</b>	<b>150A-0020-SS</b>
0.5	–	0.6299	16.00	1/8	<b>150H-16-TW</b>	<b>150A-16-TW</b>	<b>150H-16-NP</b>	<b>150A-16-NP</b>	<b>150H-16-SS</b>	<b>150A-16-SS</b>
	11/16	0.6875	17.46	1/8	<b>150H-0022-TW</b>	<b>150A-0022-TW</b>	<b>150H-0022-NP</b>	<b>150A-0022-NP</b>	<b>150H-0022-SS</b>	<b>150A-0022-SS</b>

E

THREADING

X

SPECIALS

A91: 40 - 41 A91: 20  A91: 24 - 25

Key on A91: 1

Inserts sold in multiples of 2

A91: 22

[www.alliedmachine.com](http://www.alliedmachine.com) | 1.330.343.4283



## GEN2 T-A® Structural Steel Drill Inserts

0 Series | Diameter Range: 0.5512" - 0.6875" (14.00mm - 17.46mm)

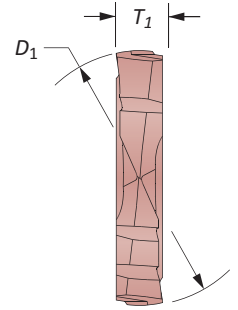
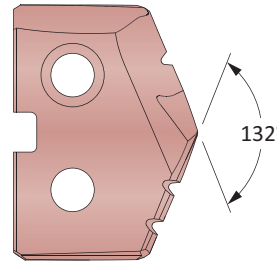
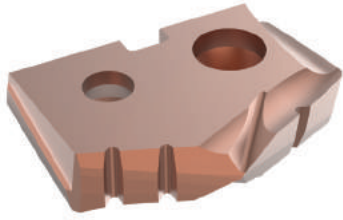

HSS Inserts – Super Cobalt | Carbide Inserts – C1 (K35)

Series	Fractional Equivalent	Insert			Part No.	
		D <sub>1</sub> inch	D <sub>1</sub> mm	T <sub>1</sub>	Super Cobalt	C1 (K35)
0	–	0.5512	14.00	1/8	450H-14-HE	4C10H-14-HE
	9/16	0.5625	14.29	1/8	450H-0018-HE	4C10H-0018-HE
0.5	5/8	0.6250	15.88	1/8	450H-0020-HE	4C10H-0020-HE
	–	0.6299	16.00	1/8	450H-16-HE	4C10H-16-HE
	11/16	0.6875	17.46	1/8	450H-0022-HE	4C10H-0022-HE

Key on A91-1

A91: 40 - 41

A91: 20

A91: 24 - 25

Inserts sold in multiples of 2

## T-A® Structural Steel Drill Insert Holders

0 Series | Taper Shank

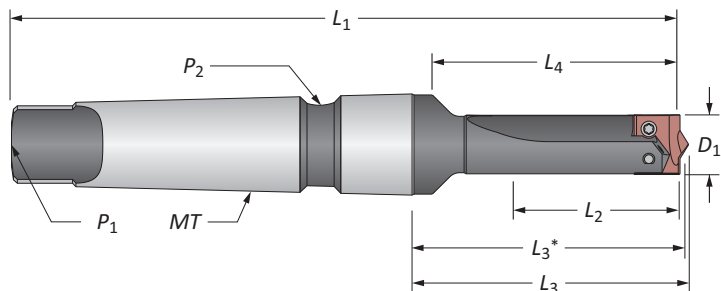

### Straight Flute #3 Morse Taper

Series	Length	$D_1$	Body					Shank			Part No.	
			$L_2$	$L_4$	$L_3$	$L_3^*$	$L_1$	MT	$P_1$	$P_2$		
i	0	Short	9/16	1-3/8	2-3/16	2-35/64	2-31/64	6-1/16	#3	TTC	TSC	22000S-003IS036
	0.5	Short	5/8	1-3/8	2-3/16	2-35/64	2-31/64	6-1/16	#3	TTC	TSC	22005S-003IS040
		Short	11/16	1-3/8	2-3/16	2-35/64	2-31/64	6-1/16	#3	TTC	TSC	22005S-003IS044
m	0	Short	14	35	56	64.7	63.1	154	#3	TTC	TSC	22000S-003IS036
		Short	16	35	56	64.7	63.1	154	#3	TTC	TSC	22000S-003IS040
		Short	17.5	35	56	64.7	63.1	154	#3	TTC	TSC	22000S-003IS044

\*If using Structural Steel holder with Notch Point®, GEN2 T-A, or 150° Structural Steel T-A drill insert geometry

### Connection Accessories

Series	Insert Screws	Nylon Locking Screws	Insert Driver	Preset Torque Hand Driver	Replacement Tips	Admissible Tightening Torque*
0	72556-IP8-1	72556N-IP8-1	8IP-8	8IP-8TL	8IP-8B	15.5 in-lbs (175 N-cm)
0.5	72567-IP8-1	72567N-IP8-1	8IP-8	8IP-8TL	8IP-8B	15.5 in-lbs (175 N-cm)

\*Tightening torques are calculated with a friction coefficient of  $\mu = 0.14$  and develop 90% of ultimate yield strength

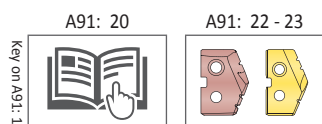

i = Imperial (in)  
m = Metric (mm)

Screws sold in multiples of 10





## T-A® Structural Steel Drill Insert Holders

O Series | Taper Shank

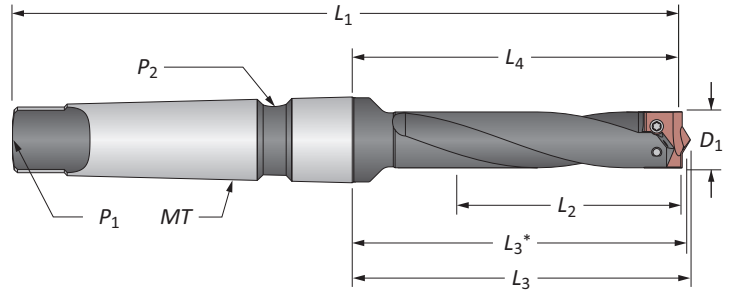

### Helical Flute #3 Morse Taper

Series	Length	D <sub>1</sub>	Body					Shank			Part No.	
			L <sub>2</sub>	L <sub>4</sub>	L <sub>3</sub>	L <sub>3</sub> *	L <sub>1</sub>	MT	P <sub>1</sub>	P <sub>2</sub>		
i	0	Standard	9/16	2-1/2	3-5/16	3-43/64	3-39/64	7-3/16	#3	TTC	TSC	24000H-003IS036
		Extended	9/16	6-1/2	9-7/16	9-51/64	9-19/32	13-5/64	#3	TTC	TSC	⚠ 25000H-003IS036
	0.5	Standard	5/8	2-1/2	3-5/16	3-43/64	3-39/64	7-3/16	#3	TTC	TSC	24005H-003IS040
		Extended	11/16	6-1/2	9-7/16	9-51/64	9-19/32	13-5/64	#3	TTC	TSC	⚠ 25005H-003IS044
m	0	Standard	14	64	84	93.3	91.7	183	#3	TTC	TSC	24000H-003IS036
		Extended	14	165	240	248.8	243.7	338	#3	TTC	TSC	⚠ 25000H-003IS036
	0.5	Standard	16	64	84	93.3	91.7	183	#3	TTC	TSC	24005H-003IS040
		Extended	17.5	165	240	248.8	243.7	338	#3	TTC	TSC	⚠ 25005H-003IS044

\*If using Structural Steel holder with Notch Point®, GEN2 T-A, or 150° Structural Steel T-A drill insert geometry

i = Imperial (in)  
m = Metric (mm)





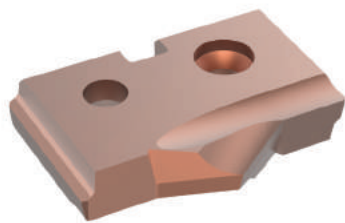
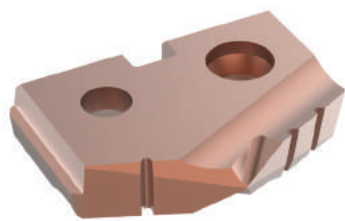
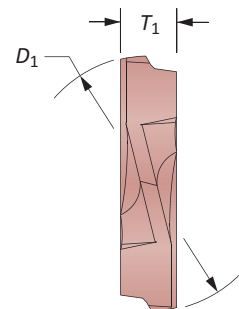
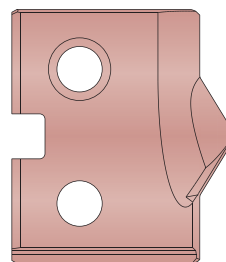
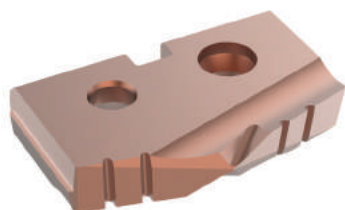
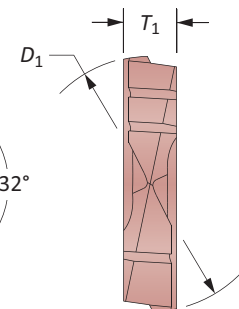
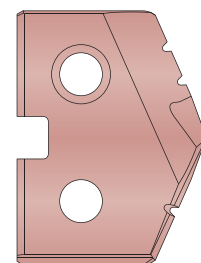
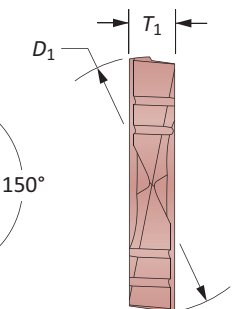
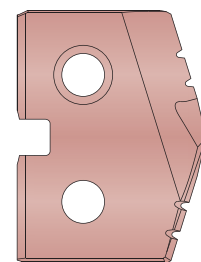

Screws sold in multiples of 10

**⚠ WARNING** Refer to Speed and Feed charts for recommended adjustments to speeds and feeds. Refer to page A91: 35 for deep hole drilling guidelines in this section of the catalog. Visit [www.alliedmachine.com/DeepHoleGuidelines](http://www.alliedmachine.com/DeepHoleGuidelines) for the most up-to-date information and procedures. Factory technical assistance is available for your specific applications through our Application Engineering Team.

**Original T-A® Structural Steel Drill Inserts**

1 Series | Diameter Range: 0.7087" - 0.9449" (18.00mm - 24.00mm)

**Thin Wall**  
For material up to 7/16" thick**Notch Point®**  
For material over 7/16" thick**150° Structural Steel**  
For material over 7/16" thick  
and for reduced exit burr**HSS Inserts – Super Cobalt**

Series	Insert				Thin Wall		Notch Point		150° Structural Steel	
	Fractional Equivalent	D <sub>1</sub> inch	D <sub>1</sub> mm	T <sub>1</sub>	 AM200 Part No.	 TiAlN Part No.	 AM200 Part No.	 TiAlN Part No.	 AM200 Part No.	 TiAlN Part No.
1	–	0.7087	18.00	5/32	<b>151H-18-TW</b>	<b>151A-18-TW</b>	<b>151H-18-NP</b>	<b>151A-18-NP</b>	<b>151H-18-SS</b>	<b>151A-18-SS</b>
	13/16	0.8125	20.64	5/32	<b>151H-0026-TW</b>	<b>151A-0026-TW</b>	<b>151H-0026-NP</b>	<b>151A-0026-NP</b>	<b>151H-0026-SS</b>	<b>151A-0026-SS</b>
	–	0.8268	21.00	5/32	<b>151H-21-TW</b>	<b>151A-21-TW</b>	<b>151H-21-NP</b>	<b>151A-21-NP</b>	<b>151H-21-SS</b>	<b>151A-21-SS</b>
	–	0.8661	22.00	5/32	<b>151H-22-TW</b>	<b>151A-22-TW</b>	<b>151H-22-NP</b>	<b>151A-22-NP</b>	<b>151H-22-SS</b>	<b>151A-22-SS</b>
1.5	7/8	0.8750	22.23	5/32	<b>151H-0028-TW</b>	<b>151A-0028-TW</b>	<b>151H-0028-NP</b>	<b>151A-0028-NP</b>	<b>151H-0028-SS</b>	<b>151A-0028-SS</b>
	15/16	0.9375	23.81	5/32	<b>151H-0030-TW</b>	<b>151A-0030-TW</b>	<b>151H-0030-NP</b>	<b>151A-0030-NP</b>	<b>151H-0030-SS</b>	<b>151A-0030-SS</b>
	–	0.9449	24.00	5/32	<b>151H-24-TW</b>	<b>151A-24-TW</b>	<b>151H-24-NP</b>	<b>151A-24-NP</b>	<b>151H-24-SS</b>	<b>151A-24-SS</b>

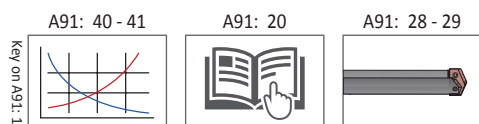

Inserts sold in multiples of 2



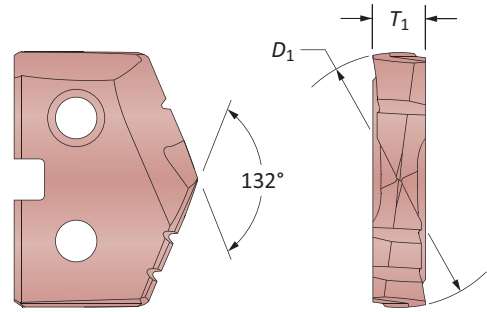
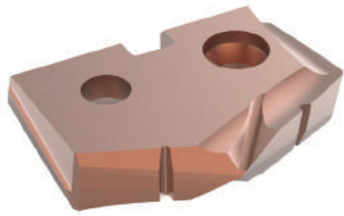

## GEN2 T-A® Structural Steel Drill Inserts

1 Series | Diameter Range: 0.7087" - 0.9449" (18.00mm - 24.00mm)



HSS Inserts – Super Cobalt | Carbide Inserts – C1 (K35)

Series	Fractional Equivalent	Insert			Part No.	
		D <sub>1</sub> inch	D <sub>1</sub> mm	T <sub>1</sub>	Super Cobalt	C1 (K35)
1	–	0.7087	18.00	5/32		
	13/16	0.8125	20.64	5/32	<b>451H-18-HE</b>	<b>4C11H-18-HE</b>
	–	0.8268	21.00	5/32	<b>451H-0026-HE</b>	<b>4C11H-0026-HE</b>
	–	0.8661	22.00	5/32	<b>451H-21-HE</b>	<b>4C11H-21-HE</b>
1.5	7/8	0.8750	22.23	5/32	<b>451H-22-HE</b>	<b>4C11H-22-HE</b>
	15/16	0.9375	23.81	5/32	<b>451H-0028-HE</b>	<b>4C11H-0028-HE</b>
	–	0.9449	24.00	5/32	<b>451H-0030-HE</b>	<b>4C11H-0030-HE</b>
					<b>451H-24-HE</b>	<b>4C11H-24-HE</b>

Key on A91-1

A91: 40 - 41

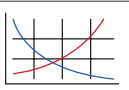

A91: 20



A91: 28 - 29



Inserts sold in multiples of 2

## T-A® Structural Steel Drill Insert Holders

1 Series | Taper Shank

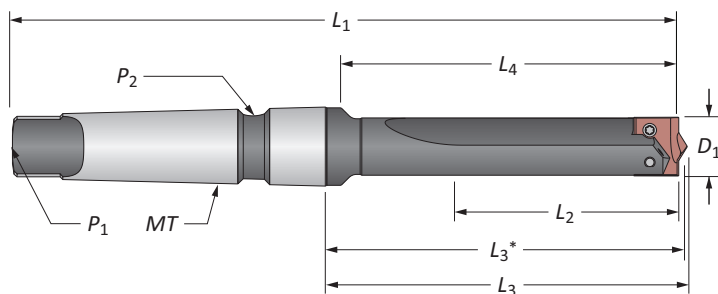

### Straight Flute #3 Morse Taper

Series	Length	$D_1$	Body					Shank			Part No.	
			$L_2$	$L_4$	$L_3$	$L_3^*$	$L_1$	MT	$P_1$	$P_2$		
i	1	Short	18mm	2-3/4	3-7/8	4-17/64	4-13/64	7-3/4	#3	TTC	TSC	22010S-003IS045
		Short	13/16	2-3/4	3-7/8	4-17/64	4-13/64	7-3/4	#3	TTC	TSC	22010S-003IS052
	1.5	Short	7/8	2-3/4	3-7/8	4-17/64	4-13/64	7-3/4	#3	TTC	TSC	22015S-003IS056
		Short	15/16	2-3/4	3-7/8	4-17/64	4-13/64	7-3/4	#3	TTC	TSC	22015S-003IS060
m	1	Short	18	70	98	108.4	106.8	197	#3	TTC	TSC	22010S-003IS045
		Short	21	70	98	108.4	106.8	197	#3	TTC	TSC	22010S-003IS052
	1.5	Short	22	70	98	108.4	106.8	197	#3	TTC	TSC	22015S-003IS056
		Short	24	70	98	108.4	106.8	197	#3	TTC	TSC	22015S-003IS060





\*If using Structural Steel holder with Notch Point®, GEN2 T-A, or 150° Structural Steel T-A drill insert geometry

### Straight Flute #4 Morse Taper

Series	Length	$D_1$	Body					Shank			Part No.	
			$L_2$	$L_4$	$L_3$	$L_3^*$	$L_1$	MT	$P_1$	$P_2$		
i	1	Short	18mm	2-3/4	3-7/8	4-21/64	4-17/64	8-3/4	#4	TTC	TSC	22010S-004IS045
		Short	13/16	2-3/4	3-7/8	4-21/64	4-17/64	8-3/4	#4	TTC	TSC	22010S-004IS052
	1.5	Short	7/8	2-3/4	3-7/8	4-21/64	4-17/64	8-3/4	#4	TTC	TSC	22015S-004IS056
		Short	15/16	2-3/4	3-7/8	4-21/64	4-17/64	8-3/4	#4	TTC	TSC	22015S-004IS060
m	1	Short	18	70	98	109.9	108.3	222	#4	TTC	TSC	22010S-004IS045
		Short	21	70	98	109.9	108.3	222	#4	TTC	TSC	22010S-004IS052
	1.5	Short	22	70	98	109.9	108.3	222	#4	TTC	TSC	22015S-004IS056
		Short	24	70	98	109.9	108.3	222	#4	TTC	TSC	22015S-004IS060

\*If using Structural Steel holder with Notch Point®, GEN2 T-A, or 150° Structural Steel T-A drill insert geometry

### Connection Accessories

Series	 Insert Screws	 Nylon Locking Screws	 Insert Driver	 Preset Torque Hand Driver	 Replacement Tips	Admissible Tightening Torque*
1	7375-IP9-1	7375N-IP9-1	8IP-9	8IP-9TL	8IP-9B	27.0 in-lbs (305 N-cm)
1.5	739-IP9-1	739N-IP9-1	8IP-9	8IP-9TL	8IP-9B	27.0 in-lbs (305 N-cm)

\*Tightening torques are calculated with a friction coefficient of  $\mu = 0.14$  and develop 90% of ultimate yield strength

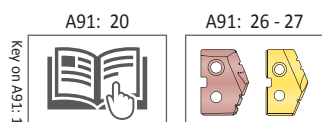

i = Imperial (in)  
m = Metric (mm)

Screws sold in multiples of 10



## T-A® Structural Steel Drill Insert Holders

1 Series | Taper Shank

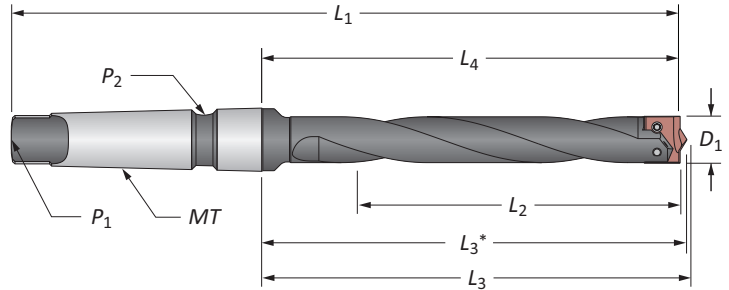

### Helical Flute #3 Morse Taper

Series	Length	D <sub>1</sub>	Body					Shank			Part No.	
			L <sub>2</sub>	L <sub>4</sub>	L <sub>3</sub>	L <sub>3</sub> *	L <sub>1</sub>	MT	P <sub>1</sub>	P <sub>2</sub>		
i	1	Standard	18mm	4-3/4	5-7/8	6-17/64	6-13/64	9-3/4	#3	TTC	TSC	24010H-003IS045
		Standard	13/16	4-3/4	5-7/8	6-17/64	6-13/64	9-3/4	#3	TTC	TSC	24010H-003IS052
		Extended	18mm	6-1/2	9-11/32	9-47/64	9-1/2	13-7/32	#3	TTC	TSC	⚠ 25010H-003IS045
	1.5	Standard	7/8	4-3/4	5-7/8	6-17/64	6-13/64	9-3/4	#3	TTC	TSC	24015H-003IS056
		Standard	15/16	4-3/4	5-7/8	6-17/64	6-13/64	9-3/4	#3	TTC	TSC	24015H-003IS060
		Extended	15/16	6-1/2	9-11/32	9-47/64	9-15/32	13-7/32	#3	TTC	TSC	⚠ 25015H-003IS060
m	1	Standard	18	121	149	159.2	157.6	248	#3	TTC	TSC	24010H-003IS045
		Standard	21	121	149	159.2	157.6	248	#3	TTC	TSC	24010H-003IS052
		Extended	18	165	237	247.3	241.3	336	#3	TTC	TSC	⚠ 25010H-003IS045
		Extended	22	165	237	247.3	241.3	336	#3	TTC	TSC	⚠ 25010H-003IS052
	1.5	Standard	22	121	149	159.2	157.6	248	#3	TTC	TSC	24015H-003IS056
		Standard	24	121	149	159.2	157.6	248	#3	TTC	TSC	24015H-003IS060
	Extended	24	165	237	247.3	234.5	336	#3	TTC	TSC	⚠ 25015H-003IS060	

\*If using Structural Steel holder with Notch Point®, GEN2 T-A, or 150° Structural Steel T-A drill insert geometry

### Helical Flute #4 Morse Taper

Series	Length	D <sub>1</sub>	Body					Shank			Part No.	
			L <sub>2</sub>	L <sub>4</sub>	L <sub>3</sub>	L <sub>3</sub> *	L <sub>1</sub>	MT	P <sub>1</sub>	P <sub>2</sub>		
i	1	Standard	18mm	4-3/4	5-7/8	6-21/64	6-17/64	10-3/4	#4	TTC	TSC	24010H-004IS045
		Standard	13/16	4-3/4	5-7/8	6-21/64	6-17/64	10-3/4	#4	TTC	TSC	24010H-004IS052
		Extended	13/16	6-1/2	9-9/32	9-47/64	9-43/64	14-5/32	#4	TTC	TSC	⚠ 25010H-004IS052
		Long	13/16	6-1/2	15-25/32	16-15/64	16-11/64	20-21/32	#4	TTC	TSC	⚠ 26010H-004IS052
	1.5	Standard	7/8	4-3/4	5-7/8	6-21/64	6-17/64	10-3/4	#4	TTC	TSC	24015H-004IS056
		Standard	15/16	4-3/4	5-7/8	6-21/64	6-17/64	10-3/4	#4	TTC	TSC	24015H-004IS060
	Extended	15/16	6-1/2	9-9/32	9-47/64	9-43/64	14-5/32	#4	TTC	TSC	⚠ 25015H-004IS060	
m	1	Standard	18	121	149	159.2	157.6	248	#4	TTC	TSC	24010H-004IS045
		Standard	21	121	149	159.2	157.6	248	#4	TTC	TSC	24010H-004IS052
		Extended	22	165	237	247.3	241.3	336	#4	TTC	TSC	⚠ 25010H-004IS052
		Long	22	165	237	247.3	241.3	336	#4	TTC	TSC	⚠ 26010H-004IS052
	1.5	Standard	22	121	149	159.2	157.6	248	#4	TTC	TSC	24015H-004IS056
		Standard	24	121	149	159.2	157.6	248	#4	TTC	TSC	24015H-004IS060
	Extended	24	165	237	247.3	234.5	336	#4	TTC	TSC	⚠ 25015H-004IS060	
	Long	24	165	237	247.3	234.5	336	#4	TTC	TSC	⚠ 26015H-004IS060	

\*If using Structural Steel holder with Notch Point®, GEN2 T-A, or 150° Structural Steel T-A drill insert geometry

i = Imperial (in)  
m = Metric (mm)

Screws sold in multiples of 10

**⚠ WARNING** Refer to Speed and Feed charts for recommended adjustments to speeds and feeds. Refer to page A91: 35 for deep hole drilling guidelines in this section of the catalog. Visit [www.alliedmachine.com/DeepHoleGuidelines](http://www.alliedmachine.com/DeepHoleGuidelines) for the most up-to-date information and procedures. Factory technical assistance is available for your specific applications through our Application Engineering Team.

A DRILLING  
B BORING  
C REAMING  
D BURNISHING  
E THREADING  
X SPECIALS



## Original T-A® Structural Steel Drill Inserts

2 Series | Diameter Range: 1.0000" - 1.3750" (25.40mm - 34.93mm)

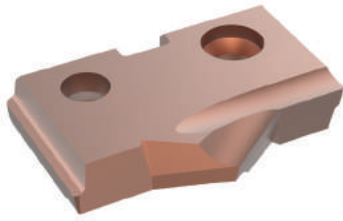

**Thin Wall**  
For material up to 7/16" thick

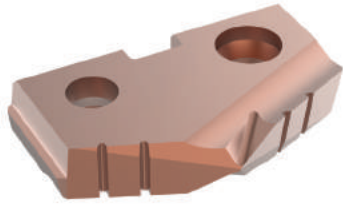
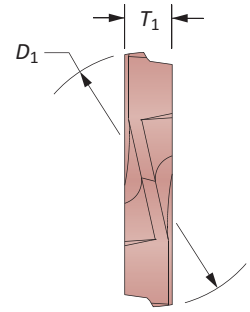
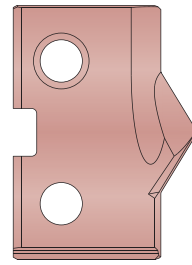

**Notch Point®**  
For material over 7/16" thick

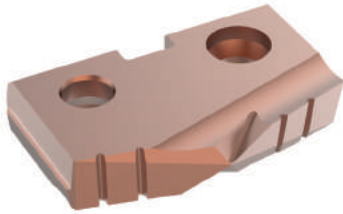
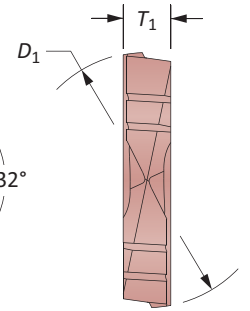
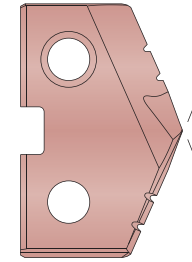

**150° Structural Steel**  
For material over 7/16" thick  
and for reduced exit burr

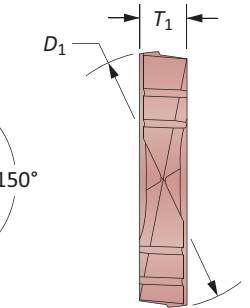
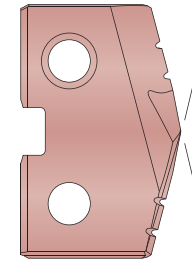

### HSS Inserts – Super Cobalt

Series	Insert				Thin Wall		Notch Point		150° Structural Steel	
	Fractional Equivalent	$D_1$ inch	$D_1$ mm	$T_1$	AM200 Part No.	TiAlN Part No.	AM200 Part No.	TiAlN Part No.	AM200 Part No.	TiAlN Part No.
2	1	1.0000	25.40	3/16	152H-0100-TW	152A-0100-TW	152H-0100-NP	152A-0100-NP	152H-0100-SS	152A-0100-SS
	–	1.0236	26.00	3/16	152H-26-TW	152A-26-TW	152H-26-NP	152A-26-NP	152H-26-SS	152A-26-SS
	1-1/16	1.0625	26.99	3/16	152H-0102-TW	152A-0102-TW	152H-0102-NP	152A-0102-NP	152H-0102-SS	152A-0102-SS
	–	1.0630	27.00	3/16	152H-27-TW	152A-27-TW	152H-27-NP	152A-27-NP	152H-27-SS	152A-27-SS
	1-1/8	1.1250	28.58	3/16	152H-0104-TW	152A-0104-TW	152H-0104-NP	152A-0104-NP	152H-0104-SS	152A-0104-SS
2.5	1-3/16	1.1875	30.16	3/16	152H-0106-TW	152A-0106-TW	152H-0106-NP	152A-0106-NP	152H-0106-SS	152A-0106-SS
	–	1.2205	31.00	3/16	152H-31-TW	152A-31-TW	152H-31-NP	152A-31-NP	152H-31-SS	152A-31-SS
	1-1/4	1.2500	31.75	3/16	152H-0108-TW	152A-0108-TW	152H-0108-NP	152A-0108-NP	152H-0108-SS	152A-0108-SS
	–	1.2992	33.00	3/16	152H-33-TW	152A-33-TW	152H-33-NP	152A-33-NP	152H-33-SS	152A-33-SS
	1-5/16	1.3125	33.34	3/16	152H-0110-TW	152A-0110-TW	152H-0110-NP	152A-0110-NP	152H-0110-SS	152A-0110-SS
	1-3/8	1.3750	34.93	3/16	152H-0112-TW	152A-0112-TW	152H-0112-NP	152A-0112-NP	152H-0112-SS	152A-0112-SS

A91: 40 - 41

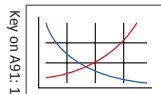

A91: 20



A91: 32 - 33

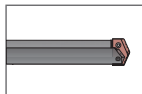



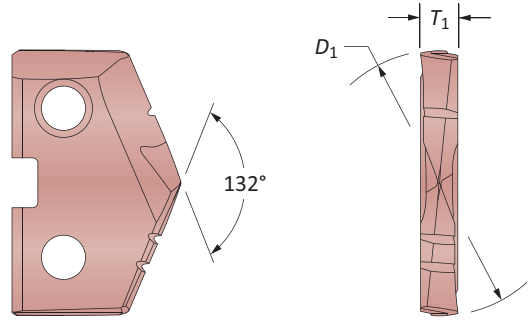
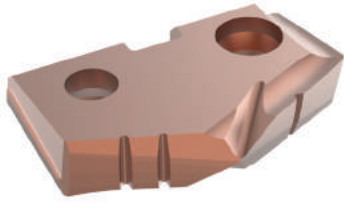

## GEN2 T-A® Structural Steel Drill Inserts

2 Series | Diameter Range: 1.0000" - 1.3750" (25.40mm - 34.93mm)



HSS Inserts – Super Cobalt | Carbide Inserts – C1 (K35)

Series	Fractional Equivalent	Insert			Part No.	
		D <sub>1</sub> inch	D <sub>1</sub> mm	T <sub>1</sub>	Super Cobalt	C1 (K35)
2	1	1.0000	25.40	3/16		
	–	1.0236	26.00	3/16	<b>452H-0100-HE</b>	<b>4C12H-0100-HE</b>
	1-1/16	1.0625	26.99	3/16	<b>452H-26-HE</b>	<b>4C12H-26-HE</b>
	–	1.0630	27.00	3/16	<b>452H-0102-HE</b>	<b>4C12H-0102-HE</b>
	1-1/8	1.1250	28.58	3/16	<b>452H-27-HE</b>	<b>4C12H-27-HE</b>
2.5	1-3/16	1.1875	30.16	3/16	<b>452H-0104-HE</b>	<b>4C12H-0104-HE</b>
	–	1.2205	31.00	3/16	<b>452H-0106-HE</b>	<b>4C12H-0106-HE</b>
	1-1/4	1.2500	31.75	3/16	<b>452H-31-HE</b>	<b>4C12H-31-HE</b>
	–	1.2992	33.00	3/16	<b>452H-0108-HE</b>	<b>4C12H-0108-HE</b>
	1-5/16	1.3125	33.34	3/16	<b>452H-33-HE</b>	<b>4C12H-33-HE</b>
	1-3/8	1.3750	34.93	3/16	<b>452H-0110-HE</b>	<b>4C12H-0110-HE</b>
					<b>452H-0112-HE</b>	<b>4C12H-0112-HE</b>

Key on A91-1

A91: 40 - 41

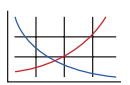

A91: 20



A91: 32 - 33



Inserts sold in multiples of 2

## T-A® Structural Steel Drill Insert Holders

2 Series | Taper Shank

A  
DRILLING

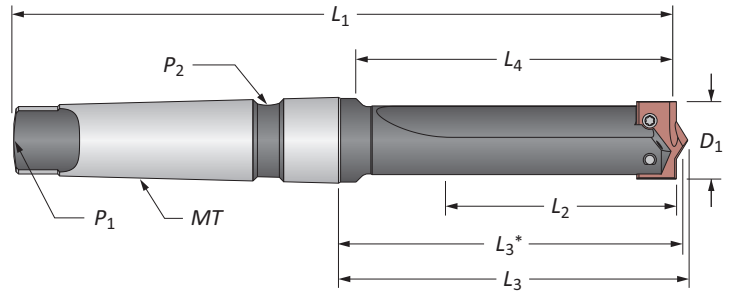

B  
BORING

### Straight Flute #4 Morse Taper

Series	Length	D <sub>1</sub>	Body					Shank			Part No.	
			L <sub>2</sub>	L <sub>4</sub>	L <sub>3</sub>	L <sub>3</sub> *	L <sub>1</sub>	MT	P <sub>1</sub>	P <sub>2</sub>		
i	2	Short	1 - 1-3/8	3-3/8	4-1/2	4-63/64	4-57/64	9-3/8	#4	TTC	TSC	22020S-004IS100
	2.5	Short	1-3/16 - 1-3/8	3-3/8	4-1/2	4-63/64	4-57/64	9-3/8	#4	TTC	TSC	22025S-004IS112
m	2	Short	26	86	114	126.6	124.2	238	#4	TTC	TSC	22020S-004IS100
	2.5	Short	31	86	114	126.6	124.2	238	#4	TTC	TSC	22025S-004IS112

\*If using Structural Steel holder with Notch Point®, GEN2 T-A, or 150° Structural Steel T-A drill insert geometry

C  
REAMING

D  
BURNISHING

E  
THREADING

### Connection Accessories

Series	Insert Screws	Nylon Locking Screws	Insert Driver	Preset Torque Hand Driver	Replacement Tips	Admissible Tightening Torque*
2	7495-IP15-1	7495N-IP15-1	8IP-15	8IP-15TL	8IP-15B	61.0 in-lbs (690 N-cm)
2.5	7495-IP15-1	7495N-IP15-1	8IP-15	8IP-15TL	8IP-15B	61.0 in-lbs (690 N-cm)

\*Tightening torques are calculated with a friction coefficient of  $\mu = 0.14$  and develop 90% of ultimate yield strength

X  
SPECIALS

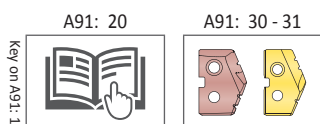

i = Imperial (in)  
m = Metric (mm)

Screws sold in multiples of 10





## T-A® Structural Steel Drill Insert Holders

2 Series | Taper Shank

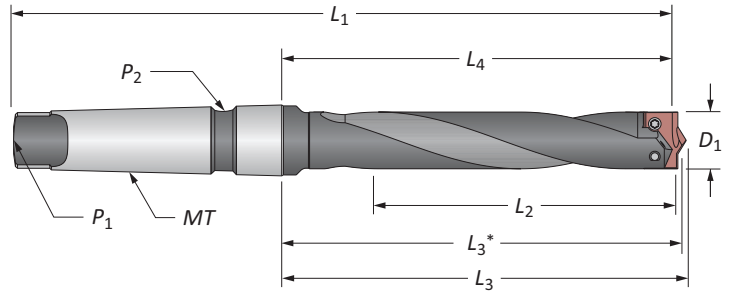

### Helical Flute #3 Morse Taper

Series	Length	D <sub>1</sub>	Body					Shank			Part No.
			L <sub>2</sub>	L <sub>4</sub>	L <sub>3</sub>	L <sub>3</sub> *	L <sub>1</sub>	MT	P <sub>1</sub>	P <sub>2</sub>	
<b>i</b> 2	Extended	1 - 1-3/8	6-1/2	9-11/32	9-3/4	9-29/64	13-7/32	#3	TTC	TSC	<b>⚠ 25020H-003IS100</b>
<b>m</b> 2	Extended	26	165	237	247.7	240.1	336	#3	TTC	TSC	<b>⚠ 25020H-003IS100</b>

\*If using Structural Steel holder with Notch Point®, GEN2 T-A, or 150° Structural Steel T-A drill insert geometry

### Helical Flute #4 Morse Taper

Series	Length	D <sub>1</sub>	Body					Shank			Part No.
			L <sub>2</sub>	L <sub>4</sub>	L <sub>3</sub>	L <sub>3</sub> *	L <sub>1</sub>	MT	P <sub>1</sub>	P <sub>2</sub>	
<b>i</b> 2	Standard	1 - 1-3/8	5-3/8	6-1/2	6-63/64	6-57/64	11-3/8	#4	TTC	TSC	24020H-004IS100
	Extended	1 - 1-3/8	6-1/2	9-7/32	9-3/4	9-43/64	14-5/32	#4	TTC	TSC	<b>⚠ 25020H-004IS100</b>
	Long	1 - 1-3/8	6-1/2	16	16-15/32	16-25/64	20-7/8	#4	TTC	TSC	<b>⚠ 26020H-004IS100</b>
<b>i</b> 2.5	Standard	1-3/16 - 1-3/8	5-3/8	6-1/2	6-63/64	6-57/64	11-3/8	#4	TTC	TSC	24025H-004IS112
<b>m</b> 2	Standard	26	137	165	177.4	175.0	289	#4	TTC	TSC	24020H-004IS100
	Extended	26	165	237	247.7	240.1	360	#4	TTC	TSC	<b>⚠ 25020H-004IS100</b>
	Long	26	165	406	418.3	416.3	530	#4	TTC	TSC	<b>⚠ 26020H-004IS100</b>
	Standard	31	137	165	177.4	175.0	289	#4	TTC	TSC	24025H-004IS112

\*If using Structural Steel holder with Notch Point®, GEN2 T-A, or 150° Structural Steel T-A drill insert geometry

**i** = Imperial (in)  
**m** = Metric (mm)

Screws sold in multiples of 10

**⚠ WARNING** Refer to Speed and Feed charts for recommended adjustments to speeds and feeds. Refer to page A91: 35 for deep hole drilling guidelines in this section of the catalog. Visit [www.alliedmachine.com/DeepHoleGuidelines](http://www.alliedmachine.com/DeepHoleGuidelines) for the most up-to-date information and procedures. Factory technical assistance is available for your specific applications through our Application Engineering Team.

A DRILLING  
 B BORING  
 C REAMING  
 D BURNISHING  
 E THREADING  
 X SPECIALS



## Original T-A® Structural Steel Drill Inserts

3 Series | Diameter Range: 1.4375" - 1.5625" (36.51mm - 39.69mm)



**Thin Wall**  
For material up to 7/16" thick

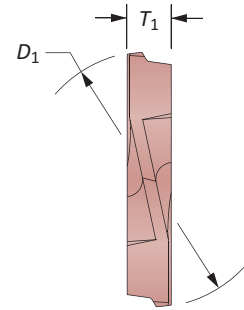
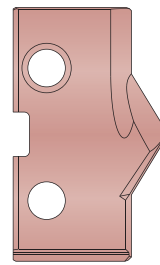



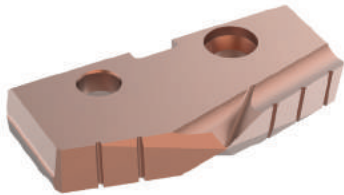
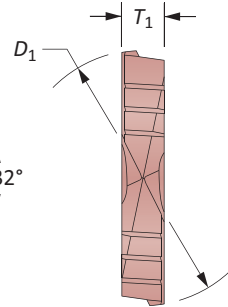
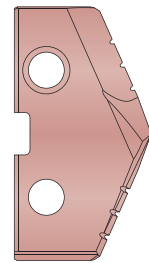

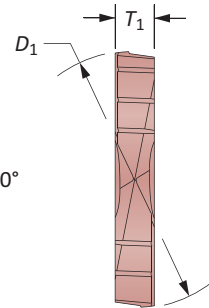
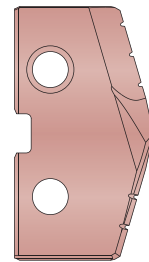

**Notch Point®**  
For material over 7/16" thick



**150° Structural Steel**  
For material over 7/16" thick  
and for reduced exit burr



### HSS Inserts – Super Cobalt

Insert				Thin Wall		Notch Point		150° Structural Steel	
Fractional Equivalent	D <sub>1</sub> inch	D <sub>1</sub> mm	T <sub>1</sub>						
				AM200 Part No.	TiAlN Part No.	AM200 Part No.	TiAlN Part No.	AM200 Part No.	TiAlN Part No.
1-7/16	1.4375	36.51	1/4	153H-0114-TW	153A-0114-TW	153H-0114-NP	153A-0114-NP	153H-0114-SS	153A-0114-SS
1-1/2	1.5000	38.10	1/4	153H-0116-TW	153A-0116-TW	153H-0116-NP	153A-0116-NP	153H-0116-SS	153A-0116-SS
-	1.5354	39.00	1/4	153H-39-TW	153A-39-TW	153H-39-NP	153A-39-NP	153H-39-SS	153A-39-SS
1-9/16	1.5625	39.69	1/4	153H-0118-TW	153A-0118-TW	153H-0118-NP	153A-0118-NP	153H-0118-SS	153A-0118-SS

A91: 40 - 41

A91: 20

A91: 36 - 37

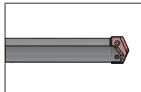
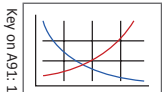

Inserts sold in multiples of 1



### GEN2 T-A® Structural Steel Drill Inserts

3 Series | Diameter Range: 1.4375" - 1.5625" (36.51mm - 39.69mm)

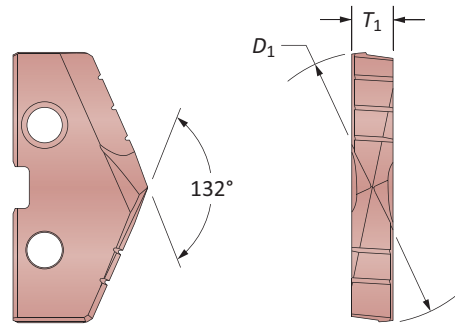
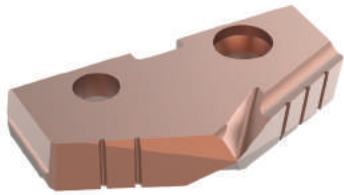

#### HSS Inserts – Super Cobalt

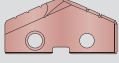
Fractional Equivalent	Insert			Part No.
	$D_1$ inch	$D_1$ mm	$T_1$	 Super Cobalt
1-7/16	1.4375	36.51	1/4	453H-0114-HE
1-1/2	1.5000	38.10	1/4	453H-0116-HE
-	1.5354	39.00	1/4	453H-39-HE
1-9/16	1.5625	39.69	1/4	453H-0118-HE

A

DRILLING

B

BORING

C

REAMING

D

BURNISHING

E

THREADING

X

SPECIALS

Key on A91-1

A91: 40 - 41

A91: 20

A91: 36 - 37

Inserts sold in multiples of 1



## T-A® Structural Steel Drill Insert Holders

3 Series | Taper Shank

DRILLING

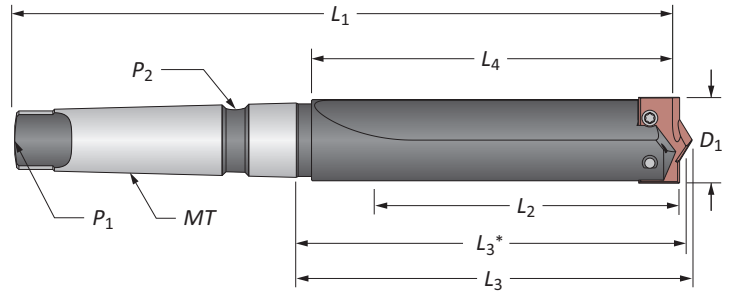

### Straight Flute #4 Morse Taper

Length	$D_1$	Body					Shank			Part No.
		$L_2$	$L_4$	$L_3$	$L_3^*$	$L_1$	MT	$P_1$	$P_2$	
① Short	1-13/32 - 1-7/8	4-3/4	6	6-1/2	6-7/16	10-7/8	#4	TTC	TSC	22030S-004IS126

\*If using Structural Steel holder with Notch Point®, GEN2 T-A, or 150° Structural Steel T-A drill insert geometry

BORING

REAMING

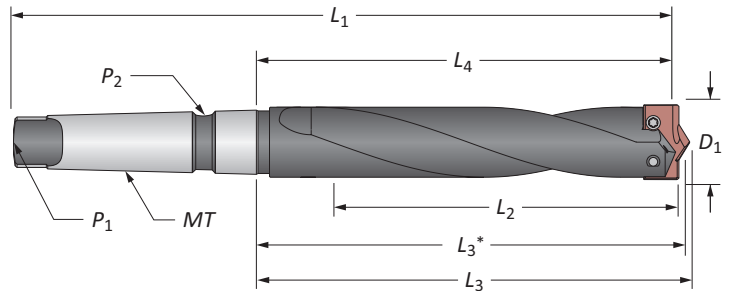

### Helical Flute #4 Morse Taper

Length	$D_1$	Body					Shank			Part No.
		$L_2$	$L_4$	$L_3$	$L_3^*$	$L_1$	MT	$P_1$	$P_2$	
① Standard	1-13/32 - 1-7/8	6-1/2	7-3/4	8-1/4	8-3/16	12-5/8	#4	TTC	TSC	24030H-004IS126

\*If using Structural Steel holder with Notch Point®, GEN2 T-A, or 150° Structural Steel T-A drill insert geometry

BURNISHING

THREADING

### Connection Accessories

Insert Screws	Nylon Locking Screws	Insert Driver	Preset Torque Hand Driver	Replacement Tips	Admissible Tightening Torque*
7514-IP20-1	7514N-IP20-1	8IP-20	-	-	121.3 in-lbs (1370 N-cm)

\*Tightening torques are calculated with a friction coefficient of  $\mu = 0.14$  and develop 90% of ultimate yield strength

SPECIALS

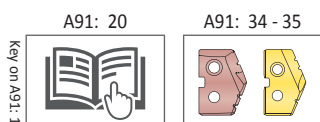





① = Imperial (in)  
 Ⓜ = Metric (mm)

Screws sold in multiples of 10

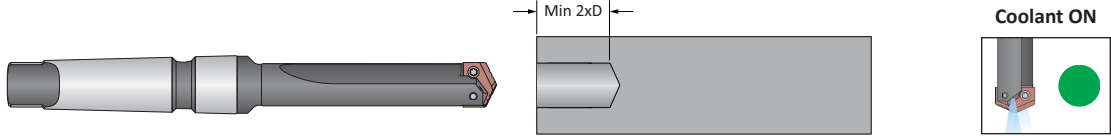
## Deep Hole Drilling Guidelines

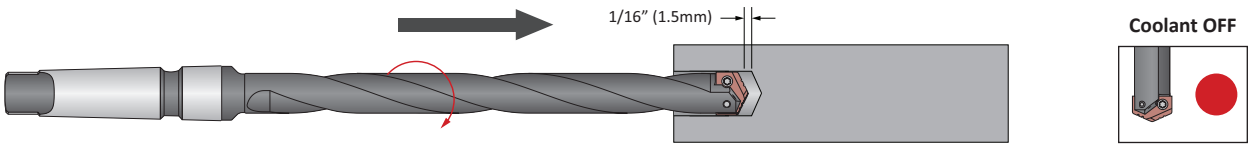
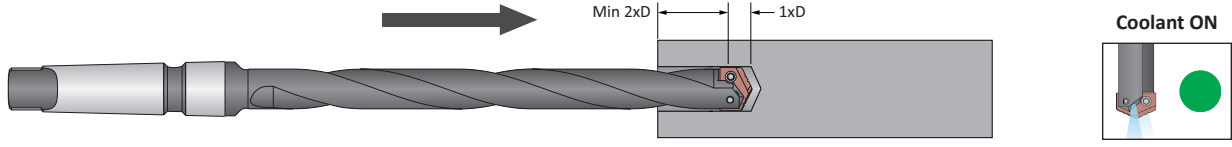
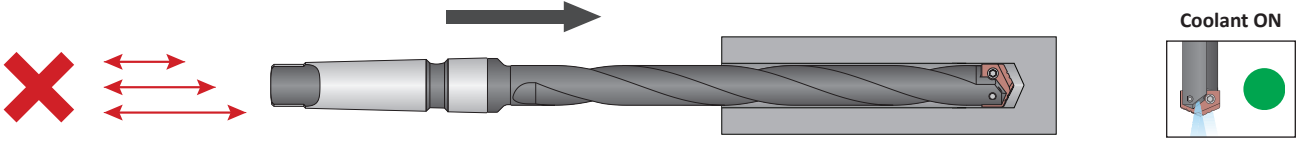
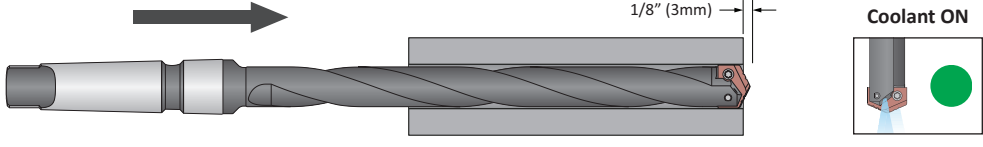
For Use with Drills Greater than 9xD (Extended, Long, XL, 3XL, and Special Length)

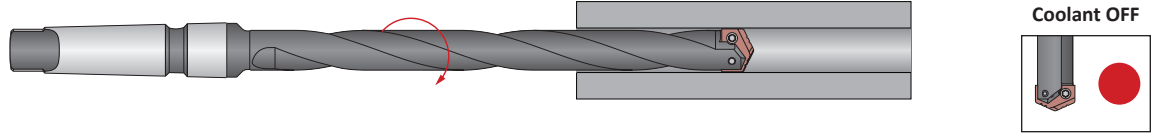
<p><b>1. Pilot Hole</b> 100 % RPM 100% IPR (mm/rev)</p>	<p>Establish the pilot hole using the same diameter short drill to a depth of 2xD minimum. Utilize a pilot drill with the same or larger included point angle.</p>	
<p> <b>2. Feed-in</b> 50 RPM max 12 IPM (300 mm/min)</p>	<p>Feed the longer drill within 1/16" (1.5mm) short of the established pilot hole bottom at a <b>maximum of 50 RPM</b> and 12 IPM (300 mm/min) feed rate.</p>	
<p><b>3. Deep Hole Transition Drilling</b> 50 % RPM 75% IPR (mm/rev)</p>	<p>Drill additional 1xD past the bottom of the pilot hole at 50% reduction of recommended speed and 25% reduction of recommended feed. Minimum of 1 second dwell is required to meet full speed before feeding.</p>	
<p><b>4. Deep Hole Drilling - Blind</b> 100% RPM 100% IPR (mm/rev)</p>	<p>Drill to full depth at recommended speed and feed for longer drill according to Allied speed and feed charts. <b>No peck cycle recommended.</b></p>	
<p><b>5. Deep Hole Drilling - at Breakout</b> 50% RPM 75% IPR (mm/rev)</p>	<p><b>For through holes only:</b> Reduce speed by 50% and feed by 25% prior to breakout. Do not break out more than 1/8" (3mm) past the full diameter of the drill.</p>	
<p> <b>6. Drill Retract</b> 50 RPM max</p>	<p>Reduce speed to a <b>maximum of 50 RPM</b> before retracting from the hole.</p>	

**⚠ WARNING** Tool failure can cause serious injury. To prevent:

- When using holders without support bushing, use a short T-A® holder to establish an initial hole that is a minimum of 2 diameters deep.
- Do not rotate tool holders more than 50 RPM unless it is engaged with the workpiece or fixture.

Visit [www.alliedmachine.com/DeepHoleGuidelines](http://www.alliedmachine.com/DeepHoleGuidelines) for the most up-to-date information and procedures. Factory technical assistance is available for your specific applications through our Application Engineering Team.

## Recommended Cutting Data

GEN3SYS® XT Pro (XTST)

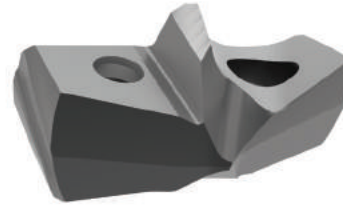

### Imperial (inch)

ISO	Material	Speed (SFM) - Mist Coolant		Feed Rate (IPR) by Diameter			
		Hardness (BHN)	AM420 Speed	12 series 0.4724 - 0.5117	13 series 0.5118 - 0.5511	14 series 0.5512 - 0.5905	15 series 0.5906 - 0.6298
P	Structural Steel A36, A285, A516, A572, etc.	100 - 150	350	0.008	0.009	0.010	0.010
		150 - 250	300	0.007	0.008	0.009	0.009
		250 - 350	260	0.006	0.007	0.008	0.008

### Metric (mm)

ISO	Material	Speed (M/mm) - Mist Coolant		Feed Rate (mm/rev) by Diameter			
		Hardness (BHN)	AM420 Speed	12 series 12.00 - 12.99	13 series 13.00 - 13.99	14 series 14.00 - 14.99	15 series 15.00 - 15.99
P	Structural Steel A36, A285, A516, A572, etc.	100 - 150	107	0.20	0.22	0.25	0.25
		150 - 250	91	0.18	0.20	0.23	0.23
		250 - 350	79	0.15	0.17	0.20	0.20

### Speed and Feed Multiplier

	Depth of Cut	
	<= 1.5xD	> 1.5xD
Speed	See above chart	0.75
Feed	See above chart	0.90

**NOTE:** The speeds and feeds listed above are based on a rigid setup using air mist through tool coolant. Speed may be increased up to 50% if using high pressure flood or through coolant.

**NOTE:** If drilling dry without coolant, speed must be reduced significantly based on setup, drill depth, and material hardness. Up to 50% speed and feed reduction may be necessary in these types of applications. Contact the Application Engineering department for assistance.

**NOTE:** If drilling material thickness of 0.500" (12.7mm) or less, a minimum of 10% reduction in feed is required to minimize material deflection.

A

DRILLING

B

BORING

C

REAMING

D

BURNISHING

F

THREADING

X

SPECIALS

**Feed Rate (IPR) by Diameter**

16 series 0.6299 - 0.6692	17 series 0.6693 - 0.7086	18 series 0.7087 - 0.7873	20 series 0.7874 - 0.8660	22 series 0.8661 - 0.9448	24 series 0.9449 - 1.0235	26 series 1.0236 - 1.1416	29 series 1.1417 - 1.2597	32 series 1.2598 - 1.3780
0.012	0.012	0.014	0.015	0.016	0.017	0.018	0.019	0.019
0.010	0.010	0.012	0.014	0.015	0.016	0.017	0.018	0.018
0.009	0.009	0.011	0.012	0.013	0.014	0.015	0.016	0.016

**Feed Rate (mm/rev) by Diameter**

16 series 16.00 - 16.99	17 series 17.00 - 17.99	18 series 18.00 - 19.99	20 series 20.00 - 21.99	22 series 22.00 - 23.99	24 series 24.00 - 25.99	26 series 26.00 - 28.99	29 series 29.00 - 31.99	32 series 32.00 - 35.00
0.30	0.30	0.36	0.38	0.41	0.43	0.46	0.48	0.48
0.25	0.25	0.30	0.36	0.38	0.41	0.43	0.46	0.46
0.23	0.23	0.28	0.30	0.33	0.36	0.38	0.41	0.41

## Recommended Cutting Data | Imperial (inch)

Original T-A® | GEN2 T-A®

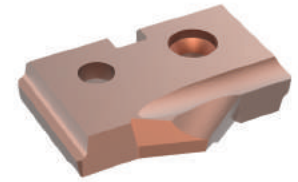

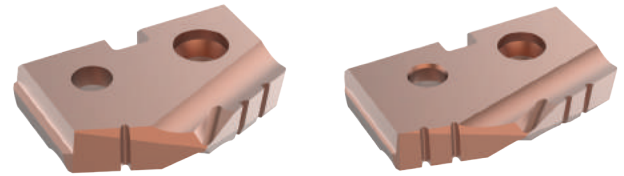

### Thin Wall Inserts Super Cobalt

ISO	Material	Speed (SFM) - Mist Coolant		Feed Rate (IPR) by Diameter				
		Hardness (BHN)	 AM200 Speed	 TiAlN Speed	0 series 9/16 - 11/16	1 series 13/16 - 15/16	2 series 1 - 1-3/8	3 series 1-13/32 - 1-7/8
P	Structural Steel A36, A285, A516, etc.	100 - 150	125	110	0.012	0.018	0.019	0.020
		150 - 250	115	100	0.011	0.016	0.017	0.019
		250 - 350	105	90	0.010	0.014	0.016	0.018



### Notch Point® and 150° Structural Steel Inserts Super Cobalt

ISO	Material	Speed (SFM) - Mist Coolant		Feed Rate (IPR) by Diameter				
		Hardness (BHN)	 AM200 Speed	 TiAlN Speed	0 series 9/16 - 11/16	1 series 13/16 - 15/16	2 series 1 - 1-3/8	3 series 1-13/32 - 1-7/8
P	Structural Steel A36, A285, A516, etc.	100 - 150	125	110	0.010	0.012	0.014	0.018
		150 - 250	115	100	0.009	0.011	0.012	0.016
		250 - 350	105	90	0.008	0.010	0.011	0.014



### GEN2 T-A Inserts Super Cobalt

ISO	Material	Speed (SFM) - Mist Coolant		Feed Rate (IPR) by Diameter			
		Hardness (BHN)	 AM200 Speed	0 series 9/16 - 11/16	1 series 13/16 - 15/16	2 series 1 - 1-3/8	3 series 1-13/32 - 1-7/8
P	Structural Steel A36, A285, A516, etc.	100 - 150	125	0.010	0.012	0.014	0.018
		150 - 250	115	0.009	0.011	0.012	0.016
		250 - 350	105	0.008	0.010	0.011	0.014

### GEN2 T-A Inserts Carbide C1 (K35)

ISO	Material	Speed (SFM) - Mist Coolant		Feed Rate (IPR) by Diameter			
		Hardness (BHN)	 AM200 Speed	0 series 9/16 - 11/16	1 series 13/16 - 15/16	2 series 1 - 1-3/8	3 series 1-13/32 - 1-7/8
P	Structural Steel A36, A285, A516, etc.	100 - 150	165	0.008	0.011	0.015	0.017
		150 - 250	155	0.006	0.010	0.013	0.015
		250 - 350	140	0.005	0.009	0.012	0.013

**NOTE:** The speeds and feeds listed above are based on a rigid setup using air mist through tool coolant. Speed may be increased up to 50% if using high pressure flood or through coolant.  
**NOTE:** If drilling dry without coolant, speed must be reduced significantly based on setup, drill depth, and material hardness. Up to 50% speed and feed reduction may be necessary in these types of applications. Contact the Application Engineering department for assistance.



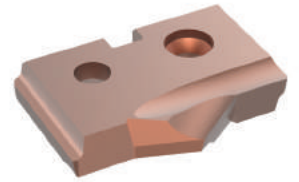

## Recommended Cutting Data | Metric (mm)

Original T-A® | GEN2 T-A®



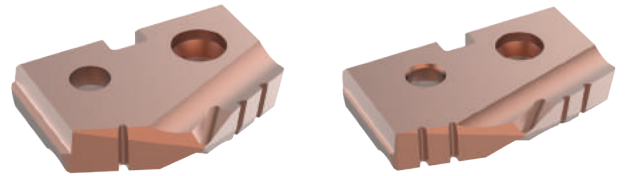

### Thin Wall Inserts Super Cobalt

ISO	Material	Speed (M/mm) - Mist Coolant		Feed Rate (mm/rev) by Diameter				
		Hardness (BHN)	 AM200 Speed	 TiAlN Speed	0 series 14 - 16	1 series 18 - 24	2 series 25 - 35	3 series 36 - 47
P	Structural Steel A36, A285, A516, etc.	100 - 150	39	34	0.30	0.45	0.48	0.50
		150 - 250	35	31	0.28	0.40	0.43	0.48
		250 - 350	32	28	0.25	0.36	0.40	0.45



### Notch Point® and 150° Structural Steel Inserts Super Cobalt

ISO	Material	Speed (M/mm) - Mist Coolant		Feed Rate (mm/rev) by Diameter				
		Hardness (BHN)	 AM200 Speed	 TiAlN Speed	0 series 14 - 16	1 series 18 - 24	2 series 25 - 35	3 series 36 - 47
P	Structural Steel A36, A285, A516, etc.	100 - 150	39	34	0.25	0.30	0.36	0.45
		150 - 250	35	31	0.23	0.28	0.30	0.40
		250 - 350	35	28	0.20	0.25	0.28	0.36



### GEN2 T-A Inserts Super Cobalt

ISO	Material	Speed (M/mm) - Mist Coolant		Feed Rate (mm/rev) by Diameter			
		Hardness (BHN)	 AM200 Speed	0 series 14 - 16	1 series 18 - 24	2 series 25 - 35	3 series 36 - 47
P	Structural Steel A36, A285, A516, etc.	100 - 150	39	0.25	0.30	0.36	0.46
		150 - 250	35	0.23	0.28	0.30	0.40
		250 - 350	35	0.20	0.25	0.28	0.36

### GEN2 T-A Inserts Carbide C1 (K35)

ISO	Material	Speed (M/mm) - Mist Coolant		Feed Rate (mm/rev) by Diameter			
		Hardness (BHN)	 AM200 Speed	0 series 14 - 16	1 series 18 - 24	2 series 25 - 35	3 series 36 - 47
P	Structural Steel A36, A285, A516, etc.	100 - 150	50	0.20	0.28	0.38	0.43
		150 - 250	47	0.15	0.25	0.33	0.38
		250 - 350	43	0.13	0.23	0.30	0.33

**NOTE:** The speeds and feeds listed above are based on a rigid setup using air mist through tool coolant. Speed may be increased up to 50% if using high pressure flood or through coolant.  
**NOTE:** If drilling dry without coolant, speed must be reduced significantly based on setup, drill depth, and material hardness. Up to 50% speed and feed reduction may be necessary in these types of applications. Contact the Application Engineering department for assistance.









# Guaranteed Test / Demo Application Form

Distributor PO #	
------------------	--

The following must be filled out completely before your test will be considered

## Distributor Information

Company Name: \_\_\_\_\_  
 Contact: \_\_\_\_\_  
 Account Number: \_\_\_\_\_  
 Phone: \_\_\_\_\_  
 Email: \_\_\_\_\_

## End User Information

Company Name: \_\_\_\_\_  
 Contact: \_\_\_\_\_  
 Industry: \_\_\_\_\_  
 Phone: \_\_\_\_\_  
 Email: \_\_\_\_\_

**Current Process** List all tooling, coatings, substrates, speeds and feeds, tool life, and any problems you are experiencing

---



---

**Test Objective** List what would make this a successful test (i.e. penetration rate, finish, tool life, hole size, etc.)

---



---

## Application Information

Hole Diameter: _____ in/mm	Tolerance: _____	Material: _____ (4150 / A36 / Cast Iron / etc.)
Pre-existing Diameter: _____ in/mm	Depth of Cut: _____ in/mm	Hardness: _____ (BHN / Rc)
Required Finish: _____ RMS	State: _____	(Casting / Hot rolled / Forging)

## Machine Information

Machine Type: _____ (Lathe / Screw machine / Machine center / etc.)	Builder: _____ (Haas, Mori Seiki, etc.)	Model #: _____
Shank Required: _____ (CAT50 / Morse taper, etc.)		Power: _____ HP/KW
Rigidity: _____	Orientation: _____	Tool Rotating: _____
<input type="checkbox"/> Excellent	<input type="checkbox"/> Vertical	<input type="checkbox"/> Yes
<input type="checkbox"/> Good	<input type="checkbox"/> Horizontal	<input type="checkbox"/> No
<input type="checkbox"/> Poor		Thrust: _____ lbs/N

## Coolant Information

Coolant Delivery: _____ (Through tool / Flood)	Coolant Pressure: _____ PSI / bar
Coolant Type: _____ (Air mist, oil, synthetic, water soluble, etc.)	Coolant Volume: _____ GPM / LPM

## Requested Tooling

QTY	Item Number	QTY	Item Number



**ALLIED MACHINE & ENGINEERING**  
 Allied Machine & Engineering  
 120 Deeds Drive  
 Dover, OH 44622

Telephone: (330) 343-4283  
 Toll Free USA & Canada: (800) 321-5537  
 Fax: (330) 602-3400

## Warranty Information



Allied Machine & Engineering warrants to original equipment manufacturers, distributors, industrial and commercial users of its products that each new product manufactured or supplied by Allied Machine shall be free from defects in material and workmanship.

Allied Machine's obligation under this warranty is limited to furnishing without additional charge a replacement or, at its option repairing or issuing credit for any product which shall within one year from the date of sale be returned freight prepaid to the plant designated by an Allied Machine representative and which upon inspection is determined by Allied Machine to be defective in materials or workmanship.

Complete information as to operating conditions, machine, set-up, and application of cutting fluid should accompany any product returned for inspection. The provisions of this warranty shall not apply to any Allied Machine products which have been subjected to misuse, improper operating conditions, machine set-up or application of cutting fluid or which have been repaired or altered if such repair or alteration in the judgment of Allied Machine would adversely affect performance of the product.

THIS WARRANTY IS IN LIEU OF ALL OTHER WARRANTIES, EXPRESS OR IMPLIED, INCLUDING ANY IMPLIED WARRANTY OF MERCHANTABILITY OR FITNESS FOR A PARTICULAR PURPOSE. Allied Machine shall have no liability or responsibility on any claim of any kind, whether in contract, tort or otherwise, for any loss or damage arising out of, connected with, or resulting from the manufacture, sale, delivery or use of any product sold hereunder, in excess of the cost of replacement or repair as provided herein.

ALL PRICES, DELIVERIES, DESIGNS, AND MATERIALS ARE SUBJECT TO CHANGE WITHOUT NOTICE.



Allied Machine & Engineering  
Registered to ISO 9001  
10001329

## United States

### Allied Machine & Engineering

120 Deeds Drive  
Dover OH 44622  
United States

**Phone:**  
+1.330.343.4283

**Fax:**  
+1.330.602.3400

**Toll Free USA and Canada:**  
800.321.5537

**Toll Free USA and Canada:**  
800.223.5140

### Allied Machine & Engineering

485 W Third Street  
Dover OH 44622  
United States

**Phone:**  
+1.330.343.4283

**Fax:**  
+1.330.364.7666  
(Engineering Dept.)

**Toll Free USA and Canada:**  
800.321.5537

## Europe

### Allied Machine & Engineering Co. (Europe) Ltd.

93 Vantage Point  
Pensnett Estate  
Kingswinford  
West Midlands  
DY6 7FR England

**Phone:**  
+44 (0) 1384.400900

### Wohlhaupter GmbH

Maybachstrasse 4  
Postfach 1264  
72636 Frickenhausen  
Germany

**Phone:**  
+49 (0) 7022.408.0

**Fax:**  
+49 (0) 7022.408.212

## Asia

### Wohlhaupter India Pvt. Ltd.

B-23, 2nd Floor  
B Block Community Centre  
Janakpuri, New Delhi - 110058  
India

**Phone:**  
+91 (0) 11.41827044

Your local Allied Machine representative:

[www.alliedmachine.com](http://www.alliedmachine.com)

Allied Machine & Engineering is registered by DQS to ISO 9001 10001329



© 2018 Allied Machine & Engineering  
Available Online Only: A91-SSD  
Publish Date: June 2018