

## PRE-PRINTED WIRE MARKER PARTS

Pre-Printed Wire Marker	
Materials Chart	174
Wire Marker Cards	175 – 180
Porta Pack Books	187
ClipSleeve Wire Markers	182
Ademark Inserts	183 – 187
Catena Rings	187 – 189

# Pre-Printed Wire Markers Materials Chart

Brady's exclusive ZipStrip® release card lets you easily remove the markers you need, when you need them.



Max. Service Type	Temp. °C	Color	Finish	Use	Special Properties
<b>Acetate Cloth</b>					
B-12	105	White	Matt	Wire marker for varnish dip or baking cycles	Oil and heat resistant
<b>Aluminum Foil</b>					
B-184	130	Silver	Matt	Permanent debossed marking	Heat, oil, solvent and abrasion resistant
<b>Overlaminated Tedlar®</b>					
B-605	127	White	Gloss	Machine tools; hostile environments	Heat, oil, solvent and abrasion resistant
<b>Polyester</b>					
B-11	130	White	Gloss	Roll-form wire marking; hostile environments	Heat, oil and solvent resistant
<b>Polyolefin</b>					
B-319	105	White	Matt	Computer printable sleeve markers	Permanent; not heat shrinkable
B-321	105	White/Yellow	Matt	Computer printable sleeve markers	Permanent; heat shrinkable
<b>Vinyl</b>					
B-292	66	White	Matt	Machine tool, flat ribbon, and wire marking	Conformable, durable; oil, water and mild solvent resistant
B-702	105	White	Gloss	Vinyl coated; machine tool labeling	Oil and mild solvent resistant; high adhesion
B-708	66	White	Gloss	Indoor/outdoor cable marking	Conformable, durable; oil, water and mild solvent resistant; self laminating
<b>Vinyl Cloth</b>					
B-500	82	White/Yellow	Matt	All-purpose marker	Moderate heat, oil and dirt resistance; high adhesion

Tedlar® is a registered trademark of DuPont.

# Wire Marker Cards

## Solid Numbers, Self-Laminating Solid Numbers, Higher Numbers

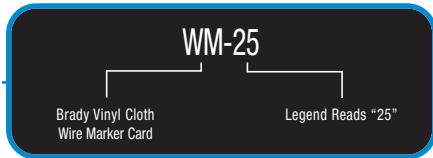
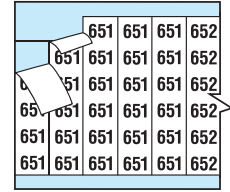
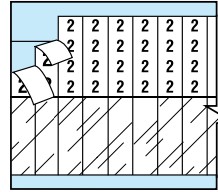
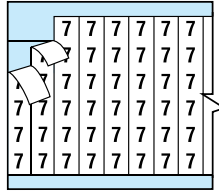

### Reference Explanation:

Most Brady references in this section follow the same two-part format:

The first code indicates the Brady product being referenced, the second code indicates the marker legend.

Legend	B-500	B-702	B-184	B-12	B-292	Markers per Card	
	Vinyl Cloth	Vinyl Film	Aluminum Foil	Acetate Cloth	Self-Laminating Vinyl <sup>1</sup>	38 mm <sup>1</sup>	19 mm <sup>1</sup>
0	WM-0	TWM-0	AF-0	HH-0	SLF-0	36	72
1	WM-1	TWM-1	AF-1	HH-1	SLF-1	36	72
2	WM-2	TWM-2	AF-2	HH-2	SLF-2	36	72
and so on through	and so on through	and so on through	and so on through	and so on through	SLF-3		
11	WM-11	TWM-11		HH-9		36	72
12	WM-12					36	72
25	WM-25		AF-25			36	72
26	WM-26		AF-26			36	72
and so on through	and so on through		and so on through			36/card until "100", "100" and so on through to "125" is 25/card	72
125	WM-125		AF-50			25	50

<sup>1</sup>19 mm for cable diameter: 4 - 6,5 mm/38 mm for cable diameter < 12 mm

## Solid Letters – Upper Case

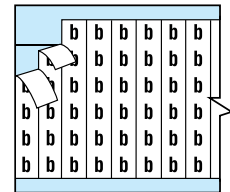
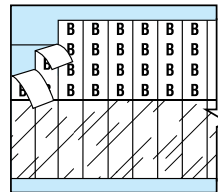
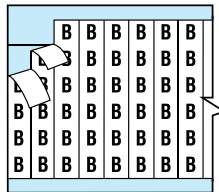

Legend	B-500	B-702	B-184	B-12	Markers per Card	
	Vinyl Cloth	Vinyl Film	Aluminum Foil	Acetate Cloth	38 mm	19 mm
A	WM-A	TWM-A	AF-A	HH-A	36	72
B	WM-B	TWM-B	AF-B	HH-B	36	72
C	WM-C	TWM-C	AF-C	HH-C	36	72
and so on through	and so on through	and so on through	and so on through	and so on through		
Z	WM-Z	TWM-Z	AF-Z	HH-Z	36	72

# Wire Marker Cards

## Solid Numbers on Coloured Background

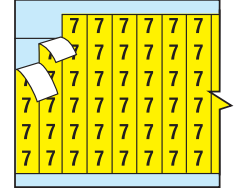

## Vinyl Cloth (B-500)

Legend	Background Colours:				Markers per Card	
	Red	Yellow	Blue	Green	38 mm	19 mm
0	WM-0-RD	WM-0-YL	WM-0-BL	WM-0-GR	36	72
1	WM-1-RD	WM-1-YL	WM-1-BL	WM-1-GR	36	72
2	WM-2-RD	WM-2-YL	WM-2-BL	WM-2-GR	36	72
3		WM-3-YL	WM-3-BL	WM-3-GR	36	72
4		WM-4-YL		WM-4-GR	36	72
5	WM-5-RD	WM-5-YL		WM-5-GR	36	72
through						
9		WM-9-YL			36	72
16		WM-16-YL			36	72
19		WM-19-YL			36	72
24		WM-24-YL			36	72
through						
30		WM-30-YL			36	72

## Consecutive Numbers, Self-Laminating Consecutive Numbers

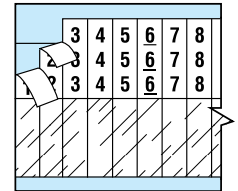
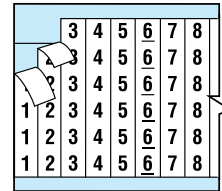

Legend	B-500	B-702	B-605	B-184	B-12	B-292	Quantity Each		Markers per Card	
	Vinyl Cloth	Vinyl Film	Over-Laminated	Aluminum Foil	Acetate Cloth	Self-Laminating Vinyl*	38 mm	19 mm	38 mm	19 mm
1-33	WM-1-33	TWM-1-33	OLWM-1-33	AF-1-33	HH-1-33	SLF-1-33	1	2	33	66
34-66	WM-34-66	TWM-34-66		AF-34-66	HH-34-66		1	2	33	66
67-99	WM-67-99	TWM-67-99		AF-67-99			1	2	33	66
100-124	WM-100-124			AF-100-124			1	2	25	50
125-149	WM-125-149			AF-125-149			1	2	25	50
through	through			through						
	WM-975-999			AF-200-224			1	2	25	50

\*38 mm length only

## Consecutive Letters

Legend	B-500	Markers per Card	
	Vinyl Cloth	38 mm	19 mm
A-Z	WM-A-Z	26	52
A-Z plus A-J	WM-A-Z, AJ	36	72

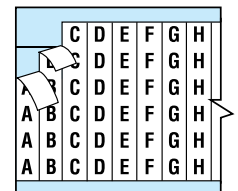

# Wire Marker Cards

## Consecutive Numbers on Coloured Background (Vinyl Cloth B-500)

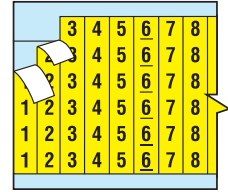

Legend	Background Colours:							Qty. Each Markers			
	Red	Yellow	Orange	Blue	Green	Brown	Black	No. per Card	per Card		
								38 mm	19 mm	38 mm	19 mm
1-33	WM-1-33RD	WM-1-33YL	WM-1-33OR	WM-1-33BL	WM-1-33GR	WM-1-33BR	WM-1-33BK	1	2	33	66
34-66	WM-34-66RD	WM-34-66YL	WM-34-66OR	WM-34-66BL	WM-34-66GR	WM-34-66BR	WM-34-66BK	1	2	33	66
67-99	WM-67-99RD	WM-67-99YL	WM-67-99OR	WM-67-99BL	WM-67-99GR	WM-67-99BR	WM-67-99BK	1	2	33	66
100-124	WM-100-124RD	WM-100-124YL					WM-100-124BK	1	2	25	50

Note: White legend on red, green, brown and black backgrounds. All other colours have black legends.

## Consecutive Letters On Coloured Background (Vinyl Cloth B-500)

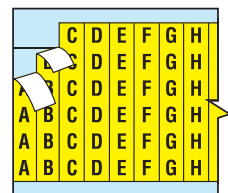

Legend	Background Colour	Reference	Quantity Each		Markers per Card	
			Letter per Card		38 mm	19 mm
A-Z	YELLOW	WM-A-Z-YL	1	2	26	52

## Consecutive Numbers Repeated, Consecutive Letters Repeated

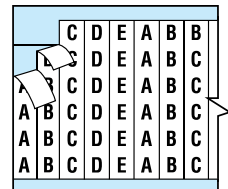
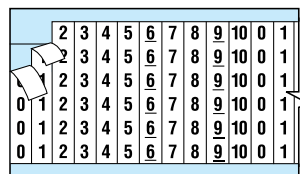

Legend	B-500 Vinyl Cloth	B-702 Vinyl Film	B-605 Over-Laminated	B-184 Aluminum Foil	Sequences per Card		Markers per Card	
					38 mm	19 mm	38 mm	19 mm
1-3	WM-1-3				12	24	36	72
1-4	WM-1-4				9	18	36	72
1-5	WM-1-5				7	14	35	70
1-6	WM-1-6				6	12	36	72
1-8	WM-1-8				4	8	32	64
1-9	WM-1-9				4	8	36	72
0-9	WM-0-9				3	6	30	60
0-10	WM-0-10				3	6	33	66
1-10	WM-1-10		OLWM-1-10		3	6	30	60
1-12	WM-1-12	TWM-1-12			3	6	36	72
1-16	WM-1-16				2	4	32	64
1-18	WM-1-18			AF-1-18	2	4	36	64
19-36	WM-19-36				2	4	36	72

# Wire Marker Cards

## Consecutive Paired Numbers

Use to mark both ends of wire with the same legend, fast and easy from the same dispenser card.

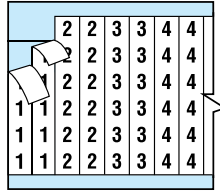

## Self-Laminating Write-On Wire Markers

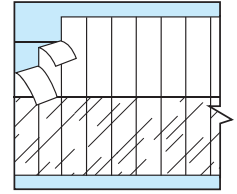

## Vinyl Cloth (B-500)

Legend	Order Reference	Pairs of Markers Per Card		Markers Per Card	
		38 mm	19 mm	38 mm	19 mm
1-16	WM-1-16-DC	16	32	32	64
17-32	WM-17-32-DC	16	32	32	64

## Vinyl (B-292)

Order Reference	Write-on Area (Width x Height)	Markers per Card
<b>38 mm Long</b>		
SLFW-250	6.35 mm x 19.05 mm	36
SLFW-344	8.74 mm x 19.05 mm	26
SLFW-500	12.70 mm x 19.05 mm	18
SLFW-750	19.05 mm x 19.05 mm	12
<b>19 mm Long</b>		
SLHW-250	6.35 mm x 9.53 mm	72
SLHW-500	12.54 mm x 9.53 mm	36

## Solid NEMA Colours

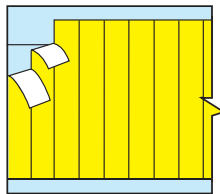

Background Colour	B-500 Vinyl Cloth	B-702 Vinyl Film	Markers Per Card	
			38 mm	19 mm
RED	WM-COL-RD	TWM-COL-RD	36	72
YELLOW	WM-COL-YL	TWM-COL-YL	36	72
LIGHT BLUE	WM-COL-LB	TWM-COL-LB	36	72
DARK BLUE	WM-COL-DB	TWM-COL-DB	36	72
LIGHT GREEN	WM-COL-LG	TWM-COL-LG	36	72
DARK GREEN	WM-COL-DG	TWM-COL-DG	36	72
WHITE	WM-COL-WT	TWM-COL-WT	36	72
BLACK	WM-COL-BK	TWM-COL-BK	36	72
TAN	WM-COL-TN	TWM-COL-TN	36	72
BROWN	WM-COL-BR	TWM-COL-BR	36	72
ORANGE	WM-COL-OR	TWM-COL-OR	36	72
PINK	WM-COL-PK	TWM-COL-PK	36	72
GREY	WM-COL-GY	TWM-COL-GY	36	72
MAROON	WM-COL-MR	TWM-COL-MR	36	72
OLIVE	WM-COL-OL	TWM-COL-OL	36	72
PURPLE	WM-COL-PL	TWM-COL-PL	36	72

## Suffix Numbers

Use to extend numbering codes or to make up other combinations of numbers or alpha-numeric codes. For example, adding suffix number 07 to 999 produces 99907.

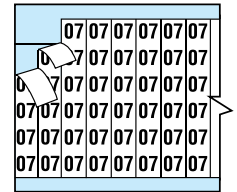

## Vinyl Cloth (B-500)

Legend	Order Reference	Markers Per Card	
		38 mm	19 mm
01	WM-01-S	36	72
and so on through			
09	WM-09-S	36	72
00 through to 09			
WM-00-09-S		30	60

**Note:** Reference WM-00-09-S is a card of markers in 00 to 09 sequence with three sequences on a card.

## Solid Letters and Numbers - Conduit Markers

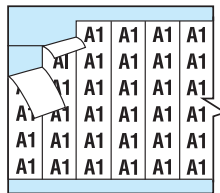

Legend	B-500 Vinyl Cloth	Markers Per Card	
		38 mm	19 mm
A1	WM-A1	36	72
A2	WM-A2	36	72
A3	WM-A3	36	72
L1	WM-L1	36	72
L2	WM-L2	36	72
L3	WM-L3	36	72
T1	WM-T1	36	72
T2	WM-T2	36	72

## Terminal Markers

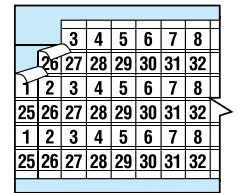

## Vinyl Cloth (B-500)

Legend	Order Reference	Marker Size (mm)	Markers per Card
1 through to 48	WM-1-48-TM	8.00 x 5.00	144
49 through to 96	WM-49-96-TM	8.00 x 5.00	144
A through to Z	WM-A-Z-TM	8.00 x 5.00	156

Terminal Markers have no "I" or "O".



## Solid Symbols – Miscellaneous

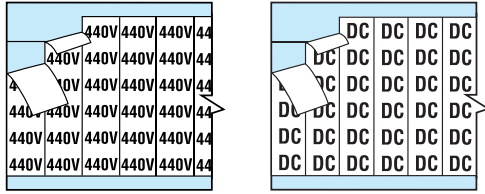

Legend	B-500	B-702	Markers Per Card	
	Vinyl Cloth	Vinyl Film	38 mm	19 mm
24V	WM-24V		25	50
+	WM-PLS	TWM-PLS	36	72
-	WM-MIN	TWM-MIN	36	72
AC	WM-AC		36	72
DC	WM-DC		36	72
⊥	WM-GRS		36	72

## Solid Numbers

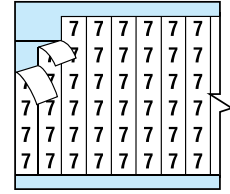

### Vinyl (B-708)

Legend	Order Reference	Markers Per Card
0	CAB-0	18
1	CAB-1	18
2	CAB-2	18
3	CAB-3	18
4	CAB-4	18
5	CAB-5	18
6	CAB-6	18
7	CAB-7	18
8	CAB-8	18
9	CAB-9	18

## Cable Markers

Standard 101.6 mm x 228.6 mm cards provide markers for cables, multi-wire circuits, even conductors and tubing in hydraulic systems. Markers may be slit for smaller diameter cable. Markers are 89 mm long; to order half markers, write 44 mm after reference.

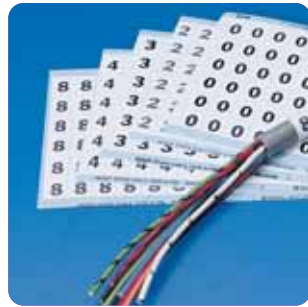

## Consecutive Numbers or Letters

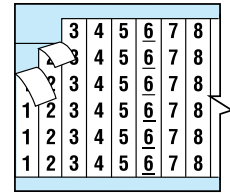

### Vinyl (B-708)

Legend	Order Reference	Markers Per Card
01 through 09	CAB-01-09*	18
1 through 9	CAB-1-9*	18

\*Two sets of legends per card.

## Solid Letters

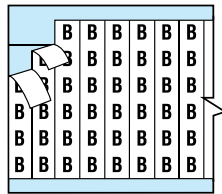

### Vinyl (B-708)

Legend	Order Reference	Markers Per Card
A	CAB-A	18
B	CAB-B	18
C	CAB-C	18
D	CAB-D	18
E	CAB-E	18
F	CAB-F	18
N	CAB-N	18

# Wire Marker Cards

## Miniature Wire Markers

**Solid Numbers, Solid letters**

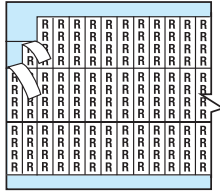
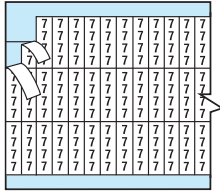

### Vinyl Film (B-702)

Legend	Order Reference	Markers Per Card 12.70 mm
0	TMM-0	150
1	TMM-1	150
2	TMM-2	150
3	TMM-3	150
and so on through	and so on through	
40	TMM-40	150
A	TMM-A	150
B	TMM-B	150
C	TMM-C	150
and so on through	and so on through	
Z	TMM-Z	150

### Solid Nema Colours

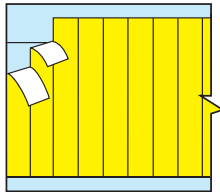

### Vinyl Film (B-702)

Background Colour	Order Reference	Markers Per Card 12.70 mm
RED	TMM-COL-RD	108
YELLOW	TMM-COL-YL	108
LIGHT BLUE	TMM-COL-LB	108
DARK BLUE	TMM-COL-DB	108
LIGHT GREEN	TMM-COL-LG	108
DARK GREEN	TMM-COL-DG	108
WHITE	TMM-COL-WT	108
BLACK	TMM-COL-BK	108
TAN	TMM-COL-TN	108
BROWN	TMM-COL-BR	108
ORANGE	TMM-COL-OR	108
PINK	TMM-COL-PK	108
GREY	TMM-COL-GY	108
MAROON	TMM-COL-MR	108
OLIVE	TMM-COL-OL	108
PURPLE	TMM-COL-PL	108

## Consecutive Numbers

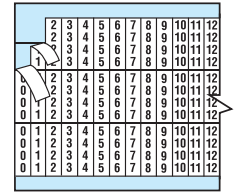

### Vinyl Film (B-702)

Legend	Order Reference	Quantity of Each Number per Card	Markers Per Card 12.70 mm
0 through 49	TMM-0-49	3	150
50 through 99	TMM-50-99	3	150
100 through 132	TMM-100-132	3	99
133 through 165	TMM-133-165	3	99
166 through 198	TMM-166-198	3	99
199 through 231	TMM-199-231	3	99
232 through 264	TMM-232-264	3	99
265 through 297	TMM-265-297	3	99
298 through 330	TMM-298-330	3	99
331 through 363	TMM-331-363	3	99
364 through 396	TMM-364-396	3	99
397 through 429	TMM-397-429	3	99
430 through 462	TMM-430-462	3	99
463 through 495	TMM-463-495	3	99

## Micro Markers

For identification of fine wire (Diameter 0.6 mm and smaller); resists continuous heat to 121°C. Only 50 micron thick. Two numbers on each marker, 250 markers on zip-strip dispenser card. Application tool included in each package of 25 cards. Marker size: 7.94 x 2.38 mm.

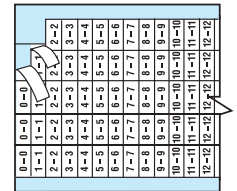

### Vinyl Film (B-702)

Legend	Order Reference	Markers Per Card
<b>Solid Numbers</b>		
0	TMXM-0	250
1	TMXM-1	250
2	TMXM-2	250
3	TMXM-3	250
4	TMXM-4	250
6	TMXM-6	250
through		
14	TMXM-14	250
17	TMXM-17	250

Legend	Order Reference	Sequences on each Card
<b>Consecutive Numbers Repeated</b>		
0 through 49	TMXM-0-49	5
50 through 99	TMXM-50-99	5
1 through 5	TMXM-1-5	50
1 through 10	TMXM-1-10	25
1 through 25	TMXM-1-25	10



## Porta Pack Books

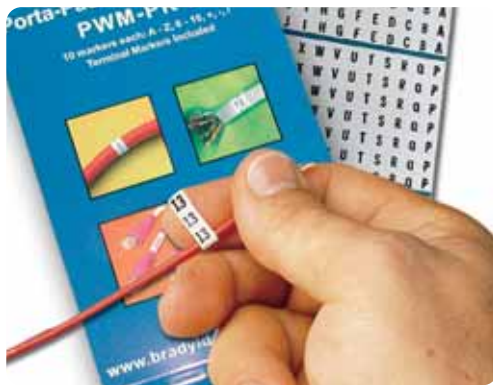

- Ten pages per book.
- Unique comb design allows for easy refill of book.
- Slim, lightweight, pocket-sized book is easy to carry and easy to use.
- Large selections of legends available. 15 different books...over 250 different refill packs.
- Numbers...letters...special symbols...NEMA colours.
- Includes terminal marker with each wire marker.

## Vinyl Cloth (B-500)

Order Reference	Legend	Markers each Legend
PWM-PK-1	0 to 9	45
PWM-PK-2	A to Z, 0 to 15, +, -, /	10
PWM-PK-3	1 to 45	10
PWM-PK-4	1, 2, 3	150
PWM-PK-5	A, B, C	150
PWM-PK-6	T1, T2, T3	150
PWM-PK-7	L1, L2, L3	150
PWM-PK-8	1 to 15 16 to 90 A to Z, +, -, /, 0	6 4 2
PWM-PK-9	1, 2, 3, A, B, C	45
PWM-PK-10	T1, T2, T3, L1, L2, L3	30
PWM-PK-11	10 different NEMA colours	45
PWM-PK-12	1 to 30 A to Z Blank Write-On Labels + -	15 15 18 8 7
PWM-PK-13	+ , -, AC, DC POS, NEG, GND, NEUT Spare Blank Write-On Labels	45 33 21 21
PWM-PK-14	46 to 90	10
PWM-PK-15	1 to 45 46 to 90	5 5

## Write-on Self-laminating Wire and Cable Markers

- Use Brady's labelling pens or other markers to write on legend.
- Transparent part over-wraps provide snug fitting, self-laminating shield that resists oil, water and solvents.
- For applications above or below ground.

## Vinyl (B-292)

Order Reference	Legend	Marker Size (mm)	Markers Per Book	Size of Write-on Area (mm)	Max Diam. (mm)
PWC-PK-1	Blank/Write-on	19.05 x 44.45	120	19.05 x 12.70	10
PWC-PK-3	Blank/Write-on	25.40 x 76.20	60	25.40 x 19.05	18
PWC-PK-6	Blank/Write-on	25.40 x 152.40	30	25.40 x 25.40	40
PWC-PK-36	Blank/Write-on	25.40 x 76.20 25.40 x 152.40	30 15	25.40 x 19.05 25.40 x 25.40	18 40



## Self Laminating Wire Markers

- Ten pages per book.
- Same as above but with printed legends.

## Vinyl (B-292)

Order Reference	Legend	Markers Each Legend	Max. Diameter mm
PWS-PK-1	0 to 9	45	12
PWS-PK-2	A to Z 0 to 15 + - /	10 10 10 10	12

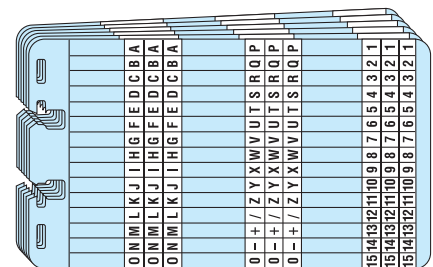

Order Reference	Legend	Marker Size (mm)	Markers Per Book	Size of Write-on Area (mm)	Max Diam. (mm)
PWS-PK-14	Blank/Write-on	12.70 x 38.10	180	12.70 x 19.05	6

## Porta-Pack® Accessories (continued)

### Labelling Pen

Brady's labelling pens use a quick drying, permanent ink. The ink is specially formulated to resist oil, solvents, abrasion and fading.



Order Reference	Ink Colour	Quantity
MP-1	Black Fine Point	12 per package or single pens are available
MP-2	Black Ultra Fine Point	12 per package or single pens are available
BFS-05	Black Fine Point	1
BFS-10	Black Ultra Fine Point	1

# ClipSleeve™ Wire Markers

## Nylon

Sizes 03 to 18 are supplied on wands with 30 sleeves per wand, 10 wands to a package. Sizes larger than 18 are packed 50 individual pieces per package. (Sizes 23 and 36 may be special-ordered mounted on wands instead of bags of 50 individual sleeves. Each pack contains 10 wands of 20 sleeves (size 23) or 15 sleeves (size 36). Specify putup desired when ordering.)

**Combination Packs:** PREFIX SCNC Contains 10 wands, one wand each of numbers 0 to 9.

**Alpha Packs** Contains 13 wands, one wand each of A to M or N to Z. (e.g. SCN07-A-M).

**Note:** Alpha Packs are not available in 03, 05, 23, 36, 45 or 61 sizes.

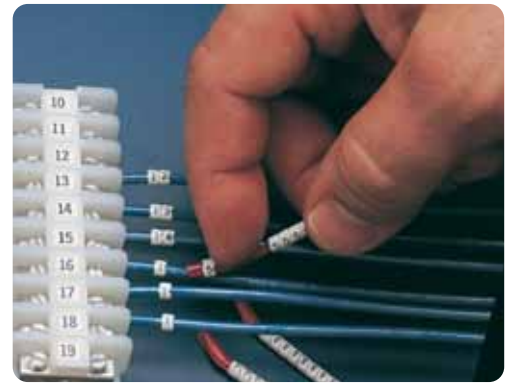

**Applier Wands** Separate wands for applying Size 23 and Size 36 ClipSleeve™ markers are available in packages of 5 wands. Specify SCN23-AW for Size 23 and SC36-AW for Size 36.

**Colour Coding Aids Users** Brady ClipSleeve™ applicator wands are colour coded for easy identification of sleeve sizes.

Size 03	maroon	Size 10	red
Size 05	grey	Size 13	dark blue
Size 07	light blue	Size 15	brown
Size 09	green	Size 18	yellow

- Markers apply quickly with a special QuikWand™ applicator.
- Place the flared "shoe" end of the wand against the wire and push sleeve onto the wire.
- Split sleeve with "chevron" locking design snaps on the wire, won't slip or slide.

For Wire Sizes	SIZE 03*	SIZE 05*	SIZE 07	SIZE 09	SIZE 10	SIZE 13
Diameter mm	0.95-1.30	1.35-1.85	1.90-2.20	2.50-2.80	2.80-3.40	3.40-4.60
LEGEND	Reference	Reference	Reference	Reference	Reference	Reference
0	SCN03-0	SCN05-0	SCN07-0	SCN09-0	SCN10-0	SCN13-0
and so on through	and so on through	and so on through	and so on through	and so on through	and so on through	and so on through
9	SCN03-9	SCN05-9	SCN07-9	SCN09-9	SCN10-9	SCN13-9
0 to 9	SCNC-03	SCNC-05	SCNC-07	SCNC-09	SCNC-10	SCNC-13
A	SCN03-A	SCN05-A	SCN07-A	SCN09-A	SCN10-A	SCN13-A
and so on through	and so on through	and so on through	and so on through	and so on through	and so on through	and so on through
Z	SCN03-Z	SCN05-Z	SCN07-Z	SCN09-Z	SCN10-Z	SCN13-Z
A to M			SCN07-A-M	SCN09-A-M	SCN10-A-M	SCN13-A-M
N to Z			SCN07-N-Z	SCN09-N-Z	SCN10-N-Z	SCN13-N-Z
+	SCN03-PLUS	SCN05-PLUS	SCN07-PLUS	SCN09-PLUS	SCN10-PLUS	SCN13-PLUS
-	SCN03-MINUS	SCN05-MINUS	SCN07-MINUS	SCN09-MINUS	SCN10-MINUS	SCN13-MINUS
BLANK		SCN05-BLANK	SCN07-BLANK	SCN09-BLANK	SCN10-BLANK	SCN13-BLANK
Parts per package	300	300	300	300	300	300

For Wire Sizes	SIZE 15	SIZE 18	SIZE 23*	SIZE 36*	SIZE 45*	SIZE 61*
Diameter mm	3.90-4.50	4.60-5.90	6.00-7.60	9.20-10.50	11.50-13.00	15.50-17.00
LEGEND	Reference	Reference	Reference	Reference	Reference	Reference
0	SCN15-0	SCN18-0	SCN23-0	SCN36-0	SCN45-0	SCN61-0
and so on through	and so on through	and so on through	and so on through	and so on through	and so on through	and so on through
9	SCN15-9	SCN18-9	SCN23-9	SCN36-9	SCN45-9	SCN61-9
0 to 9	SCNC-15	SCNC-18				
A	SCN15-A	SCN18-A	SCN23-A	SCN36-A	SCN45-A	SCN61-A
and so on through	and so on through	and so on through	and so on through	and so on through	and so on through	and so on through
Z	SCN15-Z	SCN18-Z	SCN23-Z	SCN36-Z	SCN45-Z	SCN61-Z
A to M	SCN15-A-M	SCN18-A-M				
N to Z	SCN15-N-Z	SCN18-N-Z				
+	SCN15-PLUS	SCN18-PLUS	SCN23-PLUS	SCN36-PLUS	SCN45-PLUS	SCN61-PLUS
-	SCN15-MINUS	SCN18-MINUS	SCN23-MINUS	SCN36-MINUS	SCN45-MINUS	SCN61-MINUS
Blank	SCN15-BLANK	SCN18-BLANK				
Parts per package	300	300	50	50	50	50

\*Consult your local BRADY representative delivery of half alphabet wands (A-M, N-Z) in sizes 03, 05, 23, 36, 45 and 61.

## Inserts for Cable Carrier

Ademark inserts enables efficient and uniform labelling for control panels. The inserts are universal and can be inserted in various carrier types, such as nameplate holders.



Ademark inserts are pre-printed and can be arranged in any sequence of numbers or letters that the user requires. Supplied on adhesive strips, the inserts are easily detachable to slide into carriers. The inserts are oval-shaped with gripping tabs.

The strips include:

- 25 inserts; length 3 mm
- 30 inserts; length 2.3 mm

\*Symbols: black on white, black on yellow, or coloured

0-9, A-Z, a-z, + - / . = ~ Δ Y ↔ Earth & International colour code

Special Ademark wiremarkers: on demand



## Ademark Inserts for Cable Carriers – 2.3 mm

Order Reference	Description	Pieces per Pack	Width (mm)
AIFCC-2.3-WT-A	White Ademark Insert for Cable Carrier 2.3 mm legend A	1000	2.3
AIFCC-2.3-WT-B	White Ademark Insert for Cable Carrier 2.3 mm legend B	1000	2.3
AIFCC-2.3-WT-C	White Ademark Insert for Cable Carrier 2.3 mm legend C	1000	2.3
AIFCC-2.3-WT-D	White Ademark Insert for Cable Carrier 2.3 mm legend D	1000	2.3
AIFCC-2.3-WT-E	White Ademark Insert for Cable Carrier 2.3 mm legend E	1000	2.3
AIFCC-2.3-WT-F	White Ademark Insert for Cable Carrier 2.3 mm legend F	1000	2.3
AIFCC-2.3-WT-G	White Ademark Insert for Cable Carrier 2.3 mm legend G	1000	2.3
AIFCC-2.3-WT-H	White Ademark Insert for Cable Carrier 2.3 mm legend H	1000	2.3
AIFCC-2.3-WT-I	White Ademark Insert for Cable Carrier 2.3 mm legend I	1000	2.3
AIFCC-2.3-WT-J	White Ademark Insert for Cable Carrier 2.3 mm legend J	1000	2.3
AIFCC-2.3-WT-K	White Ademark Insert for Cable Carrier 2.3 mm legend K	1000	2.3
AIFCC-2.3-WT-L	White Ademark Insert for Cable Carrier 2.3 mm legend L	1000	2.3
AIFCC-2.3-WT-M	White Ademark Insert for Cable Carrier 2.3 mm legend M	1000	2.3
AIFCC-2.3-WT-N	White Ademark Insert for Cable Carrier 2.3 mm legend N	1000	2.3
AIFCC-2.3-WT-P	White Ademark Insert for Cable Carrier 2.3 mm legend P	1000	2.3
AIFCC-2.3-WT-Q	White Ademark Insert for Cable Carrier 2.3 mm legend Q	1000	2.3
AIFCC-2.3-WT-R	White Ademark Insert for Cable Carrier 2.3 mm legend R	1000	2.3
AIFCC-2.3-WT-S	White Ademark Insert for Cable Carrier 2.3 mm legend S	1000	2.3
AIFCC-2.3-WT-T	White Ademark Insert for Cable Carrier 2.3 mm legend T	1000	2.3
AIFCC-2.3-WT-U	White Ademark Insert for Cable Carrier 2.3 mm legend U	1000	2.3
AIFCC-2.3-WT-V	White Ademark Insert for Cable Carrier 2.3 mm legend V	1000	2.3
AIFCC-2.3-WT-W	White Ademark Insert for Cable Carrier 2.3 mm legend W	1000	2.3
AIFCC-2.3-WT-X	White Ademark Insert for Cable Carrier 2.3 mm legend X	1000	2.3
AIFCC-2.3-WT-Y	White Ademark Insert for Cable Carrier 2.3 mm legend Y	1000	2.3
AIFCC-2.3-WT-Z	White Ademark Insert for Cable Carrier 2.3 mm legend Z	1000	2.3
AIFCC-2.3-WT-/	White Ademark Insert for Cable Carrier 2.3 mm legend /	1000	2.3
AIFCC-2.3-WT-GROUND	White Ademark Insert for Cable Carrier 2.3 mm legend GROUND	1000	2.3
AIFCC-2.3-WT--	White Ademark Insert for Cable Carrier 2.3 mm legend -	1000	2.3
AIFCC-2.3-WT-+	White Ademark Insert for Cable Carrier 2.3 mm legend +	1000	2.3
AIFCC-2.3-WT-.	White Ademark Insert for Cable Carrier 2.3 mm legend .	1000	2.3
AIFCC-2.3-WT-BLANK	White Ademark Insert for Cable Carrier 2.3 mm BLANK	1000	2.3
AIFCC-2.3-WT-0	White Ademark Insert for Cable Carrier 2.3 mm legend 0	1000	2.3
AIFCC-2.3-WT-1	White Ademark Insert for Cable Carrier 2.3 mm legend 1	1000	2.3
AIFCC-2.3-WT-2	White Ademark Insert for Cable Carrier 2.3 mm legend 2	1000	2.3
AIFCC-2.3-WT-3	White Ademark Insert for Cable Carrier 2.3 mm legend 3	1000	2.3

# Ademark Inserts

Order Reference	Description	Pieces per Pack	Width (mm)
AIFCC-2.3-WT-4	White Ademark Insert for Cable Carrier 2.3 mm legend 4	1000	2.3
AIFCC-2.3-WT-5	White Ademark Insert for Cable Carrier 2.3 mm legend 5	1000	2.3
AIFCC-2.3-WT-6	White Ademark Insert for Cable Carrier 2.3 mm legend 6	1000	2.3
AIFCC-2.3-WT-7	White Ademark Insert for Cable Carrier 2.3 mm legend 7	1000	2.3
AIFCC-2.3-WT-8	White Ademark Insert for Cable Carrier 2.3 mm legend 8	1000	2.3
AIFCC-2.3-WT-9	White Ademark Insert for Cable Carrier 2.3 mm legend 9	1000	2.3
AIFCC-2.3-YL-A	Yellow Ademark Insert for Cable Carrier 2.3 mm legend A	1000	2.3
AIFCC-2.3-YL-B	Yellow Ademark Insert for Cable Carrier 2.3 mm legend B	1000	2.3
AIFCC-2.3-YL-C	Yellow Ademark Insert for Cable Carrier 2.3 mm legend C	1000	2.3
AIFCC-2.3-YL-D	Yellow Ademark Insert for Cable Carrier 2.3 mm legend D	1000	2.3
AIFCC-2.3-YL-E	Yellow Ademark Insert for Cable Carrier 2.3 mm legend E	1000	2.3
AIFCC-2.3-YL-F	Yellow Ademark Insert for Cable Carrier 2.3 mm legend F	1000	2.3
AIFCC-2.3-YL-G	Yellow Ademark Insert for Cable Carrier 2.3 mm legend G	1000	2.3
AIFCC-2.3-YL-H	Yellow Ademark Insert for Cable Carrier 2.3 mm legend H	1000	2.3
AIFCC-2.3-YL-I	Yellow Ademark Insert for Cable Carrier 2.3 mm legend I	1000	2.3
AIFCC-2.3-YL-J	Yellow Ademark Insert for Cable Carrier 2.3 mm legend J	1000	2.3
AIFCC-2.3-YL-K	Yellow Ademark Insert for Cable Carrier 2.3 mm legend K	1000	2.3
AIFCC-2.3-YL-L	Yellow Ademark Insert for Cable Carrier 2.3 mm legend L	1000	2.3
AIFCC-2.3-YL-M	Yellow Ademark Insert for Cable Carrier 2.3 mm legend M	1000	2.3
AIFCC-2.3-YL-N	Yellow Ademark Insert for Cable Carrier 2.3 mm legend N	1000	2.3
AIFCC-2.3-YL-P	Yellow Ademark Insert for Cable Carrier 2.3 mm legend P	1000	2.3
AIFCC-2.3-YL-Q	Yellow Ademark Insert for Cable Carrier 2.3 mm legend Q	1000	2.3
AIFCC-2.3-YL-R	Yellow Ademark Insert for Cable Carrier 2.3 mm legend R	1000	2.3
AIFCC-2.3-YL-S	Yellow Ademark Insert for Cable Carrier 2.3 mm legend S	1000	2.3
AIFCC-2.3-YL-T	Yellow Ademark Insert for Cable Carrier 2.3 mm legend T	1000	2.3
AIFCC-2.3-YL-U	Yellow Ademark Insert for Cable Carrier 2.3 mm legend U	1000	2.3
AIFCC-2.3-YL-V	Yellow Ademark Insert for Cable Carrier 2.3 mm legend V	1000	2.3
AIFCC-2.3-YL-W	Yellow Ademark Insert for Cable Carrier 2.3 mm legend W	1000	2.3
AIFCC-2.3-YL-X	Yellow Ademark Insert for Cable Carrier 2.3 mm legend X	1000	2.3
AIFCC-2.3-YL-Y	Yellow Ademark Insert for Cable Carrier 2.3 mm legend Y	1000	2.3
AIFCC-2.3-YL-Z	Yellow Ademark Insert for Cable Carrier 2.3 mm legend Z	1000	2.3
AIFCC-2.3-YL-/	Yellow Ademark Insert for Cable Carrier 2.3 mm legend /	1000	2.3
AIFCC-2.3-YL-GROUND	Yellow Ademark Insert for Cable Carrier 2.3 mm legend GROUND	1000	2.3
AIFCC-2.3-YL--	Yellow Ademark Insert for Cable Carrier 2.3 mm legend -	1000	2.3
AIFCC-2.3-YL+	Yellow Ademark Insert for Cable Carrier 2.3 mm legend +	1000	2.3
AIFCC-2.3-YL.	Yellow Ademark Insert for Cable Carrier 2.3 mm legend .	1000	2.3
AIFCC-2.3-YL-BLANK	Yellow Ademark Insert for Cable Carrier 2.3 mm BLANK	1000	2.3
AIFCC-2.3-YL-0	Yellow Ademark Insert for Cable Carrier 2.3 mm legend 0	1000	2.3
AIFCC-2.3-YL-1	Yellow Ademark Insert for Cable Carrier 2.3 mm legend 1	1000	2.3
AIFCC-2.3-YL-2	Yellow Ademark Insert for Cable Carrier 2.3 mm legend 2	1000	2.3
AIFCC-2.3-YL-3	Yellow Ademark Insert for Cable Carrier 2.3 mm legend 3	1000	2.3
AIFCC-2.3-YL-4	Yellow Ademark Insert for Cable Carrier 2.3 mm legend 4	1000	2.3
AIFCC-2.3-YL-5	Yellow Ademark Insert for Cable Carrier 2.3 mm legend 5	1000	2.3
AIFCC-2.3-YL-6	Yellow Ademark Insert for Cable Carrier 2.3 mm legend 6	1000	2.3
AIFCC-2.3-YL-7	Yellow Ademark Insert for Cable Carrier 2.3 mm legend 7	1000	2.3
AIFCC-2.3-YL-8	Yellow Ademark Insert for Cable Carrier 2.3 mm legend 8	1000	2.3
AIFCC-2.3-YL-9	Yellow Ademark Insert for Cable Carrier 2.3 mm legend 9	1000	2.3
AIFCC-2.3-OR-BLANK	Orange Ademark Insert for Cable Carrier 2.3 mm BLANK	1000	2.3
AIFCC-2.3-WT-CA	White Ademark Insert for Cable Carrier 2.3 mm legend CA	1000	2.3
AIFCC-2.3-WT-DELTA	White Ademark Insert for Cable Carrier 2.3 mm legend DELTA	1000	2.3
AIFCC-2.3-WT-ARROW LEFT	White Ademark Insert for Cable Carrier 2.3 mm legend ARROW LEFT	1000	2.3
AIFCC-2.3-WT-ARROW RIGHT	White Ademark Insert for Cable Carrier 2.3 mm legend ARROW RIGHT	1000	2.3
AIFCC-2.3-BR-BLANK-INT	Brown Ademark Insert for Cable Carrier 2.3 mm BLANK	1000	2.3
AIFCC-2.3-GY-BLANK	Grey Ademark Insert for Cable Carrier 2.3 mm BLANK	1000	2.3
AIFCC-2.3-PL-BLANK-INT	Violet Ademark Insert for Cable Carrier 2.3 mm BLANK	1000	2.3
AIFCC-2.3-BR-1-INT	Brown Ademark Insert for Cable Carrier 2.3 mm legend 1	1000	2.3
AIFCC-2.3-RD-2	Red Ademark Insert for Cable Carrier 2.3 mm legend 2	1000	2.3
AIFCC-2.3-OR-3-INT	Orange Ademark Insert for Cable Carrier 2.3 mm Legend 3	1000	2.3
AIFCC-2.3-GN-5	Green Ademark Insert for Cable Carrier 2.3 mm legend 5	1000	2.3
AIFCC-2.3-BL-6-INT	Blue Ademark Insert for Cable Carrier 2.3 mm legend 6	1000	2.3
AIFCC-2.3-PL-7	Violet Ademark Insert for Cable Carrier 2.3 mm legend 7	1000	2.3
AIFCC-2.3-GY-8-INT	Grey Ademark Insert for Cable Carrier 2.3 mm legend 8	1000	2.3
AIFCC-2.3-BL-BLANK	Blue Ademark Insert for Cable Carrier 2.3 mm BLANK	1000	2.3
AIFCC-2.3-BK-BLANK-INT	Black Ademark Insert for Cable Carrier 2.3 mm BLANK	1000	2.3
AIFCC-2.3-RD-BLANK	Red Ademark Insert for Cable Carrier 2.3 mm BLANK	1000	2.3
AIFCC-2.3-GN-BLANK-INT	Green Ademark Insert for Cable Carrier 2.3 mm BLANK	1000	2.3
AIFCC-2.3-BK-0	Black Ademark Insert for Cable Carrier 2.3 mm legend 0	1000	2.3





## Ademark Inserts

Order Reference	Description	Pieces per Pack	Width (mm)
AIFCC-3-YL-BLANK	Yellow Ademark Insert for Cable Carrier 3 mm blank	1000	3
AIFCC-3-YL-0	Yellow Ademark Insert for Cable Carrier 3 mm legend 0	1000	3
AIFCC-3-YL-1	Yellow Ademark Insert for Cable Carrier 3 mm legend 1	1000	3
AIFCC-3-YL-2	Yellow Ademark Insert for Cable Carrier 3 mm legend 2	1000	3
AIFCC-3-YL-3	Yellow Ademark Insert for Cable Carrier 3 mm legend 3	1000	3
AIFCC-3-YL-4	Yellow Ademark Insert for Cable Carrier 3 mm legend 4	1000	3
AIFCC-3-YL-5	Yellow Ademark Insert for Cable Carrier 3 mm legend 5	1000	3
AIFCC-3-YL-6	Yellow Ademark Insert for Cable Carrier 3 mm legend 6	1000	3
AIFCC-3-YL-7	Yellow Ademark Insert for Cable Carrier 3 mm legend 7	1000	3
AIFCC-3-YL-8	Yellow Ademark Insert for Cable Carrier 3 mm legend 8	1000	3
AIFCC-3-YL-9	Yellow Ademark Insert for Cable Carrier 3 mm legend 9	1000	3
AIFCC-3-YL--	Yellow Ademark Insert for Cable Carrier 3 mm legend -	1000	3
AIFCC-3-WT- :	White Ademark Insert for Cable Carrier 3 mm legend :	1000	3
AIFCC-3-WT-=	White Ademark Insert for Cable Carrier 3 mm legend =	1000	3
AIFCC-3-YL-*	Yellow Ademark Insert for Cable Carrier 3 mm legend A	1000	3
AIFCC-3-WT-,	White Ademark Insert for Cable Carrier 3 mm legend ,	1000	3
AIFCC-3-BR-BLANK	Brown Ademark Insert for Cable Carrier 3 mm BLANK	1000	3
AIFCC-3-GY-BLANK	Grey Ademark Insert for Cable Carrier 3 mm BLANK	1000	3
AIFCC-3-PL-BLANK	Purple Ademark Insert for Cable Carrier 3 mm BLANK	1000	3
AIFCC-3-BL-BLANK	Blue Ademark Insert for Cable Carrier 3 mm BLANK	1000	3
AIFCC-3-BK-BLANK	Black Ademark Insert for Cable Carrier 3 mm BLANK	1000	3
AIFCC-3-OR-BLANK	Orange Ademark Insert for Cable Carrier 3 mm BLANK	1000	3
AIFCC-3-RD-BLANK	Red Ademark Insert for Cable Carrier 3 mm BLANK	1000	3
AIFCC-3-GN-BLANK	Green Ademark Insert for Cable Carrier 3 mm BLANK	1000	3
AIFCC-3-BK-0-INT	Black Ademark Insert for Cable Carrier 3 mm legend 0	1000	3
AIFCC-3-BR-1-INT	Brown Ademark Insert for Cable Carrier 3 mm legend 1	1000	3
AIFCC-3-RD-2-INT	Red Ademark Insert for Cable Carrier 3 mm legend 2	1000	3
AIFCC-3-OR-3-INT	Orange Ademark Insert for Cable Carrier 3 mm Legend 3	1000	3
AIFCC-3-YL-4-INT	Yellow Ademark Insert for Cable Carrier 3 mm Legend 4	1000	3
AIFCC-3-GN-5-INT	Green Ademark Insert for Cable Carrier 3 mm legend 5	1000	3
AIFCC-3-BL-6-INT	Blue Ademark Insert for Cable Carrier 3 mm legend 6	1000	3
AIFCC-3-PL-7-INT	Purple Ademark Insert for Cable Carrier 3 mm legend 7	1000	3
AIFCC-3-GY-8-INT	Grey Ademark Insert for Cable Carrier 3 mm legend 8	1000	3

### Ademark Dispenser

This black Nylon-Glass dispenser has the capability to hold 25 strips of wiremarkers. Dispensers can also be linked together to create further storage capacity. Dispensers clearly separate the wiremarkers enabling the end user to find the correct component with ease.



### Ademark Tool

Designed to make the application of wiremarkers more efficient. Its special shape helps the user insert the wiremarker efficiently into the carrier.



### Ademark Pick

Designed to efficiently remove markers from the carrier.





## Ademark Kit

The Ademark kit includes:

- 1 beechwood carry case (38 x 24 x 12.5 cm) with handle
- 1 Ademark Dispenser
- 1 Tool and 1 Pick
- 1000 Markers each: 0 - 9 A B C R S T U V W X Y Z + - Earth
- 750 carriers mod. 1
- 750 carriers mod. 2
- 500 carriers mod. 3



Order Reference	Description	Pieces per Pack
AIFCC-CASE	Ademark Insert for Cable Carrier Case Empty	1
AIFCC-DISPENSER	Ademark Insert for Cable Carrier Dispenser for 25 strips	1
AIFCC-HOOK	Ademark Insert for Cable Carrier Extracting Pick	1
AIFCC-KIT	Ademark Insert for Cable Carrier Case with Cons. & Acc.	1
AIFCC-TOOL-15MM	Ademark Insert for Cable Carrier Composing Tool 15 mm long	1
AIFCC-TOOL-30MM	Ademark Insert for Cable Carrier Composing Tool 30 mm long	1
	on request Special Ademark Cablemarkers	

The empty case can hold 49 boxes of cable markers, tools and a dispenser.

## Catena Rings

### Oval Cable Markers

These oval cable markers are produced in polyvinyl chloride making them highly flexible.

They are supplied in a row which makes them easily detachable.

#### Flexibility

The oval cable markers fit over cables with various diameters.

#### Supplied in rows

Ensures the markers are always kept together and always facing the correct way for easy use.

#### Assembly

Due to their ease of use the oval cable markers can often provide the quickest form of cable marking.

#### Minimum stock requirement

This form of marking reduces the requirement for keeping large quantities of stock as it is possible to effectively mark cables from a minimum of two packs of markers.

#### Economical

Low-cost, can be quickly applied

#### Minimum space requirement

As these markers slide directly on to the cable there is no requirement for a carrier. This allows even the smallest cable to be labelled.

#### Practical to use

Reels are made up of 500/1000 markers and therefore restocking costs are minimal.

#### NUMBERED OVAL MARKERS

These markers are supplied in white with black marking, however on request we can also supply yellow markers with black marking.

Numbers, Letters, Symbols: + - / . = ? Õ~ Earth or coloured.

International colour coded markers (on request)



# Catena Rings

## Reference table for ordering Catena rings

Catena rings are available in different diameters, colours and legends. Please use the table below for ordering.

### Catena ring Blank (no Legend)

Any combination is possible, e.g. CTR-0.8-RD-BLANK, CTR-2-GY-BLANK.

Description	Dia	Colour	Legend
CTR -	XX -	XX -	X
	0.8	BK	BLANK
	1.5	BL	
	2	BR	
	2.5	GN	
	3	GY	
	3.5	OR	
	4.5	PK	
	6	PL	
		RD	
		WH	
		YL	

### Catena ring with Legend

Any combination is possible, e.g. CTR-6-YL-G, CTR-3-WH-5

Description	Dia	Colour	Legend	Remark
CTR -	XX -	XX -	X	
	0.8	WH	-	
	1.5	YL	.	Not available in 0.8
	2		/	Not available in 0.8
	2.5		+	
	3		0 - 9	
	3.5		A - Z	
	4.5		Ground	Not available in 0.8
	6		CA	

### Catena rings – International Colour Coded

Important ! Only the diameter changes. The colour, legend and code stay fixed and should always be kept together e.g. CTR-2.5-GY-8-INT, CTR-3-GY-8-INT.

Description	Dia	Colour	Legend	Code
CTR -	xx -			
	0.8	BK	0	INT
	1.5	BL	6	INT
	2	BR	1	INT
	2.5	GN	5	INT
	3	GY	8	INT
	3.5	OR	3	INT
	4.5	PL	7	INT
	6	RD	2	INT
		YL	4	INT

\* Colour codes BK = Black, BL = Blue, BR = Brown, GN = Green, GY = Grey, OR = Orange, PK = Pink, PL = Purple, RD = Red, YL = Yellow, WH = White, YL = Yellow

## Catena Rings Tool for Cables

Designed to make the application of wiremarkers more efficient.

Order Reference	Description	Max. Diameter (mm)	Pieces per Pack
CCT-2	Catena rings tool for cables with max dia 1.8mm	1.8	1
CCT-2.5	Catena rings tool for cables with max dia 2.3mm	2.3	1
CCT-3	Catena rings tool for cables with max dia 2.8mm	2.8	1
CCT-3.5	Catena rings tool for cables with max dia 3.3mm	3.3	1
CCT-4	Catena rings tool for cables with max dia 3.8mm	3.8	1
CCT-4.5	Catena rings tool for cables with max dia 4.3mm	4.3	1
CCT-5	Catena rings tool for cables with max dia 4.8mm	4.8	1
CCT-6	Catena rings tool for cables with max dia 5.8mm	5.8	1
CCT-7	Catena rings tool for cables with max dia 6.8mm	6.8	1
CCT-8	Catena rings tool for cables with max dia 7.8mm	7.8	1
CCT-9	Catena rings tool for cables with max dia 8.8mm	8.8	1

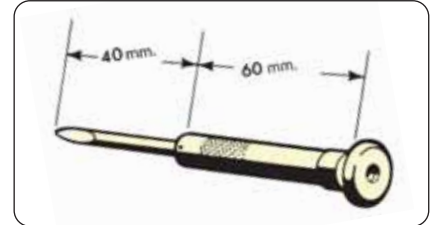

## Reference table for Catena Rings and Catena Tool

Inner ring ø (mm)	Tool type	For cables Wire Diameter Range Min/Max.(mm)
0.8	1.3	from 0.7 – 1.2
1.5	2	from 1.3 – 1.8
	2.5	from 1.3 – 2.3
2	2.5	from 1.8 – 2.3
	3	from 1.8 – 2.8
2.5	3	from 2.3 – 2.8
	3.5	from 2.3 – 3.3
3	3.5	from 2.8 – 3.3
	4	from 2.8 – 3.8
3.5	4	from 3.3 – 3.8
	4.5	from 3.3 – 4.3
	5	from 3.3 – 4.8
4.5	5	from 4.3 – 4.8
	6	from 4.3 – 5.8
	7	from 4.3 – 6.8
6	7	from 5.8 – 6.8
	8	from 5.8 – 7.8
	9	from 5.8 – 8.8

## Catena Rings Wooden box

### 20 reel box

A beechwood carry case that holds 20 reels and 2 tools.

Size: 195 x 362 x 95 h mm.



### 60 reel box

A beechwood carry case that holds 60 reels and 6 tools.

Size: 227 x 383 x 295 h mm.

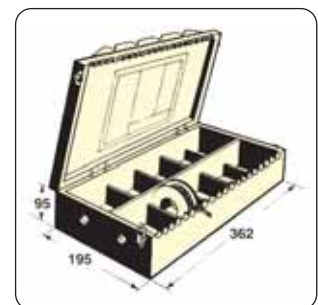

Order Reference	Description	Pieces per Pack
CCB-20	Catena rings wooden box for 20 reels & 2 tools	1
CCB-60	Catena rings wooden box for 60 reels & 6 tools	1