



CHAIN & RIGGING ATTACHMENTS

SHACKLES

CHAIN

SLINGS

HOOKS

TIE-DOWNS

BINDERS

WIRE ROPE ATTACHMENTS

HOIST RINGS

CLAMPS

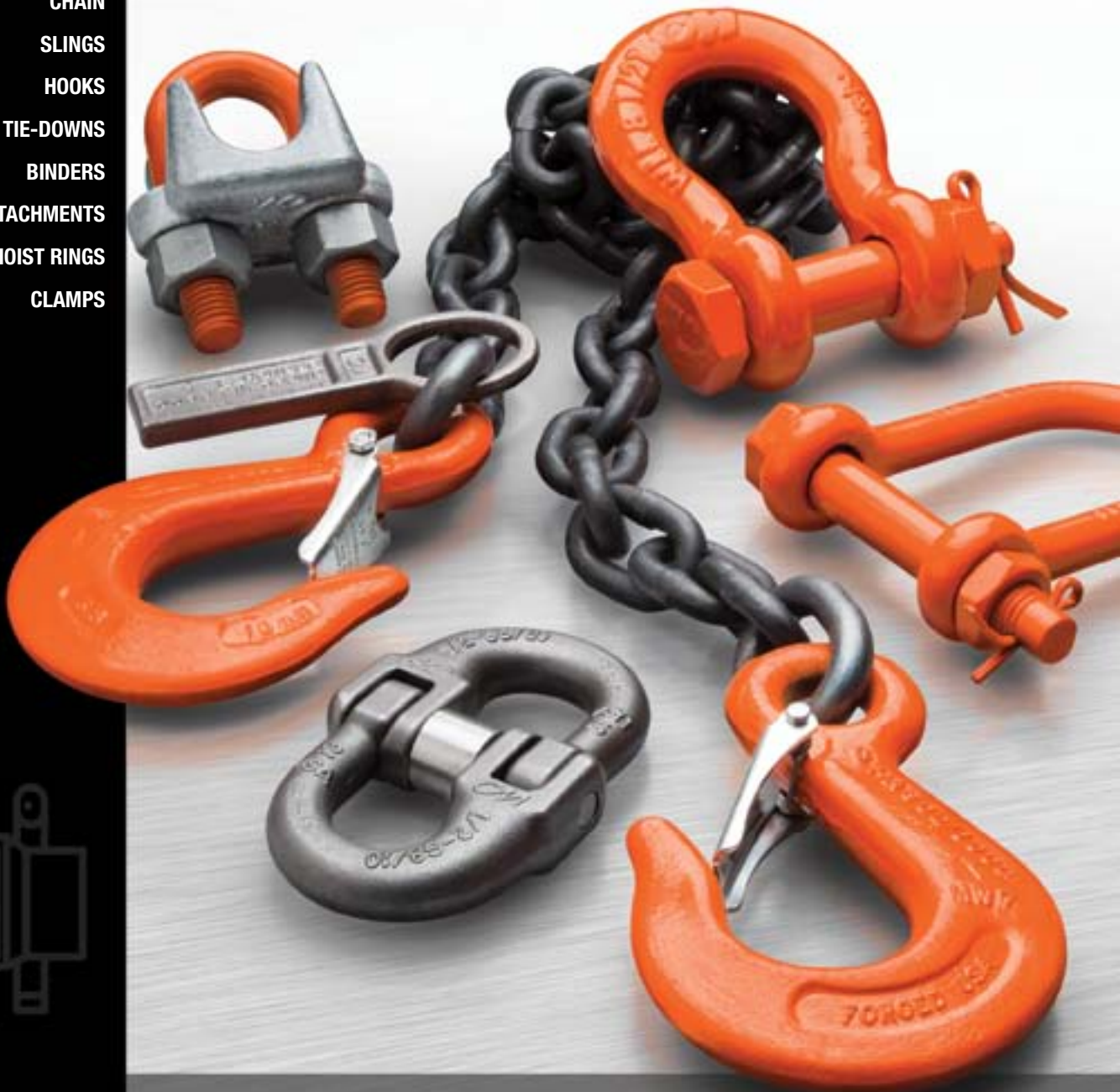

Columbus McKinnon Corporation has a rich tradition, spanning more than 141 years, of providing quality material handling products and services to meet the needs of users in a variety of industries around the globe. Professional riggers, maintenance workers, plant engineers and safety specialists rely on the CM line of chain and attachments to lift, pull and secure loads in a variety of applications. We continue to innovate and expand our rigging portfolio to meet industry needs and give customers the products they need for their unique and challenging applications.



TABLE OF CONTENTS

PRODUCT OVERVIEW	9
CHAIN & SLING INSPECTION, USE & CARE	23
SHACKLES	41
CHAIN SLINGS & COMPONENTS	57
Herc-Alloy® 1000 Products, Grade 100	60-71
Herc-Alloy 800® Products, Grade 80	72-83
RIGGING HARDWARE	85
Specialty Overhead Lifting Hooks & Lugs	88
Rings & Links	93
Adjustable Hardware	96
Wire Rope Compression Hardware	103
HEAVY-DUTY CRANE HOOKS	111
BELOW-THE-HOOK ATTACHMENTS	125
TRANSPORT CHAIN & ATTACHMENTS	145
SPECIALTY CHAIN & COMPONENTS	173
ENTERTAINMENT RIGGING PRODUCTS	181
HOISTS, TROLLEYS & BEAM CLAMPS	185
GLOSSARY	208
INDEX	210

Look for these important icons throughout this catalog.



In-Stock Guarantee Product
Contact your representative for details.



Made in the USA
Products proudly made in America.



CM Smart ID™
Products available with RFID technology.



Did You Know?
Industry, application and additional product details.



Inspection, Care & Use
Information every rigger should know.



Safety Warnings
Important information for safe and proper use.



Videos & Safety Webinars
Useful Educational and Sales Presentations

Contact Columbus McKinnon Corporation

800.888.0985 716.689.5400

FORWARD THINKING

Since 1875, when L.E. McKinnon opened a small shop to produce hardware for horse-drawn carriages, CM has pioneered many significant advances in our industry.

Our long history of innovation includes the development of the first alloy chain in 1935, which would eventually replace the industry-standard wrought iron chain used for overhead lifting. That first alloy chain was the predecessor to today's **Herc-Alloy 800®** and **Herc-Alloy® 1000** chains, hooks, and overhead rigging attachments and is now one of the most recognized brands in the rigging industry.

CM also invented the **Hammerlok®** coupling link in 1955, which enabled users of chain slings to build slings at the job site, rather than relying on a factory or service station for assembly. Today, the Hammerlok is used side-by-side with Herc-Alloy chain in all parts of the world.

Keeping innovation at the forefront of how we do business, an important recent CM milestone is our enhanced shackle identification markings. Our new forged identification markings are some of the largest and most user-friendly on the market and help to improve operator safety, reduce replacement costs, and allow for easier identification of CM products in the field. We've also developed dual-rated rigging attachments that can be used for both Grade 80 and 100 applications, helping customers reduce and better manage their rigging inventory.

Today, we continue our forward-thinking approach to our rigging business with our **In-Stock Guarantee**. The In-Stock Guarantee ensures availability of the American-made rigging products our customers rely on most. It's a new way of doing business that our competitors cannot offer and part of our commitment to providing best-in-class service to our end-users.



BUY WITH CONFIDENCE

CM is Proud to be Compliant with the “Buy American Act”

We know that American-made products are important to our customers. That’s why CM manufactures the majority of its chain and rigging attachments at our two Tennessee facilities. We also manufacture many of our hoists here in America as well.

Dating back to 1933, the Buy American Act requires end products for supplies or construction material to be manufactured domestically. For a product to comply with this Act, it is required that more than half the cost of its components is derived from U.S.-made components.

CM is proud to comply with the Buy American Act and is happy to supply a Certificate of Compliance upon request.



SERVICING CUSTOMERS AROUND THE GLOBE

In today’s global economy, Columbus McKinnon is ready to meet the needs of customers anywhere in the world.

We rely on our world-class global manufacturing facilities to produce best-in-class material handling products as well as perform product testing that exceeds standards outlined by industry regulations. To quickly and efficiently meet customer demands, we have also strategically positioned our warehouses to ensure our products are available to the customer when they need them.

Our material handling knowledge and expertise surpasses the competition. Our dedicated team of engineers, trainers and sales representatives continually work with customers to solve tough application problems and better understand their needs to fuel future product development.



IN-STOCK GUARANTEE

Columbus McKinnon's In-Stock Guarantee is a company-wide commitment to ship its most popular hoists, chain and forged attachment products in days, not weeks – so customers can get the products they need, when they need them.

The In-Stock Guarantee is designed to provide our Channel Partners and Distributors with best-in-class service and delivery of the material handling products they use every day. It also ensures product availability and reduces their on-hand product inventory.

Our In-Stock Guarantee includes hundreds of products guaranteed to ship in three days or less. We'll continue expand the offering to include more and more of the products our customers use most.

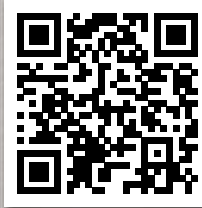

**WATCH OUR
ISG VIDEO**
SCAN THE QR CODE
WITH YOUR SMARTPHONE



Make your job easier. Save time and money. The CM Bandit™ and a variety of CM shackles are now available with CM Smart ID™ radio frequency identification (RFID) technology.

Columbus McKinnon offers RFID capabilities on the CM Bandit – making it one of the industry's first RFID-equipped ratchet lever hoists. It is also offered on some of the smallest CM shackles available.

INVENTORY TRACKING

BE MORE PRODUCTIVE & EFFICIENT

- Easily serialize inventory in your warehouse or job site
- Record and manage location of assets anywhere, anytime
- Save time and complete inventory checks faster
- Serial number can't wear off like printed or embossed serialization

INSPECTION MANAGEMENT

WORK SAFER

- Instantly see detailed product and inspection information
- Log inspection information right on site
- Increase inspection accuracy and detail, while reducing training time
- Easily maintain an up-to-date inspection log to ensure compliance with industry regulations



STANDARD ON CM BANDIT

CM Smart ID comes standard on all CM Bandit hoists for the U.S. market. It's the world's first HMI-Certified ratchet lever hoist with RFID technology.



OPTIONAL ON CM SHACKLES

CM Smart ID is optional on CM screw pin anchor and bolt, nut & cotter shackles. Available for all grades and finishes.



SMALL & DURABLE

Well-suited for even the harshest environments, CM Smart ID chips resist impact, moisture, UV, radiation, chemicals, magnetic particle testing and extreme temperatures.





PRODUCT OVERVIEW

From CM Chain and Chain Slings to Plate Clamps and Cady® Lifters, our broad product offering is complemented by an unmatched wealth of knowledge and expertise that far surpasses our competition. This includes:





- A thoroughly trained and knowledgeable technical sales force that provides expertise on applications, regulations, training requirements and product features and benefits.
- A global network of authorized distributors that provide inventory, technical support, service after the sale, and consultation regarding specific needs.
- Knowledgeable customer service representatives to help customers with shipment information, product selection, specifications and auxiliary items.
- An engineering team constantly working to improve existing products, while developing unique and innovative new products.
- Training programs dedicated specifically to rigging products, as well as broad-based programs to cover all aspects of lifting and positioning.
- The unique ability to not only manufacture high-quality rigging products, but also lead the industry in the design and manufacture of hoists, overhead cranes, and related products.

CHAIN OVERVIEW

Our chain manufacturing roots date back to the late 1800s and the Columbus Chain Company. We hold patents in chain and chain link design as well as patents in chain manufacturing processes, which help ensure our chain is the strongest and most reliable on the market today. We also invented the first alloy chain in 1933 – the forerunner to our industry-changing Herc-Alloy 800® and 1000 chains.

Today, Columbus McKinnon is an industry-leading chain manufacturer. Relying on more than a century of chain-making expertise and innovation, we manufacture a wide selection of welded graded chain in Tennessee, for use in a variety of industries. We have always been an innovator in chain and rigging products, and we continually work to improve our processes and materials to ensure we manufacture the best chain in the industry year after year.

GRADED WELDED CHAIN AT A GLANCE

	ASTM & NACM Grade	CM Chain Embossment	ASTM Specification	Name	Typical Uses
	GRADE 30	G30	A413	Proof Coil	General-purpose, low-carbon chain for industrial and agricultural applications including guard rails, logging and load securement. Not to be used for overhead lifting.
	GRADE 43	G43	A413	High Test	Grade 43 chain is manufactured to meet ASTM & NACM specifications. Typical uses include container securement, logging, towing and marine industry applications. Grade 43 is available in many finishes. Not to be used for overhead lifting.
	GRADE 70	G70	A413	Transport	A higher-strength, heat-treated carbon steel chain typically used by truckers, loggers and highway crews for load securement, towing, lashing and as trawler chain. Load ratings of Grade 70 chain are approximately 20% higher than Grade 43. Not to be used for overhead lifting.
	GRADE 80	HA800	A391	Alloy	A higher-strength, heat-treated alloy steel chain primarily used as a sling component for overhead lifting, but can also be used in rigging and tie-down applications where a lighter weight, higher strength chain is desirable. Recommended for overhead lifting by NACM, ASME and OSHA.
	GRADE 100	HA1000	A973	Alloy	With approximately 25% higher strength than Grade 80, Grade 100 chain is used primarily as a sling component for overhead lifting. Grade 100 chain can be used for all of the same applications as Grades 30 through 80. Recommended for overhead lifting by NACM, ASME and OSHA.

DIMENSIONS, WEIGHTS & WLL

Chain Size (in.)	Wire Diameter Nominal (in.)	Inside Length Nominal (in.)	Inside Width Nominal (in.)	Weight Per 100 ft (lbs.)	Working Load Limit (lbs.)
GRADE 30 (PROOF COIL)					
3/16	0.22	0.97	0.45	39.8	800
1/4	0.28	1.22	0.51	64.6	1,300
5/16	0.33	1.27	0.60	97.6	1,900
3/8	0.39	1.35	0.58	140.2	2,650
1/2	0.50	1.73	0.81	227.0	4,500
5/8	0.63	1.92	0.86	363.0	6,900
3/4	0.78	2.40	1.07	568.0	10,600
GRADE 43 (HIGH TEST)					
1/4	0.28	1.22	0.51	64.6	2,600
5/16	0.34	1.25	0.54	104.0	3,900
3/8	0.39	1.35	0.58	140.3	5,400
1/2	0.50	1.73	0.81	227.0	9,200
5/8	0.63	1.92	0.86	363.0	13,000
3/4	0.78	2.40	1.07	568.0	20,200
GRADE 70 (TRANSPORT)					
1/4	0.39	0.84	0.47	76.4	3,150
5/16	0.33	0.98	0.46	100.5	4,700
5/16	0.33	1.10	0.50	96.9	4,700
3/8	0.39	1.14	0.54	145.5	6,600
3/8*	0.39	1.38	0.60	136.5	6,600
1/2	0.53	1.56	0.73	267.0	11,300
HERC-ALLOY 800® (GRADE 80)					
7/32	0.22	0.68	0.31	44.3	2,100
9/32	0.28	0.88	0.40	72.9	3,500
5/16	0.33	1.02	0.46	90.9	4,500
3/8	0.39	1.25	0.57	144.0	7,100
1/2	0.51	1.44	0.73	255.0	12,000
5/8	0.63	1.78	0.86	382.3	18,100
3/4	0.79	2.23	1.07	595.0	28,300
7/8	0.88	2.25	1.14	776.0	34,200
1	1.00	3.07	1.49	941.0	47,700
1-1/4	1.25	3.92	1.74	1,420.0	72,300
HERC-ALLOY 1000 (GRADE 100)					
7/32	0.22	0.68	0.31	44.3	2,700
9/32	0.28	0.88	0.40	72.9	4,300
3/8	0.39	1.25	0.57	144.0	8,800
1/2	0.51	1.56	0.73	246.0	15,000
5/8	0.63	1.92	0.86	370.0	22,600
3/4	0.79	2.40	1.07	577.0	35,300

* Standard Link Grade 70 Chain

GRADE 30

GRADE 43

GRADE 70

GRADE 80

GRADE 100

CHAIN SLINGS OVERVIEW

Chain slings are a combination of chain, hooks, rings or other attachments used primarily for overhead lifting applications. Slings are generally used in conjunction with a crane or some type of lifting device and allow riggers to create a custom configuration to lift a load depending on the needs of the unique application.

CHAIN SLING CONFIGURATIONS

Standard sling configurations consist of chain branches that are affixed on one end to a master link or ring with some type of attachment, typically a hook, attached to the opposite end. CM manufactures a variety of standard sling configurations, including single, double, triple and quad chain slings. The following symbols are used to describe a sling.

FIRST SYMBOL (BASIC TYPE):

- S** : Single chain sling
- C** : Single choker chain sling with a standard end link on each end, no hooks.
- D** : Double branch chain sling (2 legs)
- T** : Triple branch chain sling (3 legs)
- Q** : Quadruple branch chain sling (4 legs)

SECOND SYMBOL (TYPE OF MASTER OR END LINK):

- O** : Oblong master link of standard dimensions
- P** : Pear shaped master link (available on request)
- R** : Ring

THIRD SYMBOL (TYPE OF HOOK):

- S** : Sling Hook
- G** : Grab Hook
- F** : Foundry Hook
- L** : Latchlok

A hook safety latch is not required by OSHA. However, if a latch is present it must be in working condition.

If attachments are other than standard, give detailed specifications.

Sling tags are stamped 1 to 4 to reflect number of branches. Additional coding is defined as follows:

- | | |
|-------------------------------------|-------------------------------------|
| AS : Adjustable Single | SB : Single Basket |
| ES : Endless Single | ED : Endless Double |
| SAL : Single Adjustable Loop | DAL : Double Adjustable Loop |
| AD : Adjustable Double | DB : Double Basket |

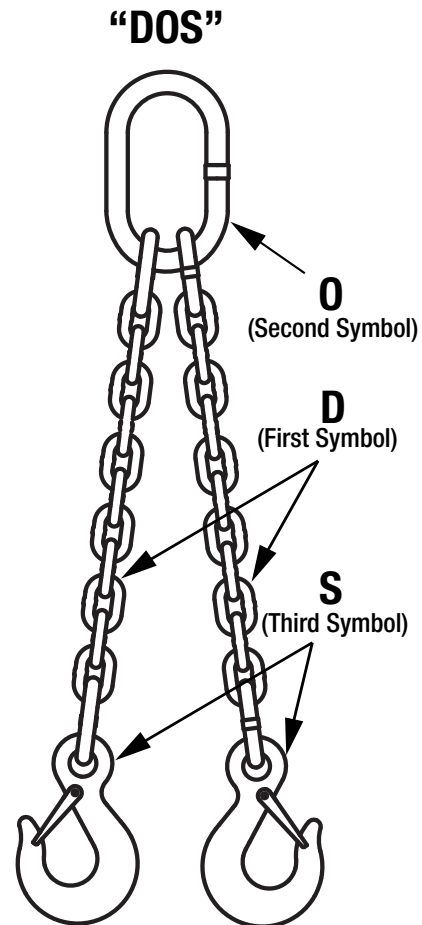

Special configurations available upon request.
For more information on sling inspection and care, see pages 26 through 28.

STANDARD TYPES OF CM CHAIN SLINGS

SINGLE CHAIN SLINGS : TYPE S & C



DOUBLE CHAIN SLINGS : TYPE D



TRIPLE CHAIN SLINGS : TYPE T

QUADRUPLE CHAIN SLINGS : TYPE Q

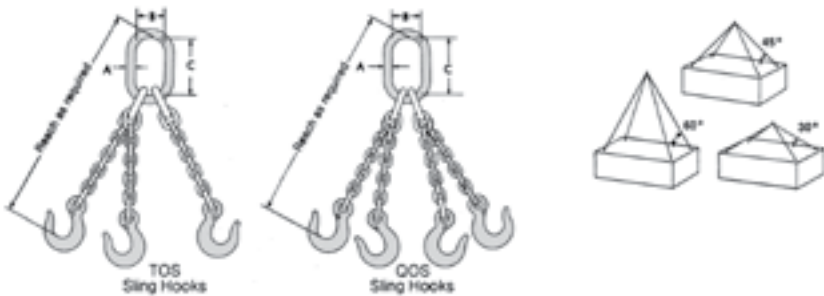

SAFETY NOTE

A quad branch chain sling, especially when used on a load of rigid structure, is usually not sustaining the load evenly on each of its four branches. The maximum working load limits are therefore set at the same values as triple branch chain slings of equal quality and size with branches used at same angle of inclination.

▶ SLING ID TAGS

CM sling configurations come with an affixed metal identification tag that includes:

- ▲ Sling size
- ▲ Sling reach
- ▲ Working load limit (all slings must be rated by their weakest component)
- ▲ Serial number
- ▲ Manufacturer name (CM) and grade of sling
- ▲ Number of branches

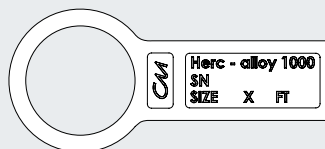

Permanently affixed sling ID tags are required per ASME B30.9 and OSHA 1910.184. To order replacement sling ID tags, contact customer service. For additional information see pages 33, 63 & 75.



HOOKS OVERVIEW

Whether you're lifting, pulling, towing or securing loads, the Columbus McKinnon line of hooks has you covered. Our history in rigging-type products dates back more than 100 years, and we rely on this long-standing knowledge and expertise to develop durable and reliable hooks that can stand up to even the toughest overhead lifting and binding applications.

Available in numerous grades and materials, we have a variety of hook styles for both overhead and non-overhead lifting applications. Learn more about all of our available hook styles below.

OVERHEAD LIFTING HOOKS

Not all hooks are appropriate for overhead lifting. When choosing an overhead lifting hook, it's important to consider the application you will be using it for. If you are lifting a plate, you may need one type of hook, while lifting a vehicle engine may require another. **Only alloy hooks should be used in overhead lifting applications.** Below are various types of hooks CM recommends for overhead lifting applications.

CLEVLOK® HOOKS

CM trademarked Clevlok® Herc-Alloy® Hooks are typically used for overhead lifting applications. This line of hooks offers easy installation in the shop or in the field. These hooks are 100% proof tested at the factory, thus requiring no additional testing once installed.



EYE HOOKS

CM Herc-Alloy® Eye Hooks are an excellent choice for welded assemblies. For some applications, they also may be used with mechanical couplers such as the CM Hammerlok®. These hooks are designed for overhead lifting and can be used in place of Clevlok® hooks if preferred. Overhead lifting eye hooks are 100% proof tested at the factory, thus requiring no additional testing once installed using the CM Hammerlok.



"S" HOOKS

CM Herc-Alloy® "S" Hooks are built and designed for special lifting applications. CM "S" hooks are 100% proof tested at the factory and can be used for various applications where a wide throat opening is desired.



PLATE HOOKS

CM Herc-Alloy® Plate Hooks are designed for lifting plate material, like steel, in vertical and horizontal orientations. Plate hooks should be used in pairs and careful attention should be paid to sling angles when determining the working load limit.



SORTING HOOKS

CM Sorting Hooks are designed to lift and move material with long narrow throat openings. Sorting hooks are 100% proof tested and are available with and without handles.



HEAVY-DUTY CRANE HOOKS

CM Heavy-Duty Crane Hooks are forged at Columbus McKinnon's STB (Stahlhammer Bommern) manufacturing facility in Hamm, Germany of high-quality German alloy steel. This category offering includes single hooks, ramshorn (double) hooks, eye hooks, cargo hooks and cross hooks, ranging from 1 to 1,250 metric ton capacities.



NON-OVERHEAD LIFTING HOOKS

Non-overhead lifting hooks are designed for pulling or load securement application. These hooks do not have the same requirements as those used for overhead lifting. Non-overhead lifting hooks are available in Grades 30, 43, and 70. Grade 80 hooks that are not suitable for overhead lifting are marked T-80 and should only be used for load securement.

CLEVIS HOOKS

Clevis Hooks are not designed for overhead lifting, but instead are most often used for load securement with tie-down chains. Clevis hooks are easy to install in the field and can be used in combination with various grades of chain including Grade 30, 43, 70 and 80. These feature a U-shaped attachment point with a pin to secure chain or other rigging attachments. Different grades of clevis hooks have different working load limits, therefore you must ensure you use the correct hook grade and size for your application.



Grab Hooks Slip Hooks

EYE HOOKS (NON-CRADLE GRAB & SLIP HOOKS)

Standard Eye Hooks are not designed for overhead lifting, but instead are most often used for load securement with tie-down chains. Eye hooks are used in combination with various grades of chain including Grade 30, 43, 70 and 80. Eye hooks feature a simple circular attachment point for rigging chain or other attachments. Different grades of eye hooks have different working load limits, therefore you must ensure you use the correct hook grade and size for your application.



Grab Hooks Slip Hooks

▶ HOOK INSPECTION & USE

INSPECTION:

- ▲ Discard hooks that are worn more than 10% of the original dimension or are worn beyond a specific dimension or tolerance as provided in a wear allowance table, chart or diagram.
- ▲ Discard hooks that have an increase in throat or slot opening more than 5% of the original opening (not to exceed 1/4 inch).
- ▲ Discard hooks with any visibly apparent bend or twist from the plane of the unbent hook.
- ▲ Replace load pins that are permanently distorted.
- ▲ Hooks should not be subjected to bending, exposed to sharp objects or tip loaded.
- ▲ Replacement load pins shall be obtained from the manufacturer of the hook.

USE:

- ▲ Care should be exercised during use, so the hook is not abused or damaged.
- ▲ Hooks attached to chain should be selected to match the size and working load limit of the chain.
- ▲ Do not exceed the working load limit or shock load the chain or attachments. Loads applied rapidly or dropped freely can result in serious overloading of the hook.
- ▲ Use proper size chain in the throat of the grab hook.
- ▲ Hooks should not be subjected to bending, exposed to sharp objects, tip loaded (unless specified by the manufacturer) or loaded in a manner inconsistent with its design.
- ▲ Avoid exposure to corrosive mediums or high temperatures that could affect the thermal treatment and strength of the hook.
- ▲ Hooks can be used from -40 degrees F to 400 degrees F without reduction of working load limit. Call the manufacturer if you exceed these temperatures.

Refer to American Society of Mechanical Engineers ASME B30.10 for a discussion of hooks, inspection procedures and operating practices.



HOOK LATCHES



CORRECT INCORRECT

Hook latches (when required) must be in good working condition. If not, the hook should be removed from service.

NEVER TIP LOAD A HOOK!

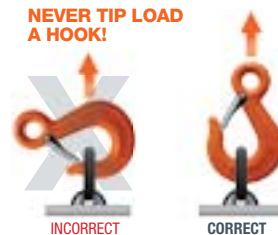

INCORRECT

CORRECT

90° MAX INCLUDED ANGLE FOR HOOKS

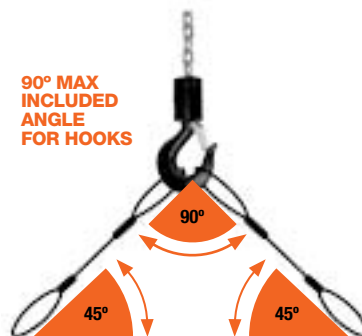

SELECTING THE RIGHT SIZE HOOK/SLING

Be sure the component is of adequate size and shape so that it can be properly seated in the saddle of hook or lifting device.

LOW HORIZONTAL ANGLES

Use a shackle or oblong master link when working with low horizontal angles. Both can be used with included angles up to 120°.

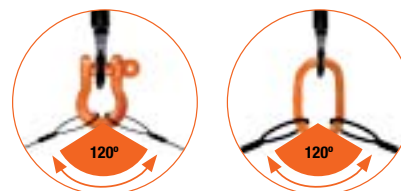

Always verify manufacturer's information prior to use.

RINGS & LINKS OVERVIEW

While alloy steel rings and links may be used individually for lifting and rigging applications, they are used most frequently as components of a sling. Rings and links are sized for use with Grade 80 or Grade 100 chain and enable the user to construct a balanced sling system for lifting and rigging. We offer a variety of rings and links suitable for overhead and non-overhead lifting applications, explained in detail below.

OVERHEAD LIFTING RINGS & LINKS

MASTER RINGS

Master Rings are an important part of most rigging applications and can be used universally because of their round configuration.



OBLONG MASTER LINKS

Featuring an optimum design for sling construction, Oblong Master Links have a greater capacity when compared with master rings of the same size because of their smaller width. Oblong master links' oval shape is also ideal for use with crane hooks, since the depth of a crane hook is normally greater than the width.



PEAR-SHAPED MASTER LINKS

These links may be used for the same applications as oblong master links, but their design is not optimum for multiple branch slings and, in some cases, may interfere with the crane hook.



OBLONG MASTER LINK SUB-ASSEMBLIES

Designed primarily for constructing slings with multiple branches, Oblong Master Link Sub-Assemblies allow you to construct a sling using mechanical couplers between the welded master couplers and the chain branches.



GRAB LINKS

Grab Links can be used to create a variable length loop-type sling. The grab link design captures a link of the chain in the link slot – similar to that of a grab hook. Grab links have a narrow neck, which restricts their use.



HAMMERLOK® COUPLING LINKS

Constructed of drop forged alloy steel and used primarily in the construction of overhead lifting slings. Specifically used for connecting the chain branches to the master link and to the hook attachments. Dual-rated Hammerloks® meet the strength levels of Grade 80 and 100. Must be matched to the chain size. Not to be used for repair or splicing of the chain.



OMEGALOKS

CM Omegaloks offer an alternative to the CM Hammerlok® as a mechanical coupler. The load and retain pin design is similar to the trademarked Clevlok® connectors. Dual-rated Omegaloks are designed to be used in conjunction with ML Series Master Links and are 100% proof tested. They can also be field installed.



A Columbus McKinnon Original. ▶
First introduced by Columbus McKinnon in 1955, the CM Hammerlok® coupling link made it possible for riggers to build chain slings at the job site.

NON-OVERHEAD LIFTING RINGS & LINKS

MID-LINKS

Mid-Links are typically used for quick repair, both temporary and permanent, of chain or for attaching chain hooks, rings and swivels to chain. They should not be used for overhead lifting. Can be used for cargo securement.



CONNECTING LINKS

Connecting Links are a type of repair link intended for use with Grade 30 chain. To use connecting links, both halves of the link are placed together and small protrusions are peened over. Connecting links should not be used for overhead lifting or cargo securement and tie-down.



REPAIR LINKS

Made of low carbon steel, Repair Links are used to permanently mend and repair chain. When using repair links, chain links and attachments are threaded into the repair lap link and the link is flattened. Repair links should not be used for overhead lifting or cargo securement and tie-down.



COLD SHUTS

Cold Shuts are a semi-permanent repair link for use with Grades 30 and 43 chain. To use a cold shut, thread a link onto the chain and insert the plain end through the hole in the link and peen over to secure. Cold Shuts should not be used for overhead lifting or cargo securement and tie-down.



▶ LINK INSPECTION & USE

INSPECTION:

Care should be exercised so that the ring and link(s) are not abused in any way during use.

- ▲ Links should not be subjected to bending or exposed to sharp corners or objects.
- ▲ Avoid exposure to corrosive mediums or high temperatures.

Visually inspect all rings and links before each use for the following conditions:

- ▲ Twists or bends
- ▲ Nicks or gouges
- ▲ Excessive wear at bearing points (innerlink area)
- ▲ Elongation (link elongation)
- ▲ Corrosion or other obvious damage

Since any of these conditions can affect the strength of the attachments shown above, a qualified person should conduct the inspection and determine whether replacement is necessary.



⚠ WARNING

Improper use or care of rings and links can result in bodily injury or property damage. To avoid injury:

- ▲ Always inspect before use for wear, damage, and elongation.
- ▲ Do not use if excessively worn or damaged.
- ▲ Never exceed the working load limit.
- ▲ Ensure the proper size link is used, and the working load limit of the ring or link is equal to or greater than the working load limit of the chain.
- ▲ Do not impact or shock load. Apply load slowly.
- ▲ Do not use on oversize crane hooks where link does not fit in saddle of the hook.
- ▲ Protect from corrosion.
- ▲ Use only alloy chain and attachments for overhead lifting.
- ▲ Do not use Hammerlok® coupling links or any of the couplers shown above to repair alloy chain for overhead lifting.

SHACKLES OVERVIEW

When it comes to shackles, Columbus McKinnon prides itself on providing the strongest and most reliable products on the market. We carry a full line of anchor and chain shackles, manufactured through our state-of-the-art forging process in Chattanooga, Tennessee*.

CM shackles are available in four materials, including carbon, super strong, U.S. alloy and German alloy. Our innovative Super Strong Shackles are unique in the industry, featuring strength ratings up to 50 percent stronger than comparable sized carbon shackles and a 6:1 design factor for ultimate safety.

CM shackles are available in a three styles: **Screw Pin; Bolt, Nut & Cotter; and Round Pin.** Learn more about the uses and benefits of each shackle style below.

* Some higher-capacity shackles are forged from high-quality German alloy steel at our STB facility in Hamm, Germany and then finished in the U.S.A.

BOLT, NUT & COTTER SHACKLES

Of all shackle types, Bolt, Nut and Cotter Shackles provide the most secure pin arrangement, resisting axial and torsional loading. This type of shackle should be used in semi-permanent applications where the pin is removed infrequently or where cyclical loading occurs. This is the preferred type of shackle in areas that are difficult to reach or inspect. Recommended for overhead lifting, bolt, nut and cotter shackles are available in capacities up to 150 tons.



SCREW PIN SHACKLES

Screw Pin Shackles allow for quick and easy removal of the screw pin, which makes this style ideal for applications where the shackle is removed frequently. While the threaded pin can resist axial forces, it should not be cyclically loaded and is unreliable and vulnerable to backing out in applications where the pin is subjected to a torque or twisting action. Recommended for overhead lifting, screw pin shackles are available in capacities up to 43 tons. Screw pins should be moused in some applications.



ROUND PIN SHACKLES

Round Pin Shackles allow for easy removal by simply removing the cotter that holds the pin in place. These shackles perform well where the pin is subjected to a torque or twisting action, but they should not be subjected to an axial load. Round pin shackles are available in capacities up to 43 tons and are **not recommended for overhead lifting.**



4 TYPES OF SHACKLE MATERIAL

MATERIAL	STYLE	WLL (TONS)	SIZES (IN.)	STYLES	DESIGN FACTOR	FINISHES
CARBON	Anchor	1/3 to 85 ton	3/16" to 3"	Bolt, Nut & Cotter; Screw Pin; Round Pin	6:1	Orange Powder Coated, Galvanized
	Chain	1/2 to 35 ton	1/4" to 2"			
SUPER STRONG 17 to 50% stronger than comparable-sized Carbon	Anchor	1/2 to 55 ton	3/16" to 2-1/2"	Bolt, Nut & Cotter; Screw Pin; Round Pin	6:1**	Orange Powder Coated, Self Colored, Galvanized
	Chain	3/4 to 35 ton	1/4" to 2"			
ALLOY (U.S.) ~50% stronger than comparable-sized Carbon and ~25% stronger than Super Strong	Anchor	2 to 120 ton	3/8" to 3"	Bolt, Nut & Cotter; Screw Pin; Round Pin	5:1	Orange Powder Coated, Self Colored, Galvanized
ALLOY (GERMAN) Higher average Charpy values	Anchor	85 to 150 ton	2-1/2" to 3-1/2"	Bolt, Nut & Cotter	5:1	Self Colored, Galvanized

** Super Strong round pin shackles have a 5:1 design factor.

WIRE ROPE ATTACHMENTS OVERVIEW

Wire rope is frequently used to make slings for rigging applications. The CM portfolio of wire rope attachments, including wire rope clips, thimbles and turnbuckles, are used to secure loops or turn back wire rope when used as part of a sling. Learn more about our specific wire rope attachment products and their uses below.

WIRE ROPE CLIPS

Wire Rope Clips are used to secure the end of wire rope when forming a loop; i.e., for wire rope turn-back. Clips are available in two configurations: mid-grip (double saddle) and single saddle. Each configuration is equally strong and effective, but care must be exercised for proper installation of single saddle clips; i.e., saddle must rest against live end of wire rope. All clips should be used in conjunction with a wire rope thimble and may require torquing.

NOTE: Wire rope clips are not recommended for fabricating slings for overhead lifting. Reference ASME B30.9 for special applications.



WIRE ROPE THIMBLES

Used in conjunction with wire rope clips, CM Wire Rope Thimbles are made specifically for wire rope turnback to form a cable loop. Available in sizes to fit a maximum wire rope diameter of 1-1/2 inch and manufactured of hot rolled steel in accordance with Fed. Spec. FF-T-276.



MID-GRIP WIRE ROPE CLIPS

The CM Mid-Grip is designed for applications in the scaffolding industry. The redesigned mid-grip features a hexagon bolt head that fits securely into a forged, hex-shaped socket that prevents spinning even after repeated use and re-torquing. It has precise threading on the nut and bolt to ensure tight alignment. This design also allows for full arc wrench swing, making installation and retightening quick and easy. The mid-grip meets FF-C-450 performance requirements and comes with a smooth, mechanical galvanized finish for protection in harsh environments.



STEEL SWAGING SLEEVES (FLEMISH EYE)

These carbon-steel, seamless sleeves are used to securely anchor the strand ends of wire rope formed into a Flemish eye. CM Swaging Sleeves are zinc plated for rust resistance and color coded in smaller sizes for inventory control purposes and easy swaging verification. Available in sizes for 1/4 to 2-1/4 inch rope diameter.



STEEL SWAGE BUTTONS

Steel Swage Buttons are typically used as wire rope terminations, but may be used at any rope location. Designed for use with 6 x 7, 6 x 9, or 6 x 37 wire rope of IPS or XIP (EIP), RRL, FC, or IWRC configurations. Made of specially selected low-carbon steel, CM steel swage buttons are available in sizes for 1/4 to 1-1/2 inch rope diameter.



BUNDLING CLIPS

The CM Bundling Clip is built for harsh environments and demanding applications of the oil and gas industry. They are user-friendly with an easy-to-assemble, U-shaped design, allowing for fewer dropped or lost parts. The CM bundling clip design eliminates shear points and damage to wire rope, and prevents the choker from going slack and the load spreading after tension is released from the sling.



PIGGYBACK® WEDGE SOCKET CLIPS

The CM PiggyBack® Wedge Socket Clip is the only clip on the market specifically designed for securing the dead end of a wire rope on a wedge socket. Its revolutionary dual saddle design attaches quickly and easily to prevent crimping and damage to the live end of wire rope and eliminates the need for a short rope piece or loop on dead end. Properly secured dead end will not snag/foul and shear off at wedge socket. Available in 3/8 inch to 1-1/2 inch sizes. Hot dip galvanized with orange painted U-bolts and drop forged saddles.



SWAGE SOCKETS (OPEN & CLOSED)

These forged, fine-grain, carbon-steel swaging sockets are used as wire rope terminations. For use with 6 x 19 or 6 x 37 IWRC regular lay rope. Available in sizes for 1/4 to 1-3/4 inch rope diameter.



SWIVELS

Swivels are used for eliminating twists in rope and chain load lines. CM swivels are forged of carbon steel and hot dip galvanized. They meet performance requirements of RR-C-271, Type VII, Class 2, and are available in 3/4 and 1 inch nominal diameter sizes.



TURNBUCKLES

Turnbuckles provide easy means for tensioning, loosening and removing chain and rope load lines. CM Turnbuckles are forged then hot dip galvanized. All meet Federal Specification FF-T-791b Type 1, Form 1. Turnbuckles are available in eye and eye, hook and hook, hook and eye, eye and jaw, and jaw and jaw styles in sizes from 1/4 to 1-1/2 inch thread diameter.

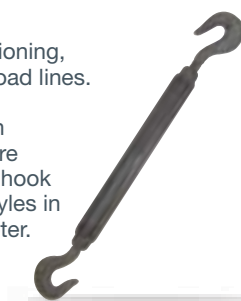

LOAD SECUREMENT OVERVIEW

Load securement, also known as tie-down or load binding, can be a complex rigging application that often has strict specifications and regulations. CM offers a number of load securement products, including load binders, binder chain assemblies and tie-down hooks, that help you safely secure loads for transport as well as meet federal, state and Commercial Vehicle Safety Alliance (CVSA) regulations. Our load securement products comply with the National Association of Chain Manufacturers (NACM) Welded Steel Chain specifications and the American Society of Testing and Materials (ASTM) specifications. They are also designed to meet applicable Federal Motor Carrier Safety Administration (FMCSA) rules for cargo securement.

LOAD BINDERS

Load Binders are typically used to take up slack and apply tension to a tie-down system. Designed primarily for use with graded chains, they can also be used with cable, steel strap or fiber webbing to secure loads in a variety of applications. Load binders are available in two general configurations: **Lever-type** (over the center) and **Ratchet-type**. CM load binders are rated by working load limit and are provided with the appropriate hooks to accept the chain size and grade consistent with the binder's load rating.

LEVER-TYPE LOAD BINDERS

Lever-Type, or over-the-center, Binders utilize mechanical advantage to reduce the manpower required to secure a load. When using a lever-type load binder, tension can be applied and released quickly. Operators should use caution, as the handle may whip suddenly. When securement is complete, the lever stores in line with load.

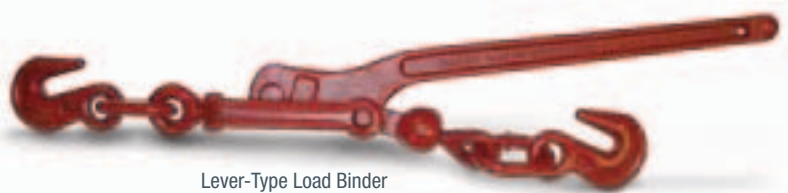

Lever-Type Load Binder

RATCHET-TYPE LOAD BINDERS

Ratchet Binders utilize a screw or rotating motion to tighten and secure loads. Ratchet binders tighten slower but are easier to operate than lever-type load binders. They also do not require a handle to lock in place to ensure the binder stays tightened. Available with a variety of end fittings.



Ratchet-Type Load Binder

RIVER RATCHETS

River Ratchets operate similar to ratchet-type load binders, but have a substantially larger capacity. Typically, these ratchets are used to gang barges utilizing a gravity-operated, double-pawl design. River ratchets are available with a variety of attachments.

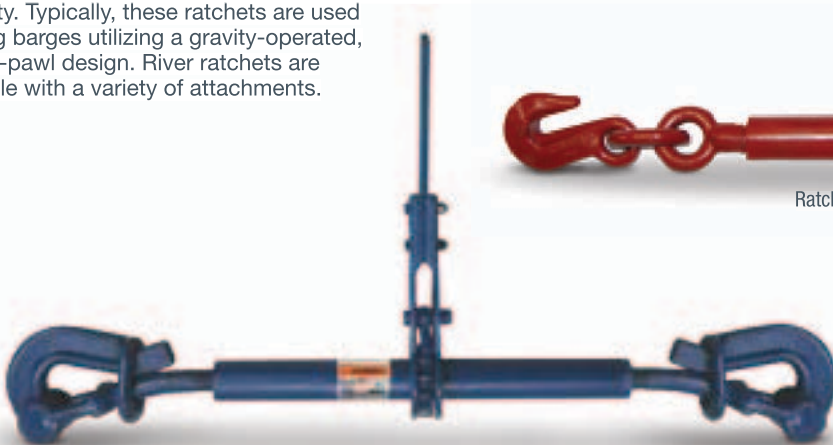

River Ratchet

BINDER CHAIN ASSEMBLIES

Binder Chain Assemblies are most often used to secure loads to trucks, rail cars or truck trailers. They typically consist of a length of chain ranging from 6 to 26 feet in length with a grab hook at each end. The grab hook can be clevis style or eye style depending on your application. Standard binder chain assemblies are available in Grades 30, 43, 70, 80 and 100.

CLEVIS HOOK ASSEMBLIES

Clevis Hook Assemblies are available in various lengths and grades, depending on your application. CM offers different dimensional binder chains as part of these assemblies, including short link chain, which provides you with easier take up and better cornering, or traditional pitch chain that gives you less pounds per foot in weight.

EYE HOOK ASSEMBLIES

Similar to CM clevis hook assemblies, Eye Hook Assemblies prevent the loss or theft of hooks from the binder chain. Eye hook assemblies are offered with short or traditional pitch chain.

TIE-DOWN HOOKS

Tie-down Hooks come in various grades, designs and installation types. Both clevis and eye style tie-down hooks are high-quality forgings made here in the U.S. The clevis style hook is most popular because of the ability to self-install with limited need for tools. The eye style hook is typically factory installed during a welding process, but is beneficial in that it protects against loss or theft of the hook.



GRADE 30 & 43 HIGH TEST HOOKS

Grade 30 and 43 Hooks are dual rated, allowing the operator to use with both grades of chain. Grade 30 and 43 hooks are available in both clevis and eye types in either slip or grab styles and should be selected based on the type and grade of chain being used in the application. Available in self-colored or zinc-plated finishes.



GRADE 70 TRANSPORT HOOKS

Transport Hooks are available in both clevis and eye types in either slip or grab styles. These hooks are rated for use with Grade 70 chain and are available in self-colored or yellow chromate finishes.



GRADE 80 HEAVY-DUTY HOOKS

Grade 80 Hooks available in both clevis and eye types in either slip or grab styles and are rated for use with Grade 80 chain. Grade 80 clevis-style hooks are marked "T80" and should not be used for overhead lifting because of their pin and cotter design. These hooks are available in self-colored or orange powder-coated finishes.



WARNING

Improper use or care of load binders can result in bodily injury or property damage.

To avoid injury:

- ▲ Never exceed working load limit.
- ▲ Always inspect binder before use for wear, damage, and elongation.
- ▲ Do not use cheater bar or handle extension.
- ▲ Do not operate load binder while anyone is on the load.
- ▲ Release load on lever type binders with extreme care. Make sure everyone is clear of the load. Handle may whip suddenly.

PLATE CLAMPS OVERVIEW

Plate clamps are most often used to lift and move steel plates from both horizontal and vertical positions. CM Plate Clamps operate through a self-actuating spring that engages when the clamp is attached to a plate. When using plate clamps, it is important that the load weighs no less than 20 percent of the clamp's working load limit. When lifting stainless steel, materials over 300 HRB in hardness or when leaving marks on the material is undesirable, special clamps are available.

Plate Clamps are available in universal, hinged, and horizontal styles. A few examples of plate clamps include:



Universal Plate Clamps



Hinged Plate Clamps



Gentle Grip Clamps



Girder Clamps



Horizontal Clamps



Container Lugs

CADY® LIFTERS OVERVIEW

Below-the-hook lifters are specialized devices which attach, hold, protect, control and orient a load in the material handling process. These products consist of lifting beams, spreader beams, roll and coil lifters, pallet lifters, sheet lifters and a variety of other specialized lifting tools.

Cady® Lifters can be categorized into three types:

- **Supporting**
Carries the load on a bearing surface(s)
- **Indentation**
Grip force indents the sides of the load
- **Friction**
Applies sufficient coefficient of friction to support the load

In addition to many standard available models, Cady Lifters can be custom engineered to meet specific application requirements.





CHAIN & SLING INSPECTION, USE & CARE

Warnings 25

CHAIN & CHAIN SLINGS

General Inspection 26

In-Depth Inspection 26-28

General Care & Use 28

CHAIN

Selection & Working Load Limits 29

CHAIN SLINGS

Selection & Working Load Limits 30-32

WIRE ROPE SLINGS

Working Load Limits 34-35

SYNTHETIC SLINGS

Web Sling Working Load Limits 36

Round Sling Working Load Limits 37

TRAINING

Rigging Training 38

CMCO University™ 39

Columbus McKinnon Corporation assumes no responsibility for the misuse or misapplication of any of its products. Products are provided with the express understanding that the purchaser and/or user are thoroughly familiar with the correct application and proper use of such rigging products. Warnings and definitions are provided as an aid to the user in understanding the correct application and proper use of the product. Chain and rigging products should not be used by personnel unless they are properly trained and/or certified for that application

For instant access to valuable rigging and hoisting application information, check out our portable Rigging Guide. Small enough to fit in your pocket or toolbox, the CM Rigging Guide is full of the tools and specifications that every rigger should have, such as:

- Working Load Limits for Shackles, Hooks and Slings
- Easy to Understand Visual References for Proper Rigging
- Load Angle Charts
- Leverage, Tension & Pull Force Calculators
- And Much More

For more information or to order your copies of the CM Rigging Guides, contact your Columbus McKinnon representative.



Literature code: CMRG

⚠ WARNING

The use of all mechanical equipment presents the possibility of personal injury or property damage if the equipment is not properly installed, operated or maintained. Before using CM chain, accessories, load binders, lifting clamps, or other hardware, users should become thoroughly familiar with application, installation, operation and maintenance requirements.

IMPROPER USE OR CARE OF CHAIN & RIGGING ATTACHMENTS CAN RESULT IN BODILY INJURY OR PROPERTY DAMAGE. TO AVOID INJURY:

CHAIN

- ▲ Do not exceed the working load limit. Refer to the catalog for product-specific load limit data.
- ▲ Always inspect chain before use. Do not use chains with links that are bent, elongated, nicked, or excessively worn or damaged.
- ▲ Do not impact load or jerk chain. Apply load slowly. Rapid load application can cause overloading.
- ▲ Use only alloy chain and attachments for overhead lifting (Grade 80 or 100).
- ▲ Do not use twisted, knotted or kinked chain. Load should be applied in a straight line fashion.
- ▲ Select the proper grade and size chain for the application.
- ▲ Select attachments such as hooks to match the grade, size, and working load limit of the chain.
- ▲ Be aware of the environment where chain and hardware are being used. Extreme temperatures and corrosive media can affect the working load limit and life of the chain and hardware.
- ▲ Full chain inspection and use information can be found on pages 26 through 28. Refer to product manuals for complete warning and use information if applicable.

RIGGING ATTACHMENTS

- ▲ Do not exceed the working load limit. Refer to the catalog for product-specific load limit data.
- ▲ Always inspect rigging attachments before use. Do not use equipment with components that are bent, elongated, nicked, or excessively worn or damaged.
- ▲ Center the load in hooks, shackles, rings and other such equipment. Use spacers on bolts and pins as necessary to maintain center loading.
- ▲ Do not move unbalanced loads.
- ▲ Do not tip load or use attachments in any manner for which they were not intended.
- ▲ Do not shock or dynamic load. Rapid load application can cause overloading.
- ▲ Do not apply load to latches. Latches are to retain slack slings.
- ▲ Select attachments to match the grade, size, and working load limit of the chain.
- ▲ Ensure that nuts, bolts pins and other fasteners are tightened and secured.
- ▲ Do not use mechanical coupling links to repair alloy chains used for overhead lifting.
- ▲ Size the master link or ring to fit properly over the crane hook.
- ▲ Do not replace pins or bolts with other than original equipment parts.
- ▲ Wire rope clips are not recommended for fabricating slings for overhead lifting. Reference ASME B30.9 for special applications.
- ▲ Use wire rope clips in conjunction with wire rope thimbles.
- ▲ When using shoulder eyebolts, always apply load in the plane of the eye.
- ▲ When using shoulder eyebolts, make sure shoulder is fully seated.
- ▲ When using hoist rings, verify full 360 degree rotation and 180 degree pivot and re-torque periodically.
- ▲ When using load binders, do not use a cheater bar or handle extension.
- ▲ Do not operate a load binder while anyone is on the load.
- ▲ Release lever type load binders with extreme care. Make sure everyone is clear of the handle as it may whip suddenly.
- ▲ Make sure plate clamps are functional and capable of lifting the load before use.
- ▲ Product-specific warning and hazard information can be found throughout this catalog. Refer to product manuals for complete warning and use information.

DISCLAIMER

The manufacturer does not accept any liability for damages which result from the product being used in excess of the working load limit or from abuse or misuse.

Always refer to applicable industry standards, specifications and regulations such as OSHA and ASME. Always adhere to any manufacturers recommendations.

CHAIN & SLING INSPECTION GUIDE

To ensure long life and continued strength of CM chain, it is important that the product is properly used, inspected and maintained. This section provides details on chain and chain sling inspection methods as well as the proper use and care of chain or slings. Following these guidelines will ensure safe and long use of CM products.

In addition to what is provided in this section, ASME and OSHA have specific regulations related to chain and chain sling use. For detailed information, refer to ASME B30.9 and OSHA 1910.184

GENERAL CHAIN & SLING INSPECTION

It is important to inspect chain and chain slings regularly and to keep a record of all chain inspections. Follow the steps below when developing your inspection requirements and tracking system. CM will supply chain and sling record cards or sheets as requested.

Before inspection, clean the chain so that marks, nicks, wear and other defects can be seen. Use a non-acid/non-caustic solvent. Each chain link and sling component should be individually inspected for the conditions noted below.

1. Excessive wear and corrosion at chain and attachment bearing points. Refer to page 27, "Wear Allowance chart for Herc-Alloy 800® and 1000 chain". The table should also be used as a guide when inspecting coupling links.
2. Nicks or gouges
3. Stretch or link elongation
4. Twists or bends
5. Distorted or damaged links, master links, coupling links or attachments, especially spread in throat opening of hooks. (Refer to other sections in this catalog for inspection guidelines regarding distortion and wear of hooks, master links and Hammerloks®.)

When inspecting chain slings specifically, it's important to note that damage is most likely to occur in the lower portion of a sling. Therefore, particular attention should be given to those sections.

Each link or component having any condition listed above is to be marked with paint to clearly indicate rejection. Since any of the above noted conditions can affect chain performance and/or reduce the chain strength, chains and chain slings containing any of the conditions should be removed from service. A qualified person should examine the chain, assess the damage, and make a decision on whether or not repair is necessary before returning it to service. Extensively damaged chain should be scrapped.

Because of its use in critical lifting applications, repair of alloy chain should only be done by an authorized CM chain sling repair station. Nicks and gouges can be removed from the chain by a qualified person as instructed in the "Nicks and Gouges" section on this page.

IN-DEPTH CHAIN & SLING INSPECTION

Since Grade 80 and 100 chains are used for overhead lifting, and used frequently as part of a sling component, a more detailed and in-depth inspection is necessary.

TWISTING & BENDING

Twisted and bent links are relatively easy to recognize and affect chain performance significantly. Twisting and bending of links results from use of slings around sharp corners without padding, use of links with grab hooks under certain adverse conditions, and from loading of chain that is twisted, knotted, or kinked. (Refer to Hook Section for a more information on grab hooks.)

Consider that chain is evaluated by applying loads in a pure tensile link end-to-link-end fashion and rated accordingly. Bent or twisted links alter this normal loading pattern significantly and thus alter inner link stresses accordingly. For this reason all chain containing twisted or bent links must be removed from service.

NICKS & GOUGES

The outsides of links are exposed to contact with foreign objects that can cause damage. Nicks and gouges frequently occur on the sides. Therefore, they usually are located on surfaces under compressive stress and their potentially harmful effects are reduced.

The unique geometry of a chain link tends to protect tensile stress areas against damage from external causes. Figure 1 shows that these tensile stress areas are on the outside of the link body at the link ends where they are shielded against most damage by the presence of interconnected links. Tensile stress areas are located also on the insides of the straight barrels, but these surfaces are similarly sheltered by their location. However, gouges cause localized increases in the link stress. They can be harmful if they are located in areas of tensile stress and particularly so if they are perpendicular to the direction of stress. Refer to Figure 1.

Figure 2 shows nicks of varying degrees of severity. Reading clockwise, at three o'clock there is a longitudinal mark in a compressive stress area. Since it is longitudinal and located in a compressive stress area, its effect is mitigated, but good workmanship calls for it to be ground out. At about five o'clock there is a deep



Figure 1 : Pattern of tensile and compression stress shown by a link under load.



Figure 2 : Location of nicks, gouges, and notches will dictate their severity.

transverse nick in an area of high shear stress. A similar nick is located at six o'clock in the zone of maximum tensile stress. Both of these can create a potentially dangerous escalation of the local stress and must be filed out. A nick that was located at eight o'clock has been filed out properly. Although the final cross section is smaller, the link is stronger because the stress riser effect of the notch has been removed. The remaining cross section can now be evaluated for acceptability by measuring it and applying the criterion for worn chain. See "Wear Allowances Table" below.

WEAR & CORROSION

Corrosion results in a reduction of link cross-section and can be detected using the same criteria as that for wear. Wear can occur in any portion of a link that is subject to rubbing contact with another surface.

The natural shape of chain confines wear, for practical considerations, to only 2 areas. These are, in order of importance, (a) at the bearing points of interlink contact, and (b) on the outside surfaces of the straight side barrels which may be abraded from dragging chains along hard surfaces or from under loads. Figure 3 illustrates the condition of interlink wear and shows how to inspect for it. Notice how easily such wear can be detected by collapsing the chain to separate each link from its neighbors.



Figure 3 : Inspection for interlink wear can be detected easily by collapsing the chain.

When wear is observed, the next step is to determine how severe the damage is and if the chain can still be safely used. To determine this, make a caliper measurement across the worn section of chain and compare it to the minimum allowable dimension for that chain. See the chart below for minimum section dimensions or wear allowances for Columbus McKinnon Grade 80 and 100 Chain.

WEAR ALLOWANCES OF HERC-ALLOY 800® & 1000 CHAIN*

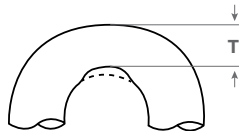

Measure cross section at link ends to determine wear. If chain is worn to less than the minimum allowable thickness, remove from service.

Note: For sizes not listed, the Minimum Allowable Thickness can be calculated as 87% of the original material diameter.

* May also be used as a guide for CM Grade 63 Alloy Chain

Chain Size		Minimum Allowable Thickness (T)	
(in.)	(mm.)	(in.)	(mm.)
7/32	5.5	0.189	4.8
9/32	7.0	0.239	6.1
3/8	10.0	0.342	8.7
1/2	13.0	0.443	11.3
5/8	16.0	0.546	13.9
3/4	20.0	0.687	17.5
7/8	22.0	0.750	19.1
1	26.0	0.887	22.5
1-1/4	32.0	1.091	27.7

CHAIN INSPECTION

The strength of welded link chain is relatively unaffected by a moderate degree of wear. The reason for this will be understood better if we take a brief look at the pattern of stress distribution in a chain link supporting an axial tension load.

Figure 4 shows in exaggerated manner the change in shape that takes place under such loading conditions. Note that the ends move farther apart while the side barrels move closer together. If the link were in a neutral stress condition to start with, the loaded link shown in broken outline would contain stresses of compression and tension. This is clearly illustrated in Figure 5 showing an inflated inner tube which is sustaining a load in the manner of a chain link. The wrinkled sections clearly indicate the areas of compression.

Figure 1 on the previous page shows the location of these stresses in a chain link. Tensile stresses are represented by arrows pointing away from each other, and compression stresses are depicted by arrows pointing toward each other. Notice that the bending, which occurs when link elongation takes place, induces compressive stresses at the interlink bearing surfaces and on the outside surfaces of the side barrels. Therefore, we see that these surfaces, which are the potential wear areas, play a lesser role in supporting the tensile load on the chain. For that reason, some amount of interlink or side barrel wear can occur before chain tensile strength decreases significantly.

Corrosion will generally be exhibited in the form of rusting and pitting. Rusted chain with a smooth unpitted surface finish can remain in service provided that the minimal section dimensions or wear allowances published by the chain manufacturer are complied with. However, visually discernible pitting should be carefully inspected using the technique outlined for "Nicks and Gouges", paying particular attention to areas of tensile stress.

Alloy steel sling chain typically exhibits well over 20% elongation before rupture. The combination of elongation and high strength provides energy absorption capacity. However, high elongation or stretch, by itself, is not an adequate indicator of shock resistance or general chain quality and should not be relied upon by riggers to provide advance warning of serious overloading and impending failure. Overloading must be prevented before it happens by selection of the proper type and size of slings.

STRETCH & CHAIN ELONGATION

A visual link-by-link inspection is the best way to detect dangerously stretched links. The smallest sign of binding or loss of clearance at the juncture points of a link indicates a collapse in the links' sides due to stretch. Any amount of stretch indicates overloading, and the chain should be removed from service.

Note that a significant degree of stretch in a few individual links may be hidden by the apparent acceptable length gage of the overall chain. This highlights the importance of link-by-link inspection.

There is no short-cut method that will disclose all types of chain damage. Safety can only be achieved through proper inspection procedures. There is no adequate substitute for careful link-by-link scrutiny.



Figure 4 : Changes in link shape that take place under axial tension loading.



Figure 5 : The tube "under load" shows wrinkles in the areas of compression.

OSHA CHAIN SLING INSPECTION

Since first published in final form on July 27, 1975, the OSHA Chain Sling Inspection section remains little changed. Specifically, the applicable sections of Code of Federal Regulations (29 CFR 1910.184) are quoted as follows:

- (d) **INSPECTIONS** – Each day before being used, the sling and all fastenings and attachments shall be inspected for damage or defects by a competent person designated by the employer. Additional inspections shall be performed during sling use where service conditions warrant. Damaged or defective slings shall be immediately removed from service.

(e) **ALLOY STEEL CHAIN SLINGS**

(3) Inspections (i) in addition to the inspection required by paragraph (d) of this section, a thorough periodic inspection of alloy steel chain steel slings in use shall be made on a regular basis, to be determined on the basis of (A) frequency of slings in use; (B) severity of service conditions; (C) nature of lifts being made; and (D) experience gained on the service life of slings used in similar circumstances. Such inspections shall in no event be at intervals greater than once every 12 months.

- (ii) The employer shall make and maintain a record of the most recent month in which each alloy steel chain sling was thoroughly inspected, and shall make such record available for examination.
- (iii) The thorough inspection of alloy steel chain slings shall be performed by a competent person designated by the employer, and shall include a thorough inspection for wear, defective welds, deformation and increase in length. Where such defects or deterioration are present, the sling shall be immediately removed from service.”

Note that while the requirements under (d) for daily inspections are not explicit as to scope or maintenance of records, it is possible that individual OSHA inspectors may have different views on conformity. However, the minimum 12-month interval inspections required under (e) call for thorough inspection and written records. It is this thorough type inspection which the procedures recommended in this catalog and in CMCO Training Classes are designed to satisfy. Of course, the fundamentals are equally applicable to the more cursory daily inspections made by the riggers, users, or inspectors (a competent person) and will enable them to fulfill their responsibility efficiently.

CHAIN & SLING GENERAL CARE & USE

PROPER CARE

Chain and chain slings require careful storage and regular maintenance.

1. Store chain and chain slings on an “A” frame in a clean, dry place.
2. Avoid exposure to corrosive mediums. Oil chain before prolonged storage.
3. Never alter the thermal treatment of chain or chain sling components by heating.
4. Do not plate or change surface finish of chain or components. Contact Columbus McKinnon for special requirements.

PROPER USE

To protect both operators and materials, observe these precautions when using chain slings.

1. Before use, inspect chain and attachments following the inspection instructions on pages 26 through 28.
2. Do not exceed working load limit as indicated on the chain or chain sling identification tag. Any of the following factors can reduce the strength of the chain or sling and cause failure:
 - Rapid load application can produce dangerous overloading.
 - Variation in the angle of the load to the sling. As the angle decreases, the working load of the sling will increase. (For more information, see page 30)
 - Twisting, knotting or kinking subjects links to unusual loading, decreasing the working load of the sling.
 - Using slings for purposes other than those for which slings are intended can reduce the working load of the sling.
3. Free chain of all twists, knots and kinks.
4. Center load in hook(s). Hook latches must not support load.
5. Avoid sudden jerks when lifting and lowering.
6. Balance all loads to avoid tipping.
7. Use pads around sharp corners.
8. Do not drop load on chains.
9. Match the size and working load limit of attachments such as hooks and rings to the size and working load limit of the chain.
10. Use only alloy chain and attachments for overhead lifting.

CHAIN SELECTION & WORKING LOAD LIMITS

Understanding the working load limit of chain and chain slings is critical when choosing the best option for your application. This section details the working load limits of chain and chain slings, as well as explains how the working load limit is affected by temperature and lifting angles.

GENERAL CHAIN WORKING LOAD LIMITS

Below is a chart of the working load limits of Grade 30 through Grade 100 chain.

Trade Diameter (in)	NACM Working Load Limits (lbs.)				
	Grade 30	Grade 43	Grade 70	Grade 80	Grade 100
1/8	400	—	—	—	—
3/16	800	—	—	2,100	2,700
7/32	—	—	—	2,100	2,700
1/4	1,300	2,600	3,150	—	—
9/32	—	—	—	3,500	4,300
5/16	1,900	3,900	4,700	4,500	5,700
3/8	2,650	5,400	6,600	7,100	8,800
7/16	3,700	7,200	8,750	—	—
1/2	4,500	9,200	11,300	12,000	15,000
5/8	6,900	13,000	15,800	18,100	22,600
3/4	10,600	20,200	24,700	28,300	35,300
7/8	12,800	24,500	—	34,200	42,700
1	17,900	—	—	47,700	—
1-1/4	—	—	—	72,300	—

Only Grade 80 or Grade 100 should be used for overhead lifting.

CHAIN WORKING LOAD LIMITS UNDER EXTREME TEMPERATURE CONDITIONS

When chain is subject to extreme temperatures, working load limits should be reduced as indicated in the chart below.

Temperature		Grade 80	
(°F)	(°C)	Reduction of Working Load Limit WHILE AT Temperature	Reduction of Working Load Limit AFTER EXPOSURE to Temperature
Below 400	Below 204	NONE	NONE
400	204	10%	NONE
500	260	15%	NONE
600	316	20%	5%
700	371	30%	10%
800	427	40%	15%
900	482	50%	20%
1,000	538	60%	25%
Over 1,000	Over 538	OSHA 1910.184 requires all slings heated to temperatures over 1,000° F to be removed from service	
Temperature		Grade 100	
Below 400	Below 204	NONE	NONE
400	204	15%	NONE
500	260	25%	5%
600	316	30%	15%
700	371	40%	20%
800	427	50%	25%
900	482	60%	30%
1,000	538	70%	35%
Over 1,000	Over 538	OSHA 1910.184 requires all slings heated to temperatures over 1,000° F to be removed from service	

SLING SELECTION & WORKING LOAD LIMITS

HOW TO SELECT THE PROPER CHAIN SLING

1. Determine the weight and configuration of the load(s) to be lifted.
2. Determine the type of chain sling required, according to weight and configuration.
3. Determine the size of the body chain according to the working load limits.
Be sure to take into consideration the effect of the required angle (see diagram below).
4. Determine the reach required to give the desired angle. This is measured from the upper bearing surface of the master link to the bearing surface of the lower attachment.
5. Know share of load on pick points and location of center of gravity.

WHAT DETERMINES A SLING'S WORKING LOAD LIMIT

The working load limit of slings is based on the following factors:

- Type of hitch
- Material strength
- Design factor
- Diameter of curvature (D/d)
- Angle of loading

For specific information on the working load limit of various slings, see page 31.

When using a sling, loads are frequently lifted at an angle. This can affect their working load limits. In the diagram to the right, the percentages shown represent the maximum working load limit of the sling when used at the designated angle.

For example:

One 3/8" Grade 80 double sling used at 90° would have a working load limit of 2 times the working load of a 3/8" Grade 80 single or 2 x 7, 100 lbs. = 14,200 lbs.

The same double sling used at 35° would have a maximum working load limit of 57% of 14,200 lbs. or .57 x 14,200 lbs. = 8,094 lbs.

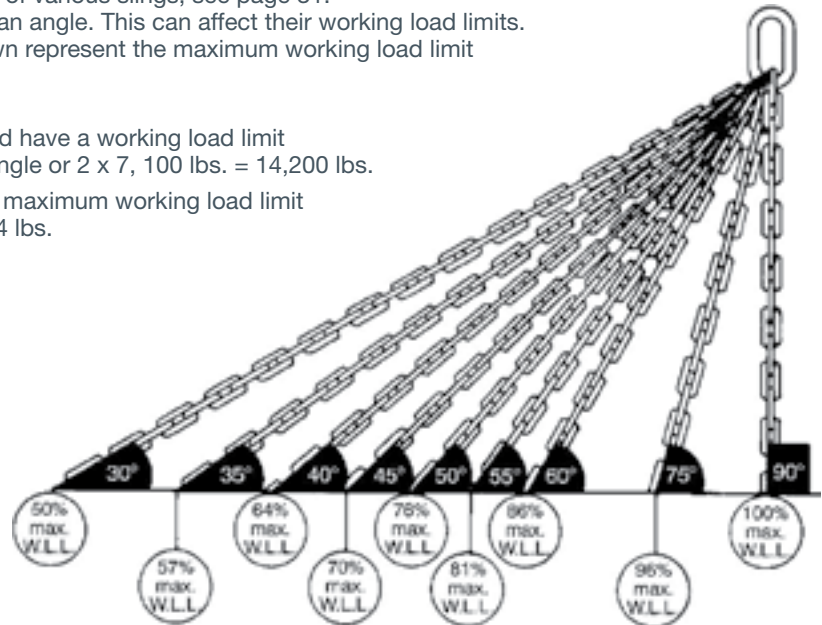

WARNING

Improper use, application or care of slings can result in injury or property damage. To avoid injury or damage:

- ▲ Never exceed the working load limit. Confirm the working load limit of all sling components are of equal or greater strength.
- ▲ Always inspect slings before use for wear, damage, and elongation. Refer to ANSI B30.9 and OSHA regulations.
- ▲ Do not impact or shock load. Apply load slowly.
- ▲ Protect from corrosion and high temperatures.
- ▲ Use with alloy chain for overhead lifting.
- ▲ Do not use twisted, knotted or kinked chain.

American National Standard ANSI B30.9, the National Association of Chain Manufacturers, and the Occupational Safety & Health Administration recommend only the use of alloy steel chain for overhead lifting i.e. for sling chain. Slings may be constructed by the user using CM Grades 80 or 100 Chain, CM alloy attachments and CM mechanical coupling links (Hammerloks®). Columbus McKinnon uses Grade 80 or 100 chain and alloy steel welded coupling links instead of Hammerloks for construction of welded slings. Refer to this catalog's product overview sections for "Chain," "Hooks" and "Rings and Links" for detailed information on components which may be used in the construction of slings.

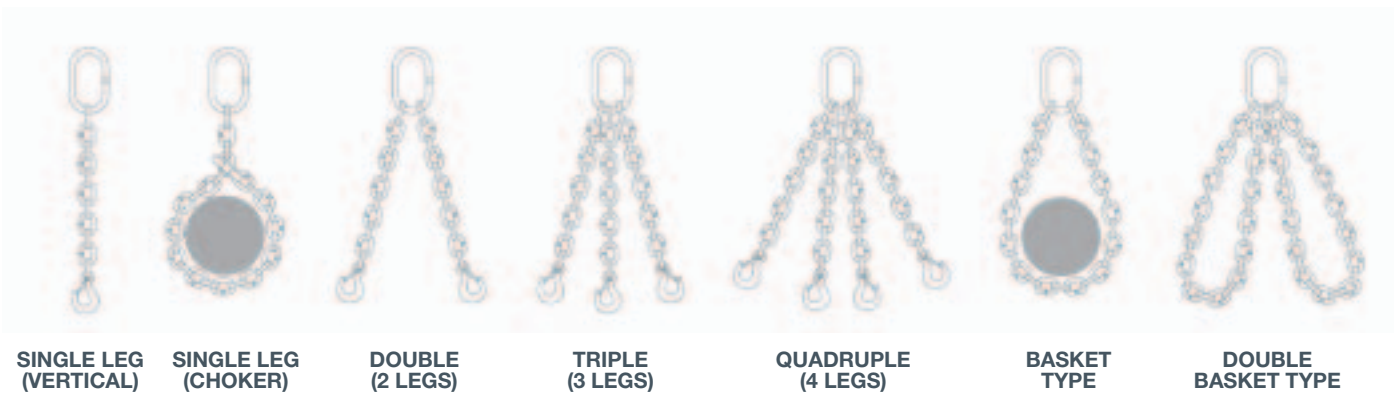

SINGLE LEG (VERTICAL) **SINGLE LEG (CHOKER)** **DOUBLE (2 LEGS)** **TRIPLE (3 LEGS)** **QUADRUPLE (4 LEGS)** **BASKET TYPE** **DOUBLE BASKET TYPE**

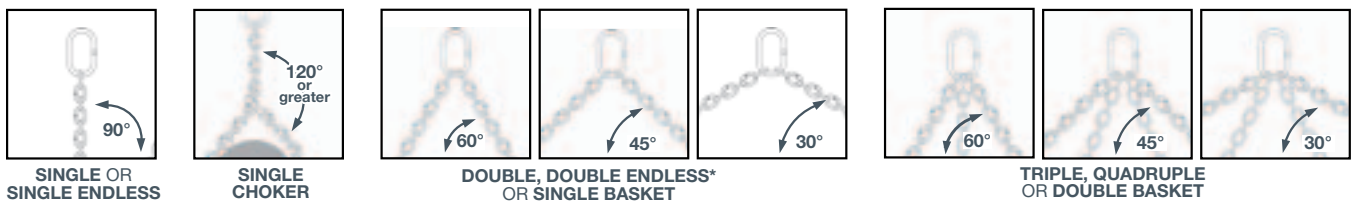

SINGLE OR SINGLE ENDLESS **SINGLE CHOKER** **DOUBLE, DOUBLE ENDLESS* OR SINGLE BASKET** **TRIPLE, QUADRUPLE OR DOUBLE BASKET**

Chain Size (in.)	Working Load Limits for Sling Types Show Above														
	Single (1 leg)	Single Choker	Double (2 legs)			Triple (3 legs)			Quad (4 legs)			Single Basket	Double Basket	Single Endless	Double Endless*
	90° (lbs.)	90° (lbs.)	60° (lbs.)	45° (lbs.)	30° (lbs.)	60° (lbs.)	45° (lbs.)	30° (lbs.)	60° (lbs.)	45° (lbs.)	30° (lbs.)	60° (lbs.)	60° (lbs.)	90° (lbs.)	60° (lbs.)
GRADE 80 CHAIN SLINGS															
7/32	2,100	1,700	3,600	3,000	2,100	5,500	4,400	3,200	5,500	4,400	3,200	3,600	5,500	2,100	3,600
9/32	3,500	2,800	6,100	4,900	3,500	9,100	7,400	5,200	9,100	7,400	5,200	6,100	9,100	3,500	6,100
5/16	4,500	3,600	7,800	6,400	4,500	11,700	9,500	6,800	11,700	9,500	6,800	7,800	11,700	4,500	7,800
3/8	7,100	5,700	12,300	10,000	7,100	18,400	15,100	10,600	18,400	15,100	10,600	12,300	18,400	7,100	12,300
1/2	12,000	9,600	20,800	17,000	12,000	31,200	25,500	18,000	31,200	25,500	18,000	20,800	31,200	12,000	20,800
5/8	18,100	14,500	31,300	25,600	18,100	47,000	38,400	27,100	47,000	38,400	27,100	31,300	47,000	18,100	31,300
3/4	28,300	22,600	49,000	40,000	28,300	73,500	60,000	42,400	73,500	60,000	42,400	49,000	73,500	28,300	49,000
7/8	34,200	27,400	59,200	48,400	34,200	88,900	72,500	51,300	88,900	72,500	51,300	59,200	88,900	34,200	59,200
1	47,700	38,200	82,600	67,400	47,700	123,900	101,200	71,500	123,900	101,200	71,500	82,600	123,900	47,700	82,600
1-1/4	72,300	57,800	125,200	102,200	72,300	187,800	153,400	108,400	187,800	153,400	108,400	125,200	187,800	72,300	125,200
GRADE 100 CHAIN SLINGS															
7/32	2,700	2,100	4,700	3,800	2,700	7,000	5,700	4,000	7,000	5,700	4,000	4,700	7,000	2,700	4,700
9/32	4,300	3,500	7,400	6,100	4,300	11,200	9,100	6,400	11,200	9,100	6,400	7,400	11,200	4,300	7,400
5/16	5,700	4,500	9,900	8,100	5,700	14,800	12,100	8,500	14,800	12,100	8,500	9,900	14,800	5,700	9,900
3/8	8,800	7,100	15,200	12,400	8,800	22,900	18,700	13,200	22,900	18,700	13,200	15,200	22,900	8,800	15,200
1/2	15,000	12,000	26,000	21,200	15,000	39,000	31,800	22,500	39,000	31,800	22,500	26,000	39,000	15,000	26,000
5/8	22,600	18,100	39,100	32,000	22,600	58,700	47,900	33,900	58,700	47,900	33,900	39,100	58,700	22,600	39,100
3/4	35,300	28,300	61,100	49,900	35,300	91,700	74,900	53,000	91,700	74,900	53,000	61,100	91,700	35,300	61,100
7/8	42,700	34,200	74,000	60,400	42,700	110,900	90,600	64,000	110,900	90,600	64,000	74,000	110,900	42,700	74,000

Do not use double endless slings at angles less than 60°. Based on OSHA and ASME B30.9 standards – Always use the sling tag for the working load limits. Factory assembled HERC-ALLOY 800® or HERC-ALLOY® 1000 chain slings have the "HERC-ALLOY 800®" or "HERC-ALLOY® 1000" trademark on serial number tags and on the sling hooks. On chain sizes 7/32" through 1-1/4" (7/32" through 3/4" for HA1000), links are embossed with grade symbol "HA-800" or "HA-1000". This data applies to Herc-Alloy 800® & Herc-Alloy® 1000 chain only. Ratings apply to both factory assembled slings and slings assembled with Hammerlok® coupling links, Clevlok® hooks, or Lodelok® hooks.

SLING SELECTION & WORKING LOAD LIMITS

SLING SAFETY: LOADING, ANGLES & CHOKING

When choosing a rigging configuration, specifically a sling, for your lifting application you need to be aware of the load that will be imposed on the sling and select the proper size chain for the job.

All chain manufacturers publish working load ratings for single chain slings in straight tension and for double, triple and quad-branch slings when used at various angles. Figure 1 illustrates how such tables would rate the capacity of a commercial Grade 80 sling made from 5/8 inch alloy chain. (See a full working load limit chart on page 31)

However, it is often overlooked that a single strand sling may be rigged to be a double branch sling and as such would create sharp loading angles. This is the reason that chain damage and overloading are usually localized in the lower portion of the sling near the load. Figure 2 illustrates this issue.

OVERLOAD EXAMPLE:

On the left side of Figure 2, we see a double branch sling used in the conventional manner. Unfortunately, such idealized rigging, where sling hooks are neatly seated in eyebolts or clevises and all portions of the chain are in straight tension, is not always possible. A more typical and frequent rigging arrangement is shown in the illustration on the right of Figure 2.

In the right-side image of the diagram, a single sling equipped with a hook is being used in a choke hitch format. Above the crotch, the chain tension is 9 tons – the same tension as shown in the illustration on the left. Let us assume that 9 tons is an acceptable load for this size chain in straight tension. In many cases, one would assume that the load is rigged correctly and the load can be safely moved, but that is not the case. If you look below the hook, you see a double branched sling. Also, typical of the flat branch angles in tight choke hitches, the legs are at angles of only 15 degrees from the horizontal. At those angles the tension load in each leg of our 9 ton capacity is 17.4 tons — an overload of nearly 100%. This is why it is important to fully understand the tension and loads that your rigging will be under. This greatly depends on the rigging configuration and the materials used to create the sling. (See the chart on the effect angles have on the working load limit of slings on pg. 30)

SHOCK LOADING

Shock loading can also damage a sling. If a load is raised with a jerk or permitted to fall and be snubbed by slack chain, the dynamic load applied to the chain can vastly exceed the static weight being lifted.

SHOCK LOADING EXAMPLE:

For example, 1/2" Herc-Alloy 800® has a working load rating of 12,000 lbs. It will sustain this amount of total load for a long period time if used correctly. However, a payload weighing considerably less than 12,000 lbs. can break the chain in a one-time situation if permitted to drop and produce high dynamic stresses.

This Herc-Alloy 800 1/2" chain has a rupture work capacity (impact strength) capacity of about 9,000 ft.lbs./ft. This means that if a 9-foot-long sling were being used to raise a 12,000 lb. payload and the load snagged and dropped onto the slack chain hook, a drop of about 7 feet would break the chain. Ex. 9,000 ft. lbs./ft x 9 ft. approximately equals 12,000 lbs. x 7 ft.

The amount of dynamic load imposed on a chain in such a situation cannot be planned for. Although the cited example is rather extreme, it can happen.

Therefore, it is important to ensure you do not overload your chain, whether it be from an improper rigging configuration that decreases the working load limit of the materials used or a shock loading situation.

FIGURE 1
WORKING LOAD LIMITS FOR 5/8"
CM Herc-Alloy 800® ALLOY STEEL CHAIN SLINGS

Single Leg Sling -
Straight Vertical Pull

Double Leg Sling -
Used at Angles as Illustrated



Working load limits for 5/8 inch alloy steel chain slings,
(single and double leg configurations.)

FIGURE 2
5/8" CM Herc-Alloy 800® ALLOY STEEL CHAIN SLINGS



CAPACITY LOADING

OVERLOADING



VISIT OUR BLOG AT BLOG.CMWORKS.COM FOR GREAT ARTICLES ON RIGGING PRODUCTS & SAFETY TOPICS LIKE THIS:

Who is responsible for putting tags on chain slings? Can I retag my chain slings with missing tags, and do I have to load test a sling after I retag it?

It is the sling manufacturer's responsibility to put ID tags on chain slings. The sling manufacturer is a person or company assembling or fabricating sling components into their final form. The sling manufacturer and the manufacturer of the sling materials may or may not be identical. An end user who buys components and assembles them mechanically is the sling manufacturer. If the user does not know who the sling manufacturer is because the old tag fell off and went missing, then a decision needs to be made. It's the user's or rigger's responsibility to maintain the tag and be sure it remains legible. A rigger cannot use a sling without a tag or when a tag is illegible or missing information.

For retagging, the user would need to start their own serial number for documentation purposes. In doing so, this user would become the "sling manufacturer." This can only be done if the user is properly trained and deemed competent. Per OSHA, a person who tags a sling must be a competent person designated by the employer. ASME B30.9 states: replacement of the sling identification shall be considered a repair. Slings shall be repaired only by the sling manufacturer or a qualified person. A repair shall be marked to identify the repairing agency. To be considered competent and or qualified, the user should have some inspection experience and complete a rigging gear inspection course from a reputable training organization.

If the user feels they are not competent to properly inspect and retag the sling, they would need to send the sling out to a rigging house with a competent person for inspection and retagging. That rigging house now becomes the "sling manufacturer." Tags must have information per OSHA 1910.184(e) Alloy steel chain slings. Key OSHA and ASME standards regarding this include:

OSHA 1910.184(E)(1) SLING IDENTIFICATION

Alloy steel chain slings shall have permanently affixed durable identification stating size, grade, rated capacity, and reach.

ASME B30.9: SECTION 9-1.7: Sling Identification 9-1.7.1 Identification Requirements

Each sling shall be marked to show:

- (a) name or trademark of manufacturer
- (b) grade
- (c) nominal chain size
- (d) number of legs
- (e) rated loads for the type(s) of hitch(es) used and the angle upon which it is based
- (f) serial number
- (g) reach

A load test is not required if a sling is made up of individual load-tested components from the component manufacturer. If the sling is always found in acceptable condition per ASME B30.9, OSHA 1910.184 and manufacturers' recommendations, then the sling can remain in service without ever needing another load test performed.

For additional information on Sling ID tags, see pages 13, 63 & 75.

WIRE ROPE SLING WORKING LOAD LIMITS

6X19 AND 6X36 CLASS

CHAIN & SLING INSPECTION, USE & CARE

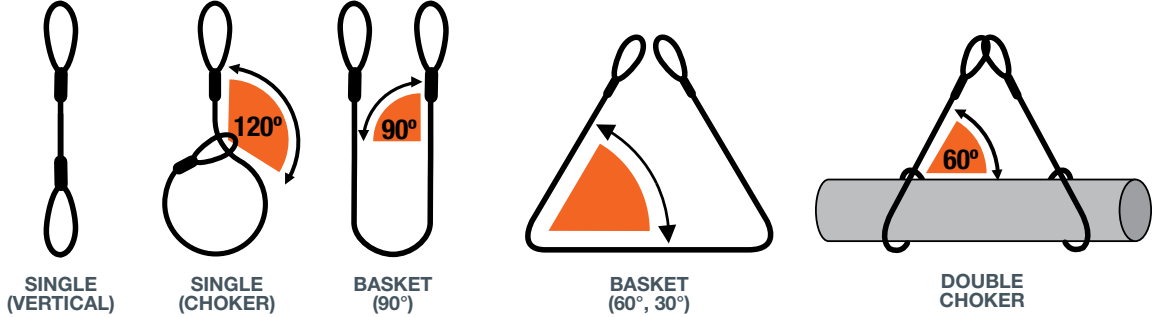

Wire Rope Size	WORKING LOAD LIMIT (TONS)						
	Single (1 Leg) Vertical	Single Choker	Basket 90°	Basket 60°	Basket 30°	Double Choker (2 Chokers)	
						60°	30°
EIPS-MS-IWRC (EXTRA IMPROVED PLOW STEEL, MECHANICAL SPLICE, INDEPENDENT WIRE ROPE CORE)							
1/4"	0.65	0.48	1.30	1.10	0.65	0.82	0.48
5/16"	1.00	0.74	2.00	1.70	1.00	1.30	0.74
3/8"	1.40	1.10	2.90	2.50	1.40	1.80	1.10
7/16"	1.90	1.40	3.90	3.40	1.90	2.50	1.40
1/2"	2.50	1.90	5.10	4.40	2.50	3.20	1.90
9/16"	3.20	2.40	6.40	5.50	3.20	4.10	2.40
5/8"	3.90	2.90	7.80	6.80	3.90	5.00	2.90
3/4"	5.60	4.10	11.00	9.70	5.60	7.10	4.10
7/8"	7.60	5.60	15.00	13.00	7.60	9.70	5.60
1"	9.80	7.20	20.00	17.00	9.80	13.00	7.20
1-1/8"	12.00	9.10	24.00	21.00	12.00	16.00	9.10
1-1/4"	15.00	11.00	30.00	26.00	15.00	19.00	11.00
1-3/8"	18.00	13.00	36.00	31.00	18.00	23.00	13.00
1-1/2"	21.00	16.00	42.00	37.00	21.00	28.00	16.00
1-5/8"	24.00	18.00	49.00	42.00	24.00	32.00	18.00
1-3/4"	28.00	21.00	57.00	49.00	28.00	37.00	21.00
1-7/8"	32.00	24.00	64.00	56.00	32.00	42.00	24.00
2"	37.00	28.00	73.00	63.00	37.00	48.00	28.00

Wire Rope Size	WORKING LOAD LIMIT (TONS)						
	Single (1 Leg) Vertical	Single Choker	Basket 90°	Basket 60°	Basket 30°	Double Choker (2 Chokers)	
						60°	30°
EEIPS-MS (EXTRA-EXTRA IMPROVED PLOW STEEL, MECHANICAL SPLICE)							
1/4"	0.71	0.52	1.40	1.20	0.71	0.90	0.52
5/16"	1.10	0.81	2.20	1.90	1.10	1.40	0.81
3/8"	1.60	1.20	3.20	2.70	1.60	2.00	1.20
7/16"	2.10	1.60	4.30	3.70	2.10	2.70	1.60
1/2"	2.80	2.00	5.50	4.80	2.80	3.50	2.00
9/16"	3.50	2.60	7.00	6.10	3.50	4.50	2.60
5/8"	4.30	3.20	8.60	7.50	4.30	5.50	3.20
3/4"	6.20	4.50	12.00	11.00	6.20	7.90	4.50
7/8"	8.30	6.10	17.00	14.00	8.30	11.00	6.10
1"	11.00	8.00	22.00	19.00	11.00	14.00	8.00

Chart is for reference only. Product not sold by Columbus McKinnon Corporation.

Based on OSHA standards - Always use the sling tag for the working load limits or consult sling manufacturer.

Note: Rated loads based on a minimum D/d of 25:1

Values listed in US tons.

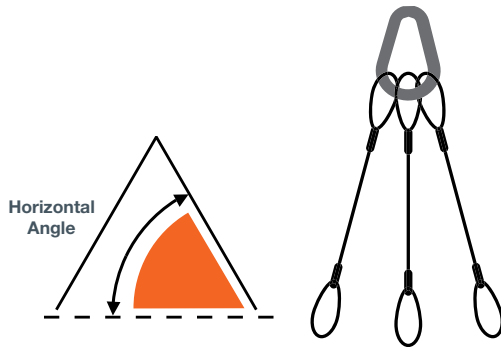

3-LEG BRIDLE

6X19 AND 6X36 CLASS

Wire Rope Size (in.)	WORKING LOAD LIMIT (TONS)			
	Vertical	60°	45°	30°
EIPS-MS-IWRC (EXTRA IMPROVED PLOW STEEL, MECHANICAL SPLICE, INDEPENDENT WIRE ROPE CORE)				
1/4	1.90	1.70	1.40	0.97
5/16	3.00	2.60	2.10	1.50
3/8	4.30	3.70	3.00	2.20
7/16	5.80	5.00	4.10	2.90
1/2	7.60	6.60	5.40	3.80
9/16	9.60	8.30	6.80	4.80
5/8	12.00	10.00	8.30	5.90
3/4	17.00	15.00	12.00	8.40
7/8	23.00	20.00	16.00	11.00
1	29.00	26.00	21.00	15.00
1-1/8	36.00	31.00	26.00	18.00
1-1/4	44.00	38.00	31.00	22.00
1-3/8	53.00	46.00	38.00	27.00
1-1/2	63.00	55.00	45.00	32.00
1-5/8	73.00	63.00	52.00	37.00
1-3/4	85.00	74.00	60.00	42.00
1-7/8	97.00	84.00	68.00	48.00
2	110.00	95.00	78.00	55.00

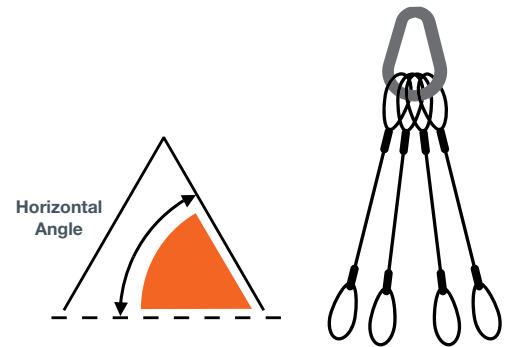

4-LEG BRIDLE

6X19 AND 6X36 CLASS

Wire Rope Size (in.)	WORKING LOAD LIMIT (TONS)			
	Vertical	60°	45°	30°
EIPS-MS-IWRC (EXTRA IMPROVED PLOW STEEL, MECHANICAL SPLICE, INDEPENDENT WIRE ROPE CORE)				
1/4	2.6	2.2	1.8	1.3
5/16	4.0	3.5	2.8	2.0
3/8	5.7	5.0	4.1	2.9
7/16	7.8	6.7	5.5	3.9
1/2	10.0	8.8	7.1	5.1
9/16	13.0	11.0	9.0	6.4
5/8	16.0	14.0	11.0	7.8
3/4	22.0	19.0	16.0	11.0
7/8	30.0	26.0	21.0	15.0
1	39.0	34.0	28.0	20.0
1-1/8	48.0	42.0	34.0	24.0
1-1/4	59.0	51.0	42.0	30.0
1-3/8	71.0	62.0	50.0	36.0
1-1/2	84.0	73.0	60.0	42.0
1-5/8	98.0	85.0	69.0	49.0
1-3/4	113.0	98.0	80.0	57.0
1-7/8	129.0	112.0	91.0	64.0
2	147.0	127.0	104.0	73.0

Wire Rope Size (in.)	WORKING LOAD LIMIT (TONS)						
	Single (1 Leg) Vertical	Single Choker	Basket 90°	Basket 60°	Basket 30°	Double Choker (2 Chokers)	
						60°	30°
EIPS-MS-FIBER (EXTRA IMPROVED PLOW STEEL, MECHANICAL SPLICE, FIBER CORE)							
1/4	0.56	0.42	1.10	0.97	0.56	0.73	0.42
5/16	0.87	0.66	1.70	1.50	0.87	1.10	0.66
3/8	1.20	0.94	2.50	2.20	1.20	1.60	0.94
7/16	1.70	1.30	3.40	2.90	1.70	2.20	1.30
1/2	2.20	1.60	4.40	3.80	2.20	2.90	1.60
9/16	2.70	2.10	5.50	4.80	2.70	3.60	2.10
5/8	3.40	2.60	6.80	5.90	3.40	4.50	2.60
3/4	4.80	3.70	9.70	8.40	4.80	6.30	3.70
7/8	6.60	5.00	13.00	11.00	6.60	8.60	5.00
1	8.30	6.40	17.00	14.00	8.30	11.00	6.40
1-1/8	10.00	8.10	21.00	18.00	10.00	14.00	8.10
1-1/4	13.00	9.90	26.00	22.00	13.00	17.00	9.90

Chart is for reference only. Product not sold by Columbus McKinnon Corporation.

Based on OSHA standards - Always use the sling tag for the working load limits or consult sling manufacturer.

Note: Rated loads based on a minimum D/d of 25:1

Values listed in US tons.

SYNTHETIC WEB SLING WORKING LOAD LIMITS

SYNTHETIC WEB SLING (EYE & EYE) WORKING LOAD LIMITS

EE LIGHT DUTY (CLASS 5) (1-PLY & 2-PLY)

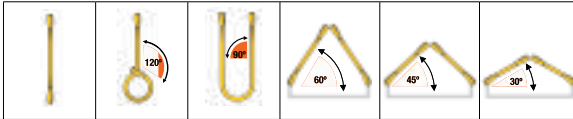

Synthetic Sling Size (in.)	Working Load Limit (lbs.)			Working Load Limit (lbs.)		
	Vertical	Choker	Vertical Basket 90°	Two Leg or Single Basket		
				60°	45°	30°
1-PLY, CLASS 5, EE LIGHT DUTY						
1	1,100	880	2,200	1,905	1,555	1,100
1-1/2	1,600	1,280	3,200	2,771	2,262	1,600
1-3/4	1,900	1,520	3,800	3,291	2,687	1,900
2	2,200	1,760	4,400	3,810	3,111	2,200
3	3,300	2,640	6,600	5,716	4,666	3,300
4	4,400	3,520	8,800	7,621	6,222	4,400
5	5,500	4,400	11,000	9,526	7,777	5,500
6	6,600	5,280	13,200	11,431	9,332	6,600
2-PLY, CLASS 5, EE LIGHT DUTY						
1	2,200	1,760	4,400	3,810	3,111	2,200
1-1/2	3,300	2,640	6,600	5,716	4,666	3,300
1-3/4	3,800	3,040	7,600	6,582	5,373	3,800
2	4,400	3,520	8,800	7,621	6,222	4,400
3	6,600	5,280	13,200	11,431	9,332	6,600
4	8,200	6,560	16,400	14,202	11,595	8,200
5	10,200	8,160	20,400	17,666	14,423	10,200
6	12,300	9,840	24,600	21,304	17,392	12,300

SYNTHETIC WEB SLING (ENDLESS) WORKING LOAD LIMITS

EN LIGHT DUTY (CLASS 5) (1-PLY & 2-PLY) (TYPE V)

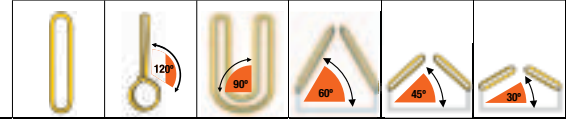

Synthetic Sling Size (in.)	Working Load Limit (lbs.)			Working Load Limit (lbs.)		
	Endless Vertical	Choker	Vertical Basket 90°	Two Leg or Single Basket		
				60°	45°	30°
1-PLY, CLASS 5, EN LIGHT DUTY						
1	2,200	1,760	4,400	3,810	3,111	2,200
1-1/2	3,200	2,560	6,400	5,542	4,525	3,200
1-3/4	3,800	3,040	7,600	6,582	5,373	3,800
2	4,400	3,520	8,800	7,621	6,222	4,400
3	6,600	5,280	13,200	11,431	9,332	6,600
4	8,800	7,040	17,600	15,242	12,443	8,800
5	11,000	8,800	22,000	19,052	15,554	11,000
6	13,200	10,560	26,400	22,862	18,665	13,200
2-PLY, CLASS 5, EN LIGHT DUTY						
1	4,400	3,520	8,800	7,621	6,222	4,400
1-1/2	6,600	5,280	13,200	11,431	9,332	6,600
1-3/4	7,600	6,080	15,200	13,163	10,746	7,600
2	8,800	7,040	17,600	15,242	12,443	8,800
3	13,200	10,560	26,400	22,862	18,665	13,200
4	16,400	13,120	32,800	28,405	23,190	16,400
5	20,400	16,320	40,800	35,333	28,846	20,400
6	24,600	19,680	49,200	42,607	34,784	24,600

SYNTHETIC WEB SLING (EYE & EYE) WORKING LOAD LIMITS

EE HEAVY DUTY (CLASS 7) (1-PLY & 2-PLY)

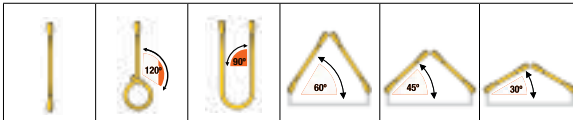

Synthetic Sling Size (in.)	Working Load Limit (lbs.)			Working Load Limit (lbs.)		
	Vertical	Choker	Vertical Basket 90°	Two Leg or Single Basket		
				60°	45°	30°
1-PLY, CLASS 7, EE HEAVY DUTY						
1	1,600	1,280	3,200	2,771	2,262	1,600
1-1/2	2,300	1,840	4,600	3,984	3,252	2,300
1-3/4	2,700	2,160	5,400	4,676	3,818	2,700
2	3,100	2,480	6,200	5,369	4,383	3,100
3	4,700	3,760	9,400	8,140	6,646	4,700
4	6,200	4,960	12,400	10,738	8,767	6,200
5	7,800	6,240	15,600	13,510	11,029	7,800
6	9,300	7,440	18,600	16,108	13,150	9,300
8	11,800	9,440	23,600	20,438	16,685	11,800
10	14,700	11,760	29,400	25,460	20,786	14,700
12	17,600	14,080	35,200	30,483	24,886	17,600
2-PLY, CLASS 7, EE HEAVY DUTY						
1	3,100	2,480	6,200	5,369	4,383	3,100
1-1/2	4,700	3,760	9,400	8,140	6,646	4,700
1-3/4	5,400	4,320	10,800	9,353	7,636	5,400
2	6,200	4,960	12,400	10,738	8,767	6,200
3	8,800	7,040	17,600	15,242	12,443	8,800
4	11,000	8,800	22,000	19,052	15,554	11,000
5	13,700	10,960	27,400	23,728	19,372	13,700
6	16,500	13,200	33,000	28,578	23,331	16,500
8	22,700	18,160	45,400	39,316	32,098	22,700
10	28,400	22,720	56,800	49,189	40,158	28,400
12	34,100	27,280	68,200	59,061	48,217	34,100

SYNTHETIC WEB SLING (ENDLESS) WORKING LOAD LIMITS

EN HEAVY DUTY (CLASS 7) (2-PLY) (TYPE V)

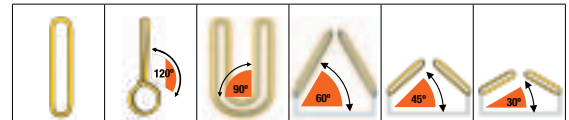

Synthetic Sling Size (in.)	Working Load Limit (lbs.)			Working Load Limit (lbs.)		
	Endless Vertical	Single Choker	Vertical Basket 90°	Two Leg or Single Basket		
				60°	45°	30°
1-PLY, CLASS 7, EN HEAVY DUTY						
1	6,200	4,960	12,400	10,738	8,767	6,200
1-1/2	9,400	7,520	18,800	16,281	13,262	9,400
1-3/4	10,800	8,640	21,600	18,706	15,271	10,800
2	12,400	9,920	24,800	21,477	17,534	12,400
3	17,600	14,080	35,200	30,483	24,886	17,600
4	22,000	17,600	44,000	38,104	31,108	22,000
5	27,400	21,920	54,800	47,457	38,744	27,400
6	33,000	26,400	66,000	57,156	46,662	33,000
8	42,350	33,880	84,600	74,801	59,812	42,300
10	52,900	42,320	105,800	91,623	74,801	52,900
12	63,500	50,800	127,000	109,982	89,789	63,500

Charts for reference only. Product not sold by Columbus McKinnon Corporation.

Always verify information on sling tag.

© Copyright 2004 by Web Sling & Tie Down Association.

CHAIN & SLING INSPECTION, USE & CARE

SYNTHETIC ROUNDSLING WORKING LOAD LIMITS

SYNTHETIC ROUNDSLING WORKING LOAD LIMITS

FOR VERTICAL & CHOKER HITCHES

Size	Working Load Limit (lbs.)		Minimum Diameter	
	Vertical	Choker	Decimals (in.)	Fractions (in.)
1	2,600	2,100	.5	1/2
2	5,300	4,200	.625	5/8
3	8,400	6,700	.75	3/4
4	10,600	8,500	.875	7/8
5	13,200	10,600	1	1
6	16,800	13,400	1.125	1-1/8
7	21,200	17,000	1.375	1-3/16
8	25,000	20,000	1.25	1-1/4
9	31,000	24,800	1.5	1-1/2
10	40,000	32,000	1.625	1-5/8
11	53,000	42,400	2	2
12	66,000	52,800	2.125	2-1/8
13	90,000	72,000	2.5	2-1/2



Chart is for reference only. Product not sold by Columbus McKinnon Corporation.

Always verify information on sling tag. © Copyright 1994 by Web Sling & Tie Down Association.
Never choke into the eye of hooks, bows of shackles and shackle pins and/or other rigging hardware.

CHAIN & SLING INSPECTION, USE & CARE

SYNTHETIC ROUNDSLING WORKING LOAD LIMITS

FOR BASKET HITCHES

Size	Working Load Limit (lbs.)				Minimum Diameter	
	90°	60°	45°	30°	Decimals (in.)	Fractions (in.)
1	5,200	4,500	3,700	2,600	.625	5/8
2	10,600	9,200	7,500	5,300	.875	7/8
3	16,800	14,500	11,900	8,400	1.0625	1-1/16
4	21,200	18,400	15,000	10,600	1.25	1-1/4
5	26,400	22,900	18,700	13,200	1.375	1-3/8
6	33,600	29,100	23,800	16,800	1.625	1-5/8
7	42,400	36,700	30,000	21,200	1.625	1-5/8
8	50,000	43,300	35,400	25,000	1.875	1-7/8
9	62,000	53,700	43,800	31,000	2	2
10	80,000	69,300	56,600	40,000	2.375	2-3/8
11	106,000	91,800	74,900	53,000	2.75	2-3/4
12	132,000	114,300	93,300	66,000	3	3
13	180,000	155,900	127,300	90,000	3.5	3-1/2



Chart is for reference only. Product not sold by Columbus McKinnon Corporation.

Always verify information on sling tag. © Copyright 1994 by Web Sling & Tie Down Association.
Never choke into the eye of hooks, bows of shackles and shackle pins and/or other rigging hardware.

RIGGING TRAINING

Columbus McKinnon is a global leader in providing expertise and training in the proper use and inspection of rigging and overhead lifting equipment. With a range of comprehensive programs conducted at venues throughout North America, as well as on site at private companies, we have a large course offering perfect for virtually any industry or application. Our rigging courses include:

QUALIFIED RIGGER HANDS-ON WORKSHOP

INCLUDES LEVEL 1 BASIC RIGGING, LEVEL 2 ADVANCED RIGGING & RIGGING GEAR & SLING INSPECTION (THOSE COURSES MAY ALSO BE TAKEN INDIVIDUALLY)

This 3-day workshop will prepare students to take the nationally accredited CIC Rigger/Signalperson Certification Exam and Level 2 Advanced Qualified Rigger Certification Exam. Businesses may wish to seek certification as a way to verify and promote their employees' knowledge of rigging.

LEVEL 1: BASIC RIGGING & SIGNAL PERSON TRAINING

Learn how to properly select, inspect and use slings and rigging hardware. Students will learn the requirements of OSHA regulations and ASME guidelines. Course also covers basic hitches, effects on working load limits, limitations of rigging equipment, load chart interpretation, proper knot tying and hand signals.

LEVEL 2: ADVANCED RIGGING

This course covers all aspects of Level 1 Basic Rigging as well as rigging math, calculating load weights, center of gravities, share of loads, sling tensions, load drifts and rigging block loads. Calculations are then applied in the hands-on rigging center.

RIGGING GEAR & SLING INSPECTION

Participants learn how to properly inspect chain, wire rope and synthetic slings, below-the-hook lifting devices, manual hoists and rigging hardware. Inspections are performed per OSHA, ASME and manufacturers' guidelines. This course is designed for riggers, sales people, and technicians who only inspect rigging gear.

RIGGING: TRAIN THE TRAINER

This workshop incorporates topics covered in Level 1: Basic Rigging & Signalperson, Rigging Gear Inspection and Level 2 Advanced Rigging coupled with hands-on rigging training.

LOAD SECUREMENT

Course is designed to educate those responsible for securing loads on over-the-road transportation vehicles and those responsible for enforcement. Course information is based on the North American Cargo Securement Standard incorporated in the regulations for the United States and Canada.

LOAD SECUREMENT: TRAIN THE TRAINER

This workshop is designed for companies needing to develop an in-house training program to educate those responsible for securing loads on over-the-road transportation vehicles and those responsible for enforcement. Participants then learn how to develop proper training/communications techniques, exercises, workshops and equipment required to deliver professional presentations. Course information is based on the North American Cargo Securement Standard incorporated in the regulations for the United States and Canada.

For a list of all rigging training available from Columbus McKinnon visit www.cmworks.com



CMCO UNIVERSITY™

CMCO University™ is an intense two-day program designed to elevate your sales revenue by giving you an intimate knowledge of our products, the information you'll need to select and sell the right product for the application, and the know-how to win in the marketplace.

If you are a CMCO Channel Partner and are interested in learning about our portfolio, product features and benefits, applications, proper product selection, and how to sell against competitive products, this is a must attend course.

KNOWLEDGE TO SALES

It's a fact — the more comfortable a sales force is with the product they're selling, the higher the conversion rate. With a deeper and wider breadth of understanding for an entire product line, a sales force will establish themselves as product and application knowledge leaders. That translates into stronger customer relationships, which in turn will lead to more sales.

OUR VISION, YOUR SUCCESS

CMCO University was conceived and designed by our staff of full-time professional instructors along with an advisory committee of product managers, sales leaders and industry specialists to do one thing — arm our Channel Partners with the knowledge they need to convert sales and generate revenue.

During the two-day program at CMCO University, attendees will have an opportunity to get hands-on experience using most of our products. For example, rather than simply speaking to the benefits of alloy chain and hooks, students will be able to see and participate in live rigging demonstrations.

Some of the topics covered in the classroom training and hands-on product demonstrations include:

- Overview of the CMCO product portfolio – manual hoists, powered hoists, crane components, chain and rigging
- Meet Our Associates – Customer Service, Management & Application Teams
- Features & Benefits of Our Products
- Applications & Industries
- CMCO Difference Against Competition
- Advantages of Pricing & Sales Programs
- Benefits to Selling & Promoting Training

NIAGARA TRAINING CENTER

Columbus McKinnon's corporate headquarters in Getzville, New York, is home to our state-of-the-art Niagara Training Center. The 3,000-square-foot facility is dedicated to training Channel Partners and end users on the safe and proper use of hoist and rigging products. The Center offers a one-of-a-kind training experience on chain and rigging equipment with more than 75 manual and powered hoists, enclosed track systems and our 50-foot-wide crane system with 3-ton Yale Global King wire rope hoist.



UNIVERSITY BENEFITS

Graduates of CMCO University will possess an intimate knowledge of all Columbus McKinnon brand overhead cranes, hoists and rigging products; as well as real world insight and instruction on how to best position, promote, and sell them. In addition to having a command of our product portfolio, graduates will be prepared to leverage our company's 141 years of product and application expertise to increase sales. New to the industry or veterans, outside sales or inside; we are confident that graduates of CMCO University will be better equipped to sell more product and to sell it better.

REGISTRATION

There is no registration fee to attend CMCO University. Students are responsible for their travel and hotel expenses. Daily after-class activities, including dinner events, will be announced as the class session approaches. Prior to attending the training, we ask that all registered students review a pre-course presentation to familiarize themselves with our company and products. This information is a great foundation for the on-site training.





SHACKLES

GENERAL INFORMATION

Design and Development	42
Forging Versus Casting	42
Standard and Specialty Shackles	43
Material and Finishes	44
Use, Care & Inspection	45
Specifications & Comparison Testing	46

PRODUCT OFFERING

Super Strong Anchor Shackles	47
Super Strong Chain Shackles	48
Alloy Anchor Shackles	49
Carbon Anchor Shackles (Industrial/Government Rated)	50
Carbon Chain Shackles (Industrial/Government Rated)	51
Web Sling Shackles (Carbon & Alloy)	52
Trawling Shackles	52
Long Reach Shackles	53
DNV Shackles	54
DNV Master Sub-Assemblies	55

Columbus McKinnon is proud to offer some of the strongest and most reliable shackles on the market. Manufactured through our state-of-the-art forging process in Chattanooga, Tennessee*, CM shackles are available in a variety of different styles and materials for virtually any rigging application.

* Some higher-capacity shackles are forged from high-quality German alloy steel at our STB facility in Hamm, Germany and then finished in the U.S.A.

DESIGN & DEVELOPMENT

SPECIFICATIONS

When manufacturing our shackles, Columbus McKinnon utilizes state-of-the-art forging equipment. The forging process is closely monitored to ensure consistent quality and the heat treatment process is computer-controlled and monitored to ensure that maximum performance parameters are met.

Each lot of product is checked to verify that the desired hardness range has been obtained.

All CM shackles are made from special bar quality material and comply with ASTM A322, ASTM A576 or ASTM A921. Galvanized shackles meet ASTM A153 or ASTM B695. Pins and bolts meet SAE J429 and ASTM A354.

CM shackles meet or exceed the performance requirements of the specs listed below:

- ASME B30.26 ■ ANSI B18
- EN 13889 ■ ISO 2415

CM also offers shackles that meet:

- U.S. Government Specification RR-C-271
- DNV Specifications

Every CM shackle is marked with an alpha-numeric trace code. For full information on CM shackle identification markings, see the Shackle Identification box to the right.

ENGINEERING & TESTING REQUIREMENTS

Columbus McKinnon has the capability to apply fracture mechanics, predict product life expectancy and conduct a multi-axial fatigue analysis to solve engineering problems related to safety-critical applications.

CM products having strength requirements are sample tested to ensure hardness, ductility and requisite loading parameters. All testing and measuring equipment is calibrated on a periodic basis. CM testing equipment is calibrated to National Institute for Standards and Testing (NIST) requirements. Columbus McKinnon is also ISO 9001:2008 certified.

Certifications for all shackles are available online. RR-C-271 certification is available if requested at time of order.

For an additional cost, we can also provide:

- Material certification
- Magnetic particle inspection
- Proof, ultimate, charpy, deformation and fatigue testing

FORGING VERSUS CASTING

Forging and casting are two very different manufacturing methods. When something is cast the material is heated above its melting temperature and poured into a mold where it solidifies. When something is forged it is physically forced into shape while remaining in a solid state – although it is frequently heated.

Forged shackles are generally better than cast. Forgings normally have less porosity, finer grain structure, higher tensile strength, better fatigue life and strength, and greater ductility than cast shackles. Why is this the case? When you melt metal to cast it, the grain size is free to expand. When it cools back to a solid, the grain structure is coarser and more random, decreasing its strength. Interior voids are also possible. The diagrams on the right illustrate the difference in grain flow between a forging and a casting.

For these reasons, CM utilizes a best-in-class forging process to ensure our shackles are strong, durable and reliable. All of our forged shackles are made right here in America at our Chattanooga, Tennessee facility, with the exception of some higher-capacity shackles that are forged from high-quality German alloy steel at our STB facility in Hamm, Germany and then finished in the U.S.A.

CUSTOMIZATION

CM shackles are always designed to meet internal, customer, contractual and regulatory requirements. Columbus McKinnon has the capability to develop original product designs based on unique customer applications. The CM Engineering department has CAD stations to facilitate design and development activities. New product design and tooling is subject to computerized Finite Element Analysis (FEA) and all drawings are filed electronically.

Custom products, or specials, designed to meet customer requirements require customer approval before the design is finalized.

In addition to product design, Columbus McKinnon also performs tooling and machine design to manufacture and process these products. Tooling that is required is purchased by the customer and remains their proprietary property throughout the life of the product.

▶ SHACKLE IDENTIFICATION

CM shackles and other rigging products can be identified by their unique markings.

We have taken extra efforts to enhance our shackle identification markings and our products now feature some of the largest and most user-friendly forged identification markings on the market. This innovation improves operator safety, reduces replacement costs and allows for easier identification of CM products in the field.

Every shackle is forged with the CM logo, its body or diameter size in imperial and/or metric units, trace code, USA, "Forged" and its specified strength requirements/working load limit (WLL). Most CM products also carry an alpha-numeric traceability code. Implemented in July 1980, this trace code system enables us to identify and track products once they ship from our plant, as well as determine:

- ▲ Date the product was forged
- ▲ Type and chemistry of steel
- ▲ Heat treating parameters
- ▲ In-process hardness testing results
- ▲ Strength data testing

Design and markings meet or exceed ASME B30.26



FORGING
Uniform grain flow gives material higher strength



CASTING
Random grain flow with larger grain structure makes material weaker than forged products

STANDARD & SPECIALTY SHACKLES

CM offers a full line of forged chain and anchor shackles for standard and specialty applications that are made right here in America*. Chain shackles are best used for straight-line pulls, while anchor shackles have a more generous loop that allows them to be side loaded or used for multiple connections.

* Some higher-capacity shackles are forged from high-quality German alloy steel at our STB facility in Hamm, Germany and then finished in the U.S.A.

STANDARD:

SCREW PIN SHACKLES



Screw Pin Shackles allow for quick and easy removal of the screw pin, which makes this style ideal for applications where the shackle is removed frequently. While the threaded pin can resist axial forces, it should not be cyclically loaded and is unreliable and vulnerable to backing out in applications where the pin is subjected to a torque or twisting action. In some applications, it is recommended to mose the screw pin to prevent the pin from unscrewing. **Recommended for overhead lifting**, screw pin shackles are available in the following materials with capacities up to 43 tons:

- Carbon shackles consist of a forged, microalloy special bar quality steel body with forged, heat-treated alloy steel pin.
- Alloy shackles consist of a forged, heat-treated alloy steel body with forged, heat-treated alloy steel pin.

Shackles meet ASME B30.26. They also meet the performance requirements of RR-C-271.

BOLT, NUT & COTTER SHACKLES



Of all shackle types, Bolt, Nut and Cotter Shackles provide the most secure pin arrangement, resisting axial and torsional loading. This type of shackle should be used in semi-permanent applications where the pin is removed infrequently. **Recommended for overhead lifting**, bolt, nut and cotter shackles are available in the following materials with capacities up to 120 tons:

- Carbon shackles consist of a forged, microalloy special bar quality steel body with forged, heat-treated alloy steel pin.
- Alloy shackles consist of a forged, heat-treated alloy steel body with forged, heat-treated alloy steel pin.

Shackles meet ASME B30.26. They also meet the performance requirements of RR-C-271.

ROUND PIN SHACKLES



Round Pin Shackles allow for easy removal by simply removing the cotter that holds the pin in place. These shackles perform well where the pin is subjected to a torque or twisting action, but are not best for use where the pin is subject to an axial load.

Round pin shackles are **not recommended for overhead lifting**. They feature a forged, heat-treated steel body with forged, heat-treated alloy steel pin and are available in capacities up to 43 tons.

Round pin anchor shackles should not be side loaded.

SPECIALTY:

DNV SHACKLES

Meet stringent DNV (Det Norske Veritas) requirements and are generally used in offshore, saltwater environments. CM Carbon DNV shackles are "Type Approved" by DNV to 2.7-1 Offshore Container Specifications. CM also offers serialized shackles and sub-assemblies inspected by a DNV surveyor who witnesses the production testing and issues DNV certificates for each batch. These shackles and sub-assemblies meet DNV 2.7-1 and 2.7-3 Offshore Container Specifications and 2.22 Lifting Appliances Requirements.

WEB SLING SHACKLES

Designed primarily for use with a synthetic web and round slings up to 6" in width. Available in capacities up to 12 tons. Body is made of carbon steel or heat-treated alloy steel. NOTE: Shackles cannot be point loaded. The load should be evenly distributed over the entire pin to achieve full working load limit.

LONG REACH SHACKLES

Made of alloy steel, CM is one of the only manufacturers of long reach shackles. These shackles are ideal for use in construction applications where a longer reach is needed to attach to pick points, and can also be used as a bail for lifting thicker products.

NOTE: Shackles cannot be point loaded. The load should be evenly distributed over the entire pin to achieve full working load limit.



SHACKLE MATERIAL & FINISHES

MATERIALS

CM forged shackles are made exclusively from domestically produced (U.S.A.)* Special Bar Quality (SBQ) steel having fine grain, reduced sulfur and phosphorus. Silicon inclusions and oxide inclusions are minimized to enhance forging performance characteristics. Steel used in our products may include, but is not restricted to the following:

- Carbon Steel 1037, 1020, 1040, 1080, 1141
- Microalloy Steel
- Alloy 4130, 4140, 8630, 8640

Using this Special Bar Quality steel, CM manufactures shackles in four distinct materials: carbon, super strong, U.S. alloy and German alloy. Each material has different properties and specifications. See our complete material comparison below.

* Some higher-capacity shackles are forged from high-quality German alloy steel at our STB facility in Hamm, Germany and then finished in the U.S.A.

4 TYPES OF SHACKLE MATERIAL

MATERIAL	STYLE	WLL (TONS)	SIZES (IN.)	STYLES	DESIGN FACTOR	FINISHES
CARBON	Anchor	1/3 to 85 tons	3/16" to 3"	Bolt, Nut & Cotter; Screw Pin; Round Pin	6:1	Orange Powder Coated, Galvanized
	Chain	1/2 to 35 tons	1/4" to 2"			
CARBON SPECIFICATIONS: Meet dimensional, performance and marking requirements of Federal Specification RR-C-271 (Regular Strength).						

SUPER STRONG 17 to 50% stronger than comparable-sized Carbon	Anchor	1/2 to 55 tons	3/16" to 2-1/2"	Bolt, Nut & Cotter; Screw Pin; Round Pin	6:1*	Orange Powder Coated, Self Colored, Galvanized
	Chain	3/4 to 35 tons	1/4" to 2"			
SUPER STRONG SPECIFICATIONS: Meet dimensional and exceed performance requirements of Federal Specification RR-C-271 (Regular Strength). Because they exceed requirements and are marked with higher strengths, they cannot be marked as meeting RR-C-271.						

* Super Strong round pin shackles have a 5:1 design factor.

ALLOY (U.S.) ~50% stronger than comparable-sized Carbon and ~25% stronger than Super Strong	Anchor	2 to 120 tons	3/8" to 3"	Bolt, Nut & Cotter; Screw Pin; Round Pin	5:1	Orange Powder Coated, Self Colored, Galvanized
ALLOY SPECIFICATIONS: Meet dimensional, performance and marking requirements of Federal Specification RR-C-271 (High Strength).						

ALLOY (GERMAN) Higher average Charpy values	Anchor	85 to 150 tons	2-1/2" to 3-1/2"	Bolt, Nut & Cotter	5:1	Self Colored, Galvanized
ALLOY SPECIFICATIONS: Shackle diameters of 2-1/2" to 3-1/2" meet dimensional, performance, and marking requirements of Federal Specification RR-C-271.						

FINISHES

CM shackles are available in three finishes: galvanized, self-colored and the recognizable CM orange powder coating.

GALVANIZED

Provides the best corrosive protection of all finishes which prevents it from wearing over time. Meets ASTM standards.

SELF-COLORED

Natural steel color easily blends with other steel finishes. Provides no protection from corrosion, but enables full exposure of identification markings.

CM ORANGE POWDER COATED

Easily recognizable as a CM product. Provides protection from corrosion and harsh environments and allows for visual identification of the manufacturer.

SHACKLE USE, CARE & INSPECTION

Improper use or care of shackles can result in bodily injury or property damage. Always observe the following guidelines when using shackles.

- Do not exceed the working load limit.
- Do not shock load.
- Do not side load – center line of load must coincide with the center line of the shackle. Shackles are designed and rated for in-line applied tension. You can attach multiple slings in the body of a shackle without reducing the capacity provided that the shackle is symmetrically loaded and the included angle does not exceed 120 degrees. (See Side Loading and Symmetrical Loading sections).
- Do not replace pin or bolt with other than original equipment.
- Inspect before use for wear, deformation and pin engagement as outlined in ASME B30.26. (See full inspection guidelines below).

Care should be exercised so that the shackle is not abused during use. When using shackles, it is important to:

- If necessary, use spacers on the shackle pin to assure that the shackle is not loaded at an angle. Load line of action should be through the center line of the shackle body and the middle of the shackle pin.
- The shackle should be protective coated with zinc plating or a galvanized finish if used in harsh environments.
- The shackle should not be subjected to high or low temperatures that could affect thermal treatment and the strength of the shackle. (Note: Per ASME B30.26 shackles are rated for temperatures between -40°F to 400°F.

SCREW PIN TIGHTENING

When tightening screw pins, it is important that shackle screw pin threads and the tapped threads in the shackle head are clean and free of burrs and damage. These conditions can cause an under-tightening of the shackle screw pin. The shackle screw pin should be tightly fitted into the shackle's leg opening until the threads engage and the shoulder of the screw pin makes contact with shackle body.

SIDE LOADING

When side loading a shackle with a single sling, the rated WLL will be reduced in accordance with the manufacturer's recommendation of a qualified person. ASME B30.26 also recommends reducing the capacity of a shackle when it is side loaded. (See figure below.) Note that only anchor shackles 3/8" to 3" may be side loaded. Chain or long-reach shackles should not be side loaded.

ANCHOR SHACKLES SIZES 3/16" TO 3"

Angles in Degrees	Working Load Limit Reduction
0° to 10°	0%
11° to 20°	15%
21° to 30°	25%
31° to 45°	30%
46° to 55°	40%
56° to 70°	45%
71° to 90°	50%

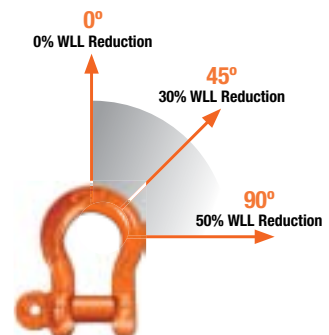

SYMMETRICAL LOADING

Shackles symmetrically loaded with two legs at a maximum included angle of 120° can be used to full working load limit. Side and symmetrical loading data applies to screw pin and bolt nut cotter anchor shackles as shown to the right.

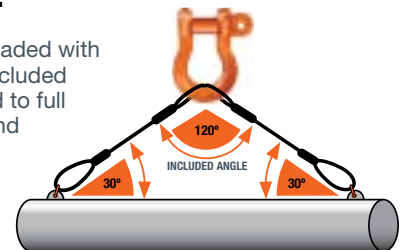

Simplify your Shackle Inspection and Inventory Management with CM Smart ID™

CM Smart ID RFID technology is now offered as an option on select shackles – including some of the smallest CM shackles available. Smart ID makes shackle inspection more efficient and effective, allowing you to easily associate detailed inspection information with every shackle so you know they're safe to use. Smart ID also increases your productivity by enabling faster inventory tracking and serialization.

ACTUAL SIZE SHOWN → MORE INFO AT www.cmworks.com/rfid/cmsmartid

SHACKLE INSPECTION

Shackles should be visually inspected before each use in line with ASME B30.26 regulations. Shackles should be discarded if any of the following conditions are apparent:

- Any parts are worn more than 10% of the original dimensions
- Load bearing components are bent, twisted, distorted, stretched, elongated, cracked or broken
- Excessive pitting, corrosion, nicks or gouges
- Indication of heat damage
- Missing or illegible manufacturer's name or trademark, working load limit or size
- Load pins have bent or visibly damaged threads
- Cotter pins or hairpin retainers are damaged

SHACKLES

CHARPY IMPACT TEST

The Charpy V-Notch Test was developed during World War 2 to test the penetration resistance of steel armor. It has since evolved into a method to test for toughness of steel in critical structures such as buildings or bridges.

In this test, a bar is mounted horizontally with the notch facing away from an impact weight suspended on a pendulum. When the weight is released, it swings down and breaks through the bar. An indicator measures how far the pendulum continues to swing after breaking the bar. The momentum of the pendulum is then the measure of the resistance of the material to breaking or penetration.

CM Super Strong shackles, with the lower hardness values, will consistently pull more than a competitor's carbon shackles of the same diameter. CM Super Strong shackles were designed to improve overall load strength and ductility without an increase in shackle diameter.

CM alloy shackles will meet the Charpy Impact Test requirements. Results of this testing show that CM Super Strong shackles greatly exceed the minimum strength requirements.

RESULTS OF COMPARISON TESTING
CM SUPER STRONG SHACKLES VERSUS STANDARD CARBON SHACKLES

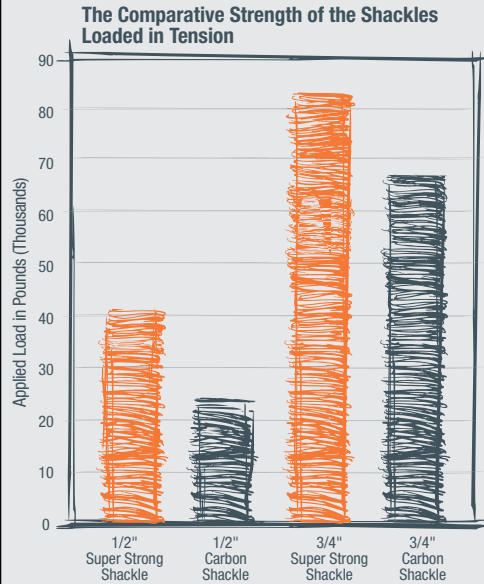

"Clearly the CM Big Orange[®] shackles exhibited superior strength and more ductility than the carbon steel shackles of the same nominal section size. While all of the shackles performed above their ratings, the CM Big Orange shackle performance was superior.

The CM Big Orange[®] shock test results indicated severe deformation occurred but no fracture was present. The carbon steel parts fractured in two tests and were severely cracked in a third test. These results indicate that the CM Big Orange shackle assembly is stronger and more ductile than the carbon steel shackle of the same size. For these reasons, the CM Big Orange shackle provides more extensive deformation prior to fracture. In conclusion, this test demonstrates the superiority of the CM Big Orange shackles when compared to the carbon steel shackles under the shock loaded conditions."

Verified by John Bloodworth, P.E.
 Q.C. Metallurgical Laboratory, Inc.

* CM Big Orange[®] shackles are now referred to as CM Super Strong shackles.

SHACKLE SPECIFICATIONS

DIMENSIONS & WORKING LOAD LIMITS

CM shackles are available in different dimensions with varying working load limits depending on the material they are made of. See the charts below for sizes and working load limits of our alloy, carbon and super strong shackles.

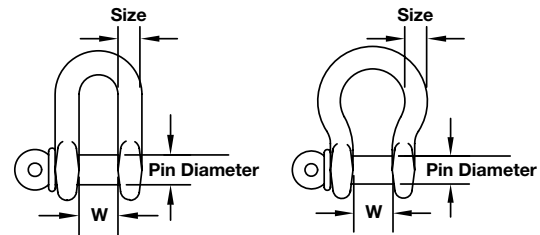

CARBON

Size (in.)	WLL (tons)	WLL (lbs.)	Pin Dia. (in.)	W dim. (in.)
3/16	1/3	667	0.25	0.38
1/4	1/2	1,000	0.31	0.47
5/16	3/4	1,500	0.38	0.53
3/8	1	2,000	0.44	0.66
7/16	1-1/2	3,000	0.50	0.72
1/2	2	4,000	0.63	0.84
5/8	3-1/4	6,500	0.75	1.06
3/4	4-3/4	9,500	0.88	1.28
7/8	6-1/2	13,000	1.00	1.44
1	8-1/2	17,000	1.13	1.72
1-1/8	9-1/2	19,000	1.25	1.84
1-1/4	12	24,000	1.38	2.03
1-3/8	13-1/2	27,000	1.50	2.25
1-1/2	17	34,000	1.63	2.41
1-5/8	20	40,000	1.75	2.66
1-3/4	25	50,000	2.00	2.94
2	35	70,000	2.25	3.28
2-1/2	55	110,000	2.75	4.13
3	85	170,000	3.25	5.00

SUPER STRONG

Size (in.)	WLL (tons)	WLL (lbs.)	Pin Dia. (in.)	W dim. (in.)
3/16	1/2	1,000	0.25	0.38
1/4	3/4	1,500	0.31	0.47
5/16	1	2,000	0.38	0.53
3/8	1-1/2	3,000	0.44	0.66
7/16	2	4,000	0.50	0.72
1/2	3	6,000	0.63	0.84
5/8	4-1/2	9,000	0.75	1.06
3/4	6-1/2	13,000	0.88	1.28
7/8	8-1/2	17,000	1.00	1.44
1	10	20,000	1.13	1.72
1-1/8	12	24,000	1.25	1.84
1-1/4	14	28,000	1.38	2.03
1-3/8	17	34,000	1.50	2.25
1-1/2	20	40,000	1.63	2.41
1-5/8	24	48,000	1.75	2.66
1-3/4	30	60,000	2.00	2.94
2	35	70,000	2.25	3.28
2-1/2	55	110,000	2.75	4.13

ALLOY

Size (in.)	WLL (tons)	WLL (lbs.)	Pin Dia. (in.)	W dim. (in.)
3/8	2	4,000	0.44	0.66
7/16	2.6	5,200	0.50	0.72
1/2	3.3	6,600	0.63	0.84
5/8	5	10,000	0.75	1.06
3/4	7	14,000	0.88	1.28
7/8	9.5	19,000	1.00	1.44
1	12.5	25,000	1.13	1.72
1-1/8	15	30,000	1.25	1.84
1-1/4	18	36,000	1.38	2.03
1-3/8	21	42,000	1.50	2.25
1-1/2*	25	50,000	1.63	2.41
1-1/2**	30	60,000	1.63	2.41
1-5/8*	29	58,000	1.75	2.66
1-5/8**	35	70,000	1.75	2.66
1-3/4*	34	68,000	2.00	2.94
1-3/4**	40	80,000	2.00	2.94
2*	43	86,000	2.25	3.28
2**	50	100,000	2.25	3.28
2-1/2**	85	170,000	2.75	4.13
3**	110	220,000	3.25	5.00
3-1/2**	150	300,000	3.75	5.25

* Screw Pin & Round Pin style only
 ** Bolt, Nut & Cotter style only



SUPER STRONG ANCHOR SHACKLES

WORKING LOAD LIMIT: 1/2 TO 55 TONS

CM Super Strong Shackles are carbon-type shackles with strength ratings that are 17 to 50% stronger than comparable-sized carbon shackles. As a result, these shackles are designed with a 6:1 design factor. Anchor shackles can be side loaded or used for multiple connections.

BENEFITS & FEATURES

- Manufactured from technically advanced domestic (U.S.A.) micro alloy steel with optimal hardness for strength and ductility. (See our full shackle material comparison on page 44)
- Shackles show major deformation before failure
- Working load limit and traceability codes shown as permanent markings on body
- All shackles have alloy quenched and tempered pins
- Available in sizes 3/16" to 2-1/2"
- Available finishes include powder coated, galvanized or self-colored
- Shackles meet dimensional requirements and exceed performance requirements of RR-C-271
- Special testing and certification is available upon request at the time of the order
- Note: Screw pin and bolt/nut/cotter shackles have a 6:1 design factor. Round pin shackles have 5:1 design factor.
- CM Smart ID RFID technology is available as an option on screw pin anchor shackles sizes 1/2" to 1-3/4" and bolt, nut & cotter shackles sizes 3/4" to 1-3/4"

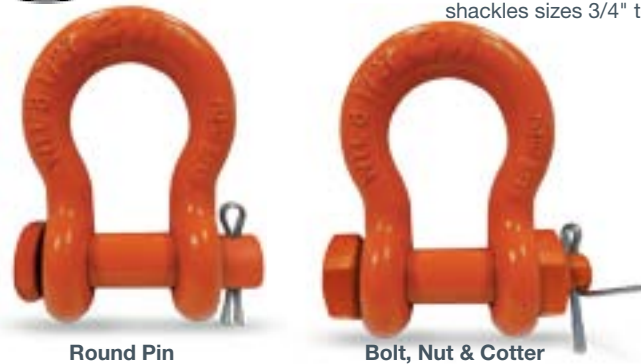

Round Pin

Bolt, Nut & Cotter

Screw Pin

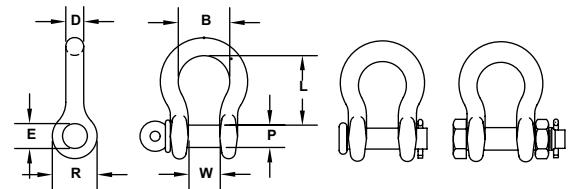

STYLES: Screw Pin, Round Pin, Bolt/Nut/Cotter
FINISHES: Self Colored, Galvanized, Orange Powder Coated

Size D (in.)	Working Load Limit (Ton)	Std. Pkg.	Weight (lbs.)	Product Code									Dimensions (in.)					
				Screw Pin			Round Pin			Bolt, Nut & Cotter			P	E	W	R	L	B (min.)
				Self Colored	Galvanized	Orange Powder Coated	Self Colored	Galvanized	Orange Powder Coated	Self Colored	Galvanized	Orange Powder Coated						
3/16	1/2	50	0.06	M645	M645G	-	M345	M345G	-	-	-	-	0.25	0.29	0.38	0.57	0.88	0.58
1/4	3/4	50	0.12	M646	M646G	M646P	M346	M346G	M346P	M846	M846G	M846P	0.31	0.36	0.47	0.75	1.13	0.75
5/16	1	50	0.20	M647	M647G	M647P	M347	M347G	M347P	M847	M847G	M847P	0.38	0.45	0.53	0.84	1.25	0.81
3/8	1-1/2	50	0.30	M648	M648G	M648P	M348	M348G	M348P	M848	M848G	M848P	0.44	0.52	0.66	1.00	1.40	1.00
7/16	2	50	0.50	M649	M649G	M649P	M349	M349G	M349P	M849	M849G	M849P	0.50	0.58	0.72	1.15	1.69	1.19
1/2	3	50	0.75	M650	M650G	M650P	M350	M350G	M350P	M850	M850G	M850P	0.63	0.70	0.84	1.34	1.94	1.38
5/8	4-1/2	25	1.30	M651	M651G	M651P	M351	M351G	M351P	M851	M851G	M851P	0.75	0.83	1.06	1.66	2.41	1.63
3/4	6-1/2	10	2.30	M652	M652G	M652P	M352	M352G	M352P	M852	M852G	M852P	0.88	0.95	1.28	1.94	2.84	1.89
7/8	8-1/2	10	3.50	M653	M653G	M653P	M353	M353G	M353P	M853	M853G	M853P	1.00	1.09	1.44	2.14	3.31	2.06
1	10	5	5.00	M654	M654G	M654P	M354	M354G	M354P	M854	M854G	M854P	1.13	1.22	1.72	2.44	3.75	2.52
1-1/8	12	Bulk	7.00	M655	M655G	M655P	M355	M355G	M355P	M855	M855G	M855P	1.25	1.36	1.84	2.66	4.02	2.69
1-1/4	14	Bulk	9.50	M656	M656G	M656P	M356	M356G	M356P	M856	M856G	M856P	1.38	1.52	2.03	3.15	4.63	2.88
1-3/8	17	Bulk	12.50	M666	M666G	M666P	M366	M366G	M366P	M866	M866G	M866P	1.50	1.65	2.25	3.25	5.19	3.25
1-1/2	20	Bulk	17.20	M657	M657G	M657P	M357	M357G	M357P	M857	M857G	M857P	1.63	1.77	2.41	3.50	5.63	3.50
1-5/8	24	Bulk	23.50	M685	M685G	M685P	M385	M385G	M385P	M885	M885G	M885P	1.75	1.88	2.66	3.91	6.13	4.13
1-3/4	30	Bulk	27.70	M677	M677G	M677P	M377	M377G	M377P	M877	M877G	M877P	2.00	2.13	2.94	4.06	6.97	4.75
2	35	Bulk	39.00	M658	M658G	M658P	M358	M358G	M358P	M858	M858G	M858P	2.25	2.38	3.28	4.51	7.44	5.50
2-1/2	55	Bulk	90.50	-	-	-	-	-	-	MC860	MC860G	-	2.75	2.91	4.13	6.25	10.48	6.75

Check with your sales rep for a list of models eligible for our In-Stock Guarantee. To order products with CM Smart ID RFID technology add "-RF" after the product number in the chart above. RFID-equipped rigging products are not eligible for our In-Stock Guarantee.



SUPER STRONG CHAIN SHACKLES

WORKING LOAD LIMIT: 3/4 TO 35 TONS

CM Super Strong Shackles are carbon-type shackles with strength ratings that are 17 to 50% stronger than comparable-sized carbon shackles. As a result, these shackles are designed with a 6:1 design factor. Chain shackles are best suited for straight-line pulls.

BENEFITS & FEATURES

- Manufactured from technically advanced domestic (U.S.A.) micro alloy steel with optimal hardness for strength and ductility. (See our full shackle material comparison on page 44)
- Shackles show major deformation before failure
- Working load limit and traceability codes shown as permanent markings on body
- All shackles have alloy quenched and tempered pins
- Available in sizes 1/4" to 2"
- Available finishes include powder coated, galvanized or self-colored
- Shackles meet dimensional requirements and exceed performance requirements of RR-C-271
- Special testing and certification is available upon request at the time of the order
- Note: Screw pin and bolt/nut/cotter shackles have a 6:1 design factor. Round pin shackles have 5:1 design factor.



Screw Pin

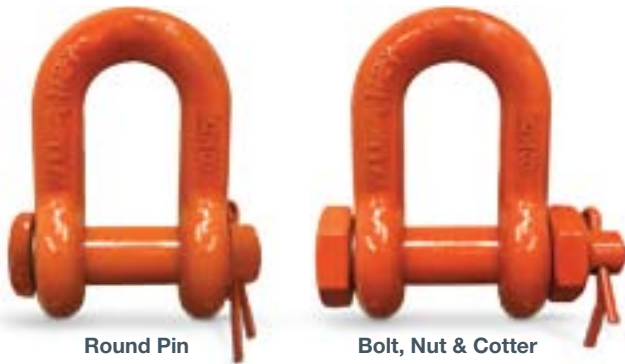

Round Pin

Bolt, Nut & Cotter

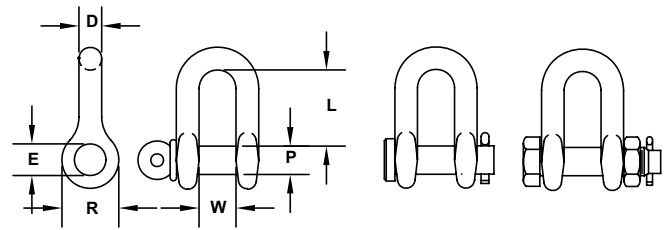

STYLES: Screw Pin, Round Pin, Bolt/Nut/Cotter
FINISHES: Self Colored, Galvanized, Orange Powder Coated

Size D (in.)	Working Load Limit (Ton)	Std. Pkg.	Weight (lbs.)	Product Code									Dimensions (in.)				
				Screw Pin			Round Pin			Bolt, Nut & Cotter			P	E	W	R	L
				Self Colored	Galvanized	Orange Powder Coated	Self Colored	Galvanized	Orange Powder Coated	Self Colored	Galvanized	Orange Powder Coated					
1/4	3/4	50	0.12	M746	M746G	M746P	M546	M546G	M546P	M946	M946G	M946P	0.31	0.36	0.47	0.75	0.88
5/16	1	50	0.20	M747	M747G	M747P	M547	M547G	M547P	M947	M947G	M947P	0.38	0.46	0.56	0.84	1.03
3/8	1-1/2	50	0.30	M748	M748G	M748P	M548	M548G	M548P	M948	M948G	M948P	0.44	0.52	0.66	0.99	1.25
1/2	3	50	0.75	M750	M750G	M750P	M550	M550G	M550P	M950	M950G	M950P	0.63	0.70	0.84	1.25	1.69
5/8	4-1/2	25	1.30	M751	M751G	M751P	M551	M551G	M551P	M951	M951G	M951P	0.75	0.83	1.09	1.58	2.00
3/4	6-1/2	10	2.30	M752	M752G	M752P	M552	M552G	M552P	M952	M952G	M952P	0.88	0.95	1.25	1.89	2.38
7/8	8-1/2	10	3.50	M753	M753G	M753P	M553	M553G	M553P	M953	M953G	M953P	1.00	1.09	1.44	2.14	2.88
1	10	5	5.00	M754	M754G	M754P	M554	M554G	M554P	M954	M954G	M954P	1.13	1.22	1.72	2.41	3.19
1-1/8	12	Bulk	7.00	M755	M755G	M755P	M555	M555G	M555P	M955	M955G	M955P	1.25	1.34	1.81	2.69	3.56
1-1/4	14	Bulk	9.50	M756	M756G	M756P	M556	M556G	M556P	M956	M956G	M956P	1.38	1.50	2.03	3.13	3.94
1-3/8	17	Bulk	12.50	M766	M766G	M766P	M566	M566G	M566P	M966	M966G	M966P	1.50	1.63	2.25	3.32	4.44
1-1/2	20	Bulk	17.20	M757	M757G	M757P	M557	M557G	M557P	M957	M957G	M957P	1.63	1.78	2.38	3.57	4.88
1-5/8	24	Bulk	23.50	M785	M785G	M785P	M585	M585G	M585P	M985	M985G	M985P	1.75	1.88	2.63	3.94	5.25
1-3/4	30	Bulk	27.70	M777	M777G	M777P	M577	M577G	M577P	M977	M977G	M977P	2.00	2.13	2.88	4.06	5.75
2	35	Bulk	39.00	M758	M758G	M758P	M558	M558G	M558P	M958	M958G	M958P	2.25	2.38	3.28	4.53	6.75



ALLOY ANCHOR SHACKLES

WORKING LOAD LIMIT: 2 TO 150 TONS

CM Alloy Shackles are designed with a 5:1 design factor and have a strength rating approximately 50% higher than a comparable-sized carbon shackle and about 25% stronger than super strong shackles. Anchor shackles can be side loaded or used for multiple connections.

BENEFITS & FEATURES

- 3/8" to 2" sizes made in the U.S.A. from domestic (U.S.A.) Special Bar Quality (SBQ) steel having fine grain, reduced sulfur and phosphorus. (See our full shackle material comparison on page 8)
- Shackles show major deformation before failure
- Working load limit and traceability codes shown as permanent markings on body
- All shackles have alloy quenched and tempered pins
- Available in sizes 3/8" to 3-1/2"
- Available finishes include powder coated, galvanized or self-colored
- Shackles meet dimensional and performance requirements of RR-C-271
- Special testing and certification is available upon request at the time of the order
- Design factor 5:1
- CM Smart ID RFID technology is available as an option on screw pin anchor shackles sizes 1/2" to 1-3/4" and bolt, nut & cotter shackles sizes 3/4" to 1-3/4"



HIGH-CAPACITY ALLOY SHACKLES



- 2-1/2" to 3-1/2" sizes forged from high-quality German alloy steel at our STB facility in Hamm, Germany and then finished in the U.S.A.
- Feature higher average Charpy values than the competition, delivering better performance and exceptional toughness in cold temperature applications.
- Convenient articulating lifting points on the bolt allow for easy rigging and transport.

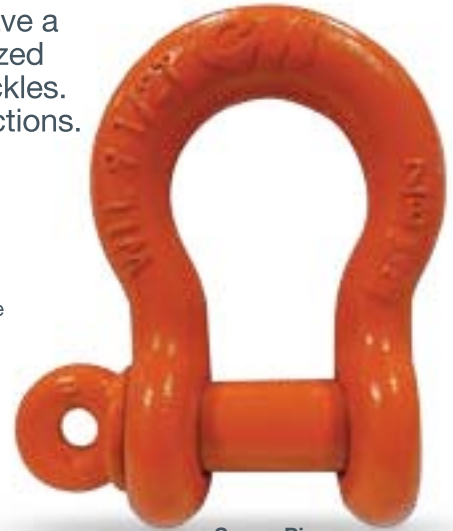
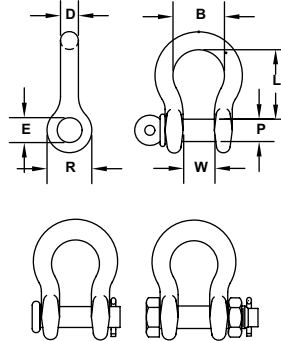

Screw Pin

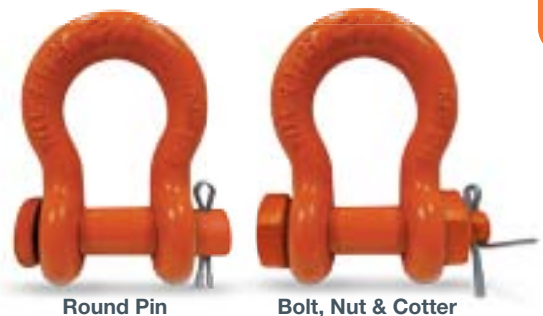

Round Pin

Bolt, Nut & Cotter

STYLES: Screw Pin, Round Pin, Bolt/Nut/Cotter
FINISHES: Self Colored, Galvanized, Orange Powder Coated

Size D (in.)	Working Load Limit (Ton)	Alloy Material Origin		Std. Pkg.	Weight (lbs.)	Product Code									Dimensions (in.)					
		U.S.A	Germany			Screw Pin			Round Pin			Bolt, Nut & Cotter			P	E	W	R	L	B min
						Self Colored	Galvanized	Orange Powder Coated	Self Colored	Galvanized	Orange Powder Coated	Self Colored	Galvanized	Orange Powder Coated						
3/8	2	✓		50	0.30	M648A	M648AG	M648AP	-	-	-	M848A	M848AG	M848AP	0.44	0.52	0.66	1.00	1.40	1.00
7/16	2.6	✓		50	0.50	M649A	M649AG	M649AP	-	-	-	M849A	M849AG	M849AP	0.50	0.58	0.72	1.15	1.69	1.19
1/2	3.3	✓		50	0.75	M650A	M650AG	M650AP	M350A	M350AG	M350AP	M850A	M850AG	M850AP	0.63	0.70	0.84	1.34	1.94	1.38
5/8	5	✓		25	1.30	M651A	M651AG	M651AP	M351A	M351AG	M351AP	M851A	M851AG	M851AP	0.75	0.83	1.06	1.66	2.41	1.63
3/4	7	✓		10	2.30	M652A	M652AG	M652AP	M352A	M352AG	M352AP	M852A	M852AG	M852AP	0.88	0.95	1.28	1.94	2.84	1.89
7/8	9.5	✓		10	3.50	M653A	M653AG	M653AP	M353A	M353AG	M353AP	M853A	M853AG	M853AP	1.00	1.09	1.44	2.14	3.31	2.06
1	12.5	✓		5	5.00	M654A	M654AG	M654AP	M354A	M354AG	M354AP	M854A	M854AG	M854AP	1.13	1.22	1.72	2.44	3.75	2.52
1-1/8	15	✓		Bulk	7.00	M655A	M655AG	M655AP	M355A	M355AG	M355AP	M855A	M855AG	M855AP	1.25	1.36	1.84	2.66	4.02	2.69
1-1/4	18	✓		Bulk	9.50	M656A	M656AG	M656AP	M356A	M356AG	M356AP	M856A	M856AG	M856AP	1.38	1.52	2.03	3.15	4.63	2.88
1-3/8	21	✓		Bulk	12.50	M666A	M666AG	M666AP	M366A	M366AG	M366AP	M866A	M866AG	M866AP	1.50	1.65	2.25	3.25	5.19	3.25
1-1/2	25	✓		Bulk	17.20	M657A	M657AG	M657AP	M357A	M357AG	M357AP	-	-	-	1.63	1.77	2.41	3.50	5.63	3.50
1-1/2	30	✓		Bulk	17.20	-	-	-	-	-	-	M857A	M857AG	M857AP	1.63	1.77	2.41	3.50	5.63	3.50
1-5/8	29	✓		Bulk	23.50	M685A	M685AG	M685AP	M385A	M385AG	M385AP	-	-	-	1.75	1.88	2.66	3.91	6.13	4.13
1-5/8	35	✓		Bulk	23.50	-	-	-	-	-	-	M885A	M885AG	M885AP	1.75	1.88	2.66	3.91	6.13	4.13
1-3/4	34	✓		Bulk	27.70	M677A	M677AG	M677AP	M377A	M377AG	M377AP	-	-	-	2.00	2.13	2.94	4.06	6.97	4.75
1-3/4	40	✓		Bulk	27.70	-	-	-	-	-	-	M877A	M877AG	M877AP	2.00	2.13	2.94	4.06	6.97	4.75
2	43	✓		Bulk	39.00	M658A	M658AG	M658AP	M358A	M358AG	M358AP	-	-	-	2.25	2.38	3.28	4.51	7.44	5.50
2	50	✓		Bulk	39.00	-	-	-	-	-	-	M858A	M858AG	M858AP	2.25	2.38	3.28	4.51	7.44	5.50
2-1/2	85		✓	Bulk	109.00	-	-	-	-	-	-	MC860A	MC860AG	-	2.75	2.99	4.13	6.13	10.48	6.75
3	110		✓	Bulk	148.00	-	-	-	-	-	-	MC862A	MC862AG	-	3.25	3.53	5.00	6.56	13.00	7.38
3-1/2	150		✓	Bulk	265.00	-	-	-	-	-	-	MC864A	MC864AG	-	3.75	4.06	5.25	8.38	15.00	9.00

Check with your sales rep for a list of models eligible for our In-Stock Guarantee. To order products with CM Smart ID RFID technology add "-RF" after the product number in the chart above. RFID-equipped rigging products are not eligible for our In-Stock Guarantee.



CARBON ANCHOR SHACKLES (INDUSTRIAL/GOVERNMENT-RATED)

WORKING LOAD LIMIT: 1/3 TO 85 TONS

CM Industrial/Government-Rated Carbon Shackles are designed with a 6:1 design factor. Anchor shackles can be side loaded or used for multiple connections.

BENEFITS & FEATURES

- Manufactured from technically advanced domestic (U.S.A.) micro alloy steel with optimal hardness for strength and ductility. (See our full shackle material comparison on page 44)
- All shackles have alloy quenched and tempered pins
- Working load limit and traceability codes shown as permanent markings on body
- Available in sizes 3/16" to 3"
- Available finishes include powder coated, self-colored or galvanized per ASTM A153
- All bolt, nut & cotter shackles have thread-protected ends
- Shackles meet dimensional and performance requirements of RR-C-271
- Standard industry tolerances apply
- Design factor 6:1
- CM Smart ID RFID technology is available as an option on screw pin anchor shackles sizes 1/2" to 1-3/4" and bolt, nut & cotter shackles sizes 3/4" to 1-3/4"



Screw Pin



Round Pin

Bolt, Nut & Cotter



▶ DID YOU KNOW?

CM INDUSTRIAL/GOVERNMENT VS. CM SUPER STRONG SHACKLES

An Industrial/Government shackle is a Super Strong shackle de-rated to meet, not exceed, the Federal Specification RR-C-271.

That means it has the same dimensions and performance characteristics as a Super Strong shackle but is marked with specifications to meet government requirements.

Example:

- 1" Super Strong shackle will be marked 10 Ton WLL
- 1" Industrial/Government shackle will be marked 8-1/2 Ton WLL

For more information, visit us at www.cmworks.com

STYLES: Screw Pin, Round Pin, Bolt/Nut/Cotter
FINISHES: Galvanized, Orange Powder Coated

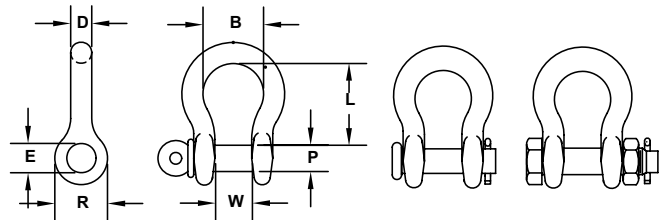

Size D (in.)	Working Load Limit (Ton)	Std. Pkg.	Weight (lbs.)	Product Code				Dimensions (in.)					
				Screw Pin		Round Pin	Bolt, Nut & Cotter	P	E	W	R	L	B (min.)
				Galvanized	Orange Powder Coated	Galvanized	Galvanized						
3/16	1/3	50	0.06	MC645G	-	MC345G	-	0.25	0.29	0.38	0.57	0.88	0.58
1/4	1/2	50	0.12	MC646G	MC646P	MC346G	MC846G	0.31	0.36	0.47	0.75	1.13	0.75
5/16	3/4	50	0.20	MC647G	MC647P	MC347G	MC847G	0.38	0.45	0.53	0.84	1.25	0.81
3/8	1	50	0.30	MC648G	MC648P	MC348G	MC848G	0.44	0.52	0.66	1.00	1.40	1.00
7/16	1-1/2	50	0.50	MC649G	MC649P	MC349G	MC849G	0.50	0.58	0.72	1.15	1.69	1.19
1/2	2	50	0.75	MC650G	MC650P	MC350G	MC850G	0.63	0.70	0.84	1.34	1.94	1.38
5/8	3-1/4	25	1.30	MC651G	MC651P	MC351G	MC851G	0.75	0.83	1.06	1.66	2.41	1.63
3/4	4-3/4	10	2.25	MC652G	MC652P	MC352G	MC852G	0.88	0.95	1.28	1.94	2.84	1.89
7/8	6-1/2	10	3.50	MC653G	MC653P	MC353G	MC853G	1.00	1.09	1.44	2.14	3.31	2.06
1	8-1/2	5	5.00	MC654G	MC654P	MC354G	MC854G	1.13	1.22	1.72	2.44	3.75	2.52
1-1/8	9-1/2	Bulk	7.00	MC655G	-	MC355G	MC855G	1.25	1.36	1.84	2.66	4.02	2.69
1-1/4	12	Bulk	9.00	MC656G	-	MC356G	MC856G	1.38	1.52	2.03	3.15	4.63	2.88
1-3/8	13-1/2	Bulk	12.50	MC666G	-	MC366G	MC866G	1.50	1.65	2.25	3.25	5.19	3.25
1-1/2	17	Bulk	17.20	MC657G	-	MC357G	MC857G	1.63	1.77	2.41	3.50	5.63	3.50
1-5/8	20	Bulk	23.50	MC685G	-	MC385G	MC885G	1.75	1.88	2.66	3.91	6.13	4.13
1-3/4	25	Bulk	27.70	MC677G	-	MC377G	MC877G	2.00	2.13	2.94	4.06	6.97	4.75
2	35	Bulk	39.00	M658G	M658P	M358G	-	2.25	2.38	3.28	4.51	7.44	5.50
2-1/2	55	Bulk	90.00	-	-	-	MC860G	2.75	2.91	4.13	6.25	10.48	6.75
3	85	Bulk	138.00	-	-	-	MC862G	3.25	3.41	5.00	6.75	13.00	7.38

To order products with CM Smart ID RFID technology add "-RF" after the product number in the chart above. RFID-equipped rigging products are not eligible for our In-Stock Guarantee.



CARBON CHAIN SHACKLES (INDUSTRIAL/GOVERNMENT-RATED)

WORKING LOAD LIMIT: 1/2 TO 35 TONS

CM Industrial/Government-Rated Carbon Shackles are designed with a 6:1 design factor. Chain shackles are best suited for straight-line pulls.

BENEFITS & FEATURES

- Manufactured from technically advanced domestic (U.S.A.) micro alloy steel with optimal hardness for strength and ductility. (See our full shackle material comparison on page 44)
- Working load limit and traceability codes shown as permanent markings on body
- All shackles have alloy quenched and tempered pins
- Available in sizes 1/4" to 2"
- Available finishes include powder coated, self-colored or galvanized per ASTM A153
- All bolt, nut & cotter shackles have thread-protected ends
- Shackles meet dimensional and performance requirements of RR-C-271
- Standard industry tolerances apply
- Design factor 6:1
- CM Smart ID RFID technology is available as an option on screw pin anchor shackles sizes 1/2" to 1-3/4" and bolt, nut & cotter shackles sizes 3/4" to 1-3/4"



Screw Pin



Round Pin



Bolt, Nut & Cotter

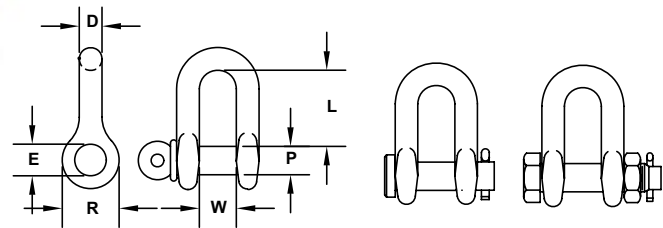

STYLES: Screw Pin, Round Pin, Bolt/Nut/Cotter
FINISHES: Self Colored, Galvanized, Orange Powder Coated

Size D (in.)	Working Load Limit (Ton)	Std. Pkg.	Weight (lbs.)	Product Code			Dimensions (in.)				
				Screw Pin	Round Pin	Bolt, Nut & Cotter	P	E	W	R	L
				Galvanized	Galvanized	Galvanized					
1/4	1/2	50	0.11	MC746G	MC546G	MC946G	0.31	0.36	0.47	0.75	0.88
5/16	3/4	50	0.17	MC747G	MC547G	MC947G	0.38	0.46	0.56	0.84	1.03
3/8	1	50	0.25	MC748G	MC548G	MC948G	0.44	0.52	0.66	0.99	1.25
1/2	2	50	0.75	MC750G	MC550G	MC950G	0.63	0.70	0.84	1.25	1.69
5/8	3-1/4	25	1.30	MC751G	MC551G	MC951G	0.75	0.83	1.09	1.58	2.00
3/4	4-3/4	10	2.30	MC752G	MC552G	MC952G	0.88	0.95	1.25	1.89	2.38
7/8	6-1/2	10	3.50	MC753G	MC553G	MC953G	1.00	1.09	1.44	2.14	2.88
1	8-1/2	5	5.00	MC754G	MC554G	MC954G	1.13	1.22	1.72	2.41	3.19
1-1/8	9-1/2	Bulk	7.00	MC755G	MC555G	MC955G	1.25	1.34	1.81	2.69	3.56
1-1/4	12	Bulk	9.50	MC756G	MC556G	MC956G	1.38	1.50	2.03	3.13	3.94
1-3/8	13-1/2	Bulk	12.50	MC766G	MC566G	MC966G	1.50	1.63	2.25	3.32	4.44
1-1/2	17	Bulk	17.20	MC757G	MC557G	MC957G	1.63	1.78	2.38	3.57	4.88
1-5/8	20	Bulk	23.50	MC785G	MC585G	MC985G	1.75	1.88	2.63	3.94	5.25
1-3/4	25	Bulk	27.70	MC777G	MC577G	MC977G	2.00	2.13	2.88	4.06	5.75
2	35	Bulk	39.00	M758G	M558G	M958G	2.25	2.38	3.28	4.53	6.75

To order products with CM Smart ID RFID technology add "-RF" after the product number in the chart above. RFID-equipped rigging products are not eligible for our In-Stock Guarantee.



CARBON WEB SLING SHACKLE

WORKING LOAD LIMIT: 8,050 TO 23,850 LBS.

Web sling shackles are designed to connect synthetic web and round slings to eye bolts and other lifting hardware.

BENEFITS & FEATURES

- Design factor 4:1
- Web Sling Shackles can be used on web slings from 3 to 6 inches in width
- Shackle body: carbon steel, heat treated
- Shackle pin: alloy steel, heat treated
- Finish: hot dip galvanized
- Zinc-plated linch pin comes standard. Cotter or hairpin available on special order.
- Tolerances: 1/32" unless otherwise indicated
- Do not point load. The load should be evenly distributed over the entire pin to achieve full working load limit.

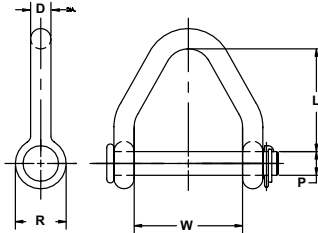

Product Code	Pin Number	Linch Pin Number	Working Load Limit (lbs.)	Dimensions (in.)					Weight (lbs.)
				P	D	L	W	R	
M702	2X702	65930	8,000	0.75	0.63	2.25	2.00	1.63	1.70
M703	2X703	65930	13,000	0.88	0.75	3.25	3.00	1.88	2.86
M704	2X704	65930	11,000	0.88	0.75	3.75	4.00	1.88	3.15
M705	2X705	65934	18,000	1.00	0.88	4.25	5.00	2.13	4.75
M706	2X706	65934	18,000	1.13	1.00	4.75	6.00	2.38	6.75
M706H	2X706H	65934	23,500	1.25	1.13	4.75	6.00	2.63	9.80

SHACKLES

ALLOY WEB SLING SHACKLE

WORKING LOAD LIMIT: 13,050 TO 22,500 LBS.

Web sling shackles are designed to connect synthetic web and round slings to eye bolts and other lifting hardware.

BENEFITS & FEATURES

- Design factor 6:1
- Web Sling Shackles can be used on web slings from 3 to 6 inches in width
- Utilize a bolt and nut with linchpin to secure the assembly in place
- All shackles are galvanized for longer life
- Marked with working load limit (WLL) and size
- Do not point load. The load should be evenly distributed over the entire pin to achieve full working load limit.

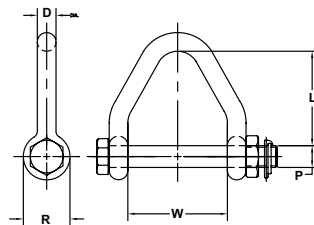

Product Code	Pin Number	Linch Pin Number	Working Load Limit (lbs.)	Dimensions (in.)					Weight (lbs.)
				P	D	L	W	R	
M703A	2X8703A	65930	13,500	0.88	0.75	3.25	3.00	1.88	3.01
M704A	2X8704A	65930	14,500	0.88	0.75	3.75	4.00	1.88	3.16
M705A	2X8705A	65934	19,000	1.00	1.00	4.25	5.00	2.38	6.04
M706A	2X8706A	65934	22,500	1.13	1.13	4.75	6.00	2.63	9.02





TRAWLING SHACKLE

WORKING LOAD LIMIT: 4,000 TO 20,000 LBS.

Load-rated trawling chain shackles are used for various applications, such as on trawl doors, the rigging of nets, and areas where critical loads are applied.

BENEFITS & FEATURES

- Design factor 6:1
- Heat-treated bodies
- Heat-treated alloy pins
- Square head pins for convenience in wrench tightening and loosening
- Durable orange powder coated finish

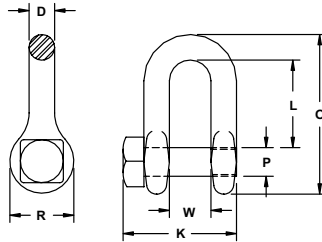

Product Code	Working Load Limit (lbs.)	Dimensions (in.)							Weight (lbs.)
		D	P	W	L	O	R	K	
M449G*	4,000	0.44	0.50	0.72	1.50	2.75	1.13	1.91	0.43
M450	6,000	0.50	0.63	0.84	1.69	3.13	1.25	2.06	0.60
M451	9,000	0.63	0.75	1.09	2.00	3.78	1.58	2.63	1.30
M452	13,000	0.75	0.88	1.25	2.38	4.53	1.89	3.13	2.20
M453	17,000	0.88	1.00	1.44	2.88	5.31	2.14	3.63	3.00
M454	20,000	1.00	1.13	1.72	3.19	5.81	2.41	4.44	4.70

* Product has a hex-head bolt and galvanized finish

SHACKLES

LONG-REACH SHACKLE

WORKING LOAD LIMIT: 7,000 TO 50,000 LBS.

As one of the only manufacturers of long-reach shackles, we designed these shackles for use in construction applications where a longer reach is needed to attach to pick points.

BENEFITS & FEATURES

- Design factor of 5:1
- Meets the requirements of ASME B30.26
- Alloy Steel
- WLL forged on body
- Offered in self-colored or durable orange powder coated finish
- Do not point load. The load should be evenly distributed over the entire pin to achieve full working load limit.
- Do not side load long-reach shackles
- 80% of bolt/pin must be covered to obtain full working load limit



Screw Pin



Bolt, Nut & Cotter

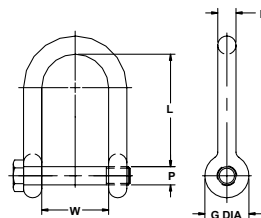

STYLES: Screw Pin, Bolt/Nut/Cotter
FINISHES: Self Colored, Orange Powder Coated



Size (in.)	Working Load Limit (lbs.)	Screw Pin		Weight (lbs.)	Bolt, Nut & Cotter		Weight (lbs.)	Dimensions (in.)				
		Product Code			Product Code			P	D	L	W	G
		Self Colored	Painted		Self Colored	Painted						
5/8	7,000	M7151	M7151P	1.80	M9151	M9151P	1.95	0.75	0.63	4.00	2.25	1.57
3/4	10,000	M7152	M7152P	2.72	M9152	M9152P	3.21	0.88	0.75	5.00	2.75	1.81
1	19,000	M7154	M7154P	5.86	M9154	M9154P	6.31	1.00	1.00	5.50	3.25	2.38
1-1/4	28,000	M7156	M7156P	11.90	M9156	M9156P	12.90	1.38	1.25	6.19	3.88	3.06
1-1/2	34,000	M7157	M7157P	19.60	M9157	M9157P	20.70	1.50	1.50	7.00	4.50	3.50
1-3/4	50,000	M7177	M7177P	30.70	M9177	M9177P	33.30	2.00	1.75	8.00	5.25	4.00

Check with your sales rep for a list of models eligible for our In-Stock Guarantee.



DNV SHACKLES

WORKING LOAD LIMIT: 4-3/4 TO 40 TON

Shackles meeting DNV requirements are often used in offshore saltwater environments. They are used to build slings and for general load securement applications, such as during the installation and removal of offshore platforms or transportation of cargo container units.

BENEFITS & FEATURES

- Certified to meet DNV standards for Offshore Container Specifications and comply with DNV Lifting Appliances Requirements
- Design factor of 5:1 or higher in accordance with DNV 2.7-1 requirements
- Exceed Charpy V impact strength of 42 Joules at -20°C (31 ft-lb at -4°F) as per DNV 2.7-1
- Shackles meet or exceed ASME B30.26. Also meet RR-C-271, EN13889 and ISO 2415 Performance Requirements
- Shackles are 100% proof tested at the manufacturing facility at two times the WLL. Breaking load applied at five times the WLL.
- Designed for use with chain, wire rope and synthetic slings
- Assembly consists of shackle body, bolt, nut and cotter
- Galvanized coating for protection against corrosion
- Certification of compliance supplied with each shipment. A 3.1 works material certificate can be provided upon request.
- Serialized shackles are also available that meet DNV 2.7-1 and 2.7-3 Offshore Container Specifications and 2.22 Lifting Appliances Requirements. CG3 documentation available upon request.

SHACKLES

▶ DID YOU KNOW?

INDUSTRY FOCUS: MARINE, SHIPYARDS AND OFFSHORE OIL & GAS EXPLORATION

Shackles and sub-assemblies meeting DNV requirements are often used in offshore, saltwater environments. They are used to build slings and for general load securement applications, such as during the installation and removal of offshore platforms or transportation of cargo container units (CCU). They are also used for underwater exploration activities. DNV products must comply with stringent production, testing, identification, inspection and documentation criteria set forth by DNV.

For more information, visit us at www.cmworks.com



Size (D) (in.)	Working Load Limit		Product Code	Dimensions (in.)						Weight (lbs.)
	ton	lbs.		P	E	W	R	L	B min	
DNV SHACKLES (FOR 2.7-1)										
3/4	4.75	9,500	M852DNV	0.88	0.95	1.25	1.94	2.84	1.89	2.61
7/8	6.5	13,000	M853DNV	1.00	1.09	1.47	2.19	3.31	2.06	4.04
1	8.5	17,000	M854DNV	1.13	1.22	1.69	2.38	3.75	2.52	5.68
1-1/8	9.5	19,000	M855DNV	1.25	1.34	1.82	2.63	4.25	2.69	7.50
1-1/4	12	24,000	M856DNV	1.38	1.50	2.03	3.13	4.75	2.88	11.00
1-3/8	13.5	27,000	M866DNV	1.50	1.63	2.25	3.25	5.25	3.25	13.50
1-1/2	17	34,000	M857DNV	1.63	1.75	2.38	3.50	5.75	3.50	18.50
1-3/4	25	50,000	M877DNV	2.00	2.13	2.88	4.00	7.00	4.75	31.00
SERIALIZED DNV SHACKLES (FOR 2.7-1, 2.7-3 & 2.22)										
3/4	7	14,000	M852ADNV	0.88	0.95	1.25	1.94	2.84	1.89	2.61
7/8	9.5	19,000	M853ADNV	1.00	1.09	1.47	2.19	3.31	2.06	4.04
1	12.5	25,000	M854ADNV	1.13	1.22	1.69	2.38	3.75	2.52	5.68
1-1/8	15	30,000	M855ADNV	1.25	1.34	1.82	2.63	4.25	2.69	7.50
1-1/4	18	36,000	M856ADNV	1.38	1.50	2.03	3.13	4.75	2.88	11.00
1-3/8	21	42,000	M866ADNV	1.50	1.63	2.25	3.25	5.25	3.25	13.50
1-1/2	30	60,000	M857ADNV	1.63	1.75	2.38	3.50	5.75	3.50	18.50
1-3/4	40	80,000	M877ADNV	2.00	2.13	2.88	4.00	7.00	4.75	31.00

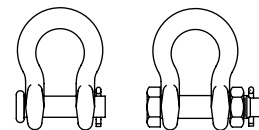
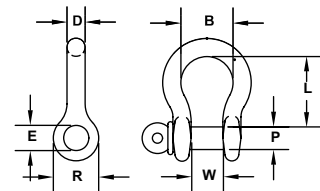



DNV MASTER SUB-ASSEMBLIES

WORKING LOAD LIMIT: 17-1/2 TO 50 TON

Master Sub-Assemblies meeting DNV requirements are used to build slings in conjunction with DNV Shackles. These products are designed for use in offshore saltwater environments for general load securement applications, such as during the installation and removal of offshore platforms or transportation of cargo container units.

BENEFITS & FEATURES

- Certified and serialized to meet DNV 2.7-1 and 2.7-3 Offshore Container Specifications and 2.22 Lifting Appliances Requirements
- Design factor of 5:1 or higher in accordance with DNV 2.7-1 requirements
- Welds exceed Charpy V impact strength of 27 Joules at -20°C (20 ft-lb, at -4°F) as per DNV 2.7-1
- Exceed ASTM A952 specifications for lifting components
- Designed to meet ASME B30.9 requirements
- Links are 100% proof tested at the manufacturing facility at two times the WLL
- Designed for use with chain, wire rope and synthetic slings
- Made from superior triple alloy steel with a galvanized coating for protection against corrosion
- Certification of compliance supplied with each shipment. CG3 documentation available upon request.
- Available in sizes from 1-1/4" to 2" diameter. Other sizes available upon request.
- Conforms to the new lower hardness offshore requirement

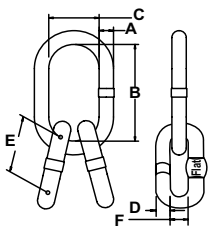

Trade Size (in.)	Working Load Limit		Product Code	Master Link Dimensions (in.)			Intermediate Link Dimensions (in.)			Weight (lbs.)
	ton	lbs.		Material Diameter A	Inside Length B	Inside Width C	Material Diameter D	Inside Length E	Inside Width F	
1-1/4	17.64	35,280	SA125DNV	1.25	8.75	4.38	1.25	8.75	4.38	27.8
1-1/2	27.56	55,125	SA150DNV	1.50	10.50	5.25	1.50	10.50	5.25	48.0
1-3/4	38.59	77,175	SA175DNV	1.75	12.00	6.00	1.75	12.00	6.00	75.0
2	50	100,000	SA200DNV	2.00	14.00	7.00	2.00	14.00	7.00	113.7

SHACKLES



HERD-PILLOY 1000
SN/D M 6522
SIZE 3/8 X 5 FT 1



CHAIN SLINGS & COMPONENTS

RATED FOR OVERHEAD LIFTING

SECTION OVERVIEW 58

HERC-ALLOY® 1000 PRODUCTS (Grade 100)

Product Overview	60-61
Chain	62
Chain Slings	63
Master Link (Dual Rated)	64
Sub-Assembly (Dual Rated)	64
Pear Shaped Master Link	65
EZ-Connect Master Link & Chain Shortener.....	65
Hammerlok® (Dual Rated)	66
Chain Shortener	66
Omgalok Connector (Dual Rated)	66
Rigging Hook (Dual Rated)	66
Clevlok® Sling Hook (Dual Rated)	67
Eye Sling Hook (Dual Rated)	67
Clevlok® Cradle Grab Hook (Dual Rated)	68
Eye Cradle Grab Hook (Dual Rated)	68
Clevlok® Foundry Hook	69
Eye Foundry Hook (Dual Rated)	69
Clevlok® Style Latchlok® Hook	70
Eye Style Latchlok® Hook	70
Swivel Style Latchlok® Hooks	71

HERC-ALLOY 800® PRODUCTS (Grade 80)

Product Overview	72-73
Chain	74
Chain Slings	75
Master Link (Dual Rated)	76
Forged Master Link	76
Master Link With and Without Flats	77
Flat Bottom Master Link	77
Sub-Assembly (Dual Rated)	78
Wide Body Sub-Assembly with Flats	78
Master Ring	79
Grab Link	79
Hammerlok® (Herc-Alloy 800®)	80
Weblok™ Assembly	80
Clevlok® Sling Hook (Dual Rated)	81
Eye Sling Hook (Dual Rated)	81
Clevlok® Grab Hook without Cradle	82
Clevlok® Cradle Grab Hook (Dual Rated)	82
Eye Cradle Grab Hook (Dual Rated)	83
Eye Foundry Hook (Dual Rated)	83

CHAIN SLINGS & COMPONENTS OVERVIEW

Chain slings are a combination of chain, hooks, rings and other attachments used primarily for overhead lifting. CM's selection of Grade 80 and Grade 100 chain and attachments can be combined in a variety of configurations to fit virtually any application.

THE STRENGTH OF CM HERC-ALLOY®

Made in America, CM Herc-Alloy® 1000 and 800 products are made of superior triple alloy steel that provides the best strength-to-weight performance in the industry. These products also meet and exceed ASTM A973 standards. Herc-Alloy® is now one of the most recognized and trusted brands in the rigging industry and is only offered by Columbus McKinnon.

DUAL-RATED RIGGING ATTACHMENTS

To help customers reduce and better manage their rigging inventory, Columbus McKinnon has developed several dual-rated rigging attachments that can be used for both Grade 80 and Grade 100 applications. Forged in the U.S.A, CM dual-rated rigging products are the best choice for even the toughest overhead lifting applications.















HERC-ALLOY® 1000

Columbus McKinnon has a long history of developing innovative products that have changed the material handling industry – including the development of the first alloy chain in 1933. This alloy chain eventually replaced the industry-standard wrought iron chain used for overhead lifting and is the predecessor to today’s Herc-Alloy® 1000 chain, hooks and overhead lifting attachments. Made in America, CM Herc-Alloy® products are made of superior triple alloy steel that provides the best strength-to-weight performance in the industry. Herc-Alloy® 1000 chain meets ASTM A973 standards while components, such as hooks and Hammerloks®, meet ASTM A952 standards.

Herc-Alloy® is now one of the most recognized and trusted brands in the rigging industry and is only offered by Columbus McKinnon.

HERC-ALLOY® 1000 PRODUCT OVERVIEW

The chart below is an overview of our most popular Herc-Alloy® 1000 products. Our full product offering, including detailed specifications and available sizes, can be found on the product pages within this section.











	Chain Size		Working Load Limit (lbs.)	COMPONENTS											
				Chain (Per Ft.)	Chain (Drum)	Master Link	Sub-Assembly	Pear Shaped Master Link	EZ-Connect Master Link & Chain Shortener	Hammerlok®	Chain Shortener	Omegalok Connector	Rigging Hook	Clevlok® Sling Hook w/Latch	Clevlok® Sling Hook w/o Latch
	(in.)	(mm.)		Page 62	Page 62	Page 64	Page 64	Page 65	Page 65	Page 66	Page 66	Page 66	Page 67	Page 67	Page 67
															
Single at 60°	7/32	5.5	2,700	607321	677310	555231	-	554702	-	667021-2	-	-	M7502A	657716	557716
	9/32	7	4,300	607328	677311	555232	-	554702	555232S1	667028-2	M71805A-2	644128	M7503A	657718	557718
	3/8	10	8,800	607339	677313	555235	-	554702	555325S1	667038-2	M71806A-2	644138	M7504A	657719	557719
	1/2	13	15,000	607351	677315	555238	-	554706	555328S1	667050-2	M71808A-2	644150	M7505A	657720	557720
	5/8	16	22,600	607363	677316	555238	-	554710	555239S1	667062-2	M71810A-2	644162	M7507A	657721	557721
Double at 60°	3/4	20	35,300	607378	677317	555240	-	554714	-	667075-2	-	-	M7509A	657722	557722
	7/32	5.5	4,700	607321	677310	555231	-	554702	-	667021-2	-	-	M7502A	657726	557716
	9/32	7	7,400	607328	677311	555232	-	554702	555232S2	667028-2	M71805A-2	644128	M7503A	657718	557718
	3/8	10	15,200	607339	677313	555235	-	554706	555325S2	667038-2	M71806A-2	644138	M7504A	657719	557719
	1/2	13	26,000	607351	677315	555238	-	554710	555328S2	667050-2	M71808A-2	644150	M7505A	657720	557720
Triple & Quad at 60°	5/8	16	39,100	607363	677316	555240	-	554714	555240S2	667062-2	M71810A-2	644162	M7507A	657721	557721
	3/4	20	61,100	607378	677317	555243	-	554719	-	667075-2	-	-	M7509A	657722	557722
	7/32	5.5	7,000	607321	677310	-	555274	554702	-	667021-2	-	-	M7502A	-	-
	9/32	7	11,200	607328	677311	-	555275	554706	-	667028-2	M71805A-2	644128	M7503A	657718	557718
	3/8	10	22,900	607339	677313	-	555276	554710	-	667038-2	M71806A-2	644138	M7504A	657719	557719
Triple & Quad at 60°	1/2	13	39,000	607351	677315	-	555277	554714	-	667050-2	M71808A-2	644150	M7505A	657720	557720
	5/8	16	58,700	607363	677316	-	555278	554719	-	667062-2	M71810A-2	644162	M7507A	657721	557721
	3/4	20	91,700	607378	677317	-	555279	554726	-	667075-2	-	-	M7509A	657722	557722



To help customers reduce and better manage their rigging inventory, Columbus McKinnon has developed several **DUAL-RATED RIGGING ATTACHMENTS** that can be used for both Grade 80 and 100 applications.



HERC-ALLOY® 1000
CHAIN SLINGS &
COMPONENTS

	Chain Size		Working Load Limit (lbs.)	COMPONENTS									
				Eye Sling Hook w/Latch	Eye Sling Hook w/o Latch	Clevlok® Cradle Grab Hook	Eye Cradle Grab Hook	Clevlok® Foundry Hook	Eye Foundry Hook	Clevlok® Style Latchlok® Hook	Eye Style Latchlok® Hook	Bearing Swivel Style Latchlok® Hook	Bushing Swivel Style Latchlok® Hook
	(in.)	(mm.)		Page 67	Page 67	Page 68	Page 68	Page 69	Page 69	Page 70	Page 70	Page 71	Page 71
													
Single at 90°	7/32	5.5	2,700	558618	458618	659718	559724	-	-	-	-	-	-
	9/32	7	4,300	558622	458622	659722	559725	475798	474798	M616005	M626005	M696005	M676005
	3/8	10	8,800	558625	458625	659725	559737	475799	474799	M616010	M626010	M696010	M676010
	1/2	13	15,000	558628	458628	659728	559750	475800	474800	M616015	M626015	M696015	M676015
	5/8	16	22,600	558629	458629	659729	559762	475801	474801	M616020	M626020	M696020	M676020
	3/4	20	35,300	558630	458630	-	559775	-	474802	-	-	-	-
Double at 60°	7/32	5.5	4,700	-	-	-	-	-	-	-	-	-	-
	9/32	7	7,400	558622	458622	659722	559725	475798	474798	M616005	M626005	M696005	M676005
	3/8	10	15,200	558625	458625	659725	559737	475799	474799	M616010	M626010	M696010	M676010
	1/2	13	26,000	558628	458628	659728	559750	475800	474800	M616015	M626015	M696015	M676015
	5/8	16	39,100	558629	458629	659729	559762	475801	474801	M616020	M626020	M696020	M676020
	3/4	20	61,100	558630	458630	-	559775	-	474802	-	-	-	-
Triple & Quad at 60°	7/32	5.5	7,000	-	-	-	-	-	-	-	-	-	-
	9/32	7	11,200	558622	458622	659722	559725	475798	474798	M616005	M626005	M696005	M676005
	3/8	10	22,900	558625	458625	659725	559737	475799	474799	M616010	M626010	M696010	M676010
	1/2	13	39,000	558628	458628	659728	559750	475800	474800	M616015	M626015	M696015	M676015
	5/8	16	58,700	558629	458629	659729	559762	475801	474801	M616020	M626020	M696020	M676020
	3/4	20	91,700	558630	458630	-	559775	-	474802	-	-	-	-

Sling ID Tags available. See page 63 for details.



HERC-ALLOY® 1000 CHAIN

WORKING LOAD LIMIT: 2,700 TO 35,300 LBS.

BENEFITS & FEATURES

- Meets ASTM A973 & NACM standards
- 25% higher working load limit when compared to Grade 80
- Environmentally friendly black coating for distinct appearance and ease of identification
- Certification included with every drum
- 100% proof tested
- 4:1 design factor

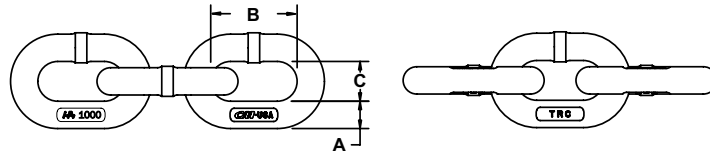

Chain Size (in.)	Working Load Limit (lbs.)	Nominal Chain Dimensions (in.)			Per Foot			Per Drum		
		Material Diameter A	Inside Length B	Inside Width C	Product Code	Weight (lbs./ft.)	Approximate Number of Links (per ft.)	Product Code	Length (ft.)	Weight (lbs.)
7/32	2,700	0.22	0.68	0.31	607321	0.44	17.8	677310	800	354
9/32	4,300	0.28	0.88	0.40	607328	0.73	13.6	677311	500	365
3/8	8,800	0.39	1.25	0.57	607339	1.44	9.6	677313	500	720
1/2	15,000	0.51	1.56	0.73	607351	2.46	7.7	677315	300	738
5/8	22,600	0.63	1.92	0.86	607363	3.70	6.3	677316	200	740
3/4	35,300	0.79	2.40	1.07	607378	5.77	5.0	677317	100	577

▶ INSPECTION, CARE & USE

HOW TO SELECT AND ORDER THE PROPER CHAIN SLING

1. Determine the weight and configuration of the load(s) to be lifted.
2. Determine the type of chain sling required, according to weight and configuration. (See page 31 for standard sling configurations.)
3. Determine the size of the body chain according to the working load limits. Be sure to take into consideration the effect of the required angle. The working load limit is the maximum load in pounds which should be applied in direct tension to a straight length of chain.
 Note: Working load limit can be affected by angles of loading, type of hitch used, environmental conditions such as hot and cold temperatures, and D/d ratio.
4. Determine the reach required to give the desired angle. The reach is measured from the upper bearing surface of the master link to the bearing surface of the lower attachment. If chain slings are to be used in pairs and are to be matched for reach, please indicate when ordering.
5. Know share of load on pick points and location of center of gravity.

See pages 26 through 32 for more information, or visit us at www.cmworks.com



HERC-ALLOY® 1000 CHAIN SLINGS & COMPONENTS



HERC-ALLOY® 1000 CHAIN SLINGS



**SINGLE LEG
(VERTICAL)**



**DOUBLE
(2 LEGS)**



**TRIPLE
(3 LEGS)**



**QUADRUPLE
(4 LEGS)**



**SINGLE
ENDLESS**



**DOUBLE
ENDLESS**



ADJUST-A-LINK



**SINGLE
BASKET**



**DOUBLE
BASKET**



**SINGLE
ADJUSTABLE**

**DOUBLE
ADJUSTABLE**

Adjusters on slings allow for easy and safe take up of chain when applications require shorter leg lengths or when lifting objects of abnormal sizes. There are two styles of adjusters: Style A and Style B. Style A is commonly used for shorter reach slings and consists of a hook attached to the link. Style B has 12" of chain in between link and hook gives you more flexibility on longer slings. *Note: Adjusters are also available on single, double, triple and quad slings.*

SLING ID TAGS

Description	Product Code
Alloy Sling ID Tag	557037
Carbon Sling ID Tag	457106
Attachment Ring	557193

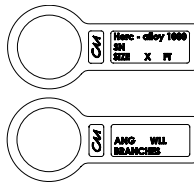

Information on tag includes sling size, reach, WLL, serial number, name of manufacturer, grade of sling & number of branches

Chain Size (in.)	Working Load Limits for Sling Types Show Above														
	Single (1 leg)	Single Choker	Double (2 legs)			Triple (3 legs)			Quad (4 legs)			Single Basket	Double Basket	Single Endless	Double Endless
	90° (lbs.)	90° (lbs.)	60° (lbs.)	45° (lbs.)	30° (lbs.)	60° (lbs.)	45° (lbs.)	30° (lbs.)	60° (lbs.)	45° (lbs.)	30° (lbs.)	60° (lbs.)	60° (lbs.)	90° (lbs.)	60° (lbs.)
7/32	2,700	2,100	4,700	3,800	2,700	7,000	5,700	4,000	7,000	5,700	4,000	4,700	7,000	2,700	4,700
9/32	4,300	3,500	7,400	6,100	4,300	11,200	9,100	6,400	11,200	9,100	6,400	7,400	11,200	4,300	7,400
3/8	8,800	7,100	15,200	12,400	8,800	22,900	18,700	13,200	22,900	18,700	13,200	15,200	22,900	8,800	15,200
1/2	15,000	12,000	26,000	21,200	15,000	39,000	31,800	22,500	39,000	31,800	22,500	26,000	39,000	15,000	26,000
5/8	22,600	18,100	39,100	32,000	22,600	58,700	47,900	33,900	58,700	47,900	33,900	39,100	58,700	22,600	39,100
3/4	35,300	28,300	61,100	49,900	35,300	91,700	74,900	53,000	91,700	74,900	53,000	61,100	91,700	35,300	61,100

American Society of Mechanical Engineers ASME B30.9, the National Association of Chain Manufacturers (NACM) and the Occupation Safety & Health Administration (OSHA) recommend only the use of alloy steel chain for overhead lifting, i.e. sling chain. Slings may be constructed by the user using Herc-Alloy® chain, Herc-Alloy 1000 or Herc-Alloy 800 chain and attachments.

For more information on standard sling configurations, see page 31 or visit us online at www.cmworks.com

HERC-ALLOY® 1000
 CHAIN SLINGS &
 COMPONENTS



MASTER LINK DUAL RATED FOR USE WITH HA800 OR HA1000

WORKING LOAD LIMIT: 5,400 TO 105,900 LBS.

BENEFITS & FEATURES

- Accepts both Herc-Alloy® 1000 & 800 chain and components
- Durable orange powder coated finish
- May be used for mechanical and welded sling assemblies
- 100% proof tested
- 4:1 design factor
- Conforms to the new lower hardness offshore requirement

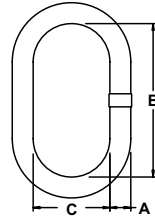
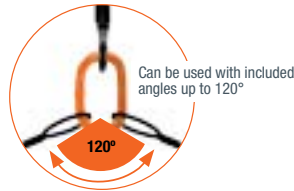

Trade Size (in.)	Working Load Limit (lbs.)	Catalog Number	Product Code	Nominal Dimensions (in.)			Weight (lbs.)	Type and Size of Chain Sling on Which Used (in.)			
				Material Diameter A	Inside Length B	Inside Width C		Single	Double	Triple	Quad
13/32	5,400	HA40	555231	0.41	3.00	1.50	0.33	7/32	7/32	–	–
1/2	8,600	HA50	555232	0.56	5.00	2.50	1.02	9/32	9/32	7/32	7/32
3/4	17,600	HA75	555235	0.75	5.50	2.75	2.08	3/8	3/8	9/32	9/32
1	30,000	HA100	555238	1.00	7.00	3.50	4.59	1/2 & 5/8	1/2	3/8	3/8
1-1/4	45,200	HA125	555240	1.25	8.75	4.38	9.31	3/4	5/8	1/2	1/2
1-1/2	70,600	HA150	555243	1.50	10.50	5.25	15.60	–	3/4	5/8	5/8
1-3/4	105,900	HA175	555246	1.75	12.00	6.00	24.40	–	–	3/4	3/4

SUB-ASSEMBLY DUAL RATED FOR USE WITH HA800 OR HA1000

WORKING LOAD LIMIT: 7,000 TO 91,700 LBS.

BENEFITS & FEATURES

- Designed for triple and quad branch Herc-Alloy® chain slings
- Consists of an oblong master link and two welded master coupling links
- Accepts both Herc-Alloy 1000 & 800 chain and components
- Durable orange powder coated finish
- May be used for mechanical or welded sling assemblies
- 100% proof tested
- 4:1 design factor
- Conforms to the new lower hardness offshore requirement

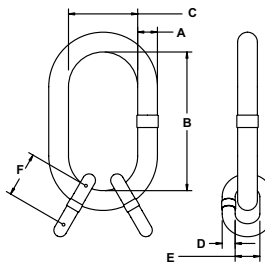
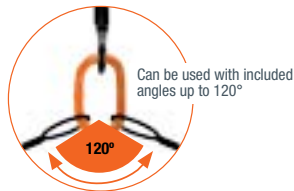

Trade Size (in.)	Working Load Limit at 60° (lbs.)	Catalog Number	Product Code	Master Link Nominal Dimensions (in.)			Intermediate Link Nominal Dimensions (in.)			Weight (lbs.)	Type and Size of Chain Sling on Which Used (in.)	
				Material Diameter A	Inside Length B	Inside Width C	Material Diameter D	Inside Width E	Inside Length F		Triple	Quad
1/2	7,000	SA050	555274	0.56	5.00	2.50	0.44	1.06	1.75	1.35	7/32	7/32
3/4	11,200	SA075	555275	0.75	5.50	2.75	0.47	0.88	1.56	2.64	9/32	9/32
1	22,900	SA100	555276	1.00	7.00	3.50	0.78	1.50	2.63	7.25	3/8	3/8
1-1/4	39,000	SA125	555277	1.25	8.75	4.38	0.91	1.75	3.13	13.51	1/2	1/2
1-1/2	58,700	SA150	555278	1.50	10.50	5.25	1.13	2.25	4.00	24.28	5/8	5/8
1-3/4	91,700	SA175	555279	1.75	12.00	6.00	1.50	2.75	5.25	44.58	3/4	3/4

HERC-ALLOY® 1000
CHAIN SLINGS & COMPONENTS





PEAR SHAPED MASTER LINK HERC-ALLOY® 1000

WORKING LOAD LIMIT: 9,000 TO 125,200 LBS.

BENEFITS & FEATURES

- Made from alloy material
- Proof tested at two times WLL
- Durable orange powder coated finish
- Custom sizes available upon request
- 4:1 design factor

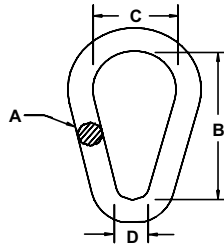

Trade Size (in.)	Working Load Limit (lbs.)	Product Code	Nominal Dimensions (in.)				Weight (lbs.)	Type and Size of Chain Sling		
			Diameter A	Inside Length B	Inside Width C	Inside Width D		Single (in.)	Double (in.)	Triple (in.)
1/2	9,000	554702	0.56	5.31	2.50	1.25	0.81	7/32, 9/32 & 3/8	7/32 & 9/32	7/32
3/4	18,000	554706	0.75	5.63	2.75	2.00	2.08	1/2	3/8	9/32
1	30,300	554710	1.00	7.25	3.50	2.63	4.59	5/8	1/2	3/8
1-1/4	45,500	554714	1.25	8.75	4.63	3.25	9.17	3/4	5/8	1/2
1-1/2	71,200	554719	1.50	10.50	5.25	3.88	15.28	-	3/4	5/8
1-3/4	86,000	554723	1.75	12.00	6.00	4.50	23.93	-	-	-
2	120,000	554726	2.00	14.00	7.00	3.50	35.93	-	-	3/4
2-1/4	125,200	554731	2.25	16.00	8.00	6.00	52.83	-	-	-

EZ·CONNECT™ MASTER LINK & CHAIN SHORTENER DUAL RATED FOR USE WITH HA800 OR HA1000



WORKING LOAD LIMIT: 9,000 TO 125,200 LBS.

BENEFITS & FEATURES

- Fits Grade 80 and Grade 100 chain
- Durable orange powder coated finish
- Allows you to adjust sling legs quickly and easily, utilizing the same sling for various reaches
- Chain shortener features cradle hook to ensure full load seating for safe operation.
- Does not require the sling to be de-rated.
- Ability to use 30° to 60° angles, preventing dangerous side loading
- 4:1 design factor
- Conforms to the new lower hardness offshore requirement

FOR SINGLE LEG SLING

Product Code	Chain Size (in.)	Working Load Limit @ 90° (lbs.)	Weight (lbs.)	Nominal Dimensions (in.)							
				Master Link			Shortener		Overall Reach		
				Material Dia. A	Width B	Pitch C	Pitch D	Pitch E	F	G	
555232S1	9/32	4,300	1.9	0.56	2.50	5.00	4.76	3.38	8.38	9.76	
555235S1	3/8	8,800	4.6	0.75	2.75	5.50	6.25	4.74	10.24	11.75	
555238S1	1/2	15,000	9.6	1.00	3.50	7.00	7.57	5.82	12.82	14.57	
555239S1	5/8	22,600	12.8	1.00	3.50	7.00	9.32	7.04	14.04	16.32	

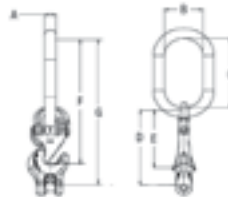

FOR DOUBLE LEG SLING

Product Code	Chain Size (in.)	Working Load Limit			Weight (lbs.)	Nominal Dimensions (in.)						
		60°	45°	30°		Master Link			Shortener		Overall Reach	
		Material Dia. A	Width B	Pitch C		Pitch D	Pitch E	F	G			
555232S2	9/32	7,400	6,100	4,300	3.0	0.562	2.50	5.00	4.76	3.38	8.38	9.76
555235S2	3/8	15,200	12,400	8,800	7.1	0.75	2.75	5.50	6.25	4.74	10.24	11.75
555238S2	1/2	26,000	21,200	15,000	14.5	1.00	3.50	7.00	7.57	5.82	12.82	14.57
555240S2	5/8	39,100	32,000	22,600	26.6	1.25	4.38	8.75	9.32	7.04	15.79	18.07

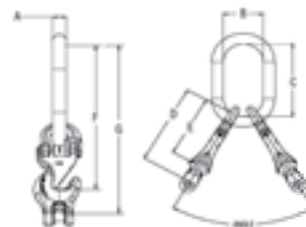

HERC-ALLOY® 1000
 CHAIN SLINGS & COMPONENTS



HAMMERLOK® DUAL RATED FOR USE WITH HA800 OR HA1000

WORKING LOAD LIMIT: 2,700 TO 35,300 LBS.

BENEFITS & FEATURES

- Used for overhead lifting slings to connect chain branches to the master link and the hook to attachments
- Constructed of drop forged alloy steel
- Can be used with Grade 100 and Grade 80 chain
- Must be matched to chain size
- Do not use for chain repair or splicing
- Meets ASTM A952 standards
- 4:1 design factor



Size (in.)	Working Load Limit (lbs.)	Product Code	Load Pin Kit Product Code	Dimensions (in.)								Weight (lbs.)
				A (Max)	B (Max)	C	D	E	F	G		
7/32	2,700	667021-2	R667021-2	0.29	0.28	1.85	0.69	0.61	1.44	0.52	0.27	
9/32	4,300	667028-2	R667028-2	0.37	0.44	1.94	0.69	0.68	1.58	0.61	0.28	
3/8	8,800	667038-2	R667038-2	0.52	0.50	3.02	1.15	1.05	2.33	0.81	0.84	
1/2	15,000	667050-2	R667050-2	0.64	0.68	3.79	1.43	1.29	2.98	1.10	1.87	
5/8	22,600	667062-2	R667062-2	0.81	0.91	4.50	1.70	1.54	3.57	1.32	3.13	
3/4	35,300	667075-2	R667075-2	0.97	1.07	5.36	2.06	1.78	4.69	1.52	5.75	

CHAIN SHORTENER HERC-ALLOY® 1000

WORKING LOAD LIMIT: 4,300 TO 22,600 LBS.

BENEFITS & FEATURES

- Quickly and easily adjust chain length of sling when the load has uneven pick points
- Durable orange powder coated finish
- Marked with both fraction and metric sizes
- Forged alloy steel – quenched & tempered
- Mechanically attaches directly to master ring
- 4:1 design factor

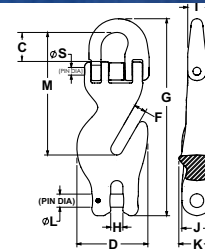

Size (in.)	Working Load Limit (lbs.)	Product Code	Standard Package	Dimensions (in.)												Weight (lbs.)
				C	D	G	H	J	K	L	F	M	S	T		
9/32	4,300	M71805A-2	10	0.69	2.16	5.86	0.38	0.80	1.00	0.36	0.38	3.38	0.21	0.54	1.20	
3/8	8,800	M71806A-2	10	1.15	2.74	7.61	0.47	1.17	1.41	0.51	0.47	4.74	0.31	0.71	2.50	
1/2	15,000	M71808A-2	10	1.43	3.34	9.36	0.65	1.38	2.07	0.63	0.65	5.82	0.41	0.93	4.80	
5/8	22,600	M71810A-2	5	1.74	4.19	11.56	0.79	1.53	2.46	0.75	0.79	7.04	0.48	1.06	8.20	

Note: If used as a choker, working load limit should be reduced by 20%.

OMEGALOK CONNECTOR DUAL RATED FOR USE WITH HA800 OR HA1000

WORKING LOAD LIMIT: 3,500 TO 22,600 LBS.

BENEFITS & FEATURES

- Fraction and metric markings
- Durable orange powder coated finish
- 100% proof tested
- For use with master link with flats (see page 77)
- 4:1 design factor

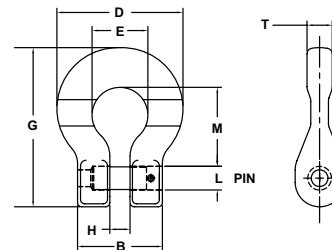

Size (in.)	Working Load Limit (lbs.)	Standard Package	Product Code			Dimensions (in.)									Weight (lbs.)
			Completed Unit	Load Pin	Retainer Pin	B	D	E	G	H	L	M	T		
9/32	4,300	12	644128	595780	602326	1.36	2.30	0.98	2.81	0.33	0.36	1.45	0.43	0.55	
3/8	8,800	12	644138	595781	495821	1.90	2.82	1.25	3.57	0.45	0.51	1.77	0.57	1.18	
1/2*	15,000	12	644150	595782	495822	2.31	3.52	1.56	4.44	0.59	0.63	2.26	0.70	2.00	
5/8*	22,600	5	644162	595785	495823	2.87	4.46	2.00	5.45	0.75	0.75	2.72	0.88	3.76	

* Grade 80 only



RIGGING HOOK DUAL RATED FOR USE WITH HA800 OR HA1000

WORKING LOAD LIMIT: 2,700 TO 22,600 LBS.

BENEFITS & FEATURES

- For use with both Grade 80 & 100 chain
- Large eye to easily accommodate other fittings
- Quenched & tempered alloy steel
- Durable orange powder coated finish
- 5:1 design factor

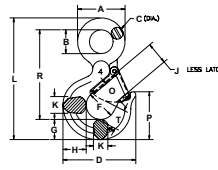

Size (in.)	Working Load Limit (lbs.)	Product Code			Standard Package	Dimensions (in.)														Weight (lbs.)
		With Latch	Without Latch	Latch Kit		A	B	C	D	F	G	H	J	K	L	O	P	R	T	
7/32	2,700	M7502A	M7402A	4X1302	10	1.50	0.74	0.38	3.12	1.25	0.87	1.01	0.93	0.63	4.37	0.93	2.13	3.12	0.87	0.66
9/32	4,300	M7503A	M7403A	4X1303	10	1.75	0.86	0.45	3.37	1.38	0.94	1.11	0.97	0.71	5.04	0.97	2.27	3.66	0.97	1.12
5/16	5,700	M7504A	M7404A	4X1304	10	2.13	1.10	0.52	3.79	1.50	1.07	1.23	1.02	0.88	5.65	1.02	2.56	4.08	1.03	1.46
3/8	8,800	M7505A	M7405A	4X1305	10	2.50	1.23	0.64	4.24	1.63	1.26	1.43	1.19	0.94	6.54	1.16	2.85	4.67	1.21	2.42
1/2	15,000	M7507A	M7407A	4X1307	5	3.08	1.55	0.77	5.10	2.00	1.44	1.63	1.50	1.38	7.98	1.41	3.47	5.77	1.47	4.10
5/8	22,600	M7509A	M7409A	4X1309	5	3.88	1.98	0.95	6.24	2.50	1.82	2.01	1.78	1.68	10.07	1.69	4.59	7.31	1.71	8.16

CLEVLOK® SLING HOOK DUAL RATED FOR USE WITH HA800 OR HA1000



WORKING LOAD LIMIT: 2,700 TO 35,300 LBS.

BENEFITS & FEATURES

- For use with both Grade 80 & 100 chain
- Fatigue rated to Grade 100 specifications
- 100% proof tested
- Durable orange powder coated finish
- Improved forged latch
- New CE compliant hooks and latches
- Meets EN 1677
- Fraction and metric markings
- 4:1 design factor

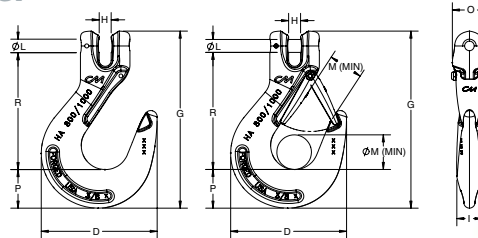

Size (in.)	Working Load Limit (lbs.)	Standard Package	Product Code					Dimensions (in.)											Weight (lbs.)
			With Latch	Without Latch	Latch Kit	Alloy Load Pin	Retaining Pin	D	G	H	I	L	M	O	P	R			
7/32	2,700	10	657716	557716	4X455321	SP595778	495826	3.05	5.00	0.31	0.66	0.28	0.96	1.13	0.94	3.45	1.10		
9/32	4,300	10	657718	557718	4X455322	595780SP	495825	3.53	5.55	0.38	0.75	0.36	0.83	1.32	1.11	3.75	1.20		
3/8	8,800	10	657719	557719	4X455325	595781	495825	4.54	6.93	0.47	1.00	0.51	1.06	1.34	1.51	4.58	2.21		
1/2	15,000	5	657720	557720	4X455328	595782	495823	5.48	8.28	0.58	1.33	0.63	1.38	1.87	1.55	5.59	4.22		
5/8	22,600	5	657721	557721	4X455329	SP595783P	495849	6.20	9.61	0.71	1.47	0.75	1.69	2.11	1.83	6.44	6.64		
3/4	35,300	Bulk	657722	557722	4X455330	595786	495824	7.63	11.79	0.88	1.88	0.94	2.09	2.55	2.51	7.74	11.22		

EYE SLING HOOK DUAL RATED FOR USE WITH HA800 OR HA1000



WORKING LOAD LIMIT: 2,700 TO 35,300 LBS.

BENEFITS & FEATURES

- For use with both Grade 80 & 100 chain
- Fatigue rated to Grade 100 specifications
- Available with or without latch
- Durable orange powder coated finish
- 100% proof tested
- Fraction and metric markings
- 4:1 design factor

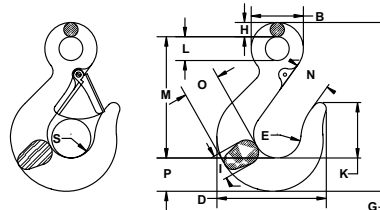

Size (in.)	Working Load Limit (lbs.)	Product Code			Standard Package	Dimensions (in.)											Weight (lbs.)		
		With Latch	Without Latch	Latch Kit		B	D	E	G	H	I	K	L	M	N	O		P	S
7/32	2,700	558618	458618	4X458321	10	1.50	3.04	1.30	5.06	0.38	0.66	1.47	0.75	3.75	0.97	0.99	0.94	0.99	0.8
9/32	4,300	558622	458622	595523	10	1.65	3.48	1.50	5.25	0.45	0.75	1.75	0.72	3.75	1.19	1.21	1.05	1.10	1.1
3/8	8,800	558625	458625	595525	10	2.06	4.33	1.88	6.66	0.58	0.97	2.19	0.91	4.77	1.44	1.46	1.31	1.29	1.9
1/2	15,000	558628	458628	595528	5	2.63	5.50	2.25	8.16	0.77	1.10	2.56	1.09	5.67	1.78	1.91	1.68	1.63	4.5
5/8	22,600	558629	458629	595529	5	3.06	6.23	2.63	9.63	0.89	1.46	2.62	1.31	6.50	2.03	2.20	2.23	1.69	7.3
3/4	35,300	558630	458630	595530	Bulk	3.50	7.82	3.00	11.38	1.00	1.69	3.47	1.50	7.81	2.50	2.82	2.58	2.31	11.4



CLEVLOK® CRADLE GRAB HOOK

DUAL RATED FOR USE WITH HA800 OR HA1000

WORKING LOAD LIMIT: 2,700 TO 35,300 LBS.

BENEFITS & FEATURES

- For use with both Grade 80 & 100 chain
- Meets ASTM A952 standards
- 100% proof tested
- Durable orange powder coated finish
- Fraction and metric markings
- 4:1 design factor

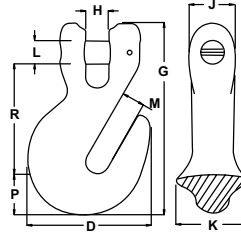

Size (in.)	Working Load Limit (lbs.)	Product Code	Standard Package Quantity	Dimensions (in.)									Weight (lbs.)
				D	G	H	J	K	L	M	P	R	
7/32	2,700	659718	10	1.62	3.21	0.31	0.75	0.94	0.28	0.31	0.62	1.98	0.50
9/32	4,300	659722	10	2.18	3.39	0.38	0.82	0.97	0.36	0.38	0.82	1.86	0.63
3/8	8,800	659725	10	2.72	4.33	0.47	1.18	1.29	0.51	0.74	1.03	2.47	1.30
1/2	15,000	659728	5	3.65	5.27	0.65	1.39	2.01	0.63	0.60	1.19	3.04	2.10
5/8	22,600	659729	5	4.50	6.54	0.77	1.55	2.42	0.75	0.77	1.41	3.76	4.20
3/4	35,300	659730	Bulk	5.40	8.80	0.88	2.05	2.69	0.88	0.91	1.89	5.30	10.50

Note: If used as a choker, working load limit should be reduced by 20%. Reference CM Rigging Guide for more details.

HERC-ALLOY® 1000
CHAIN SLINGS & COMPONENTS



EYE CRADLE GRAB HOOK

DUAL RATED FOR USE WITH HA800 OR HA1000

WORKING LOAD LIMIT: 2,700 TO 35,300 LBS.

BENEFITS & FEATURES

- For use with both Grade 80 & 100 chain
- Meets ASTM A952 standards
- 100% proof tested
- Durable orange powder coated finish
- Fraction and metric markings
- 4:1 design factor

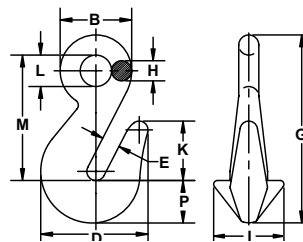

Size (in.)	Working Load Limit (lbs.)	Product Code	Standard Package Quantity	Dimensions (in.)									Weight (lbs.)	
				B	D	E	G	H	I	K	L	M		P
7/32	2,700	559724	10	1.20	1.68	0.31	3.22	0.33	0.92	0.99	0.55	2.20	0.69	0.35
9/32	4,300	559725	10	1.40	1.93	0.37	3.72	0.39	1.07	1.15	0.63	2.58	0.76	0.55
3/8	8,800	559737	10	1.78	2.86	0.47	4.81	0.52	1.38	1.66	0.75	3.27	1.02	1.39
1/2	15,000	559750	5	2.28	3.69	0.59	6.36	0.63	1.81	2.15	1.06	4.23	1.53	3.05
5/8	22,600	559762	5	2.75	4.53	0.75	7.62	0.75	2.13	2.65	1.25	5.06	1.80	4.36
3/4	35,300	559775	Bulk	3.50	5.23	0.91	9.54	1.00	2.88	3.55	1.52	6.70	1.85	9.00

Note: If used as a choker, working load limit should be reduced by 20%.



CLEVLOK® FOUNDRY HOOK HERC-ALLOY® 1000

WORKING LOAD LIMIT: 4,300 TO 35,300 LBS.

BENEFITS & FEATURES

- Clevlok® head designed for easy assembly
- "I" beam body design increases grip when removing from load
- Quenched & tempered alloy steel
- Individually proof tested
- Durable orange powder coated finish
- 4:1 design factor

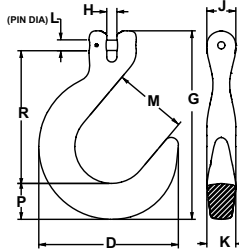

Size (in.)	Working Load Limit (lbs.)	Clevlok Foundry Hook			Alloy Load Pin Product Code	Retaining Pin Product Code	Dimensions (in.)									
		Product Code	Standard Package Quantity	Weight (lbs.)			D	G	H	J	K	L	M	P	R	
9/32	4,300	475798	5	2.43	595780	602326	4.82	6.52	0.35	1.00	1.00	0.36	2.55	1.24	4.59	
3/8	8,800	475799	5	4.14	595781	495821T	5.73	7.87	0.47	1.16	1.27	0.51	3.05	1.43	5.59	
1/2	15,000	475800	5	7.10	SP595782	495823	6.83	9.40	0.59	1.50	1.50	0.63	3.55	1.75	6.58	
5/8	22,600	475801	5	12.03	595785	495823	7.94	10.98	0.70	1.74	1.81	0.75	4.07	2.03	7.69	
3/4	35,300	475802	5	21.00	495784	495824	9.17	13.20	0.88	2.05	2.00	0.91	4.50	2.63	8.87	

HERC-ALLOY® 1000
CHAIN SLINGS & COMPONENTS

EYE FOUNDRY HOOK DUAL RATED FOR USE WITH HA800 OR HA1000

WORKING LOAD LIMIT: 4,300 TO 35,300 LBS.

BENEFITS & FEATURES

- For use with both Grade 80 & 100 chain
- Throat opening to 4.5" (114 mm)
- Meets ASTM A952 standards
- Durable orange powder coated finish
- 100% proof tested
- For welded 7/32" chain sling use 9/32" eye foundry hook
- 4:1 design factor

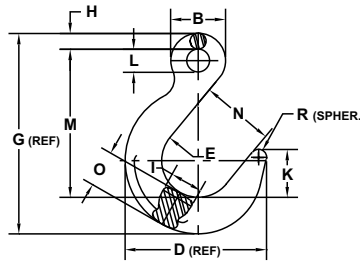

Size (in.)	Working Load Limit (lbs.)	Product Code	Standard Package Quantity	Dimensions (in.)												Weight (lbs.)
				B	D	E	G	H	I	K	L	M	N	O	R	
9/32	4,300	474798	5	1.56	4.73	2.50	6.45	0.47	1.00	1.56	0.63	4.75	2.50	1.23	0.25	2.4
3/8	8,800	474799	5	2.00	5.72	3.00	7.88	0.63	1.27	1.88	0.80	5.77	3.00	1.50	0.31	4.5
1/2	15,000	474800	5	2.50	6.74	3.50	9.38	0.75	1.50	2.22	1.00	6.88	3.50	1.75	0.38	7.1
5/8	22,600	474801	5	3.00	7.79	4.00	10.97	0.88	1.81	2.63	1.13	8.06	4.00	2.03	0.44	11.6
3/4	35,300	474802	Bulk	3.50	9.07	4.50	12.81	1.00	2.20	3.00	1.50	9.25	4.50	2.56	0.50	20.0

LATCHLOK® HOOK USE

Working load limits are based on chain size. Hooks are embossed with the chain size they attach to and are not embossed with the working load limit (WLL).

Example: A 9/32" hook embossed (HA1000 9/32") means it's a Grade 100 hook for 9/32" Grade 100 chain with a working load limit of 4,300 lbs. If you are putting it on Grade 80 chain you derate to the 9/32" Grade 80 rating of 3,500 lbs.

The chart below shows the working load limit of Latchlok® hooks when used with Grade 100 and Grade 80 chain slings. It also provides working load limit information for these hooks when used with synthetic web, round or wire rope slings.

Attachment Type	Hook Size: 9/32" Maximum WLL: 4,300 lbs.		Hook Size: 3/8" Maximum WLL: 8,800 lbs.		Hook Size: 1/2" Maximum WLL: 15,000 lbs.		Hook Size: 5/8" Maximum WLL: 22,600 lbs.	
	Size (in.)	WLL 4:1 (lbs.)	Size (in.)	WLL 4:1 (lbs.)	Size (in.)	WLL 4:1 (lbs.)	Size (in.)	WLL 4:1 (lbs.)
When used with Herc-Alloy® chain use the working load limits stated below. Chain WLL are based on 4:1 design.								
Herc-Alloy® 800 Chain	9/32	3,500	3/8	7,100	1/2	12,000	5/8	18,000
Herc-Alloy® 1000 Chain	9/32	4,300	3/8	8,800	1/2	15,000	5/8	22,600
Synthetic web, round and wire rope slings have a 5:1 design factor. If you wish to use these hooks with these slings and maintain the 5:1 sling design factor, use the WLL below.								
Synthetic Web, Round and Wire Rope Slings	9/32	3,500	3/8	7,100	1/2	12,000	5/8	18,000

Always use proper connecting hardware with web, round and wire rope slings. Never choke slings in the eye of the hook.

CLEVLOK® STYLE LATCHLOK® HOOK HERC-ALLOY® 1000

WORKING LOAD LIMIT: 4,300 TO 22,600 LBS.

BENEFITS & FEATURES

- High-cycling, long-life spring
- 100% proof tested
- Meets ASTM A952 standards
- Durable orange powder coated finish
- Positive locking hook
- 4:1 design factor

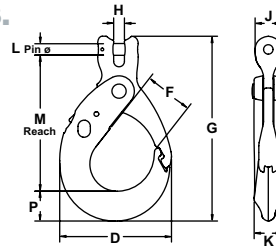

Size (in.)	Working Load Limit (lbs.)	Product Code	Replace Latch Kit Part #	Dimensions (in.)									Weight (lbs.)
				H	M	P	D	F	J	K	G	L	
9/32	4,300	M616005	656005	0.35	5.05	0.88	3.77	1.64	1.00	0.91	6.61	0.36	2.40
3/8	8,800	M616010	656010	0.45	6.08	1.07	4.76	2.26	1.17	1.15	7.98	0.51	4.20
1/2	15,000	M616015	656015	0.59	7.88	1.58	6.26	2.91	1.50	1.47	10.54	0.63	9.00
5/8	22,600	M616020	656020	0.71	8.96	1.97	7.37	3.22	1.74	1.85	12.19	0.75	14.00

EYE STYLE LATCHLOK® HOOK HERC-ALLOY® 1000

WORKING LOAD LIMIT: 4,300 TO 22,600 LBS.

BENEFITS & FEATURES

- Large eye design for use with chain, wire rope and synthetic material
- 100% proof tested
- Meets ASTM A952 standards
- Durable orange powder coated finish
- For welded 7/32" chain sling use 9/32" eye Lodelok hook
- Positive locking hook
- 4:1 design factor

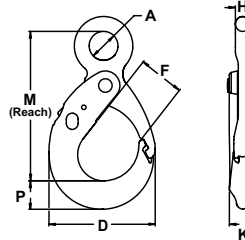

Size (in.)	Working Load Limit (lbs.)	Product Code	Replace Latch Kit Part #	Dimensions (in.)							Weight (lbs.)
				A	M	P	D	F	H	K	
9/32	4,300	M626005	656005	1.09	5.37	0.88	3.77	1.64	0.47	0.91	2.50
3/8	8,800	M626010	656010	1.36	6.65	1.07	4.74	2.27	0.59	1.15	4.74
1/2	15,000	M626015	656015	1.57	8.79	1.58	6.26	2.91	0.80	1.47	10.00
5/8	22,600	M626020	656020	2.00	10.37	1.97	7.37	3.22	1.03	1.85	16.00



SWIVEL STYLE LATCHLOK® HOOKS

HERC-ALLOY® 1000

WORKING LOAD LIMIT: 4,300 TO 22,600 LBS.

BENEFITS & FEATURES OF BOTH STYLES

- The eye easily positions to attach to the load
- 100% proof tested
- Meets ASTM A952 standards
- Certification of test available
- Durable orange powder coated finish
- For welded 7/32" chain sling use 9/32" swivel Lodelok hook
- Positive locking hook
- 4:1 design factor

► DID YOU KNOW?

BEARING VS. BUSHING STYLE SWIVEL HOOKS

BEARING SWIVEL HOOKS

The load may be swiveled and turned into position WITH or WITHOUT the load attached.

BUSHING SWIVEL HOOKS

The load must be swiveled and turned into position BEFORE attaching, lifting or moving a load.

For more information, visit us at www.cmworks.com



BEARING STYLE SWIVEL HOOK



BUSHING STYLE SWIVEL HOOK

BEARING SWIVEL STYLE

Size (in.)	Working Load Limit (lbs.)	Product Code	Replace Latch Kit Part #	Dimensions (in.)								Weight (lbs.)
				H	M	P	D	F	A	B	K	
9/32	4,300	M696005	656005	0.62	7.43	0.88	3.77	1.64	1.50	1.31	0.91	3.5
3/8	8,800	M696010	656010	0.77	9.11	1.07	4.76	2.26	1.75	1.62	1.15	4.8
1/2	15,000	M696015	656015	0.93	11.49	1.58	6.26	2.91	2.25	1.82	1.47	10.7
5/8	22,600	M696020	656020	1.00	13.73	1.97	7.37	3.22	2.50	2.16	1.85	17.4

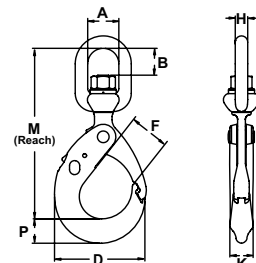

BUSHING SWIVEL STYLE

Size (in.)	Working Load Limit (lbs.)	Product Code	Replace Latch Kit Part #	Dimensions (in.)								Weight (lbs.)
				H	M	P	D	F	A	B	K	
9/32	4,300	M676005	656005	0.62	7.17	0.88	3.77	1.64	1.50	1.33	0.91	3.5
3/8	8,800	M676010	656010	0.77	8.73	1.07	4.76	2.26	1.75	1.63	1.15	4.8
1/2	15,000	M676015	656015	0.93	11.18	1.58	6.26	2.91	2.00	1.76	1.47	10.6
5/8	22,600	M676020	656020	1.00	13.35	1.97	7.37	3.22	2.75	2.38	1.85	17.0

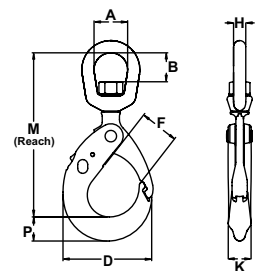

HERC-ALLOY® 1000
CHAIN SLINGS & COMPONENTS

► INSPECTION, CARE & USE

USING LATCHLOK® HOOKS SAFELY

- ▲ Do not apply load unless latch and hook are completely closed and locked
- ▲ Make certain that the latch does not support any part of the load
- ▲ When lifting, make certain that the load is firmly seated in the base (bowl) of the hook
- ▲ Inspect hook and latch periodically. If the hook or latch is damaged or if the latch fails to interlock with the tip, the hook should be removed from service
- ▲ Do not exceed the working load limit
- ▲ Do not use if the hook is visibly distorted, damaged or worn
- ▲ Keep body and other objects clear of the latch when closing to avoid the pinch point
- ▲ Do not side load or tip load hook
- ▲ User should be properly trained and understand safe rigging practices

For more information, visit us at www.cmworks.com









HERC-ALLOY 800®

Columbus McKinnon has a long history of developing innovative products that have changed the material handling industry – including the development of the first alloy chain in 1933. This alloy chain eventually replaced the industry-standard wrought iron chain used for overhead lifting and is the predecessor to today’s Herc-Alloy 800® chain, hooks and overhead lifting attachments. Made in America, CM Herc-Alloy® products are made of superior triple alloy steel that provides the best strength-to-weight performance in the industry. These products also meet and exceed ASTM A391 standards.

Herc-Alloy® is now one of the most recognized and trusted brands in the rigging industry and is only offered by Columbus McKinnon.

HERC-ALLOY 800® PRODUCT OVERVIEW

The chart below is an overview of our most popular Herc-Alloy 800® products. Our full product offering, including detailed specifications and available sizes, can be found on the product pages within this section.

	Chain Size (in.)		Working Load Limit (lbs.)	COMPONENTS							
				Chain (Per Ft.)	Chain (Drum)	Master Link	Master Link w/Flats	Sub- Assembly	Sub- Assembly w/Flats	Hammerlok®	Weblok™ Assembly
	(in.)	(mm.)		Page 74	Page 74	Page 76	Page 76	Page 78	Page 78	Page 80	Page 80
											
Single at 90°	7/32	5.5	2,100	607020	677010	555231	ML040	–	–	664021-2	–
	9/32	7	3,500	607028	677011	555232	ML040	–	–	664028-2	–
	3/8	10	7,100	607037	677013	555235	ML063	–	–	664038-2	–
	1/2	13	12,000	607050	677015	555238	ML075	–	–	664050-2	–
	5/8	16	18,100	607062	677016	555238	ML100	–	–	664062-2	–
	3/4	20	28,300	607075	677017	555240	ML125	–	–	664075-2	867025-4
	7/8	23	34,200	607087	677018	554943	ML125	–	–	664089-2	867030-4
	1	26	47,700	607101	677019	554946	ML150	–	–	664100-2	867035-4
1-1/4	32	72,300	607128	677070	554949	ML200	–	–	664125-2	–	
Double at 60°	7/32	5.5	3,600	607020	677010	555231	ML050	–	–	664021-2	–
	9/32	7	6,100	607028	677011	555232	ML063	–	–	664028-2	–
	3/8	10	12,300	607037	677013	555235	ML075	–	–	664038-2	–
	1/2	13	20,800	607050	677015	555238	ML100	–	–	664050-2	–
	5/8	16	31,300	607062	677016	555240	ML125	–	–	664062-2	–
	3/4	20	49,000	607075	677017	555243	ML150	–	–	664075-2	–
	7/8	23	59,200	607087	677018	554946	ML175	–	–	664089-2	–
	1	26	82,600	607101	677019	554949	ML200	–	–	664100-2	–
1-1/4	32	125,200	607128	677070	554951	ML250	–	–	664125-2	–	
Triple & Quad at 60°	7/32	5.5	5,500	607020	677010	–	–	555274	SA063	664021-2	–
	9/32	7	9,100	607028	677011	–	–	555275	SA075	664028-2	–
	3/8	10	18,400	607037	677013	–	–	555276	SA100	664038-2	–
	1/2	13	31,200	607050	677015	–	–	555277	SA125	664050-2	–
	5/8	16	47,000	607062	677016	–	–	555278	SA175	664062-2	–
	3/4	20	73,500	607075	677017	–	–	555279	SA200	664075-2	–
	7/8	23	88,900	607087	677018	–	–	554980	SA225	664089-2	–
	1	26	123,900	607101	677019	–	–	554981	SA250	664100-2	–
1-1/4	32	187,800	607128	677070	–	–	554983	SA300	664125-2	–	



To help customers reduce and better manage their rigging inventory, Columbus McKinnon has developed several **DUAL-RATED RIGGING ATTACHMENTS** that can be used for both Grade 80 and 100 applications.



	Chain Size (in.)		Clevlok® Sling Hook w/Latch	Clevlok® Sling Hook w/o Latch	Eye Sling Hook w/Latch	Eye Sling Hook w/o Latch	Clevlok® Grab Hook	Clevlok® Cradle Grab Hook	Eye Cradle Grab Hook	Eye Foundry Hook
	(in.)	(mm.)	Page 81	Page 81	Page 81	Page 81	Page 82	Page 82	Page 83	Page 83
Single at 90°	7/32	5.5	657716	557716	558618	458618	659718	-	559724	-
	9/32	7	657718	557718	558622	458622	659722	659222	559725	474798
	3/8	10	657719	557719	558625	458625	659725	659225	559737	474799
	1/2	13	657720	557720	558628	458628	659728	659228	559750	474800
	5/8	16	657721	557721	558629	458629	659729	659229	559762	474801
	3/4	20	657722	557722	558630	458630	-	659430	559775	474802
	7/8	23	-	-	558332	458732	-	-	559387	474503
	1	26	-	-	558333	458733	-	-	559100	474504
1-1/4	32	-	-	558335	458735	-	-	559124	474505	
Double at 60°	7/32	5.5	657716	557716	558618	458618	659718	-	559724	-
	9/32	7	657718	557718	558622	458622	659722	659222	559725	474798
	3/8	10	657719	557719	558625	458625	659725	659225	559737	474799
	1/2	13	657720	557720	558628	458628	659728	659228	559750	474800
	5/8	16	657721	557721	558629	458629	659729	659229	559762	474801
	3/4	20	657722	557722	558630	458630	-	659430	559775	474802
	7/8	23	-	-	558332	458732	-	-	559387	474503
	1	26	-	-	558333	458733	-	-	559100	474504
1-1/4	32	-	-	558335	458735	-	-	559124	474505	
Triple & Quad at 60°	7/32	5.5	657716	557716	558618	458618	659718	-	559724	-
	9/32	7	657718	557718	558622	458622	659722	659222	559725	474798
	3/8	10	657719	557719	558625	458625	659725	659225	559737	474799
	1/2	13	657720	557720	558628	458628	659728	659228	559750	474800
	5/8	16	657721	557721	558629	458629	659729	659229	559762	474801
	3/4	20	657722	557722	558630	458630	-	659430	559775	474802
	7/8	23	-	-	558332	458732	-	-	559387	474503
	1	26	-	-	558333	458733	-	-	559100	474504
1-1/4	32	-	-	558335	458735	-	-	559124	474505	

Sling ID Tags available. See page 75 for details.



HERC-ALLOY 800® CHAIN

WORKING LOAD LIMIT: 2,100 TO 72,300 LBS.

BENEFITS & FEATURES

- A higher strength heat treated alloy steel chain primarily used as a sling component for overhead lifting
- Can be used in rigging and tie down applications where a lighter weight, higher strength chain is desirable
- Recommended for overhead lifting by NACM, ASME, and OSHA
- 4:1 design factor

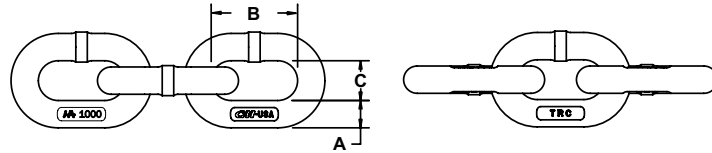

Chain Size (in.)	Working Load Limit (lbs.)	Nominal Chain Dimensions (in.)			Per Foot			Per Drum		
		Material Diameter A	Inside Length B	Inside Width C	Product Code	Weight (lbs./ft.)	Approximate Number of Links (per ft.)	Product Code	Length (ft.)	Weight (lbs.)
7/32	2,100	0.22	0.68	0.31	607020	0.44	17.8	677010	800	354
9/32	3,500	0.28	0.88	0.40	607028	0.73	13.6	677011	500	365
5/16	4,500	0.33	1.02	0.46	607031	0.91	11.8	-	-	-
3/8	7,100	0.39	1.25	0.57	607037	1.44	9.6	677013	500	719
1/2	12,000	0.51	1.44	0.73	607050	2.55	8.3	677015	300	765
5/8	18,100	0.63	1.78	0.86	607062	3.82	6.8	677016	200	765
3/4	28,300	0.79	2.23	1.07	607075	5.95	5.4	677017	100	595
7/8	34,200	0.88	2.25	1.14	607087	7.76	5.3	677018	100	776
1	47,700	1.00	3.07	1.49	607101	9.41	3.9	677019	100	941
1-1/4	72,300	1.25	3.92	1.74	607128	14.20	3.1	677070	90	1,278

HERC-ALLOY 800®
CHAIN SLINGS & COMPONENTS

▶ INSPECTION, CARE & USE

HOW TO SELECT AND ORDER THE PROPER CHAIN SLING

1. Determine the weight and configuration of the load(s) to be lifted.
2. Determine the type of chain sling required, according to weight and configuration. (See page 31 for standard sling configurations.)
3. Determine the size of the body chain according to the working load limits. Be sure to take into consideration the effect of the required angle. The working load limit is the maximum load in pounds which should be applied in direct tension to a straight length of chain.

Note: Working load limit can be affected by angles of loading, type of hitch used, environmental conditions such as hot and cold temperatures, and D/d ratio.

4. Determine the reach required to give the desired angle. The reach is measured from the upper bearing surface of the master link to the bearing surface of the lower attachment. If chain slings are to be used in pairs and are to be matched for reach, please indicate when ordering.
5. Know share of load on pick points and location of center of gravity.



See pages 26 through 32 for more information, or visit us at www.cmworks.com



HERC-ALLOY 800® CHAIN SLINGS



**SINGLE LEG
(VERTICAL)**



**DOUBLE
(2 LEGS)**



**TRIPLE
(3 LEGS)**



**QUADRUPLE
(4 LEGS)**



**MAGNET
SLING**



**SINGLE
ENDLESS**



**DOUBLE
ENDLESS**



**SINGLE
BASKET**



**DOUBLE
BASKET**



**SINGLE
ADJUSTABLE**



**DOUBLE
ADJUSTABLE**

Adjusters on slings allow for easy and safe take up of chain when applications require shorter leg lengths or when lifting objects of abnormal sizes. There are two styles of adjusters: Style A and Style B. Style A is commonly used for shorter reach slings and consists of a hook attached to the link. Style B has 12" of chain in between link and hook gives you more flexibility on longer slings. *Note: Adjusters are also available on single, double, triple and quad slings.*

SLING ID TAGS

Description	Product Code
Alloy Sling ID Tag	557037
Carbon Sling ID Tag	457106
Attachment Ring	557193

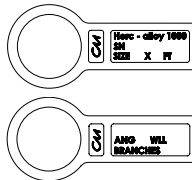

Information on tag includes sling size, reach, WLL, serial number, name of manufacturer, grade of sling & number of branches

Chain Size (in.)	Working Load Limits for Sling Types Show Above														
	Single (1 leg)	Single Choker	Double (2 legs)			Triple (3 legs)			Quad (4 legs)			Single Basket	Double Basket	Single Endless	Double Endless
	90° (lbs.)	90° (lbs.)	60° (lbs.)	45° (lbs.)	30° (lbs.)	60° (lbs.)	45° (lbs.)	30° (lbs.)	60° (lbs.)	45° (lbs.)	30° (lbs.)	60° (lbs.)	60° (lbs.)	90° (lbs.)	60° (lbs.)
7/32	2,100	1,700	3,600	3,000	2,100	5,500	4,400	3,200	5,500	4,400	3,200	3,600	5,500	2,100	3,600
9/32	3,500	2,800	6,100	4,900	3,500	9,100	7,400	5,200	9,100	7,400	5,200	6,100	9,100	3,500	6,100
5/16	4,500	3,600	7,800	6,400	4,500	11,700	9,500	6,800	11,700	9,500	6,800	7,800	11,700	4,500	7,800
3/8	7,100	5,700	12,300	10,000	7,100	18,400	15,100	10,600	18,400	15,100	10,600	12,300	18,400	7,100	12,300
1/2	12,000	9,600	20,800	17,000	12,000	31,200	25,500	18,000	31,200	25,500	18,000	20,800	31,200	12,000	20,800
5/8	18,100	14,500	31,300	25,600	18,100	47,000	38,400	27,100	47,000	38,400	27,100	31,300	47,000	18,100	31,300
3/4	28,300	22,600	49,000	40,000	28,300	73,500	60,000	42,400	73,500	60,000	42,400	49,000	73,500	28,300	49,000
7/8	34,200	27,400	59,200	48,400	34,200	88,900	72,500	51,300	88,900	72,500	51,300	59,200	88,900	34,200	59,200
1	47,700	38,200	82,600	67,400	47,700	123,900	101,200	71,500	123,900	101,200	71,500	82,600	123,900	47,700	82,600
1-1/4	72,300	57,800	125,200	102,200	72,300	187,800	153,400	108,400	187,800	153,400	108,400	125,200	187,800	72,300	125,200

American Society of Mechanical Engineers ASME B30.9, the National Association of Chain Manufacturers (NACM) and the Occupation Safety & Health Administration (OSHA) recommend only the use of alloy steel chain for overhead lifting, i.e. sling chain. Slings may be constructed by the user using Herc-Alloy® chain, Herc-Alloy 1000 or Herc-Alloy 800 chain and attachments.

▶ **For more information on standard sling configurations, see page 31 or visit us online at www.cmworks.com**

HERC-ALLOY 800®
 CHAIN SLINGS &
 COMPONENTS



MASTER LINK DUAL RATED FOR USE WITH HA800 OR HA1000

WORKING LOAD LIMIT: 5,400 TO 187,800 LBS.

BENEFITS & FEATURES

- Accepts both Herc-Alloy® 1000 & 800 chain and components
- Durable orange powder coated finish
- May be used for mechanical and welded sling assemblies
- 100% proof tested
- 4:1 design factor
- Conforms to the new lower hardness offshore requirement

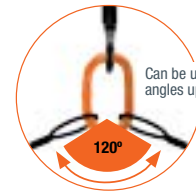
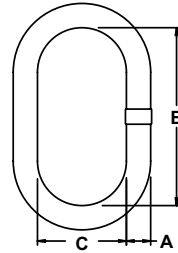

Can be used with included angles up to 120°

Trade Size (in.)	Working Load Limit (lbs.)	Catalog Number	Product Code	Nominal Dimensions (in.)			Weight (lbs.)	Type and Size of Grade 80 Chain Sling (in.)	
				Material Diameter A	Inside Length B	Inside Width C		Single	Double
Standard Sizes (DUAL RATED THROUGH 1-3/4" SIZE ONLY)									
13/32	5,400	HA40	555231	0.41	3.00	1.50	0.33	7/32 & 9/32	7/32
1/2	8,600	HA50	555232	0.56	5.00	2.50	1.02	3/8	9/32
3/4	17,600	HA75	555235	0.75	5.50	2.75	2.08	1/2	3/8
1	30,000	HA100	555238	1.00	7.00	3.50	4.59	5/8 & 3/4	1/2
1-1/4	45,200	HA125	555240	1.25	8.75	4.38	9.31	7/8	5/8
1-1/2	70,600	HA150	555243	1.50	10.50	5.25	15.60	1	3/4 & 7/8
1-3/4	105,900	HA175	555246	1.75	12.00	6.00	24.40	1-1/4	1
2*	88,900	HA200	554949	2.00	14.00	7.00	38.00	1-1/4	1
2-1/4*	125,200	HA225	554951	2.25	16.00	8.00	55.00	-	1-1/4
2-3/4*	187,800	HA275	554957	2.75	16.00	9.00	84.84	-	-
Special Sizes (NOT DUAL RATED)									
1	18,200	N/A	554969	1.00	8.00	4.00	5.25	N/A	N/A
1-1/4	22,800	N/A	554942	1.25	12.00	6.00	12.08	N/A	N/A
1-1/2	36,700	N/A	554944	1.50	14.00	7.00	20.16	N/A	N/A
1-1/2	42,900	N/A	554970	1.50	12.00	6.00	17.60	N/A	N/A
1-3/4	57,100	N/A	554945	1.75	14.00	7.00	27.92	N/A	N/A
2	77,800	N/A	554952	2.00	16.00	8.00	43.00	N/A	N/A

NOTE: Standard sizes dual rated through 1-3/4" only. Special sizes not dual rated.

FORGED MASTER LINK GRADE 80

WORKING LOAD LIMIT: 5,100 TO 20,400 LBS.



BENEFITS & FEATURES

- Quenched and tempered alloy steel
- Fatigue rated to Grade 80 specifications
- 100% proof tested
- Raised markings for better identification
- Durable orange powder coated finish
- 6:1 design factor

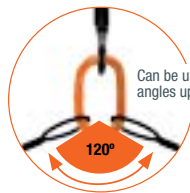

Can be used with included angles up to 120°

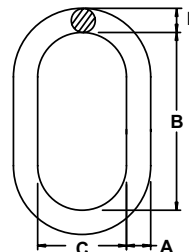

Trade Size (in.)	Working Load Limit (lbs.)	Product Code	Nominal Dimensions (in.)			Weight (lbs.)
			Material Diameter A	Inside Length B	Inside Width C	
1/2	5,100	M50P	0.50	5.00	2.50	0.90
5/8	7,700	M62P	0.63	6.00	3.00	1.75
3/4	10,600	M75P	0.75	6.00	3.00	2.35
1	20,400	M100P	1.00	8.00	4.00	6.00



MASTER LINK WITH & WITHOUT FLATS

HERC-ALLOY 800®

WORKING LOAD LIMIT: 4,200 TO 327,800 LBS.

BENEFITS & FEATURES

- Designed to accept HA800 chain, wire rope and synthetic attachments
- Use with mechanical and welded assemblies
- Sizes up to 1-1/4" available with flats to accommodate Omega link
- 100% proof tested
- 6:1 design factor
- Extra wide body makes these links ideal for wire rope applications and use with Omegaloks. Master link with flat allows for easy installation of these attachments.
- Conforms to the new lower hardness offshore requirement

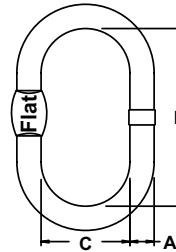
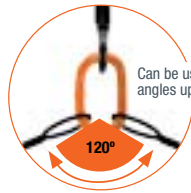

Trade Size (in.)	Working Load Limit (lbs.)		Product Code	Nominal Dimensions (in.)			Flat Dimensions (in.)		Weight (lbs.)	Type and Size of Chain Sling (in.)	
	With Chain	With Wire Rope & Synthetics		Material Diameter A	Inside Length B	Inside Width C	Width	Thickness		Single	Double
7/16	4,200	3,360	ML040 ML040NF	0.44	4.13	2.29	0.94 -	0.28 -	0.50	7/32 & 9/32	7/32
1/2	5,750	4,600	ML050 ML050NF	0.56	4.84	2.69	0.94 -	0.28 -	1.02	-	7/32
5/8	9,000	7,200	ML063 ML063NF	0.63	5.29	2.98	1.22 -	2.81 -	1.34	3/8	9/32
3/4	14,200	11,360	ML075 ML075NF	0.75	6.61	3.72	1.41 -	0.40 -	2.36	1/2	3/8
7/8	17,300	13,840	ML087 ML087NF	0.88	7.35	4.14	1.56 -	0.44 -	3.60	-	-
1	26,500	21,200	ML100 ML100NF	1.00	7.53	4.30	1.56 -	0.53 -	5.20	5/8	1/2
1-1/4	37,400	29,920	ML125 ML125NF	1.25	9.26	5.29	1.56 -	0.68 -	9.60	3/4 & 7/8	5/8
1-1/2	53,000	42,400	ML150	1.50	11.03	6.30	-	-	16.20	1	3/4
1-3/4	72,150	57,720	ML175	1.75	12.86	7.35	-	-	25.10	-	7/8
2	94,200	75,360	ML200	2.00	14.70	8.40	-	-	41.00	1-1/4	1
2-1/4	119,200	95,360	ML225	2.25	16.54	9.45	-	-	58.00	-	-
2-1/2	147,150	117,720	ML250	2.50	18.38	10.50	-	-	74.90	-	1-1/4
2-3/4	178,050	142,440	ML275	2.75	20.21	11.55	-	-	99.80	-	-

NOTE: *Master link with flats are available through 1-1/4" only
 Part numbers with "NF" are for master links WITHOUT flats

FLAT BOTTOM MASTER LINK GRADE 80

WORKING LOAD LIMIT: 73,500 TO 187,800 LBS.

BENEFITS & FEATURES

- Designed to accept HA800 chain and components
- Made from alloy steel
- Extra wide width allows for larger hook usage
- 100% proof tested
- 4:1 design factor

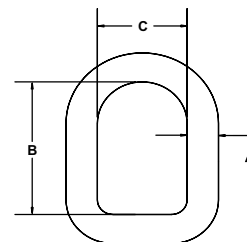

Chain Size (in.)	Trade Size (in.)	Working Load Limit (lbs.)	Product Code	Nominal Dimensions (in.)			Weight (lbs.)
				Material Diameter A	Inside Length B	Inside Width C	
5/8 & 3/4	1-3/4	73,500	554966	1.75	8.00	5.000	18.96
7/8 & 1	2	123,900	554950	2.00	8.98	5.000	28.04
1 & 1/4	2-1/2	187,800	554965	2.50	11.92	6.500	54.73



SUB-ASSEMBLY DUAL RATED FOR USE WITH HA800 & HA1000

WORKING LOAD LIMIT: 7,000 TO 187,800 LBS.

BENEFITS & FEATURES

- Designed for triple and quad branch Herc-Alloy® chain slings
- Consists of an oblong master link and two welded master coupling links
- Accepts both Herc-Alloy 1000 & 800 chain and components
- Durable orange powder coated finish
- May be used for mechanical or welded sling assemblies
- 100% proof tested
- 4:1 design factor
- Conforms to the new lower hardness offshore requirement

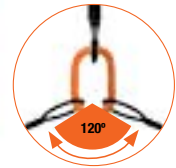
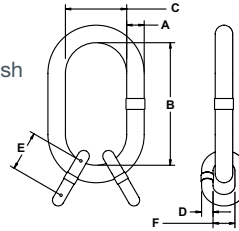

Can be used with included angles up to 120°

Trade Size (in.)	Catalog Number	Working Load Limit at 60° (lbs.)	Product Code	Master Link Nominal Dimensions (in.)			Intermediate Link Nominal Dimensions (in.)			Weight (lbs.)	Type & Size of Chain Sling (in.)	
				Material Diameter A	Inside Length B	Inside Width C	Material Diameter D	Inside Length E	Inside Width F		Triple	Quad
1/2	SA50	7,000	555274	0.56	5.00	2.50	0.44	1.75	1.06	1.35	7/32	7/32
3/4	SA75	11,200	555275	0.75	5.50	2.75	0.47	1.56	0.88	2.64	9/32	9/32
1	SA100	22,900	555276	1.00	7.00	3.50	0.78	2.63	1.50	7.25	3/8	3/8
1-1/4	SA125	39,000	555277	1.25	8.75	4.38	0.91	3.13	1.75	13.51	1/2	1/2
1-1/2	SA150	58,700	555278	1.50	10.50	5.25	1.13	4.00	2.25	24.28	5/8	5/8
1-3/4	SA175	91,700	555279	1.75	12.00	6.00	1.50	5.25	2.75	44.58	3/4 & 7/8	3/4 & 7/8
2*	HA200-SA	88,900	554980	2.00	14.00	7.00	1.53	5.25	2.75	57.34	7/8	7/8
2-1/4*	HA225-SA	123,900	554981	2.25	16.00	8.00	1.78	6.00	3.00	81.48	1	1
2-3/4*	HA275-SA	187,800	554983	2.75	16.00	9.00	2.00	7.00	3.50	126.66	1-1/4	1-1/4

* Grade 80 only

WIDE BODY SUB-ASSEMBLY WITH FLATS HERC-ALLOY 800®

WORKING LOAD LIMIT: 4,600 TO 178,050 LBS.



BENEFITS & FEATURES

- Designed to accept Herc-Alloy 800® chain, wire rope and synthetic attachments
- Durable orange powder coated finish
- 100% proof tested
- May be used for mechanical and welded sling assemblies
- Extra wide body is ideal for wire rope applications
- Sizes up to 1-1/4" intermediate links available with flats to accommodate Omega links
- 6:1 design factor
- Conforms to the new lower hardness offshore requirement

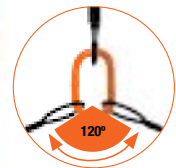
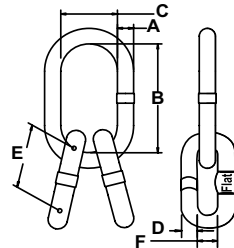

Can be used with included angles up to 120°

Trade Size (in.)	Working Load Limit (lbs.)		Complete Assembly Product Code	Master Link Nominal Dimensions (in.)			Intermediate Link Nominal Dimensions (in.)			Weight (lbs.)	Type and Size of Chain Sling (in.)			
	With Chain	With Wire Rope & Synthetic		Product Code	Material Diameter A	Inside Length B	Inside Width C	Product Code	Material Diameter D		Inside Length E	Inside Width F	Triple	Quad
1/2	5,750	4,600	SA050	ML050	0.56	4.84	2.69	ML040	0.44	4.13	2.29	1.8	-	-
5/8	9,000	7,200	SA063	ML063	0.63	5.29	2.98	ML050	0.56	4.84	2.69	2.9	7/32	7/32
3/4	14,000	11,200	SA075	ML075	0.75	6.61	3.72	ML063	0.63	5.29	2.98	5.5	9/32	9/32
7/8	17,300	13,840	SA087	ML087	0.88	7.35	4.14	ML063	0.63	5.29	2.98	6.3	-	-
1	26,500	21,200	SA100	ML100	1.00	7.53	4.30	ML075	0.75	6.61	3.72	10.2	3/8	3/8
1-1/4	37,400	29,920	SA125	ML125	1.25	9.26	5.29	ML100	1.00	7.53	4.30	20.0	1/2	1/2
1-1/2	53,000	42,400	SA150	ML150	1.50	11.03	6.30	ML100	1.00	7.53	4.30	26.6	-	-
1-3/4	72,150	57,720	SA175	ML175	1.75	12.86	7.35	ML125	1.25	9.26	5.29	44.3	5/8	5/8
2	94,200	75,360	SA200	ML200	2.00	14.70	8.40	ML150	1.50	11.03	6.30	73.4	3/4	3/4
2-1/4	119,200	95,360	SA225	ML225	2.25	16.54	9.45	ML175	1.75	12.86	7.35	108.2	7/8	7/8
2-1/2	147,150	117,720	SA250	ML250	2.50	18.38	10.50	ML200	2.00	14.70	8.40	156.9	1	1
2-3/4	178,050	142,400	SA275	ML275	2.75	20.21	11.55	ML200	2.00	14.70	8.40	181.0	-	-

NOTE: Master link with flats are available through 1-1/4" only



MASTER RING HERC-ALLOY 800®

WORKING LOAD LIMIT: 3,500 TO 141,000 LBS.

BENEFITS & FEATURES

- Made from alloy material
- Proof tested at two times WLL
- Durable orange powder coated finish
- 4:1 design factor

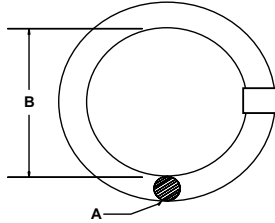

Trade Size (in.)	Working Load Limit (lbs.)	Product Code	Dimensions (in.)		Weight (lbs.)	Type and Size of Chain Sling (in.)			
			Material Diameter A	Inside Length B		Single	Double	Triple	Quadruple
1/2	3,500	554611	0.51	2.50	0.52	7/32 & 9/32	–	–	–
5/8	6,100	554613	0.63	3.00	0.99	–	7/32	7/32	7/32
3/4	10,500	554615	0.75	4.00	1.86	3/8	9/32	9/32	9/32
7/8	12,300	554617	0.88	4.00	2.60	1/2	–	–	–
1	18,400	554619	1.00	4.00	3.45	5/8	3/8	–	–
1-1/4	28,300	554623	1.25	5.00	6.98	3/4	1/2	3/8	3/8
1-1/2	31,300	554627	1.50	6.00	11.80	–	–	–	–
1-3/4	53,000	554630	1.75	7.00	18.70	7/8 & 1	5/8	1/2	1/2
2	73,500	554635	2.00	8.00	27.90	1-1/4	7/8	5/8	5/8
2-1/4	88,900	554636	2.25	9.00	39.90	–	–	3/4	3/4
2-1/2	141,000	554640	2.50	10.00	54.60	–	1	7/8 & 1	7/8 & 1

HERC-ALLOY 800®
 CHAIN SLINGS &
 COMPONENTS

GRAB LINK HERC-ALLOY 800®

WORKING LOAD LIMIT: 3,500 TO 18,100 LBS.



BENEFITS & FEATURES

- Made from alloy material
- Proof tested at two times the WLL
- Economical chain adjuster for single slings
- Durable orange powder coated finish
- 4:1 design factor

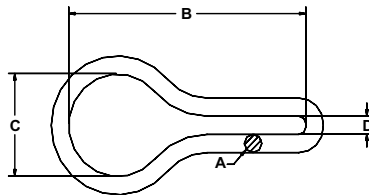

Trade Size (in.)	Working Load Limit (lbs.)	Product Code	Dimensions (in.)				Weight (lbs.)
			Diameter A	Inside Length B	Inside Width C	Inside Width D	
1/2	3,500	554320	0.56	5.50	2.50	0.54	1.01
3/4	7,100	554326	0.75	6.06	2.75	0.63	2.08
1	12,000	554332	1.00	7.63	3.50	0.75	4.59
1-1/4	18,100	554337	1.25	9.25	4.38	1.00	9.16



HAMMERLOK® HERC-ALLOY 800®

WORKING LOAD LIMIT: 2,100 TO 72,300 LBS.

BENEFITS & FEATURES

- Used for overhead lifting slings to connect chain branches to the master link and the hook to attachments.
- Constructed of drop forged alloy steel
- Can be used with Grade 80 chain
- Must be matched to chain size
- Do not use for chain repair or splicing
- Meets ASTM A952 standards.
- 4:1 design factor



Size (in.)	Working Load Limit (lbs.)	Completed Unit			Load Pin Kit		Dimensions (in.)						
		Product Code	Weight (lbs.)	Standard Package	Product Code	Weight (lbs.)	A	B	C	D	E	F	G
7/32	2,100	664021-2	0.12	36	R664021-2	0.01	0.25	0.25	1.40	0.50	0.58	1.21	0.44
9/32	3,500	664028-2	0.26	36	R664028-2	0.02	0.34	0.31	1.94	0.75	0.70	1.51	0.56
3/8	7,100	664038-2	0.59	36	R664038-2	0.05	0.48	0.50	2.41	0.88	0.91	2.09	0.80
1/2	12,000	664050-2	1.42	24	R664050-2	0.12	0.66	0.70	3.51	1.29	1.41	2.96	1.15
5/8	18,100	664062-2	2.35	12	R664062-2	0.20	0.78	0.81	4.06	1.50	1.70	3.52	1.40
3/4	28,300	664075-2	3.67	12	R664075-2	0.30	0.96	0.94	4.78	1.80	1.97	4.11	1.71
7/8	34,200	664089-2	5.98	6	R664089-2	0.40	1.16	1.05	5.25	1.97	2.09	4.95	1.88
1	47,700	664100-2	9.47	-	R664100-2	0.70	1.32	1.25	6.00	2.31	2.37	5.87	2.33
1-1/4	72,300	664125-2	16.61	-	R664125-2	1.20	1.57	1.53	6.81	2.17	2.98	7.04	2.67

HERC-ALLOY 800®
CHAIN SLINGS & COMPONENTS

WEBLOK™ ASSEMBLY HERC-ALLOY 800®

WORKING LOAD LIMIT: 5,000 TO 75,000 LBS.



BENEFITS & FEATURES

- Combines our industry-leading Hammerlok coupling link with a CM web sling attachment, making it ideal for use with synthetic slings.
- Features a unique double load pin retention system to prevent the load pin from backing out during extreme use. Uses both traditional and bolt/lock nut retention.
- Durable orange powder coated finish on bottom portion.
- Made of durable forged alloy steel.
- 100% proof tested.
- Meets ASTM A952 & WSTDA-RS1 standards.
- 5:1 design factor



Retention Component 1:
Traditional stud tube and spring assembly engages the center of the load pin.

Retention Component 2:
Load pin is designed to act like a bolt, featuring a capped end and lock nut.

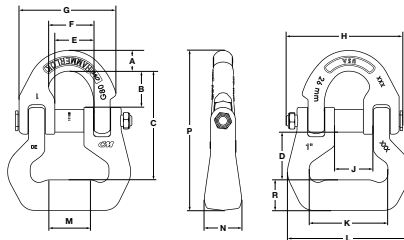

Size (in.)	Working Load Limit (lbs.)		Product Code	Dimensions (in.)															Weight (lbs.)	
	Design Factor			A	B	C	D	E	F	G	H	J	K	L	M	N	P	R		Locknut
	5:1	4:1																		
3/8	5,000	6,250	867010-4	0.530	1.157	3.151	1.306	0.931	1.048	2.327	2.883	0.931	2.000	3.175	0.750	1.000	4.482	0.800	1/4-20 UNC	1.49
5/8	10,000	12,500	867020-4	0.875	1.737	4.320	1.520	1.347	1.551	3.574	4.372	1.347	2.750	4.130	1.250	1.250	6.185	0.990	3/8-16 UNC	3.96
3/4	15,000	18,750	867025-4	1.039	2.022	5.467	2.132	1.547	1.781	4.313	5.341	1.547	2.750	4.479	1.200	1.380	7.607	1.100	1/2-13UNC	6.62
7/8	25,000	31,250	867030-4	1.046	1.829	5.145	2.004	1.919	2.247	5.003	6.103	1.919	3.750	6.000	2.410	1.750	7.601	1.410	5/8-11UNC	8.96
1	40,000	50,000	867035-4	1.250	2.313	6.573	2.885	2.365	2.735	5.856	7.030	2.365	4.744	7.446	2.500	2.250	9.670	1.848	5/8-11UNC	15.83
1-1/4	60,000	75,000	867040-4	1.531	2.625	7.406	3.219	2.701	3.000	7.035	8.536	2.701	5.753	8.882	3.375	2.310	10.918	1.980	3/4-16UNC	25.35



CLEVLOK® SLING HOOK

DUAL RATED FOR USE WITH HA800 OR HA1000

WORKING LOAD LIMIT: 2,700 TO 35,300 LBS.

BENEFITS & FEATURES

- For use with both Grade 80 & 100 chain
- Available with and without a latch
- Quenched and tempered alloy steel
- Clevlok head design
- 100% proof tested and fatigue rated
- Durable orange powder coated finish
- Improved forged latch (hook available with or without latch)
- Replacement pin and latch kit available
- New CE compliant hooks and latches
- Meets EN 1677, ASTM A953 and ASME B30.10 standards
- 4:1 design factor

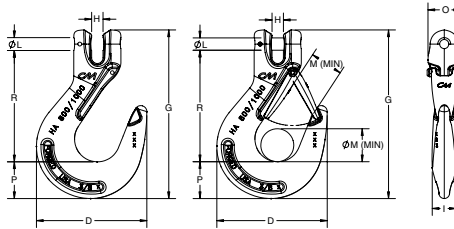

Size (in.)	Working Load Limit (lbs.)	Standard Package	Product Code					Dimensions (in.)										Weight (lbs.)
			With Latch	Without Latch	Latch Kit	Alloy Load Pin	Retaining Pin	D	G	H	I	L	M	O	P	R		
7/32	2,700	10	657716	557716	4X455321	SP595778	495826	3.05	5.00	0.31	0.66	0.28	0.96	1.13	0.94	3.45	1.10	
9/32	4,300	10	657718	557718	4X455322	595780SP	495825	3.53	5.55	0.38	0.75	0.36	0.83	1.32	1.11	3.75	1.20	
3/8	8,800	10	657719	557719	4X455325	595781	495825	4.54	6.93	0.47	1.00	0.51	1.06	1.34	1.51	4.58	2.21	
1/2	15,000	5	657720	557720	4X455328	595782	495823	5.48	8.28	0.58	1.33	0.63	1.38	1.87	1.55	5.59	4.22	
5/8	22,600	5	657721	557721	4X455329	SP595783P	495849	6.20	9.61	0.71	1.47	0.75	1.69	2.11	1.83	6.44	6.64	
3/4	35,300	Bulk	657722	557722	4X455330	595786	495824	7.63	11.79	0.88	1.88	0.94	2.09	2.55	2.51	7.74	11.22	

EYE SLING HOOK

DUAL RATED FOR USE WITH HA800 OR HA1000

WORKING LOAD LIMIT: 2,700 TO 72,300 LBS.

BENEFITS & FEATURES

- For use with both Grade 80 & 100 chain
- Available with and without latch
- Quenched and tempered alloy steel
- 100% proof tested
- Fatigue rated
- Hook available with and without latch (replacement latch available)
- Durable orange powder coated finish
- 4:1 design factor

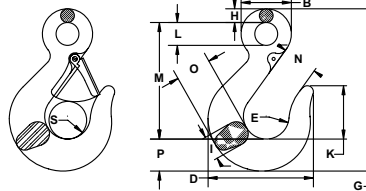

Size (in.)	Working Load Limit (lbs.)	Standard Package	Product Code			Dimensions (in.)													Weight (lbs.)
			With Latch	Without Latch	Latch Kit	B	D	E	G	H	I	K	L	M	N	O	P	S	
7/32	2,700	10	558618	458618	4X458321	1.50	3.04	1.03	5.06	0.38	0.66	1.48	0.75	3.75	1.17	0.98	0.94	0.96	0.8
9/32	4,300	10	558622	458622	595523	1.63	3.50	1.50	5.25	0.44	0.73	1.59	0.75	3.75	1.19	1.20	1.05	1.06	1.10
3/8	8,800	10	558625	458625	595525	2.06	4.33	1.88	6.64	0.56	0.95	2.19	0.94	4.78	1.44	1.45	1.28	1.31	1.90
1/2	15,000	5	558628	458628	595528	2.63	5.50	2.25	8.16	0.75	1.17	2.56	1.13	5.69	1.78	1.94	1.66	1.63	4.30
5/8	22,600	5	558629	458629	595529	3.06	6.34	2.63	9.66	0.88	1.44	2.63	1.31	6.50	2.03	2.38	2.19	1.75	7.30
3/4	35,300	Bulk	558630	458630	595530	3.50	7.83	3.00	11.38	1.00	1.69	3.44	1.50	7.81	2.50	2.83	2.51	2.19	12.50
7/8*	34,200	Bulk	558332	458732	595532	3.88	8.59	3.38	12.72	1.09	1.94	3.88	1.69	8.75	2.78	3.22	2.84	2.38	18.10
1*	47,700	Bulk	558333	458733	595533	4.31	9.59	4.00	14.23	1.22	2.14	4.25	1.88	9.88	3.13	3.55	3.09	2.88	22.60
1-1/4*	72,300	Bulk	558335	458735	595535	5.31	11.56	4.66	17.00	1.50	2.62	4.64	2.31	11.50	3.88	4.25	3.89	3.41	47.00

* Herc-Alloy 800® only

HERC-ALLOY 800®
CHAIN SLINGS & COMPONENTS





CLEVLOK® GRAB HOOK WITHOUT CRADLE

HERC-ALLOY 800®

WORKING LOAD LIMIT: 3,500 TO 18,100 LBS.

BENEFITS & FEATURES

- Quenched and tempered alloy steel
- Fatigue rated
- Built without lugs to avoid catching when slipping into tight clearance
- Durable orange powder coated finish
- Replacement pin available
- 4:1 design factor

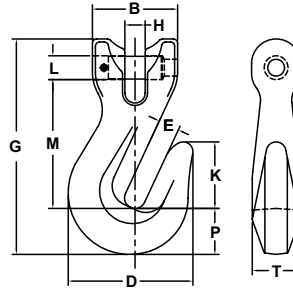

Size (in.)	Working Load Limit (lbs.)	Standard Package	Product Code			Dimensions (in.)										Weight (lbs.)
			Completed Unit	Load Pin	Retainer Pin	B	D	E	G	H	K	L	M	P	T	
9/32	3,500	10	659232	595780	602326	1.36	1.91	0.36	3.70	0.33	1.04	0.36	2.29	0.76	0.81	0.6
3/8	7,100	10	659235	595781	495821	1.90	2.78	0.47	4.81	0.45	1.49	0.51	2.87	1.03	1.06	1.3
1/2	12,000	5	659238	595782	495822	2.31	3.62	0.59	6.35	0.59	1.98	0.63	3.78	1.51	1.38	2.5
5/8	18,100	5	659239	595783	495823	2.87	4.41	0.75	7.74	0.75	2.39	0.75	4.82	1.80	1.69	4.4

Note: If used as a choker, working load limit should be reduced by 20%.

HERC-ALLOY 800®
CHAIN SLINGS & COMPONENTS

CLEVLOK® CRADLE GRAB HOOK

DUAL RATED FOR USE WITH HA800 OR HA1000



WORKING LOAD LIMIT: 2,700 TO 28,300 LBS.

BENEFITS & FEATURES

- For use with both Grade 80 & 100 chain
- Unique cradle grab design
- Quenched and tempered alloy steel
- Fatigue rated
- Durable orange powder coated finish
- Replacement pin available
- 4:1 design factor

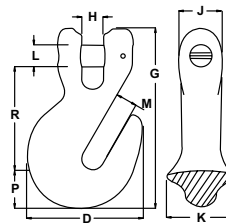

Size (in.)	Working Load Limit (lbs.)	Product Code	Standard Package Quantity	Dimensions (in.)									Weight (lbs.)
				D	G	H	J	K	L	M	P	R	
7/32	2,700	659718	10	1.62	3.21	0.31	0.75	0.94	0.28	0.31	0.62	1.98	0.50
9/32	4,300	659722	10	2.18	3.39	0.38	0.82	0.97	0.36	0.38	0.82	1.86	0.63
3/8	8,800	659725	10	2.72	4.33	0.47	1.18	1.29	0.51	0.74	1.03	2.47	1.30
1/2	15,000	659728	5	3.65	5.27	0.65	1.39	2.01	0.63	0.60	1.19	3.04	2.10
5/8	22,600	659729	5	4.50	6.54	0.77	1.55	2.42	0.75	0.77	1.41	3.76	4.20
3/4*	28,300	659430	Bulk	5.23	9.08	0.88	2.05	2.88	0.91	0.88	1.87	5.50	10.24

* 3/4" is Herc-Alloy 800® only. Hook shape/style differs from photo and dimension drawing shown.

Note: If used as a choker, working load limit should be reduced by 20%.



EYE CRADLE GRAB HOOK

DUAL RATED FOR USE WITH HA800 OR HA1000

WORKING LOAD LIMIT: 3,200 TO 72,300 LBS.

BENEFITS & FEATURES

- For use with both Grade 80 & 100 chain
- Unique cradle grab design
- Quenched and tempered alloy steel
- 100% proof tested
- Fatigue rated
- Durable orange powder coated finish
- 4:1 design factor

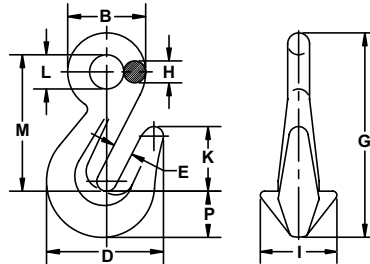

Size (in.)	Working Load Limit (lbs.)	Standard Package	Product Code	Dimensions (in.)										Weight (lbs.)
				B	D	E	G	H	I	K	L	M	P	
7/32	3,200	10	559724	1.20	1.68	0.31	3.22	0.33	0.92	0.99	0.55	2.20	0.69	0.35
9/32	4,300	10	559725	1.40	1.93	0.36	3.72	0.39	1.07	1.13	0.63	2.57	0.76	0.55
3/8	8,800	10	559737	1.78	2.86	0.47	4.81	0.52	1.65	1.49	0.78	3.27	1.02	1.06
1/2	15,000	5	559750	2.28	3.63	0.59	6.36	0.63	1.81	2.15	1.06	4.23	1.53	2.00
5/8	22,600	5	559762	2.75	4.53	0.75	7.62	0.75	2.13	2.65	1.22	5.06	1.80	5.40
3/4	35,300	Bulk	559775	3.50	5.23	0.91	9.54	1.00	2.88	3.52	1.52	6.70	1.85	9.00
7/8*	34,200	Bulk	559387	3.75	5.69	1.00	9.63	1.00	3.00	3.75	1.75	6.50	2.12	10.40
1*	47,700	Bulk	559100	4.31	7.00	1.19	12.44	1.22	3.88	4.31	1.88	8.09	3.12	20.90
1-1/4*	72,300	Bulk	559124	5.38	8.50	1.53	15.56	1.56	2.50	5.50	2.25	10.50	3.50	40.00

* Herc-Alloy 800® only

Note: If used as a choker, working load limit should be reduced by 20%.

HERC-ALLOY 800®
 CHAIN SLINGS &
 COMPONENTS

EYE FOUNDRY HOOK

DUAL RATED FOR USE WITH HA800 OR HA1000

WORKING LOAD LIMIT: 4,300 TO 72,300 LBS.

BENEFITS & FEATURES

- For use with both Grade 80 & 100 chain
- Throat opening up to 6 inches
- Quenched and tempered alloy steel
- Fatigue rated
- Durable orange powder coated finish
- 4:1 design factor

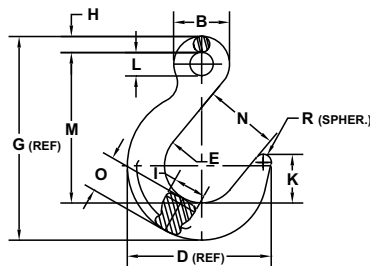

Size (in.)	Working Load Limit (lbs.)	Standard Package	Product Code	Dimensions (in.)												Weight (lbs.)
				B	D	E	G	H	I	K	L	M	N	O	R	
9/32	4,300	5	474798	1.56	4.73	2.50	6.45	0.47	1.00	1.56	0.63	4.75	2.50	1.23	0.25	2.4
3/8	8,800	5	474799	2.00	5.72	3.00	7.88	0.63	1.27	1.88	0.80	5.77	3.00	1.50	0.31	4.5
1/2	15,000	5	474800	2.50	6.75	3.50	9.38	0.75	1.50	2.22	1.00	6.88	3.50	1.75	0.38	7.1
5/8	22,600	5	474801	3.00	7.81	4.00	10.97	0.88	1.81	2.63	1.25	8.06	4.00	2.03	0.44	11.6
3/4	35,300	Bulk	474802	3.50	9.10	4.50	12.81	1.00	2.20	3.00	1.50	9.25	4.50	2.56	0.50	20.0
7/8*	34,200	Bulk	474503	4.00	10.09	5.00	14.23	1.13	2.25	3.38	1.70	10.38	5.00	2.78	0.56	26.0
1*	47,700	Bulk	474504	4.50	11.55	5.50	16.17	1.29	2.63	3.75	2.13	11.56	5.50	3.45	0.62	36.8
1-1/4*	72,300	Bulk	474505	5.13	12.87	6.00	18.03	1.38	3.17	4.25	2.33	12.88	6.00	3.81	0.75	58.4

* Herc-Alloy 800® only



RIGGING HARDWARE

SECTION OVERVIEW 86

SHACKLES 87 (Refer to pages 42 through 55 for details.)

SPECIALTY OVERHEAD LIFTING HOOKS & LUGS

Sorting Hook	88
Shank Hook	88
Plate Hook	89
Alloy "S" Hook	89
Rigging Hook	90
Swivel Rigging Hook	90
Replacement Latches	91
Yale® Import Weld-On Lifting Hook	91
Replacement Hook with Latch	92
CLB Container Lifting Lugs	92

RINGS & LINKS

Master Link (Dual Rated)	93
Forged Master Link	93
Master Link With and Without Flats	94
Wide Body Sub-Assembly with Flats	95
DNV Master Sub-Assemblies	95

ADJUSTABLE HARDWARE

Shoulder Eye Bolts Overview	96
Shoulder Eye Bolts	97
Hoist Rings Overview	98
Heavy Duty® Hoist Ring	99
Specialty Engineered Hoist Ring	100
Hoist Ring (Metric)	101
Hoist Ring Swivel	102
Turnbuckles	103

WIRE ROPE COMPRESSION HARDWARE

Wire Rope Clips	104
Mid-Grip Wire Rope Clips	105
Piggyback® Wedge Socket Clips	106
Bundling Clip	107
Swage Socket (Open)	107
Swage Socket (Closed)	108
Swage Button	108
Swaging Sleeve for Flemish Eye	109



RIGGING HARDWARE OVERVIEW

Whether you need specialty overhead lifting hooks or wire rope compression devices, CM has a large selection of detachable rigging hardware that's strong, durable and reliable. We carry a variety of links, hooks, eye bolts, hoist rings and wire rope clips to meet all of your rigging and load handling needs.

SPECIALTY OVERHEAD LIFTING HOOKS & LUGS

Designed for a variety of overhead lifting applications, our assortment of specialty lifting hooks and lugs help position and move everything from plates to large cylinders and coils. Choose from sorting hooks, plate hooks, swivel hooks and more.

RINGS & LINKS

Oftentimes it is necessary to use collector rings, such as shackles, rings, links and master links, in conjunction with crane hooks to lift a load. Rings and links ensure proper alignment and loading of a hook. Rather than improperly loading the hook, operators should use rings and links to ensure safe handling and also prevent overcrowding the hook with multiple attachments.

ADJUSTABLE HARDWARE

CM's selection of adjustable hardware, including eye bolts, hoist rings and turnbuckles, allow for easy load attachment and sling adjustment when lifting or securing a load. Eyebolts and swivel hoist rings are used for making attachment points on loads for easier lifting. Turnbuckles provide easy means for tensioning, loosening and removing chain and rope load lines.

WIRE ROPE COMPRESSION HARDWARE

Wire rope compression hardware, including wire rope clips, bundling clips and swage sockets, are used to secure and manipulate wire rope for lifting applications. Wire rope clips are typically used to secure wire rope when forming a loop. Bundling clips eliminate shear points and damage to wire rope, while swage sockets are used as wire rope terminations.



RIGGING HARDWARE

SHACKLES

WORKING LOAD LIMIT: 1/3 TO 120 TON

When it comes to shackles, Columbus McKinnon prides itself on providing the strongest and most reliable products on the market. We carry a full line of anchor and chain shackles, manufactured through our state-of-the-art forging process in Chattanooga, Tennessee*.

CM shackles are available in three materials, including carbon, super strong and alloy. Our innovative Super Strong Shackles are unique in the industry, featuring strength ratings up to 50 percent stronger than comparable sized carbon shackles and a 6:1 design factor for ultimate safety.

CM shackles are available in a three styles: **Screw Pin; Bolt, Nut & Cotter; and Round Pin.** Learn more about the uses and benefits of each shackle style below.

* Some higher-capacity shackles are forged from high-quality German alloy steel at our STB facility in Hamm, Germany and then finished in the U.S.A.

BOLT, NUT & COTTER SHACKLES

Of all shackle types, Bolt, Nut and Cotter Shackles provide the most secure pin arrangement, resisting axial and torsional loading. This type of shackle should be used in semi-permanent applications where the pin is removed infrequently or where cyclical loading occurs. This is the preferred type of shackle in areas that are difficult to reach or inspect. Recommended for overhead lifting, bolt, nut and cotter shackles are available in capacities up to 120 tons.



SCREW PIN SHACKLES

Screw Pin Shackles allow for quick and easy removal of the screw pin, which makes this style ideal for applications where the shackle is removed frequently. While the threaded pin can resist axial forces, it should not be cyclically loaded and is unreliable and vulnerable to backing out in applications where the pin is subjected to a torque or twisting action. Recommended for overhead lifting, screw pin shackles are available in capacities up to 43 tons. Screw pins should be moused in some applications.



ROUND PIN SHACKLES

Round Pin Shackles allow for easy removal by simply removing the cotter that holds the pin in place. These shackles perform well where the pin is subjected to a torque or twisting action, but they should not be subjected to an axial load. Round pin shackles are available in capacities up to 43 tons and are **not recommended for overhead lifting.**



4 TYPES OF SHACKLE MATERIAL

MATERIAL	STYLE	WLL (TONS)	SIZES (IN.)	STYLES	DESIGN FACTOR	FINISHES
CARBON	Anchor	1/3 to 120 ton	3/16" to 3-1/2"	Bolt, Nut & Cotter; Screw Pin; Round Pin	6:1	Orange Powder Coated, Galvanized
	Chain	1/2 to 35 ton	1/4" to 2"			
SUPER STRONG 17 to 50% stronger than comparable-sized Carbon	Anchor	1/2 to 55 tons	3/16" to 2-1/2"	Bolt, Nut & Cotter; Screw Pin; Round Pin	6:1*	Orange Powder Coated, Self Colored, Galvanized
	Chain	3/4 to 35 tons	1/4" to 2"			
ALLOY (U.S.) ~50% stronger than comparable-sized Carbon and ~25% stronger than Super Strong	Anchor	2 to 120 ton	3/8" to 3"	Bolt, Nut & Cotter; Screw Pin; Round Pin	5:1	Orange Powder Coated, Self Colored, Galvanized
ALLOY (GERMAN) Higher average Charpy values	Anchor	85 to 150 ton	2-1/2" to 3-1/2"	Bolt, Nut & Cotter	5:1	Self Colored, Galvanized

* Super Strong round pin shackles have a 5:1 design factor.



SORTING HOOK HERC-ALLOY 800®

WORKING LOAD LIMIT: 7-1/2 TONS

BENEFITS & FEATURES

- Quenched and tempered alloy steel
- Long tapered point designed for easy grab in rings, pear links, eye bolts or lifting holes
- Durable orange powder coated finish
- Do not load last 1" of the tip
- Design factor 5:1

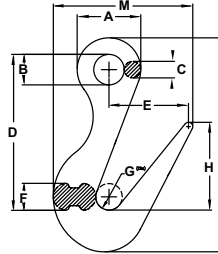

Working Load Limit (lbs.)		With Handle		Without Handle		Dimensions (in.)									
At Tip (ton)	At bottom of Hook (ton)	Product Code	Weight (lbs.)	Product Code	Weight (lbs.)	A	B	C	D	E	F	G	H	I	M
2	7-1/2	M129H	7.0	M129	6.8	3	1.44	0.78	7.34	3.75	1.28	1.25	3.93	10.09	6.58

SHANK HOOK HERC-ALLOY 800®

WORKING LOAD LIMIT: 1 TO 7 TONS



BENEFITS & FEATURES

- Heat treated alloy steel provides strength without bulk or weight
- Pre-drilled boss allows for latch
- Shank hooks are supplied unthreaded, but can be supplied threaded as a special order item
- Shank hooks made from other material (bronze, stainless steel, etc.) available upon request
- Design factor 5:1

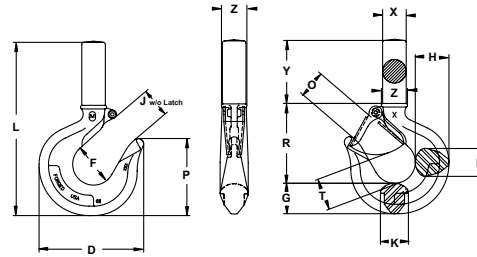

Alloy Shank Hook		Weight (lbs.)	Latch Kit Product Code	Max Shank Diameter (in.)	Latch Hole (in.)	Dimensions (in.)												
Working Load Limit* (ton)	Product Code					D	F	G	H	J	K	L	O	P	R	X	Y	Z
1	M1302AV	0.65	4X1302	0.72	0.14	3.09	1.25	0.87	1.01	0.91	0.63	5.44	0.88	2.12	2.35	0.66	2.22	0.69
1-1/2	M1303AV	0.80	4X1303	0.79	0.19	3.37	1.38	0.94	1.11	0.97	0.71	5.92	0.91	2.27	2.59	0.73	2.39	0.80
2	M1304AV	1.47	4X1304	0.86	0.18	3.75	1.50	1.04	1.21	1.06	0.88	6.45	1.00	2.58	2.75	0.79	2.66	1.00
3	M1305AV	1.85	4X1305	1.11	0.18	4.23	1.63	1.25	1.43	1.17	0.94	7.42	1.16	2.84	3.16	0.96	3.01	1.03
5	M1307AV	4.04	4X1307	1.30	0.20	5.16	2.00	1.44	1.63	1.48	1.38	8.80	1.41	3.52	3.85	1.24	3.52	1.27
7	M1309AV	7.25	4X1309	1.56	0.20	6.24	2.50	1.82	2.01	1.78	1.68	10.72	1.69	4.59	4.70	1.49	4.02	1.56

* Working Load Limits in Metric Tons.

WARNING

The following should be observed:

- ▲ Shanks are not intended for internal threading or swaging.
- ▲ To obtain maximum strength threads should be class 1 or 2.
- ▲ Thread engagement in nut or object must be a minimum of 1-1/2 times the thread diameter. Insufficient thread engagement can result in loss of load.

RIGGING HARDWARE

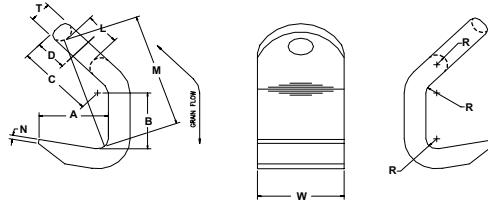

PLATE HOOK HERC-ALLOY 800®

WORKING LOAD LIMIT: 3,600 TO 11,400 LBS.

BENEFITS & FEATURES

- Made from alloy material
- Designed to handle plate steel
- Durable orange powder coated finish
- Available as components or attached to certified slings
- Design factor 5:1
- Meets ASME B30.10 standards



Size (in.)	Product Code	Working Load Limit (lbs.)	Dimensions (in.)										Weight (lbs.)
			A	B	C	D	L	M	N	T	W	R	
9/32	462528	3,600	2.00	1.75	2.50	0.94	1.00	3.48	0.13	0.63	2.50	0.31	2.80
3/8	462537	7,050	2.63	2.97	4.31	1.24	1.13	6.53	0.19	0.75	2.75	0.50	5.70
1/2	462550	11,400	3.50	4.00	4.38	1.50	1.50	6.98	0.28	1.00	3.50	0.50	13.00
5/8	462562	17,800	4.38	5.00	5.44	1.88	1.88	9.25	0.31	1.25	5.00	0.63	26.50
3/4	462575	25,600	5.19	6.00	6.50	2.38	2.25	10.88	0.38	1.50	5.75	0.75	42.00
7/8	462587	34,900	6.00	7.00	7.63	2.50	2.63	13.06	0.44	1.75	6.00	1.00	65.00

Other sizes available

WARNING

NEVER USE PLATE HOOKS ON A QUAD SLINGS.
To lift a plate with a quad sling, a spreader or beam is required and hooks would go on the end of double chain slings that would be attached to each end of the beam.



ALLOY "S" HOOK HERC-ALLOY 800®

WORKING LOAD LIMIT: 210 TO 6,250 LBS.

BENEFITS & FEATURES

- Made from alloy material
- Proof tested at two times WLL
- Durable orange powder coated finish
- WLL embossed on hooks
- Custom sizes available upon request
- Serialized upon request
- Design factor 4:1

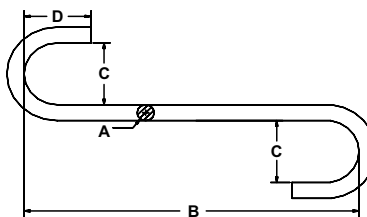

Size (in.)	Working Load Limit (lbs.)	Product Code	Dimensions (in.)				Weight (lbs.)
			A	B	C	D	
9/32	210	562228	0.28	4.50	1.13	1.13	0.15
3/8	410	562237	0.38	6.00	1.50	1.50	0.35
1/2	870	562250	0.56	7.50	2.00	2.00	1.04
5/8	1,120	562262	0.63	9.00	2.50	2.50	1.56
3/4	1,730	562275	0.75	10.50	3.00	3.00	2.60
7/8	2,370	562287	0.88	12.00	3.50	3.50	4.20
1	2,920	562300	1.00	13.00	4.00	4.00	6.00
1-5/32	3,150	562310	1.13	15.00	4.50	4.50	9.30
1-1/4	4,450	562325	1.25	16.00	5.00	5.00	11.70
1-3/8	6,100	562337	1.38	17.00	5.50	5.50	15.40
1-1/2	6,250	562350	1.50	18.00	6.00	6.00	19.50

RIGGING HARDWARE



RIGGING HOOK

WORKING LOAD LIMIT: 3/4 TO 60 TONS

BENEFITS & FEATURES

- Load rating marked on each hook body
- Design factor 5:1
- Pre-drilled latch tab allows addition of heavy-duty latch
- Hooks up through 31-1/2 tons have orange powder coated finish. Hooks with WLL 37 tons and greater are protected with Rust Veto®

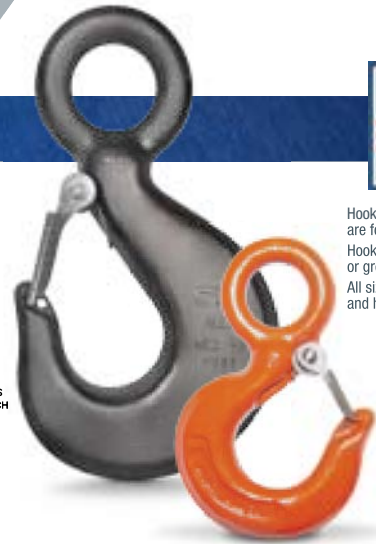
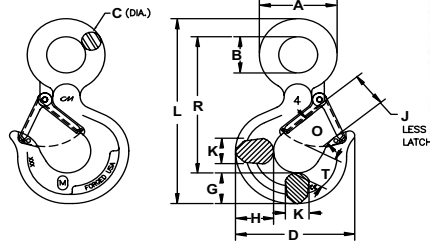

Hooks with 3/4 to 7 ton WLL are forged in U.S.A.
 Hooks with WLL of 7-1/2 ton or greater are forged in Germany.
 All sizes are machined and heat-treated in the U.S.A.

2 ton WLL & 45 ton WLL hooks shown.

Std. Package	Carbon				Alloy				Zinc Plated Latch Kit (optional) Product Code	Dimensions (in.)											Weight (lbs.)		
	Painted Orange		Painted Orange		Rust Veto®																		
	WLL* (tons)	Product Code	WLL* (tons)	Product Code	WLL* (tons)	Product Code	A	B		C	D	G	H	J	K	L	O	R	T				
10	3/4	M6402C	M6502C	1	M6402A	M6502A	-	-	-	4X1302	1.50	0.75	0.38	3.12	0.87	1.01	0.93	0.63	4.37	0.93	3.13	0.87	0.66
10	1	M6403C	M6503C	1-1/2	M6403A	M6503A	-	-	-	4X1303	1.75	0.88	0.44	3.37	0.94	1.11	0.97	0.71	5.04	0.97	3.66	0.97	1.12
5	1-1/2	M6404C	M6504C	2	M6404A	M6504A	-	-	-	4X1304	2.13	1.10	0.50	3.80	1.06	1.21	1.02	0.74	5.65	1.02	4.09	1.03	1.46
5	2	M6405C	M6505C	3	M6405A	M6505A	-	-	-	4X1305	2.50	1.25	0.64	4.20	1.26	1.43	1.19	0.94	6.55	1.16	4.67	1.16	2.42
5	3	M6407C	M6507C	5	M6407A	M6507A	-	-	-	4X1307	3.08	1.56	0.77	5.11	1.44	1.63	1.50	1.38	7.97	1.41	5.78	1.53	4.10
5	5	M6409C	M6509C	7	M6409A	M6509A	-	-	-	4X1309	3.88	1.98	0.94	6.24	1.82	2.01	1.78	1.68	10.07	1.69	7.31	1.94	8.16
-	7-1/2	M6411C	M6511C	11	M6411A	M6511A	-	-	-	4X1311	4.69	2.44	1.13	7.89	2.25	2.63	2.38	1.88	12.41	2.19	9.03	2.52	15.60
-	10	M6415C	M6515C	15	M6415A	M6515A	-	-	-	4X1315	5.34	2.84	1.25	8.53	2.75	3.10	2.50	2.03	14.05	2.30	10.21	2.54	21.58
-	15	M6422C	M6522C	22	M6422A	M6522A	-	-	-	4X1322	6.63	3.50	1.56	10.30	3.15	3.62	3.30	2.60	17.53	3.12	12.81	2.73	39.89
High-Capacity Units																							
-	-	-	-	31-1/2	M6430A	M6530A	-	-	-	4X1330	7.01	3.50	1.75	12.41	3.62	4.57	3.86	2.99	19.43	3.44	14.06	3.16	65.3
-	-	-	-	-	-	-	37	M6437A	M6537A	4X1337	8.50	4.49	2.01	14.06	4.57	5.72	4.65	3.75	24.76	4.02	18.19	4.40	116.68
-	-	-	-	-	-	-	45	M6445A	M6545A	4X1345	9.28	4.92	2.18	15.75	5.08	6.85	4.80	4.49	27.38	4.06	21.69	4.68	174.82
-	-	-	-	-	-	-	60	M6460A	M6560A	4X1360	10.77	5.71	2.53	18.70	5.98	8.27	5.65	5.51	32.22	4.96	23.70	6.24	301.59

Other finishes are available as special orders. * Working Load Limits in Metric Tons.

RIGGING HARDWARE

SWIVEL RIGGING HOOK

WORKING LOAD LIMIT: 1 TO 22 TONS

BENEFITS & FEATURES

- Design factor 5:1
- Pre-drilled for latches
- Hooks furnished with or without latches
- Powder coated orange
- Hooks are heat treated, quenched and tempered

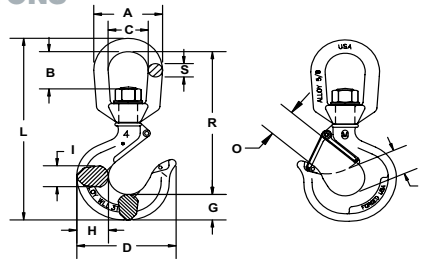

Standard Package	Alloy				Zinc Plated Latch Kit (optional) Product Code	Dimensions (in.)											Latch Kit	Weight (lbs.)
	WLL* (tons)	Product Code																
		without Latch	with Latch	A		B	C	D	G	H	I	L	R	S	T	O		
10	1	M3402A	M3502A	4X1302	2.00	1.11	1.31	3.06	0.87	1.05	0.63	5.83	4.63	0.38	0.87	0.93	4X1302	1.05
10	1-1/2	M3403A	M3503A	4X1303	2.50	1.38	1.50	3.33	0.94	1.11	0.71	6.83	5.44	0.50	0.97	0.97	4X1303	1.56
10	2	M3404A	M3504A	4X1304	3.00	1.65	1.75	3.67	1.06	1.21	0.88	7.76	6.25	0.63	1.03	1.06	4X1304	2.50
10	3	M3405A	M3505A	4X1305	3.00	1.65	1.75	4.20	1.27	1.43	0.94	8.40	6.49	0.63	1.16	1.16	4X1305	3.20
10	5	M3407A	M3507A	4X1307	3.50	1.77	2.00	5.11	1.44	1.63	1.31	9.76	7.53	0.75	1.53	1.41	4X1307	5.36
Bulk	7	M3409A	M3509A	4X1309	4.75	2.39	2.75	6.24	1.82	2.01	1.68	12.42	9.67	1.00	1.94	1.69	4X1309	10.56
Bulk	11	M3411A	M3511A	4X1311	5.50	2.55	3.25	7.69	2.25	2.63	1.88	14.89	12.06	1.13	2.46	2.22	4X1311	19.00
Bulk	15	M3415A	M3515A	4X1315	6.00	2.47	3.50	8.37	2.59	2.94	2.19	15.79	11.95	1.25	2.62	2.23	4X1315	26.75
Bulk	22	M3422A	M3522A	4X1322	7.75	3.82	4.75	10.19	3.00	3.50	2.69	21.18	16.68	1.50	2.74	3.05	4X1322	51.80

* Working Load Limits in Metric Tons

REPLACEMENT LATCHES FOR SWIVEL, RIGGING & SHANK HOOKS

Working Load Limit (tons)		Product Code			
Alloy	Carbon	Old Style	New Style		
		Stainless	Zinc	Stainless	Locking
1	3/4	4X405	4X1302	4X1302S	4X1302M
1-1/2	1	4X405	4X1303	4X1303S	4X1303M
2	1-1/2	4X406	4X1304	4X1304S	4X1304M
3	2	4X406	4X1305	4X1305S	4X1305M
5	3	4X410	4X1307	4X1307S	4X1307M
7	5	4X412	4X1309	4X1309S	4X1309M
11	7-1/2	4X414	4X1311	4X1311S	4X1311M
15	10	595530	4X1315	-	4X1315M
22	15	595533	4X1322	-	4X1322M



YALE® IMPORT WELD-ON LIFTING HOOK

WORKING LOAD LIMIT: 2,200 TO 17,500 LBS.

BENEFITS & FEATURES

- Heavy steel construction with a durable finish
- Designed for use with excavating equipment – can be welded directly onto the bucket
- Latch prevents chain from accidentally unhooking
- Design factor 4:1

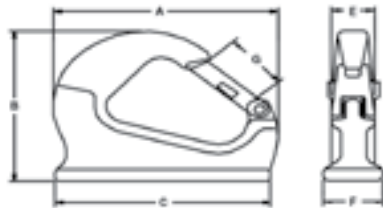

Product Code	Working Load Limit (lbs.)	Dimensions (in.)						Weight (lbs.)	Replacement Latch Product Code
		A	B	C	E	F	G		
48211	2,205	4.63	4.13	2.78	1.00	1.25	0.84	0.88	4X48211
48212	6,615	5.81	4.72	3.74	1.25	1.30	0.98	2.88	4X48212
48213	11,025	7.97	6.45	5.12	1.16	1.72	1.79	5.31	4X48213
48214	17,500	7.61	5.43	6.69	1.58	1.97	1.85	8.50	4X48214

Design Factor 4:1
Imported

REPLACEMENT HOOK WITH LATCH

WORKING LOAD LIMIT: 1 TON

BENEFITS & FEATURES

- Easy installation
- Bolt, nut, and cotter pin provides safe and secure attaching points
- Self colored finish
- Easy installation
- Design factor 4:1

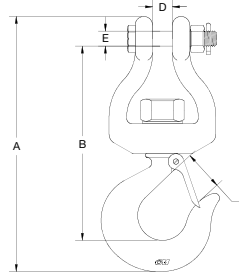

Working Load Limit (ton)	Product Code	Dimensions (in.)					Weight (lbs.)
		A	B	C	D	E	
1	M134	7.56	5.63	1.13	0.50	0.44	2.56

CLB CONTAINER LIFTING LUGS

WORKING LOAD LIMIT: 88,100 LBS. (PER SET OF 4)

Supplied in sets of 4, CLB Lifting Lugs serve as flexible lashing points for the transportation of containers.

BENEFITS & FEATURES

- Spring-loaded bolt to prevent accidental release
- Mounted horizontally at the side of the container in either upper or lower holes
- Easy installation and removal – simply insert and turn to install
- Designed to eliminate the dangerous use of standard hooks
- Lugs cannot drop out when slings become slack
- Lugs can be used for left hand or right hand turns
- For maximum capacity, use a lifting beam in conjunction with CLB lifting lugs
- Design factor 4:1

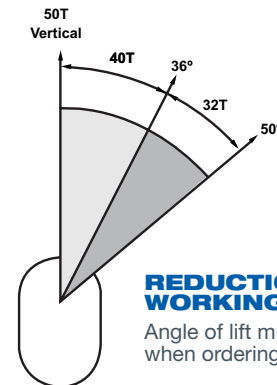
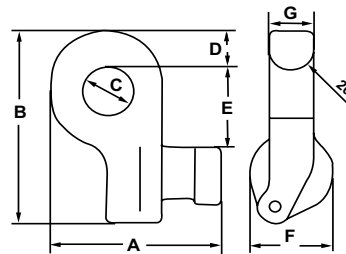

REDUCTION OF WORKING LOAD LIMIT

Angle of lift must be specified when ordering CLB lifting lugs

Product Code	Working Load Limit (lbs. per set of 4)	Dimensions (in.)							Weight (lbs.)
		A	B	C	D	E	F	G	
CLB40	88,100	5.984	7.126	1.772	1.457	2.874	2.953	1.575	39.7

RIGGING HARDWARE



MASTER LINK DUAL RATED FOR USE WITH HA800 OR HA1000

WORKING LOAD LIMIT: 3,600 TO 187,800 LBS.

BENEFITS & FEATURES

- Accepts both Herc-Alloy® 1000 & 800 chain and components
- Durable orange powder coated finish
- May be used for mechanical and welded sling assemblies
- 100% proof tested
- Design factor 4:1
- Conforms to the new lower hardness offshore requirement

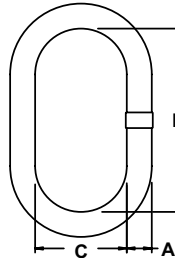

Trade Size (in.)	Working Load Limit (lbs.)	Catalog Number	Product Code	Nominal Dimensions (in.)			Weight (lbs.)	Type and Size of Grade 80 Chain Sling (in.)	
				Material Diameter A	Inside Length B	Inside Width C		Single	Double
Standard Sizes (DUAL RATED THROUGH 1-3/4" SIZE ONLY)									
3/8	5,400	HA40	555231	0.41	3.00	1.50	0.33	7/32 & 9/32	7/32
1/2	8,600	HA50	555232	0.56	5.00	2.50	1.02	3/8	9/32
3/4	17,600	HA75	555235	0.75	5.50	2.75	2.08	1/2	3/8
1	30,000	HA100	555238	1.00	7.00	3.50	4.59	5/8 & 3/4	1/2
1-1/4	45,200	HA125	555240	1.25	8.75	4.38	9.31	7/8	5/8
1-1/2	70,600	HA150	555243	1.50	10.50	5.25	15.60	1	3/4 & 7/8
1-3/4	105,900	HA175	555246	1.75	12.00	6.00	24.40	1-1/4	1
2*	88,900	HA200	554949	2.00	14.00	7.00	38.00	1-1/4	1
2-1/4*	125,200	HA225	554951	2.25	16.00	8.00	55.00	-	1-1/4
2-3/4*	187,800	HA275	554957	2.75	16.00	9.00	84.84	-	-
Special Sizes (NOT DUAL RATED)									
1	18,200	N/A	554969	1.00	8.00	4.00	5.25	N/A	N/A
1-1/4	22,800	N/A	554942	1.25	12.00	6.00	12.08	N/A	N/A
1-1/2	36,700	N/A	554944	1.50	14.00	7.00	20.16	N/A	N/A
1-1/2	42,900	N/A	554970	1.50	12.00	6.00	17.60	N/A	N/A
1-3/4	57,100	N/A	554945	1.75	14.00	7.00	27.92	N/A	N/A
2	77,800	N/A	554952	2.00	16.00	8.00	43.00	N/A	N/A

NOTE: Standard sizes dual rated through 1-3/4" only. Special sizes not dual rated.

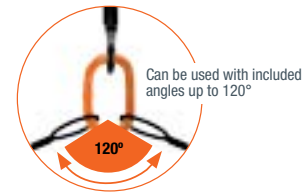

FORGED MASTER LINK GRADE 80

WORKING LOAD LIMIT: 5,100 TO 20,400 LBS.



BENEFITS & FEATURES

- Quenched and tempered alloy steel
- Fatigue rated to Grade 80 specifications
- 100% proof tested
- Raised markings for better identification
- Durable orange powder coated finish
- Design factor 4:1

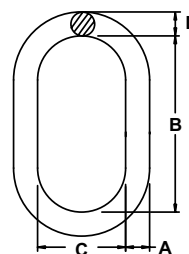
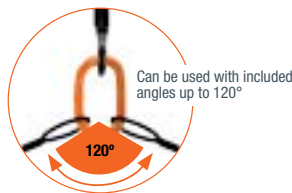

Trade Size (in.)	Working Load Limit (lbs.)	Product Code	Nominal Dimensions (in.)			Weight (lbs.)
			Material Diameter A	Inside Length B	Inside Width C	
1/2	5,100	M50P	0.50	5.00	2.50	0.90
5/8	7,700	M62P	0.63	6.00	3.00	1.75
3/4	10,600	M75P	0.75	6.00	3.00	2.35
1	20,400	M100P	1.00	8.00	4.00	6.00



MASTER LINK WITH & WITHOUT FLATS

HERC-ALLOY 800®

WORKING LOAD LIMIT: 3,360 TO 178,050 LBS.

BENEFITS & FEATURES

- Designed to accept HA800 chain, wire rope and synthetic attachments
- Use with mechanical and welded assemblies
- Sizes up to 1-1/4" available with flats to accommodate Omega link
- 100% proof tested
- Extra wide body makes these links ideal for wire rope applications and use with Omegaloks. Master link with flat allows for easy installation of these attachments.
- Design factor 6:1
- Conforms to the new lower hardness offshore requirement

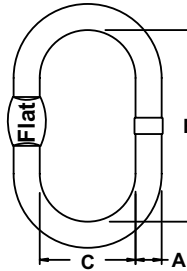
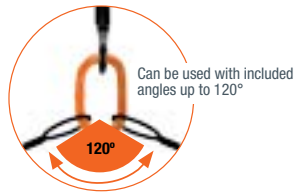

Trade Size (in.)	Working Load Limit (lbs.)		Product Code	Nominal Dimensions (in.)			Flat Dimensions (in.)		Weight (lbs.)	Type and Size of Chain Sling (in.)	
	With Chain	With Wire Rope & Synthetics		Material Diameter A	Inside Length B	Inside Width C	Width	Thickness		Single	Double
7/16	4,200	3,360	ML040	0.44	4.13	2.29	0.94	0.28	0.50	7/32 & 9/32	7/32
			ML040NF				-	-			
1/2	5,750	4,600	ML050	0.56	4.84	2.69	0.94	0.28	1.02	-	7/32
			ML050NF				-	-			
5/8	9,000	7,200	ML063	0.63	5.29	2.98	1.22	2.81	1.34	3/8	9/32
			ML063NF				-	-			
3/4	14,200	11,360	ML075	0.75	6.61	3.72	1.41	0.40	2.36	1/2	3/8
			ML075NF				-	-			
7/8	17,300	13,840	ML087	0.88	7.35	4.14	1.56	0.44	3.60	-	-
			ML087NF				-	-			
1	26,500	21,200	ML100	1.00	7.53	4.30	1.56	0.53	5.20	5/8	1/2
			ML100NF				-	-			
1-1/4	37,400	29,920	ML125	1.25	9.26	5.29	1.56	0.68	9.60	3/4 & 7/8	5/8
			ML125NF				-	-			
1-1/2	53,000	42,400	ML150	1.50	11.03	6.30	-	-	16.20	1	3/4
1-3/4	72,150	57,720	ML175	1.75	12.86	7.35	-	-	25.10	-	7/8
2	94,200	75,360	ML200	2.00	14.70	8.40	-	-	41.00	1-1/4	1
2-1/4	119,200	95,360	ML225	2.25	16.54	9.45	-	-	58.00	-	-
2-1/2	147,150	117,720	ML250	2.50	18.38	10.50	-	-	74.90	-	1-1/4
2-3/4	178,050	142,440	ML275	2.75	20.21	11.55	-	-	99.80	-	-

NOTE: *Master link with flats are available through 1-1/4" only
 Part numbers with "NF" are for master links WITHOUT flats

RIGGING HARDWARE

WIDE BODY SUB-ASSEMBLY WITH FLATS HERC-ALLOY 800®



WORKING LOAD LIMIT: 4,600 TO 178,050 LBS.

BENEFITS & FEATURES

- Designed to accept Herc-Alloy 800® chain, wire rope and synthetic attachments
- Durable orange powder coated finish
- 100% proof tested
- May be used for mechanical and welded sling assemblies
- Extra wide body is ideal for wire rope applications
- Sizes up to 1-1/4" intermediate links available with flats to accommodate Omega links
- Design factor 6:1
- Conforms to the new lower hardness offshore requirement

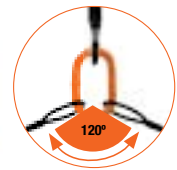
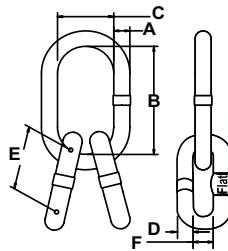

Can be used with included angles up to 120°

Trade Size (in.)	Working Load Limit (lbs.)		Complete Assembly Product Code	Master Link Nominal Dimensions (in.)			Intermediate Link Nominal Dimensions (in.)				Weight (lbs.)	Type and Size of Chain Sling (in.)		
	With Chain	With Wire Rope & Synthetic		Product Code	Material Diameter A	Inside Length B	Inside Width C	Product Code	Material Diameter D	Inside Length E		Inside Width F	Triple	Quad
1/2	5,750	4,600	SA050	ML050	0.56	4.84	2.69	ML040	0.44	4.13	2.29	1.8	-	-
5/8	9,000	7,200	SA063	ML063	0.63	5.29	2.98	ML050	0.56	4.84	2.69	2.9	7/32	7/32
3/4	14,000	11,200	SA075	ML075	0.75	6.61	3.72	ML063	0.63	5.29	2.98	5.5	9/32	9/32
7/8	17,300	13,840	SA087	ML087	0.88	7.35	4.14	ML063	0.63	5.29	2.98	6.3	-	-
1	26,500	21,200	SA100	ML100	1.00	7.53	4.30	ML075	0.75	6.61	3.72	10.2	3/8	3/8
1-1/4	37,400	29,920	SA125	ML125	1.25	9.26	5.29	ML100	1.00	7.53	4.30	20.0	1/2	1/2
1-1/2	53,000	42,400	SA150	ML150	1.50	11.03	6.30	ML100	1.00	7.53	4.30	26.6	-	-
1-3/4	72,150	57,720	SA175	ML175	1.75	12.86	7.35	ML125	1.25	9.26	5.29	44.3	5/8	5/8
2	94,200	75,360	SA200	ML200	2.00	14.70	8.40	ML150	1.50	11.03	6.30	73.4	3/4	3/4
2-1/4	119,200	95,360	SA225	ML225	2.25	16.54	9.45	ML175	1.75	12.86	7.35	108.2	7/8	7/8
2-1/2	147,150	117,720	SA250	ML250	2.50	18.38	10.50	ML200	2.00	14.70	8.40	156.9	1	1
2-3/4	178,050	142,400	SA275	ML275	2.75	20.21	11.55	ML200	2.00	14.70	8.40	181.0	-	-

NOTE: Master link with flats are available through 1-1/4" only

DNV MASTER SUB-ASSEMBLIES



WORKING LOAD LIMIT: 17-1/2 TO 50 TON

Master Sub-Assemblies meeting DNV requirements are used to build slings in conjunction with DNV Shackles. These products are designed for use in offshore saltwater environments for general load securement applications, such as during the installation and removal of offshore platforms or transportation of cargo container units.

BENEFITS & FEATURES

- Certified and serialized to meet DNV 2.7-1 and 2.7-3 Offshore Container Specifications and 2.22 Lifting Appliances Requirements.
- Design factor of 5:1 or higher in accordance with DNV 2.7-1 requirements.
- Welds exceed Charpy V impact strength of 27 Joules at -20°C (20 ft-lb, at -4°F) as per DNV 2.7-1.
- Exceed ASTM A952 specifications for lifting components.
- Designed to meet ASME B30.9 requirements.
- Links are 100% proof tested at the manufacturing facility at two times the WLL.
- Designed for use with chain, wire rope and synthetic slings.
- Made from superior triple alloy steel with a galvanized coating for protection against corrosion.
- Certification of compliance supplied with each shipment. CG3 documentation available upon request.
- Available in sizes from 1-1/4" to 2" diameter. Other sizes available upon request.
- Conforms to the new lower hardness offshore requirement



Trade Size (in.)	Working Load Limit		Product Code	Master Link Dimensions (in.)			Intermediate Link Dimensions (in.)			Weight (lbs.)
	ton	lbs.		Material Diameter A	Inside Length B	Inside Width C	Material Diameter D	Inside Length E	Inside Width F	
1-1/4	17.64	35,280	SA125DNV	1.25	8.75	4.38	1.25	8.75	4.38	27.8
1-1/2	27.56	55,125	SA150DNV	1.50	10.50	5.25	1.50	10.50	5.25	48.0
1-3/4	38.59	77,175	SA175DNV	1.75	12.00	6.00	1.75	12.00	6.00	75.0
2	50	100,000	SA200DNV	2.00	14.00	7.00	2.00	14.00	7.00	113.7

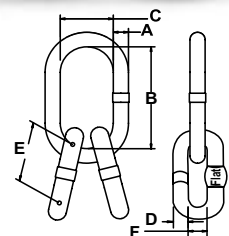

SHOULDER EYE BOLTS

Shoulder eye bolts are most often used as lifting or pulling rings for large objects that are typically made out of metal. When using shoulder eye bolts it is important to always pull the load in the plane of the eye and to reduce the working load limit if loading other than true vertical.

PRODUCT USE, CARE & INSPECTION

MINIMUM ENGAGEMENT DEPTH

Eye bolts should be threaded into the surface a minimum of 1-1/2 times the thread diameter.*

Example:

The minimum engagement depth for an eye bolt with a 1/2" diameter would be 3/4".

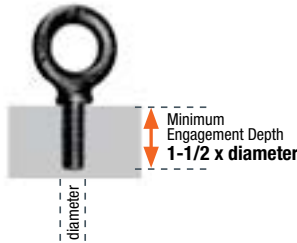

ALWAYS PULL LOAD IN THE PLANE OF THE EYE

When loading shoulder eye bolts, never go below a 45 degree side pull. A vertical pull should be used whenever possible.

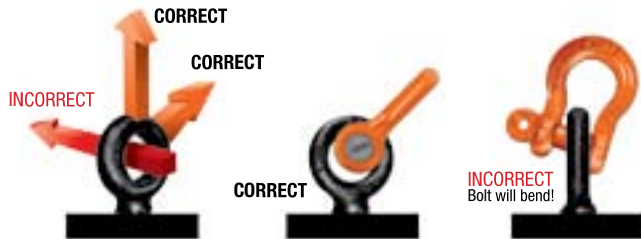

INSTALLATION INSTRUCTIONS & USE:

Inspect eye bolts before use.

- Do not exceed the working load limit - reduce the working load limit according to the table below if loading other than true vertical. Inspect eye bolts before use. Do not use if bent more than 15° or if wear of more than 10% of original dimension is evident.
- Install with shoulder at 90° to axis of hole to assure total contact of shoulder. Torque nut/eye bolt to assure proper seating. Check seating after initial loading.
- If installing in tapped hole, make sure depth of thread engagement is at least 1-1/2 times bolt diameter. Thread fit must also be good and tight.
- Where eye bolts must be aligned, a washer or shim may be placed under the shoulder to permit alignment when tightened.
- To minimize the bending moment, always apply load in the direction of the plane of eye. Reduce working load limit according to table if loading other than true vertical.
- Never insert a hook tip in an eye bolt to load.
- Do not use a sling reeved through an eye bolt or a pair of eye bolts using a shackle.

If in doubt, consult a rigging handbook or discuss with a qualified person

WORKING LOAD LIMIT REDUCTIONS

Shoulder Eye Bolt Working Load Limit Reductions based on Angle to Horizontal				
90° (True Vertical)	75°	65°	45°	Less than 45°
Full working load limit	55% of full working load limit	35% of full working load limit	25% of full working load limit	Do not use

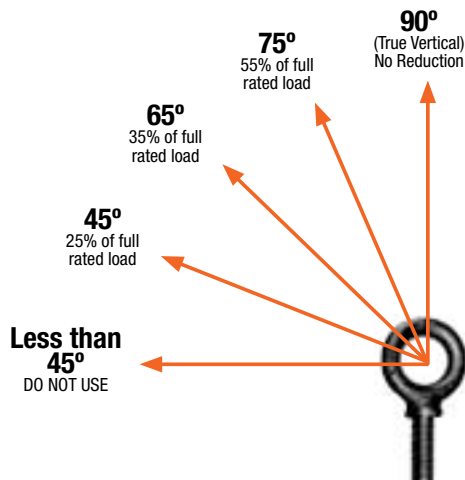

* per ASME B30.26-2.9.4.2 "when used in a tapped blind hole, the effective thread length shall be at least 1-1/2 times the diameter of the bolt for engagement in steel... For other thread engagements or in other materials, contact the eye bolt manufacturer or a qualified person"

Always verify manufacturer's information prior to use.

RIGGING HARDWARE



SHOULDER EYE BOLTS

WORKING LOAD LIMIT: 500 TO 21,000 LBS.

BENEFITS & FEATURES

- Forged steel
- Heat treated, quenched and tempered
- Meets IFI standards, ASTM A489, ANSI/ASME, B18.15, ASME B30.26
- Design factor 5:1

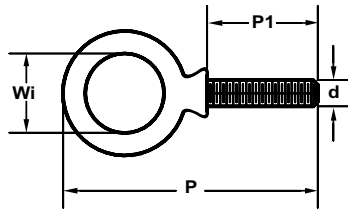

Shank Diameter (in.)	Product Code	Working Load Limit (lbs.)	Dimensions (in.)				Weight (lbs.)
			Wi	P1	P	d Thread (UNC-2A)	
1/4	456920	500	0.75	1.00	2.39	1/4 - 20	0.06
5/16	456921	900	0.87	1.12	2.80	5/16 - 18	0.11
3/8	456922	1,300	1.00	1.25	3.22	3/8 - 16	0.18
7/16	496933	1,800	1.09	1.38	3.59	7/16 - 14	0.22
1/2	456923	2,400	1.19	1.50	3.96	1/2 - 13	0.35
5/8	456924	4,000	1.38	1.75	4.69	5/8 - 11	0.70
3/4	456925	5,000	1.50	2.00	5.28	3/4 - 10	1.10
7/8	456926	7,000	1.69	2.50	6.04	7/8 - 9	1.70
1	456927	9,000	1.81	2.50	6.67	1 - 8	2.36
1-1/8	456930	12,000	2.00	2.75	7.44	1-1/8 - 7	3.98
1-1/4	456928	15,000	2.18	3.00	8.12	1-1/4 - 7	4.68
1-1/2	456929	21,000	2.50	3.50	9.49	1-1/2 - 6	7.77

HOIST RINGS

Used in the same manner as shoulder eye bolts, hoist rings pivot or swivel to provide a steady lift and maintain higher working load limits than shoulder eye bolts when lifting at angles.

PRODUCT USE, CARE & INSPECTION

MINIMUM ENGAGEMENT DEPTH

Hoist rings should be threaded into the surface a minimum of 1-1/2 times the thread diameter.*



INSTALLATION INSTRUCTIONS & USE:

- Drill and tap workpiece so that the hoist ring bolt is installed perpendicular to the surface of the workpiece.
- Work surface (mounting surface) should be flat and smooth to provide full 360° flush seating for the bushing flange of the hoist ring. Mounting screws should always be tightened to recommended torque. (SAFETY NOTE: Some loosening may develop after prolonged service in a permanent installation. It is advisable to periodically re-tighten the mounting screw to maintain the specified torque value.)
- The use of free fit spacers between the bushing flange and mounting surface is not recommended as this will reduce the safe load rating on angularly applied loads.
- After installation, check hoist ring to be sure it swivels and pivots freely in all directions. Hoist ring must be free to swivel 360° and pivot 180° at all times.
- When lifting, apply force gradually.

EFFECT OF HOIST RING ANGLE ON LOAD

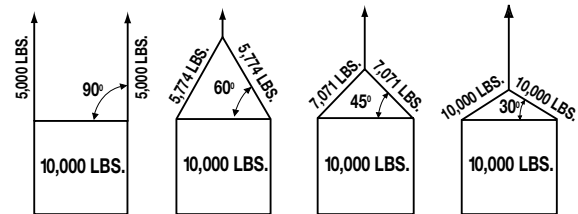
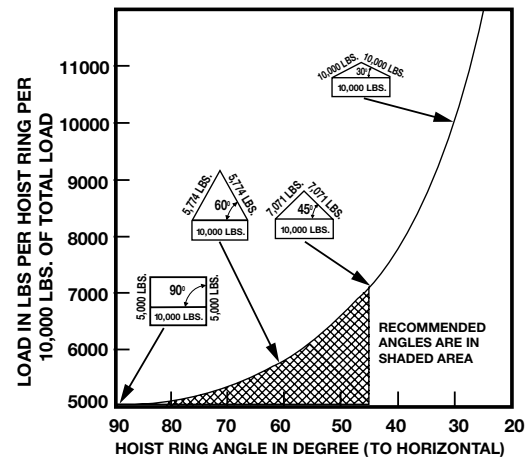

WARNING

Improper installation and use of hoist rings can cause injury

To avoid injury or damage:

- ▲ Never exceed the rated capacity of the hoist ring.
- ▲ Install rings per instructions. Verify full 360° seating - Retorque periodically.
- ▲ Consult angular lifting graph when lifting at other than 90°.

* Per ASME B30.26-2.9.4.2 "when used in a tapped blind hole, the effective thread length shall be at least 1-1/2 times the diameter of the bolt for engagement in steel... For other thread engagements or in other materials, contact the eyebolt manufacturer or a qualified person"

Always verify manufacturer's information prior to use.

RIGGING HARDWARE



HEAVY DUTY® HOIST RING

RATED LOAD: 500 TO 30,000 LBS.

BENEFITS & FEATURES

- Economical forged ring is strong and impact-resistant
- Pivots 180° and swivels 360° simultaneously
- Back and side pins constructed of one piece of forged alloy steel
- 100% magnetic particle inspected
- Bale and center body are closed-die forged to assure superior grain flow and consistent dimensional accuracy
- Large bale allows for use of a variety of hook sizes
- Meets ASME B30.26
- Design factor 5:1

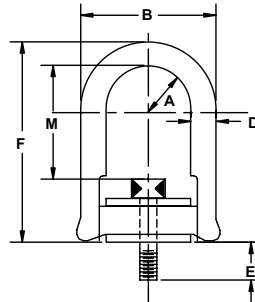

Product Code	Rated Load (lbs.)	Dimensions (in.)							Torque Load (ft.-lbs.)	Weight (lbs.)
		A	B	D	E	F	Thread	M		
433112	500	0.65	2.29	0.44	0.56	3.23	1/4 - 20	1.57	5	0.50
433212	800	0.65	2.29	0.44	0.56	3.23	5/16 - 18	1.51	7	0.52
433214	800	0.65	2.29	0.44	1.06	3.23	5/16 - 18	1.51	7	0.54
433312	1,000	0.65	2.29	0.44	0.56	3.23	3/8 - 16	1.45	12	0.56
433314	1,000	0.65	2.29	0.44	1.06	3.23	3/8 - 16	1.45	12	0.58
433512	2,500	1.00	3.50	0.75	0.75	5.31	1/2 - 13	2.56	28	1.71
433515	2,500	1.00	3.50	0.75	1.00	5.31	1/2 - 13	2.56	28	1.72
433516	2,500	1.00	3.50	0.75	1.25	5.31	1/2 - 13	2.56	28	1.82
433612	4,000	1.00	3.50	0.75	0.75	5.31	5/8 - 11	2.44	60	1.76
433614	4,000	1.00	3.50	0.75	1.00	5.31	5/8 - 11	2.44	60	1.78
433615	4,000	1.00	3.50	0.75	1.25	5.31	5/8 - 11	2.44	60	1.88
433714	5,000	1.00	3.50	0.75	1.00	5.31	3/4 - 10	2.31	100	1.89
433716	5,000	1.00	3.50	0.75	1.50	5.31	3/4 - 10	2.31	100	2.02
433102	7,000	1.40	5.10	1.00	1.20	7.37	3/4 - 10	3.57	100	7.23
433103	7,000	1.40	5.10	1.00	1.45	7.37	3/4 - 10	3.57	100	7.25
433101	8,000	1.40	5.10	1.00	1.20	7.37	7/8 - 9	3.32	160	7.33
433105	10,000	1.40	5.10	1.00	1.45	7.37	1 - 8	3.20	230	7.57
433106	10,000	1.40	5.10	1.00	1.20	7.37	1 - 8	3.20	230	7.63
433107	10,000	1.40	5.10	1.00	2.20	7.37	1 - 8	3.20	230	7.81
433401	15,000	2.00	6.75	1.25	2.63	9.22	1-1/4 - 7	3.74	470	16.00
433420	20,000	2.00	6.75	1.25	2.63	9.22	1-3/8 - 6	3.62	670	17.20
433424	24,000	2.00	6.75	1.25	2.63	9.22	1-1/2 - 6	3.49	800	18.10
433427	30,000	2.00	6.75	1.25	2.96	9.22	2 - 4/1/2	3.49	1,100	22.90
433432	30,000	2.00	6.75	1.25	2.96	9.22	2 - 8	3.49	1,100	22.90

Note: No de-rating required when used in proper applications

Heavy Duty® is not a trademark of Columbus McKinnon Corporation.

RIGGING HARDWARE



SPECIALTY ENGINEERED HOIST RING

RATED LOAD: 550 TO 100,000 LBS.

BENEFITS & FEATURES

- Machined
- Pivots 180° and swivels 360° simultaneously
- Bale and shoulder pin machined from alloy steel
- Patented design provides shoulder pin retention with specialized clip
- Easily disassembled for periodic non-destructive inspection
- Available in stainless steel and metric sizes (special order)
- Meets ASME B30.26
- Design factor 5:1

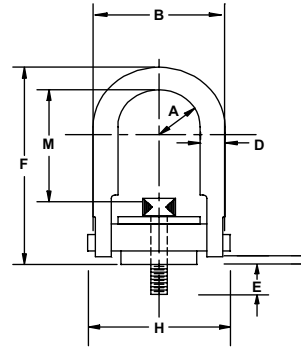

Product Code	Rated Load (lbs.)	Dimensions (in.)							Torque Load (ft.-lbs.)	Weight (lbs.)
		A	D	E	F	Thread	H	M		
423050	550	0.43	0.38	0.54	2.67	1/4 - 20	1.84	1.33	5	0.31
423052	800	0.43	0.38	0.54	2.67	5/16 - 18	1.84	1.27	7	0.31
423053	1,000	0.43	0.38	0.54	2.67	3/8 - 16	1.84	1.21	12	0.31
423301	2,500	0.70	0.50	1.07	3.77	1/2 - 13	2.58	1.84	28	1.00
423004	2,500	0.88	0.75	0.78	4.78	1/2 - 13	3.52	2.31	28	2.31
423322	2,500	0.88	0.75	0.78	6.72	1/2 - 13	3.52	4.25	28	2.75
423005	2,500	0.88	0.75	1.03	4.78	1/2 - 13	3.52	2.31	28	2.31
423323	2,500	0.88	0.75	1.03	6.72	1/2 - 13	3.52	4.25	28	2.00
423006	2,500	0.88	0.75	1.28	4.78	1/2 - 13	3.52	2.31	28	2.31
423324	2,500	0.88	0.75	1.28	6.72	1/2 - 13	3.52	4.25	28	2.75
423001	4,000	0.88	0.75	0.78	4.78	5/8 - 11	3.52	2.18	60	2.44
423002	4,000	0.88	0.75	1.03	4.78	5/8 - 11	3.52	2.18	60	2.44
423320	4,000	0.88	0.75	1.03	6.72	5/8 - 11	3.52	4.12	60	2.88
423003	4,000	0.88	0.75	1.28	4.78	5/8 - 11	3.52	2.18	60	2.56
423321	4,000	0.88	0.75	1.28	6.72	5/8 - 11	3.52	4.12	60	3.00
423007	5,000	0.88	0.75	1.03	4.78	3/4 - 10	3.52	2.06	100	2.56
423325	5,000	0.88	0.75	1.03	6.72	3/4 - 10	3.52	4.0	100	3.00
423009	5,000	0.88	0.75	1.53	4.78	3/4 - 10	3.52	2.06	100	6.63
423327	5,000	0.88	0.75	1.53	6.72	3/4 - 10	3.52	4.00	100	7.25
423102	7,000	1.40	1.00	1.04	6.52	3/4 - 10	5.14	3.06	100	6.63
423103	7,000	1.40	1.00	1.54	6.52	3/4 - 10	5.14	3.06	100	6.75
423330	7,000	1.40	1.00	1.54	8.11	3/4 - 10	5.14	4.65	100	6.75
423101	8,000	1.40	1.00	1.04	6.52	7/8 - 9	5.14	2.93	160	7.00
423328	8,000	1.40	1.00	1.04	8.11	7/8 - 9	5.14	4.52	160	7.00
423105	10,000	1.40	1.00	1.29	6.52	1 - 8	5.14	2.81	230	7.00
423331	10,000	1.40	1.00	1.29	8.11	1 - 8	5.14	4.40	230	7.00
423332	10,000	1.40	1.00	1.54	8.11	1 - 8	5.14	4.40	230	7.00
423106	10,000	1.40	1.00	1.54	6.52	1 - 8	5.14	2.81	230	7.00
423107	10,000	1.40	1.00	2.29	6.52	1 - 8	5.14	2.81	230	7.00
423333	10,000	1.40	1.00	2.29	8.11	1 - 8	5.14	4.40	230	7.00
423401	15,000	1.75	1.25	1.89	8.73	1-1/4 - 7	6.50	4.12	470	14.00
423202	24,000	2.25	1.75	2.70	12.47	1-1/2 - 6	8.55	6.41	800	33.75
423200	30,000	2.25	1.75	2.96	12.47	2 - 4-1/2	8.55	6.41	1,100	36.00
423501	50,000	3.00	2.25	4.00	16.87	2-1/2 - 8	11.67	8.03	2,100	87.50
423503	50,000	3.00	2.25	4.00	16.87	2-1/2 - 4	11.67	8.03	2,100	87.50
423600	75,000	3.75	2.75	5.20	19.50	3 - 4	14.15	8.48	4,300	166.00
423701	100,000	4.00	3.25	7.00	22.09	3-1/2 - 4	15.90	9.28	6,600	240.00

RIGGING HARDWARE



HOIST RING (METRIC)

RATED LOAD: 400 TO 13,500 KG

BENEFITS & FEATURES

- Swivels 360° and pivots 180° while under load
- 5:1 design factor
- Retain the same rated load from 0 to 90°
- Black oxide finish for corrosion resistance
- Meets ANSI/ASME B30.26
- Design factor 5:1

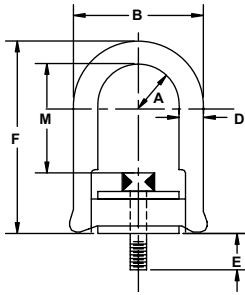

Product Code	Rated Load (kg.)	Dimensions (mm)							Torque Load (N.m.)	Weight (kg.)
		A	B	D	E	F	Thread	M		
434212	400	16.50	58.20	11.10	16.00	82.00	M8 x 1.25	38.50	9.50	0.24
434214	400	16.50	58.20	11.10	21.00	82.00	M8 x 1.25	38.50	9.50	0.25
434312	450	16.50	58.20	11.10	16.00	82.00	M10 x 1.5	36.50	16.00	0.25
434314	450	16.50	58.20	11.10	26.00	82.00	M10 x 1.5	36.50	16.00	0.26
434515	1,050	25.40	88.90	19.10	25.00	134.90	M12 x 1.75	65.00	37.00	0.78
434516	1,050	25.40	88.90	19.10	32.00	134.90	M12 x 1.75	65.00	37.00	0.83
434614	1,900	25.40	88.90	19.10	25.00	134.90	M16 x 2.0	62.00	80.00	0.81
434615	1,900	25.40	88.90	19.10	32.00	134.90	M16 x 2.0	62.00	80.00	0.85
434714	2,200	25.40	88.90	19.10	25.00	134.90	M20 x 2.5	58.70	135.00	0.86
434716	2,200	25.40	88.90	19.10	38.00	134.90	M20 x 2.5	58.70	135.00	0.92
434101	3,000	35.60	129.50	25.40	28.00	187.20	M20 x 2.5	89.70	135.00	3.14
434102	4,200	35.60	129.50	25.40	28.00	187.20	M24 x 3.0	85.70	311.00	3.29
434103	4,200	35.60	129.50	25.40	38.00	187.20	M24 x 3.0	85.70	311.00	3.30
434105	4,500	35.60	129.50	25.40	38.00	187.20	M30 x 3.5	79.70	311.00	3.44
434107	4,500	35.60	129.50	25.40	48.00	187.20	M30 x 3.5	79.70	311.00	3.55
434401	7,000	50.80	171.50	31.80	67.00	234.20	M30 x 3.5	95.00	637.20	7.26
434402	11,000	50.80	171.50	31.80	67.00	234.20	M36 x 4.0	88.60	1,085.50	8.21
434403	12,500	50.80	171.50	31.80	80.00	234.20	M42 x 4.5	88.60	1,085.50	10.14
434404	13,500	50.80	171.50	31.80	80.00	234.20	M48 x 5.0	88.60	1,085.50	10.59

RIGGING HARDWARE



HOIST RING SWIVEL

RATED LOAD: 2,000 TO 20,000 LBS.

BENEFITS & FEATURES

- Machined
- Pivots 180° and swivels 360° simultaneously
- Bale and shoulder pin machined from alloy steel
- Patented design provides shoulder pin retention with specialized clip
- Design factor 6:1

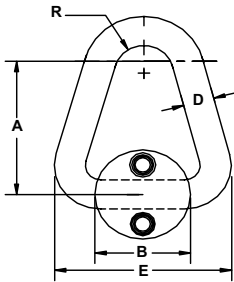

Product Code	Rated Load (lbs.)	Dimensions (in.)					Torque Load (ft.-lbs.)	Weight (lbs.)	High Strength Screws		
		A	B	D	E	R			Product Code	Screw Thread	Screw Length (in.)
434030	2,000	2	1-3/4	5/16	2-1/2	1/2	4-7	0.54	423812	43,236	1.25
434035	2,500	2-1/2	2-1/4	3/8	3-3/16	5/8	7-10	1.02	423813	42,437	1.25
434040	5,000	3	2-5/8	1/2	3-7/8	3/4	20-25	1.92	423804	41,276	2.00
434045	12,000	4	3-1/8	3/4	5-1/4	7/8	20-25	3.94	-	-	-
434050	20,000	5	3-5/8	1	6-3/16	1	42-50	7.44	-	-	-

RIGGING HARDWARE

TURNBUCKLES

WORKING LOAD LIMIT: 400 TO 21,400 LBS.

BENEFITS & FEATURES

- Turnbuckles can be used to apply tension to wire rope or cable.
- Composed of a forged body and two end fittings. End fittings can be eyes, jaws, or hooks.
- Must only be applied to loads within their working load limit as specified for the particular end fitting being applied.
- Apply turnbuckles in a straight in-line manner only. Do not allow anything to contact the turnbuckle body or end attachment threaded shanks.
- Apply load to the center of end attachment eyes and bowl of hooks. Do not tip load hooks or side load eyes.
- Design factor 5:1

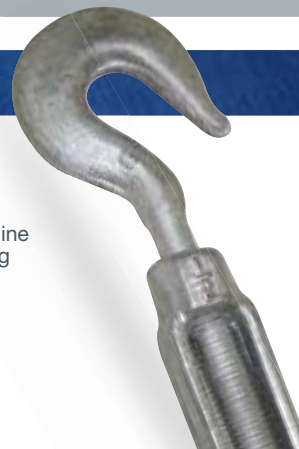

Eye & Eye		Jaw & Eye		Jaw & Jaw		Thread Diameter (in.)	Take Up (in.)	WLL (lbs.)	Weight (lbs.)
Product Code	Weight (lbs.)	Product Code	Weight (lbs.)	Product Code	Weight (lbs.)				
0404EE	0.3	0404JE	0.3	0404JJ	0.4	1/4	4	500	0.4
0504EE	0.5	0504JE	0.5	0504JJ	0.6	5/16	4.5	800	0.6
0606EE	0.8	0606JE	0.9	0606JJ	0.9	3/8	6	1,200	0.9
0806EE	1.5	0806JE	1.7	0806JJ	1.8	1/2	6	2,200	1.8
0809EE	1.9	0809JE	2.0	0809JJ	2.1	1/2	9	2,200	2.1
0812EE	2.3	0812JE	2.4	0812JJ	2.4	1/2	12	2,200	2.4
1006EE	2.5	1006JE	3.0	1006JJ	3.0	5/8	6	3,500	3.0
1009EE	3.3	1009JE	3.5	1009JJ	3.7	5/8	9	3,500	3.7
1012EE	3.8	1012JE	4.0	1012JJ	4.2	5/8	12	3,500	4.2
1206EE	3.9	1206JE	4.3	1206JJ	4.6	3/4	6	5,200	4.6
1209EE	4.8	1209JE	5.1	1209JJ	5.4	3/4	9	5,200	5.4
1212EE	5.4	1212JE	5.7	1212JJ	6.0	3/4	12	5,200	6.0
1218EE	7.0	1218JE	7.3	1218JJ	7.7	3/4	18	5,200	7.7
1412EE	7.4	1412JE	7.9	1412JJ	8.4	7/8	12	7,200	8.4
1418EE	9.6	1418JE	10.2	1418JJ	10.7	7/8	18	7,200	10.7
1606EE	9.0	1606JE	9.4	1606JJ	9.7	1	6	10,000	9.7
1612EE	11.2	1612JE	11.6	1612JJ	11.9	1	12	10,000	11.9
1618EE	13.8	1618JE	14.3	1618JJ	14.8	1	18	10,000	14.8
1624EE	17.1	1624JE	17.6	1624JJ	18.2	1	24	10,000	18.2
2012EE	20.9	-	-	2012JJ	23.8	1-1/4	12	15,200	23.8
2018EE	25.7	-	-	2018JJ	27.5	1-1/4	18	15,200	27.5
2024EE	29.7	-	-	2024JJ	33.7	1-1/4	24	15,200	33.7
2412EE	29	-	-	2412JJ	38.1	1-1/2	12	21,400	38.1
2418EE	35.2	-	-	2418JJ	44.2	1-1/2	18	21,400	44.2
2424EE	40.7	-	-	2424JJ	48.4	1-1/2	24	21,400	48.4

CARE & INSPECTION

Inspect turnbuckles before use for bent components and worn threads. Do not use if body or end fitting is bent more than 10° from the axial center line. Do not use if threads are visibly worn or feel loose. If in doubt, consult a rigging handbook or discuss with a qualified person.

WARNING

Improper use or care of turnbuckles can result in bodily injury or property damage. To avoid injury:

- Inspect turnbuckles for distortion and wear.
- Do not use if anything is in contact with the turnbuckle body or an end fitting.
- Only apply load to center of eyes and bowl of hooks.
- Do not exceed working load limit.

TURNBUCKLE LOCK NUTS



Size (in.)	Product Code		Weight (lbs.)
	Right Hang Nut	Left Hang Nut	
1/4	3X845	3X845L	0.005
5/16	-	3X846L	0.008
3/8	3X847	3X847L	0.010
1/2	3X849	3X849L	0.030
5/8	-	3X850L	0.050
3/4	-	3X851L	0.090
7/8	-	3X852L	0.130
1	-	3X853L	0.200
1-1/4	-	3X855L	0.410
1-1/2	-	3X866L	0.700

Imported. Hot Dip Galvanized.

Imported.

Product Code		Thread Diameter (in.)	Take Up (in.)	WLL (lbs.)	Weight (lbs.)
Hook & Eye	Hook & Hook				
0404HE	0404HH	1/4	4	400	-
0504HE	0504HH	5/16	4-1/2	700	-
0606HE	0606HH	3/8	6	1,000	0.8
0806HE	0806HH	1/2	6	1,500	1.5
0809HE	0809HH	1/2	9	1,500	1.9
0812HE	0812HH	1/2	12	1,500	2.3
1006HE	1006HH	5/8	6	2,250	2.5
1009HE	1009HH	5/8	9	2,250	3.3
1012HE	1012HH	5/8	12	2,250	3.8
1206HE	1206HH	3/4	6	3,000	3.9
1209HE	1209HH	3/4	9	3,000	4.8
1212HE	1212HH	3/4	12	3,000	5.4
1218HE	1218HH	3/4	18	3,000	7.0
1412HE	1412HH	7/8	12	4,000	7.4
1418HE	1418HH	7/8	18	4,000	9.6
1606HE	1606HH	1	6	5,000	9.0
1612HE	1612HH	1	12	5,000	11.2
1618HE	1618HH	1	18	5,000	13.8
1624HE	1624HH	1	24	5,000	17.1
2418HE	2418HH	1-1/2	18	7,500	31.2
2424HE	2424HH	1-1/2	24	7,500	38.2

Imported.



WIRE ROPE CLIPS

SIZES: 1/8 TO 1-1/2 IN.

BENEFITS & FEATURES

- Precision manufactured and galvanized to meet federal specifications (FF-C-450 Type 1 Class 1) on 1/4" and larger.
- Drop forged base

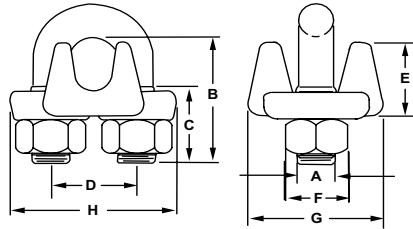

Size (in.)	Standard Package	Product Code	Dimensions (in.)								Minimum Number of Clips	Torque (ft./lbs.)	Rope Turnback	Weight (lbs.)
			A	B	C	D	E	F	G	H				
1/8	50	M244	1/8-24UNC	0.72	0.44	0.47	0.42	0.38	0.81	1.09	2	4-1/2	3-1/4	0.08
3/16	50	M245	1/4-20UNC	0.94	0.56	0.59	0.50	0.50	0.94	1.19	2	7-1/2	3-3/4	0.12
1/4	50	M246	5/16-18UNC	1.03	0.50	0.75	0.66	0.56	1.19	1.44	2	15	4-3/4	0.18
5/16	50	M247	3/8-16UNC	1.38	0.75	0.88	0.72	0.69	1.31	1.69	2	30	5-1/4	0.30
3/8	50	M248	7/16-14UNC	1.50	0.75	1.00	0.91	0.75	1.63	1.94	2	45	6-1/2	0.42
7/16	50	M249	1/2-13UNC	1.88	1.00	1.19	1.06	0.88	1.78	2.31	2	65	7	0.70
1/2	20	M250	1/2-13UNC	1.88	1.00	1.19	1.16	0.88	1.91	2.31	3	65	11-1/2	0.85
9/16	20	M296	9/16-12UNC	2.38	1.25	1.31	1.24	0.94	1.94	2.50	3	95	12	1.00
5/8	20	M251	9/16-12UNC	2.38	1.25	1.31	1.34	0.94	2.00	2.49	3	95	12	1.00
3/4	10	M252	5/8-11UNC	2.75	1.44	1.50	1.44	1.06	2.34	2.81	4	130	18	1.53
7/8	10	M253	3/4-10UNC	3.13	1.63	1.75	1.63	1.25	2.44	3.16	4	225	20	2.40
1	10	M254	3/4-10UNC	3.50	1.81	1.88	1.78	1.25	2.63	3.47	5	225	26	2.50
1-1/8	5	M255	3/4-10UNC	3.88	2.00	2.00	1.88	1.25	2.81	3.59	6	225	34	3.10
1-1/4	5	M256	7/8-9UNC	4.25	2.13	2.31	2.19	1.44	3.15	4.22	7	360	37	4.10
1-3/8	5	M257	7/8-9UNC	4.63	2.31	2.38	2.25	1.44	3.08	4.25	7	360	44	4.50
1-1/2	5	M258	7/8-9UNC	4.94	2.38	2.59	2.50	1.44	3.41	4.47	8	360	48	5.40

NOTE: 1/8" through 5/8" packed 1 piece per poly bag. 3/4" & larger shipped assembled in factory packs and tagged.

PROPER USE OF WIRE ROPE CLIPS

1. Refer to the chart above when following these instructions. Turn back specified amount of rope from thimble or loop. Apply first clip one base width from dead end of rope. Apply U-bolt over dead end of wire rope, ensuring live end rests in saddle. Tighten nuts evenly, alternate from one nut to the other until reaching the recommended torque.
2. When two clips are required, apply the second clip as near the thimble or loop as possible. Tighten nuts evenly, alternating until reaching the recommended torque. When more than two clips are required, apply the second clip as near the loop or thimble as possible and turn nuts on second clip firmly, but do not tighten. Proceed to Step 3.
3. When three or more clips are required, space additional clips equally between the first two and take up rope slack. Then tighten nuts on each U-bolt evenly, alternating from one nut to the other until reaching the recommended torque.
4. Apply an initial load equal to loads expected in use. Inspect for proper orientation and spacing of clips and retighten the nuts to recommended torque.

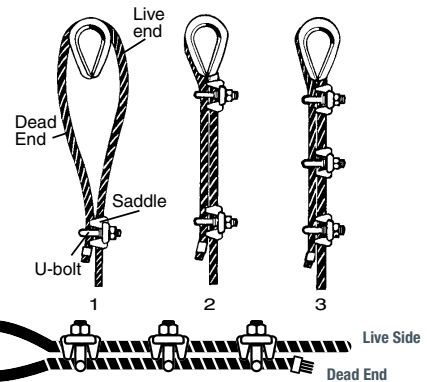

NOTE: Mechanical spliced or finished eyes slings are the preferred method of wire rope sling construction. OSHA does not allow the use of clips to form the eyes of wire rope slings.

CARE

- Care should be exercised in the installation and use of wire rope clips so that the clip, wire rope, or thimble is not damaged.
- Do not over torque or under torque the nuts. Too much torque can result in damage to the clip and/or the wire rope. Too little torque can result in the wire rope slipping. Torque nuts to the value specified in the accompanying instructions.
- Clips should not be subjected to bending or come in contact with sharp object.
- Avoid exposure to corrosive mediums.

INSPECTION

- Visually inspect wire rope clips before each use.
- Be certain threads are not stripped and that nuts are tight.
- Check torque of nuts periodically.
- Replace distorted thimbles.
- Shorten wire rope and form new loop if damaged.
- Replace distorted thimbles.

⚠ WARNING

NEVER INSTALL THE U-BOLT ON THE LIVE SIDE!

IMPROPER USE OF WIRE ROPE CLIPS



MID-GRIP WIRE ROPE CLIPS

SIZES: 3/16 TO 3/4 IN.

BENEFITS & FEATURES

- Allows for full arc wrench swing for quicker installation, retightening and disassembly.
- Saddles are made of forged steel for strength and wearability. Full assembly is mechanical galvanized per ASTM B695-04 Class 25 Type 1.
- Size, manufacturer and trace code are clearly marked on the saddle for easy identification.
- Meets or exceeds performance requirements of FF-C-450 specifications, Type III, Class 1 and will provide maximum holding strength.

NEW & IMPROVED HEX BOLT & NUT DESIGN

TIGHT, SECURE FIT

Hexagon bolt head fits securely into hex-shaped socket for exceptional rotation resistance. This prevents spinning even after repeated use and re-torquing.

PRECISE THREADING

Precise threading on bolt and nut ensures tight alignment and exceptional strength.

FEWER LOOSE PARTS TO DROP

Hex bolt is knurled and machine pressed into socket to securely couple with the saddle.

EASY TO INSPECT

Sight window/notch on top of mid-grip allows for easy inspection of the bolts.



NEW STYLE

Available in 3/16" through 5/8"

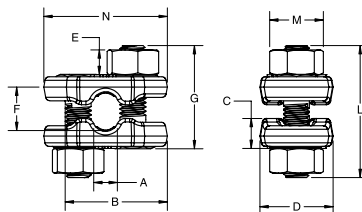

OLD STYLE

Available in 3/4" only

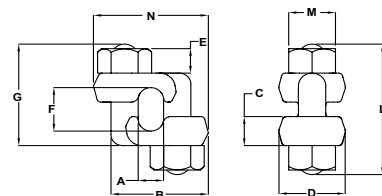

Size (in.)	Standard Package	Product Code	Dimensions (in.)										Minimum Number of Clips	Rope Turn-Back (in.)	Torque (ft./lbs.)	Weight (lbs.)
			A	B	C	D	E Thread	F	G	L Approx.	M	N				
New Style																
3/16	20	M2546	0.37	1.53	0.44	1.06	3/8 - 16	0.50	1.50	1.93	0.69	1.74	2	4	30	0.38
1/4	20	M2546	0.37	1.53	0.44	1.06	3/8 - 16	0.50	1.50	1.93	0.69	1.74	2	4	30	0.38
5/16	20	M2547	0.34	1.48	0.44	1.06	3/8 - 16	0.63	1.50	1.90	0.69	1.80	2	5	30	0.38
3/8	20	M2548	0.46	1.67	0.54	1.13	7/16 - 14	0.75	1.84	2.26	0.75	2.00	2	5.5	45	0.49
7/16	20	M2550	0.65	2.03	0.59	1.31	1/2 - 13	1.05	2.23	2.74	0.88	2.40	2	6.5	65	0.84
1/2	20	M2550	0.65	2.03	0.59	1.31	1/2 - 13	1.05	2.23	2.74	0.88	2.40	3	11	65	0.84
9/16	20	M2551	0.78	2.46	0.73	1.63	5/8 - 11	1.38	2.81	3.44	1.06	2.90	3	12.75	130	1.55
5/8	20	M2551	0.78	2.46	0.73	1.63	5/8 - 11	1.38	2.81	3.44	1.06	2.90	3	13.5	130	1.55
Old Style																
3/4	20	M2252	0.81	2.69	0.88	1.81	3/4 - 10	1.50	3.38	5.00	1.25	3.02	3	16	225	1.79

INSPECTION, CARE & USE

PROPER USE OF MID-GRIP CLIPS

- Refer to chart above when following these instructions. Turn back specified amounts of rope from thimble or loop. Apply first clip one base width from dead end of rope. Tighten nuts evenly, alternating from one nut to the other until reaching the recommended torque.
- When two clips are required, apply the second clip as near the loop or thimble as possible. Tighten nuts evenly, alternating until reaching the recommended torque. When more than two clips are required, apply the second clip as near the loop or thimble as possible and turn nuts on second clip firmly, but do not tighten. Proceed to step 3.
- When three or more clips are required, space additional clips between first two and take up rope slack. Then tighten nuts on all clips, alternating from one nut to the other until reaching the recommended torque.
- Apply an initial load equal to loads expected in use. Inspect for proper spacing and retighten the nuts to the recommended torque.

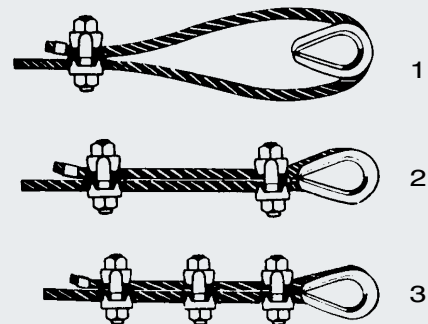

For more information, visit us at www.cmworks.com



PIGGYBACK® WEDGE SOCKET CLIPS

SIZES: 3/8 TO 1-1/2 IN.

BENEFITS & FEATURES

- Forged saddles include size, USA and CM logo
- Drop-forged base for superior function and wearability
- Galvanized finish

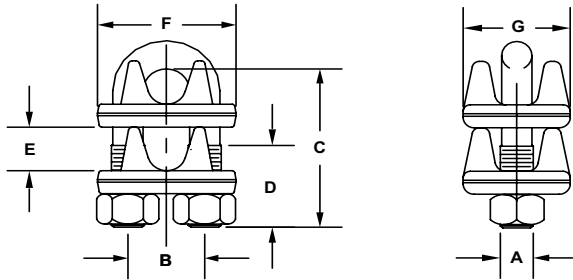

Size (in.)	Standard Package	Product Code	Saddle	U-Bolt	Dimensions (in.)							Heavy Hex Nut Galv.	Torque (ft./lbs.)	Min. Tail (in.)	Weight (lbs.)
					A	B	C	D	E	F	G				
3/8	10	M248D	1X248	2X248L	7/16-14UNC	1.00	2.38	0.75	0.69	1.94	1.62	602224	45	6	0.8
7/16	10	M249D	1X249	2X250L	1/2-13UNC	1.19	2.62	1.00	0.66	2.31	1.78	602225	65	6	1.3
1/2	10	M250D	1X250	2X250L	1/2-13UNC	1.19	2.62	1.00	0.72	2.31	1.91	602225	65	6	1.4
9/16	10	M296D	1X296	2X251L	9/16-12UNC	1.31	3.19	1.25	0.77	2.50	1.97	602226	95	6	1.7
5/8	10	M251D	1X251	2X251L	9/16-12UNC	1.31	3.19	1.25	0.87	2.50	2.00	602226	95	6	1.7
3/4	10	M252D	1X252	2X252L	5/8-11UNC	1.50	3.50	1.50	0.91	2.81	2.34	602227	130	6	2.5
7/8	5	M253D	1X253	2X253L	3/4-10UNC	1.75	3.88	2.00	1.07	3.16	2.44	602228	225	6	3.6
1	5	M254D	1X254	2X254L	3/4-10UNC	1.88	4.25	2.00	1.22	3.47	2.62	602228	225	6	3.9
1-1/8	5	M255D	1X255	2X255L	3/4-10UNC	2.00	4.50	2.00	1.31	3.59	2.81	602228	225	6-3/4	4.9
1-1/4	5	M256D	1X256	2X256L	7/8-9UNC	2.31	5.25	2.38	1.50	4.22	3.15	602246	360	7-1/2	6.5
1-3/8	5	M257D	1X257	2X257L	7/8-9UNC	2.38	5.62	2.38	1.56	4.25	3.08	602246	360	8-1/4	7.1
1-1/2	5	M258D	1X258	2X258L	7/8-9UNC	2.59	6.00	2.38	1.75	4.47	3.41	602246	360	9	8.2

RIGGING HARDWARE

PROPER USE OF PIGGYBACK WEDGE SOCKET CLIPS

- Dead end wire rope tail length should be at least 6 rope diameters, but not less than 6 inches beyond the wedge socket. See Figure 1.
- Apply U-bolt and first saddle on dead end rope and the second saddle on live end rope. Install nuts. See Figures 1 & 2.
- Position the dual saddle clip so that 3 to 4 inches of dead end rope remain beyond the clip. See Figures 1 & 2.
- Tighten nuts evenly. Alternate tightening each nut until reaching the required torque specified. See Figure 2.
- Check that clip does not pinch or clamp the live wire rope. Apply an initial test load equal to the loads expected in regular use. Be certain rope is secured properly in the wedge socket prior to any use.
- Inspect for proper rope alignment with wedge socket and retighten the nuts to the specified torque.

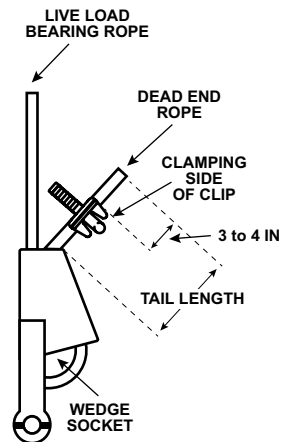

FIGURE 1

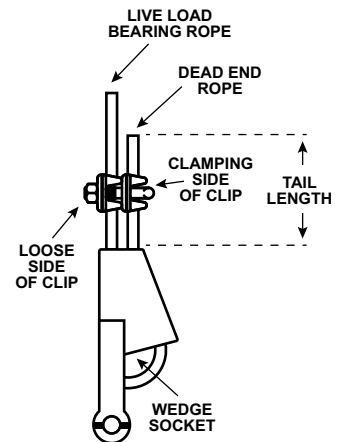

FIGURE 2



BUNDLING CLIP

SIZES: 3/4 TO 1-1/8 IN.

BENEFITS & FEATURES

- Galvanized and painted U-bolt with rolled threads. Interchangeable and replaceable with our standard wire rope clip U-bolts.
- Forged and galvanized saddles come with FORGED USA, size, CM logo and trace code forged in.
- Meets B30.26 plus traceability.
- Performs to rated capacities.
- After inspection, the CM Bundling Clip is reusable.
- Available for use with 3/4", 7/8", 1" and 1-1/8" wire rope chokers.

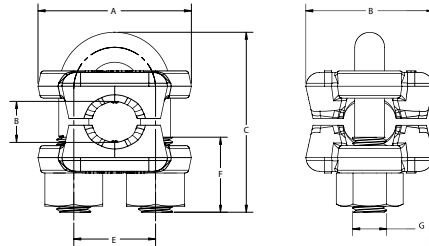

Size (in.)	Standard Package	Product Code	Dimensions (in.)							Torque (ft./lbs.)	Weight (lbs.)
			A	B	C	D	E	F	G		
3/4	10	M252B	2.81	2.81	3.30	0.75	1.50	1.38	5/8"-11 UNC	130	2.5
7/8	5	M253B	3.16	2.44	3.80	0.88	1.75	1.63	3/4"-10 UNC	225	3.6
1	5	M254B	3.47	2.63	4.16	1.00	1.88	1.81	3/4"-10 UNC	225	3.9
1-1/8	5	M255B	3.60	2.81	4.54	1.13	2.00	2.00	3/4"-10 UNC	225	4.9

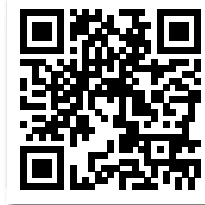

SEE BUNDLING CLIPS IN ACTION
<http://www.youtube.com/user/ColumbusMcKinnon>

SWAGE SOCKET (OPEN)

SIZES: 1/4 TO 1-3/4 IN.

BENEFITS & FEATURES

- Forged from fine grain, special bar quality C-1035 steel
- Spheroidized annealed for cold swaging
- Recommended for use on 6" x 19" or 6" x 37" IWRC regular lay wire ropes. Can also be used on galvanized bridge rope.
- Not for use on fiber core or lang lay ropes.**
- Sockets have 100% efficiency rating based on catalog strength of wire rope when properly applied

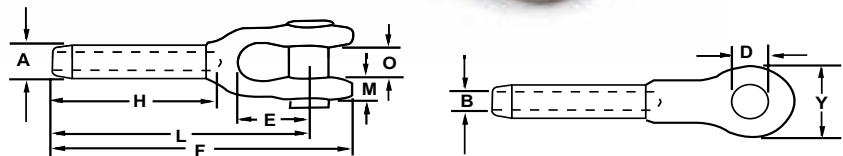

Size (in.)	Product Code	Dimensions (in.)										After Swage Diameter (in.)	Weight (lbs.)
		A	B	D	E	F	H	L	M	O	Y		
1/4	697120	0.50	0.27	0.69	1-1/2	4-3/4	2-1/8	4	5/16	11/16	1-3/8	0.44	0.55
3/8	697122	0.77	0.41	0.81	1-3/4	6-1/4	3-3/16	5-5/16	13/32	13/16	1-5/8	0.69	1.08
7/16	697123*	0.98	0.48	1.00	2	7-13/16	4-1/4	6-11/16	1/2	1	2	0.88	2.30
1/2	697124	0.98	0.55	1.00	2	7-13/16	4-1/4	6-11/16	1/2	1	2	0.88	2.25
9/16	697125*	1.26	0.61	1.19	2-1/4	9-9/16	5-5/16	8-1/8	5/8	1-1/4	2-1/2	1.13	4.60
5/8	697126	1.26	0.67	1.19	2-1/4	9-9/16	5-5/16	8-1/8	5/8	1-1/4	2-1/2	1.13	4.50
3/4	697127*	1.55	0.80	1.38	2-3/4	11-11/16	6-3/8	10	3/4	1-1/2	3	1.38	7.80
7/8	697128*	1.70	0.94	1.63	3-1/4	13-5/8	7-7/16	11-5/8	15/16	1-3/4	3-3/8	1.50	11.70
1	697129*	1.98	1.06	2.00	3-3/4	15-5/8	8-1/2	13-3/8	1-1/32	2	4	1.75	17.80
1-1/8	697130*	2.25	1.19	2.25	4-1/4	17-1/2	9-9/16	15	1-3/16	2-1/4	4-1/2	2.00	29.70
1-1/4	697131*	2.53	1.33	2.50	4-3/4	19-7/16	10-5/8	16-1/2	1-3/16	2-1/2	5	2.25	36.00
1-3/8	697132*	2.80	1.45	2.50	5-1/4	21-1/4	11-11/16	18-1/8	1-5/16	2-1/2	5-1/4	2.50	47.00
1-3/4	697134*	3.39	1.86	3.50	6-3/4	27-1/8	14-7/8	23	1-11/16	3-1/2	7	3.00	93.00

* Special ordered.



SWAGE SOCKET (CLOSED)

SIZES: 5/16 TO 1-1/2 IN.

BENEFITS & FEATURES

- Forged from fine grain, special bar quality C-1035 steel
- Spheroidized annealed for cold swaging
- Recommended for use on 6" x 19" or 6" x 37" IWRC regular lay wire ropes. Can also be used on galvanized bridge rope.
- **Not for use on fiber core or lang lay ropes.**
- Sockets have 100% efficiency rating based on catalog strength of wire rope when properly applied

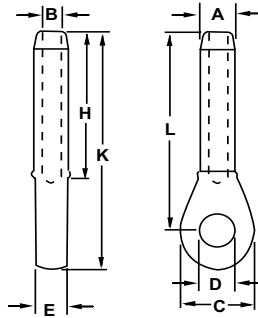

Size (in.)	Product Code	Dimensions (in.)								After Swage Diameter (in.)	Weight (lbs.)
		A	B	C	D	E	H	K	L		
5/16	697152*	0.77	0.34	1-11/16	0.88	11/16	3-3/16	5-1/2	4-1/2	0.69	0.79
3/8	697153*	0.77	0.41	1-11/16	0.88	11/16	3-3/16	5-1/2	4-1/2	0.69	0.78
7/16	697154	0.98	0.48	2	1.06	7/8	4-1/4	6-15/16	5-3/4	0.88	1.45
1/2	697155*	0.98	0.55	2	1.06	7/8	4-1/4	6-15/16	5-3/4	0.88	1.38
9/16	697156*	1.26	0.61	2-1/2	1.25	1-1/8	5-5/16	8-3/4	7-1/4	1.13	2.78
5/8	697157	1.26	0.67	2-1/2	1.25	1-1/8	5-5/16	8-3/4	7-1/4	1.13	2.75
7/8	697159	1.70	0.94	3-1/2	1.69	1-1/2	7-7/16	12-1/8	10-1/8	1.50	7.50
1-1/4	697162*	2.53	1.33	5	2.56	2-1/4	10-5/8	17-1/4	14-3/8	2.25	23.00
1-3/8	697163*	2.80	1.45	5-1/4	2.56	2-1/4	11-11/16	18-7/8	15-3/4	2.50	31.00
1-1/2	697164	3.08	1.58	5-1/2	2.81	2-1/2	12-3/4	20-3/8	17	2.75	39.00

* Special ordered.

RIGGING HARDWARE

SWAGE BUTTON

FOR ROPE DIAMETERS: 1/8 TO 1-1/8 IN.



BENEFITS & FEATURES

- Fittings machined from specially selected and processed low carbon steel
- Buttons have 98% efficiency rating based on catalog strength of wire rope when properly applied



Rope Diameter (in.)	Product Code	Dimensions (in.)		Weight (lbs.)
		Wi	P	
1/8	697101*	0.38	0.63	0.03
3/16	697102*	0.50	0.88	0.05
5/16	697104	0.75	1.38	0.16
3/8	697105	0.75	1.75	0.19
1/2	697107	1.13	2.19	0.54
5/8	697109	1.38	2.88	1.06
3/4	697110	1.50	3.25	1.36
7/8	697111	1.75	3.88	2.19
1	697112	2.00	4.38	3.15
1-1/8	697113	2.25	4.81	4.58

* Special ordered.

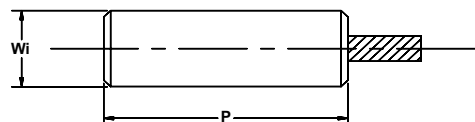



SWAGING SLEEVE FOR FLEMISH EYE

FOR ROPE DIAMETERS: 1/4 TO 2-1/2 IN.

BENEFITS & FEATURES

- Carbon steel sleeves come with unique color change quality control feature – color changes intensity once sleeve has been pressed verifying that swaging has occurred
- Zinc plating extends shelf life and resists rusting
- Color coding helps determine size and simplifies inventory
- Seamless construction
- Fits standard industry dies
- Mill-certified, annealed low-carbon steel provides consistent swaging without cracking
- No need for 16th size dies (O.D. of 16th sizes same as next largest sleeve size).

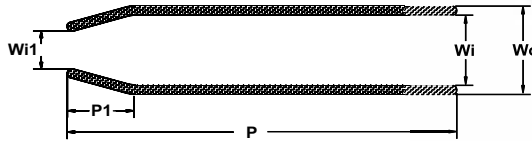

Rope Diameter (in.)	Color	Standard Package	Product Code	Dimensions (in.)					Wall Thickness (in.)	Diameter After Swage (in.)	Weight (lbs.)
				P	W0	W1	Wi	P1			
0.250	Gold	250	697180*	1.00	0.66	0.33	0.47	0.28	0.09	0.50	0.04
0.312	Red	200	697181	1.50	0.91	0.44	0.61	0.47	0.14	0.73	0.14
0.375	Green	100	697182*	1.50	0.91	0.47	0.66	0.47	0.13	0.73	0.12
0.500	Gold	50	697184*	2.00	1.22	0.63	0.91	0.59	0.16	0.98	0.28
0.625	Green	25	697186	2.75	1.47	0.75	1.09	0.70	0.19	1.20	0.56
0.750	Blue	20	697187	3.19	1.72	0.92	1.28	0.86	0.22	1.41	0.88
0.875	Gold	10	697188*	3.56	2.01	1.01	1.53	1.00	0.25	1.63	1.38
1.000	Self Colored	10	697189	4.00	2.28	1.16	1.72	1.13	0.28	1.88	1.90
1.250	Self Colored	Bulk	697191*	5.20	2.78	1.47	2.16	1.41	0.31	2.27	3.40
1.500	Self Colored	Bulk	697193	6.25	3.25	1.69	2.63	1.69	0.31	2.65	5.00
1.750	Self Colored	Bulk	697194	7.25	3.84	1.94	3.13	1.97	0.36	3.04	8.40
2.000	Self Colored	Bulk	697195	8.50	4.38	2.25	3.63	2.25	0.38	3.50	11.30
2.250	Self Colored	Bulk	697196*	9.56	5.03	2.50	4.03	2.53	0.50	4.06	19.20
2.500	Self Colored	Bulk	697197*	10.50	5.50	2.75	4.50	2.81	0.50	4.44	23.20

* Special ordered.

RIGGING HARDWARE





HEAVY-DUTY CRANE HOOKS

SECTION OVERVIEW	112
SINGLE HOOKS	116
RAMSHORN HOOKS	118
FORM B RAMSHORN HOOKS	120
EYE HOOKS	122

HEAVY-DUTY CRANE HOOKS OVERVIEW

Columbus McKinnon's Stahlhammer Bommern GmbH (STB) business is the number one manufacturer of heavy-load single and ramshorn hooks in Europe. Now available in North America, our offering includes a comprehensive line of heavy-duty crane hooks in both single- and double-hook configurations. This offering includes standard forged hooks, crossheads, nuts and complete hook suspensions. Designed to stringent, globally recognized DIN standards, our high-quality un-machined and machined products range in capacity from 1 to 1,250 metric tons.* We also offer a variety of specialty hooks and parts for unique lifting and industrial applications.

* Capacities listed are per DIN 15400 drive group 2m (approximated to CMAA Specification No. 70, Service Class C). For capacities in different drive groups, please refer to DIN 15400.

PRODUCTS



Single Hook

SINGLE HOOKS

Made of high-quality steel, our single hooks are used in a variety of lifting applications. Single hooks are available as un-machined and machined with multiple suspension types. We also offer extended shafts and custom hooks machined to your exact specifications.



Ramshorn Hook



Ramshorn Form B Hook

RAMSHORN HOOKS

Frequently used with heavy-duty cranes in marine and industrial applications, ramshorn, or double/sister hooks, are ideal for applications that require equal load distribution when using multiple slings. The double hook design prevents damage to the sling and choking at the lifting point. Our double hooks are available up to size no. 400 with capacities up to 1,250 metric tons, in two different configurations:

- Standard Ramshorn Hooks
- Form B Ramshorn Hooks
Feature a shackle connection point for increased rigging flexibility.



Eye Hook

EYE HOOKS

In addition to our single- and double-hook offering, we also manufacture drop forged and open-die forged eye hooks up to size no. 44 with capacities up to 500 tons. Meeting DIN 7540 standards, our eye hooks are ideal for use in applications that require a high degree of motion in the hook connection.



Cargo Hook



Cross Hook

SPECIALTY HOOKS

We also carry drop-forged cargo hooks and cross hooks.



Crank Shaft



Bracket



Crane Wheel

SPECIALTY PARTS

In addition to hooks, we have the capability to forge a variety of specialty parts for unique applications. Some of these products include:

- Crank shafts for heavy machinery
- Pull rods for vehicle manufacture and trains
- Un-machined parts for drives and heavy machinery
- Chain linking elements
- Coupling elements
- Running wheels for cranes and the mining industry
- Special flanges and bearing housings
- Lifting brackets for wind turbines

HOW TO ORDER HEAVY-DUTY CRANE HOOKS

1) SELECT THE TYPE OF HOOK YOU NEED

Choose from the following hook types:

- Single Hook
- Ramshorn (Double) Hook
- Ramshorn (Double) Form B Hook
- Eye Hook
- Cargo Hook
- Cross Hook

2) SELECT THE HOOK MATERIAL

Choose from the following materials:

- Carbon
- Super Alloy
- Extreme Alloy
- Bronze
- Stainless Steel

3) CHOOSE YOUR FINISHING OPTIONS

Hooks may be furnished as unmachined shank hooks, or we can machine and finish your hooks to meet your exact specifications.

Options include:

- Nut
- Suspension
- Extended Shaft
- Suspension with Rotating Lock
- Fork Head Suspension

Additional finishing options and specially-designed hooks are also available.

HEAVY-DUTY CRANE HOOKS

▶ DID YOU KNOW?

IDENTIFYING MARKINGS ON YOUR HEAVY-DUTY CRANE HOOK

The following markings are present on CM Heavy-Duty Crane Hooks to better identify, inspect & trace your hook.

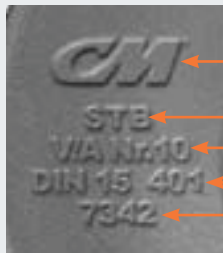

CM LOGO
Represents the brand of the hook

STB LOGO
Represents the CMCO's STB manufacturing facility in Hamm, Germany, where the product was forged

MATERIAL TYPE & SIZE
Material: V/A (Alloy), P/C (Carbon)
Hook Size: Nr. XX

DIN NUMBER
Represents the internationally-recognized German design standard that the product meets

TRACE CODE
Represents a number assigned to each product/batch manufactured, for easy traceability

For more information, visit us at www.cmworks.com

▶ **DID YOU KNOW?**

WHAT IS DIN?

DIN stands for “Deutsches Institut für Normung”, meaning “German Institute for Standardization”. Founded in 1917, DIN is the organization responsible for standardization in Germany and is the German ISO member body. Today, there are approximately 30,000 DIN standards covering nearly every field of technology, including crane hooks.

 For more information, visit us at www.cmworks.com

MATERIALS

To create a great product, you have to start with the best materials. To accomplish this, we’ve partnered with one of the leading steel suppliers in Europe to develop what we feel is the highest quality steel available. Our involvement in the earliest stages of our raw material development allows us to determine our material specifications, reducing variations in chemical makeup and helping to ensure consistency in the quality of the products we produce.

OUR PRODUCTS ARE AVAILABLE IN FIVE MATERIALS:

1. CARBON

- Design Factor 6:1
- Strength Class P
- Depending on size, we offer two grades of fine-grain carbon steel:

StE355N
(similar to ASTM A572 Grade 50)

StE420N
(similar to ASTM A255 Grade D)

2. SUPER ALLOY

- Design Factor 5:1
 - Strength Class V
 - Heat-treatable steel:
- 34CrNiMo6**
(similar to SAE/AISI 4340)

3. EXTREME ALLOY

Need a stronger material? Available upon request is our extreme alloy material with a minimum Charpy V-notch impact value of 42 joule at -40°C and a maximum value of 52 joule at -50°C.

- Design Factor 5:1
- Strength Class W (per EN 13001-3-5 standard)
- Heat-treatable steel

4. BRONZE

- Design Factor 6:1

5. STAINLESS STEEL

- Design Factor 6:1

All of our products are quenched and tempered. Our products are also pre-formed. This promotes grain flow, which provides strength and durability for products under high dynamic stress – like our heavy-duty crane hooks and specially machined parts.

ADVANTAGES

All of Columbus McKinnon’s heavy-duty crane hooks and specialty parts are made in house at our 82,000 square foot facility in Hamm, Germany.

With our own forging, machining and tool-making capabilities, we are able to turn pre-formed steel billets into finished, geometrically complex products quickly and efficiently while ensuring the highest levels of quality. For closed-die forgings, we rely on a hammer forge with pre-forming presses that give us flexibility in the forging process and allow for a shorter set-up time and running-in period. For larger hooks, we use state-of-the-art, open-die forging technology. We also use modular dies that reduce tool costs for smaller quantities of individually designed hooks.

For easy identification, we forge a traceability code along with STB and CM logos into every product.

CAPABILITIES

We manufacture many of our products through a combination of open-die forging and drop forging processes.

DROP FORGING

We primarily focus on drop-forging technologies for standard and geometrically complex parts due to the cost savings it provides for larger production runs.

We use drop forging to produce single hooks up to size no. 63 and 250 metric ton capacities, as well as ramshorn hooks up to size no. 125 and 500 metric ton capacities.

OPEN-DIE FORGING

Our open-die forging capabilities enable us to produce large, heavy-duty hooks that not only meet our customers’ unique requirements but DIN specifications as well. Our open-die forging capabilities allow us to manufacture hooks with any shaft length and is typically used for a single specialized product or products with small production runs.

We utilize modular dies that allow us to forge different hook shapes using the same die by simply changing the insert.

We use open-die forging to produce single hooks ranging in size from no. 80 to no. 400, and no. 160 to no. 400 for ramshorn hooks.

COMBINING CAPABILITIES

For forgings with longer shaft lengths, we frequently combine our drop forging and open-die forging capabilities to produce a single product. This allows us to produce geometrically complex engineered products with longer shaft lengths.

MACHINING CAPABILITIES

We can machine any type of hook suspension required, including cross heads and nuts.

IN-HOUSE TOOL SHOP

Our in-house tool shop gives us the ability to design and produce our own dies, allowing for quick turnaround of specialty forgings and custom products. We are also able to repair and replace parts on our existing dies without relying on an external supplier.

QUALITY

Quality is at the core of how we do business. Our manufacturing and production processes are designed with rigorous quality, testing and safety requirements to ensure we produce the highest-quality products for our customers.

Columbus McKinnon's STB manufacturing facility is ISO 9001:2008 certified by DNV. This means our customers can buy with confidence, knowing our products are consistently manufactured to the highest quality levels and our processes are regularly reviewed for improvement opportunities. All of our suppliers are ISO 9000 certified as well.

WE ARE APPROVED AS A SUPPLIER OF STEEL FORGINGS BY:

- Det Norske Veritas (DNV)
- American Bureau of Shipping (ABS)
- Germanischer Lloyd (GL)
- Lloyd's Register (LR)
- Bureau Veritas (BV)
- Richtlinie 97/23/E (TÜV Nord)
- Deutsche Bahn

OUR OTHER APPROVALS INCLUDE:

- Supplier of materials according to AD 2000 – Merkblatt W0 (TÜV Nord)
- Re-stamping (TÜV Nord)
- Supplier of pull rods and forging parts (German Railway)

QUALITY CERTIFICATES

The majority of our products come standard with a company Certificate 3.1 according to EN 10204, which includes:

- Description of the part
- Order confirmation number
- Material melt number
- Unique inspection number (if required)
- Result of mechanical properties test
- Parameter of heat treatment process
- Confirmation of magnetic particle test

For an additional cost, a Certificate 3.2 according to EN 10204 with external certification organizations (ABS, LR, DNV, BV) can be provided.

MARKETS SERVED

Whether you're lifting massive steel beams for large construction projects or loading shipping containers onto ocean barges, CM Heavy-Duty Crane Hooks are there. We serve global customers in a variety of markets, including:

- Crane Technology
- Mining
- Construction Equipment & Machinery
- Drive Systems
- Chemical, Power Plant & Utility Engineering
- Offshore Technology
- Plant Manufacturing
- Nuclear Technology
- Railway
- Engine Construction



SINGLE HOOKS (UNMACHINED) (PER DIN 15401)

SIZES AVAILABLE: SIZE NO. 1 TO 250
CAPACITIES: 1.6 TO 800 METRIC TON

Single Hook Heavy-Duty Crane Hooks are available as standard, un-machined shanks hooks and can be machined & finished to include a nut, suspension, extended shaft, suspension with rotating lock or fork head suspension. Other finishing options and specially-designed single hooks are also available.

MATERIAL OPTIONS

CARBON

- Strength Class P
- Design Factor 6:1
- Products up to size 63: fine-grain carbon steel StE355N (similar to ASTM A572 Grade 50)
- Products size 80 and up: fine-grain carbon steel StE420N (similar to ASTM A255 Grade D)

SUPER ALLOY

- Strength Class V
- Design Factor 5:1
- Heat-treatable steel 34CrNiMo6 (similar to SAE/AISI 4340)

EXTREME ALLOY

- Material with a minimum Charpy V-notch impact value of 42 joule at -40°C and a maximum value of 52 joule at -50°C is available upon request.
- Strength Class W (per EN 13001-3-5 standard)
- Design Factor 5:1
- Heat-treatable steel

BRONZE

- Design Factor 6:1

STAINLESS STEEL

- Design Factor 6:1



SINGLE HOOK
(Drop Forged, Un-Machined)

MACHINING AND FINISHING OPTIONS

		Single Hook Un-Machined	Single Hook Machined with Nut	Single Hook Suspension	Extended Shaft Single Hook (e.g. Motor-Driven Rotatable Hook Suspensions)	Single Hook Suspension with Rotating Lock	Fork Head Single Hook Suspension	Special Design Single Hooks
Sizes Available	Drop Forged	no. 1 to no. 63					–	Based on custom design Realization as drop or open-die forged parts Die real
	Open-Die Forged	no. 80 to no 250					no. 1 to no 250	
Hook Material Options		Carbon, Super Alloy, Extreme Alloy, Bronze, Stainless Steel						
Standard or Custom Design Product		Standard			Custom			

DIMENSIONS
SINGLE HOOK, UN-MACHINED SHANK

When ordering a CM Heavy-Duty Crane Hook, start with dimensions of the un-machined shank hook to find out what will meet your application requirements. From there, we can machine & finish the hook to your exact specifications. See the dimensions of the un-machined shank hooks below.

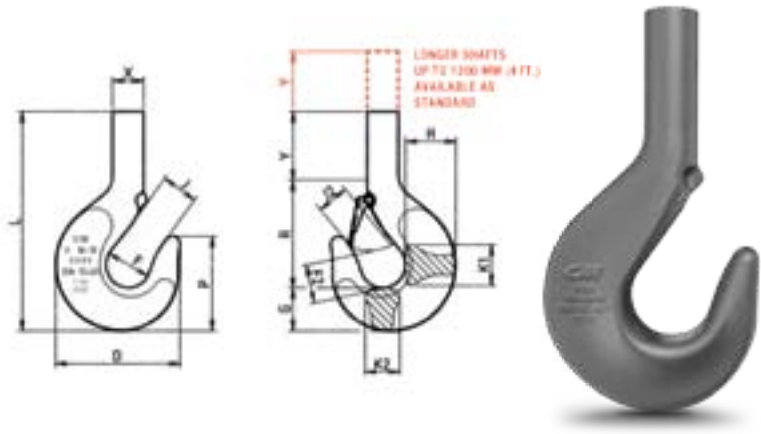

Size	Capacities* Metric Ton		Dimensions in. (mm)														Weight lbs. (kg) DIN	
	Carbon	Super Alloy	D	F	F2	G	H	J	J2	K1	L DIN	K2	P	R	X	Y**		
RSN 1	1.6	3.2	Std.	4.92 (125)	1.97 (50)	1.54 (39)	1.57 (40)	1.89 (48)	1.57 (40)	1.26 (32)	1.5 (38)	9.33 (237)	1.26 (32)	3.82 (97)	5.04 (128)	1.18 (30)	2.72 (69)	7.05 (3.2)
			Long	4.92 (125)	1.97 (50)	1.54 (39)	1.57 (40)	1.89 (48)	1.57 (40)	1.26 (32)	1.5 (38)	17.2 (437)	1.26 (32)	3.82 (97)	5.04 (128)	1.18 (30)	10.59 (269)	9.7 (4.4)
RSN 1.6	2.5	5	Std.	5.67 (144)	2.2 (56)	2.09 (53)	1.89 (48)	2.2 (56)	1.77 (45)	1.46 (37)	1.77 (45)	10.71 (272)	1.5 (38)	4.41 (112)	5.75 (146)	1.42 (36)	3.07 (78)	9.92 (4.5)
			Long	5.67 (144)	2.2 (56)	2.09 (53)	1.89 (48)	2.2 (56)	1.77 (45)	1.46 (37)	1.77 (45)	18.58 (472)	1.5 (38)	4.41 (112)	5.75 (146)	1.42 (36)	10.94 (278)	13.67 (6.2)
RSN 2.5	4	8	Std.	6.61 (168)	2.48 (63)	1.97 (50)	2.28 (58)	2.64 (67)	1.97 (50)	1.57 (40)	2.09 (53)	12.24 (311)	1.77 (45)	5.12 (130)	6.57 (167)	1.65 (42)	3.39 (86)	13.89 (6.3)
			Long	6.61 (168)	2.48 (63)	1.97 (50)	2.28 (58)	2.64 (67)	1.97 (50)	1.57 (40)	2.09 (53)	20.12 (511)	1.77 (45)	5.12 (130)	6.57 (167)	1.65 (42)	11.26 (286)	18.92 (8.6)
RSN 4	6.3	12.5	Std.	7.6 (193)	2.8 (71)	2.64 (67)	2.64 (67)	3.15 (80)	2.2 (56)	1.81 (46)	2.48 (63)	13.86 (352)	2.09 (53)	5.79 (147)	7.48 (190)	1.89 (48)	3.74 (95)	19.4 (8.8)
			Long	7.6 (193)	2.8 (71)	2.64 (67)	2.64 (67)	3.15 (80)	2.2 (56)	1.81 (46)	2.48 (63)	21.73 (552)	2.09 (53)	5.79 (147)	7.48 (190)	1.89 (48)	11.61 (295)	25.98 (11.8)
RSN 5	8	16	Std.	8.43 (214)	3.15 (80)	2.87 (73)	2.95 (75)	3.54 (90)	2.48 (63)	2.01 (51)	2.8 (71)	15.47 (393)	2.36 (60)	6.5 (165)	8.46 (215)	2.09 (53)	4.06 (103)	27.12 (12.3)
			Long	8.43 (214)	3.15 (80)	2.87 (73)	2.95 (75)	3.54 (90)	2.48 (63)	2.01 (51)	2.8 (71)	23.35 (593)	2.36 (60)	6.5 (165)	8.46 (215)	2.09 (53)	11.93 (303)	35.13 (15.9)
RSN 6	10	20	Std.	9.57 (243)	3.54 (90)	3.07 (78)	3.35 (85)	3.94 (100)	2.8 (71)	2.2 (56)	3.15 (80)	18.31 (465)	2.64 (67)	7.32 (186)	9.45 (240)	2.36 (60)	5.51 (140)	37.7 (17.1)
			Long	9.57 (243)	3.54 (90)	3.07 (78)	3.35 (85)	3.94 (100)	2.8 (71)	2.2 (56)	3.15 (80)	26.18 (665)	2.64 (67)	7.32 (186)	9.45 (240)	2.36 (60)	13.39 (340)	47.97 (21.8)
RSN 8	12.5	25	Std.	10.67 (271)	3.94 (100)	4.06 (103)	3.74 (95)	4.41 (112)	3.15 (80)	2.56 (65)	3.54 (90)	20.2 (513)	2.95 (75)	8.19 (208)	10.55 (268)	2.64 (67)	5.91 (150)	52.91 (24)
			Long	10.67 (271)	3.94 (100)	4.06 (103)	3.74 (95)	4.41 (112)	3.15 (80)	2.56 (65)	3.54 (90)	28.07 (713)	2.95 (75)	8.19 (208)	10.55 (268)	2.64 (67)	13.78 (350)	65.72 (29.8)
RSN 10	16	32	Std.	11.93 (303)	4.41 (112)	3.78 (96)	4.17 (106)	4.92 (125)	3.54 (90)	2.99 (76)	3.94 (100)	21.97 (558)	3.35 (85)	9.17 (233)	11.26 (286)	2.95 (75)	6.54 (166)	74.96 (34)
			Long	11.93 (303)	4.41 (112)	3.78 (96)	4.17 (106)	4.92 (125)	3.54 (90)	2.99 (76)	3.94 (100)	29.84 (758)	3.35 (85)	9.17 (233)	11.26 (286)	2.95 (75)	14.41 (366)	91.01 (41.3)
RSN 12	20	40	Std.	13.46 (342)	4.92 (125)	3.86 (98)	4.65 (118)	5.51 (140)	3.94 (100)	3.39 (86)	4.41 (112)	24.72 (628)	3.74 (95)	10.28 (261)	12.44 (316)	3.35 (85)	7.64 (194)	103.62 (47)
			Long	13.46 (342)	4.92 (125)	3.86 (98)	4.65 (118)	5.51 (140)	3.94 (100)	3.39 (86)	4.41 (112)	32.6 (828)	3.74 (95)	10.28 (261)	12.44 (316)	3.35 (85)	15.51 (394)	124.24 (56.4)
RSN 16	25	50	Std.	15.12 (384)	5.51 (140)	4.49 (114)	5.2 (132)	6.3 (160)	4.41 (112)	3.9 (99)	4.92 (125)	28.11 (714)	4.17 (106)	11.5 (292)	14.06 (357)	3.74 (95)	8.86 (225)	145.51 (66)
			Long	15.12 (384)	5.51 (140)	4.49 (114)	5.2 (132)	6.3 (160)	4.41 (112)	3.9 (99)	4.92 (125)	35.98 (914)	4.17 (106)	11.5 (292)	14.06 (357)	3.74 (95)	16.73 (425)	171.27 (77.7)
RSN 20	32	63	Std.	17.01 (432)	6.3 (160)	4.8 (122)	5.91 (150)	7.09 (180)	4.92 (125)	4.41 (112)	5.51 (140)	31.61 (803)	4.65 (118)	12.99 (330)	15.94 (405)	4.17 (106)	9.76 (248)	209 (95)
			Long	17.01 (432)	6.3 (160)	4.8 (122)	5.91 (150)	7.09 (180)	4.92 (125)	4.41 (112)	5.51 (140)	39.49 (1003)	4.65 (118)	12.99 (330)	15.94 (405)	4.17 (106)	17.64 (448)	242 (110)
RSN 25	40	80	Std.	19.13 (486)	7.09 (180)	5.98 (152)	6.69 (170)	7.87 (200)	5.51 (140)	4.92 (125)	6.3 (160)	35.2 (894)	5.2 (132)	14.65 (372)	17.91 (455)	4.65 (118)	10.59 (269)	300 (136)
			Long	19.13 (486)	7.09 (180)	5.98 (152)	6.69 (170)	7.87 (200)	5.51 (140)	4.92 (125)	6.3 (160)	43.07 (1094)	5.2 (132)	14.65 (372)	17.91 (455)	4.65 (118)	18.46 (469)	340 (154)
RSN 32	50	100	Std.	21.34 (542)	7.87 (200)	6.22 (158)	7.48 (190)	8.82 (224)	6.3 (160)	5.63 (143)	7.09 (180)	38.82 (986)	5.91 (150)	16.34 (415)	20.08 (510)	5.2 (132)	11.26 (286)	412 (187)
			Long	21.34 (542)	7.87 (200)	6.22 (158)	7.48 (190)	8.82 (224)	6.3 (160)	5.63 (143)	7.09 (180)	46.69 (1186)	5.91 (150)	16.34 (415)	20.08 (510)	5.2 (132)	19.13 (486)	462 (2010)
RSN 40	63	125	Std.	23.86 (606)	8.82 (224)	6.3 (160)	8.35 (212)	9.84 (250)	7.09 (180)	6.46 (164)	7.87 (200)	43.5 (1105)	6.69 (170)	18.27 (464)	22.32 (567)	5.91 (150)	12.83 (326)	582 (264)
			Long	23.86 (606)	8.82 (224)	6.3 (160)	8.35 (212)	9.84 (250)	7.09 (180)	6.46 (164)	7.87 (200)	51.38 (1305)	6.69 (170)	18.27 (464)	22.32 (567)	5.91 (150)	20.71 (526)	646 (293)
RSN 50	80	160	Std.	26.69 (678)	9.84 (250)	7.87 (200)	9.29 (236)	11.02 (280)	7.87 (200)	7.17 (182)	8.82 (224)	48.27 (1226)	7.48 (190)	20.51 (521)	25.00 (635)	6.69 (170)	13.98 (355)	948 (430)
			Long	26.69 (678)	9.84 (250)	7.87 (200)	9.29 (236)	11.02 (280)	7.87 (200)	7.17 (182)	8.82 (224)	56.14 (1426)	7.48 (190)	20.51 (521)	25.00 (635)	6.69 (170)	21.85 (555)	1030 (467)
RSN 63	100	200	Std.	30.04 (763)	11.02 (280)	8.27 (210)	10.43 (265)	12.4 (315)	8.82 (224)	8.15 (207)	9.84 (250)	54.53 (1385)	8.35 (212)	23.03 (585)	27.95 (710)	7.48 (190)	16.14 (410)	1323 (600)
			Long	30.04 (763)	11.02 (280)	8.27 (210)	10.43 (265)	12.4 (315)	8.82 (224)	8.15 (207)	9.84 (250)	62.4 (1585)	8.35 (212)	23.03 (585)	27.95 (710)	7.48 (190)	24.02 (610)	1426 (647)
RFN 80	125	250	Std.	33.86 (860)	12.4 (315)	10.2 (259)	11.81 (300)	13.98 (355)	9.84 (250)	9.21 (234)	11.02 (280)	61.81 (1570)	9.29 (236)	25.91 (658)	31.57 (802)	8.35 (212)	18.43 (468)	1896 (860)
			Long	33.86 (860)	12.4 (315)	10.2 (259)	11.81 (300)	13.98 (355)	9.84 (250)	9.21 (234)	11.02 (280)	69.69 (1770)	9.29 (236)	25.91 (658)	31.57 (802)	8.35 (212)	26.30 (668)	2024 (918)
RFN 100	160	320	Std.	38.03 (966)	13.98 (355)	10.63 (270)	13.19 (335)	15.75 (400)	11.02 (280)	10.31 (262)	12.4 (315)	68.9 (1750)	10.43 (265)	29.02 (737)	35.51 (902)	9.29 (236)	20.20 (513)	2690 (1220)
			Long	38.03 (966)	13.98 (355)	10.63 (270)	13.19 (335)	15.75 (400)	11.02 (280)	10.31 (262)	12.4 (315)	76.77 (1950)	10.43 (265)	29.02 (737)	35.51 (902)	9.29 (236)	28.07 (716)	2849 (1292)
RFN 125	200	400	Std.	42.48 (1079)	15.75 (400)	13.07 (332)	14.76 (375)	17.72 (450)	12.4 (315)	11.73 (298)	13.98 (355)	77.36 (1965)	11.81 (300)	32.48 (825)	40.16 (1020)	10.43 (265)	22.44 (570)	3836 (1740)
			Long	42.48 (1079)	15.75 (400)	13.07 (332)	14.76 (375)	17.72 (450)	12.4 (315)	11.73 (298)	13.98 (355)	85.24 (2165)	11.81 (300)	32.48 (825)	40.16 (1020)	10.43 (265)	30.31 (770)	4036 (1831)
RFN 160	250	500	Std.	47.8 (1214)	17.72 (450)	13.15 (334)	16.73 (425)	19.69 (500)	13.98 (355)	13.31 (338)	15.75 (400)	87.2 (2215)	13.19 (335)	36.61 (930)	45.08 (1145)	11.81 (300)	25.39 (645)	5467 (2480)
			Long	47.8 (1214)	17.72 (450)	13.15 (334)	16.73 (425)	19.69 (500)	13.98 (355)	13.31 (338)	15.75 (400)	95.08 (2415)	13.19 (335)	36.61 (930)	45.08 (1145)	11.81 (300)	33.27 (845)	5724 (2597)
RFN 200	320	630	Std.	53.5 (1359)	19.69 (500)	16.1 (409)	18.7 (475)	22.05 (560)	15.75 (400)	14.96 (380)	17.72 (450)	99.33 (2523)	14.76 (375)	40.94 (1040)	50.20 (1275)	13.19 (335)	30.43 (773)	7540 (3420)
			Long	53.5 (1359)	19.69 (500)	16.1 (409)	18.7 (475)	22.05 (560)	15.75 (400)	14.96 (380)	17.72 (450)	107.2 (2723)	14.76 (375)	40.94 (1040)	50.20 (1275)	13.19 (335)	38.31 (973)	7860 (3565)
RFN 250	400	800	Std.	60.04 (1525)	22.05 (560)	17.32 (440)	20.87 (530)	24.8 (630)	17.72 (450)	16.81 (427)	19.69 (500)	111.61 (2835)	16.73 (425)	45.87 (1165)	56.30 (1430)	14.76 (375)	34.45 (875)	10582 (4800)
			Long	60.04 (1525)	22.05 (560)	17.32 (440)	20.87 (530)	24.8 (630)	17.72 (450)	16.81 (427)	19.69 (500)	119.49 (3035)	16.73 (425)	45.87 (1165)	56.30 (1430)	14.76 (375)	42.32 (1075)	10984 (4982)

Also available as finished parts with threaded shank.
For lifting hook suspensions for bottom blocks, refer to DIN 15411. Suspensions consist of cross pieces according to DIN 15412, lifting hook nuts according to DIN 15413 and securing plates according to DIN 15414.
Forging tolerances according to DIN EN 10243-1-F.

* Capacities listed are per DIN 15400 drive group 2m (approximated to CMAA Specification No. 70, Service Class C). For capacities in different drive groups, please refer to DIN 15400.

** Extended length shanks up to 1200 mm are available upon request.

HEAVY-DUTY CRANE HOOKS

RAMSHORN HOOKS (UNMACHINED) (PER DIN 15402)

SIZES AVAILABLE: SIZE NO. 2.5 TO 400
CAPACITIES: 4 TO 1,250 METRIC TON

Ramshorn (Double) Heavy-Duty Crane Hooks are available as standard, un-machined shanks hooks and can be machined & finished to include a nut, suspension, extended shaft, suspension with rotating lock, fork head suspension or latches. Other finishing options are also available.

MATERIAL OPTIONS

CARBON

- Strength Class P
- Design Factor 6:1
- Products up to size 40: fine-grain carbon steel StE355N (similar to ASTM A572 Grade 50)
- Products size 50 and up: fine-grain carbon steel StE420N (similar to ASTM A255 Grade D)

SUPER ALLOY

- Strength Class V
- Design Factor 5:1
- Heat-treatable steel 34CrNiMo6 (similar to SAE/AISI 4340)

EXTREME ALLOY

- Material with a minimum Charpy V-notch impact value of 42 joule at -40°C and a maximum value of 52 joule at -50°C is available upon request.
- Strength Class W (per EN 13001-3-5 standard)
- Design Factor 5:1
- Heat-treatable steel

BRONZE

- Design Factor 6:1

STAINLESS STEEL

- Design Factor 6:1



RAMSHORN HOOK
(Drop Forged, Un-Machined)

MACHINING AND FINISHING OPTIONS

		Ramshorn Hook Un-Machined	Ramshorn Hook Machined with Nut	Ramshorn Hook Suspension	Extended Shaft Ramshorn Hook e.g. Motor-Driven Rotatable Hook Suspensions	Ramshorn Hook with Eye Suspension	Fork Head Ramshorn Hook Suspension
Sizes Available	Drop Forged	no. 2.5 to no. 80				-	
	Open-Die Forged	no. 100 to no. 420				no. 2.5 to no. 420	
Hook Material Options		Carbon, Super Alloy, Extreme Alloy, Bronze, Stainless Steel					
Standard or Custom Design Product		Standard			Custom		

DIMENSIONS
RAMSHORN HOOK, UN-MACHINED SHANK

When ordering a CM Heavy-Duty Crane Hook, start with dimensions of the un-machined shank hook to find out what will meet your application requirements. From there, we can machine & finish the hook to your exact specifications. See the dimensions of the un-machined shank hooks below.

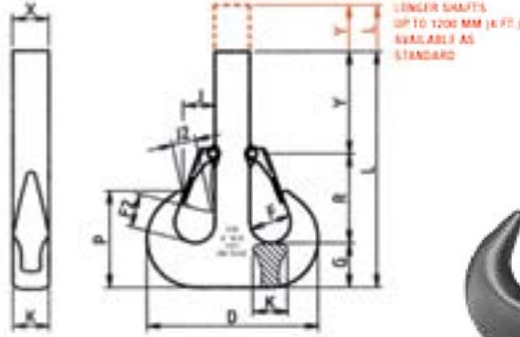

Size	Capacities* Metric Ton		Dimensions in. (mm)													Weight lbs. (kg) DIN
	Carbon	Super Alloy	D	F	F2	G	J	J2	K	L	P	R	X	Y**		
RSN 2.5	4	8	Std.	8.19 (208)	1.97 (50)	1.65 (42)	1.97 (50)	1.57 (40)	1.26 (32)	1.57 (40)	11.81 (300)	4.53 (115)	4.41 (112)	1.65 (42)	5.43 (138)	15.21 (6.9)
			Long	8.19 (208)	1.97 (50)	1.65 (42)	1.97 (50)	1.57 (40)	1.26 (32)	1.57 (40)	19.69 (500)	4.53 (115)	4.41 (112)	1.65 (42)	13.31 (338)	20.06 (9.1)
RSN 4	6.3	12.5	Std.	9.37 (238)	2.2 (56)	1.77 (45)	2.36 (60)	1.77 (45)	1.38 (35)	1.89 (48)	13.39 (340)	5.24 (133)	4.88 (124)	1.89 (48)	6.14 (156)	21.38 (9.7)
			Long	9.37 (238)	2.2 (56)	1.77 (45)	2.36 (60)	1.77 (45)	1.38 (35)	1.89 (48)	21.26 (540)	5.24 (133)	4.88 (124)	1.89 (48)	14.02 (356)	27.56 (12.5)
RSN 5	8	16	Std.	10.47 (266)	2.48 (63)	2.36 (60)	2.64 (67)	1.97 (50)	1.61 (41)	2.09 (53)	14.92 (379)	5.87 (149)	5.63 (143)	2.09 (53)	6.65 (169)	29.54 (13.4)
			Long	10.47 (266)	2.48 (63)	2.36 (60)	2.64 (67)	1.97 (50)	1.61 (41)	2.09 (53)	22.8 (579)	5.87 (149)	5.63 (143)	2.09 (53)	14.53 (369)	37.26 (16.9)
RSN 6	10	20	Std.	11.85 (301)	2.8 (71)	2.64 (67)	2.95 (75)	2.2 (56)	1.77 (45)	2.36 (60)	17.72 (450)	6.57 (167)	6.3 (160)	2.36 (60)	8.46 (215)	37.04 (16.8)
			Long	11.85 (301)	2.8 (71)	2.64 (67)	2.95 (75)	2.2 (56)	1.77 (45)	2.36 (60)	25.59 (650)	6.57 (167)	6.3 (160)	2.36 (60)	16.34 (415)	46.74 (21.2)
RSN 8	12.5	25	Std.	13.27 (337)	3.15 (80)	2.87 (73)	3.35 (85)	2.48 (63)	1.93 (49)	2.64 (67)	19.69 (500)	7.4 (188)	7.17 (182)	2.64 (67)	9.17 (233)	55.78 (25.3)
			Long	13.27 (337)	3.15 (80)	2.87 (73)	3.35 (85)	2.48 (63)	1.93 (49)	2.64 (67)	27.56 (700)	7.4 (188)	7.17 (182)	2.64 (67)	17.05 (433)	67.9 (30.8)
RSN 10	16	32	Std.	14.84 (377)	3.54 (90)	3.31 (84)	3.74 (95)	2.8 (71)	2.2 (56)	2.95 (75)	21.46 (545)	8.31 (211)	7.56 (192)	2.95 (75)	10.16 (258)	78.26 (35.5)
			Long	14.84 (377)	3.54 (90)	3.31 (84)	3.74 (95)	2.8 (71)	2.2 (56)	2.95 (75)	29.33 (745)	8.31 (211)	7.56 (192)	2.95 (75)	18.03 (458)	93.48 (42.4)
RSN 12	20	40	Std.	16.57 (421)	3.94 (100)	3.46 (88)	4.17 (106)	3.15 (80)	2.4 (61)	3.35 (85)	24.25 (616)	9.29 (236)	8.27 (210)	3.35 (85)	11.81 (300)	109.13 (49.5)
			Long	16.57 (421)	3.94 (100)	3.46 (88)	4.17 (106)	3.15 (80)	2.4 (61)	3.35 (85)	32.13 (816)	9.29 (236)	8.27 (210)	3.35 (85)	19.69 (500)	128.75 (58.4)
RSN 16	25	50	Std.	18.54 (471)	4.41 (112)	3.39 (86)	4.65 (118)	3.54 (90)	2.72 (69)	3.74 (95)	27.48 (698)	10.39 (264)	9.33 (237)	3.74 (95)	13.5 (343)	154 (69.7)
			Long	18.54 (471)	4.41 (112)	3.39 (86)	4.65 (118)	3.54 (90)	2.72 (69)	3.74 (95)	35.35 (898)	10.39 (264)	9.33 (237)	3.74 (95)	21.38 (543)	178 (80.8)
RSN 20	32	63	Std.	20.91 (531)	4.92 (125)	4.02 (102)	5.2 (132)	3.94 (100)	3.11 (79)	4.17 (106)	30.79 (782)	11.61 (295)	10.43 (265)	4.17 (106)	15.16 (385)	215 (97.5)
			Long	20.91 (531)	4.92 (125)	4.02 (102)	5.2 (132)	3.94 (100)	3.11 (79)	4.17 (106)	38.66 (982)	11.61 (295)	10.43 (265)	4.17 (106)	23.03 (585)	246 (111.4)
RSN 25	40	80	Std.	23.54 (598)	5.51 (140)	4.33 (110)	5.91 (150)	4.41 (112)	3.43 (87)	4.65 (118)	34.06 (865)	13.07 (332)	12.4 (315)	4.65 (118)	15.75 (400)	298 (135)
			Long	23.54 (598)	5.51 (140)	4.33 (110)	5.91 (150)	4.41 (112)	3.43 (87)	4.65 (118)	41.93 (1065)	13.07 (332)	12.4 (315)	4.65 (118)	23.62 (600)	336 (152.2)
RSN 32	50	100	Std.	26.46 (672)	6.3 (160)	5.2 (132)	6.69 (170)	4.92 (125)	3.94 (100)	5.2 (132)	37.8 (960)	14.76 (375)	13.19 (335)	5.2 (132)	17.91 (455)	425 (193)
			Long	26.46 (672)	6.3 (160)	5.2 (132)	6.69 (170)	4.92 (125)	3.94 (100)	5.2 (132)	45.67 (1160)	14.76 (375)	13.19 (335)	5.2 (132)	25.79 (655)	473 (214.5)
RSN 40	63	125	Std.	29.69 (754)	7.09 (180)	5.43 (138)	7.48 (190)	5.51 (140)	4.41 (112)	5.91 (150)	42.32 (1075)	16.54 (420)	14.76 (375)	5.91 (150)	20.08 (510)	617 (280)
			Long	29.69 (754)	7.09 (180)	5.43 (138)	7.48 (190)	5.51 (140)	4.41 (112)	5.91 (150)	50.2 (1275)	16.54 (420)	14.76 (375)	5.91 (150)	27.95 (510)	678 (307.7)
RSN 50	80	160	Std.	33.15 (842)	7.87 (200)	7.24 (184)	8.35 (212)	6.3 (160)	5.28 (134)	6.69 (170)	46.34 (1177)	18.58 (472)	16.54 (420)	6.69 (170)	21.46 (545)	829 (376)
			Long	33.15 (842)	7.87 (200)	7.24 (184)	8.35 (212)	6.3 (160)	5.28 (134)	6.69 (170)	54.21 (1377)	18.58 (472)	16.54 (420)	6.69 (170)	29.33 (745)	907 (411.6)
RSN 63	100	200	Std.	37.17 (944)	8.82 (224)	7.13 (181)	9.29 (236)	7.09 (180)	5.91 (150)	7.48 (190)	52.2 (1326)	20.79 (528)	18.11 (460)	7.48 (190)	24.8 (630)	1250 (567)
			Long	37.17 (944)	8.82 (224)	7.13 (181)	9.29 (236)	7.09 (180)	5.91 (150)	7.48 (190)	60.08 (1526)	20.79 (528)	18.11 (460)	7.48 (190)	32.68 (830)	1348 (611.5)
RSN 80	125	250	Std.	41.81 (1062)	9.84 (250)	7.2 (183)	10.43 (265)	7.87 (200)	6.65 (169)	8.35 (212)	59.06 (1500)	23.23 (590)	20.28 (515)	8.35 (212)	28.35 (720)	1673 (759)
			Long	41.81 (1062)	9.84 (250)	7.2 (183)	10.43 (265)	7.87 (200)	6.65 (169)	8.35 (212)	66.93 (1700)	23.23 (590)	20.28 (515)	8.35 (212)	36.22 (920)	1795 (814.4)
RSN 100	160	320	Std.	46.69 (1186)	11.02 (280)	9.65 (245)	11.81 (300)	8.82 (224)	7.68 (195)	9.29 (236)	65.94 (1675)	26.14 (664)	22.64 (575)	9.29 (236)	31.5 (800)	2337 (1060)
			Long	46.69 (1186)	11.02 (280)	9.65 (245)	11.81 (300)	8.82 (224)	7.68 (195)	9.29 (236)	73.82 (1875)	26.14 (664)	22.64 (575)	9.29 (236)	39.37 (1000)	2488 (1128.7)
RFN 125	200	400	Std.	52.36 (1330)	12.4 (315)	9.33 (237)	13.19 (335)	9.84 (250)	8.46 (215)	10.43 (265)	74.21 (1885)	29.25 (743)	25.39 (645)	10.43 (265)	35.63 (905)	3287 (1491)
			Long	52.36 (1330)	12.4 (315)	9.33 (237)	13.19 (335)	9.84 (250)	8.46 (215)	10.43 (265)	82.09 (2085)	29.25 (743)	25.39 (645)	10.43 (265)	43.5 (1105)	3478 (1577.6)
RFN 160	250	500	Std.	59.25 (1505)	13.98 (355)	9.65 (245)	14.76 (375)	11.02 (280)	9.57 (243)	11.81 (300)	83.46 (2120)	32.8 (833)	28.54 (725)	11.81 (300)	40.16 (1020)	4663 (2115)
			Long	59.25 (1505)	13.98 (355)	9.65 (245)	14.76 (375)	11.02 (280)	9.57 (243)	11.81 (300)	91.34 (2320)	32.8 (833)	28.54 (725)	11.81 (300)	48.03 (1220)	4907 (2226)
RFN 200	320	630	Std.	66.34 (1685)	15.75 (400)	12.72 (323)	16.73 (425)	12.4 (315)	10.94 (278)	13.19 (335)	95.39 (2423)	37.01 (940)	31.5 (800)	13.19 (335)	47.17 (1198)	6647 (3015)
			Long	66.34 (1685)	15.75 (400)	12.72 (323)	16.73 (425)	12.4 (315)	10.94 (278)	13.19 (335)	103.27 (2623)	37.01 (940)	31.5 (800)	13.19 (335)	55.04 (1398)	6952 (3153.4)
RFN 250	400	800	Std.	74.21 (1885)	17.72 (450)	13.9 (353)	18.7 (475)	13.98 (355)	12.44 (316)	14.76 (375)	107.28 (2725)	41.54 (1055)	34.45 (875)	14.76 (375)	54.13 (1375)	9409 (4268)
			Long	74.21 (1885)	17.72 (450)	13.9 (353)	18.7 (475)	13.98 (355)	12.44 (316)	14.76 (375)	115.16 (2925)	41.54 (1055)	34.45 (875)	14.76 (375)	62.01 (1575)	9792 (4441.4)
RFN 320	500	1000	Std.	83.66 (2125)	19.69 (500)	15.16 (385)	20.87 (530)	15.75 (400)	14.21 (361)	16.73 (425)	121.26 (3080)	46.46 (1180)	37.4 (950)	16.73 (425)	62.99 (1600)	14231 (6455)
			Long	83.66 (2125)	19.69 (500)	15.16 (385)	20.87 (530)	15.75 (400)	14.21 (361)	16.73 (425)	129.13 (3280)	46.46 (1180)	37.4 (950)	16.73 (425)	70.87 (1800)	14722 (6677.7)
RFN 400	630	1250	Std.	93.5 (2375)	22.05 (560)	17.13 (435)	23.62 (600)	17.72 (450)	16.06 (408)	18.7 (475)	137.6 (3495)	52.36 (1330)	41.14 (1045)	18.7 (475)	72.83 (1850)	17857 (8100)
			Long	93.5 (2375)	22.05 (560)	17.13 (435)	23.62 (600)	17.72 (450)	16.06 (408)	18.7 (475)	145.47 (3695)	52.36 (1330)	41.14 (1045)	18.7 (475)	80.71 (2050)	18471 (8378.2)

HEAVY-DUTY
CRANE HOOKS

Also available as finished parts with threaded shank.
For lifting hook suspensions for bottom blocks, refer to DIN 15411. Suspensions consist of cross pieces according to DIN 15412, lifting hook nuts according to DIN 15413 and securing plates according to DIN 15414.
Forging tolerances according to DIN EN 10243-1-F.

* Capacities listed are per DIN 15400 drive group 2m (approximated to CMAA Specification No. 70, Service Class C). For capacities in different drive groups, please refer to DIN 15400.

** Extended length shanks up to 1200 mm are available upon request.

RAMSHORN FORM B HOOKS (UNMACHINED) WITH SHACKLE CONNECTION (PER DIN 15402 B)

SIZES AVAILABLE: SIZE NO. 8 TO 400
CAPACITIES: 12.5 TO 1,250 METRIC TON

Ramshorn (Double) Form B Heavy-Duty Crane Hooks feature a shackle connection point for increased rigging flexibility. They are available as standard, un-machined shanks hooks and can be machined & finished to include a nut, suspension, extended shaft, suspension with rotating lock, fork head suspension or latches. Other finishing options are also available.

MATERIAL OPTIONS

CARBON

- Strength Class P
- Design Factor 6:1
- Products up to size 40: fine-grain carbon steel StE355N (similar to ASTM A572 Grade 50)
- Products size 50 and up: fine-grain carbon steel StE420N (similar to ASTM A255 Grade D)

SUPER ALLOY

- Strength Class V
- Design Factor 5:1
- Heat-treatable steel 34CrNiMo6 (similar to SAE/AISI 4340)

EXTREME ALLOY

- Material with a minimum Charpy V-notch impact value of 42 joule at -40°C and a maximum value of 52 joule at -50°C is available upon request.
- Strength Class W (per EN 13001-3-5 standard)
- Design Factor 5:1
- Heat-treatable steel

BRONZE

- Design Factor 6:1

STAINLESS STEEL

- Design Factor 6:1

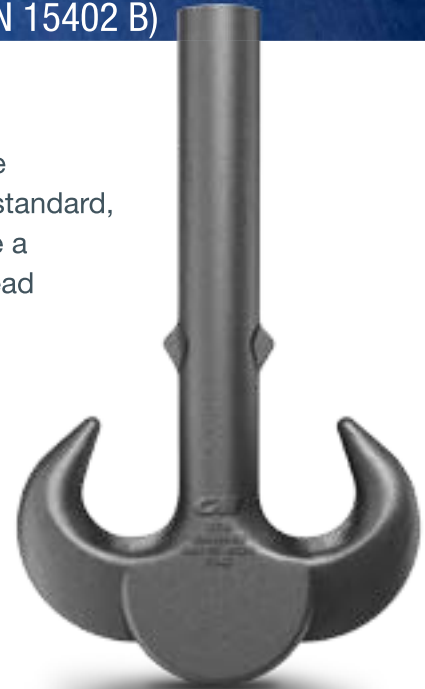

RAMSHORN FORM B HOOK
(Drop Forged, Un-Machined)



RAMSHORN FORM B
(Drop Forged, Machined with Crosshead, Nut and Latches)



RAMSHORN FORM B
(Open Die Forged, Machined with Nut and Latches)

Shackle Connection Point

MACHINING AND FINISHING OPTIONS

	Ramshorn Form B Hook Un-Machined	Ramshorn Form B Hook Machined with Nut	Ramshorn Form B Hook Suspension	Extended Shaft Ramshorn Form B Hook e.g. Motor-Driven Rotatable Hook Suspensions	Ramshorn Form B Hook with Eye Suspension	Fork Head Ramshorn Form B Hook Suspension
Drop Forged Sizes Available		no. 2.5 to no. 80				-
Open-Die Forged Sizes Available		no. 100 to no. 420				no. 2.5 to no. 420
Hook Material Options	Carbon, Super Alloy, Extreme Alloy, Bronze, Stainless Steel					
Standard or Custom Design Product	Standard			Custom		



DIMENSIONS
RAMSHORN FORM B HOOK, UN-MACHINED SHANK

When ordering a CM Heavy-Duty Crane Hook, start with dimensions of the un-machined shank hook to find out what will meet your application requirements. From there, we can machine & finish the hook to your exact specifications. See the dimensions of the un-machined shank hooks below.

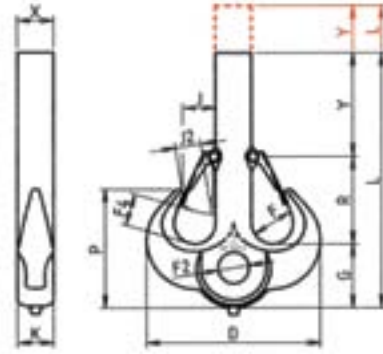

Size	Capacities* Metric Ton		Dimensions in. (mm)														Weight lbs. (kg)
	Carbon	Super Alloy	D	F	F2	F4	G	J	J2	K	L	P	R	X	Y**		
RFN 8	12.5	25	Standard	13.27 (337)	3.15 (80)	2.91 (74)	2.87 (73)	4.72 (120)	2.48 (63)	1.93 (49)	2.64 (67)	21.06 (535)	8.78 (223)	7.17 (182)	2.64 (67)	9.17 (233)	66.14 (30)
			Long	13.27 (337)	3.15 (80)	2.91 (74)	2.87 (73)	4.72 (120)	2.48 (63)	1.93 (49)	2.64 (67)	28.94 (735)	8.78 (223)	7.17 (182)	2.64 (67)	17.05 (433)	78.26 (35.5)
RFN 10	16	32	Standard	14.84 (377)	3.54 (90)	2.91 (74)	3.31 (84)	5.12 (130)	2.8 (71)	2.2 (56)	2.95 (75)	22.83 (580)	9.69 (246)	7.56 (192)	2.95 (75)	10.16 (258)	90.39 (41)
			Long	14.84 (377)	3.54 (90)	2.91 (74)	3.31 (84)	5.12 (130)	2.8 (71)	2.2 (56)	2.95 (75)	30.71 (780)	9.69 (246)	7.56 (192)	2.95 (75)	18.03 (458)	105.6 (47.9)
RSN 12	20	40	Standard	16.57 (421)	3.94 (100)	3.07 (78)	3.46 (88)	5.91 (150)	3.15 (80)	2.4 (61)	3.35 (85)	25.98 (660)	11.02 (280)	8.27 (210)	3.35 (85)	11.81 (300)	125.66 (57)
			Long	16.57 (421)	3.94 (100)	3.07 (78)	3.46 (88)	5.91 (150)	3.15 (80)	2.4 (61)	3.35 (85)	33.86 (860)	11.02 (280)	8.27 (210)	3.35 (85)	19.69 (500)	145.28 (65.9)
RSN 16	25	50	Standard	18.54 (471)	4.41 (112)	3.39 (86)	3.39 (86)	6.69 (170)	3.54 (90)	2.72 (69)	3.74 (95)	29.53 (750)	12.44 (316)	9.33 (237)	3.74 (95)	13.5 (343)	171.96 (78)
			Long	18.54 (471)	4.41 (112)	3.39 (86)	3.39 (86)	6.69 (170)	3.54 (90)	2.72 (69)	3.74 (95)	37.4 (950)	12.44 (316)	9.33 (237)	3.74 (95)	21.38 (543)	196.43 (89.1)
RSN 20	32	63	Standard	20.91 (531)	4.92 (125)	3.78 (96)	4.02 (102)	7.48 (190)	3.94 (100)	3.11 (79)	4.17 (106)	33.07 (840)	13.9 (353)	10.43 (265)	4.17 (106)	15.16 (385)	242.51 (110)
			Long	20.91 (531)	4.92 (125)	3.78 (96)	4.02 (102)	7.48 (190)	3.94 (100)	3.11 (79)	4.17 (106)	40.94 (1040)	13.9 (353)	10.43 (265)	4.17 (106)	23.03 (585)	273.15 (123.9)
RSN 25	40	80	Standard	23.54 (598)	5.51 (140)	4.17 (106)	4.33 (110)	8.35 (212)	4.41 (112)	3.43 (87)	4.65 (118)	36.5 (927)	15.51 (394)	12.4 (315)	4.65 (118)	15.75 (400)	335.1 (152)
			Long	23.54 (598)	5.51 (140)	4.17 (106)	4.33 (110)	8.35 (212)	4.41 (112)	3.43 (87)	4.65 (118)	44.37 (1127)	15.51 (394)	12.4 (315)	4.65 (118)	23.62 (600)	373.02 (169.2)
RSN 32	50	100	Standard	26.46 (672)	6.3 (160)	4.57 (116)	5.2 (132)	9.29 (236)	4.92 (125)	3.94 (100)	5.2 (132)	40.39 (1026)	17.36 (441)	13.19 (335)	5.2 (132)	17.91 (455)	462.97 (210)
			Long	26.46 (672)	6.3 (160)	4.57 (116)	5.2 (132)	9.29 (236)	4.92 (125)	3.94 (100)	5.2 (132)	48.27 (1226)	17.36 (441)	13.19 (335)	5.2 (132)	25.79 (655)	510.37 (231.5)
RSN 40	63	125	Standard	29.69 (754)	7.09 (180)	5.16 (131)	5.43 (138)	10.43 (265)	5.51 (140)	4.41 (112)	5.91 (150)	45.28 (1150)	19.49 (495)	14.76 (375)	5.91 (150)	20.08 (510)	632.73 (287)
			Long	29.69 (754)	7.09 (180)	5.16 (131)	5.43 (138)	10.43 (265)	5.51 (140)	4.41 (112)	5.91 (150)	53.15 (1350)	19.49 (495)	14.76 (375)	5.91 (150)	27.95 (710)	693.79 (314.7)
RSN 50	80	160	Standard	33.15 (842)	7.87 (200)	5.75 (146)	7.24 (184)	11.81 (300)	6.3 (160)	5.28 (134)	6.69 (170)	49.8 (1265)	22.05 (560)	16.54 (420)	6.69 (170)	21.46 (545)	952.4 (432)
			Long	33.15 (842)	7.87 (200)	5.75 (146)	7.24 (184)	11.81 (300)	6.3 (160)	5.28 (134)	6.69 (170)	57.68 (1465)	22.05 (560)	16.54 (420)	6.69 (170)	29.33 (740)	1030.88 (467.6)
RSN 63	100	200	Standard	37.17 (944)	8.82 (224)	6.61 (168)	7.13 (181)	13.19 (335)	7.09 (180)	5.91 (150)	7.48 (190)	56.1 (1425)	24.69 (627)	18.11 (460)	7.48 (190)	24.8 (630)	1402.14 (636)
			Long	37.17 (944)	8.82 (224)	6.61 (168)	7.13 (181)	13.19 (335)	7.09 (180)	5.91 (150)	7.48 (190)	63.98 (1625)	24.69 (627)	18.11 (460)	7.48 (190)	32.68 (830)	1500.25 (680.5)
RSN 80	125	250	Standard	41.81 (1062)	9.84 (250)	7.4 (188)	7.2 (183)	14.76 (375)	7.87 (200)	6.65 (169)	8.35 (212)	63.39 (1610)	27.56 (700)	20.28 (515)	8.35 (212)	28.35 (720)	2015.03 (914)
			Long	41.81 (1062)	9.84 (250)	7.4 (188)	7.2 (183)	14.76 (375)	7.87 (200)	6.65 (169)	8.35 (212)	71.26 (1810)	27.56 (700)	20.28 (515)	8.35 (212)	36.22 (920)	2137.16 (969.4)
RSN 100	160	320	Standard	46.69 (1186)	11.02 (280)	8.19 (208)	9.65 (245)	16.73 (425)	8.82 (224)	7.68 (195)	9.29 (236)	70.87 (1800)	31.06 (789)	22.64 (575)	9.29 (236)	31.5 (800)	2777.82 (1260)
			Long	46.69 (1186)	11.02 (280)	8.19 (208)	9.65 (245)	16.73 (425)	8.82 (224)	7.68 (195)	9.29 (236)	78.74 (2000)	31.06 (789)	22.64 (575)	9.29 (236)	39.37 (1000)	2929.28 (1328.7)
RFN 125	200	400	Standard	52.36 (1330)	12.4 (315)	9.25 (235)	9.33 (237)	18.7 (475)	9.84 (250)	8.46 (215)	10.43 (265)	79.72 (2025)	34.76 (883)	25.39 (645)	10.43 (265)	35.63 (905)	3873.52 (1757)
			Long	52.36 (1330)	12.4 (315)	9.25 (235)	9.33 (237)	18.7 (475)	9.84 (250)	8.46 (215)	10.43 (265)	87.6 (2225)	34.76 (883)	25.39 (645)	10.43 (265)	43.5 (1105)	4064.44 (1843.6)
RFN 160	250	500	Standard	59.25 (1505)	13.98 (355)	10.24 (260)	9.65 (245)	20.87 (530)	11.02 (280)	9.57 (243)	11.81 (300)	89.57 (2275)	38.9 (988)	28.54 (725)	11.81 (300)	40.16 (1020)	5511.56 (2500)
			Long	59.25 (1505)	13.98 (355)	10.24 (260)	9.65 (245)	20.87 (530)	11.02 (280)	9.57 (243)	11.81 (300)	97.44 (2475)	38.9 (988)	28.54 (725)	11.81 (300)	48.03 (1220)	5756.27 (2611)
RFN 200	320	630	Standard	66.34 (1685)	15.75 (400)	11.1 (282)	12.72 (323)	23.62 (600)	12.4 (315)	10.94 (278)	13.19 (335)	102.28 (2598)	43.9 (1115)	31.5 (800)	13.19 (335)	47.17 (1198)	7848.46 (3560)
			Long	66.34 (1685)	15.75 (400)	11.1 (282)	12.72 (323)	23.62 (600)	12.4 (315)	10.94 (278)	13.19 (335)	110.16 (2798)	43.9 (1115)	31.5 (800)	13.19 (335)	55.04 (1398)	8153.58 (3698.4)
RFN 250	400	800	Standard	74.21 (1885)	17.72 (450)	12.28 (312)	13.9 (353)	26.38 (670)	13.98 (355)	12.44 (316)	14.76 (375)	114.96 (2920)	49.21 (1250)	34.45 (875)	14.76 (375)	54.13 (1375)	11095.87 (5039)
			Long	74.21 (1885)	17.72 (450)	12.28 (312)	13.9 (353)	26.38 (670)	13.98 (355)	12.44 (316)	14.76 (375)	122.83 (3120)	49.21 (1250)	34.45 (875)	14.76 (375)	62.01 (1575)	11478.15 (5206.4)
RFN 320	500	1000	Standard	83.66 (2125)	19.69 (500)	13.86 (352)	15.16 (385)	29.53 (750)	15.75 (400)	14.21 (361)	16.73 (425)	129.92 (3300)	51.77 (1315)	37.4 (950)	16.73 (425)	62.99 (1600)	14837.11 (6730)
			Long	83.66 (2125)	19.69 (500)	13.86 (352)	15.16 (385)	29.53 (750)	15.75 (400)	14.21 (361)	16.73 (425)	137.8 (3500)	51.77 (1315)	37.4 (950)	16.73 (425)	70.87 (1800)	15328.08 (6952.7)
RFN 400	630	1250	Standard	93.5 (2375)	22.05 (560)	15.63 (397)	17.13 (435)	33.46 (850)	17.72 (450)	16.06 (408)	18.7 (475)	147.44 (3745)	58.46 (1485)	41.14 (1045)	18.7 (475)	72.83 (1850)	21109.26 (9575)
			Long	93.5 (2375)	22.05 (560)	15.63 (397)	17.13 (435)	33.46 (850)	17.72 (450)	16.06 (408)	18.7 (475)	155.31 (3945)	58.46 (1485)	41.14 (1045)	18.7 (475)	80.71 (2050)	21722.59 (9853.2)

Also available as finished parts with threaded shank.
For lifting hook suspensions for bottom blocks refer to DIN 15411. Suspensions consist of cross pieces according to DIN 15412, lifting hook nuts according to DIN 15413 and securing plates according to DIN 15414.
Forging tolerances according to DIN EN 10243-1-F.

* Capacities listed are per DIN 15400 drive group 2m (approximated to CMAA Specification No. 70, Service Class C). For capacities in different drive groups, please refer to DIN 15400

** Extended length shanks up to 1200 mm are available upon request.

EYE HOOKS (PER DIN 15402)

SIZES AVAILABLE: SIZE NO. 25 TO 43
CAPACITIES: 3.2 TO 440 METRIC TON

Heavy-Duty Crane Eye Hooks are available in capacities from 3.2 to 400 metric ton. These hooks are furnished as complete units, with latches being optional.

MATERIAL OPTIONS

CARBON

- Strength Class P
- Design Factor 4:1
- Products up to size 40: fine-grain carbon steel StE355N (similar to ASTM A572 Grade 50)
- Products size 41 and up: fine-grain carbon steel StE420N (similar to ASTM A255 Grade D)

SUPER ALLOY

- Strength Class V
- Design Factor 4:1
- Heat-treatable steel
- 34CrNiMo6 (similar to SAE/AISI 4340)

EXTREME ALLOY

- Material with a minimum Charpy V-notch impact value of 42 joule at -40°C and a maximum value of 52 joule at -50°C is available upon request.
- Strength Class W (per EN 13001-3-5 standard)
- Design Factor 4:1
- Heat-treatable steel

BRONZE

- Design Factor 4:1

STAINLESS STEEL

- Design Factor 4:1



EYE HOOK
(Drop Forged with Latch)

MACHINING AND FINISHING OPTIONS

	Eye Hooks (Complete)
	
Drop Forged Sizes Available	27 to 39
Open-Die Forged Sizes Available	40 to 44
Other	Grade 5 (Carbon), Grade 8 (Super Alloy) and Grade 10 (G100 with Extreme Alloy)
Finishing Options	Available with or without latch



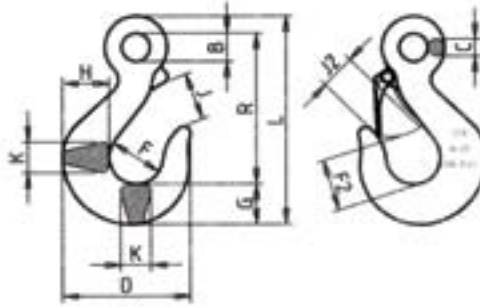

DIMENSIONS
EYE HOOK

Size	Capacities* Metric Ton		Dimensions in. (mm)												Weight lbs. (kg)
	Carbon	Super Alloy	D	F	F2	G	H	J	J2	K	L	R	B	C	
25	3.53 (3.2)	5.51 (5)	4.61 (117)	1.97 (50)	1.69 (43)	1.44 (36.5)	1.67 (42.5)	1.65 (42)	1.22 (31)	1.1 (28)	7.52 (191)	5.43 (138)	1.02 (26)	0.63 (16)	3.1 (1.4)
27	5.51 (5)	8.82 (8)	5.83 (148)	2.44 (62)	2.36 (60)	1.81 (46)	2.11 (53.5)	2.01 (51)	1.57 (40)	1.38 (35)	9.49 (241)	6.85 (174)	1.26 (32)	0.79 (20)	5.7 (2.6)
28	6.94 (6.3)	11.02 (10)	6.42 (163)	2.76 (70)	2.48 (63)	2.05 (52)	2.36 (60)	2.28 (58)	1.69 (43)	1.57 (40)	10.43 (265)	7.48 (190)	1.42 (36)	0.89 (22.5)	8.6 (3.9)
29	8.82 (8)	13.78 (12.5)	7.36 (187)	3.11 (79)	2.95 (75)	2.28 (58)	2.66 (67.5)	2.6 (66)	2.01 (51)	1.75 (44.5)	11.93 (303)	8.62 (219)	1.57 (40)	0.98 (25)	12.6 (5.7)
30	11.02 (10)	17.64 (16)	8.19 (208)	3.46 (88)	3.35 (85)	2.56 (65)	2.95 (75)	3.03 (77)	2.24 (57)	1.95 (49.5)	13.35 (339)	9.69 (246)	1.81 (46)	1.1 (28)	17.6 (8)
31	13.78 (12.5)	22.05 (20)	9.29 (236)	3.9 (99)	3.58 (91)	2.87 (73)	3.33 (84.5)	3.43 (87)	2.48 (63)	2.2 (56)	15.04 (382)	10.91 (277)	2.05 (52)	1.24 (31.5)	25.4 (11.5)
32	17.64 (16)	30.86 (28)	10.55 (268)	4.41 (112)	4.02 (102)	3.25 (82.5)	3.78 (96)	3.94 (100)	2.87 (73)	2.48 (63)	17.01 (432)	12.32 (313)	2.36 (60)	1.4 (35.5)	35.3 (16)
33	22.05 (20)	35.27 (32)	11.73 (298)	4.92 (125)	3.98 (101)	3.62 (92)	4.17 (106)	4.41 (112)	3.23 (82)	2.76 (70)	18.98 (482)	13.74 (349)	2.6 (66)	1.57 (40)	48.5 (22)
34	27.56 (25)	44.09 (40)	12.99 (330)	5.51 (140)	5.16 (131)	4.06 (103)	4.65 (118)	4.84 (123)	3.7 (94)	3.07 (78)	21.1 (536)	15.28 (388)	2.83 (72)	1.75 (44.5)	69.4 (31.5)
35	35.27 (32)	55.12 (50)	14.72 (374)	6.22 (158)	6.1 (155)	4.57 (116)	5.31 (135)	5.55 (141)	4.25 (108)	3.5 (89)	24.02 (610)	17.4 (442)	3.31 (84)	1.99 (50.5)	101 (46)
36	44.09 (40)	69.45 (63)	16.34 (415)	6.93 (176)	6.14 (156)	5.12 (130)	5.94 (151)	6.34 (161)	4.65 (118)	3.9 (99)	26.81 (681)	19.45 (494)	3.54 (90)	2.2 (56)	139 (63)
37	55.12 (50)	88.18 (80)	18.15 (461)	7.8 (198)	6.85 (174)	5.71 (145)	6.61 (168)	8.9 (226)	5.16 (131)	4.33 (110)	32.24 (819)	24.02 (610)	4.02 (102)	2.48 (63)	176 (80)
38	69.45 (63)	110.23 (100)	21.34 (542)	8.86 (225)	7.6 (193)	6.77 (172)	7.68 (195)	8.5 (216)	6.02 (153)	4.92 (125)	35.31 (897)	25.59 (650)	4.57 (116)	2.91 (74)	276 (125)
39	88.18 (80)	165.35 (150)	24.29 (617)	9.84 (250)	8.86 (225)	7.83 (199)	8.86 (225)	10.08 (256)	6.97 (177)	6.3 (160)	41.38 (1051)	30.12 (765)	5.12 (130)	3.39 (86)	551 (250)
40	110.23 (100)	220.46 (200)	27.56 (700)	10.83 (275)	10.79 (274)	9.33 (237)	10.24 (260)	10.43 (265)	8.03 (204)	7.09 (180)	46.85 (1190)	33.46 (850)	5.91 (150)	4.02 (102)	805 (365)
41	165.35 (150)	275.58 (250)	31.73 (806)	12.2 (310)	12.44 (316)	10.59 (269)	11.42 (290)	11.26 (286)	9.29 (236)	7.87 (200)	51.89 (1318)	36.54 (928)	6.69 (170)	4.72 (120)	1135 (515)
42	220.46 (200)	330.69 (300)	35.91 (912)	13.78 (350)	11.89 (302)	12.19 (309.5)	12.99 (330)	12.99 (330)	10.24 (260)	8.66 (220)	59.13 (1502)	41.42 (1052)	7.48 (190)	5.51 (140)	1609 (730)
43	275.58 (250)	440.92 (400)	41.57 (1056)	15.75 (400)	15.31 (389)	13.54 (344)	14.96 (380)	13.78 (350)	11.73 (298)	9.45 (240)	67.32 (1710)	47.05 (1195)	8.27 (210)	6.69 (170)	2326 (1055)

* Capacities listed are per DIN 7540 for temperatures from -40°C up to +200°C (-40°F up to 400°F).

For applications at other temperatures, please refer to DIN 7540.

Forging tolerances according to DIN EN 10243-1.





BELOW-THE-HOOK ATTACHMENTS

CAMLOK™ CLAMPS

General Information & Use	126
CZ Universal Plate Clamp	128
CY Hinged Universal Plate Clamp	129
CX Heavy Duty Hinged Universal Plate Clamp	130
LJ Gentle Grip Clamp	131
TTR Girder Clamp	132
CH Heavy Duty Horizontal Plate Clamp	133
CP Pile Pitching Clamp	134
TTG Horizontal Girder Clamp	134
CG Girder Turning Clamps	135
THK Horizontal Plate Clamp	136
HG High Grip Plate Clamp	137
THS Plate Clamp	138
TSH Plate Clamp	139
BTG Groundworks	140
CLB Container Lifting Lugs	140
HGC Hand Grip Clamp	141

CADY® PRODUCTS	142
-----------------------------	-----

Camlok™ PLATE AND BEAM CLAMPS

Camlok™ lifting clamps are part of an extensive portfolio of rigging and below-the-hook attachments from Columbus McKinnon. Available as stand-alone components or complete lifting systems, the Camlok line of clamps address a multitude of application needs and provide secure lifts for a variety of loads. These include:

- Structural Steel Plates
- Stainless Steel
- Iron
- Aluminum
- Girders/Beams
- Sheet Plates
- Steel Piles
- Rolled Steel Joists
- Manhole Pipes
- Shipping Containers

Camlok Clamps are designed in accordance with ISO9002, and the company is accredited by BSI (British standards) and a member of the Lifting Equipment Engineers Association (LEEA).



HOW TO SELECT THE RIGHT CLAMP FOR YOUR APPLICATION

For efficient, reliable, and secure operation of a lifting clamp, the selection of the correct clamp for the job is extremely important. Clamps can be used on most types and grades of steel up to a surface hardness of 300 Brinell (32HRc), and are suitable for certain grades of aluminum sheet and brass. Clamps are not suitable for steel over 300 Brinell (32HRc), stainless steel, lead, certain grades of copper and materials over 120°C or 250°F surface temperature. Some clamps are available for steel over 300 Brinell and stainless steel upon request.

DETERMINING PROPER SIZE

The working load limit (WLL) of the clamp should be as close as possible to the actual load to be lifted. This ensures the clamp works at maximum efficiency, reduces wear, and increases the clamp's service life. The maximum jaw capacity of the clamp should also be as close as possible to the plate thickness being lifted. The spring will be stretched to its maximum and will be providing the maximum amount of initial grip to the lift.

Excessive wear and a reduction in working life can be caused if a clamp is continuously used to lift material of the same thickness. With this type of application, the teeth of the clamp's moving jaw where the wear is concentrated must be inspected regularly. Scheduled or periodic rotation of duties will increase the operational life of your clamp inventory. Speciality clamps can be manufactured for specific needs as well.

DETERMINING PROPER TYPE

For lifting thin, light sheets, operators should choose a narrow throat clamp. The pad side of a narrow throat clamp is closer to the moving jaw, thus increasing the initial grip of the clamp by causing the spring to be stretched.

For lifting thick, but small, plates, the best solution is a larger clamp where the pad side is further away from the moving jaw.

For lifting loads of made of hardened steel, the operator should avoid using clamps with teeth that may damage the load. Non-marking clamps should be used instead.

CHOOSE AN ACCREDITED & EXPERIENCED SOURCE

Camlok is accredited by BSI (British Standards) and is a member of the Lifting Equipment Engineers Association (LEEA). Our clamps are designed in accordance with ISO9002. Whether you need a single clamp or a complete lifting system that includes forged rigging attachments, hoists and overhead cranes, count on the decades of engineering and application-driven experience provided by Columbus McKinnon and Camlok.

⚠ WARNING

If not properly installed, operated and maintained, the use of all mechanical equipment presents the possibility of personal injury or property damage. Before using lifting clamps, become familiar with applicable installation, operation and maintenance requirements. Clamps should be used only by authorized, properly trained operators.

TO AVOID INJURY:

- ▲ Inspect clamps and equipment before use. Do not use if components are bent, elongated, gouged, nicked excessively, worn, or damaged. Make sure that nuts, bolts, pins and other fasteners are tightened and secure. Make sure clamps are functional and will grip the load.
- ▲ Do not exceed the clamp's rated load or working load limit of other lifting equipment components.
- ▲ Lift only one plate at a time when using lifting clamps.
- ▲ Do not lift unbalanced loads. Avoid sudden jerks when applying the load. Rapid load application can produce overloading.
- ▲ Use clamps and lifting equipment only if authorized and properly trained.
- ▲ Always stand clear when lifting and lowering.
- ▲ Use more than one clamp suspended from a lifting beam when lifting long loads.
- ▲ Always gently lift and lower.

MECHANICS OF A CLAMP

The maximum load imposed on a device determines the structure and size of a plate clamp. The manufacturer will design the internal components of the clamp to cope with these forces in consideration of the expected mechanical losses of the system.

Most Camlok™ clamps use sharp teeth to bite into the plate being lifted. Once a clamp has bitten into the plate, it effectively becomes one with the plate and allows the plate to be safely lifted. The design of the clamp is such that the load applied to the hook ring is magnified through a system of links to create a high gripping force that pushes the jaw teeth into the lifted plate. This gripping force is directly proportional to the load applied and self actuating (i.e. the higher the load applied, the higher the gripping force). This is known as the primary action.

A secondary force generated by movement in the lifted plate supplements the primary gripping force. If the plate starts to slip from the clamp, the moving jaw is turned with the plate and the cam shape of the jaw increases the gripping force.

Plate lifting clamps are simple machines. Like all machines with mechanisms they are subject to naturally occurring phenomenon that reduce efficiency. These include:

- Friction between moving parts. This will reduce the forces transmitted through the mechanism.
- Inertia of the components. This will assert a degree of drag into the system slowing the reaction to changing inputs.

The system of links and pivots in a plate clamp are simple, lightweight, and move over a small distance when in operation. The bearings in a plate clamp are generally simple “metal on metal” type, have large forces acting through them, and have poor lubrication. Therefore, the friction loss can be significant if the clamp is poorly maintained and suffering from wear.

The mechanism of the plate clamp is not static during operation, but the movements are small. The inertia and friction of the mechanism can have a significant effect on the performance of the clamp when lifting material from the horizontal to the vertical position. The imposed load on the clamp fluctuates from 50% of the load being lifted to zero and then to 100% at the “top dead center” position. (The point when the center of gravity of the plate passes over the pivot point contact on the floor and is then lifted clear.)

The amount a tooth penetrates into the lifted plate is dependent on a number of factors:

- The gripping force
- The hardness of the plate being lifted
- The shape of the clamp tooth

In simple terms, a tooth will penetrate into the material until the gripping force, divided by the projected area of the tooth contact, equals the indent stress of the material.

LIFTING PAD & JAW DESIGN

SQUARE PADS

Unlike round pads on the market, Camlok uses a wide spacing or square pad layout. The wide spacing and layout of the teeth on the Camlok square pad help prevent pivoting of the plate and clamp during lifting. This protects the straight teeth on the moving jaw. All the teeth on the square pad can be used to lift the load therefore maximizing efficiency. The pads are marked with the maximum material hardness.

ROUND PADS

On round pads the gripping force must push all teeth into the material. However, only the top and bottom quarter of the pad can be used to effectively lift the load, thus reducing the efficiency of the pad. There is no resistance to pivoting and straight teeth on the jaw suffer rotational stress and wear.

SQUARE VS. ROUND PADS

	SQUARE	ROUND
Pivoting Resistance	Excellent	Poor
Teeth Wear	Excellent	Average
Full Surface Contact	Excellent	Poor
Load Distribution	Excellent	Poor
Pad Bolt Stress	Low	High

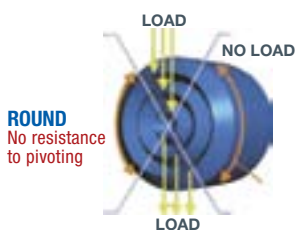
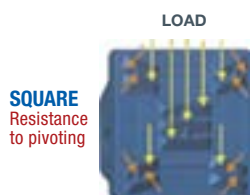

CAMLOK™ JAW

The wide pad and teeth layout on the Camlok clamp prevents the load from twisting or pivoting in the jaws. This helps prevent any unnecessary wear or damage on the teeth.

The force of the load on the Camlok clamp is distributed through the pad directly to the clamp housing. This means there is no load stress on the pad bolts and reduces the possibility of pad bolt failure during lifting.

Figure 1. When the load on round pads twists, the narrow jaw resists it. This places very high loads on the edge of the jaw, which is not designed to sustain this pivoting load.

FIGURE 1

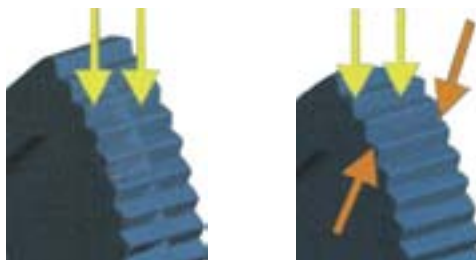

CZ UNIVERSAL PLATE CLAMP

WORKING LOAD LIMIT: 120 TO 66,000 LBS.

CZ Plate Clamps can be used on all hot rolled structural steel plates and sections up to a surface hardness of 300 Brinell (32HRc).

BENEFITS & FEATURES

- Body of clamp is welded construction
- Can be used to lift a plate from the horizontal to vertical position and vice versa through 180°
- Clamp jaws and pads are manufactured from high-tensile steel
- Fitted with a hold open and lock closed lever. To initiate the self actuating force, a spring is incorporated into the clamp to give an initial bite on the material. If the plate should start to slip during lifting, the cam shape of the jaw turns with the material and increases the gripping force.
- The cam handle is ergonomically designed with a flat surface to allow for ease of operation while wearing protective gloves
- The cam handle connects to the cam via a robust square drive
- Unlike others, these plate clamps are designed with a sloping slot, which increases the grip on the load when the clamp is in the horizontal position
- Design factor 4:1

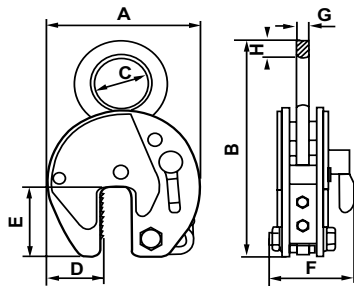
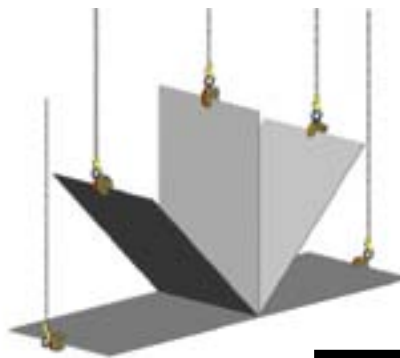

▶ INSPECTION, CARE & USE

DO NOT side load clamp more than 15° – use type CY or CX clamp for side loading

DO NOT lift plates with a temperature greater than 120°C or 250°F

DO NOT use to lift stainless steel, lead or copper.

For stainless steel plates, use LJ or HG Clamp.

DO NOT use on a double, triple, or quad sling. When using two clamps to lift a steel plate, a lifting beam must be used between the two clamps, so the clamps operate in a vertical position. Use a CY or CX clamp for slings with more than one leg.

For more information, visit us at www.cmworks.com

Product Code	Working Load Limit		Jaw Capacity (in.)	Dimensions (in.)								Weight (lbs.)
	Minimum (lbs.)	Maximum (lbs.)		A	B	C	D	E	F	G	H	
92 500	120	1,100	0 to 5/8	3.898	7.677	1.142	1.299	1.850	1.969	0.393	0.433	3.3
92 1500	350	3,300	0 to 3/4	4.961	8.858	1.969	1.929	2.756	3.228	0.472	0.472	6.6
92 2000	450	4,400	0 to 1-1/4	7.559	12.283	3.150	2.953	3.780	3.937	0.787	0.787	17.6
92 3000	675	6,600	0 to 1-1/4	7.559	12.283	3.150	2.953	3.780	3.937	0.787	1.181	22.0
CZ4	1,100	8,800	0 to 1-1/4	7.756	14.606	3.150	2.677	3.661	5.079	0.787	1.181	26.5
CZ4L	1,100	8,800	1-1/8 to 2-3/8	8.976	15.354	3.150	2.677	3.661	5.079	0.787	1.181	39.7
CZ6	1,600	13,200	0 to 2	11.535	19.055	3.504	3.740	5.630	5.079	0.984	1.378	46.3
CZ8	2,150	17,600	0 to 2	11.535	19.370	3.504	3.740	5.630	5.079	0.984	1.654	57.3
CZ8L	2,150	17,600	2 to 4	14.252	20.630	3.504	4.488	5.630	5.079	0.984	1.654	70.5
CZ10	3,350	22,000	0 to 2	11.535	21.457	4.331	3.740	5.630	5.472	0.984	1.772	66.1
CZ10L	3,350	22,000	2 to 4	14.252	21.457	4.331	4.488	5.630	5.472	0.984	1.772	81.6
CZ15	6,650	33,000	0 to 2	14.173	24.134	5.118	4.921	6.378	8.031	1.772	2.165	165.3
CZ15L	6,650	33,000	2 to 4	18.110	26.693	5.118	6.890	6.378	8.031	1.772	2.165	194.0
CZ20	8,850	44,000	0 to 2-1/2	18.189	29.724	5.118	6.496	8.268	9.252	1.772	2.559	271.2
CZ20L	8,850	44,000	2-1/2 to 5	22.047	31.693	5.118	7.677	8.268	9.252	1.772	2.559	299.8
CZ30	13,250	66,000	0 to 2-1/2	18.189	28.819	2.362	6.496	8.268	11.614	2.559	-	429.9

*Not Stocked

CY HINGED UNIVERSAL PLATE CLAMP

WORKING LOAD LIMIT: 450 TO 6,600 LBS.

CY Plate Clamps can be used on all structural steel plates up to a surface hardness of 300 Brinell (32HRc). These clamps are designed to be used with a two leg chain sling for lifting longer plates.

BENEFITS & FEATURES

- Can be used to lift a plate from the horizontal to vertical position and vice versa
- Can turn a plate from the horizontal to vertical position
- Sufficient clamping of the load is achieved by the special shape of the hook ring
- Fitted with a cam-operated closing mechanism that can be replaced with a chain pull open/close mechanism
- Because of the swiveling hook ring, clamps can be fitted to a steel plate in any position
- Design factor 4:1



INSPECTION, CARE & USE

- DO NOT** lift loads less than 20% of working load limit of clamp
- DO NOT** lift plates with a temperature greater than 120°C or 250°F
- DO NOT** use to lift stainless steel, lead or copper.
For stainless steel plates, use LJ or HG Clamp.

For more information, visit us at www.cmworks.com

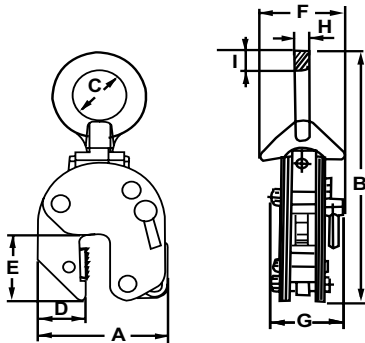

Product Code	Working Load Limit		Jaw Capacity (in.)	Dimensions (in.)								
	Minimum (lbs.)	Maximum (lbs.)		A	B	C	D	E	F	G	H	I
CY1	450	2,200	0 to 3/4	4.961	10.630	1.969	1.929	2.756	3.740	2.480	0.472	0.906
CY2	900	4,400	0 to 1-1/4	7.559	15.039	3.150	2.953	3.780	5.197	3.622	0.787	1.181
CY3	1,350	6,600	0 to 1-1/4	7.559	15.039	3.150	2.953	3.780	5.197	3.622	0.787	1.181

SAFE LOADS FOR TWO CLAMPS

Angle (degrees)	Product Code		
	CY1 (lbs.)	CY2 (lbs.)	CY3 (lbs.)
0 to 30	4,400	8,800	13,200
30 to 90	2,200	4,400	6,600
90 to 120	1,100	2,200	3,300

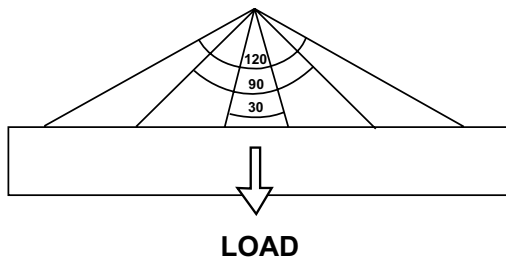

CX HEAVY-DUTY HINGED UNIVERSAL PLATE CLAMP

WORKING LOAD LIMIT: 1,000 TO 22,000 LBS.

CX Plate Clamps are a more robust, heavy-duty model of the CY clamp. The CX clamp has a reinforced plate at the top of the mouth and a heavy-duty hook ring. The CX clamp is more suitable for turning vertically racked plates.

BENEFITS & FEATURES

- Used on all hot rolled structural steel plates and sections up to a surface hardness of 300 Brinell (32HRc)
- Lifts plates from horizontal to vertical position and vice versa through 180°
- Vertically racked plates can be turned over due to the built-in lifting eye and link
- Clamps can be used with 2 leg slings
- Design factor 4:1



Hammerlok® and link not included

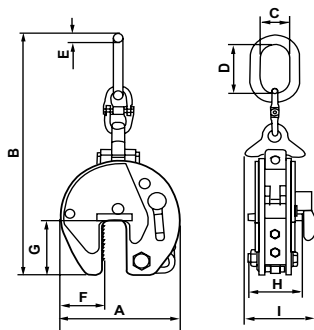

▶ INSPECTION, CARE & USE

- DO NOT** lift loads less than 20% of working load limit of clamp
- DO NOT** lift plates with a temperature greater than 120°C or 250°F
- DO NOT** use to lift stainless steel, lead or copper.
For stainless steel plates, use LJ or HG Clamp.

For more information, visit us at
www.cmworks.com

Product Code	Working Load Limit		Jaw Capacity (in.)	Dimensions (in.)									Weight (lbs.)
	Minimum (lbs.)	Maximum (lbs.)		A	B	C	D	E	F	G	H	I	
CX3000	1,000	6,600	0 to 1-1/4	7.756	20.276	2.638	5.433	0.748	2.677	3.661	3.189	4.331	26.5
CX6000	2,650	13,200	0 to 2	11.496	29.016	3.740	6.929	1.102	3.740	5.630	5.394	7.402	83.8
CX6000L*	2,650	13,200	2 to 4	14.449	30.906	3.858	7.087	1.102	4.528	5.630	5.315	7.402	105.8
CX8000	3,550	17,600	0 to 2	11.496	29.016	3.858	6.929	1.102	3.740	5.630	5.354	8.268	86.0
CX8000L*	3,550	17,600	2 to 4	14.449	30.906	3.858	7.087	1.102	4.528	5.630	5.354	8.268	112.4
CX10000	4,400	22,000	0 to 2	14.173	35.551	4.331	7.677	1.299	4.921	6.378	6.693	8.780	134.5
CX10000L*	4,400	22,000	2 to 4	17.559	36.260	4.409	7.677	1.299	6.614	6.378	6.693	8.780	167.5

*Not Stocked

LJ GENTLE GRIP CLAMP

WORKING LOAD LIMIT: 60 TO 3,300 LBS.

LJ Plate Clamps can be used to lift and turn all structural steel plates, including stainless steel, iron and aluminum, without marking or damaging the surface.

BENEFITS & FEATURES

- Designed to lift thin-gauge steel plates, stainless steel, iron, timber, and aluminum without marring or damaging the surface
- Lifts plates from the horizontal to vertical position and vice versa through 180°
- The performance on the leather jaws is not affected by standing water so the clamp can be used with submerged plasma cutting machines
- The LJ clamp is suitable for surface hardness greater than 300 Brinell (32HRc)
- Minimum load will not affect the LJ clamps as they do not have teeth for bite. However some load is required to combat friction in the clamp. Extra care must be taken when lifting plates in the lower 20% of their rated capacity. Thin plates are best lifted with the fixed jaw on top when performing a horizontal to vertical lift.
- The clamp may not be suitable for lifting highly polished plates where the polish process may leave lubricating compounds
- Design factor 4:1

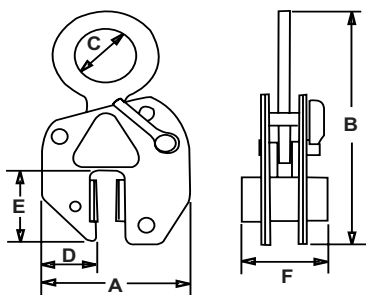

► INSPECTION, CARE & USE

DO NOT use the clamp on plates with surface contamination (dirt, grease, scale, etc...). Minimize dirt and dust on the surface to be lifted. Pads can tolerate surface water on the plate but shall not be submerged under water.

DO NOT use on smooth polished surfaces. Polished surfaces leave behind lubricating compounds. The leather pads need to surround the irregularities in the surface to grip the load effectively.

DO clean the leather pads regularly. Clean in water only and use a brass suede brush to rough up the surface.

DO NOT use solvents to clean the jaw lining as this may affect the bond between the surface material and the metal of the jaw.

DO inspect the clamp before each use. Make sure the pads are clean. If pads are cut or worn, or can not be cleaned, take clamp out of service and replace pads. When in doubt, remove clamp from service.

For more information, visit us at www.cmworks.com

Product Code	Working Load Limit		Jaw Capacity (in.)	Dimensions (in.)						Weight (lbs.)
	Minimum (lbs.)	Maximum (lbs.)		A	B	C	D	E	F	
LJ500	60	1,100	0 to 3/8	5.000	7.874	2.165	2.047	2.717	2.992	7.7
LJ1500	400	3,300	0 to 3/4	8.465	13.583	3.346	2.953	5.315	4.646	26.5

TTR GIRDER CLAMP

WORKING LOAD LIMIT: 90 TO 6,600 LBS.

TTR Clamps can be used on girders and rolled steel joists up to a surface hardness of 300 Brinell (32HRc). These clamps are designed for handling structural beams with the flange in a vertical position, or “H” position.

BENEFITS & FEATURES

- Used to lift and transport structural beams up to a surface hardness of 300 Brinell (32HRc) with the flanges in the upright position
- Versatile tool for transporting girders and joists. Can be used to lift and stack girders horizontally.
- The hook rings are designed to be as near to the center of gravity as possible, resulting in a near horizontal lift
- Clamp is fitted with a cam-operated locking mechanism
- Short beams may be lifted with a single clamp, longer beams should use 2 clamps in combination with a spreader beam
- Design factor 4:1

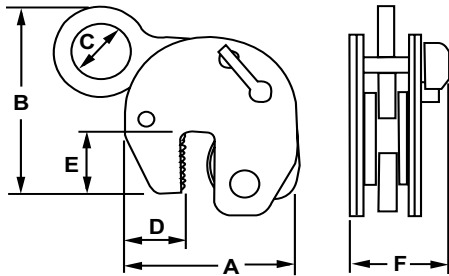

▶ INSPECTION, CARE & USE

DO NOT lift plates with a temperature greater than 120°C or 250°F
DO NOT use to lift stainless steel, lead or copper.

For more information, visit us at www.cmworks.com

Product Code	Working Load Limit		Flange (in.)	Dimensions (in.)						Weight (lbs.)
	Minimum (lbs.)	Maximum (lbs.)		A	B	C	D	E	F	
TTR750	90	1,600	1/4 to 5/8	5.375	7.500	2.000	1.750	2.375	3.500	7.7
TTR1500	350	3,300	1/4 to 1	7.500	10.625	2.625	2.625	3.000	4.875	22.0
TTR3000*	700	6,600	1/4 to 1	8.250	9.875	3.500	2.625	3.375	5.000	26.5

*Not Stocked

BELOW-THE-HOOK ATTACHMENTS

CH HEAVY-DUTY HORIZONTAL PLATE CLAMP

WORKING LOAD LIMIT: 2,200 TO 17,600 LBS.

CH Clamps must be used in pairs and can be used on all types of materials in plate form, providing the plate can withstand the forces imposed. Standard CH clamps are supplied with smooth jaws.

BENEFITS & FEATURES

- CH clamps are designed for loading process machines and to lift and transport sheet steel plates in the horizontal position
- Can be designed to suit any load or plate thickness
- Clamps are suitable for lifting one plate at a time, or bundles of plates provided the plates are the same width, have straight square sides, and are thicker than 10% of the maximum jaw capacity of the clamp
- Clamps have smooth teeth so they can be used on all types of material
- The smooth jaws can be replaced with serrated, hardened steel teeth and used on material up to 300 Brinell (32HRc)
- Designed to be used with 2 legged slings
- CH clamps should never be side loaded
- Sold in pairs
- Design factor 4:1

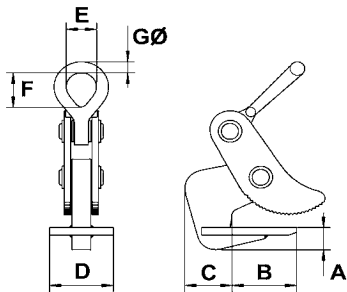

▶ INSPECTION, CARE & USE

DO NOT side load CH clamps.

DO NOT use on a quad sling. When lifting long plates, use a beam or spreader bar that has a double leg sling at each end and connect clamps to the slings.



For more information, visit us at
www.cmworks.com

Product Code	Working Load Limit (lbs. per pair)	Jaw Capacity (in.)	Dimensions (in.)							Weight (lbs. per pair)
			A	B	C	D	E	F	G	
CH1	2,200	1/4 to 1-1/4	1.181	3.228	2.362	3.937	1.260	1.732	0.512	13.2
CH2	4,400	1/4 to 1-1/4	1.181	3.228	2.362	3.937	1.969	2.874	0.709	24.3
CH2/L	4,400	3/4 to 2	1.181	3.228	2.362	3.937	1.969	2.874	0.709	26.5
CH4	8,800	1/4 to 1-1/4	1.575	4.409	3.150	3.937	2.520	3.622	0.984	37.5
CH4/L	8,800	2 to 4	1.575	4.409	3.150	3.937	2.520	3.622	0.984	50.7
CH6	13,200	1/4 to 3	2.165	6.772	3.937	5.118	3.543	5.118	1.378	101.4
CH6/L	13,200	2 to 5	2.165	6.772	3.937	5.118	3.543	5.118	1.378	123.5
CH8	17,600	1/4 to 3	2.165	6.772	4.134	5.118	3.543	5.118	1.378	116.8
CH8/L	17,600	2 to 5	2.165	6.772	4.134	5.118	3.543	5.118	1.378	132.3
CH10	22,000	1/4 to 4	2.559	8.465	4.724	5.906	4.488	5.118	1.378	209.4
CH10/L	22,000	2 to 6	2.559	8.465	4.724	5.906	4.488	5.118	1.378	238.1
HH8*	17,600	1/4 to 2	2.165	6.614	4.134	5.118	4.134	5.118	3.543	46.3
HH8/L	17,600	2 to 4	2.165	6.614	4.134	5.118	3.543	4.488	1.378	61.7

*Not Stocked

CP PILE PITCHING CLAMP

WORKING LOAD LIMIT: 4,400 TO 11,000 LBS.

CP Clamps are designed specifically for pitching sheet steel and have the advantage of an attached rope for easy release from the ground.

BENEFITS & FEATURES

- Designed specifically for pitching sheet steel piling
- Ideal clamp for heavy construction
- Rope is fitted for easy release from the ground
- These are not designed to extract driven piles, use the PP series clamps for this
- Design factor 4:1

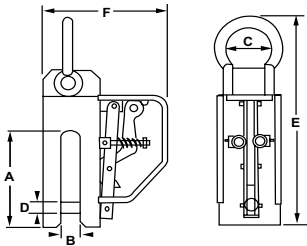

▶ INSPECTION, CARE & USE

DO NOT use CP Clamps to extract a driven pile. Use the PP series clamps for this application.

For more information, visit us at www.cmworks.com



Product Code	Working Load Limit (lbs.)	Dimensions (in.)						Weight (lbs.)
		A	B	C	D	E	F	
CP2	4,400	8.976	0.787	2.000	0.787	16.750	8.500	41.9
CP3	6,600	8.976	1.024	2.500	1.181	17.875	8.875	50.7
CP5	11,000	8.976	1.378	3.250	1.181	19.875	9.500	72.8

TTG HORIZONTAL GIRDER CLAMP

WORKING LOAD LIMIT: 200 TO 16,500 LBS.

TTG Clamps are designed to lift and transport structural steel beams in the horizontal position.

BENEFITS & FEATURES

- Designed to lift and transport structural steel beams in the horizontal position
- Fitted with a Camlok spring-operated safety lock and is operated by pulling the lock upwards
- For short beams, a single clamp can be used. Long beams should be lifted using 2 clamps attached to opposite beam flanges
- Maximum hardness of material to lift should not exceed 300 Brinell (32HRc)
- Design factor 4:1

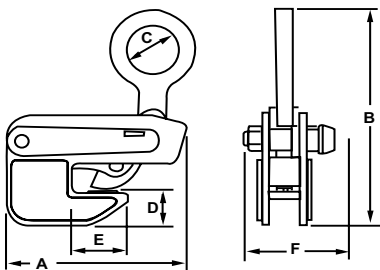

▶ INSPECTION, CARE & USE

DO NOT lift plates with a temperature greater than 120°C or 250°F

For more information, visit us at www.cmworks.com



Product Code	Working Load Limit		Plate (in.)	Dimensions (in.)						Weight (lbs.)
	Minimum (lbs.)	Maximum (lbs.)		A	B	C	D	E	F	
TTG1500	200	3,300	0 to 1-1/8	9.000	10.875	3.750	1.750	2.750	4.000	12.1
TTG3000	350	6,600	0 to 1-3/8	11.125	11.625	3.125	2.125	2.875	4.500	24.3
TTG4500*	1,000	9,900	0 to 1-1/2	12.375	13.250	3.500	2.375	3.000	4.625	32.0
TTG7500*	1,650	16,500	0 to 1-3/4	14.500	15.000	4.375	2.500	3.625	6.625	61.7

*Not Stocked

CG GIRDER TURNING CLAMPS

WORKING LOAD LIMIT: 250 TO 13,200 LBS.

CG Clamps can lift and turn girders through 90° and are designed to meet the requirements of the heavy steel industry. They are general purpose clamps and can be used on rolled steel joists, beams, and fabrications up to a surface hardness of 300 Brinell (32HRc).

BENEFITS & FEATURES

- Can be used on beams, fabrications, channels and rolled steel joists
- Can lift and turn beams up to 90° and are designed to land the beam in either the vertical or horizontal position.
- Fitted with a cam/spring-operated safety lock
- Incorporates a positive lock onto one of the uppermost edges, which will allow the beam to be set down with the flange vertical
- For long girders, fabrications and welded structures, two clamps and a lifting beam may be required
- Design factor 4:1

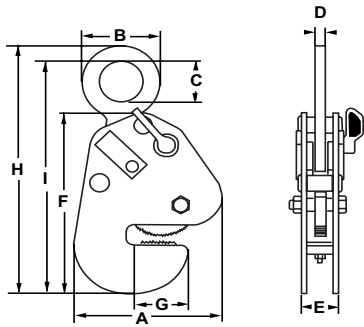

▶ INSPECTION, CARE & USE

DO NOT lift plates with a temperature greater than 120°C or 250°F

For more information, visit us at
www.cmworks.com

Product Code	Working Load Limit		Jaw Capacity (in.)	Dimensions (in.)									Weight (lbs.)
	Minimum (lbs.)	Maximum (lbs.)		A	B	C	D	E	F	G	H	I	
CG1	250	2,200	0 to 5/8	8.307	3.543	1.969	0.512	1.693	10.354	2.520	13.780	13.268	13.2
CG2	450	4,400	0 to 1-1/4	11.417	5.512	3.150	0.787	2.362	12.480	3.937	18.307	17.126	30.9
CG4	900	8,800	0 to 1-1/4	11.417	6.339	3.504	0.787	3.031	12.835	4.252	20.591	18.976	41.9
CG6	1,350	13,200	7/16 to 2	13.268	6.732	3.504	0.984	4.055	14.764	5.709	21.693	20.630	81.6

THK HORIZONTAL PLATE CLAMP

WORKING LOAD LIMIT: 90 TO 19,800 LBS.

THK Clamps have a jaw that pivots in the reverse direction to our normal horizontal clamps and are designed to lift and handle thin sheet plates that tend to sag when being lifted.

BENEFITS & FEATURES

- Designed to lift and transport thin steel plates in the horizontal position
- The reverse jaw feature ensures that the grip of the clamp increases the more the plate deflects under its own self weight
- Clamps are used in pairs with a two legged chain sling. Two pairs of clamps supported from a lifting beam must be used when handling long plates
- Only lift one plate at a time
- Design factor 4:1

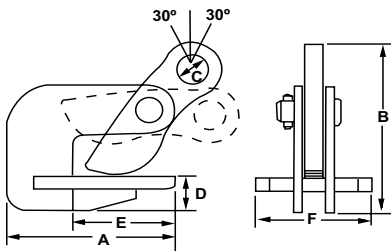

Product Code	Working Load Limit		Plate (in.)	Dimensions (in.)						Weight (lbs. per pair)
	Minimum (lbs.)	Maximum (lbs.)		A	B	C	D	E	F	
THK750	90	1,600	0 to 1	4.625	5.375	0.750	1.000	2.875	3.125	6.6
THK1500	200	3,300	0 to 1-3/8	5.375	6.625	1.000	1.250	3.125	3.500	13.2
THK4500*	500	9,900	0 to 1-3/4	8.625	8.625	1.750	4.000	4.375	4.375	35.3
THK6000*	700	13,200	0 to 2-3/8	8.375	10.500	1.375	1.875	4.875	4.375	50.7
THK9000	1,000	19,800	0 to 2-3/8	8.750	11.375	1.625	2.250	4.500	5.500	77.2

*Not Stocked

▶ INSPECTION, CARE & USE

DO NOT use THK clamps with 3 or 4 leg slings. Use a spreader beam.



For more information, visit us at
www.cmworks.com

HG HIGH GRIP PLATE CLAMP

WORKING LOAD LIMIT: 100 TO 8,800 LBS.

HG High Grip Clamps are designed to give additional grip forces to products during lifting. The High Grip has an additional lever in the clamping mechanism thus asserting a higher gripping force on the plate being lifted.

BENEFITS & FEATURES

- Can be used on hot rolled structural steel plates
- Can be used to lift stainless steel plates or plates with hardened surfaces due to cold rolling
- Smaller jaw range makes these clamps more efficient for lifting thinner steel
- Suitable for hardness up to 371 Brinell (40 HRc)
- Can be used for lifting and turning plates from the horizontal to vertical position or vice versa, through 180°
- Clamp has serrated teeth and will mark plate
- Standard clamp is fitted with a hook ring but can be alternatively supplied with a short length of chain
- Design factor 4:1

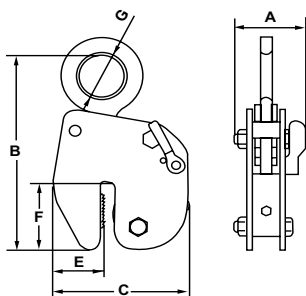

► INSPECTION, CARE & USE

DO NOT side load clamp more than 15°

DO NOT lift plates with a temperature greater than 120°C or 250°F

DO NOT use clamps on a double chain sling, when using two clamps to lift a steel plate, a lifting beam must be used between the two clamps to allow clamps to hang vertically

For more information, visit us at
www.cmworks.com

Product Code	Working Load Limit		Jaw Capacity (in.)	Dimensions (in.)						Weight (lbs.)
	Minimum (lbs.)	Maximum (lbs.)		A	B	C	E	F	G	
HG500	100	1,100	0 to 3/8	1.654	9.055	5.827	2.165	3.110	1.969	11.0
HG1000	150	2,000	0 to 5/8	3.661	11.698	8.268	2.638	4.488	2.638	26.5
HG2000	450	4,400	0 to 3/4	4.331	16.378	12.008	4.016	6.260	3.150	48.5
HG3000*	700	6,600	0 to 3/4	4.331	16.378	12.008	4.016	6.260	3.150	59.5
HG4000*	900	8,800	0 to 3/4	4.724	13.189	12.008	4.016	6.220	3.150	70.5

*Not Stocked

THS PLATE CLAMP

WORKING LOAD LIMIT: 90 TO 9,900 LBS.

THS Plate Clamps can be used with single or two leg slings with a maximum angle of 60°. The clamps are designed to be used on structural steel plates up to a surface hardness of 300 Brinell (32HRc), providing the plate can withstand the forces imposed.

BENEFITS & FEATURES

- Spring/lever-operated mechanism securely locks the clamp onto the horizontally positioned plate
- Do not use to lift stainless steel, lead or copper
- Can be used in single or 2 leg slings
- Use lifting beams for longer plates
- Clamp locks quickly onto the plate, enabling a single operator to set up the plate for lifting
- Lifts and handles single sheet steel plates in the horizontal position
- Useful for loading plates into guillotines, presses, punching machines and folding presses
- Caution should be used so that maximum single angle of 60° is not exceeded
- Design factor 4:1

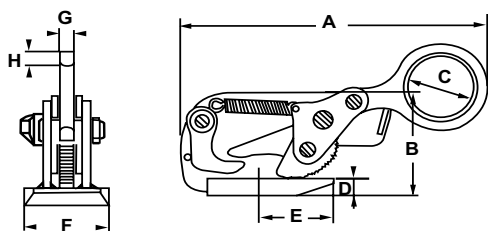
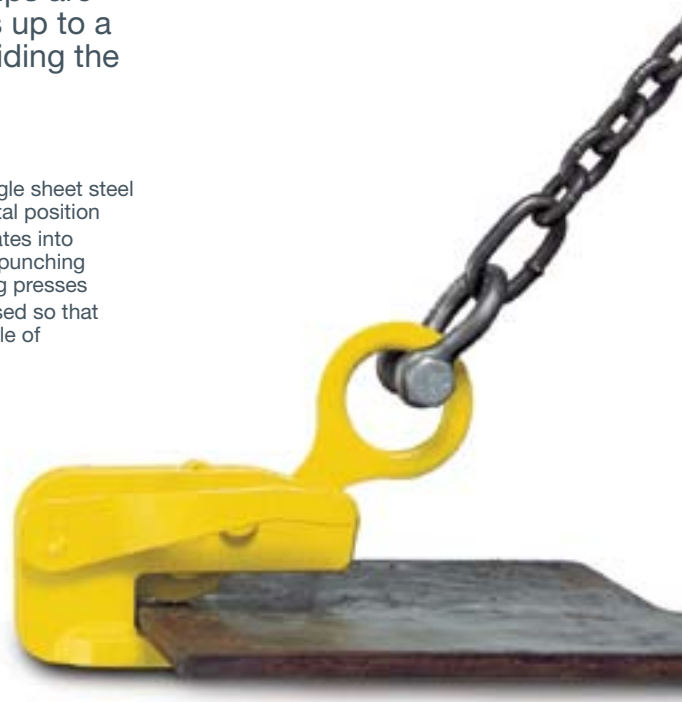

▶ INSPECTION, CARE & USE

- DO NOT** use with endless, 3 or 4 leg slings
- DO NOT** exceed 60° angle when lifting
- DO NOT** lift plates with a temperature greater than 120°C or 250°F
- DO NOT** use to lift stainless steel, lead or copper

For more information, visit us at
www.cmworks.com

Product Code	Working Load Limit		Jaw Capacity (in.)	Dimensions (in.)								Weight (lbs.)
	Minimum (lbs.)	Maximum (lbs.)		A	B	C	D	E	F	G	H	
THS750	90	1,600	0 to 3/4	10.039	3.819	1.969	0.591	2.756	3.150	0.472	0.591	6.6
THS1500	175	3,300	0 to 1-3/8	13.189	4.724	2.756	0.787	3.150	3.543	0.591	0.669	13.2
THS4500	500	9,900	0 to 1-3/4	17.717	7.717	3.543	2.323	4.331	4.331	0.787	1.181	37.5

TSH SCREW CLAMP

WORKING LOAD LIMIT: 3,300 TO 11,000 LBS.

TSH clamps are designed for pulling and holding sheet metal, girders, and related steel objects.

BENEFITS & FEATURES

- Recommended for use with lever tools
- Offer the best means of holding and securing loads - great for positioning
- Primarily used as anchor points to allow fabrications to be pulled together and positioned during assembly or prior to welding
- Supplied complete with an alloy shackle that allows for pulling 180°
- High force screw threads
- Hardened steel jaws
- The clamps are attached by turning the screwed threaded axle
- When load is applied to the clamp, the circular toothed pad pivots in a cam action, gripping the load
- Swivel jaws increase grip if plate moves
- Maximum hardness of material to lift should not exceed 300 Brinell (32HRc)
- Not recommended for lifting applications
- Design factor 4:1



► INSPECTION, CARE & USE

- DO NOT** lift plates with a temperature greater than 120°C or 250°F
- DO NOT** use with stainless steel, lead or copper
- DO NOT** over torque the threaded axle. This could cause damage to the pad.

For more information, visit us at www.cmworks.com

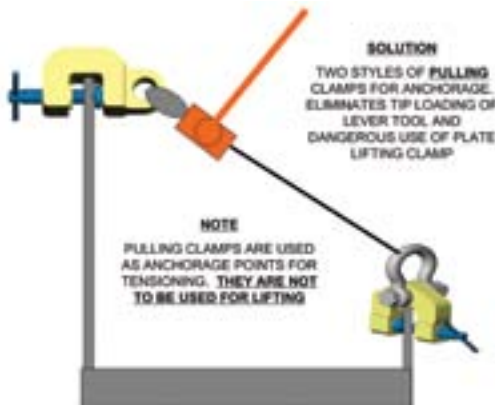
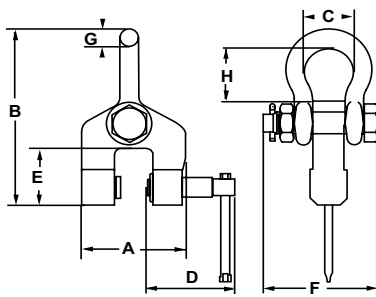

Product Code	Working Load Limit (lbs.)	Jaw Capacity (in.)	Dimensions (in.)								Weight (lbs.)
			A	B	C	D	E	F	G	H	
TSH1500	3,300	0 to 1-1/4	5.118	10.039	2.559	4.528	2.953	5.000	1.024	3.701	15.4
TSH3000	6,600	0 to 2	6.693	11.417	2.913	4.921	3.346	5.669	1.181	4.646	24.3
TSH5000	11,000	0 to 3-1/8	10.039	18.504	5.118	6.890	5.315	9.449	1.969	6.890	59.5

BTG GROUNDWORKS

WORKING LOAD LIMIT: 3,300 TO 6,600 LBS. (PER SET OF 3)

BTG Clamps are designed to lift and handle concrete manhole pipes in the vertical position. These clamps enable the manhole trench size to be minimized and facilitate accurate positioning of pipes on top of each other.

BENEFITS & FEATURES

- Solid construction and lightweight design
- Sold in sets of 3
- Simple handling - Attachment and removal of the clamps from the pipes is extremely easy due to the simple and straight-forward design
- Large jaw capacity
- Service friendly
- Design factor 4:1

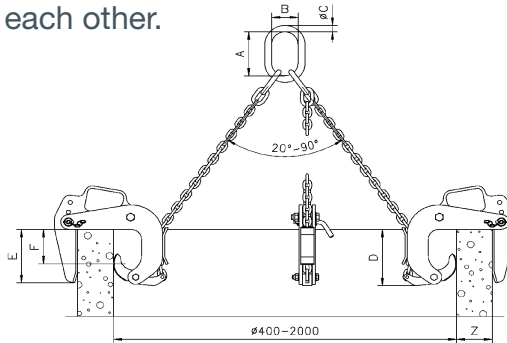

Product Code	Working Load Limit (lbs. per set of 3)	Jaw Capacity (Z, in.)	Dimensions (in.)						Weight (lbs.)
			A	B	C	D	E (Mouth)	F (Pressure Line)	
BTG1500/3	3,300	1-1/2 to 4-3/4	5.315	5.315	0.709	7.087	6.496	3.937	75.0
BTG3000/3	6,600	2 to 7	6.890	3.937	1.024	12.205	9.646	6.890	132.3
BTG3000L/3	6,600	3-1/2 to 8-5/8	6.890	3.937	1.024	12.205	9.646	6.890	172.0

CLB CONTAINER LIFTING LUGS

WORKING LOAD LIMIT: 88,100 LBS. (PER SET OF 4)

Supplied in sets of 4, CLB Lifting Lugs serve as flexible lashing points for the transportation of containers.

BENEFITS & FEATURES

- Spring-loaded bolt to prevent accidental release
- Mounted horizontally at the side of the container in either upper or lower holes
- Easy installation and removal – simply insert and turn to install
- Designed to eliminate the dangerous use of standard hooks
- Lugs cannot drop out when slings become slack
- Lugs can be used for left hand or right hand turns
- For maximum capacity, use a lifting beam in conjunction with CLB lifting lugs
- Design factor 4:1

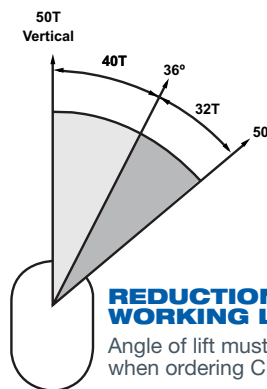
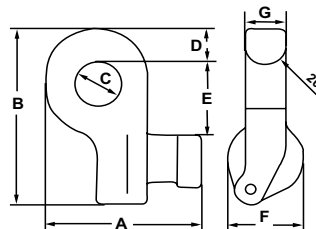

REDUCTION OF WORKING LOAD LIMIT
 Angle of lift must be specified when ordering CLB lifting lugs

Product Code	Working Load Limit (lbs. per set of 4)	Dimensions							Weight (lbs.)
		A	B	C	D	E	F	G	
CLB40	88,100	5.984	7.126	1.772	1.457	2.874	2.953	1.575	39.7

HGC HAND GRIP CLAMP

WORKING LOAD LIMIT: 500 LBS.

The HGC Hand Grip Clamp is designed to manually lift, carry or pull any object that will fit into the jaws. It is primarily used in workshop environments.

BENEFITS & FEATURES

- Additional lever in clamping mechanism provides a very high gripping force
- Can be used to lift plate from horizontal to vertical position and vice versa
- Can be used on all structural steel plates and sections up to a surface hardness of 300 Brinell (32HRc)
- Not suitable for steel over 300 Brinell, stainless steel, lead, copper and materials over 120°C/ 250°F surface temperature
- Enables the operator to open and attach the clamp to sheet material by depressing the lifting handle
- Two pre-tensioned, hardened, serrated toothed jaws grip the sheet securely when the handle is released, preventing plate slippage
- Design factor 4:1

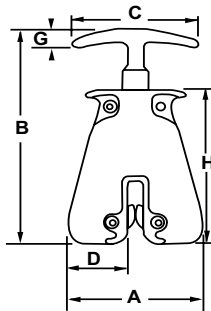
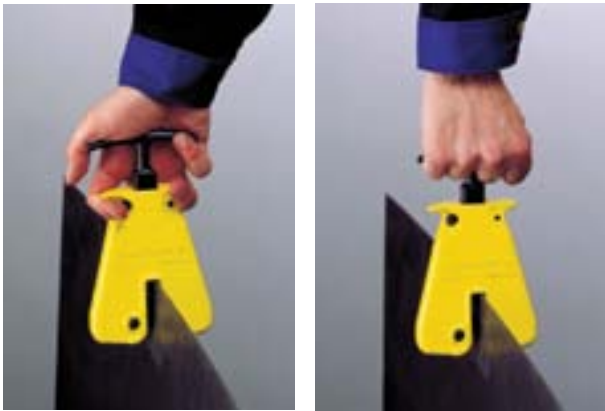

► INSPECTION, CARE & USE

DO NOT lift plates with a temperature greater than 120°C or 250°F
DO NOT use to lift stainless steel, lead or copper.

NOTE: Clamp in photo above is shown with handle. For loads heavier than 75 lbs., use a clamp with a lifting ring. **DO NOT** use a sling in conjunction with the handle-style clamp.

For more information, visit us at
www.cmworks.com

Product Code	Working Load Limit (lbs.)	Plate Size (in.)	Dimensions (in.)								Weight (lbs.)
			A	B	C	D	E	F (Thickness)	G	H	
HGC	500	0 to 3/8	4.25	7.25	3.875	1.875	2.125	0.875	0.375	5.125	2.0

Cady **CADY LIFTERS** **GENERAL INFORMATION**



Cady Lifters represents a complete line of below-the-hook attachments for efficiently handling goods in industrial, construction, and related environments. The Cady team of welders conform to the Structural Welding Code of the American Welding Society, thus ensuring the consistency of the products manufactured. All products conform to the requirements of ANSI/ASME B30.20 for below-the-hook lifting devices.

In addition to the standard products listed below, custom solutions can be designed to satisfy the most challenging lifts. Products such as tongs, scissors, and grabs may be tailored to the exact application.

LIFTING BEAMS

Use for a multitude of applications ranging from low headroom and high capacity to load leveling and multiple-point.

- MPB - Multiple Purpose Lifting Beam
- ALB - Adjustable Lifting Beam
- TBSB - Fixed Twin Basket Sling Lifting Beam
- FLB - Fixed Spread Lifting Beam
- LHB - Low Headroom Multiple Spread Lifting Beam
- HCLB - High-Capacity Lifting Beam
- HDBB - Heavy Duty Twin Basket Sling Lifting Beam
- THLB - Twin Hoist Lifting Beam
- ABB - Adjustable Bail Lifting Beam
- Motorized Load Leveling Lifting Beam
- BCB - Bulk Container Lifting Beam
- AFPB - Standard Adjustable Four Point Lifting Beam
- FPB - Four Point Lifting Beam
- TPB - Three Point Lifting Beam
- CCB - Chlorine Cylinder Lifting Beam
- LHMB - Low Headroom Multiple Spread Lifting Beam
- LLL - Load Leveling Lifting Beam
- RLB - Twin Hoist Rotating Lifting Beam

SPREADER BEAMS

Perfect for adding stability where headroom is not limited.

- FSB - Fixed Spreader Beam
- ADJSB - Adjustable Spreader Beam

COIL LIFTERS & UPENDERS

Available in a variety of styles and sizes, both manual and motorized, for handling a wide range of coil widths.

- NCC - Narrow Coil C-Hook
- DCH - Dixon Coil C-Hook
- HDC - Heavy Duty C-Hook
- CSC - Close Stacking C-Hook
- SCC - Slit Coil C-Hook
- VCL - Vertical Coil Lifter
- ECL - Extended Width Vertical Coil Lifter
- HCL - Vertical Coil Lifter with Hand Wheel
- Fixed Bail Coil Lifter
- Rotating Bail Coil Lifter
- Telescopic Coil Lifter with Hand Wheel
- NCL - Narrow Aisle Coil Lifter
- HDCU - Heavy Duty Coil Upender
- LPU - Low Platform Coil Upender
- Parking Stands for Coil Lifters

SHEET LIFTERS

Ideal for handling bundles, sheets, plates and other stacked material.

- PL - Plate Lifters
- HSL - Heavy Duty Sheet Lifters
- SBSL - Small Bundle Sheet Lifter
- SSL - Standard Duty Sheet Lifter

PALLET LIFTERS

Whether standard or heavy duty, fixed or adjustable, pallet lifters are ideal for lifting and handling pallets in a variety of applications.

- ALL - Adjustable Load Lifter
- WPL - Wheeled Pallet Lifter
- LPL - Lightweight Pallet Lifter
- FPL - Standard Fixed Forks Pallet Lifter
- HPL - Heavy Duty Fixed Forks Pallet Lifter
- APL - Standard Adjustable Forks Pallet Lifter
- HAPL - Heavy Duty Adjustable Forks Pallet Lifter
- HWPL - Hand Wheel Adjustable Forks Pallet Lifter
- HHWPL - Heavy Duty Hand Wheel Adjustable Forks Pallet Lifter

ROLL LIFTERS

Lift, position and upend a wide range of roll sizes.

- SRB - Standard Roll Lifting Beam
- Special Roll Lifting Beam
- Roll Gripping Tongs
- Roll Grab
- Motorized Roll Lifter
- Roll Lifting C-Hook
- Roll Positioner

LIFTING TONGS

Versatile attachment perfect for a range of lifting applications, such as handling rolls, tubes, bales, containers and crates.

- Custom Friction Tongs
- BLT - Bale Lifting Tongs - Standard Indentation Type
- DT - Die Lifting Tongs - Standard Support Type



C-HOOKS

BENEFITS & FEATURES

C-Hooks are available in a variety of styles. Compact C-Hooks are rugged, yet lightweight for easy handling. The polished, large radius inside corners of Cady compact C-Hooks minimize stress concentration in these critical areas. These inside corners are positioned to avoid contact with coil edges, thus reducing coil damage. Additionally, the curved saddle on the lower arm reduces wear on the coil.

In addition to the popular Compact C-Hooks, the following are part of the Cady Lifters line:

- **Close Stacking C-Hooks** – Contain a short upper arm that permits handling a large range of coil sizes flush against a vertical surface. This arm also allows the user to handle all coils in a range without interfering with adjacent coils during movement.
- **Ship Loaders** – Designed for use with slings to handle two coils simultaneously. Hooks are easily separated for insertion into coils.



CRANE FORKS

BENEFITS & FEATURES

Crane forks are ideal for handling palletized loads in areas such as loading docks, crowded or unpaved storage areas, and railroad yards. They are also frequently used to load barges, gondolas and open-top trucks.

All Cady crane forks are counter balanced to hang level when empty and increase the rate of handling. Counterweight balances the lifter structure only, not the load. The load is centered under the lifting bail for a level lift.

SPREADER BEAMS

BENEFITS & FEATURES

Lifting beams and spreaders are available in a wide range of capacities and styles. Beams are available in fixed or adjustable styles and may also be designed with special hook or shackle configurations. Low headroom beams are offered with either fixed or movable hooks and can also be designed for three-point lifts.



WARNING

- ▲ Inspect lifter, moving lifter parts and operating controls for proper operation before each use. Never use malfunctioning or damaged lifter, or one tagged "Out of Service."
- ▲ Do not exceed rated load of lifter and crane.
- ▲ Make sure load is balanced and stable.
- ▲ Avoid shock loads due to sudden starts and stops.
- ▲ Make sure lifting ropes and chains are not twisted or kinked.
- ▲ Do not lift people. Make sure operator and others are clear of load at all times.
- ▲ Make sure load clears objects during moving.

▶ For more information on Cady below-the-hook lifters, visit us online at www.cmworks.com/cady





TRANSPORT CHAIN & ATTACHMENTS

Inspection, Use & Care	146
Transport (Binding) Chain	148
Welded Assembly	149
Clevis Assembly	150
Clevis Assembly with Import Hooks	150
Rivet Assembly	151
Aircraft Assembly	151
Cluster Assembly with Grab, R Hook and J/T Combo	152
Chain Assembly with J, Grab and J/T Combo	152
Chain Assembly with Grab, R, J/T Combo	152
Bridle Assembly Tow Tiger with J and J/T Combo	153
Bridle Assembly Tow Tiger with R and J/T Combo	153
“J” Hook	154
Recovery “J” Hook Assemblies	154
Forged R, T & Mini J Hook	155
Pear Links	155
Double Clevis (Mid Link)	156
Clevis Grab Hook (Grade 70 & Grade 80)	157
Eye Grab Hook (Grade 70 & Grade 80)	158
Clevis Slip Hook	159
Eye Slip Hook	159
Clevis Style Heavy Duty Tie Downs	160
Clevlok® Style Heavy Duty Tie Downs	160
Ratchet Binders Heavy Duty Tie Downs	160
Forged Ratchet Load Binder	161
Removable Handle Load Binder	161
Forged Lever Load Binder	162
Specialty Forged Lever Load Binder	162
E-Z Pro® Cam Release Lever Binder	163
CMG Ratchet/ Lever Binders	163
D-Rings	164
Sixth Wheel Ratchet	164
High Test Chain	165
Welded Assembly	165
Clevis Assembly	166
Proof Coil Chain	167
Hanger Chain	167
Clevis Slip Hook	168
Eye Slip Hook	168
Clevis Grab Hook	169
Eye Grab Hook	169
Weld-On Grab Hooks	170
Weldless Rings	170
Repair Links/Lap Link	170
Cold Shuts	171
Forged Triangles	171

TRANSPORTATION

Columbus McKinnon and our Tennessee-based Dixie Industries are leaders in innovation for the towing and transportation industries. We are the premier manufacturer of American-made chain and forged attachments for the towing industry. We are proud to not only offer towing products, but a full line of chain and hardware for the heavy-duty trucking industry.

LOAD BINDER USE, INSPECTION & CARE

USE

1. Always follow safe work practices and take precautions in use of binders. Particular attention is called to the following sections of D.O.T. Federal Motor Carrier Safety Regulations: S392.9 (relating to safe loading); S393.100 (relating to protection against shifting or falling cargo); and S393.102 (relating to securement systems).
2. Never exceed working load limit shown on the binder. Hand effort will tighten binder to working load limit.
3. Always inspect the load binder before use. See the load binder inspection section below.
4. Always position the load binder so the handle goes downward when securing or tightening the load.
5. Operate only by hand from a firm standing position.
6. Do not operate load binder while anyone is on the load.
7. Do not use a cheater bar or handle extension. Extensions can dangerously overload the binder system and may result in serious injury. Use a ratchet-type binder if sufficient leverage is difficult to develop.
8. Make certain that the lever of the lever-type binder is over center and locked. Always secure the handle in the locked position with a positive retaining method. The handle must be secured since there is a possibility of relaxation of the load, which may result in the lever moving from the locked-over-center position to relaxed mode, resulting in loss of tension in the system.
9. Release handle/load with extreme care. Make sure everyone is clear. Lever binder handle can snap back over center. Use open palm under handle and push up.
10. Tighten binders before moving and frequently recheck and retighten.

CARE

Care should be exercised during use so that the binder is not abused or damaged.

1. The binder or hooks should not be subjected to bending or sharp objects. Loading should be in a straight line.
2. Avoid exposure to corrosive mediums. Lubricate periodically.

INSPECTION

Inspect binder prior to each use for damage, distortion, cracks, nicks, or wear.

1. Bending of any feature in any plane of more than 10 degrees is cause for removal of the unit from service. Any distortion indicates overloading or misuse.
2. Distorted or elongated connecting links indicate overloading or misuse and is also cause for removal of the unit from service.
3. If wear of connecting link ends is more than 10% of the original stock, remove unit from service.
4. On lever-type binders inspect yoke periodically for distortion and make certain it is seated on the pins.
5. Deep nicks and gouges should be smoothed out to relief stress concentrations providing that the material removed does not exceed 10% of the total material.
6. If distortion, cracks, nicks, or wear affect more than 10% of the stock, discard the unit.

TIE-DOWN BINDER CHAIN USE

Depending on the type of cargo you are securing, there are a variety of different factors that can affect the way you secure the load.

WHEN SECURING CARGO, IT IS IMPORTANT TO CONSIDER THE FOLLOWING:

- What is the gross weight of the load?
- What is the physical size of the load?
- Is the weight uniformly distributed?
- Is the cargo size uniform?

THE EFFECT OF ANGLE ON INDIRECT TIEDOWNS

You also need to consider the effect that angles will have on indirect tie downs. The chart below demonstrates how the effectiveness of the tie down is impacted by the angle at which it is used.

TIEDOWN TIGHTENED TO 1,000 LBS. OF TENSION

Angle	Effectiveness	Downward or Clamping Force	
90	100%	1,000 lbs	
60	85%	850 lbs.	
45	70%	700 lbs.	
30	50%	500 lbs.	
15	25%	250 lbs.	

THE ANGLE OF AN INDIRECT TIEDOWN SHOULD NEVER BE LESS THAN 30°

DETERMINING THE AGGREGATE WORKING LOAD LIMIT

When using multiple tie downs, you also need to determine the aggregate working load limit. **The aggregate working load limit of any securement system must be at least 50% of the weight of the cargo being secured with a length of less than 10 ft. (3 meters) & blocked from forward motion.** The diagram below illustrates how you would determine the aggregate working load limit when using multiple tie downs.

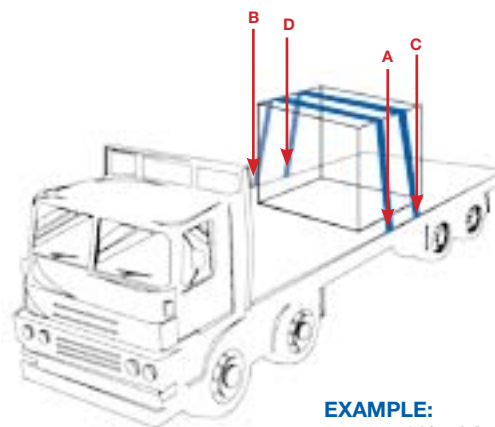

EXAMPLE:

- 50% of A
- + 50% of B
- + 50% of C
- + 50% of D

= Aggregate Working Load Limit

For full details on regulations and requirements for securing cargo, refer to FMCSA – Federal Motor Carrier Safety Administration Section(s) 393.100 through 393.136 of the FMCSA regulation handbook. Information is also available online at: <http://www.fmcsa.dot.gov>.



TRANSPORT (BINDING) CHAIN GRADE 70 STANDARD & SHORT LINK

WORKING LOAD LIMIT: 3,150 TO 11,300 LBS.

BENEFITS & FEATURES

- Do not use for overhead lifting
- High-carbon steel, heat treated
- Zinc plated with gold chromate finish
- Meets ASTM & NACM standards
- Meets FMCSA & CVSA requirements
- Thermal heat treated using advanced technology
- Heat treated for superior wear and toughness
- 100% proof tested
- Permanent identification on chain (embossed with G70, plus 3 letter trace code)
- Full weld trim
- Design factor 4:1

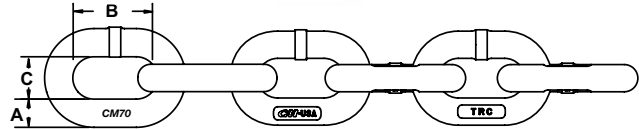

Chain Size (in.)	Working Load Limit (lbs.)	Nominal Chain Dimensions (in.)			Per Foot			Per Drum				Per Pail	
		Material Diameter A	Inside Length B	Inside Width C	Product Code	Weight (lbs./ft.)	Approximate Number of Links (per ft.)	Full Drum		Half Drum		Product Code	Length (ft.)
								Product Code	Length (ft.)	Product Code	Length (ft.)		
1/4	3,150	0.28	0.84	0.47	608927	0.76	14.30	678531	800	678521	400	678517	130
5/16	4,700	0.33	0.98	0.46	608935	1.01	12.20	678532	550	678522	275	678518	90
5/16**	4,700	0.33	1.10	0.50	609035	0.97	10.90	679032	550	679022	275	679018	90
3/8	6,600	0.39	1.14	0.54	608941	1.46	10.50	678533	400	678523	200	678519	60
3/8**	6,600	0.39	1.38	0.60	609041	1.37	8.73	679033	400	679023	200	679019	60
1/2	11,300	0.53	1.56	0.73	608954	2.70	7.70	678535	200	678525	100	-	-

** Standard Link Grade 70 Chain





WELDED ASSEMBLY GRADE 70

WORKING LOAD LIMIT: 4,700 TO 6,600 LBS.

BENEFITS & FEATURES

- Meets FMCSA, CVSA, DOT requirements
- Available in custom-built lengths
- Assemblies are available with your choice of mechanical or welded end attachments
- Welded assemblies are proof tested after welding.
- Full line of lever and ratchet binders to accommodate binder chain offering
- Gold Chromate per ASTM B633 Fe/ZN 13 Type II
- Design factor 4:1



► DID YOU KNOW?

INDUSTRY FOCUS: FARMING, TOWING & TRANSPORTATION

Grade 70 welded assemblies have a load rating around 20% higher than Grade 43 assemblies, so a smaller size assembly can be used for many jobs. Advantages include less weight, easier handling and more convenient storage, which is ideal for truckers, loggers and highway crews; for secure load binding and tie-downs; and for towing, hauling and lashing.

For more information, visit us at www.cmworks.com

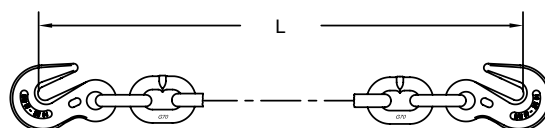

Chain Size (in.)	Working Load Limit (lbs.)	Length (L) (ft.)	Product Code	Product Code in Bag	Weight (lbs.)
Short Link					
5/16	4,700	14	–	638259	15.19
5/16	4,700	16	–	638264	17.20
5/16	4,700	20	638224	–	21.22
5/16	4,700	20	–	638302	21.22
5/16	4,700	25	638260	–	26.24
5/16	4,700	25	–	638306	26.24
3/8	6,600	20	638558	–	31.06
Standard Link					
5/16	4,700	16	639064	–	16.64
5/16	4,700	16	–	639064BG	16.64
5/16	4,700	20	639024	–	20.52
5/16	4,700	20	–	639024BG	20.52
5/16	4,700	25	639060	–	25.36
3/8	6,600	16	639089	–	23.75
3/8	6,600	20	639058	–	29.31



CLEVIS ASSEMBLY GRADE 70

WORKING LOAD LIMIT: 3,150 TO 11,300 LBS.

BENEFITS & FEATURES

- Hook on each end
- Meets all Department of Transportation (D.O.T.) requirements and is required in most states by the D.O.T.
- Chain won't degrade in ultra-violet light, as compared to nylon straps.
- Custom lengths available
- Gold Chromate per ASTM B633 Fe/ZN 13 Type II
- Design factor 4:1



Chain Size (in.)	Working Load Limit (lbs.)	Product Code	Product Code in Bag	L (ft.)	Weight (lbs.)
Short Link					
1/4	3,150	638265	-	20	16.41
5/16	4,700	638274	-	12	13.10
5/16	4,700	638282	638277	16	17.10
5/16	4,700	638283	-	18	19.12
5/16	4,700	638284	638266	20	21.13
5/16	4,700	638313	-	24	25.15
5/16	4,700	638279	638279BG	25	26.16
3/8	6,600	638291	-	14	22.23
3/8	6,600	638292	638268	16	25.19
3/8	6,600	638293	-	18	28.15
3/8	6,600	638294	638267	20	31.11
1/2	11,300	638350	-	20	56.93
Standard Link					
5/16	4,700	639082	-	16	15.60
5/16	4,700	639084	639084BG	20	20.40
5/16	4,700	639079	-	25	25.30
3/8	6,600	639091	-	14	21.00
3/8	6,600	639092	-	16	23.80
3/8	6,600	639093	-	18	26.60
3/8	6,600	639094	639094BG	20	31.16
3/8	6,600	639097	-	25	36.30

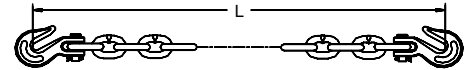

CLEVIS ASSEMBLY WITH IMPORT HOOKS GRADE 70

WORKING LOAD LIMIT: 4,700 TO 11,300 LBS.

BENEFITS & FEATURES

- Hook on each end
- Meets all Department of Transportation (D.O.T.) requirements and is required in most states by the D.O.T.
- Chain won't degrade in ultra-violet light, as compared to nylon straps.
- Custom lengths available
- Gold Chromate per ASTM B633 Fe/ZN 13 Type II
- Chain is made in the U.S.A.
- Design factor 4:1



Chain Size (in.)	Working Load Limit (lbs.)	Product Code	L (ft.)	Weight (lbs.)
Standard Link				
5/16	4,700	639032GGC20	20	20.30
5/16	4,700	639032GGC25	25	25.20
3/8	6,600	639038GGC20	20	29.20
3/8	6,600	639038GGC25	25	31.16
1/2	11,300	638350GGC20	20	55.50





RIVET ASSEMBLY GRADE 70

WORKING LOAD LIMIT: 4,700 TO 6,600 LBS.

BENEFITS & FEATURES

- Riveted hooks prevent loss or theft of hooks
- Gold Chromate per ASTM B633 Fe/ZN 13 Type II
- Design factor 4:1

Chain Size (in.)	Working Load Limit (lbs.)	Product Code	L (ft.)	Weight (lbs.)
Short Link				
5/16	4,700	638281CRV	14	15.10
5/16	4,700	638282CRV	16	17.10
5/16	4,700	638283CRV	18	19.10
5/16	4,700	638284CRV	20	21.10
3/8	6,600	638291CRV	14	22.22
3/8	6,600	638292CRV	16	25.18
3/8	6,600	638293CRV	18	28.14
3/8	6,600	638294CRV	20	31.10
Standard Link				
5/16	4,700	639084CRV	20	20.43
5/16	4,700	639079CRV	25	25.27
3/8	6,600	639094CRV	20	29.33

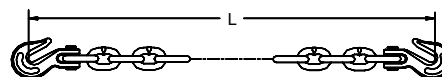

AIRCRAFT ASSEMBLY

MINIMUM BREAK STRENGTH: 14,100 LBS.

BENEFITS & FEATURES

- Meets MIL-DTL-6458E- Type I specifications
- 100% proof tested in accordance to MIL spec standards
- Gold chromate finish per ASTM B633 Fe/ZN 13 Type II
- Individually packaged assemblies available upon request
- Design factor 4:1

Chain Size (in.)	Minimum Break Strength (lbs.)	Product Code	L (ft.)	Weight (lbs.)
9/32	14,100	627728	9	7.17

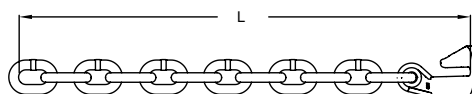



CLUSTER ASSEMBLY WITH GRAB, R HOOK & J/T COMBO GRADE 70

WORKING LOAD LIMIT: 4,700 LBS.

BENEFITS & FEATURES

- J/T combination hooks are ideal for applications that require you to hook to different vehicle models.
- Provides ease of use, eliminating the need for multiple attachments that could get in the way of hooks. Also reduces weight of assembly.
- Cluster is 100% proof tested at 2 times the working load limit and has a 4:1 design factor.
- All components are made in the USA.
- Yellow chromate finish meets ASTM B633 Fe/ZN 13 Type II.



Product Code	Working Load Limit (lbs.)	Weight Per Assembly (lbs.)
638317	4,700	2.7

CHAIN ASSEMBLY WITH J, GRAB & J/T COMBO GRADE 70



WORKING LOAD LIMIT: 4,700 LBS.

BENEFITS & FEATURES

- Assembly includes grab hook and J/T combo on one end with a 15" I-Beam J hook on the other end.
- Cluster is 100% proof tested at 2 times the working load limit and has a 4:1 design factor.
- All components are made in the USA.
- Yellow chromate finish meets ASTM B633 Fe/ZN 13 Type II.
- Short Link Grade 70 chain allows for better cornering and is only offered by Dixie Industries.
- Custom links available upon request.



Product Code	Working Load Limit (lbs.)	Chain Size (in.)	Chain Length (ft.)	Weight Per Assembly (lbs.)
638318	4,700	5/16	6	11.4
638323	4,700	5/16	10	15.4

CHAIN ASSEMBLY WITH GRAB, R & J/T COMBO GRADE 70



WORKING LOAD LIMIT: 4,700 LBS.

BENEFITS & FEATURES

- J/T combination is ideal for applications that require you to hook to different vehicle models for towing.
- Provides ease of use, eliminating the need for multiple attachments that could get in the way of hooks. Also reduces weight of assembly.
- Cluster is 100% proof tested at 2 times the working load limit and has a 4:1 design factor.
- Yellow chromate finish meets ASTM B633 Fe/ZN 13 Type II.



Product Code	Working Load Limit (lbs.)	Chain Size (in.)	Chain Length (ft.)	Weight Per Assembly (lbs.)
638324	4,700	5/16	6	8.8
638325	4,700	5/16	10	12.8



BRIDLE ASSEMBLY TOW TIGER WITH J & J/T COMBO GRADE 70

WORKING LOAD LIMIT: 4,700 LBS.

BENEFITS & FEATURES

- Assembly includes the patented Tow Tiger as top link with a J/T Combo and 15" J hook on the end of each leg.
- Tow Tiger gives the user a quick, easy way to shorten chain and eliminates hardware, reducing the weight of the assembly. Tow Tiger also provides greater flexibility for leg adjustment by only using one piece of chain.
- Assembly is 100% proof tested at 2 times the working load limit and has a 4:1 design factor.
- All components are made in the USA.
- Yellow chromate finish meets ASTM B633 Fe/ZN 13 Type II.
- Short Link Grade 70 chain allows for better cornering and is only offered by Dixie Industries.
- Custom lengths available upon request



Product Code	Working Load Limit (lbs.)	Chain Size (in.)	Chain Length (ft.)	Weight Per Assembly (lbs.)
638326	4,700	5/16	2	14.9
638327	4,700	5/16	3	16.9
638328	4,700	5/16	6	22.9
638329	4,700	5/16	8	26.9

BRIDLE ASSEMBLY TOW TIGER WITH R & J/T COMBO GRADE 70



WORKING LOAD LIMIT: 4,700 LBS.

BENEFITS & FEATURES

- Assembly includes the patented Tow Tiger as top link with a J/T Combo and 15" R hook on the end of each leg.
- Tow Tiger gives the user a quick, easy way to shorten chain and eliminates hardware, reducing the weight of the assembly. The Tow Tiger also provides greater flexibility for leg adjustment by only using one piece of chain.
- Assembly is 100% proof tested at 2 times the working load limit and has a 4:1 design factor.
- All components are made in the USA.
- Yellow chromate finish meets ASTM B633 Fe/ZN 13 Type II.
- Short Link Grade 70 chain allows for better cornering and is only offered by Dixie Industries.
- Custom lengths available upon request



Product Code	Working Load Limit (lbs.)	Chain Size (in.)	Chain Length (ft.)	Weight Per Assembly (lbs.)
638330	4,700	5/16	2	7.86
638331	4,700	5/16	3	9.87
638332	4,700	5/16	6	15.90
638333	4,700	5/16	8	19.92



“J” HOOK

WORKING LOAD LIMIT: 3,000 TO 5,400 LBS.

BENEFITS & FEATURES

- “I-Beam” construction offers greater strength with less weight and a wider bowl for stability
- Larger tip to help prevent hook from tip loading or slipping off
- Forged in USA
- Available in self colored, zinc plated, yellow chromate, and powder coated finishes
- Design factor 4:1 (Grade 70)
- Design factor 3:1 (Grade 43 & Clevis Type)
- **Not for overhead lifting**



Forged 8" “J” Hook



Forged 15" “J” Hook



Clevis Type “J” Hook

Size (in.)	Use With	Working Load Limit (lbs.)	Standard Package	Product Code	Finish	Weight (lbs.)
Grade 70						
8	Sports Car	5,400	10	91255	Black	2.2
8	Sports Car	5,400	10	91259	Yellow Chromate	2.2
15	Standard	5,400	10	92855	Black	3.3
15	Standard	5,400	10	92859	Yellow Chromate	3.3
Grade 43						
8	Sports Car	3,900	10	92150	Self Colored	2.2
8	Sports Car	3,900	10	92151	Yellow Chromate	2.2
15	Standard	3,900	10	92180	Self Colored	3.3
15	Standard	3,900	10	92181	Yellow Chromate	3.3
Clevis Type						
7/8 x 8	Sports Car	3,000	10	90243	Zinc Plated	2.1
7/8 x 8	Sports Car	3,000	10	90242	Self Colored	2.1
7/8 x 15	Standard	3,000	10	90283	Zinc Plated	3.1
7/8 x 15	Standard	3,000	10	90282	Self Colored	3.1

RECOVERY “J” HOOK ASSEMBLIES GRADE 70

WORKING LOAD LIMIT: 7,100 LBS.

BENEFITS & FEATURES

- Patented I-Beam 15" “J” Hook with Clevlok® head with no catch points.
- Patented nose design reduces hook slippage on chain.
- Load rest reduces load rolling out of hook bowl (load must be behind rest).
- Designed for professional towing operations.
- All mechanical connections. No welded links.
- Design factor 4:1

Product Code	Working Load Limit (lbs.)	Size (in.)	Chain Length (ft.)	Description	Weight (lbs.)
97901G8	7,100	3/8	10	15" J Hook & Master Link	21.41





FORGED R, T & MINI J HOOKS GRADE 70

WORKING LOAD LIMIT: 4,700 LBS.

Forged “R”, “T” and Mini “J” Hooks are used for towing and auto tie-downs. Each hook has a different design, giving you the option to secure various models of automobiles with only these hooks.

BENEFITS & FEATURES

- Designed for use in towing or auto tie-downs
- Available in yellow chromate, self-colored & zinc finishes
- Forged from superior steel
- Design factor 4:1

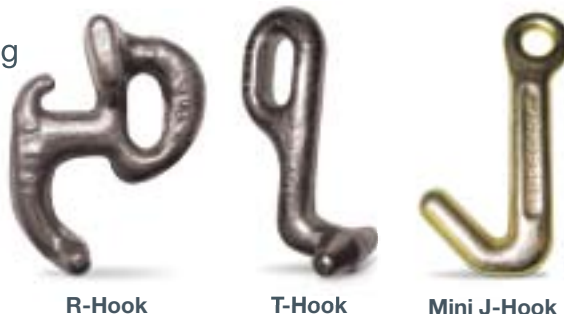

R-Hook

T-Hook

Mini J-Hook

Type	Working Load Limit (lbs.)	Standard Package	Finish	Product Code	Dimensions (in.)						Weight (lbs.)
					A	B	C	D	E	F	
R-Hook	4,700	10	Self-Colored	93424	2.63	3.25	1.50	1.13	0.50	-	0.64
R-Hook	4,700	10	Zinc	93423							
T-Hook	4,700	10	Self-Colored	93406	2.54	4.00	1.64	0.55	0.62	-	0.62
T-Hook	4,700	10	Zinc	93405							
Mini J-Hook	4,700	10	Zinc	92711	4.84	2.75	0.63	0.38	1.30	0.55	0.60
Mini J-Hook	4,700	10	Yellow Chromate	92714							

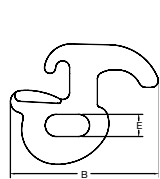

R-Hook

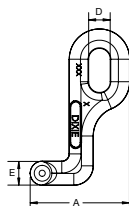
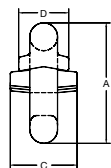

T-Hook

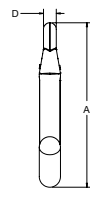
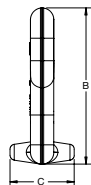

Mini J-Hook

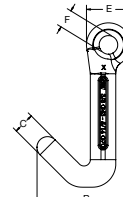

PEAR LINKS

WORKING LOAD LIMIT: 2,900 TO 10,800 LBS.



Pear Links are used as a top link for attaching chain slings to crane hooks, winches or hoists. Typically used in the towing industry as a top link from the tow truck winch to attach bridle assemblies.

BENEFITS & FEATURES

- Designed for use in towing & general industry
- Yellow chromate finish for superior corrosion protection
- Forged from superior steel
- Design factor 6:1

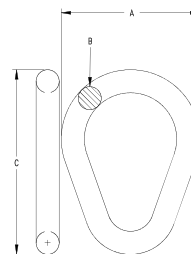

Size (in.)	Working Load Limit (lbs.)	Standard Package	Finish	Product Code	Dimensions (in.)			Weight (lbs)
					A	B	C	
1/2	2,900	10	Self Colored	93220	3.00	0.50	4.00	0.55
5/8	4,200	10	Self Colored	95660	3.81	0.63	5.05	1.20
5/8	4,200	10	Yellow Chromate	95664	3.81	0.63	5.05	1.20
3/4	6,000	10	Self Colored	95671	4.53	0.76	6.03	1.95
1	10,800	10	Self Colored	95675	6.00	1.00	8.00	4.30



DOUBLE CLEVIS (MID-LINK)

WORKING LOAD LIMIT: 4,700 TO 13,000 LBS.

Designed for use with Grade 70 chain as a quick and easy temporary repair.

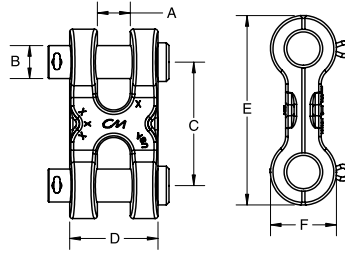

BENEFITS & FEATURES

- Zinc-plated finish
- Size forged into link
- Quick easy installations
- Design factor 4:1

For Chain Size (in.)	Working Load Limit (lbs.)	Standard Package	Product Code	Dimensions (in.)						Weight (lbs.)
				A	B	C	D	E	F	
1/4 and 5/16	4,700	10	M605	0.43	0.38	1.70	1.12	2.61	0.91	0.35
3/8	6,600	10	M606	0.50	0.38	2.00	1.31	3.06	1.09	0.46
7/16 and 1/2	11,300	5	M608	0.66	0.59	2.59	1.74	3.90	1.31	1.10
5/8	13,000	5	M610	0.75	0.75	2.81	2.01	4.31	1.50	1.70

NOTE: 1/4" through 1/2" sizes are individually bagged





CLEVIS GRAB HOOK GRADE 80

WORKING LOAD LIMIT: 3,500 TO 18,100 LBS.

BENEFITS & FEATURES

- Not recommended for overhead lifting
- Quenched and tempered alloy steel
- Durable orange powder coated finish
- Design factor 4:1

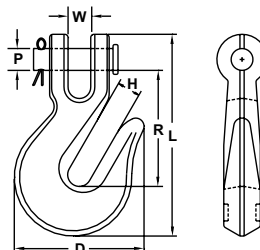

Size (in.)	Working Load Limit (lbs.)	Standard Package	Product Code	Dimensions (in.)						Weight (lbs.)
				W	D	H	L	R	P	
1/4	3,500	30	M804A	0.31	2.06	0.38	3.32	1.88	0.33	0.56
5/16	4,500	30	M805A	0.38	2.57	0.44	4.08	2.34	0.39	0.88
3/8	7,100	30	M806A	0.46	2.66	0.50	4.50	2.64	0.50	1.10
7/16	6,900	20	M807A†	0.51	2.94	0.57	5.02	3.00	0.50	1.50
1/2	12,000	10	M808A	0.59	3.38	0.68	5.64	3.31	0.59	2.36
5/8	18,100	10	M810A	0.75	4.31	0.81	6.86	3.95	0.75	4.00

† Hook is marked Grade 63

CLEVIS GRAB HOOK GRADE 70

WORKING LOAD LIMIT: 4,700 TO 6,600 LBS.



BENEFITS & FEATURES

- Designed specifically for transport Grade 70 chain
- Design factor 4:1
- Yellow chromate finish
- Not recommended for overhead lifting

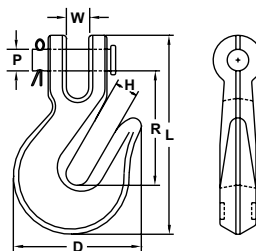

Size (in.)	Working Load Limit (lbs.)	Standard Package	Product Code (Yellow Chromate)	Dimensions (in.)						Weight (lbs.)
				W	D	H	L	R	P	
5/16	4,700	10	62273	0.42	2.40	0.44	3.52	2.18	0.38	0.75
3/8	6,600	10	62373	0.52	2.94	0.54	4.17	2.53	0.44	1.10



EYE GRAB HOOK GRADE 80

WORKING LOAD LIMIT: 3,600 TO 18,100 LBS.

BENEFITS & FEATURES

- Quenched and tempered alloy steel
- Durable orange powder coated finish
- Design factor 4:1
- **Not recommended for overhead lifting**

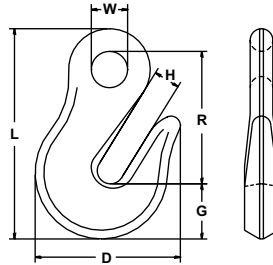

Size (in.)	Working Load Limit (lbs.)	Standard Package	Product Code	Dimensions (in.)							Weight (lbs.)
				W	D	H	L	R	G	Thickness	
1/4	3,600	30	M204A	0.55	2.00	0.38	3.22	2.05	0.80	0.59	0.44
5/16	4,500	30	M205A	0.63	2.41	0.44	3.78	2.41	1.00	0.69	0.69
3/8	7,200	30	M206A	0.80	2.65	0.50	4.34	2.80	1.06	0.83	1.00
7/16	6,900	20	M207A†	0.81	3.05	0.58	4.86	3.17	1.21	0.81	1.20
1/2	12,000	10	M208A	0.95	3.31	0.66	5.56	3.55	1.39	1.00	2.31
5/8	18,100	10	M210A	1.06	4.34	0.78	7.05	4.56	1.77	1.11	4.00

† Hook is marked Grade 63

EYE GRAB HOOK GRADE 70

WORKING LOAD LIMIT: 4,700 TO 6,600 LBS.



BENEFITS & FEATURES

- Designed specifically for transport Grade 70 chain
- Design factor 4:1
- Self-colored finish
- **Not recommended for overhead lifting**

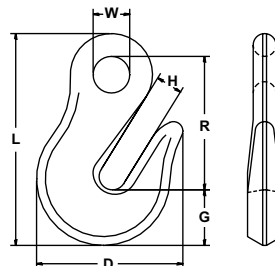

Size (in.)	Working Load Limit (lbs.)	Standard Package	Product Code (Self-Colored)	Dimensions (in.)						Weight (lbs.)
				W	D	H	L	R	P	
5/16	4,700	50	71297	0.70	2.39	0.49	3.69	2.42	1.15	0.75
3/8	6,600	25	71397	0.67	2.65	0.51	3.73	2.45	1.16	1.10



CLEVIS SLIP HOOK GRADE 70

WORKING LOAD LIMIT: 4,700 TO 6,600 LBS.

BENEFITS & FEATURES

- Designed specifically for transport Grade 70 chain
- Design factor 4:1
- Hook embossed with trace code providing traceability throughout the manufacturing and testing process to heat of steel
- Durable orange powder coated finish

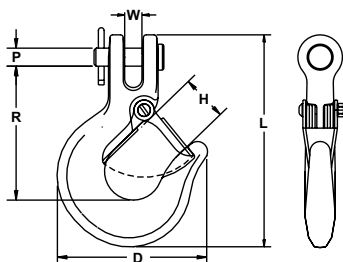

TRANSPORT CHAIN
& ATTACHMENTS

Size (in.)	Working Load Limit (lbs.)		Finish	Standard Package	With Latch		Without Latch		Latch Kit	Dimensions (in.)					
	Grade 63	Grade 70			Product Code	Weight (lbs.)	Product Code	Weight (lbs.)		Product Code	W	D	H	L	R
1/4	2,750	—	Orange Paint	20	—	—	M904A	.50	—	0.32	2.63	0.94	3.67	2.31	0.33
5/16	3,600	4,700	Orange Paint	20	6905AWL	.96	M6905A	.91	4X1304	0.36	3.27	1.06	4.62	2.89	0.38
5/16	3,600	4,700	Yellow Chromate	20	6905AZL	.96	M6905AZ	.91	4X1304	0.36	3.27	1.06	4.62	2.89	0.38
3/8	5,500	6,600	Orange Paint	20	6906AWL	1.66	M6906A	1.61	4X1305	0.45	3.87	1.00	5.42	3.39	0.49
3/8	5,500	6,600	Yellow Chromate	20	6906AZL	1.66	M6906AZ	1.61	4X1305	0.45	3.87	1.00	5.42	3.39	0.49
5/16	3,600	—	Orange Paint	20	—	—	M905A	.75	—	0.38	3.18	1.06	4.27	2.54	0.38
3/8	5,500	—	Orange Paint	20	—	—	M906A	1.25	—	0.45	3.66	1.25	4.88	3.02	0.49
7/16	6,900	—	Orange Paint	10	—	—	M907A	2.00	—	0.50	4.31	1.56	5.69	3.48	0.50
1/2	9,400	—	Orange Paint	10	—	—	M908A	2.80	—	0.59	4.88	1.75	6.41	4.00	0.59
5/8	14,200	—	Orange Paint	5	—	—	M910A	5.00	—	0.81	5.69	2.00	7.56	4.75	0.75

EYE SLIP HOOK GRADE 70

WORKING LOAD LIMIT: 3,150 TO 8,750 LBS.



BENEFITS & FEATURES

- Designed specifically for transport Grade 70 chain
- Design factor 4:1
- Hook embossed with trace code providing traceability throughout the manufacturing and testing process to heat of steel
- Durable orange powder coated finish

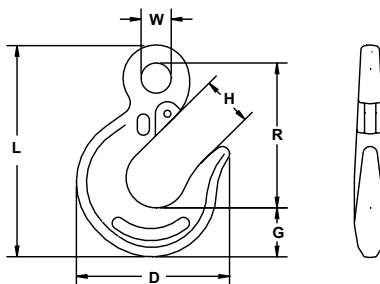

Size (in.)	Working Load Limit (lbs.)		Standard Package	Product Code			Dimensions (in.)						Weight (lbs.)
	Grade 63	Grade 70		With Latch	Without Latch	Latch Kit	W	D	H	L	R	G	
1/4	2,750	3,150	20	M6304WL	M6304	4X1302	0.55	2.69	0.87	3.80	2.62	0.87	0.45
5/16	3,600	4,700	20	M6305WL	M6305	4X405	0.63	3.18	1.01	4.41	3.01	1.03	0.58
3/8	5,500	6,600	20	M6306WL	M6306	4X406	0.80	3.74	1.17	5.38	3.73	1.25	1.40
7/16	7,100	8,750	10	M6307WL	M6307	4X410	0.83	4.34	1.42	5.79	3.93	1.38	1.50
1/2	9,400	—	10	—	M308A	—	0.95	4.94	1.76	6.33	4.31	1.50	2.30
5/8	14,200	—	5	—	M310A	—	1.19	5.63	2.00	7.67	5.29	1.69	3.77

GENERAL BENEFITS & FEATURES OF CM HEAVY-DUTY TIE-DOWNS

- Meets FMCSA, CVSA tie-down requirements
- Made from high quality alloy steel
- Made in USA
- Cannot be used for overhead lifting
- Lighter weight than most transport binder chains
- Does not degrade in ultra-violet light
- Permanent identification on chain and attachments
- Made to order assemblies available in 3 days or less
- Design factor 4:1

CLEVIS STYLE HEAVY-DUTY TIE-DOWNS
GRADE 80



WORKING LOAD LIMIT: 4,500 TO 12,000 LBS.

Chain Size (in.)	Chain Grade	Working Load Limit (lbs.)	Product Code	Length (L) (ft.)	Chain Finish	Weight (lbs.)
5/16	80	4,500	607031CV20	20	Black	19.60
5/16	80	4,500	607031CV25	25	Black	24.10
3/8	80	7,100	607037CV20	20	Black	30.30
3/8	80	7,100	607037CV25	25	Black	37.50
1/2	80	12,000	607050CV20	20	Black	54.60
1/2	80	12,000	607050CV25	25	Black	67.30

Design factor 4:1

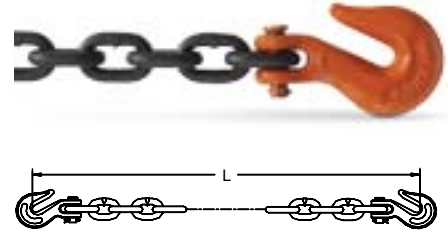

CLEVLOK® STYLE HEAVY-DUTY TIE-DOWNS GRADE 80 & 100



WORKING LOAD LIMIT: 7,100 TO 12,000 LBS.

Chain Size (in.)	Chain Grade	Working Load Limit (lbs.)	Product Code	Length (L) (ft.)	Chain Finish	Weight (lbs.)
3/8	80	7,100	607037CL20	20	Black	31.00
3/8	80	7,100	607037CL25	25	Black	38.00
1/2	80	12,000	607050CL15	15	Black	42.00
1/2	80	12,000	607050CL20	20	Black	55.00
3/8	100	8,800	607337CL20	20	Black	31.00
3/8	100	8,800	607337CL25	25	Black	38.50

Design factor 4:1

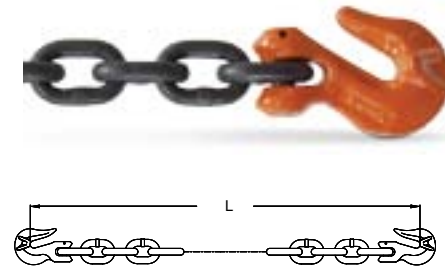

HEAVY DUTY RATCHET BINDERS
GRADE 80 & 100



WORKING LOAD LIMIT: 5,400 TO 16,000 LBS.

With Chain Size (in.)	Use With Chain Grade	Working Load Limit (lbs.)	Product Code	End Fittings	Take Up (in.)	Weight (lbs.)
5/16	80	5,400	48365	Hook & Hook	8	12
3/8	80	7,100	48360	Hook & Hook	8	13
3/8	80 or 100	9,200	48366	Hook & Hook	8	13
1/2	80	13,000	48367	Hook & Hook	8	16
1/2	80 or 100	15,000	48358	Hook & Hook	8	16
1/2	80 or 100	16,000	48387	Hook & Hook	8	16

Design factor 4:1

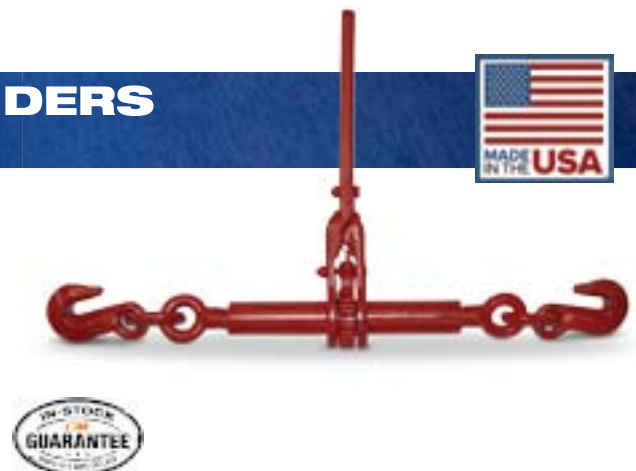



FORGED RATCHET LOAD BINDER

GRADES 30, 43, 70, 80, 100

WORKING LOAD LIMIT: 2,600 TO 16,000 LBS.

BENEFITS & FEATURES

- Handle is designed loose using self-locking, one-way bolts allowing easy removal of unwanted debris such as mud, snow or ice
- Proof tested to 50% of the minimum breaking strength
- Gears are permanently welded to the barrel
- Durable powder coated finish
- Design factor 4:1 (Except 48358 & 48387, which are 3:1)



Chain Grade & Size (in.)					Product Code	End Fittings	Standard Package	Working Load Limit (lbs.)	Take Up (in.)	Handle Length (in.)	Barrel Size O.D. (Diam. x Length) (in.)	Screw Diameter (in.)	Weight (lbs.)
G30	G43	G70	G80	G100									
3/16 & 1/4	1/4	–	–	–	48364	Hook / Hook	4	2,600	4	12	1-5/16 x 6	5/8	5.4
–	–	–	–	–	48811	Eye / Eye (no hook)	4	5,400	8.5	12	1-5/16 x 10	3/4	8.6
–	–	–	–	–	48363	Eye / Eye (no hook)	4	13,000	8	14	1-1/2 x 10	1	9.8
5/16 & 3/8	5/16 & 3/8	5/16	–	–	46565	Body Only	4	5,400	8	–	1-1/2 x 10	1	11.0
3/8 & 1/2	3/8 & 1/2	3/8	–	–	46566	Body Only	4	9,200	8	–	1-1/2 x 10	1	11.7
–	–	–	–	–	46565H	Handle Only	4	–	–	14	–	–	4.3
5/16 & 3/8	5/16 & 3/8	5/16	–	–	48810	Hook / Hook	4	5,400	8.5	12	1-5/16 x 10	3/4	8.6
5/16 & 3/8	5/16 & 3/8	5/16 & 3/8	5/16 & 3/8	–	48360	Hook / Hook	4	7,100	8	14	1-1/2 x 10	1	13.0
5/16 & 3/8	5/16 & 3/8	5/16	5/16	–	48365	Hook / Hook	4	5,400	8	14	1-1/2 x 10	1	12.0
3/8 & 1/2	3/8 & 1/2	3/8	3/8	–	48366	Hook / Hook	4	9,200	8	14	1-1/2 x 10	1	13.0
1/2 & 5/8	1/2 & 5/8	1/2	1/2	–	48367	Hook / Hook	4	13,000	8	14	1-1/2 x 10	1	16.0
–	3/8 & 1/2	3/8 & 1/2	3/8 & 1/2	3/8	48458	Hook / Hook	4	12,000	8	14	1-1/2 x 10	1	13.0
–	5/16 & 3/8	5/16 & 3/8	5/16 & 3/8	5/16 & 3/8	48455	Hook / Hook	4	8,800	8	14	1-1/2 x 10	1	16.0
3/8 & 1/2	3/8 & 1/2	3/8 & 1/2	3/8 & 1/2	3/8 & 1/2	48358	Hook / Hook	4	15,000	8	14	1-1/2 X 10	1	16.0
3/8 & 1/2	3/8 & 1/2	3/8 & 1/2	3/8 & 1/2	3/8 & 1/2	48387	Hook / Hook	4	16,000	8	14	1-1/2 X 10	1	16.0

REMOVABLE HANDLE LOAD BINDER GRADES 30, 43, 70



WORKING LOAD LIMIT: 5,400 TO 9,200 LBS.

BENEFITS & FEATURES

- Removable handle provides greater load security by making it less likely for load to be stolen
- Reduces overall weight
- Durable powder coated finish
- Design factor 4:1

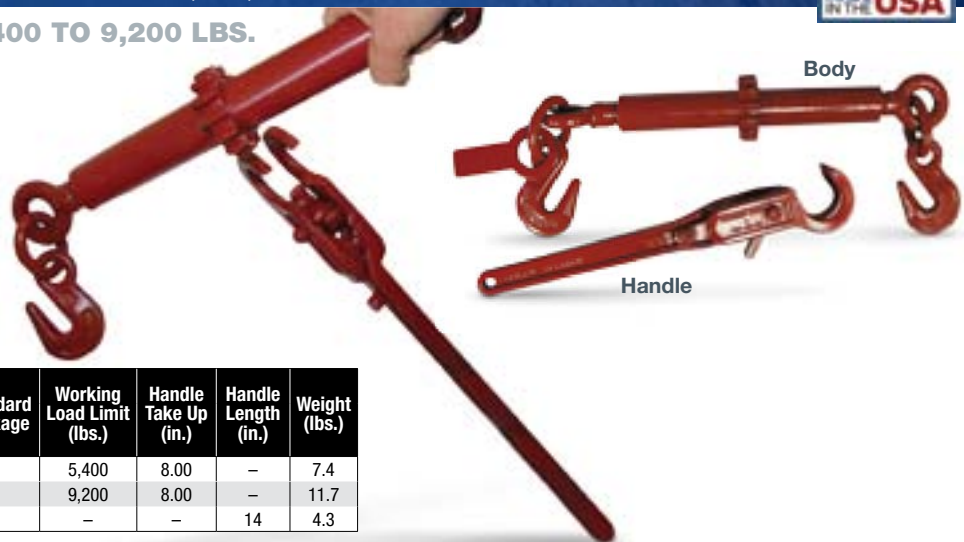

Size (in.)			Product Code	Standard Package	Working Load Limit (lbs.)	Handle Take Up (in.)	Handle Length (in.)	Weight (lbs.)	
G30	G43	G70							
3/8	3/8	5/16	46565	Body	4	5,400	8.00	–	7.4
1/2	1/2	3/8	46566	Body	4	9,200	8.00	–	11.7
–	–	–	46565H	Handle	4	–	–	14	4.3



FORGED LEVER LOAD BINDER GRADES 30, 43, 70, 80

WORKING LOAD LIMIT: 2,600 TO 9,200 LBS.

BENEFITS & FEATURES

- All components are forged, not cast
- Forged binders are lighter and stronger than cast binders
- Under equal force a forged handle will yield and bend while a cast handle may break
- Design factor 4:1



Chain Grade & Size (in.)				Product Code	Working Load Limit (lbs.)	Handle Take Up (in.)	Handle Length (in.)	Weight (lbs.)
G30	G43	G70	G80					
1/4	1/4	–	–	48304	2,600	3.75	11.25	3.0
3/8	3/8	5/16	–	48305	5,400	4.50	16.12	8.1
1/2	1/2	3/8	–	48306	9,200	4.75	16.62	10.6
3/8	3/8	3/8	3/8	48769	7,100	4.50	16.62	8.1



SPECIALTY FORGED LEVER LOAD BINDER GRADES 30, 43, 70

WORKING LOAD LIMIT: 5,400 LBS.

BENEFITS & FEATURES

- Durable powder coated finish, design factor 4:1
- **DIXI-LOC BINDERS** provide extra security by allowing the binder to be locked in closed position using a pad lock, linchpin or bolt.
- **COMPRESSION BINDERS** are designed for securing bar and rod steel, lumber, poles and machinery with rubber tires.
- **EZ GRAB BINDERS** are military style binders designed to use handle leverage to remove slack from the chain before hook-up, achieving correct tension on the first try.



Compression Binders

Binder Type	Description	Chain Grade & Size (in.)			Product Code	Standard Package	Working Load Limit (lbs.)	Take Up (in.)	Handle Length (in.)	Weight (lbs.)
		G30	G43	G70						
Dixi-Loc Binder	Lockable	3/8	3/8	5/16	48385	4	5,400	4.50	16.62	8.50
Compression Binder	Metal Spring	3/8	3/8	5/16	48395	4	5,400	4.50	16.62	14.60
EZ Grab Binder	Lever	3/8	3/8	5/16	48325	4	5,400	4.50	18.38	8.75

▶ INSPECTION, CARE & USE

LOAD BINDER OPERATING INSTRUCTIONS

1. Follow D.O.T. Federal Motor Carrier Safety Regulations S 392.9, S 393.100, and S 393.102
2. Inspect before use. Replace worn and deformed binders. Lubricate pivot and swivel points for optimum performance.
3. Do not operate with anyone on load.
4. Always apply lever binder in straight line hook-to-hook manner without bending and such that handle goes down when securing load.
5. Tighten binders before moving and recheck frequently.
6. Do not exceed working load limit shown on binder – hand effort will tighten binder to working load limit.
7. Do not use cheater bar or handle extension as their use can overload binder system and result in injury.
8. Secure handle down with a positive retaining method.
9. Release handle/load with extreme care. Make sure everyone is clear. Lever binder handle can snap back over center. Use open palm under handle and push up.

For more information, visit us at www.cmworks.com

⚠ WARNING

Load binder systems store energy which can release suddenly. To avoid injury:

- ▲ Operate only by hand from a firm standing position.
- ▲ Operate handle cautiously.
- ▲ Stay clear of handle path; handle may release suddenly.
- ▲ Follow manufacturer's instructions.



E-Z PRO® CAM RELEASE LEVER BINDER GRADES 30, 43, 70

WORKING LOAD LIMIT: 5,400 TO 9,200 LBS.

Effortlessly release this load binder without using any tools or prying – all it takes is one finger. Due to its unique design, the binder’s handle releases the load at the same point every time – when the handle is perpendicular to the body of the binder. Low-energy release prevents the binder from snapping back over center.

BENEFITS & FEATURES

- Binder releases effortlessly without the use of any tools or prying
- Free turning, 360° continuous swivel action in both tongue and clevis for enhanced straight line pull.
- Highly visible, durable yellow powder coated finish
- Design factor 4:1



48405: 5,400 lb. Working Load Limit



48406: 9,200 lb. Working Load Limit



Chain Grade & Size (in.)			Product Code	Standard Package	Working Load Limit (lbs.)	Take Up (in.)	Handle Length (in.)	Weight (lbs.)
G30	G43	G70						
3/8	3/8	5/16	48405	4	5,400	4.75	16.62	9.0
1/2	1/2	3/8	48406	4	9,200	4.75	16.62	9.8

CMG RATCHET / LEVER BINDERS

WORKING LOAD LIMIT: 2,600 TO 8,800 LBS.

BENEFITS & FEATURES

- Forged components
- Durable powder coated finish
- Designed to meet CM requirements
- Design factor 3:1



Maximum Chain Size (Grade 70) (in.)	Description	Product Code	Working Load Limit (lbs.)	Handle Take Up (in.)	Handle Length (in.)	Weight (lbs.)
5/16 & 3/8	5/16" & 3/8" Ratchet Binder	48362CMG	8,800	8	14	13
1/4	5/16" Lever Binder	48304CMG	2,600	3	11.5	3.4
5/16	3/8" Lever Binder	48305CMG	6,600	4	16	8.8
5/16	3/8" Indirect Binder	48405CMG	5,400	8	15	9.0

Imported



D-RINGS & KEEPER LINKS

WORKING LOAD LIMIT: 1,200 TO 14,000 LBS.

D-Rings with weldable clips are designed for quick, easy attachment when securing loads.

BENEFITS & FEATURES

- Clips are designed for welding
- Self colored finish
- Links and rings are forged from superior steel
- Proper welding procedures should be followed for d-ring clips
- Design factor 5:1

Size (in.)	Description	Working Load Limit (lbs.)	Standard Package	Product Code	Dimensions (in.)			Weight (lbs)
					A	B	C	
D-Rings								
1 x 3 x 4	D-Ring	12,000	10	93200	3.00	4.00	1.00	3.40
1 x 3 x 3	D-Ring	12,000	10	92501	3.00	4.00	1.00	2.87
1	D-Ring Clip	—	10	93210	—	—	—	0.71
11/16 x 2-3/4 x 2-1/4	D-Ring	7,000	10	92505	2.75	2.25	0.69	1.21
1/2 x 1-1/2	D-Ring Clip	—	10	92504	—	—	—	0.77
3/8 x 1-3/4 x 1-3/4	D-Ring	1,200	10	95610	1.75	1.75	0.38	0.24
Keeper Links								
3/4 x 1.5 x 3.5	Keeper Link	14,000	10	37111	1.52	3.50	0.76	1.42

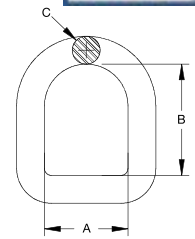

D-Ring with Clip (D-Ring and D-Ring Clip sold separately)

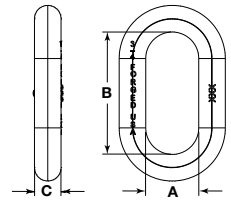

Keeper Link

SIXTH WHEEL RATCHET



BENEFITS & FEATURES

- Ergonomically reduces risk of injury when operating trailer landing gear
- Permits the operator to use an ergonomically-correct posture, utilizing body weight while reducing muscle exertion
- Preferred by 80% of drivers in actual use tests
- US Patent 7,021,659 stamped on all authentic Sixth Wheel units
- Designed to fit all standard gear
- Secured by a self-locking security pin and cap made of hardened steel that can only be removed by using heavy-duty shop equipment



THE SIXTH WHEEL VS. STANDARD CRANK

THE SIXTH WHEEL

Utilizes a ratcheting mechanism that allows the operator to exert more force while avoiding awkward and unsafe postures.



STANDARD CRANK

Requires a full-circle motion. This puts the operator in unsafe postures while exerting extremely high forces.



Product Code	Diameter (in.)	Length (A) (in.)
34902R082P	1	8
34902R132P	1	13
34902R202P	1	20

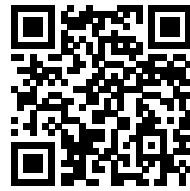

SEE THE SIXTH WHEEL RATCHET IN ACTION
SCAN THE QR CODE OR VISIT
<http://www.youtube.com/user/ColumbusMcKinnon>

HIGH TEST CHAIN GRADE 43

WORKING LOAD LIMIT: 2,600 TO 20,200 LBS.

Grade 43 chain, commonly called High Test, is manufactured to meet ASTM and NACM specifications. Typical uses include container securement, logging, towing, and marine industry. Grade 43 chain is available in many finishes and package configurations. It should not be used for overhead lifting.

BENEFITS & FEATURES

- Meets ASTM & NACM standards
- Available in a wide assortment of finishes including: self-colored and galvanized
- 50% stronger than Grade 30 chain
- Permanent identification on chain
- 100% proof tested
- Available in drums and multiple styles of assemblies
- Design factor 3:1

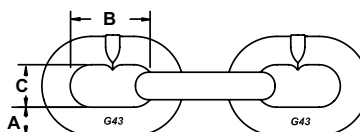

Chain Size (in.)	Working Load Limit (lbs.)	Nominal Chain Dimensions (in.)			Weight (lbs./ft.)	Approximate Number of Links (per ft.)	Self Colored Finish				Hot Dipped Galvanized Finish				
		Material Diameter A	Inside Length B	Inside Width C			Full Drum		Half Drum		Full Drum		Half Drum		
							Product Code	Length (ft.)	Product Code	Length (ft.)	Product Code	Length (ft.)	Product Code	Length (ft.)	
Import															
1/4	2,600	0.28	1.22	0.51	0.65	9.87	678141	800	678131	400	678341	800	-	-	
5/16	3,900	0.34	1.25	0.54	1.04	9.60	678142	550	678132	275	678342	550	-	-	
3/8	5,400	0.39	1.35	0.58	1.40	8.89	678143	400	678133	200	678343	400	678333	200	
North American															
1/2	9,200	0.50	1.73	0.81	2.27	6.93	678145	200	-	-	678345	200	-	-	
5/8	13,000	0.63	1.92	0.86	3.63	6.26	678146	150	678136	75	678346	150	-	-	
3/4	20,200	0.78	2.40	1.07	5.68	5.06	678147	100	678137	50	678347	100	-	-	

FINISHES: Self Colored, Galvanized

WELDED ASSEMBLY GRADE 43

WORKING LOAD LIMIT: 5,400 LBS.

BENEFITS & FEATURES

- Hook on each end (welded)
- Meets FMCSA, CVSA, NACM, & ASTM standards
- Available with welded style hooks
- Chain won't degrade in ultra-violet light, as compared to nylon straps.
- Various end attachments available
- Self-colored finish is standard (galvanized and zinc-plated also available)
- Custom lengths upon request
- Design factor 3:1

Chain Size (in.)	Working Load Limit (lbs.)	Product Code	L (ft.)	Finish	Weight (lbs.)
3/8	5,400	638240	16	Self Colored	22.70
3/8	5,400	638241	20	Self Colored	28.10

FINISHES: Self Colored, Zinc Plated, Galvanized

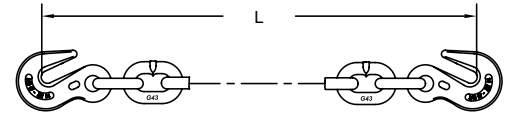

CLEVIS ASSEMBLY GRADE 43

WORKING LOAD LIMIT: 2,600 TO 9,200 LBS.

BENEFITS & FEATURES

- Hook on each end (clevis style)
- Meets FMCSA, CVSA, NACM, & ASTM standards
- Available in clevis style hooks
- Chain won't degrade in ultra-violet light, as compared to nylon straps.
- Various end attachments available
- Self-colored finish is standard (galvanized and zinc-plated also available)
- Custom lengths upon request
- Design factor 3:1

Chain Size (in.)	Working Load Limit (lbs.)	Product Code	L (ft.)	Finish	Weight (lbs.)
1/4	2,600	638010	10	Self Colored	6.50
5/16	3,900	608401	20	Self Colored	21.85
5/16	3,900	638025	25	Self Colored	27.05
3/8	5,400	638208	10	Self Colored	15.38
3/8	5,400	638215	12	Self Colored	18.20
3/8	5,400	638216	14	Self Colored	20.99
3/8	5,400	638217	16	Self Colored	23.80
3/8	5,400	638219	20	Self Colored	28.10
3/8	5,400	638220	25	Self Colored	36.43
1/2	9,200	638226	20	Self Colored	48.38

FINISHES: Self Colored, Zinc Plated, Galvanized

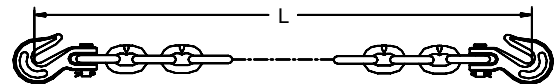

PROOF COIL CHAIN GRADE 30

WORKING LOAD LIMIT: 800 TO 10,600 LBS.

Grade 30 chain, commonly called Proof Coil, is manufactured to meet ASTM & NACM specifications. Typical uses include barrier chains, trailer safety chains, light construction, marine industry, etc. Grade 30 chain is available in a wide assortment of finishes and packaged configurations. It should not be used for overhead lifting.

BENEFITS & FEATURES

- Meets ASTM & NACM standards
- Available in a wide assortment of finishes including, Self-Colored, Zinc Plated, Galvanized, Powder Coated
- Permanent identification on chain (embossed with CM30)
- 100% proof tested
- Available in drums, pails and multiple styles of assemblies
- Design factor 4:1

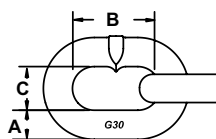

Chain Size (in.)	Working Load Limit (lbs.)	Nominal Chain Dimensions (in.)			Weight* (lbs./ft.)	Approximate Number of Links (per ft.)
		Material Diameter A	Inside Length B	Inside Width C		
3/16	800	0.22	0.97	0.45	0.40	12.4
1/4	1,300	0.28	1.22	0.51	0.65	9.9
5/16	1,900	0.33	1.27	0.60	0.98	9.5
3/8	2,650	0.39	1.35	0.58	1.40	8.9
1/2	4,500	0.50	1.73	0.81	2.27	6.9
5/8	6,900	0.63	1.92	0.86	3.63	6.3
3/4	10,600	0.78	2.40	1.07	5.68	5.0

Chain Size (in.)	Self-Colored Finish				Zinc Plated Finish						Hot Dipped Galvanized Finish					
	Full Drum		Half Drum		Full Drum		Half Drum		Pail		Full Drum		Half Drum		Pail	
	Product Code	Length (ft.)	Product Code	Length (ft.)	Product Code	Length (ft.)	Product Code	Length (ft.)	Product Code	Length (ft.)	Product Code	Length (ft.)	Product Code	Length (ft.)	Product Code	Length (ft.)
Import																
3/16	671040	850	-	-	671440	850	-	-	671410	250	671340	850	671394	500	-	-
1/4	671041	800	671091	400	671441	800	671491	400	671411	140	671341	800	671391	400	-	-
5/16	671042	550	671092	275	671442	550	671492	275	671412	90	671342	550	-	-	-	-
3/8	671043	400	671093	200	671443	400	-	-	671413	60	671343	400	671393	200	-	-
North American																
1/2	-	-	671045	200	671445	200	-	-	671415	40	671345	200	-	-	-	-
5/8	671046	150	-	-	-	-	-	-	-	-	671346	150	-	-	-	-
3/4	671047	100	-	-	-	-	-	-	-	-	671347	100	-	-	-	-

* Weight for Hot Dipped Galvanized Finish: Add 5% for sizes under 1/2", Add 2% for sizes over 1/2"

HANGER CHAIN GRADE 30

WORKING LOAD LIMIT: 1,300 LBS.

Hanger Chain is used for securement and attachment purposes in mines where a temporary connection is required.

BENEFITS & FEATURES

- Hooks are heat treated and tempered
- Design factor of 4:1 matching NACM specifications
- Hook embossed with trace code providing traceability through manufacturing and testing process to heat of steel
- Design factor 4:1
- Not to be used for overhead lifting

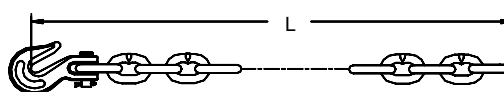

Chain Size (in.)	Working Load Limit (lbs.)	Product Code	L (ft.)	Finish	Weight (lbs.)
1/4	1,300	601710CMG	3	Self Colored	2.23
1/4	1,300	601711CMG	4	Self Colored	2.88
1/4	1,300	601712CMG	5	Self Colored	3.52
1/4	1,300	601714CMG	7	Self Colored	4.82



CLEVIS SLIP HOOK GRADE 30/43

WORKING LOAD LIMIT: 2,600 TO 13,000 LBS.

BENEFITS & FEATURES

- Heat-treated pins
- Hooks are heat treated and tempered
- Design factor 4:1 when used with Grade 30
- Design factor 3:1 when used with Grade 43
- When using these hooks with Grade 30 chain, the hooks must rated to the working load limit of the chain.
- Hook embossed with trace code providing traceability through manufacturing and testing process to heat of steel
- Zinc plated finish
- Not to be used for overhead lifting**

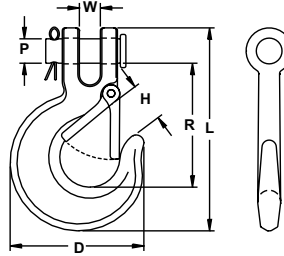

Size (in.)	Working Load Limit (lbs.)	Standard Package	Product Code				Dimensions (in.)						Weight (lbs.)
			Zinc Plated (without Latch)*	Zinc Plated (with Latch)	Latch Kit	W	D	H	L	R	P		
1/4	2,600	25	66193	66173	75199	0.35	2.33	0.72	2.27	2.32	0.31	0.35	
5/16	3,900	25	66293	66273	75199	0.42	2.65	0.86	4.13	2.59	0.38	0.63	
3/8	5,400	25	66393	66373	75299	0.50	3.20	1.01	4.81	3.04	0.44	1.02	
7/16	7,200	10	66493	66473	75299	0.58	3.91	1.02	5.56	3.50	0.50	1.56	
1/2	9,200	10	66593	66573	4X410	0.63	4.16	1.12	6.31	4.15	0.55	2.27	
5/8	13,000	5	M910Z	-	-	0.81	5.69	2.00	7.56	4.75	0.75	4.00	

* Hooks without latches are not designed for latches to be added.

EYE SLIP HOOK GRADE 30/43

WORKING LOAD LIMIT: 2,600 TO 20,200 LBS.



BENEFITS & FEATURES

- Hooks are heat treated and tempered
- Design factor 4:1 when used with Grade 30
- Design factor 3:1 when used with Grade 43
- When using these hooks with Grade 30 chain, the hooks must rated to the working load limit of the chain.
- Hook embossed with trace code providing traceability through manufacturing and testing process to heat of steel
- Not to be used for overhead lifting**

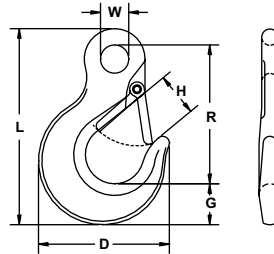

Size (in.)	Working Load Limit (lbs.)	Standard Package	Product Code				Dimensions (in.)						Weight (lbs.)	
			Self Colored (without Latch)*	Zinc Plated (without Latch)*	Zinc Plated (with Latch)	Latch Kit	W	D	H without latch	H with latch	L	R		G
1/4	2,600	50	-	75193	75143	75199	0.53	2.47	0.81	0.73	3.69	2.61	0.81	0.38
5/16	3,900	50	74294	75293	75243	75199	0.69	2.88	0.83	0.82	3.98	2.70	0.91	0.57
3/8	5,400	50	-	75393	75343	75299	0.78	3.25	0.92	0.93	4.11	3.17	1.13	0.83
7/16	7,200	10	-	75493	-	-	0.91	3.73	1.23	-	5.28	3.64	1.31	1.38
1/2	9,200	10	-	75593	75543	4X410	1.03	4.25	1.30	1.21	6.13	4.20	1.50	1.95
5/8	13,000	5	74694	75693	-	-	1.28	5.23	1.69	-	7.41	5.11	1.81	3.72
3/4	20,200	5	-	75793	-	-	1.53	6.28	2.45	-	8.88	6.00	2.34	3.72

* Hooks without latches are not designed for latches to be added.

FINISHES: Self Colored, Zinc Plated



CLEVIS GRAB HOOK GRADE 30/43

WORKING LOAD LIMIT: 2,600 TO 20,200 LBS.

BENEFITS & FEATURES

- Heat-treated pins
- Hooks are heat treated and tempered
- Design factor 4:1 when used with Grade 30
- Design factor 3:1 when used with Grade 43
- When using these hooks with Grade 30 chain, the hooks must be rated to the working load limit of the chain.
- Hook embossed with trace code providing traceability through manufacturing and testing process to heat of steel
- Not to be used for overhead lifting**

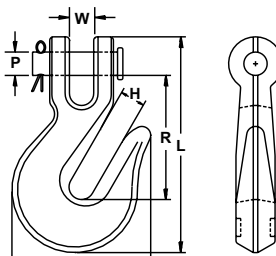

Size (in.)	Working Load Limit (lbs.)	Standard Package	Product Code		Dimensions (in.)						Weight (lbs.)
			Self Colored	Zinc Plated	W	D	H	L	R	P	
1/4	2,600	50	—	61193	0.36	2.05	0.37	2.88	1.57	0.31	0.37
5/16	3,900	50	—	61293	0.42	2.41	0.44	3.52	1.98	0.38	0.63
3/8	5,400	50	60392	61393	0.50	2.94	0.54	4.20	2.23	0.44	1.10
7/16	7,200	10	60492	61493	0.58	3.25	0.59	4.93	2.94	0.50	1.60
1/2	9,200	10	60592	61593	0.66	3.70	0.67	5.43	2.93	0.55	2.42
5/8	13,000	10	60692	61693	0.75	4.25	0.781	6.88	4.00	0.69	3.61
3/4	20,200	5	M812	M812Z	0.88	5.19	0.94	8.00	4.56	0.75	7.00

FINISHES: Self Colored, Zinc Plated

EYE GRAB HOOK GRADE 30/43

WORKING LOAD LIMIT: 2,600 TO 20,200 LBS.

BENEFITS & FEATURES

- Hooks are heat treated and tempered
- Design factor 4:1 when used with Grade 30
- Design factor 3:1 when used with Grade 43
- When using these hooks with Grade 30 chain, the hooks must be rated to the working load limit of the chain.
- Hook embossed with trace code providing traceability through manufacturing and testing process to heat of steel
- Zinc plated finish
- Not to be used for overhead lifting**

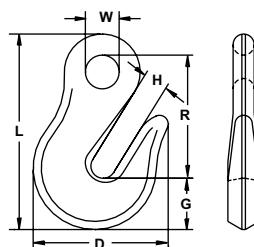

Size (in.)	Working Load Limit (lbs.)	Standard Package	Product Code	Dimensions (in.)						Weight (lbs.)
				W	D	H	L	R	G	
1/4	2,600	50	71193	0.47	1.78	0.35	2.85	1.78	0.81	0.30
5/16	3,900	50	71293	0.61	2.19	0.44	3.47	2.19	0.98	0.56
3/8	5,400	50	71393	0.82	2.86	0.49	4.13	2.69	1.14	0.87
7/16	7,200	10	71493	0.83	2.99	0.59	4.97	3.21	1.34	1.45
1/2	9,200	10	71593	0.93	3.34	0.67	5.38	3.40	1.50	2.17
5/8	13,000	5	71693	1.16	4.63	0.76	6.95	4.49	1.88	3.89
3/4	20,200	5	71793	1.38	5.50	0.98	8.28	5.35	2.28	6.12



WELD-ON GRAB HOOKS

WORKING LOAD LIMIT: 1,900 TO 4,500 LBS.

Weld-On Grab Hooks are designed to be welded onto equipment for a quick and easy chain attachment point.

BENEFITS & FEATURES

- Self-colored finish
- Forged from superior steel
- Grade and size forged into hooks
- Not for use in lifting applications

Type	Working Load Limit (lbs.)	Standard Package	Product Code	Dimensions (in.)					Weight (lbs)
				A	B	C	D	E	
5/16	1,900	10	90300	2.47	0.53	0.38	0.75	2.00	0.39
3/8	2,650	10	90304	3.00	0.70	0.51	0.81	2.40	0.89
1/2	4,500	10	90305	3.92	0.91	0.65	1.08	3.12	1.30

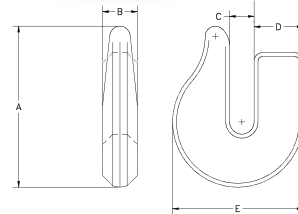

WELDLESS RINGS

WORKING LOAD LIMIT: 3,500 TO 10,000 LBS.

Weldless Rings are used for various applications in towing, farming, logging, and general industrial as an attaching point on equipment.

BENEFITS & FEATURES

- Excellent to use in combination with chain slings and shackles
- Available in various finishes including self-colored, painted or plated
- Forged from superior steel
- Size forged into rings
- Design factor 6:1 (except for 43709, which is 4:1)

Size (in.)	Inside Length (in.)	Working Load Limit (lbs.)	Standard Package	Product Code	Dimensions (in.)			Weight (lbs.)
					A	B	C	
1/2	2-1/2	3,500	12	43709	2.50	3.50	0.50	0.50
5/8	2-3/4	4,000	12	43809	2.75	4.00	0.64	0.79
3/4	3	6,000	12	43009	3.00	4.50	0.75	1.38
7/8	3-1/4	9,000	12	43109	3.28	5.00	0.91	2.08
1	4	10,000	12	43209	4.00	6.00	1.00	3.66

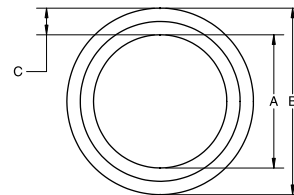

REPAIR LINKS / LAP LINK

SIZES: 1/4 IN. TO 1/2 IN.

Repair Links (Lap Links) are used for temporary, quick chain repair or for connecting low carbon chain to attachments.

BENEFITS & FEATURES

- Zinc-plated finish
- Easily assembled
- Available in various sizes
- Design factor 4:1
- **Do not use for overhead lifting**

Size (in.)	Inside Length (in.)	Standard Package	Product Code	Dimensions (in.)			Weight (lbs.)
				A	B	C	
1/4	1-1/4	50	84291	1.25	0.56	0.25	0.68
5/16	1-1/2	50	84591	1.50	0.75	0.31	0.13
3/8	2	50	84891	2.00	0.75	0.38	0.26
1/2	2-1/2	25	84991	2.50	1.00	0.50	0.53

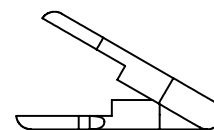
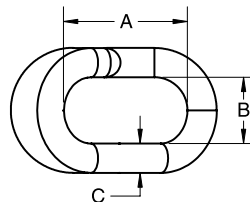

COLD SHUTS GRADE 30

WORKING LOAD LIMIT: 400 TO 3,700 LBS.

Cold Shuts are used for quick, temporary repairs of low carbon chain and to attach components to chain ends.

BENEFITS & FEATURES

- Zinc plated finish
- Quick installations
- Not to be used as a permanent repair of chains
- Design factor 4:1
- Do not use for overhead lifting

Size (in.)	Working Load Limit (lbs.)	Standard Package	Product Code	Dimensions (in.)					Weight (lbs.)
				A	B	C	D	E	
3/16	400	100	51091	0.44	0.95	0.45	0.20	0.18	0.03
1/4	800	100	51191	0.60	0.92	0.52	0.26	0.24	0.05
5/16	1,300	100	51291	0.76	1.17	0.66	0.33	0.31	0.11
3/8	1,900	100	51391	0.89	1.26	0.75	0.39	0.37	0.17
1/2	3,700	50	51591	0.90	1.71	1.03	0.52	0.49	0.28

Not to be used for load securement (tie down). 3/16" to 1/2" may be imported.
Working load limit does not meet NACM specifications for corresponding chain size.

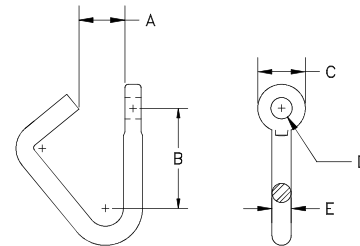

FORGED TRIANGLES ("D" RINGS)

WORKING LOAD LIMIT: 4,000 LBS.

Forged Triangles ("D" rings) are used as quick, easy attachment points for synthetic products used in towing, logging and general industry.

BENEFITS & FEATURES

- Forged from superior steel
- Fits up to 3" flat webbing
- Design factor 6:1

Size (in.)	Working Load Limit (lbs.)	Standard Package	Finish	Product Code	Dimensions (in.)				Weight (lbs)
					A	B	C	D	
3	4,000	10	Self Colored	90210	2.43	0.88	3.12	0.56	1.00

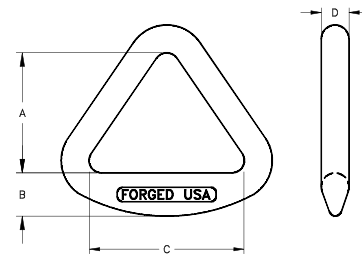



FORGED USA

JM



SPECIALTY CHAIN & COMPONENTS

Winch Line/Tail Chain	174
Straight Link Machine Chain	174
Straight Link Coil Chain	174
Sash Chain	175
Buoy Chain	175
Cast Drive Sprocket	176
Drive Sprocket - Replaceable Teeth	176
Long Wall Mining Chain	177
Padless Shackle Connectors	178
Special Chain Connector	179
Grinding Mill Liner Bolts	179



WINCH LINE / TAIL CHAIN GRADE 80

WORKING LOAD LIMIT: 18,100 TO 47,700 LBS.

BENEFITS & FEATURES

- Available in Grade 80
- Comprehensive product offering
- Odd number of links to prevent twisting of chain during hook up
- All assemblies are 100% proof tested
- Design factor 4:1

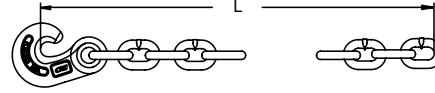

Chain Size (in.)	Working Load Limit (lbs.)	Product Code	Length (L) (in.)	Finish	Weight (lbs.)
5/8	18,100	695178	18	Black	8.16
3/4	28,300	695180	18	Black	13.64
7/8	34,200	695183	24	Black	19.44
1	47,700	695185	24	Black	24.46

STRAIGHT LINK MACHINE CHAIN

WORKING LOAD LIMIT: 215 TO 925 LBS.

BENEFITS & FEATURES

- Not for overhead lifting
- Meets ASTM A467 and NACM
- Zinc-plated finish
- Design factor 4:1

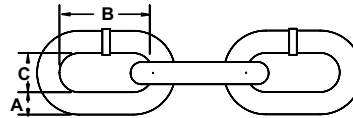

Trade Size	Size (in.)	Working Load Limit (lbs.)	Product Code	Feet per Carton	Weight per Carton (lbs.)	Nominal Chain Dimensions (in.)			Weight (lbs./ft.)	Approximate Number of Links (per ft.)
						Material Diameter A	Inside Length B	Inside Width C		
#4	1/8	215	621309	100	13.2	0.12	0.55	0.21	0.13	21.8
#3	9/64	270	621311	100	17.7	0.13	0.58	0.24	0.18	20.7
#2	5/32	325	621313	100	23.0	0.15	0.67	0.26	0.23	17.9
1/0	11/64	465	621317	100	23.3	0.19	0.75	0.30	0.23	16.0
2/0	3/16	545	621319	100	38.2	0.19	0.75	0.32	0.38	16.0
4/0	7/32	700	621321	100	45.6	0.22	0.98	0.41	0.46	12.2
5/0	1/4	925	621325	100	61.6	0.25	1.07	0.45	0.62	11.2

STRAIGHT LINK COIL CHAIN

WORKING LOAD LIMIT: 205 TO 880 LBS.

BENEFITS & FEATURES

- Not for overhead lifting
- Meets ASTM A467 and NACM
- Zinc-plated finish
- Design factor 4:1

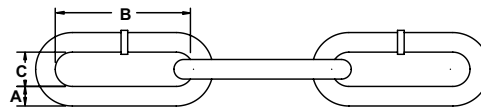

Trade Size	Size (in.)	Working Load Limit (lbs.)	Product Code	Feet per Carton	Weight per Carton (lbs.)	Nominal Chain Dimensions (in.)			Weight (lbs./ft.)	Approximate Number of Links (per ft.)
						Material Diameter A	Inside Length B	Inside Width C		
#4	1/8	205	620309	100	10.5	0.12	1.06	0.24	0.11	11.3
#3	9/64	255	620311	100	13.5	0.13	1.17	0.24	0.14	10.3
#2	5/32	310	620313	100	18.6	0.15	1.18	0.28	0.19	10.2
1/0	11/64	440	620317	100	28.1	0.19	1.25	0.33	0.28	9.6
2/0	3/16	520	620319	100	30.7	0.19	1.28	0.34	0.31	9.4
4/0	7/32	670	620321	100	39.6	0.22	1.39	0.43	0.40	8.6
5/0	1/4	880	620325	100	55.3	0.25	1.52	0.45	0.55	7.9

SPECIALTY CHAIN & COMPONENTS



SASH CHAIN

WORKING LOAD LIMIT: 75 TO 225 LBS.

Sash chain is typically used in pulley applications in windows and window sashes.

BENEFITS & FEATURES

- Not for overhead lifting
- Meets or exceeds ASTM & NACM standards where applicable
- Zinc-plated finish
- Custom cuts for OEM applications are available
- Design factor 4:1

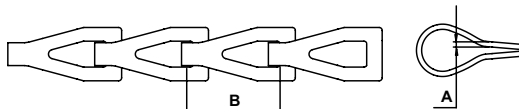

SPECIALTY CHAIN & COMPONENTS

Trade Size	Working Load Limit (lbs.)	Product Code	Quantity per Carton (ft.)	Weight per Carton (lbs.)	Nominal Chain Dimensions (in.)		Weight (lbs./ft.)	Approximate Number of Links (per ft.)
					Stock Thickness A	B		
8	75	683451	100	3.9	0.04	0.55	0.04	21.82
25	94	683452	100	4.9	0.04	0.55	0.05	21.82
30	81	683453	100	5.5	0.03	0.56	0.06	21.43
35	106	683454	100	5.9	0.04	0.56	0.06	21.43
40	131	683456	100	8.0	0.04	0.56	0.08	21.43
45	175	683457	100	9.5	0.05	0.56	0.10	21.43
50	225	683458	100	12.0	0.06	0.59	0.12	20.34

BUOY CHAIN

WORKING LOAD LIMIT: 15,000 TO 91,000 LBS.

For use on navigation markers for the U.S. Coast Guard, Public Works Canada and other navigation jurisdictions.

BENEFITS & FEATURES

- Not for overhead lifting
- Design factor 4:1

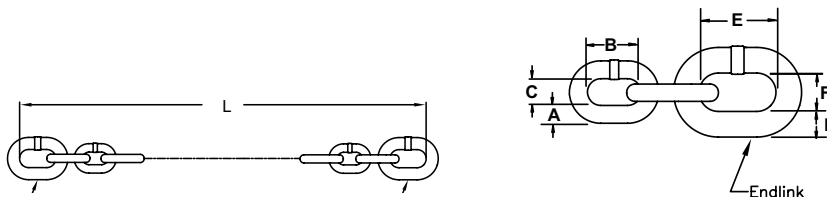

Chain Size (in.)	Minimum Breaking Strength (lbs.)	Product Code	L (ft.)	Chain Dimensions (in.)			Endlink Dimensions (in.)			Finish	Weight (lbs./shot)
				A	B	C	D	E	F		
1/2	15,000	6510049	90	0.50	3.00	1.88	0.75	4.50	2.69	Self Colored	196.00
1/2	15,000	6510048	45	0.50	3.00	1.88	0.75	4.50	2.69	Self Colored	99.26
3/4	32,000	6510050	90	0.75	4.50	2.69	0.88	5.25	3.13	Self Colored	431.66
3/4	32,000	6510051	45	0.75	4.50	2.69	0.88	5.25	3.13	Self Colored	215.66
1	58,000	4340890	90	1.00	6.00	3.56	1.00	6.00	3.56	Self Colored	760.50
1	58,000	4340890G	90	1.00	6.00	3.56	1.00	6.00	3.56	Hot Dipped Galvanized	760.50
1-1/8	77,000	4340990	90	1.13	6.75	4.00	1.13	6.75	4.00	Self Colored	961.20
1-1/4	91,000	4341090	90	1.25	7.50	4.44	1.25	7.50	4.44	Self Colored	1,186.20



CAST DRIVE SPROCKET

CM Sprockets are engineered products made of heat-treated steel for excellent wearability. Sprockets are available in various sizes and styles depending on your needs.

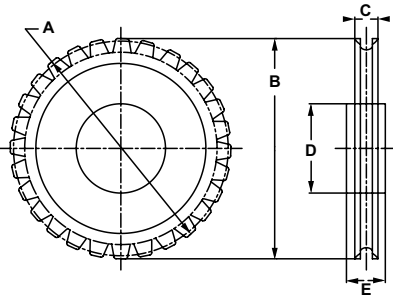

Chain Size (in.)	Number of Pockets	Dimensions (in.)					Weight (lbs.)
		A (Diameter)	B (Diameter)	C	D (Diameter)	E	
14 x 50	7	8.77	9.62	1.88	—	—	23.0
0.375 x 1.012	15	9.66	10.32	1.50	4.25	2.75	25.0
	20	12.89	13.52	1.50	4.50	2.75	38.0

DRIVE SPROCKET - REPLACEABLE TEETH

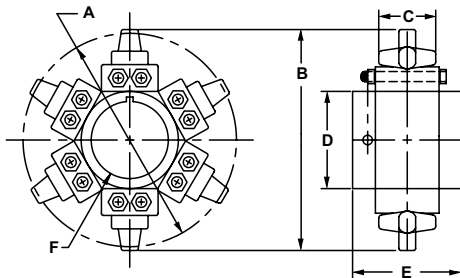

Chain Size (mm.)	Number of Teeth	Dimensions (in.)					
		A	B	C	D	E (Diameter)	F
14 x 50	6	7.52	8.19	1.69	3.25	3.50	2.19
14 x 50	16	20.05	21.35	1.69	6.00	3.50	2.44

MINING

To meet the specific needs of the mining industry, Columbus McKinnon Corporation manufactures high-strength mining chain and components for long wall applications. From chain to sprockets to connectors, we have the hardware to keep your product moving. Chain and components are all made by CM, assuring form and fit of each piece.

Combining the long wall product line with our other products, we have one of the most comprehensive offerings in the market for your mining applications.

LONG WALL MINING CHAIN



MINIMUM BREAK STRENGTH: 36,500 TO 191,300 LBS.

BENEFITS & FEATURES

- Available in carburized and through hardened
- CM carburized chain is processed with the latest technology to provide excellent strength and wear properties
- Chain is calibrated to assure fit when building assemblies
- Match pairs in various lengths are available
- All chain and components are built by CM to ensure form and fit
- Wide assortment of attachments to accommodate chain
- Design factor 4:1

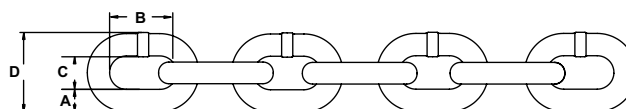

Chain Size (mm.)	Minimum Break		Product Code		Nominal Chain Dimensions (in.)				Finish	Weight (lbs./ft.)	Approximate Number of Links (per ft.)
	Carburized (lbs.)	Through Hardened (lbs.)	Carburized	Through Hardened	Material Diameter A	Inside Length B	Inside Width C	D			
14 x 50	36,500	56,200	695714C	695724	0.55	1.97	0.67	1.89	Self Colored	2.68	6.10
18 x 64	65,000	92,200	695717C	695718	0.70	2.52	0.83	2.36	Self Colored	4.23	4.76
22 x 86	75,000	137,200	695721C	695722	0.87	3.39	1.02	2.91	Self Colored	6.29	3.54
26 x 92	90,000	191,300	695727C	695729	1.00	3.62	1.18	3.39	Self Colored	8.53	3.31

► For more information on our mining product offering, visit us online at www.cmworks.com/mining





PADLESS SHACKLE CONNECTORS

BENEFITS & FEATURES

- Available in 1-bolt and 2-bolt configurations
- Specially forged for proper form and fit to CM Mining Chain
- Precision drilled for superb fitting

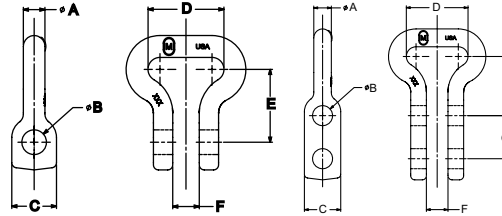

Chain Size (mm.)	Bolt Size	Product Code	Dimensions (in.)							Weight (lbs.)
			A	B	C	D	E	F	G	
1 Bolt										
14 x 50	5/8-11 UNC x 2-1/2" Gr-8	M14JL	0.56	0.69	1.16	1.97	1.89	0.69	-	0.50
18 x 64	5/8-11 UNC x 3" Gr-8	M18JL	0.72	0.69	1.26	2.52	2.00	0.78	-	1.31
22 x 86	7/8-9 UNC x 4" Gr-8	M22JL	0.88	0.97	2.00	3.39	2.94	1.14	-	0.50
26 x 92	1-8 UNC x 4-1/2" Gr-8	M26JL	1.06	1.06	2.25	3.62	3.50	1.12	-	1.31
2 Bolt										
14 x 50	5/8-11 UNC x 2-1/2 Gr-8	M14JL4	0.56	0.69	1.16	1.97	1.89	0.69	1.38	1.13
18 x 64	5/8-11 UNC x 3" Gr-8	M18JL4	0.72	0.64	1.26	2.52	2.00	0.78	1.75	2.13
22 x 86	5/8-11 UNC x 3-1/2" Gr-8	M22JL4	0.88	0.69	2.00	3.39	2.94	1.14	1.56	4.25
26 x 92	7/8-9 UNC x 4" Gr-8	M26JL4	1.06	0.94	2.25	3.62	3.75	1.12	2.38	7.63

SPECIAL CHAIN CONNECTOR



BENEFITS & FEATURES

- Specially forged for proper form and fit to CM Mining Chain
- Precision drilled for superb fitting



Chain Size (mm.)	Bolt Size (Gr-8) (in.)	Product Code	Dimensions (in.)							Weight (lbs.)
			A	B	C	D	E	F	G	
14 x 50	5/8-11 UNC x 2-1/2"	M14HC	1.19	3.74	5.88	0.64	0.76	0.50	0.56	0.63
18 x 64	5/8-11 UNC x 3"	M18HC4	1.41	4.44	9.44	0.64	1.00	0.72	1.62	1.88

GRINDING MILL LINER BOLTS

PROOF LOAD PSI: 33,000 TO 120,000 LBS.



BENEFITS & FEATURES

- After electric induction heating, bolt heads are forged from a selection of over 200 forging dies.
- Forged flashings are eliminated
- Bolts are heat treated in controlled atmosphere furnaces to meet precise “through hardening” specifications.
- Patented metal cup washer and seal system eliminates seepage from the shell bolt holes.
- Bolts are then tested for consistent quality before packing and shipping.
- Products are made-to-order as specials



SPECIALTY CHAIN & COMPONENTS

Lister Grade 1

Bolt Diameter (in.)	Proof Load PSI	Tensile Strength PSI min.	Recommended Torque*		
			UNC (ft./lbs.)	UNF (ft./lbs.)	8-UN (ft./lbs.)
3/4	55,000	74,000	190	213	0
7/8	33,000	60,000	194	214	0
1	33,000	60,000	291	318	291
1-1/8	33,000	60,000	412	462	427
1-1/4	33,000	60,000	581	644	600
1-1/4	33,000	60,000	1,012	1,138	1,074
1-3/4	33,000	60,000	1,596	1,840*	1,774
2	33,000	60,000	2,400	2,774*	2,659

Lister Grade 2

Bolt Diameter (in.)	Proof Load PSI	Tensile Strength PSI min.	Recommended Torque*		
			UNC (ft./lbs.)	UNF (ft./lbs.)	8-UN (ft./lbs.)
3/4	120,000	150,000	434	485	0
7/8	120,000	150,000	701	772	0
1	120,000	150,000	1,050	1,149	1,050
1-1/8	120,000	150,000	1,488	1,669	1,541
1-1/4	120,000	150,000	2,100	2,325	2,167
1-1/2	120,000	150,000	3,653	4,111	3,879

Lister Grade 5

Bolt Diameter (in.)	Proof Load PSI	Tensile Strength PSI min.	Recommended Torque*		
			UNC (ft./lbs.)	UNF (ft./lbs.)	8-UN (ft./lbs.)
3/4	85,000	120,000	307	343	0
7/8	85,000	120,000	496	546	0
1	85,000	120,000	743	813	743
1-1/8	74,000	105,000	927	1,040	960
1-1/4	74,000	105,000	1,308	1,449	1,350
1-1/2	74,000	105,000	2,276	2,561	2,417

ASTM-A449

Bolt Diameter (in.)	Proof Load PSI	Tensile Strength PSI minimum	Recommended Torque*	
			UNC (ft./lbs.)	UNF (ft./lbs.)
1-3/4	55,000	90,000	2,571	2,815
2	55,000	90,000	3,867	4,285

ASTM-A354

Bolt Diameter (in.)	Proof Load PSI	Tensile Strength PSI minimum	Recommended Torque*	
			UNC (ft./lbs.)	UNF (ft./lbs.)
Grade BC				
1-3/4	105,000	125,000	4,832	5,290
2	105,000	125,000	7,267	8,051
Grade BD				
1-3/4	120,000	150,000	5,763	6,309
2	120,000	150,000	8,667	9,603

* Torque values assume bolt is dry. Lubricants, painting, etc., can reduce these values.

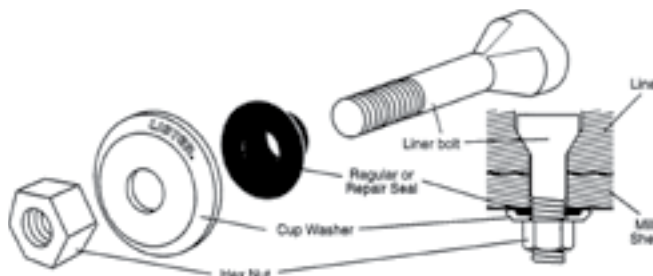



WILL 67/125

SH
CM

ENTERTAINMENT RIGGING PRODUCTS

S.T.A.C. Chain	182
S.T.A.C. Chain Sets	182
Theatrical Shackles	183





S.T.A.C. CHAIN

SPECIAL THEATRICAL ALLOY CHAIN

WORKING LOAD LIMIT: 6 TONS

Ideal for theatrical rigging applications where bridle adjustability is required

BENEFITS & FEATURES

SUPER STRENGTH

Grade 80 alloy material with 1/2" diameter and 6 ton working load limit

HEAT TREATED

Alloy steel provides long life

MEETS EUROPEAN STANDARDS FOR LONG LINK CHAIN

PROOF TESTED

Each link proof tested to assure weld and material integrity

FIRE & ABRASION RESISTANT

4:1 DESIGN FACTOR

POSITIVE AND EASY ID

Chain embossed with "STAC 8" and "CM USA" for easy identification as CM alloy. Also tagged with size, grade, reach and working load limit.

VERSATILITY

Link accepts up to 3/4" shackle for adjustability

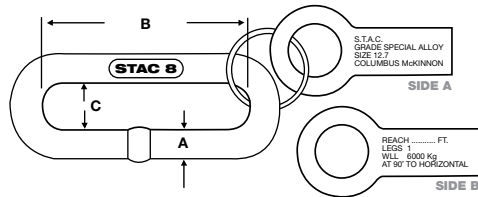

Chain Size (in.)	Working Load Limit (lbs.)	Nominal Chain Dimensions (in.)			Per Foot		Per Drum		
		Material Diameter A	Inside Length B	Inside Width C	Product Code	Weight (lbs./ft.)	Length (ft.)	Product Code	Weight (lbs.)
1/2	12,000	0.53	3.74	0.91	695550	2.03	250	695550D250	506.75
							500	695550D500	1,013.50

S.T.A.C. CHAIN SETS

SPECIAL THEATRICAL ALLOY CHAIN



BENEFITS & FEATURES

- Cut to desired length to meet your needs
- Each assembly tagged with reach and length
- Black finish
- Fits and functions with the CM line of black shackles
- Wide links allow for easy hook up



Chain Size (in.)	Length (ft.)	Cut Length Product Code	Weight (lbs.)
1/2	3	695575	6.70
	4	695576	9.94
	5	695577	11.96
	6	695578	13.99
	7	695579	16.01
	8	695580	18.03
	9	695581	20.05
	10	695582	22.07
	11	695583	24.10
	12	695584	26.12
	13	695585	28.14
	14	695586	30.16
	15	695587	32.18



THEATRICAL SHACKLES PAINTED BLACK

WORKING LOAD LIMIT: 1/2 TO 10 TONS

BENEFITS & FEATURES

- Manufactured from technically advanced micro alloy material
- Design factor 6:1
- Working Load Limit and traceability codes shown as permanent marking on body
- All shackles have alloy quenched and tempered pins
- Available in sizes 3/16" to 1"
- Available in black powder coated finish only
- Special testing and certification is available upon request at the time of the order



ENTERTAINMENT RIGGING PRODUCTS

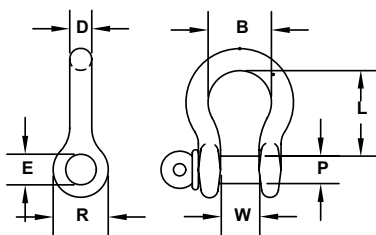

Size D (in.)	Working Load Limit (Ton)	Standard Package	Weight (lbs.)	Product Code	Dimensions (in.)					
					P	E	W	R	L	B min
3/16	1/2	50	0.06	M645B	0.25	0.29	0.38	0.57	0.88	0.58
1/4	3/4	50	0.12	M646B	0.31	0.36	0.47	0.75	1.13	0.75
5/16	1	50	0.20	M647B	0.38	0.45	0.53	0.84	1.25	0.81
3/8	1-1/2	50	0.30	M648B	0.44	0.52	0.66	1.00	1.40	1.00
7/16	2	50	0.50	M649B	0.50	0.58	0.72	1.15	1.69	1.19
1/2	3	50	0.75	M650B	0.63	0.70	0.84	1.34	1.94	1.38
5/8	4-1/2	25	1.30	M651B	0.75	0.83	1.06	1.66	2.41	1.63
3/4	6-1/2	10	2.30	M652B	0.88	0.95	1.28	1.94	2.84	1.89
7/8	8-1/2	10	3.50	M653B	1.00	1.09	1.44	2.14	3.31	2.06
1	10	5	5.00	M654B	1.13	1.22	1.72	2.44	3.75	2.52

POWER to PERFORM

For a complete listing of rigging products for the entertainment industry, visit us at www.cm-et.com



TO FASTEN CHAIN
PULL DOWN ON
LEVER

HAND OPERATED LEVER HOIST
WARNING TO PREVENT THE RISK OF FALLS
This device is designed for use as a hand-operated lever hoist. It is not to be used as a fall arrest device. The user must be trained in the proper use of this device. The user must always use proper fall protection techniques. The user must always use the correct chain and hook. The user must always use the correct load capacity. The user must always use the correct safety procedures. The user must always use the correct safety equipment. The user must always use the correct safety training. The user must always use the correct safety supervision. The user must always use the correct safety documentation. The user must always use the correct safety communication. The user must always use the correct safety coordination. The user must always use the correct safety cooperation. The user must always use the correct safety collaboration. The user must always use the correct safety partnership. The user must always use the correct safety alliance. The user must always use the correct safety coalition. The user must always use the correct safety confederation. The user must always use the correct safety federation. The user must always use the correct safety league. The user must always use the correct safety union. The user must always use the correct safety association. The user must always use the correct safety organization. The user must always use the correct safety institution. The user must always use the correct safety authority. The user must always use the correct safety body. The user must always use the correct safety organization. The user must always use the correct safety institution. The user must always use the correct safety authority. The user must always use the correct safety body.

PRODUCT SHOWCASE

HOISTS, TROLLEYS & BEAM CLAMPS

**ELECTRIC HOIST
MODEL COMPARISON** 186-187

**AIR HOIST
MODEL COMPARISON** 189

**LEVER HOIST
MODEL COMPARISON** 190-191

**HAND CHAIN HOIST
MODEL COMPARISON** 192-193

RATCHET LEVER HOISTS

CM Tornado 360° 194-197

CM Bandit 198-201

HAND CHAIN HOISTS

CM Hurricane 360° 202-203

CLAMPS

CTP Adjustable Trolley Clamp 204

CM Beam Clamp 205

Screwlok Beam Clamp with Shackle 206

SC Series Twin Beam Clamp 207

► To see our full line of hoists, trolleys & beam clamps,
visit us online at www.cmworks.com



ELECTRIC HOISTS

MODEL COMPARISON



CM
SHOPSTAR
Electric Chain Hoist



CM
SHOPSTAR VS
Electric Chain Hoist



CM
VALUSTAR
Electric Chain Hoist



COFFING
HOISTS
JLC
Electric Chain Hoist

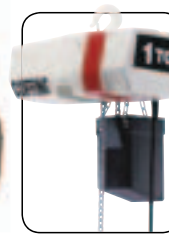

COFFING
HOISTS
EC
Electric Chain Hoist



CM
LODESTAR
Electric Chain Hoist

CAPACITY	Speed (fpm)	Reeving	Speed (fpm)	Reeving	Speed (fpm)	Reeving	Speed (fpm)	Reeving	Speed (fpm)	Reeving	Speed (fpm)	Reeving
250 lb.	16, 24, 40	1										
300 lb.	16, 24, 40	1										
500 lb.	8, 12, 16, 20, 24	1 & 2										
3/8 ton												
600 lb.	8, 12, 20	2										
3/4 ton												
1,000 lb.	6, 8, 12	2										
1/8 ton							32	1			32, 60	1
1/4 ton					16	1	16, 32	1	16, 32, 64	1	16, 32	1
1/2 ton					16	1	16, 32	1	9, 16, 32	1	8, 16, 32, 64	1 & 2
1 ton					8, 16	1 & 2	16	1	4, 8, 12, 16, 32, 48	1 & 2	8, 16, 32	1 & 2
2 ton					8	2	8	2	6, 8, 16, 24	1 & 2	8, 16	1 & 2
3 ton									5, 10, 16	2 & 3	5-1/2, 11	3
4 ton									8, 12	2		
5 ton									5, 8	3		
6 ton												
7-1/2 ton												
9 ton												
10 ton												
12 ton												
15 ton												

STANDARD FEATURES

Total Enclosed Non-Vented Motor	Standard				Standard		Standard		Standard		Standard	
Total Enclosed Fan Cooled Motor	N/A				N/A		N/A		ED Model Only		N/A	
Vane Motor												N/A
Adjustable Up/Down Limits	N/A				N/A		Standard		Standard		Standard	
Paddle Limits	N/A				N/A		N/A		N/A		N/A	
Weather Proofing	N/A				N/A		Weather-Resistant Cover		Weather-Resistant Cover		Standard	
Load Chain	Std. Unplated/Optional Plated				Unplated		Std. Unplated/Optional Plated		Std. Unplated/Optional Plated		Standard Zinc Plated	
Chain Container	Optional				Optional		Standard up to 20' Single Chain		Optional		Standard Fabric Bag	
Powder Coat Finish	Standard				Standard		N/A		N/A		Standard	
Variable Frequency Drive Versions	N/A				N/A		Standard Offering		Standard Offering		Standard Offering	
Two-Speed Version	N/A				N/A		Standard Offering		Standard Offering		Standard Offering	
Certification	CUL				N/A		CSA		CSA		CSA/US, TUV, CE, RoHS	
Motor Brake	DC				AC Caliper Style		AC Friction Disc		AC Friction Disc		DC Electric, Double Option	
Mechanical Load Brake	N/A				N/A		N/A		Standard		N/A	
Spark-Resistant Features	N/A				N/A		N/A		N/A		N/A	
Upper Suspension	Included				Included		Included		Included		Rigid Hook Standard	
Overload Clutch	Standard				Standard		Standard		Standard		Standard Out of Load Path	
Metric Rated	Standard				Standard		Optional		Optional		Standard	
Suspension Option	Hook and Lug				Hook and Lug		Hook and Lug		Hook and Lug		Hook and Lug	
Warranty	Lifetime				1 Year		Lifetime		Lifetime		Lifetime	

ELECTRIC HOISTS

MODEL COMPARISON



CM
CLASSIC LODESTAR
Electric Chain Hoist



CM
MAN GUARD
Electric Chain Hoist



BUDGIT
Hoists
MANGUARD
Electric Chain Hoist



CM
LODESTAR XL
Electric Chain Hoist



CM
POWERSTAR
Electric Chain Hoist

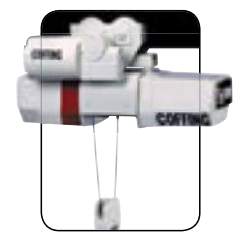

COFFING
HOISTS
WR
Electric Wire Rope Hoist

Speed (fpm)	Reeving	Speed (fpm)	Reeving	Speed (fpm)	Reeving	Speed (fpm)	Reeving	Speed (fpm)	Reeving	Speed (fpm)	Reeving
										10, 16, 21, 32	1, 2
32, 60	1										
16, 32	1	16, 32	1	16, 32, 64	1						
8, 16, 32, 64	1 & 2	16, 32	1	16, 32	1						
8, 16, 32	1 & 2	16, 32	1	8, 16, 32	1			20, 24, 32, 40, 48	1	10, 16, 28	1, 2
8, 16	2	8, 16	2	4, 8, 16	2	6, 8, 18, 24, 30	1	20, 24, 32, 40	1	14, 21	1, 2
5-1/2, 11	3	5, 10	3	5, 10	3	3, 4, 9, 12, 15	2	10, 12, 16, 20, 24	2	10, 14, 26	1, 2
						3, 4, 9, 12, 15	2	10, 12, 16, 20, 24	2		
						2, 2.7, 3, 6, 8, 9, 12, 15	2, 3	10, 12, 16, 20	2	16	2
						2.7, 2, 6, 8, 10	3	10, 12, 16, 20	2		
						2, 6, 10	3	7, 8, 11, 14, 16	3		
								7, 8, 11, 13	3		
								7, 8, 11, 13	4		
								5, 6, 8, 10	4		
								4, 5, 6, 8	5		

STANDARD FEATURES

Standard	Standard	Standard	Standard	Standard	Standard
N/A	N/A	N/A	N/A	N/A	N/A
N/A	N/A	N/A	N/A	N/A	N/A
Standard	N/A	N/A	Standard	Standard	Standard
N/A	Standard	Standard	N/A	N/A	N/A
Standard	N/A	Optional	Weather-Resistant Cover	Weather-Resistant Cover	Weather-Resistant Cover
Standard Zinc Plated	Std. Plated, 10, 15, 20' Lifts	Std. Unplated/Optional Plated	Unplated/Optional Plated	Unplated/Optional Plated	N/A
Optional	Standard up to 20' Lifts	Standard up to 28' Single Chain	Optional	Optional	N/A
Standard	Standard	Standard	Standard	Standard	N/A
Standard Offering	Standard 3-Step Infinite Var.	Standard Offering 2-Step	N/A	N/A	Standard Offering
Standard Offering	For 575V Only	Standard Offering	Optional	Optional	Optional
CSA, TUV, CE	CSA	CSA	N/A	N/A	N/A
AC Friction Disc	AC Friction Disc	AC Friction Disc	AC Friction Disc	AC Friction Disc	AC Friction Disc
N/A	N/A	Optional	N/A	N/A	N/A
N/A	N/A	N/A	N/A	N/A	N/A
Ordered Separately	Included	Included	Included	Included	Included
Standard in Gear Case	Standard	Standard	Standard	Standard	Standard
Standard	Standard	Optional	Standard	Most Models	N/A
Hook and Lug	Hook Only	Hook and Lug	Hook and Lug	Lug	Lug
Lifetime	Lifetime	Lifetime	Lifetime	Lifetime	Lifetime



AIR HOISTS

MODEL COMPARISON



SHOPAIR
Air Chain Hoist

Also available as:
BUDGIT 600
COFFING SLA



AIRSTAR
Air Chain Hoist

Also available as:
BUDGIT SERIES 2200
COFFING CAH (SMALL FRAME)
YALE YAL



AIRSTAR 6
Air Chain Hoist

Also available as:
BUDGIT SERIES 6000
COFFING CAH (LARGE FRAME)
YALE KALC



LODESTAR AIR XL
Air Chain Hoist

Also available as:
COFFING CXLA
YALE XL AIR

CAPACITY	Speed (fpm)	Reeving	Speed (fpm)	Reeving	Speed (fpm)	Reeving	Speed (fpm)	Reeving
250 lb.	31	1						
300 lb.	31	1						
500 lb.	21	1	65	1				
3/8 ton			60	1				
600 lb.	16	2						
3/4 ton			29	2				
1,000 lb.	11	2	45	1	16	1		
1/8 ton								
1/4 ton								
1/2 ton								
1 ton			23	2	8, 13, 30	1		
2 ton					5, 6, 15	2	31	1
3 ton					4, 10	3	21	2
4 ton								
5 ton							13	2
6 ton							10	3
7-1/2 ton							9	3
9 ton								
10 ton								
12 ton								
15 ton								

STANDARD FEATURES

Total Enclosed Non-Vented Motor	N/A		N/A		N/A		N/A	
Total Enclosed Fan Cooled Motor	N/A		N/A		N/A		N/A	
Vane Motor	Standard		Standard		Standard		Standard	
Adjustable Up/Down Limits	N/A		N/A		N/A		N/A	
Paddle Limits	N/A		Standard		N/A		N/A	
Weather Proofing	Standard		Standard		Standard		Standard	
Load Chain	Unplated/Optional Plated		Unplated/Optional Plated		Unplated/Optional Plated		Unplated/Optional Plated	
Chain Container	Optional		Optional		Optional		Optional	
Powder Coat Finish	Standard		Standard		Standard		Standard	
Variable Frequency Drive Versions	N/A		N/A		N/A		N/A	
Two-Speed Version	N/A		N/A		N/A		N/A	
Certification	N/A		N/A		N/A		N/A	
Motor Brake	Disc		Drum		Mechanical Load Brake		Disc	
Mechanical Load Brake	N/A		N/A		Standard		Standard	
Spark-Resistant Features	N/A		Optional		Optional		N/A	
Upper Suspension	Included		Included		Included		Included	
Overload Clutch	Standard		N/A		Standard		Standard	
Metric Rated	Standard		Standard		Standard		Standard	
Suspension Option	Lug and Hook		Lug and Hook		Lug and Hook		Lug and Hook	
Warranty	Lifetime		Lifetime		Lifetime		Lifetime	

LEVER HOISTS

MODEL COMPARISON



CM
SERIES 602 & 603
Mini Ratchet Lever Hoist

CM
BANDIT
Ratchet Lever Hoist

CM
TORNADO 360°
Ratchet Lever Hoist

CM
SERIES 653
Ratchet Lever Hoist

CM
SHORT HANDLE
Puller

CM
SERIES 640
Puller

CAPACITY (Ton)	Capacity	Reeving	Capacity	Reeving	Capacity	Reeving	Capacity	Reeving	Capacity	Reeving	Capacity	Reeving
1/4	✓	1										
1/2	✓	1										
3/4			✓	1			✓	1	✓	1	✓	1
1							✓	1				
1-1/2			✓	1			✓	1	✓	1	✓	1
2							✓	1				
3			✓	1			✓	2	✓	2	✓	2
4-1/2												
6			✓	2			✓	2			✓	4
9												
11												
13												
15												

FEATURES

Load Limiter			Optional						Optional		Optional	
Metal Housing	✓		✓				✓					
Aluminum Housing									✓		✓	
Free Chaining	✓		✓				✓		✓		✓	
Weston Brake	✓		✓				✓		✓		✓	
Ratchet & Pawl												
Standard Lifts (ft.)	5 & 10		5, 10, 15, 20				5, 10, 15, 20		5, 10, 20		5, 10, 15, 20	
Zinc-Plated Chain	✓		✓				✓					
Self-Colored Chain									✓		✓	
Metric Rated	✓						✓		✓		✓	
Warranty	Lifetime		Lifetime				5 Years		Lifetime		Lifetime	

OPTIONS

Bullard Hooks									✓		✓	
Latchlok Hooks									✓		✓	
Bronze Hooks									✓		✓	
Shipyards Hooks			✓				✓					
Extended Lifts			✓				✓		✓		✓	
Chainless Heads			✓				✓		✓		✓	
Zinc-Plated Chain									✓		✓	
Anchor Slings									✓		✓	
Load Sentry											✓	
Non-Free Chaining									✓		✓	
Spark Resistant									✓		✓	

LEVER HOISTS

MODEL COMPARISON



COFFING
HOISTS
PA
Ratchet Lever Hoist



COFFING
HOISTS
LSB
Ratchet Lever Hoist



COFFING
HOISTS
RA
Ratchet Lever Hoist



COFFING
HOISTS
G SERIES
Ratchet Lever Hoist



LITTLE MULE
**WIRE ROPE
PULLER**



LITTLE MULE
**LINEMAN'S
STRAP HOIST**

Capacity	Reeving	Capacity	Reeving	Capacity	Reeving	Capacity	Reeving	Capacity	Reeving	Capacity	Reeving
✓	1	✓	1	✓	1	✓	1	✓	1 & 2	✓	1 & 2
✓	1	✓	1	✓	1	✓	1	✓	1 & 2	✓	1 & 2
✓	1	✓	1	✓	2	✓	2	✓	2	✓	1 & 2
				✓	1					✓	2
✓	2	✓	1	✓	2	✓	2			✓	2
		✓	2	✓	3	✓	3				
				✓	4	✓	4				
						✓	5				
						✓	6				
						✓	7				
						✓	8				
		Optional								Handle with overload protection	
		✓				✓				✓	
✓				✓		✓		✓		✓	
✓		✓		✓		✓		✓		✓	
5, 10, 15, 20		5, 10, 15, 20		5		5 (+/-)		6.5 & 10.3		4.5, 5, 5.5, 7, 9, 11, 14	
✓		✓		✓		✓					
Lifetime		Lifetime		Lifetime		Lifetime		Lifetime		Lifetime	
				✓		✓				✓	
				✓		✓					
		✓		✓		✓					
		✓		✓		✓					
		✓		✓		✓					

HAND CHAIN HOISTS

MODEL COMPARISON



CM
SERIES 622
Hand Chain Hoist



COFFING
HOISTS
LHH
Hand Chain Hoist



CHESTER
HOIST
MODEL AM
Hand Chain Hoist

CAPACITY (Ton)	Capacity	Reeving	Capacity	Reeving	Capacity	Reeving
1/4						
1/2	✓	1	✓	1	✓	1
1	✓	1	✓	1	✓	1
1-1/2			✓	1	✓	1
2	✓	1	✓	1		
3	✓	2	✓	1	✓	2
4					✓	3
5	✓	2	✓	3		
6					✓	5
8			✓	3		
10			✓	3		
12			✓	5		
15			✓	5		
16						
20			✓	6		
25			✓	8		
30			✓	10		
40			✓	14		
50			✓	20		
FEATURES						
Load Limiter			Optional		Optional	
Metal Housing	✓		✓		✓	
Aluminum Housing						
Weston Brake	✓		✓		✓	
Standard Lifts (ft.)	10, 15, 20		10, 15, 20		15, 20, 25	
Low Headroom Option						
Zinc Plate Hand Chain						
Zinc Plate Load Chain						
Self-Colored Hand Chain	✓		✓		✓	
Self-Colored Load Chain	✓		✓		✓	
Configurator Quoted						
Domestic Hoist						
Warranty	1 Year		Lifetime		1 Year	
Metric Ton Rated	✓		✓		✓	
OPTIONS						
Fabric Chain Bag						
Rigid Chain Container					✓	
Extended Lifts			✓		✓	
Zinc Plate Hand Chain			✓		✓	
Zinc Plate Load Chain			✓		✓	
Stainless Load Chain						
Stainless Load Chain						
Aluminum Hand Chain						
Chainless Heads	✓		✓			
Spark Resistant						
Low Headroom						
Lug Mount					✓	
Trolley Mount					✓	
Special Exterior Finish						
Bronze Hook						
Latchlok Hooks						
Bullard Hook						

CM® TORNADO 360™

RATCHET LEVER HOIST

Redefining lever-operated hoists, the CM® Tornado 360°™ features the revolutionary Sidewinder™ lever handle that allows for efficient operation in both lifting and pulling applications. Ergonomically designed for increased safety, the patent-pending CM Tornado 360° lets the operator work up to 12 times faster and with as much as 30% less pull force than with conventional ratchet lever tools.

SPECIFICATIONS

- **3/4, 1-1/2, 3 & 6 TON CAPACITIES**
- **METRIC RATED**
- **STANDARD LIFTS UP TO 20 FEET**
Longer lifts are available.

OPTIONS

SHIPYARD HOOKS

Available on 1-1/2 & 3 ton units.

CM SMART ID™ RADIO FREQUENCY IDENTIFICATION

Simplify inventory and inspection management processes.

INTERNAL LOAD LIMITER

Allows the handle to rotate freely, preventing the lifting of an overload sufficient to damage the hoist. Units equipped with a load limiter feature a black hand wheel for quick and easy on-site identification.

FEATURES & BENEFITS

SIDEWINDER LEVER HANDLE

This first-of-its-kind lever handle design will revolutionize the ratchet lever hoist industry. Its unique foldable handle and 360° rotating lever increases productivity while reducing the risk of operator injury.

CONVENIENT DIRECTIONAL INDICATOR

Easy-to-use, highly visible directional indicator located on the handle clearly shows the operating direction as lifting, lowering or neutral.

EASY & SMOOTH FREE CHAINING

For quick take up and positioning of slack chain – even with one hand. Designed not to accidentally free chain while under load. Cast chain end stop allows the user to easily position the chain in free-chaining mode and prevents it from entering the liftwheel and jamming the hoist.

POSITIVE LOAD CONTROL

Enclosed Weston-type brake stays clean and dry for precise load positioning.

BUILT TO LAST

Lightweight aluminum housing withstands rigorous use and features high-quality, long-lasting bearings. Powder-coat finish provides extra protection in harsh environments.

MEETS ASME B30.21

EXCELLENT CORROSION PROTECTION

Robust chain guide and chain stripper made from cast steel and zinc plated for corrosion protection.

100% LOAD TESTED CHAIN

Proven chain integrity and corrosion resistance. U.S. models equipped with American-made gold chromate chain, Canadian models with zinc-plated chain.

EASY-TO-INSPECT SWIVEL HOOKS

Bolt-on hooks with nylon locks help users comply with ASME B30.21 and B30.10 inspection requirements. Hooks are forged, allowing them to yield under overload without breaking. Cast safety latches provide positive and secure load engagement.

INDUSTRY-LEADING WARRANTY

Our lifetime warranty on all mechanical components, including the Sidewinder lever handle, is the industry's best warranty against manufacturing and material defects.

With our 3-year brake warranty, if the brake discs wear out within 3 years from the date of purchase, CMCO will replace the ratchet disc assembly free of charge.

EASY IDENTIFICATION

Each unit has a unique serial number for easy and accurate identification.

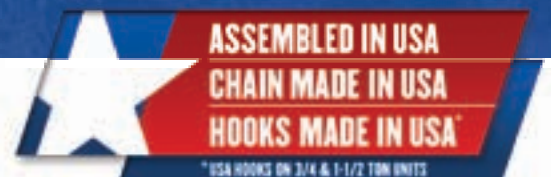

BANDIT™ RATCHET LEVER HOIST

THE PATENT-PENDING CM TORNADO 360° RATCHET LEVER HOIST FEATURES THE REVOLUTIONARY SIDEWINDER™ LEVER HANDLE.

What makes the Sidewinder unique are two innovative components:

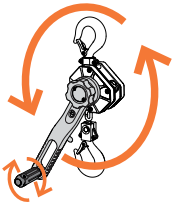

1. 360° ROTATING LEVER

The unique offset, or curved, design of the lever keeps the operator's hand and body aligned with the load chain. This reduces the risk of the twist effect (when a hoist twists around the chain) and the need to stabilize the hoist with another hand.



2. FOLD-OUT REVOLVING HANDLE

Recessed in the lever, the heavy-duty steel core handle folds down into position on either side of the lever, allowing for easy operation from any angle. The handle is grooved to provide a secure grip – even with gloves.

The handle revolves, allowing the operator to ergonomically and easily maintain control of the lever through its full 360° range of motion.



Together, the Sidewinder's lever and handle allow the operator to realize the full potential of 360° rotation, making the CM Tornado 360° unlike any other ratchet lever hoist on the market.

(((DISTINCTIVE CLICKING SOUND))) ENSURES THE HANDLE IS LOCKED INTO POSITION

To return handle to upright position, simply pull the handle outward and snap into place inside the lever.



EASILY CHANGE YOUR GRIP TO SUIT THE APPLICATION

When an application requires a customary ratcheting hand grip, the Tornado 360° can be operated like a traditional lever tool when the lever handle is in the upright position.



EASILY CARRY & TRANSPORT WITH JUST ONE HAND

When folded out, the lever handle can serve as a carrying grip for easy transport. Simply attach the end stop to the hook and slip the hook onto the Sidewinder lever handle to lift and carry the unit with one hand.



ERGONOMIC DESIGN DELIVERS OPTIMAL OPERATOR SAFETY

Hoist design allows the operator to work in a safe and ergonomic position.

Sidewinder lever handle enables smooth 360° operation, reducing repetitive wrist action experienced with traditional ratchet lever hoists.

Double reduction gearing and high-quality bearings decrease required pull force by up to 30%, reducing operator fatigue.



TORNADO 360™ RATCHET LEVER HOIST

DIMENSIONS & SPECIFICATIONS

Capacity Tons (kg.)	Product Code		Standard Lift ft. (m)	Pull Force to Lift Rated Load lb./ft. (kg./ft.)		Reeving	Weight lbs. (kg)	Dimensions in. (mm)														
	without load limiter	with load limiter		Sidewinder Lever Handle Operation	Traditional Lever Operation			A (Min.)	B	C	D	E	F	G	H	J	K	L	M	N	O	P
0.75 (750)	TOR07505	TOR07505LL	5 (1.5)	38.2 (17.3)	47.2 (21.4)	1	14.6 (6.62)	12.60 (320)	0.79 (20)	1.06 (27)	0.71 (18)	12.87 (327)	11.81 (300)	1.57 (40)	3.19 (81)	4.76 (121)	2.20 (56)	4.13 (105)	6.33 (161)	1.18 (30)	4.72 (120)	10.1 (257)
	TOR07510	TOR07510LL	10 (3.0)				16.8 (7.62)															
	TOR07515	TOR07515LL	15 (4.5)				19.0 (8.62)															
	TOR07520	TOR07520LL	20 (6.0)				21.2 (9.62)															
	TOR075LCX	TOR075LCXLL	Less Chain				11.95 (5.42)															
1.5 (1,500)	TOR15005	TOR15005LL	5 (1.5)	58.5 (26.5)	60.7 (27.5)	1	21.0 (9.52)	14.76 (375)	1.02 (26)	1.22 (31)	0.83 (21)	12.87 (327)	11.81 (300)	2.01 (51)	3.78 (96)	5.79 (147)	2.71 (69)	4.33 (110)	7.05 (179)	1.18 (30)	4.72 (120)	10.7 (273)
	TOR15010	TOR15010LL	10 (3.0)				24.5 (11.11)															
	TOR15015	TOR15015LL	15 (4.5)				28.1 (12.75)															
	TOR15020	TOR15020LL	20 (6.0)				31.6 (14.33)															
	TOR150LCX	TOR150LCXLL	Less Chain				16.71 (7.58)															
	00002145	Optional Upper Shipyard Hook		4.4 (2.00)	14.02 (356)	1.10 (28)	1.06 (27)	0.91 (23)	12.87 (327)	11.81 (300)	1.46 (37)	3.78 (96)	5.24 (133)	2.72 (69)	4.33 (110)	7.05 (179)	1.18 (30)	4.72 (120)	10.75 (273)			
	3315WLP	Optional Lower Shipyard Hook		2.87 (1.30)	14.02 (356)	1.10 (28)	1.06 (27)	0.91 (23)	12.87 (327)	11.81 (300)	1.46 (37)	3.78 (96)	5.24 (133)	2.72 (69)	4.33 (110)	7.05 (179)	1.18 (30)	4.72 (120)	10.75 (273)			
3 (3,000)	TOR30005	TOR30005LL	5 (1.5)	79.4 (36)	90.4 (41)	1	36.61 (16.61)	17.52 (445)	1.46 (37)	1.57 (40)	1.10 (28)	14.84 (377)	13.78 (350)	2.24 (57)	4.84 (123)	7.09 (180)	3.39 (86)	4.76 (121)	8.15 (207)	1.18 (30)	4.72 (120)	11.77 (299)
	TOR30010	TOR30010LL	10 (3.0)				44.01 (19.96)															
	TOR30015	TOR30015LL	15 (4.5)				51.41 (23.32)															
	TOR30020	TOR30020LL	20 (6.0)				58.81 (26.68)															
	TOR300LCX	TOR300LCXLL	Less Chain				29.21 (13.25)															
	00002383	Optional Upper Shipyard Hook		4.23 (1.92)	17.17 (436)	1.46 (37)	1.42 (36)	1.10 (28)	14.84 (377)	13.78 (350)	1.89 (48)	4.84 (123)	6.73 (171)	3.39 (86)	4.76 (121)	8.15 (207)	1.18 (30)	4.72 (120)	11.77 (299)			
3403WLP	Optional Lower Shipyard Hook		4.81 (2.18)	17.17 (436)	1.46 (37)	1.42 (36)	1.10 (28)	14.84 (377)	13.78 (350)	1.89 (48)	4.84 (123)	6.73 (171)	3.39 (86)	4.76 (121)	8.15 (207)	1.18 (30)	4.72 (120)	11.77 (299)				
6 (6,000)	TOR60005	TOR60005LL	5 (1.5)	83.8 (38)	92.6 (42)	2	52.26 (23.70)	22.17 (563)	1.77 (45)	1.73 (44)	1.38 (35)	14.84 (377)	13.78 (350)	2.80 (71)	6.38 (162)	9.17 (233)	3.39 (86)	4.76 (121)	8.15 (207)	1.18 (30)	4.72 (120)	11.77 (299)
	TOR60010	TOR60010LL	10 (3.0)				59.66 (27.06)															
	TOR60015	TOR60015LL	15 (4.5)				67.06 (30.42)															
	TOR60020	TOR60020LL	20 (6.0)				74.46 (33.77)															
	TOR600LCX	TOR600LCXLL	Less Chain				44.86 (20.35)															

3/4, 1-1/2 AND 3 TON UNITS

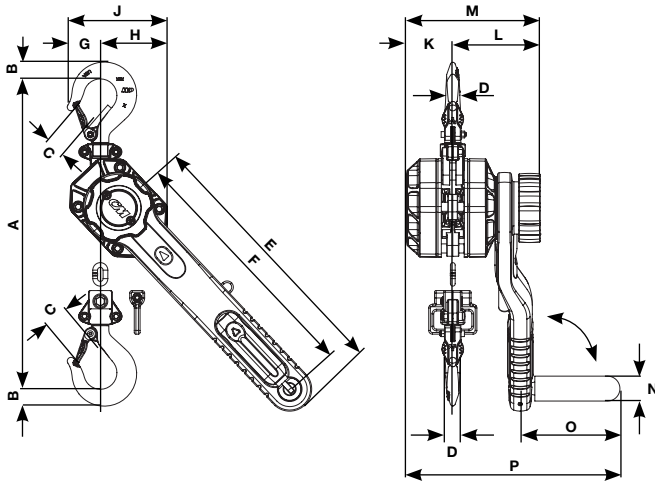

6 TON UNITS

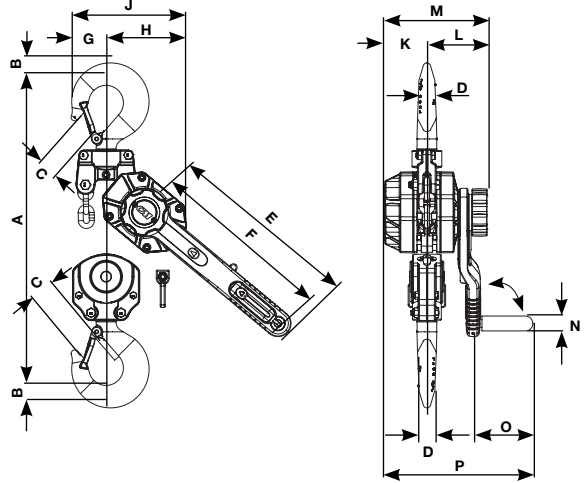

HOISTS, TROLLEYS & BEAM CLAMPS

RATCHET LEVER HOIST

The CM Bandit™ is one of the most compact and durable ratchet lever hoists in the industry. Its lightweight and portable design, easy free-chaining feature and 360° rotating handle make it one of the most versatile hoists on the market today. Now available in 3/4, 1-1/2, 3 and 6 ton capacities for all of your pulling and lifting needs.

SPECIFICATIONS

- **3/4, 1-1/2, 3 & 6 TON CAPACITIES**
- **METRIC RATED.**
- **STANDARD LIFTS UP TO 20 FEET.**
Longer lifts are available.

FEATURES & BENEFITS

COMPACT & PORTABLE DESIGN

Rugged, yet lightweight, design and construction allow the Bandit to be easily transported and used in even the most confining spaces.

OUR FIRST HOIST WITH CM SMART ID™ RFID TECHNOLOGY!

- Standard on all U.S. Bandit units
- Chip associated with detailed product information at the factory

FREE-CHAINING

Easy free-chaining feature allows for quick take up and positioning of slack chain. Designed not to accidentally free chain while under load.

360° ROTATING HANDLE

Full rotation of handle allows for versatile rigging options when working in tight spaces.

LOW HANDLE EFFORT

Double reduction gearing provides easy operation with minimal handle effort.

COMFORT-FIT HANDLE

Screwed-on comfortable rubber grip makes for a secure hold in all environments.

LOAD SECURITY & EASY INSPECTION

Upper and lower hooks feature standard cast safety latches that provide positive and secure load engagement. Hooks are bolted on for easy removal and inspection.

MEETS ASME B30.21 POSITIVE LOAD CONTROL

Enclosed Weston-type load brake stays clean and dry for positive load positioning.

EASY TO POSITION & ATTACH

Upper and lower hooks feature extra-wide throat openings to allow for easier attachment to pick points. Hooks swivel 360° for faster positioning.

BUILT TO LAST

Impact-resistant stamped steel housing withstands repeated rigorous use.

CORROSION RESISTANT

Standard powder coat finish on housing and zinc plating on major components for extra protection against corrosion when working in harsh environments.

100% LOAD TESTED GOLD CHROMATE CHAIN

Proven chain integrity and corrosion resistance.

EASY IDENTIFICATION

Each unit has a unique serial number for easy and accurate identification.

OPTIONAL SHIPYARD HOOKS

Shipyards hooks are available as an option on 1-1/2 & 3 ton units.

OPTIONAL INTERNAL LOAD LIMITER

Allows the handle to rotate but will not lift if load exceeds 125% of the working load limit.

SHIPS IN 3 DAYS – GUARANTEED

3/4 & 1-1/2 ton units are eligible for our In-Stock Guarantee.



BANDIT™ RATCHET LEVER HOIST

SUGGESTED INDUSTRY APPLICATIONS:



SHIP BUILDING

Position of metal sheets for bolting and welding



UTILITY LINES & POWER PLANTS

Lightweight hoist makes it easier to pull, tighten and secure above ground cables. Compact design makes boiler repairs a much easier task in confined spaces.



STEEL BEAM & BRIDGE CONSTRUCTION

Precise movement for bolt alignment and an excellent tool for deck tensioning



CONVEYOR MAINTENANCE

Great for belt tensioning and repairs

WASTE TREATMENT PLANTS

Excellent for cartridge removal & replacement

PUMP INSTALLS

Small size makes this hoist ideal for lifting condensing units and pumps in confined spaces



EQUIPPED WITH RFID TECHNOLOGY

All CM Bandit units for the U.S. market come standard with CM Smart ID™ – new radio frequency identification (RFID) technology from Columbus McKinnon. CM Smart ID can help simplify your inventory and inspection management processes.

Before the Bandit leaves our factory, a CM Smart ID RFID chip is associated with product information that is uploaded and stored on the CM Smart ID Cloud. This free information, which includes the Chip ID number, CM product code, product description and capacity, can be instantly accessed by anyone in your company, anywhere, at any time.



ACTUAL SIZE

PRODUCT LINE AT A GLANCE (U.S.A MODELS)

Capacities (Ton)	In-Stock Guarantee	CM Smart ID RFID	Initial Assembly	Final Assembly	Hook Origin	Tri-Point Hook Inspection	Optional Shipyard Hooks	Chain Origin	Type of Chain	Load Tested
3/4	✓	✓	CMCO China Facility	CMCO USA Facility	CMCO USA Facility			CMCO USA Facility	Gold Chromate	China & USA
1-1/2	✓	✓			CMCO USA Facility		✓			
3		✓			CMCO China Facility	✓	✓			
6		✓			CMCO China Facility	✓				

Check for availability on 3 and 6 ton units.



THE WORLD'S FIRST HMI-CERTIFIED RATCHET LEVER HOIST

Columbus McKinnon designed the CM Bandit to be the best lever hoist on the market. As a result, the CM Bandit has become the world's first HMI-Certified ratchet lever hoist, meeting strict, nationally recognized industry standards. This certification supports our commitment to safety, service and aftermarket support. It instills customer confidence in the quality and value of the CM Bandit, which is also backed by our industry-leading lifetime warranty.

WHAT IS THE HOIST MANUFACTURERS INSTITUTE (HMI)?

HMI members are industry-leading suppliers of material handling equipment, including manual and powered hoist and trolley manufacturing and distribution.

HMI is recognized as the authority and principal resource in the hoist industry. It is the leading advocate for the safe and proper operation of hoisting equipment and related products.

WHAT DOES HMI-CERTIFIED MEAN?

The purpose of HMI certification is to instill consumer confidence that the product and its manufacturer have met strict HMI requirements, which include that the manufacturer:

- Be a manufacturer of industrial hoisting equipment
- Have its product meet one or more requirements as stated by HMI
- Have a qualified, US-registered professional engineer verify, sign and seal that the product meets the requirements
- Must provide a Declaration of Conformity for Technical, Service and Support

HMI is not a trademark of Columbus McKinnon Corporation.





**WATCH OUR
BANDIT VIDEOS**
SCAN THE QR CODE
WITH YOUR SMARTPHONE

BANDIT™ RATCHET LEVER HOIST

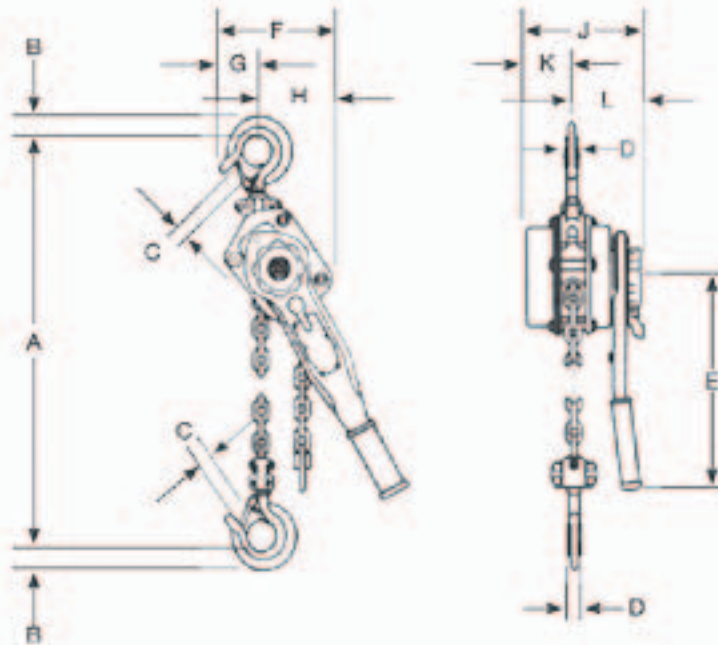

DIMENSIONS & SPECIFICATIONS

Model Number	Capacity Metric Rated Ton (kg)	Standard Lift ft. (m)	Lever Pull to Lift Rated Load lbs./ft. (kg)	Weight lbs. (kg)	Dimensions Inches (mm)										
					A	B	C	D	E	F	G	H	J	K	L
BAN07505	3/4 (750)	5 (1.52)	45 (20.41)	13.6 (6.17)	12.80 (325.12)	0.94 (23.88)	1.13 (28.70)	0.69 (17.53)	9.63 (244.60)	4.88 (123.95)	2.19 (55.63)	3.31 (84.07)	6.06 (153.92)	2.11 (53.59)	3.95 (100.33)
BAN07510		10 (3.05)		15.7 (7.12)											
BAN07515		15 (4.57)		18 (8.16)											
BAN07520		20 (6.1)		20.1 (9.12)											
BAN15005	1-1/2 (1500)	5 (1.52)	64 (29.03)	20.7 (9.39)	14.20 (360.68)	1.13 (28.70)	1.25 (31.75)	0.81 (20.57)	10.25 (260.35)	5.63 (143.00)	2.38 (60.45)	3.56 (90.42)	6.75 (171.45)	2.69 (68.33)	4.13 (104.90)
BAN15010		10 (3.05)		24.3 (11.02)											
BAN15015		15 (4.57)		27.9 (12.65)											
BAN15020		20 (6.1)		31.5 (14.29)											
BAN30005	3 (3000)	5 (1.52)	73 (33.11)	38.3 (17.37)	17.50 (444.5)	1.69 (42.93)	1.56 (39.62)	1.25 (31.75)	16.37 (415.8)	7.52 (191.01)	3.38 (85.85)	4.65 (118.11)	7.84 (199.14)	3.29 (83.57)	4.56 (115.82)
BAN30010		10 (3.05)		45.7 (20.73)											
BAN30015		15 (4.57)		53 (24.04)											
BAN30020		20 (6.1)		60.4 (27.4)											
BAN60005	6 (6000)	5 (1.52)	93 (42.18)	63.2 (28.67)	22.00 (558.8)	1.81 (45.97)	2.19 (55.63)	1.50 (38.1)	16.37 (415.8)	9.47 (240.54)	3.38 (85.85)	6.05 (153.67)	7.84 (199.14)	3.29 (83.57)	4.56 (115.82)
BAN60010		10 (3.05)		77.9 (35.33)											
BAN60015		15 (4.57)		92.6 (42.00)											
BAN60020		20 (6.1)		107.3 (48.7)											

Check for availability on 3 and 6 ton units.

HOISTS, TROLLEYS & BEAM CLAMPS

CM HURRICANE 360°™

HAND CHAIN HOIST

The CM Hurricane 360°™ provides ultimate flexibility for a wide range of applications. The patented hand chain cover rotates a full 360 degrees, allowing operators to lift, pull or position loads from virtually any angle without standing under them.

SPECIFICATIONS

- 1/2 TO 10 TON CAPACITIES
- STANDARD LIFTS UP TO 20 FT.
- 5-YEAR WARRANTY

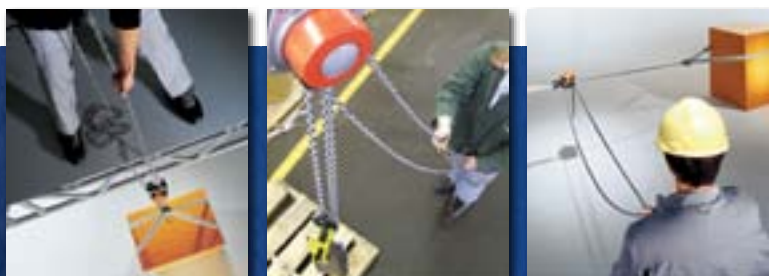

THE CM HURRICANE 360°™ IS IDEAL WHEN WORKING:

- **IN TIGHT SPACES** where the rigid handle of a lever hoist would be difficult to maneuver and operate.
- **ABOVE THE LOAD** being lifted.
- **ON A DRIFTING APPLICATION** where the hand chain angle adjusts throughout the operation.
- With large loads to allow the operator to be **A SAFE DISTANCE** away.

FEATURES & BENEFITS

OPERATE FROM ANY ANGLE

360 degree rotating hand chain cover allows the hoist to be operated at any angle from any location, even inverted.

STANDARD LOAD LIMITER

For simple, automatic overload protection.

BRAKING POWER

Double pawl Weston-Style braking system provides reliable positive load control.

POWDER COATED FINISH

For corrosion protection.

HEAT TREATED STEEL GEARING

All internal gears and pinions are heat treated steel for high strength and long life.

CHAIN GUIDE AND STRIPPER

Assures load chain alignment.

PRECISION 4-POCKET LIFTWHEEL

Fully machined for better chain fit and reduced wear allowing for accurate movement of the load chain.

HARDENED STEEL CHAIN

Alloy steel load chain assures high strength and long wear life.

MINIMAL MAINTENANCE

Easily disassembled, requiring no special tools.

MEETS ASME B30.16

And European CE Standard

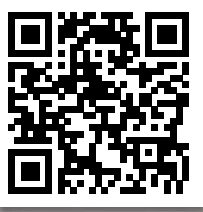
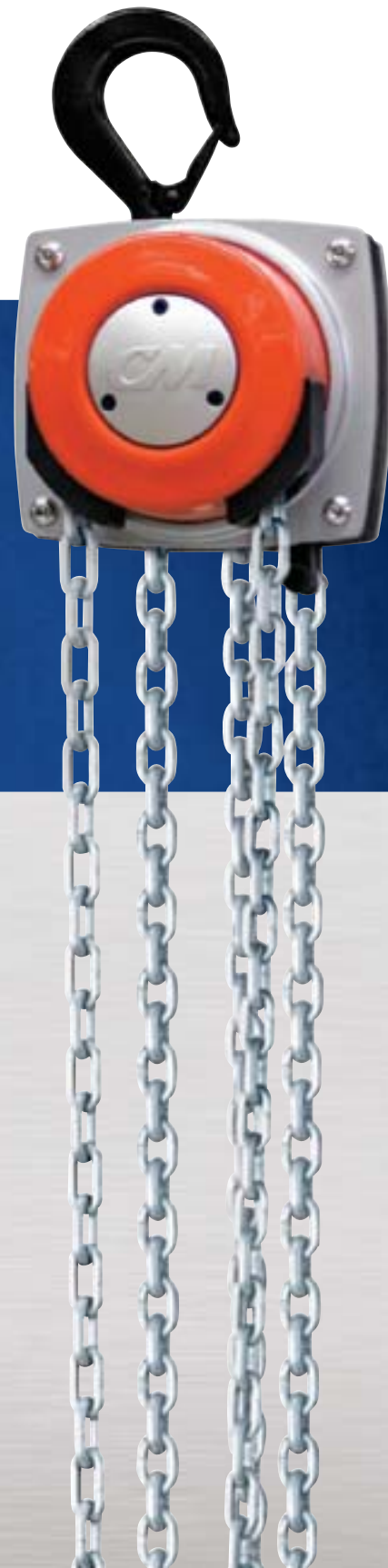

SEE THE HURRICANE 360° IN ACTION

SCAN THE QR CODE TO VISIT OUR YOUTUBE CHANNEL

or go to <http://www.youtube.com/user/ColumbusMcKinnon>

HURRICANE 360°™ HAND CHAIN HOIST

SUGGESTED INDUSTRY APPLICATIONS:



REFINERIES

Drifting through wall openings



POWER PLANT MAINTENANCE

Boiler Repair



CONSTRUCTION

Used in confined spaces when handles could present problems



THEATRICAL INSTALLATIONS

Truss installations while inverted



SWITCHGEAR INSTALLS

Used to stand beside the gears instead on over the top pull

BOILER ROOM MAINTENANCE

Keeps you safer from the heater parts if boiler is in use

MOTOR/PUMP REPLACEMENTS

Pull pumps by standing to the side inside of or under or over the load

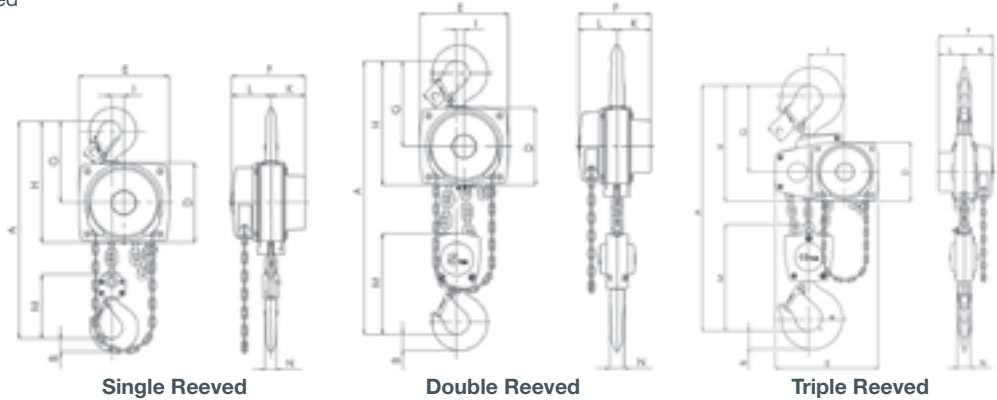

DIMENSIONS & SPECIFICATIONS

Product Code	Load Rating Tons (kg)	Lift		Weight (lbs.)	Hand Chain Pull to Lift Rated Load lbs. (kg)	Hand Chain Overhauled to Lift Load One Foot ft. (m)	Dimensions in inches (mm)													
		ft.	m.				A	B	C	D	E	F	G	H	I	K	L	M	N	
5632A	1/2 (500)	Less Chain		20	44 (20)	30 (9.1)	11.811 (300)	0.669 (17)	0.945 (24)	5.236 (133)	5.827 (148)	5.827 (148)	5.472 (139)	8.110 (206)	0.945 (24)	2.402 (61)	3.425 (87)	4.331 (110)	0.551 (14)	
5623A		10	3	23																
5624A		15	4.5	28																
5625A		20	6	33																
5651A		30	9	43																
5633A	1 (1,000)	Less Chain		21	54 (24)	49 (14.9)	13.189 (335)	0.866 (22)	1.142 (29)	6.142 (156)	6.890 (175)	6.575 (167)	6.457 (164)	9.528 (242)	0.945 (24)	2.756 (70)	3.819 (97)	4.921 (125)	0.748 (19)	
5626A		10	3	26																
5627A		15	4.5	33																
5628A		20	6	41																
5653A		30	9	58																
5634A	2 (2,000)	Less Chain		26	74 (34)	71 (21.6)	15.551 (395)	1.181 (30)	1.378 (35)	7.165 (182)	7.992 (203)	7.638 (194)	7.559 (192)	11.142 (283)	1.220 (31)	3.268 (83)	4.370 (111)	6.142 (156)	0.866 (22)	
5629A		10	3	45																
5630A		15	4.5	48																
5631A		20	6	51																
5638A	3 (3,000)	Less Chain		56	92 (42)	87 (26)	20.472 (520)	1.496 (38)	1.575 (40)	8.661 (220)	9.843 (250)	8.622 (219)	8.858 (225)	13.189 (335)	1.339 (34)	3.740 (95)	4.882 (124)	7.008 (178)	1.181 (30)	
5635A		10	3	68																
5636A		15	4.5	79																
5637A		20	6	90																
5642A	5 (5,000)	Less Chain		80	76 (34)	174 (53)	25.748 (654)	1.772 (45)	1.850 (47)	8.661 (220)	9.843 (250)	8.622 (219)	9.528 (242)	13.858 (352)	0.827 (21)	3.740 (95)	4.882 (124)	11.220 (285)	1.457 (37)	
5639A		10	3	122																
5640A		15	4.5	142																
5641A		20	6	162																
5646A	10 (10,000)	Less Chain		120	102 (46)	261 (79.3)	32.480 (825)	2.677 (68)	2.677 (68)	8.661 (220)	15.079 (383)	8.622 (219)	12.835 (326)	17.165 (436)	5.354 (136)	3.740 (95)	4.882 (124)	15.787 (401)	1.969 (50)	
5643A		10	3	210																
5644A		15	4.5	240																
5645A		20	6	270																

HOISTS, TROLLEYS & BEAM CLAMPS



► To see our full line of hoists, trolleys & beam clamps, visit us online at www.cmworks.com



CM CTP ADJUSTABLE TROLLEY CLAMP

ADJUSTABLE TROLLEY CLAMP

A heavy duty adjustable trolley designed for easy installation while offering superior strength and stability throughout its long service life.

SPECIFICATIONS

- 2,200 TO 6,600 LB. CAPACITIES
- I-BEAM WIDTHS FROM 2-1/4 TO 12-1/2 IN.
- MINIMUM RADIUS CURVES OF 24, 35 AND 45 IN.

FEATURES & BENEFITS

ADJUSTS TO FIT A RANGE BEAM WIDTHS
Easily hand-adjusted with its central threaded spindle to fit a wide range of beam widths.

QUICK & EASY INSTALLATION
The CTP requires no tools to install.

CORROSION RESISTANT
Zinc plated spindles for added protection against the elements.

SAFE & SECURE
Unique Locking Nut Handle prevents spindle from loosening.

THE SMART & ECONOMICAL CHOICE
With its competitive price and universal Hanging Clevis able to accept most hoists, the CTP is a tremendous value.

METRIC RATED

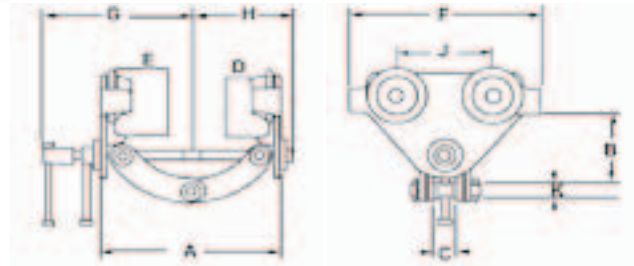

Capacity		Product Code	Model	I-Beam Width (in.)	Minimum Radius Curve (in.)	Wheel Diameter (in.)	Dimensions (in.)														Weight (lbs.)
(lbs.)	(ton)						A		B		C	D	E	F	G	H	J	K			
							Min.	Max.	Min.	Max.											
2,200	1	05500024	CTP/A 1T	2-1/4 to 6	24	2.36	3.74	7.283	3.228	4.291	1.026	2.598	2.874	6.299	6.020	4.134	2.952	0.787	5.5		
4,400	2	05500025	CTP/A 2T	3 to 7-7/8	35	3.27	4.921	9.843	4.173	6.102	1.653	3.543	3.937	10.236	8.070	5.471	5.118	0.787	21.8		
4,400	2	05500026	CTP/B 2T	7-7/8 to 11-7/8	35	3.27	4.921	9.843	5.365	7.519	1.653	3.543	3.937	10.236	10.039	7.441	5.118	0.787	22.7		
6,600	3	05500027	CTP/A 3T	3 to 7-7/8	45	4.37	5.315	10.236	5.039	6.732	1.969	4.331	4.921	12.207	8.661	6.102	5.906	0.866	38.6		
6,600	3	05500028	CTP/B 3T	7-7/8 to 12-1/2	45	4.37	5.315	10.236	5.905	8.346	1.969	4.331	4.921	12.207	11.02	8.464	5.906	0.866	43.0		

► To see our full line of hoists, trolleys & beam clamps, visit us online at www.cmworks.com

PHONE: 800.888.0985



CM BEAM CLAMP

BEAM CLAMP

Ideal as an anchor (semi-permanent) for rigging operations (vertical or horizontal), as a hoisting anchor, or as a tool for positioning and holding beams for welding. The Beam Clamp is recommended for commercial, construction and industrial applications.

SPECIFICATIONS

- 2,000 TO 20,000 LB. CAPACITIES
- I-BEAM WIDTHS FROM 3 TO 12.2 IN.

FEATURES & BENEFITS

REDUCED FLANGE STRESS

Special clamp jaw design distributes load away from flange edge.

ADJUSTABLE

Threaded mechanism fits securely on a wide range of flange widths and beam sizes.

LOW HEADROOM

Provided by built-in suspension bar.

LIFETIME WARRANTY



Capacity		Product Code	Model Number	I-Beam Width (in.)	Weight (lbs.)
(lbs.)	(ton)				
2,000	1	09001W	BC-1	3 to 9	9
4,000	2	09002W	BC-2	3 to 9	13
6,000	3	09003W	BC-3	3.2 to 12.6	18
10,000	5	09004W	BC-5	3.6 to 12.2	22
20,000	10	09005W	BC-10	3.6 to 12.6	34

► To see our full line of hoists, trolleys & beam clamps, visit us online at www.cmworks.com



Camlok™ SCREWLOK BEAM CLAMP WITH SHACKLE

BEAM CLAMP

Screwlok Beam Clamps are designed for attachment to the lower flanges of structural steel beams to provide a semi-permanent lifting point. The clamps can be quickly and easily attached via the screw-type mechanism.

BENEFITS & FEATURES

- Designed to fit flanges of most structural beams
- Act as a semi-permanent lifting point for use with manual or electric hoists
- Shackle incorporated for quick and easy component attachment

Product Code	Working Load Limit (lbs.)	Jaw Capacity (in.)	Dimensions (in.)						Weight (lbs.)
			A	B	C	D	E	F	
SC921	2,200	3 to 8-1/4	12.625	12.125	1.750	8.250	5.375	2.625	11.0
SC922	4,400	3 to 8-1/4	12.625	12.875	1.750	8.250	5.375	2.875	13.5
SC923	6,600	4 to 10-5/8	16.125	14.750	1.750	10.625	6.500	4.000	17.5
SC923/L	6,600	3 to 12	17.375	16.500	1.750	12.000	8.625	4.000	20.0
SC925	11,000	4 to 10-5/8	16.125	15.375	2.125	10.625	8.500	4.375	22.0
SC925/L	11,000	3 to 12	17.125	17.125	2.125	12.000	8.625	4.375	26.5
SC9210	22,000	3 to 12	18.125	20.000	3.250	12.000	8.625	4.375	35.5

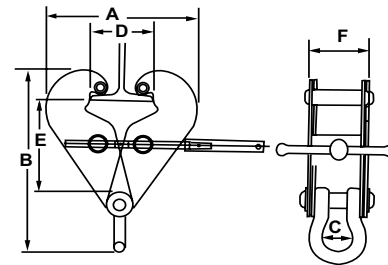

► INSPECTION, CARE & USE

DO NOT side load more than 15 degrees.

DO NOT use as a lifting device. Clamp should only be used for suspension or to anchor a hoist



For more information, visit us at
www.cmworks.com

Camlok™ SC SERIES TWIN BEAM CLAMP

BEAM CLAMP

Twin Beam Clamps enable one beam to be suspended beneath another beam. These clamps are designed for easy attachment and can only be used with a minimum of two suspension points.

BENEFITS & FEATURES

- Enables one beam to be suspended beneath another
- Quickly and easily attaches to both beams
- Supplied fixed at parallel, at 90 degrees to each other or with swivel that allows for 360 degree rotation
- Used for supporting vertical loads only

Product Code	Working Load Limit (lbs.)	Flange Width		Weight (lbs.)
		Minimum (in.)	Maximum (in.)	
SC922T	4,400	2.995	8.387	28.7
SC923T	6,600	3.994	10.783	35.3
SC923/LT	6,600	2.995	12.181	44.1
SC925/LT*	11,000	2.995	12.181	59.5
SC925L	11,000	3.000	12.000	35.5

*Not Stocked



HOISTS, TROLLEYS
& BEAM CLAMPS

ORGANIZATIONS

ACRP

Association of Crane & Rigging Professionals
28175 Haggerty Road, Novi, MI 48377
(800) 690-3921

ANSI

Refers to American National Standards Institute
Specifications published by ANSI
1899 L Street, NW, 11th Floor Washington, DC, 20036
(202) 293-8020.

ASME

The American Society of Mechanical Engineers
Two Park Avenue, New York, NY 10016-5990
(800) 843-2763.

ASTM

Refers to American Society of Testing and Materials
Specifications published by ASTM
100 Barr Harbor Dr., West Conshohocken, PA 19428
(610) 832-9500

AWEA

American Wind Energy Association
1501 M St. NW, Suite 1000, Washington, DC 20005
(202) 383-2500

AWRF

Associated Wire Rope Fabricators
P.O. Box 748, Walled Lake, MI 48390
(800) 444-2973

CVSA

Commercial Vehicle Safety Alliance
6303 Ivy Lane, Suite 310, Greenbelt, MD 20770-6319
(301) 830-6143

DOT

Department of Transportation
1200 New Jersey Ave, SE, Washington, DC 20590
(202) 366-4000

ISO

International Organization for Standardization
ISO Central Secretariat: Geneva Switzerland

NACM

Refers to National Association of Chain Manufacturers
Specifications published by NACM
Post Office Box 89014, Tucson, AZ 85752-9014
(520) 886-0695

OSHA

Occupational Safety & Health Administration
U.S. Department of Labor
200 Constitution Avenue, Washington, D.C. 20210
(800) 321-6742.

SC&RA

Specialized Carriers & Rigging Association
5870 Trinity Parkway, Suite 200, Centreville, VA 20120
(703) 698-0291

WSTDA

Web Sling & Tie Down Association
(443) 640-1070.

INDUSTRY TERMS

ANGLE OF LOADING

The acute angle between the horizontal and the leg of the rigging referred to as the horizontal angle.

BASKET HITCH

Rigging a sling in which the sling is passed around the load and both loop eyes or end fittings are attached to the hoist, crane or lifting device.

BRIDLE SLING

Sling composed of multiple legs with a fitting that attaches to the lifting hook.

CHOKER HITCH

A type of rigging hitch in which the sling is passed around the load then through one loop eye or other end fitting, with the other loop eye or end fitting attached to the hoist, crane or lifting device. This method will reduce the lifting capacity of a sling.

CLEVIS

A U-shaped fitting with holes in each end through which a pin or bolt is run.

COMPETENT PERSON

As defined by OSHA, this is someone who is capable of identifying existing and predictable hazards in the surroundings or working conditions which are unsanitary, hazardous, or dangerous to employees, and who has authorization to take prompt corrective measures to eliminate them.

COUPLING LINK

An alloy steel welded coupling link used as an intermediate link to join alloy steel chain to master links.

DATE CODE (ALSO KNOW AS TRACE CODE)

A series of letters, numbers or both embossed on products that identifies its manufacturing history.

DESIGN FACTOR (SAFETY FACTOR)

An industry term usually computed by dividing breaking strength by the catalog working load limit and generally expressed as a ratio – for example 4:1.

ELONGATION

A test performed on products to determine the amount of stretch prior to fracture. This is typically stated as a percentage.

LOAD

The total superimposed weight or force to be overcome by the hoisting and rigging equipment.

MASTER LINK

Forged or welded steel link used to support all legs of an alloy-steel chain or wire rope sling.

MECHANICAL COUPLING LINK

A non-welded, mechanically closed steel link used to attach master links, hooks, and other attachments to alloy steel chain.

MESSENGER SLING

A short, standard eye-eye wire rope sling often used to connect between a crane hook and another wire rope sling or bridle.

MINIMUM BREAK FORCE OR MBS

The minimum force at which the product has been tested during manufacture that includes testing to break when a constantly increasing force is applied in direct tension. This test is a manufacturer's attribute acceptance test and SHALL NOT be used as criteria for service and design purposes.

OVERHEAD LIFTING

The process of lifting that would elevate a freely suspended load to such a position that dropping the load would present a possibility of bodily injury or property damage.

OVERLOAD

A static or dynamic load in excess of the "Working load Limit."

PROOF LOAD

The load applied during a manufacturing proof test.

PROOF TEST OR PROOF FORCE

The minimum tensile force applied to a product under a constantly increasing force in direct tension during manufacturing. These tests are manufacturing integrity tests and SHALL NOT be used as criteria for service and design purposes.

QUALIFIED PERSON

As defined by OSHA, this is someone who by possession of a recognized degree, certificate, or professional standing, or who by extensive knowledge, training, and experience, has successfully demonstrated his/her ability to solve or resolve problems relating to the subject matter, the work, or the project.

RATED LOAD (CAPACITY)

The maximum load designated by the manufacturer for which a crane, hoist, rigging, or other lifting device is designed and built. Can also be expressed as WLL, SWLL or Capacity.

REACH

The effective length of an alloy steel chain sling measured from the top bearing surface of the upper terminal component to the bottom bearing surface of the lower terminal component.

SAFE WORKING LOAD LIMIT OR SWLL

The maximum rated capacity that shall be applied in direct tension to an undamaged straight-line product.

SHOCK LOADING

Any condition of rapid lift sudden shifting of load or arrest of a falling load.

SLINGS

An assembly made of chain, wire rope or synthetic material with or without end fittings that connects to a lifting mechanism at the top and lower portion supports the load.

TRACE CODE

A series of letters, numbers or both embossed on products that identifies its manufacturing history.

TEST LOAD

A load that is periodically applied to hoisting equipment to ensure that it has the ability to safely handle the rated capacity of the equipment. The test load ranges from 100 to 125 percent of the rated load capacity.

VERTICAL HITCH

A method of supporting a load by a single, vertical part or leg of the sling.

WORKING LOAD LIMIT (WLL)

The working load limit of a chain is the maximum load in pounds that should ever be applied to a chain, even when the chain is new and the load is applied in direct tension to a straight length of chain.

PRODUCT NAME	PAGE
A	
Aircraft Assembly	151
Alloy “S” Hook (Grade 80).....	89
B	
Bandit™ Ratchet Lever Hoist	198
Beam Clamp.....	205
Bridle Assembly Tow Tiger with J & J/T Combo (Grade 70)	153
Bridle Assembly Tow Tiger with R & J/T Combo (Grade 70).....	153
BTG Groundworks.....	140
Bundling Clip	107
Buoy Chain.....	175
C	
Cady® Lifters	142
CG Girder Turning Clamps	135
CH Heavy-Duty Horizontal Plate Clamp	133
Chain (Herc-Alloy® 1000).....	62
Chain (Herc-Alloy 800®).....	74
Chain Assembly with Grab, R and J/T Combo (Grade 70).....	152
Chain Assembly with J, Grab and J/T Combo (Grade 70)	152
Chain Shortener (Herc-Alloy 1000).....	66
CLB Container Lifting Lugs	92, 140
CLB Container Lifting Lugs	92 140
Clevis Assembly (Grade 43)	166
Clevis Assembly (Grade 70)	150
Clevis Assembly with Import Hooks (Grade 70).....	150
Clevis Grab Hook (Grade 30/43)	169
Clevis Grab Hook (Grade 70)	157
Clevis Grab Hook (Grade 80)	157
Clevis Slip Hook (Grade 30/43)	168
Clevis Slip Hook (Grade 70)	159
Clevis Style Heavy-Duty Tie-Downs.....	160
Clevlok® Cradle Grab Hook (Dual Rated)	68, 82
Clevlok® Foundry Hook (Dual Rated)	69
Clevlok® Grab Hook without Cradle (Grade 80)	82
Clevlok® Sling Hook (Dual Rated).....	67, 81
Clevlok® Style Heavy-Duty Tie-Downs.....	160
Cluster Assembly with Grab, R Hook & J/T Combo (Grade 70).....	152
CMG Ratchet & Lever Binders	163
Cold Shuts.....	171
CP Pile Pitching Clamp	134
Crane Hook (Single Hook, Ramshorn Hook, Form B Ramshorn Hook, Eye Hook)	116-123
CTP Adjustable Trolley Clamp.....	204
CX Heavy Duty Hinged Universal Plate Clamp	130
CY Hinged Universal Plate Clamp.....	129
CZ Universal Plate Clamp	128

PRODUCT NAME	PAGE
D	
D-Rings	164
DNV Master Sub-Assembly.....	55, 95
Double Clevis (Mid-Link)	156
Drive Sprocket - Cast.....	176
Drive Sprocket - Replaceable Teeth.....	176
E	
E-Z Pro® Cam Release Lever Binder.....	163
EZ-Connect Master Link & Chain Shortener (Dual Rated)	65
Eye Cradle Grab Hook (Dual Rated).....	68, 83
Eye Foundry Hook (Dual Rated)	69, 83
Eye Grab Hook (Grade 30/43)	169
Eye Grab Hook (Grade 70)	158
Eye Grab Hook (Grade 80)	158
Eye Hook (Heavy-Duty Crane Hook).....	122
Eye Sling Hook (Dual Rated)	67, 81
Eye Slip Hook (Grade 30/43)	168
Eye Slip Hook (Grade 70)	159
F	
Flat Bottom Master Link (Grade 80)	77
Forged Lever Load Binder.....	162
Forged Master Link (Grade 80).....	76, 93
Forged R, T & Mini J Hooks (Grade 70).....	155
Forged Ratchet Load Binder.....	161
Forged Triangles (“D” Rings)	171
Form B Ramshorn Hook (Heavy-Duty Crane Hook)	120
G	
Grab Link (Grade 80)	79
Grinding Mill Liner Bolts	179
H	
Hammerlok® (Dual Rated).....	66
Hammerlok® (Grade 80).....	80
Hanger Chain (Grade 30).....	167
Heavy Duty Crane Hooks (Single Hook, Ramshorn Hook, Form B Ramshorn Hook, Eye Hook)	116-123
Heavy Duty® Hoist Ring.....	99
HG High Grip Plate Clamp	137
HGC Hand Grip Clamp.....	141
High Test Chain (Grade 43)	165
Hoist Ring (Metric).....	115
Hoist Ring Swivel	116
Hurricane 360™ Hand Chain Hoist	198
J	
J Hook.....	154

PRODUCT NAME	PAGE
L	
Latchlok Hook® - Clevlok® Style (Herc-Alloy® 1000)	70
Latchlok Hook® - Eye Style (Herc-Alloy® 1000).....	70
Latchlok Hook® - Swivel Style (Herc-Alloy® 1000)	71
LJ Gentle Grip Clamp.....	131
Long Wall Mining Chain.....	177
M	
Master Link (Dual Rated)	64, 76, 93
Master Link with & without Flats (Grade 80)	77, 94
Master Ring (Grade 80)	79
Mid-Grip Wire Rope Clips	105
O	
Omegalok Connector (Dual Rated)	66
P	
Padless Shackle Connectors	178
Pear Links.....	155
Pear Shaped Master Link (Herc-Alloy® 1000).....	65
Piggyback® Wedge Socket Clips	106
Plate Hook (Grade 80)	89
Proof Coil Chain (Grade 30).....	167
R	
Ramshorn Hook (Heavy-Duty Crane Hook)	118
Ratchet Binders Heavy-Duty Tie Downs.....	160
Recover “J” Hook Assemblies (Grade 70).....	154
Removable Handle Load Binder	161
Repair Link / Lap Link	170
Replacement Hook with Latch.....	92
Replacement Latches (for swivel, rigging & shank hooks).....	91
Rigging Hook (Dual Rated, for use with chain).....	67
Rigging Hook	90
Rivet Assembly (Grade 70).....	151
S	
S.T.A.C. Chain	182
S.T.A.C. Chain Sets	182
Sash Chain	175
SC Series Twin Beam Clamp.....	207
Screwlok Beam Clamp with Shackle	206
Shackles - Alloy Anchor	49
Shackles - Alloy Web Sling.....	52
Shackles - Carbon Anchor (Industrial/Government)	50
Shackles - Carbon Chain (Industrial/Government).....	51
Shackles - Carbon Web Sling	52
Shackles - DNV	54
Shackles - Long Reach	53
Shackles - Super Strong Anchor.....	47
Shackles - Super Strong Chain.....	48
Shackles - Theatrical.....	182
Shackles - Trawling	53

PRODUCT NAME	PAGE
Shank Hook (Grade 80).....	88
Shoulder Eye Bolts.....	97
Single Hook (Heavy-Duty Crane Hook).....	116
Sixth Wheel Ratchet.....	164
Sling ID Tags.....	63, 75
Slings (Herc-Alloy® 1000)	63
Slings (Herc-Alloy 800®)	75
Sorting Hook (Grade 80).....	88
Special Chain Connector	178
Specialty Engineered Hoist Ring.....	100
Specialty Forged Lever Load Binder.....	162
Straight Link Coil Chain.....	174
Straight Link Machine Chain	174
Sub-Assembly (Dual Rated)	64, 78
Swage Button.....	108
Swage Socket (Closed)	108
Swage Socket (Open).....	107
Swaging Sleeve for Flemish Eye	109
Swivel Rigging Hook	90
T	
THK Horizontal Plate Clamp.....	136
THS Plate Clamp	138
Tornado 360° Ratchet Lever Hoist	194
Transport (Binding) Chain (Grade 70)	148
TSH Screw Clamp	139
TTG Horizontal Girder Clamp.....	134
TTR Girder Clamp	132
Turnbuckles	103
W	
Weblok Assembly	80
Weld-On Grab Hooks	170
Welded Assembly (Grade 43).....	166
Welded Assembly (Grade 70).....	149
Weldless Rings	170
Wide Body Sub-Assembly with Flats.....	78, 95
Winch Line / Tail Chain	174
Wire Rope Clips.....	104
Y	
Yale® Import Weld-On Lifting Hook	91

PRODUCT NAME PAGE

SHACKLES

Shackles - Super Strong Anchor.....	47
Shackles - Super Strong Chain.....	48
Shackles - Alloy Anchor.....	49
Shackles - Carbon Anchor (Industrial/Government).....	50
Shackles - Carbon Chain (Industrial/Government).....	51
Shackles - Alloy Web Sling.....	52
Shackles - Carbon Web Sling.....	52
Shackles - Long Reach.....	53
Shackles - Trawling.....	53
Shackles - DNV.....	54
DNV Master Sub-Assembly.....	55

CHAIN SLINGS & COMPONENTS (Rated for Overhead Lifting)

HERC-ALLOY® 1000 (AND DUAL RATED) PRODUCTS

Chain (Herc-Alloy® 1000).....	62
Slings (Herc-Alloy® 1000) & Sling ID Tags.....	63
Master Link (Dual Rated).....	64
Sub-Assembly (Dual Rated).....	64
Pear Shaped Master Link (Herc-Alloy® 1000).....	65
EZ•Connect Master Link & Chain Shortener (Dual Rated).....	65
Hammerlok® (Dual Rated).....	66
Chain Shortener (Herc-Alloy 1000).....	66
Omegalok Connector (Dual Rated).....	66
Rigging Hook (Dual Rated).....	67
Clevlok® Sling Hook (Dual Rated).....	67
Eye Sling Hook (Dual Rated).....	67
Clevlok® Cradle Grab Hook (Dual Rated).....	68
Eye Cradle Grab Hook (Dual Rated).....	68
Clevlok® Foundry Hook (Dual Rated).....	69
Eye Foundry Hook (Dual Rated).....	69
Latchlok® Hook - Clevlok® Style (Herc-Alloy® 1000).....	70
Latchlok® Hook - Eye Style (Herc-Alloy® 1000).....	70
Latchlok® Hook - Swivel Style (Herc-Alloy® 1000).....	71

HERC-ALLOY 800® (AND DUAL RATED) PRODUCTS

Chain (Herc-Alloy 800®).....	74
Slings (Herc-Alloy 800®) & Sling ID Tags.....	75
Master Link (Dual Rated).....	76
Forged Master Link (Grade 80).....	76
Flat Bottom Master Link (Grade 80).....	77
Master Link with & without Flats (Grade 80).....	77
Sub-Assembly (Dual Rated).....	78
Wide Body Sub-Assembly with Flats.....	78
Grab Link (Grade 80).....	79
Master Ring (Grade 80).....	79
Hammerlok® (Grade 80).....	80
Weblok Assembly (Grade 80).....	80
Clevlok® Sling Hook (Dual Rated).....	81
Eye Sling Hook (Dual Rated).....	81
Clevlok® Grab Hook without Cradle (Grade 80).....	82
Clevlok® Cradle Grab Hook (Dual Rated).....	82
Eye Cradle Grab Hook (Dual Rated).....	83

PRODUCT NAME PAGE

Eye Foundry Hook (Dual Rated).....	83
------------------------------------	----

RIGGING HARDWARE

Shank Hook (Grade 80).....	88
Sorting Hook (Grade 80).....	88
Alloy "S" Hook (Grade 80).....	89
Plate Hook (Grade 80).....	89
Swivel Rigging Hook.....	90
Rigging Hook (Dual Rated).....	90
Replacement Latches (for swivel, rigging & shank hooks).....	91
Yale® Import Weld-On Lifting Hook.....	91
Replacement Hook with Latch.....	92
CLB Container Lifting Lugs.....	92
Master Link (Dual Rated).....	93
Forged Master Link (Grade 80).....	93
Master Link with & without Flats (Grade 80).....	94
DNV Master Sub-Assembly.....	95
Wide Body Sub-Assembly with Flats.....	95
Shoulder Eye Bolts.....	97
Heavy Duty® Hoist Ring.....	99
Specialty Engineered Hoist Ring.....	100
Hoist Ring (Metric).....	101
Hoist Ring Swivel.....	102
Turnbuckles.....	103
Wire Rope Clips.....	104
Mid-Grip Wire Rope Clips.....	105
Piggyback® Wedge Socket Clips.....	106
Bundling Clip.....	107
Swage Socket (Open).....	107
Swage Button.....	108
Swage Socket (Closed).....	108
Swaging Sleeve for Flemish Eye.....	109

HEAVY-DUTY CRANE HOOKS

Single Hooks.....	116
Ramshorn Hooks.....	118
Form B Ramshorn Hooks.....	120
Eye Hooks.....	122

BELOW THE HOOK ATTACHMENTS

CZ Universal Plate Clamp.....	128
CY Hinged Universal Plate Clamp.....	129
CX Heavy Duty Hinged Universal Plate Clamp.....	130
LJ Gentle Grip Clamp.....	131
TTR Girder Clamp.....	132
CH Heavy-Duty Horizontal Plate Clamp.....	133
CP Pile Pitching Clamp.....	134
TTG Horizontal Girder Clamp.....	134
CG Girder Turning Clamps.....	135
THK Horizontal Plate Clamp.....	136
HG High Grip Plate Clamp.....	137
THS Plate Clamp.....	138
TSH Screw Clamp.....	139
BTG Groundworks.....	140
CLB Container Lifting Lugs.....	140

PRODUCT NAME	PAGE
HGC Hand Grip Clamp.....	141
Cady Lifters	142

TRANSPORT CHAIN & ATTACHMENTS

Transport (Binding) Chain (Grade 70)	148
Welded Assembly (Grade 70)	149
Clevis Assembly (Grade 70)	150
Clevis Assembly with Import Hooks (Grade 70).....	150
Aircraft Assembly	151
Rivet Assembly (Grade 70).....	151
Chain Assembly with Grab, R and J/T Combo (Grade 70).....	152
Chain Assembly with J, Grab and J/T Combo (Grade 70).....	152
Cluster Assembly with Grab, R Hook & J/T Combo (Grade 70).....	152
Bridle Assembly Tow Tiger with J & J/T Combo (Grade 70).....	153
Bridle Assembly Tow Tiger with R & J/T Combo (Grade 70).....	153
J Hook	154
Recover "J" Hook Assemblies (Grade 70).....	154
Forged R, T & Mini J Hooks (Grade 70).....	155
Pear Links.....	155
Double Clevis (Mid-Link)	156
Clevis Grab Hook (Grade 70)	157
Clevis Grab Hook (Grade 80)	157
Eye Grab Hook (Grade 70)	158
Eye Grab Hook (Grade 80)	158
Clevis Slip Hook (Grade 70)	159
Eye Slip Hook (Grade 70)	159
Clevis Style Heavy-Duty Tie-Downs.....	160
Clevlok® Style Heavy-Duty Tie-Downs.....	160
Ratchet Binders Heavy-Duty Tie Downs.....	160
Forged Ratchet Load Binder	161
Removable Handle Load Binder	161
Forged Lever Load Binder.....	162
Specialty Forged Lever Load Binder.....	162
CMG Ratchet & Lever Binders	163
E-Z Pro® Cam Release Lever Binder.....	163
D-Rings	164
Sixth Wheel Ratchet.....	164
High Test Chain (Grade 43)	165
Clevis Assembly (Grade 43)	166
Welded Assembly (Grade 43)	166
Hanger Chain (Grade 30).....	167
Proof Coil Chain (Grade 30).....	167
Clevis Slip Hook (Grade 30/43)	168
Eye Slip Hook (Grade 30/43)	168
Clevis Grab Hook (Grade 30/43)	169
Eye Grab Hook (Grade 30/43)	169
Repair Link / Lap Link	170
Weld-On Grab Hooks.....	170

PRODUCT NAME	PAGE
Weldless Rings	170
Cold Shuts.....	171
Forged Triangles ("D" Rings)	171

SPECIALTY CHAIN & COMPONENTS

Straight Link Coil Chain.....	174
Straight Link Machine Chain	174
Winch Line / Tail Chain	174
Buoy Chain.....	175
Sash Chain	175
Drive Sprocket - Cast.....	176
Drive Sprocket - Replaceable Teeth.....	176
Long Wall Mining Chain.....	177
Padless Shackle Connectors	178
Special Chain Connector	178
Grinding Mill Liner Bolts	179

ENTERTAINMENT RIGGING PRODUCTS

Shackles - Theatrical.....	182
S.T.A.C. Chain	183
S.T.A.C. Chain Sets	183

HOISTS, TROLLEYS & BEAM CLAMPS

CM Tornado 360 ^o ™ Ratchet Lever Hoist	194
CM Bandit™ Ratchet Lever Hoist.....	198
CM Hurricane 360 ^o ™ Hand Chain Hoist	202
CTP Adjustable Trolley Clamp.....	204
Beam Clamp.....	205
Screwlok Beam Clamp with Shackle	206
SC Series Twin Beam Clamp.....	207

INDEX (BY PRODUCT CODE)

PRODUCT
CODE PAGE

00002145.....197	1006JJ.....103	1612EE.....103	3X866L.....103	433103.....99
00002383.....197	1009EE.....103	1612HE.....103	423001.....100	433105.....99
0404EE.....103	1009HE.....103	1612HH.....103	423002.....100	433106.....99
0404HE.....103	1009HH.....103	1612JE.....103	423003.....100	433107.....99
0404HH.....103	1009JE.....103	1612JJ.....103	423004.....100	433112.....99
0404JE.....103	1009JJ.....103	1618EE.....103	423005.....100	433212.....99
0404JJ.....103	1012EE.....103	1618HE.....103	423006.....100	433214.....99
0504EE.....103	1012HE.....103	1618HH.....103	423007.....100	433312.....99
0504HE.....103	1012HH.....103	1618JE.....103	423009.....100	433314.....99
0504HH.....103	1012JE.....103	1618JJ.....103	423050.....100	433401.....99
0504JE.....103	1012JJ.....103	1624EE.....103	423052.....100	433420.....99
0504JJ.....103	1206EE.....103	1624HE.....103	423053.....100	433424.....99
05500024.....204	1206HE.....103	1624HH.....103	423101.....100	433427.....99
05500025.....204	1206HH.....103	1624JE.....103	423102.....100	433432.....99
05500026.....204	1206JE.....103	1624JJ.....103	423103.....100	433512.....99
05500027.....204	1206JJ.....103	2012EE.....103	423105.....100	433515.....99
05500028.....204	1209EE.....103	2012JJ.....103	423106.....100	433516.....99
0606EE.....103	1209HE.....103	2018EE.....103	423107.....100	433612.....99
0606HE.....103	1209HH.....103	2018JJ.....103	423200.....100	433614.....99
0606HH.....103	1209JE.....103	2024EE.....103	423202.....100	433615.....99
0606JE.....103	1209JJ.....103	2024JJ.....103	423301.....100	433714.....99
0606JJ.....103	1212EE.....103	2412EE.....103	423320.....100	433716.....99
0806EE.....103	1212HE.....103	2412JJ.....103	423321.....100	434030.....102
0806HE.....103	1212HH.....103	2418EE.....103	423322.....100	434035.....102
0806HH.....103	1212JE.....103	2418HE.....103	423323.....100	434040.....102
0806JE.....103	1212JJ.....103	2418HH.....103	423324.....100	434045.....102
0806JJ.....103	1218EE.....103	2418JJ.....103	423325.....100	434050.....102
0809EE.....103	1218HE.....103	2424EE.....103	423327.....100	4340890.....175
0809HE.....103	1218HH.....103	2424HE.....103	423328.....100	4340890G.....175
0809HH.....103	1218JE.....103	2424HH.....103	423330.....100	4340990.....175
0809JE.....103	1218JJ.....103	2424JJ.....103	423331.....100	434101.....101
0809JJ.....103	1412EE.....103	3315WLP.....197	423332.....100	434102.....101
0812EE.....103	1412HE.....103	3403WLP.....197	423333.....100	434103.....101
0812HE.....103	1412HH.....103	34902R082P.....164	423401.....100	434105.....101
0812HH.....103	1412JE.....103	34902R132P.....164	423501.....100	434107.....101
0812JE.....103	1412JJ.....103	34902R202P.....164	423503.....100	4341090.....175
0812JJ.....103	1418EE.....103	37111.....164	423600.....100	434212.....101
09001W.....205	1418HE.....103	3X845L.....103	423701.....100	434214.....101
09002W.....205	1418HH.....103	3X846L.....103	423804.....102	434312.....101
09003W.....205	1418JE.....103	3X847L.....103	423812.....102	434314.....101
09004W.....205	1418JJ.....103	3X849L.....103	423813.....102	434401.....101
09005W.....205	1606EE.....103	3X850L.....103	43009.....170	434402.....101
1006EE.....103	1606HE.....103	3X851L.....103	43109.....170	434403.....101
1006HE.....103	1606HH.....103	3X852L.....103	43209.....170	434404.....101
1006HH.....103	1606JE.....103	3X853L.....103	433101.....99	434515.....101
1006JE.....103	1606JJ.....103	3X855L.....103	433102.....99	434516.....101

**PRODUCT
CODE** **PAGE**

434614.....101	47580069	4X1304..67, 88, 90, 91, 159	554615.....79	555246..... 64, 76, 93
434615.....101	47580169	4X1304M91	554617.....79	555274..... 64, 78
434714.....101	475802.....69	4X1304S91	554619.....79	555275..... 64, 78
434716.....101	48211.....91	4X1305.. 67, 88, 90-91, 159	554623.....79	555276..... 64, 78
43709.....170	48212.....91	4X1305M91	554627.....79	555277..... 64, 78
43809.....170	48213.....91	4X1305S91	554630.....79	555278..... 64, 78
456920.....97	48214.....91	4X1307..... 67, 88, 90, 91	554635.....79	555279..... 64, 78
456921.....97	48304.....162	4X1307M91	554636.....79	557037..... 63, 75
456922.....97	48304CMG.....163	4X1307S91	554640.....79	557193..... 63, 75
456923.....97	48305.....162	4X1309..... 67, 88, 90, 91	554702.....65	557716..... 67, 81
456924.....97	48305CMG.....163	4X1309M91	554706.....65	557718..... 67, 81
456925.....97	48306.....162	4X1309S91	554710.....65	557719..... 67, 81
456926.....97	48325.....162	4X1311..... 90, 91	554714.....65	557720..... 67, 81
456927.....97	48358..... 150, 151	4X1311M91	554719.....65	557721..... 67, 81
456928.....97	48360..... 150, 151	4X1311S91	554723.....65	557722..... 67, 81
456929.....97	48362CMG.....163	4X1315..... 90, 91	554726.....65	558332.....81
456930.....97	48363.....161	4X1315M91	554731.....65	558333.....81
457106..... 67, 75	48364.....161	4X1322..... 90, 91	554942..... 76, 93	558335.....81
458618..... 67, 81	48365..... 150, 151	4X1322M91	554944..... 76, 93	558618..... 67, 81
458622..... 67, 81	48366..... 150, 151	4X405..... 91, 159	554945..... 76, 93	558622..... 67, 81
458625..... 67, 81	48367..... 150, 151	4X406..... 91, 159	554949..... 76, 93	558625..... 67, 81
458628..... 67, 81	48385.....162	4X410.....91, 159, 168	554950.....77	558628..... 67, 81
458629..... 67, 81	48387..... 150, 151	4X412.....91	554951..... 76, 93	558629..... 67, 81
458630..... 67, 81	48395.....162	4X414.....91	554952..... 76, 93	558630..... 67, 81
458732.....81	48405CMG.....163	4X455321..... 67, 81	554957..... 76, 93	559100.....83
458733.....81	48455.....161	4X455322..... 67, 81	554965.....77	559124.....83
458735.....81	48458.....161	4X455325..... 67, 81	554966.....77	559387.....83
462528.....89	48769.....162	4X455328..... 67, 81	554969..... 76, 93	559724..... 68, 83
462537.....89	48810.....161	4X455329..... 67, 81	554970..... 76, 93	559725..... 68, 83
462550.....89	48811.....161	4X455330..... 67, 81	554980.....78	559737..... 68, 83
462562.....89	495784.....69	4X458321..... 67, 81	554981.....78	559750..... 68, 83
462575.....89	495821..... 66, 82	4X48211.....91	554983.....78	559762..... 68, 83
462587.....89	495821T.....69	4X48212.....91	555231..... 64, 76, 93	559775..... 68, 83
46565.....161	495822..... 66, 82	4X48213.....91	555232..... 64, 76, 93	562228.....89
46565H.....161	495823....66, 67, 69, 81, 82	4X48214.....91	555232S1.....65	562237.....89
46566.....161	495824..... 67, 69, 81	51091.....171	555232S2.....65	562250.....89
474503.....83	495825..... 67, 81	51191.....171	555235..... 64, 76, 93	562262.....89
474504.....83	495826..... 67, 81	51291.....171	555235S1.....65	562275.....89
474505.....83	495849..... 67, 81	51391.....171	555235S2.....65	562287.....89
474798..... 69, 83	496933.....97	51591.....171	555238..... 64, 76, 93	562300.....89
474799..... 69, 83	4X1302..67, 88, 90, 91, 159	554320.....79	555238S1.....65	562310.....89
474800..... 69, 83	4X1302M91	554326.....79	555238S2.....65	562325.....89
474801..... 69, 83	4X1302S91	554332.....79	555239S1.....65	562337.....89
474802..... 69, 83	4X1303..... 67, 88, 90, 91	554337.....79	555240..... 64, 76, 93	562350.....89
475798.....69	4X1303M91	554611.....79	555240S2.....65	5623A.....203
475799.....69	4X1303S91	554613.....79	555243..... 64, 76, 93	5624A.....203

INDEX (BY PRODUCT CODE)

PRODUCT
CODE PAGE

5625A.....203	60592.....169	620317.....174	638292.....150	639094BG.....150
5626A.....203	60692.....169	620319.....174	638292CRV.....151	639094CRV.....151
5627A.....203	607020.....74	620321.....174	638293.....150	639097.....150
5628A.....203	607028.....74	620325.....174	638293CRV.....151	644128.....66
5629A.....203	607031.....74	621309.....174	638294.....150	644138.....66
5630A.....203	607031CV20.....160	621311.....174	638294CRV.....151	644150.....66
5631A.....203	607031CV25.....160	621313.....174	638302.....149	644162.....66
5632A.....203	607037.....74	621317.....174	638306.....149	6510048.....175
5633A.....203	607037CL20.....160	621319.....174	638313.....150	6510049.....175
5634A.....203	607037CL25.....160	621321.....174	638317.....152	6510050.....175
5635A.....203	607037CV20.....160	621325.....174	638318.....152	6510051.....175
5636A.....203	607037CV25.....160	62273.....157	638323.....152	656005.....70, 71
5637A.....203	607050.....74	62373.....157	638324.....152	656010.....70, 71
5638A.....203	607050CL15.....160	627728.....151	638325.....152	656015.....70, 71
5639A.....203	607050CL20.....160	638010.....166	638326.....153	656020.....70, 71
5640A.....203	607050CV20.....160	638025.....166	638327.....153	657716.....67, 81
5641A.....203	607050CV25.....160	638208.....166	638328.....153	657718.....67, 81
5642A.....203	607062.....74	638215.....166	638329.....153	657719.....67, 81
5643A.....203	607075.....74	638216.....166	638330.....153	657720.....67, 81
5644A.....203	607087.....74	638217.....166	638331.....153	657721.....67, 81
5645A.....203	607101.....74	638219.....166	638332.....153	657722.....67, 81
5646A.....203	607128.....74	638220.....166	638333.....153	659232.....82
5651A.....203	607321.....62	638224.....149	638350.....150	659235.....82
5653A.....203	607328.....62	638226.....166	638350GGC20.....150	659238.....82
595523.....67, 81	607337CL20.....160	638240.....166	638558.....149	659239.....82
595525.....67, 81	607337CL25.....160	638241.....166	639024.....149	659430.....82
595528.....67, 81	607339.....62	638259.....149	639024BG.....149	659718.....68, 82
595529.....67, 81	607351.....62	638260.....149	639032GGC20.....150	659722.....68, 82
595530.....67, 81, 91	607363.....62	638264.....149	639032GGC25.....150	659725.....68, 82
595532.....81	607378.....62	638265.....150	639038GGC20.....150	659728.....68, 82
595533.....81, 91	608401.....166	638266.....150	639038GGC25.....150	659729.....68, 82
595535.....81	608927.....148	638267.....150	639058.....149	659730.....68
595780.....66, 69, 82	608935.....148	638268.....150	639060.....149	66173.....168
595780SP.....67, 81	608941.....148	638274.....150	639064.....149	66193.....168
595781.....66, 67, 69, 81, 82	608954.....148	638277.....150	639064BG.....149	66273.....168
595782.....66, 67, 81, 82	609035.....148	638279.....150	639079.....150	66293.....168
595783.....82	609041.....148	638279BG.....150	639079CRV.....151	66373.....168
595785.....66, 69	61193.....169	638281CRV.....151	639082.....150	66393.....168
595786.....67, 81	61293.....169	638282.....150	639084.....150	664021-2.....80
601710CMG.....167	61393.....169	638282CRV.....151	639084BG.....150	664028-2.....80
601711CMG.....167	61493.....169	638283.....150	639084CRV.....151	664038-2.....80
601712CMG.....167	61593.....169	638283CRV.....151	639089.....149	664050-2.....80
601714CMG.....167	61693.....169	638284.....150	639091.....150	664062-2.....80
602326.....66, 69, 82	620309.....174	638284CRV.....151	639092.....150	664075-2.....80
60392.....169	620311.....174	638291.....150	639093.....150	664089-2.....80
60492.....169	620313.....174	638291CRV.....151	639094.....150	664100-2.....80

PRODUCT CODE	PAGE				
664125-2	80	677013	74	679032	142
66473	168	677015	74	679033	142
66493	168	677016	74	683451	175
66573	168	677017	74	683452	175
66593	168	677018	74	683453	175
667021-2	66	677019	74	683454	175
667028-2	66	677070	74	683456	175
667038-2	66	677310	62	683457	175
667050-2	66	677311	62	683458	175
667062-2	66	677313	62	6905AWL	159
667075-2	66	677315	62	6905AZL	159
671040	167	677316	62	6906AWL	159
671041	167	677317	62	6906AZL	159
671042	167	678131	165	695178	174
671043	167	678132	165	695180	174
671045	167	678133	165	695183	174
671046	167	678136	165	695185	174
671047	167	678137	165	695550	182
671091	167	678141	165	695550D250	182
671092	167	678142	165	695550D500	182
671093	167	678143	165	695575	182
671340	167	678145	165	695576	182
671341	167	678146	165	695577	182
671342	167	678147	165	695578	182
671343	167	678333	165	695579	182
671345	167	678341	165	695580	182
671346	167	678342	165	695581	182
671347	167	678343	165	695582	182
671352	167	678345	165	695583	182
671391	167	678346	165	695584	182
671393	167	678347	165	695585	182
671394	167	678517	142	695586	182
671410	167	678518	142	695587	182
671411	167	678519	142	695714C	177
671412	167	678521	142	695717C	177
671413	167	678522	142	695718	177
671415	167	678523	142	695721C	177
671440	167	678525	142	695722	177
671441	167	678531	142	695724	177
671442	167	678532	142	695727C	177
671443	167	678533	142	695729	177
671445	167	678535	142	697101	108
671491	167	679018	142	697102	108
671492	167	679019	142	697104	108
677010	74	679022	142	697105	108
677011	74	679023	142	697107	108
				697109	108
				697110	108
				697111	108
				697112	108
				697113	108
				697120	107
				697122	107
				697123	107
				697124	107
				697125	107
				697126	107
				697127	107
				697128	107
				697129	107
				697130	107
				697131	107
				697132	107
				697134	107
				697152	108
				697153	108
				697154	108
				697155	108
				697156	108
				697157	108
				697159	108
				697162	108
				697163	108
				697164	108
				697180	109
				697181	109
				697182	109
				697184	109
				697186	109
				697187	109
				697188	109
				697189	109
				697191	109
				697193	109
				697194	109
				697195	109
				697196	109
				697197	109
				71193	169
				71293	169
				71297	158
				71393	169
				71493	169
				71497	158
				71593	169
				71693	169
				71793	169
				74294	168
				74694	168
				75143	168
				75193	168
				75199	168
				75243	168
				75293	168
				75299	168
				75343	168
				75393	168
				75493	168
				75543	168
				75593	168
				75693	168
				75793	168
				84291	170
				84591	170
				84891	170
				84991	170
				867025-4	80
				867030-4	80
				867035-4	80
				867040-4	80
				90210	171
				90242	154
				90243	154
				90282	154
				90283	154
				90300	170
				90304	170
				90305	170
				91255	154
				91259	154
				92150	154
				921500	128
				92151	154
				92180	154
				92181	154
				922000	128
				923000	128
				92500	128

INDEX (BY PRODUCT CODE)

PRODUCT
CODE PAGE

92501.....164	CH2.....133	M129H.....88	M254D.....106	M3507A.....90
92504.....164	CH2/L.....133	M1302A.....88	M2550.....105	M3509A.....90
92505.....164	CH4.....133	M1303A.....88	M2551.....105	M350A.....49
92711.....155	CH4/L.....133	M1304A.....88	M255.....104	M350AG.....49
92714.....155	CH6.....133	M1305A.....88	M255B.....107	M350AP.....49
92855.....154	CH6/L.....133	M1307A.....88	M255D.....106	M350G.....47
92859.....154	CH8.....133	M1309A.....88	M256.....104	M350P.....47
93200.....164	CH8/L.....133	M134.....92	M256D.....106	M351.....47
93210.....164	CLB40.....92, 140	M14HC.....178	M257.....104	M3511A.....90
93220.....155	CP2.....134	M14JL.....178	M257D.....106	M3515A.....90
93405.....155	CP3.....134	M14JL4.....178	M258.....104	M351A.....49
93406.....155	CP5.....134	M18HC4.....178	M258D.....106	M351AG.....49
93423.....155	CX10000.....130	M18JL.....178	M26JL.....178	M351AP.....49
93424.....155	CX10000L.....130	M18JL4.....178	M26JL4.....178	M351G.....47
95610.....164	CX3000.....130	M204A.....158	M296.....104	M351P.....47
95660.....155	CX6000.....130	M205A.....158	M296D.....106	M352.....47
95664.....155	CX6000L.....130	M206A.....158	M308A.....159	M3522A.....90
95671.....155	CX8000.....130	M207A.....158	M310A.....159	M352A.....49
95675.....155	CX8000L.....130	M208A.....158	M3402A.....90	M352AG.....49
97901G8.....154	CY1.....129	M210A.....158	M3403A.....90	M352AP.....49
BAN07505.....201	CY2.....129	M2252.....105	M3404A.....90	M352G.....47
BAN07510.....201	CY3.....129	M22JL.....178	M3405A.....90	M352P.....47
BAN07515.....201	CZ10.....128	M22JL4.....178	M3407A.....90	M353.....47
BAN07520.....201	CZ10L.....128	M244.....104	M3409A.....90	M353A.....49
BAN15005.....201	CZ15.....128	M245.....104	M3411A.....90	M353AG.....49
BAN15010.....201	CZ15L.....128	M246.....104	M3415A.....90	M353AP.....49
BAN15015.....201	CZ20.....128	M247.....104	M3422A.....90	M353G.....47
BAN15020.....201	CZ20L.....128	M248.....104	M345.....47	M353P.....47
BAN30005.....201	CZ30.....128	M248D.....106	M345G.....47	M354.....47
BAN30010.....201	CZ4.....128	M249.....104	M346.....47	M354A.....49
BAN30015.....201	CZ4L.....128	M249D.....106	M346G.....47	M354AG.....49
BAN30020.....201	CZ6.....128	M250.....104	M346P.....47	M354AP.....49
BAN60005.....201	CZ8.....128	M250D.....106	M347.....47	M354G.....47
BAN60010.....201	CZ8L.....128	M251.....104	M347G.....47	M354P.....47
BAN60015.....201	HG1000.....137	M251D.....106	M347P.....47	M355.....47
BAN60020.....201	HG2000.....137	M252.....104	M348.....47	M355A.....49
BTG1500/3.....140	HG3000.....137	M252B.....107	M348G.....47	M355AG.....49
BTG3000/3.....140	HG4000.....137	M252D.....106	M348P.....47	M355AP.....49
BTG3000L/3.....140	HG500.....137	M253.....104	M349.....47	M355G.....47
CG1.....135	HGC.....141	M253B.....107	M349G.....47	M355P.....47
CG2.....135	HH8.....133	M253D.....106	M349P.....47	M356.....47
CG4.....135	HH8/L.....133	M254.....104	M350.....47	M356A.....49
CG6.....135	LJ1500.....131	M2546.....105	M3502A.....90	M356AG.....49
CH1.....133	LJ500.....131	M2547.....105	M3503A.....90	M356AP.....49
CH10.....133	M100P.....76, 93	M2548.....105	M3504A.....90	M356G.....47
CH10/L.....133	M129.....88	M254B.....107	M3505A.....90	M356P.....47

**PRODUCT
CODE** **PAGE**

M357.....	47	M550.....	48	M626010.....	70	M648G.....	47	M652G.....	47
M357A.....	49	M550G.....	48	M626015.....	70	M648P.....	47	M652P.....	47
M357AG.....	49	M550P.....	48	M626020.....	70	M649.....	47	M653.....	47
M357AP.....	49	M551.....	48	M62P.....	76, 93	M649A.....	49	M653A.....	49
M357G.....	47	M551G.....	48	M6304.....	159	M649AG.....	49	M653AG.....	49
M357P.....	47	M551P.....	48	M6304WL.....	159	M649AP.....	49	M653AP.....	49
M358.....	47, 50	M552.....	48	M6305.....	159	M649B.....	183	M653B.....	183
M358A.....	49	M552G.....	48	M6305WL.....	159	M649G.....	47	M653G.....	47
M358AG.....	49	M552P.....	48	M6306.....	159	M649P.....	47	M653P.....	47
M358AP.....	49	M553.....	48	M6306WL.....	159	M650.....	47	M654.....	47
M358G.....	47, 50	M553G.....	48	M6307.....	159	M6502A.....	90	M654A.....	49
M358P.....	47	M553P.....	48	M6307WL.....	159	M6502C.....	90	M654AG.....	49
M366.....	47	M554.....	48	M6402A.....	90	M6503A.....	90	M654AP.....	49
M366A.....	49	M554G.....	48	M6402C.....	90	M6503C.....	90	M654B.....	183
M366AG.....	49	M554P.....	48	M6403A.....	90	M6504A.....	90	M654G.....	47
M366AP.....	49	M555.....	48	M6403C.....	90	M6504C.....	90	M654P.....	47
M366G.....	47	M555G.....	48	M6404A.....	90	M6505A.....	90	M655.....	47
M366P.....	47	M555P.....	48	M6404C.....	90	M6505C.....	90	M655A.....	49
M377.....	47	M556.....	48	M6405A.....	90	M6507A.....	90	M655AG.....	49
M377A.....	49	M556G.....	48	M6405C.....	90	M6507C.....	90	M655AP.....	49
M377AG.....	49	M556P.....	48	M6407A.....	90	M6509A.....	90	M655G.....	47
M377AP.....	49	M557.....	48	M6407C.....	90	M6509C.....	90	M655P.....	47
M377G.....	47	M557G.....	48	M6409A.....	90	M650A.....	49	M656.....	47
M377P.....	47	M557P.....	48	M6409C.....	90	M650AG.....	49	M656A.....	49
M385.....	47	M558.....	48, 51	M6411A.....	90	M650AP.....	49	M656AG.....	49
M385A.....	49	M558G.....	48, 51	M6411C.....	90	M650B.....	183	M656AP.....	49
M385AG.....	49	M558P.....	48	M6415A.....	90	M650G.....	47	M656G.....	47
M385AP.....	49	M558P.....	48	M6415C.....	90	M650P.....	47	M656P.....	47
M385G.....	47	M566.....	48	M6422A.....	90	M651.....	47	M657.....	47
M385P.....	47	M566G.....	48	M6422C.....	90	M6511A.....	90	M657A.....	49
M449G*.....	53	M566P.....	48	M645.....	47	M6511C.....	90	M657AG.....	49
M450.....	53	M577.....	48	M645B.....	183	M6515A.....	90	M657AP.....	49
M451.....	53	M577G.....	48	M645G.....	47	M6515C.....	90	M657G.....	47
M452.....	53	M577P.....	48	M646.....	47	M651A.....	49	M657P.....	47
M453.....	53	M585.....	48	M646B.....	183	M651AG.....	49	M658.....	47, 50
M454.....	53	M585G.....	48	M646G.....	47	M651AP.....	49	M658A.....	49
M50P.....	76, 93	M585P.....	48	M646P.....	47	M651B.....	183	M658AG.....	49
M546.....	48	M605.....	156	M647.....	47	M651G.....	47	M658AP.....	49
M546G.....	48	M606.....	156	M647B.....	183	M651P.....	47	M658G.....	47, 50
M546P.....	48	M608.....	156	M647G.....	47	M652.....	47	M658P.....	47, 50
M547.....	48	M610.....	156	M647P.....	47	M6522A.....	90	M666.....	47
M547G.....	48	M616005.....	70	M648.....	47	M6522C.....	90	M666A.....	49
M547P.....	48	M616010.....	70	M648A.....	49	M652A.....	49	M666AG.....	49
M548.....	48	M616015.....	70	M648AG.....	49	M652AG.....	49	M666AP.....	49
M548G.....	48	M616020.....	70	M648AP.....	49	M652AP.....	49	M666G.....	47
M548P.....	48	M626005.....	70	M648B.....	183	M652B.....	183	M666P.....	47

INDEX (BY PRODUCT CODE)

PRODUCT
CODE PAGE

M676005.....71	M71805A-266	M757.....48	M850G.....47	M856G.....47
M676010.....71	M71806A-266	M757G.....48	M850P.....47	M856P.....47
M676015.....71	M71808A-266	M757P.....48	M851.....47	M857.....47
M676020.....71	M71810A-266	M758.....48, 51	M851A.....49	M857A.....49
M677.....47	M7402A67	M758G.....48, 51	M851AG.....49	M857ADNV.....54
M677A.....49	M7403A67	M758P.....48	M851AP.....49	M857AG.....49
M677AG.....49	M7404A67	M75P.....76, 93	M851G.....47	M857AP.....49
M677AP.....49	M7405A67	M766.....48	M851P.....47	M857DNV.....54
M677G.....47	M7407A67	M766G.....48	M852.....47	M857G.....47
M677P.....47	M7409A67	M766P.....48	M852A.....49	M857P.....47
M685.....47	M746.....48	M777.....48	M852ADNV.....54	M858.....47
M685A.....49	M746G.....48	M777G.....48	M852AG.....49	M858A.....49
M685AG.....49	M746P.....48	M777P.....48	M852AP.....49	M858AG.....49
M685AP.....49	M747.....48	M785.....48	M852DNV.....54	M858AP.....49
M685G.....47	M747G.....48	M785G.....48	M852G.....47	M858G.....47
M685P.....47	M747P.....48	M785P.....48	M852P.....47	M858P.....47
M6905A.....159	M748.....48	M804A.....157	M853.....47	M866.....47
M6905AZ.....159	M748G.....48	M805A.....157	M853A.....49	M866A.....49
M6906A.....159	M748P.....48	M806A.....157	M853ADNV.....54	M866ADNV.....54
M6906AZ.....159	M750.....48	M807A.....157	M853AG.....49	M866AG.....49
M696005.....71	M750G.....48	M808A.....157	M853AP.....49	M866AP.....49
M696010.....71	M750P.....48	M810A.....157	M853DNV.....54	M866DNV.....54
M696015.....71	M7502A.....67	M812.....169	M853G.....47	M866G.....47
M696020.....71	M7503A.....67	M812Z.....169	M853P.....47	M866P.....47
M702.....52	M7504A.....67	M846.....47	M854.....47	M877.....47
M703.....52	M7505A.....67	M846G.....47	M854A.....49	M877A.....49
M703A.....52	M7507A.....67	M846P.....47	M854ADNV.....54	M877ADNV.....54
M704.....52	M7509A.....67	M847.....47	M854AG.....49	M877AG.....49
M704A.....52	M751.....48	M847G.....47	M854AP.....49	M877AP.....49
M705.....52	M751G.....48	M847P.....47	M854DNV.....54	M877DNV.....54
M705A.....52	M751P.....48	M848.....47	M854G.....47	M877G.....47
M706.....52	M752.....48	M848A.....49	M854P.....47	M877P.....47
M706A.....52	M752G.....48	M848AG.....49	M855.....47	M885.....47
M706H.....52	M752P.....48	M848AP.....49	M855A.....49	M885A.....49
M7151.....53	M753.....48	M848G.....47	M855ADNV.....54	M885AG.....49
M7151P.....53	M753G.....48	M848P.....47	M855AG.....49	M885AP.....49
M7152.....53	M753P.....48	M849.....47	M855AP.....49	M885G.....47
M7152P.....53	M754.....48	M849A.....49	M855DNV.....54	M885P.....47
M7154.....53	M754G.....48	M849AG.....49	M855G.....47	M904A.....159
M7154P.....53	M754P.....48	M849AP.....49	M855P.....47	M905A.....159
M7156.....53	M755.....48	M849G.....47	M856.....47	M906A.....159
M7156P.....53	M755G.....48	M849P.....47	M856A.....49	M907A.....159
M7157.....53	M755P.....48	M850.....47	M856ADNV.....54	M908A.....159
M7157P.....53	M756.....48	M850A.....49	M856AG.....49	M910A.....159
M7177.....53	M756G.....48	M850AG.....49	M856AP.....49	M910Z.....168
M7177P.....53	M756P.....48	M850AP.....49	M856DNV.....54	M9151.....53

**PRODUCT
CODE** **PAGE**

M9151P53	M958P48	MC54851	MC652P50	MC785G51
M915253	M96648	MC548G51	MC65350	MC84650
M9152P53	M966G48	MC55051	MC653G50	MC846G50
M915453	M966P48	MC550G51	MC653P50	MC84750
M9154P53	M97748	MC55151	MC65450	MC847G50
M915653	M977G48	MC551G51	MC654G50	MC84850
M9156P53	M977P48	MC55251	MC654P50	MC848G50
M915753	M98548	MC552G51	MC65550	MC84950
M9157P53	M985G48	MC55351	MC655G50	MC849G50
M917753	M985P48	MC553G51	MC65650	MC85050
M9177P53	MC34550	MC55451	MC656G50	MC850G50
M94648	MC345G50	MC554G51	MC65750	MC85150
M946G48	MC34650	MC55551	MC657G50	MC851G50
M946P48	MC346G50	MC555G51	MC66650	MC85250
M94748	MC34750	MC55651	MC666G50	MC852G50
M947G48	MC347G50	MC556G51	MC67750	MC85350
M947P48	MC34850	MC55751	MC677G50	MC853G50
M94848	MC348G50	MC557G51	MC68550	MC85450
M948G48	MC34950	MC56651	MC685G50	MC854G50
M948P48	MC349G50	MC566G51	MC74651	MC85550
M95048	MC35050	MC57751	MC746G51	MC855G50
M950G48	MC350G50	MC577G51	MC74751	MC85650
M950P48	MC35150	MC58551	MC747G51	MC856G50
M95148	MC351G50	MC585G51	MC74851	MC85750
M951G48	MC35250	MC64550	MC748G51	MC857G50
M951P48	MC352G50	MC645G50	MC75051	MC86047, 50
M95248	MC35350	MC64650	MC750G51	MC860A49
M952G48	MC353G50	MC646G50	MC75151	MC860AG49
M952P48	MC35450	MC646P50	MC751G51	MC860G47, 50
M95348	MC354G50	MC64750	MC75251	MC86250
M953G48	MC35550	MC647G50	MC752G51	MC862A49
M953P48	MC355G50	MC647P50	MC75351	MC862AG49
M95448	MC35650	MC64850	MC753G51	MC862G50
M954G48	MC356G50	MC648G50	MC75451	MC86450
M954P48	MC35750	MC648P50	MC754G51	MC864A49
M95548	MC357G50	MC64950	MC75551	MC864AG49
M955G48	MC36650	MC649G50	MC755G51	MC86650
M955P48	MC366G50	MC649P50	MC75651	MC866G50
M95648	MC37750	MC65050	MC756G51	MC87750
M956G48	MC377G50	MC650G50	MC75751	MC877G50
M956P48	MC38550	MC650P50	MC757G51	MC88550
M95748	MC385G50	MC65150	MC76651	MC885G50
M957G48	MC54651	MC651G50	MC766G51	MC94651
M957P48	MC546G51	MC651P50	MC77751	MC946G51
M95848, 51	MC54751	MC65250	MC777G51	MC94751
M958G48, 51	MC547G51	MC652G50	MC78551	MC947G51

INDEX (BY PRODUCT CODE)

PRODUCT
CODE PAGE

MC948.....51	R664038-2.....80	THK6000.....136	TSH1500.....139
MC948G.....51	R664050-2.....80	THK750.....136	TSH3000.....139
MC950.....51	R664062-2.....80	THK9000.....136	TSH5000.....139
MC950G.....51	R664075-2.....80	THS1500.....138	TTG1500.....134
MC951.....51	R664089-2.....80	THS4500.....138	TTG3000.....134
MC951G.....51	R664100-2.....80	THS750.....138	TTG4500.....134
MC952.....51	R664125-2.....80	TOR07505.....197	TTG7500.....134
MC952G.....51	R667021-2.....65	TOR07505LL.....197	TTR1500.....132
MC953.....51	R667028-2.....65	TOR07510.....197	TTR3000.....132
MC953G.....51	R667038-2.....65	TOR07510LL.....197	TTR750.....132
MC954.....51	R667050-2.....65	TOR07515.....197	
MC954G.....51	R667062-2.....65	TOR07515LL.....197	
MC955.....51	R667075-2.....65	TOR07520.....197	
MC955G.....51	SA050.....78, 95	TOR07520LL.....197	
MC956.....51	SA063.....78, 95	TOR075LCX.....197	
MC956G.....51	SA075.....78, 95	TOR075LCXLL.....197	
MC957.....51	SA087.....78, 95	TOR15005.....197	
MC957G.....51	SA100.....78, 95	TOR15005LL.....197	
MC966.....51	SA125.....78, 95	TOR15010.....197	
MC966G.....51	SA125DNV.....55, 95	TOR15010LL.....197	
MC977.....51	SA150.....78, 95	TOR15015.....197	
MC977G.....51	SA150DNV.....55, 95	TOR15015LL.....197	
MC985.....51	SA175.....78, 95	TOR15020.....197	
MC985G.....51	SA175DNV.....55, 95	TOR15020LL.....197	
ML040.....77, 78, 94, 95	SA200.....78, 95	TOR150LCX.....197	
ML040NF.....77, 94	SA200DNV.....55, 95	TOR150LCXLL.....197	
ML050.....77, 78, 94, 95	SA225.....78, 95	TOR30005.....197	
ML050NF.....77, 94	SA250.....78, 95	TOR30005LL.....197	
ML063.....77, 78, 94, 95	SA275.....78, 95	TOR30010.....197	
ML063NF.....77, 94	SC921.....206	TOR30010LL.....197	
ML075.....77, 78, 94, 95	SC9210.....206	TOR30015.....197	
ML075NF.....77, 94	SC922.....206	TOR30015LL.....197	
ML087.....77, 78, 94, 95	SC922T.....207	TOR30020.....197	
ML087NF.....77, 94	SC923.....206	TOR30020LL.....197	
ML100.....77, 78, 94, 95	SC923/L.....206	TOR300LCX.....197	
ML100NF.....77, 94	SC923/LT.....207	TOR300LCXLL.....197	
ML125.....77, 78, 94, 95	SC923T.....207	TOR60005.....197	
ML125NF.....77, 94	SC925.....206	TOR60005LL.....197	
ML150.....77, 78, 94, 95	SC925/L.....206	TOR60010.....197	
ML175.....77, 78, 94, 95	SC925/LT.....207	TOR60010LL.....197	
ML200.....77, 78, 94, 95	SC925L.....207	TOR60015.....197	
ML225.....77, 78, 94, 95	SP595778.....67, 81	TOR60015LL.....197	
ML250.....77, 78, 94, 95	SP595782.....69	TOR60020.....197	
ML275.....77, 78, 94, 95	SP595783P.....67, 81	TOR60020LL.....197	
R664021-2.....80	THK1500.....136	TOR600LCX.....197	
R664028-2.....80	THK4500.....136	TOR600LCXLL.....197	



YOUR ONE SOURCE FOR FLOOR-TO-CEILING SYSTEMS

Since 1875, Columbus McKinnon has helped to make material handling easier and safer, and, today, is your single source for complete floor-to-ceiling lifting systems.

From below-the-hook attachments, chain, rigging products, manual and powered chain hoists to electric wire rope hoists, cranes, enclosed track systems and specially engineered products, Columbus McKinnon has the engineering expertise to meet the most demanding applications.



KNOW HOW. KNOW WHY.

Columbus McKinnon is committed to providing expert safety training on the proper use and inspection of rigging and overhead lifting equipment. Our company offers comprehensive programs at our national training centers as well as on-site at your facility. Courses include:

- Hoist Maintenance
- Safe Hoisting
- Rigging Gear Inspection
- Crane & Hoist Inspection
- Load Securement
- Crane Operator Training
- Rigging



Win in the marketplace with **CMCO University™**. This three-day program is designed to give Channel Partners intimate product and application knowledge that they can use to advise their end-user customers during the product selection and sales processes.

Columbus McKinnon's corporate headquarters in Getzville, New York, is home to our state-of-the-art **Niagara Training Center**. The 3,000-square-foot facility is dedicated to training Channel Partners and end users on the safe and proper use of hoist and rigging products. The Center offers a one-of-a-kind training experience on chain and rigging equipment with more than 75 manual and powered hoists, enclosed track systems and our 50-foot-wide crane system with 3-ton Yale Global King wire rope hoist.



USA 800.888.0985 • 716.689.5400 • fax: 716.689.5644

CANADA 877.264.6478 • fax: 877.264.6477

www.cmworks.com

