



PRODUCT CATALOGUE

GET IT DONESM

JULY 2013



THE Evolution OF Innovation



GearWrench® Hand Tools are warranted for Life to be free of defects in material and workmanship. Carrying cases, pouches, accessory bits and consumable products, if any, are not covered by this Warranty.

If use of any GearWrench® Hand Tool when used for its intended purpose, fails to give complete satisfaction, return it to your GearWrench® Distributor or contact Apex Tool Group and it will be repaired or replaced free of charge. *Except Torque Products

*GearWrench® Torque Products are warranted to (1) be free of defects in material and workmanship for one year and (2) meet out of the box calibration accuracy standards as stated in the product literature. Accuracy standards for calibration are warranted for 90 days from date of purchase. Products for which Warranty Repair is requested should be returned, at Buyer's cost, for evaluation to:

Warranty Service & Authorized Repair:
Apex Tool Group
519 Nurigong Street
Albury NSW 2640
Australia

GearWrench® Torque Products are precision instruments that contain moving parts. These components are subject to normal wear through use and replacement thereof is the responsibility of Buyer. Torque Products should be routinely checked for calibration at an Authorised Repair Centre using GearWrench® repair parts.

This Warranty shall not apply to Products which have been misused, abused, damaged by accident or otherwise, repaired by anyone other than an Authorised Repair Centre or modified by anyone other than Apex Tool Group and is in lieu of all other warranties, whether express, implied or statutory. THE IMPLIED WARRANTIES OF MERCHANT ABILITY AND FITNESS FOR A PARTICULAR PURPOSE ARE SPECIFICALLY EXCLUDED. Buyer's sole and exclusive remedy for breach of this Warranty is, at the option of Apex Tool Group, repair or replacement of the defective Product. IN NO EVENT WILL APEX TOOL GROUP BE LIABLE FOR ANY INDIRECT, SPECIAL, INCIDENTAL, CONSEQUENTIAL OR PUNITIVE DAMAGES ARISING FROM BREACH OF THIS WARRANTY, EVEN IF APEX TOOL GROUP HAS BEEN ADVISED OF THE POSSIBILITY OF SUCH DAMAGES.

The Apex Tool Group is not responsible for personal injury or damage resulting from improper tool usage, product modification, abuse or usage beyond expected product life.

For further information on GearWrench® Hand Tools, Torque Products or Authorised Repair Centres, please contact us at:

Apex Tool Group
519 Nurigong Street
Albury NSW 2640
Australia
Email: apextoolaus@apextoolgroup.com

Phone Number: 02 6058 0300

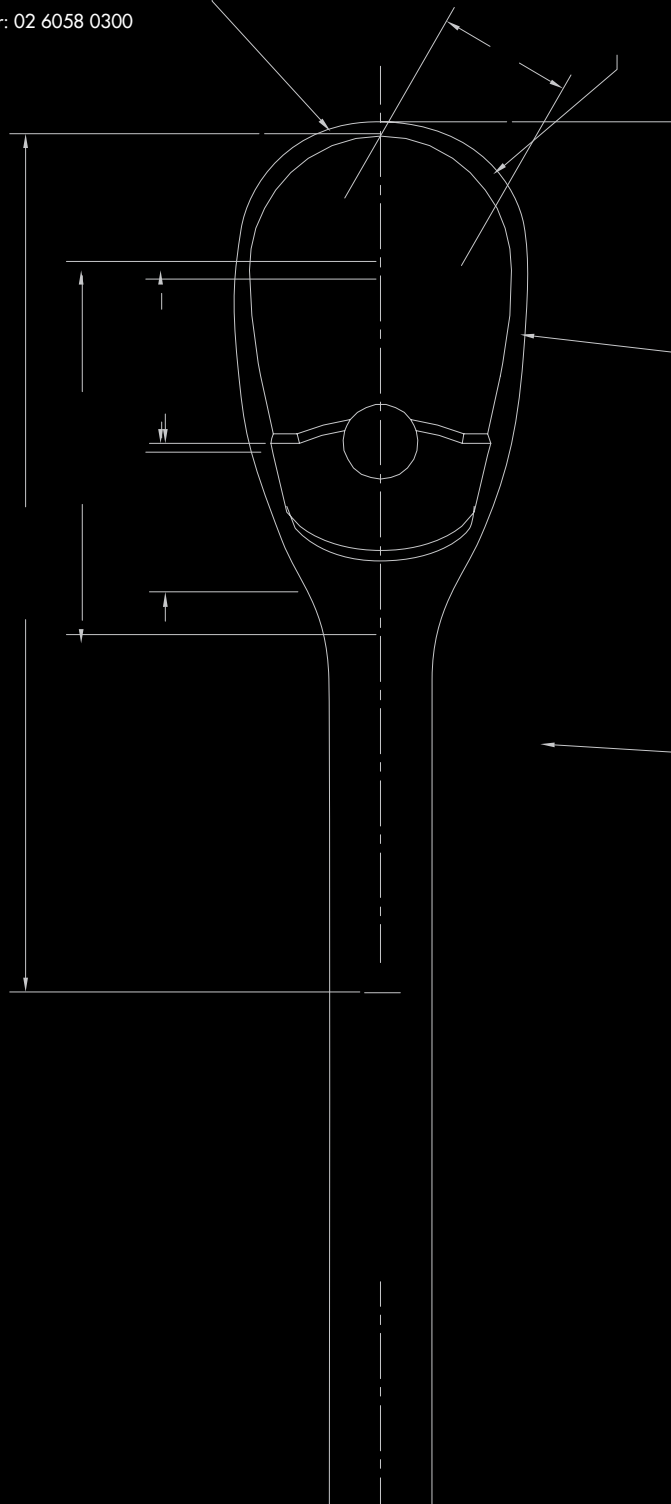
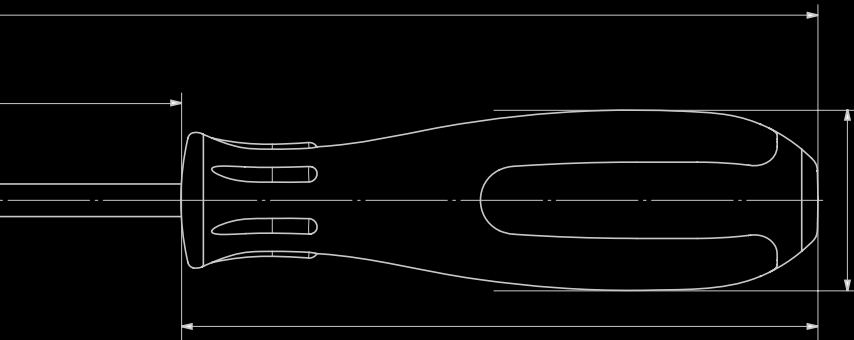

GEARWRENCH® is a registered trademark of EASCO Inc., an Apex Tool Group Company.















GearBox™, X-Beam™, Quadbox™, Vortex™, Pass-Thru®, GearPlier™, Double-X™, and GearDriver™ are trademarked registered brands of Apex Tool Group.



Apex Tool Group
519 Nurigong Street
Albury NSW 2640
Tel: sales (02) 6021 6666
Fax: sales 1800 021 940
Email: alburysales@apextoolgroup.com

www.apextoolgroup.com.au
www.gearwrench.com (USA website)

TABLE OF CONTENTS

TOOL SETS	11	
CABINETS & STORAGE	26	
MODULAR STORAGE SYSTEM	34	
RATCHETS, SOCKETS AND DRIVE TOOLS	44	
BIT SOCKETS AND FLEX HEX™ KEYS	98	
IMPACT SOCKETS	103	
WRENCHES	111	
TORQUE WRENCHES	163	
SCREWDRIVERS AND NUTDRIVERS	166	
PLIERS	174	
PRY BARS	180	
PUNCHES AND CHISELS	183	
RATCHETING TAPS AND DIES	186	
SPECIALTY AND GENERAL PURPOSE TOOLS	191	
INDEX	194	
TERMS AND CONDITIONS	207	
CUSTOMER SUPPORT	208	

GEARWRENCH®

THE EVOLUTION OF INNOVATION

GearWrench started in 1996, when we developed a ratcheting wrench that stood up to professional environments – the “Original” combination ratcheting wrench.

Noticing the need for more ratcheting options, we quickly expanded to stubby and double box as these were traditional non-ratcheting wrench configurations.

The Reversible and Flex style wrenches were born from user feedback, with an eye for how to work in tight spaces.

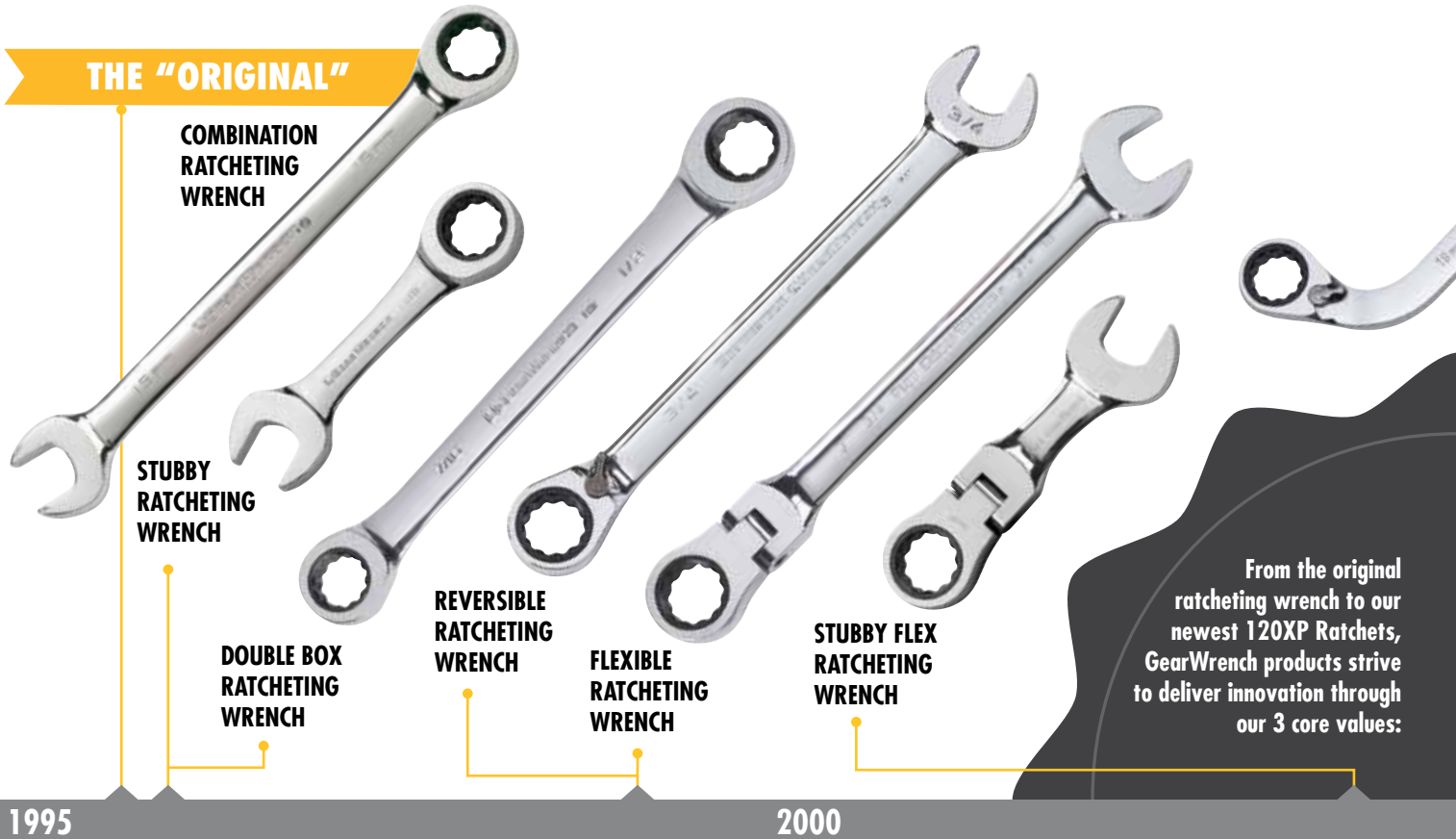

From the original ratcheting wrench to our newest 120XP Ratchets, GearWrench products strive to deliver innovation through our 3 core values:



GEARRATCHET VORTEX SOCKET SYSTEM



GEARDRIVER INTERCHANGABLE SHAFT SYSTEM

As more professionals began to use ratcheting wrenches, we spent time solving more access problems and introducing other wrench styles.

Having success in wrenches, we began to integrate ratcheting mechanisms into screwdrivers and other traditionally non-ratcheting tools.

GearWrench has continued to innovate products by adding productivity features to products like pry bars, hemostats, tool boxes, and ratchets.

SPEED STRENGTH ACCESS

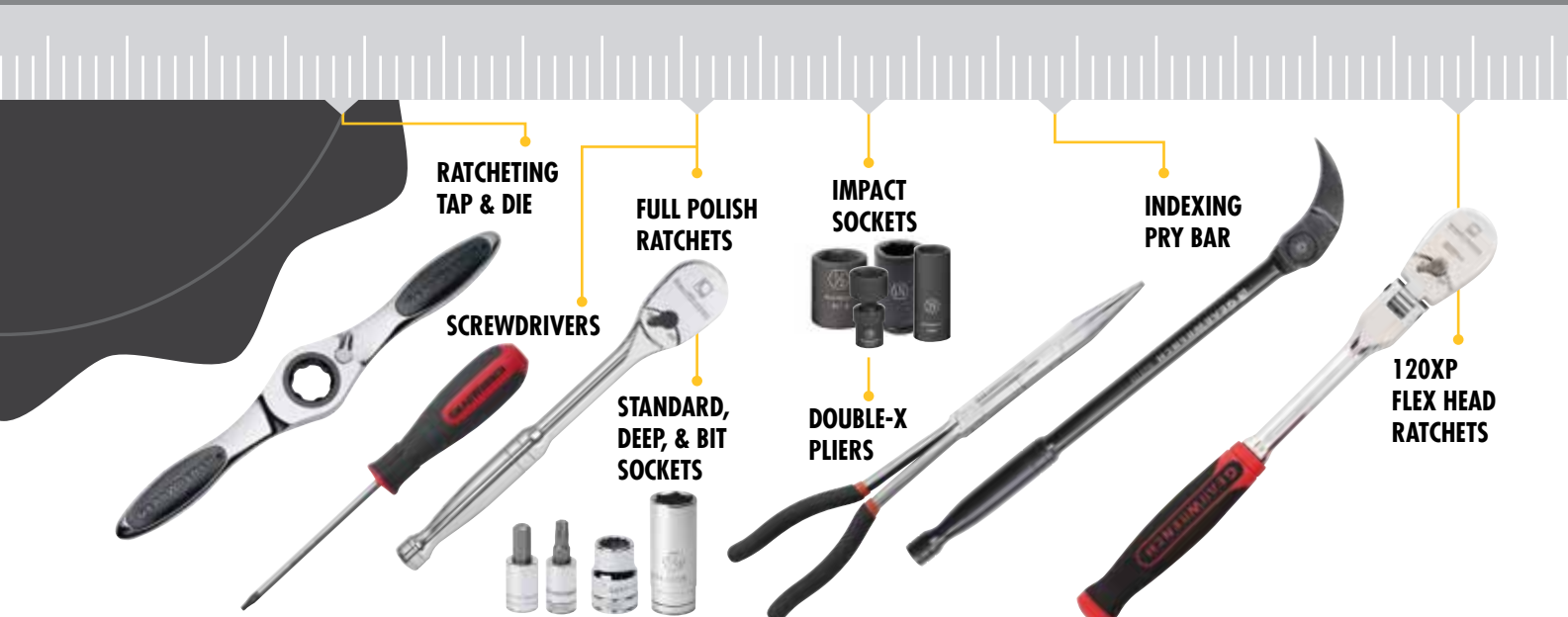
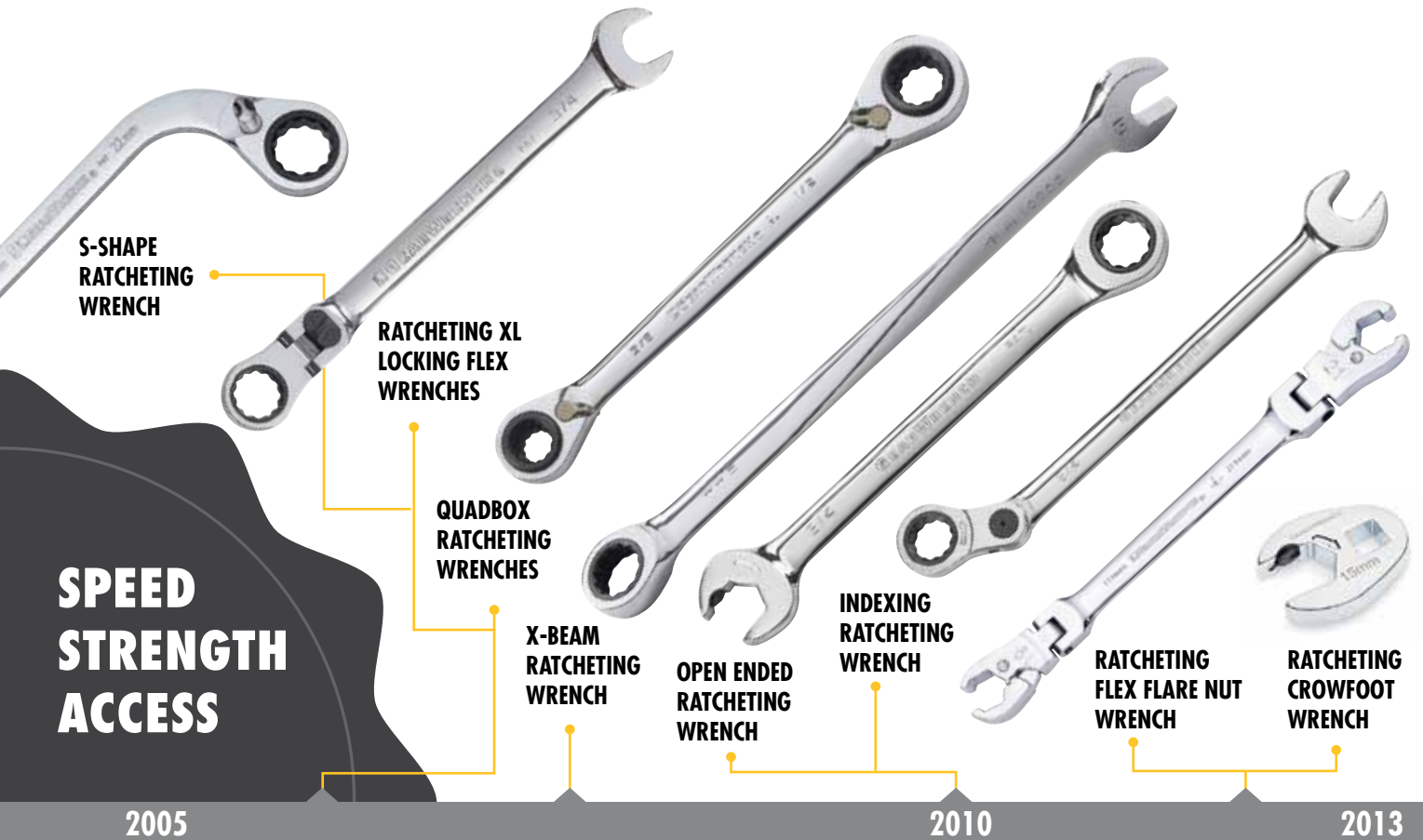

NEW PRODUCT HIGHLIGHTS

GearWrench has significantly expanded its product line of productivity solutions to help professional mechanics and technicians get their jobs done faster and easier. Look for these new items in this catalogue, online at www.gearwrench.com.au and from your GearWrench distributor.



Tool Chest & Roller Cabinet

Pg. 30

- Available in Red, Orange & Green
- 26" 8 drawer chest - 660W x 307D x 432mm High
- 27" 7 drawer roller cabinet - 678W x 459D x 859mm High
- Auto return drawers snap the drawer closed
- Durable powder-coated full polish lacquer coating protects against scratches and marring

120XP Ratchets

Pg's. 62, 68, 78, 86

- 120 positions give a 3° ratchet arc, enabling fasteners to be turned in tight spaces
- Full polish teardrop ratchet - 1/4", 3/8" & 1/2" drive
- Full polish flex teardrop ratchet - 1/4", 3/8" & 1/2" drive
- 3 piece full polish mixed ratchet set - 1/4", 3/8" & 1/2" drive

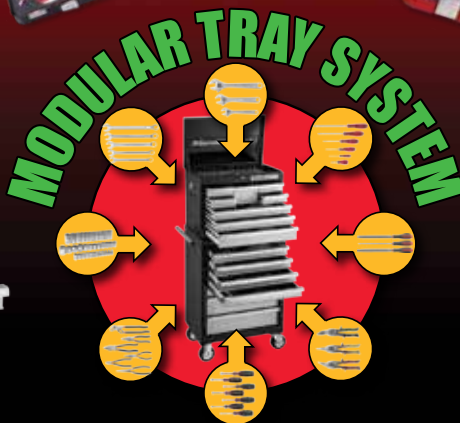

Modular Storage System

Pg. 34

- Designed to fit most tool chests and trolleys
- 3 small EVA trays with tools
- 5 large EVA trays with tools
- 3 blow moulded cases with tools
- 9 metal case sets with EVA trays and tools
- Tool trolley and tool chest storage



Ratcheting Crowfoot Wrench

Pg. 135

- Use with 3/8" drive extension to access hard to reach fasteners
- Ratcheting function allows rapid turning of fasteners without removing the wrench
- 10 piece ratcheting crowfoot set - METRIC
- 11 piece ratcheting crowfoot set - SAE



Ratcheting Flex Flare Nut Wrench

Pg. 134

- Flex head provides access to difficult to reach hose fittings
- Ratcheting function allows rapid turning of fasteners without removing the wrench
- 6 piece ratcheting flex flare nut wrench set - METRIC
- 5 piece ratcheting flex flare nut wrench set - SAE



INDUSTRY SOLUTIONS: *INDUSTRIAL & COMMERCIAL*

In today's industrial environment, mechanics rely on their tools to keep critical equipment operating with as little down time as possible. With manufacturing plants in 3 countries including the United States, GearWrench understands how critical it is to have the highest quality standards for manufacturing and the importance of dependable tools for the industry.

With nearly three thousand individual SKU's, GearWrench has one of the broadest and most complete professional hand tool lines in the market. We offer tools ranging from the precise to the nearly indestructible. No matter the industry you find yourself in, GearWrench has the tools to fit your needs.

- Industrial Maintenance & Repair Organisations
- Aviation
- Alternative Energy
- Commercial Construction



INDUSTRY SOLUTIONS

- Fully Featured Innovative Products
- Tool Sets and Tool Storage
- Tools for Students and Schools

Starting a new career can be one of the most nerve racking experiences in a person's life. For a mechanic or a technician, starting out can be especially tough when making that initial investment in the tools necessary to make a living in the future. GearWrench® can help ease that anxiety. We work with the leading instructors, institutions, and OEM manufacturers to ensure that when a student purchases a GearWrench® kit from an authorized distributor, they have the right tools for the job from day one, all without putting the student into severe debt. The bottom line is GearWrench® provides students with fully featured products at a significant value.

- Auto Body
- Diesel
- HVAC
- Hybrids
- Electrical
- Wind Energy



GEARWRENCH MOTORSPORTS AUSTRALASIA

GearWrench products in the Australasian market are backed and supported by an exciting motorsport program including the V8 Supercars, V8 Ute Series, Free-Style Motocross, Pro Stock Drag Racing and Sprint Car Racing. The V8 Supercars involves a partnership with leading V8 Supercars Team, Triple8 Racing and Red Bull Racing Australia.

Not only do the race teams put the Gearwrench tools to the test in the most arduous of environments, but they bring the excitement and energy of the GearWrench brand to the market through innovative promotions and events.



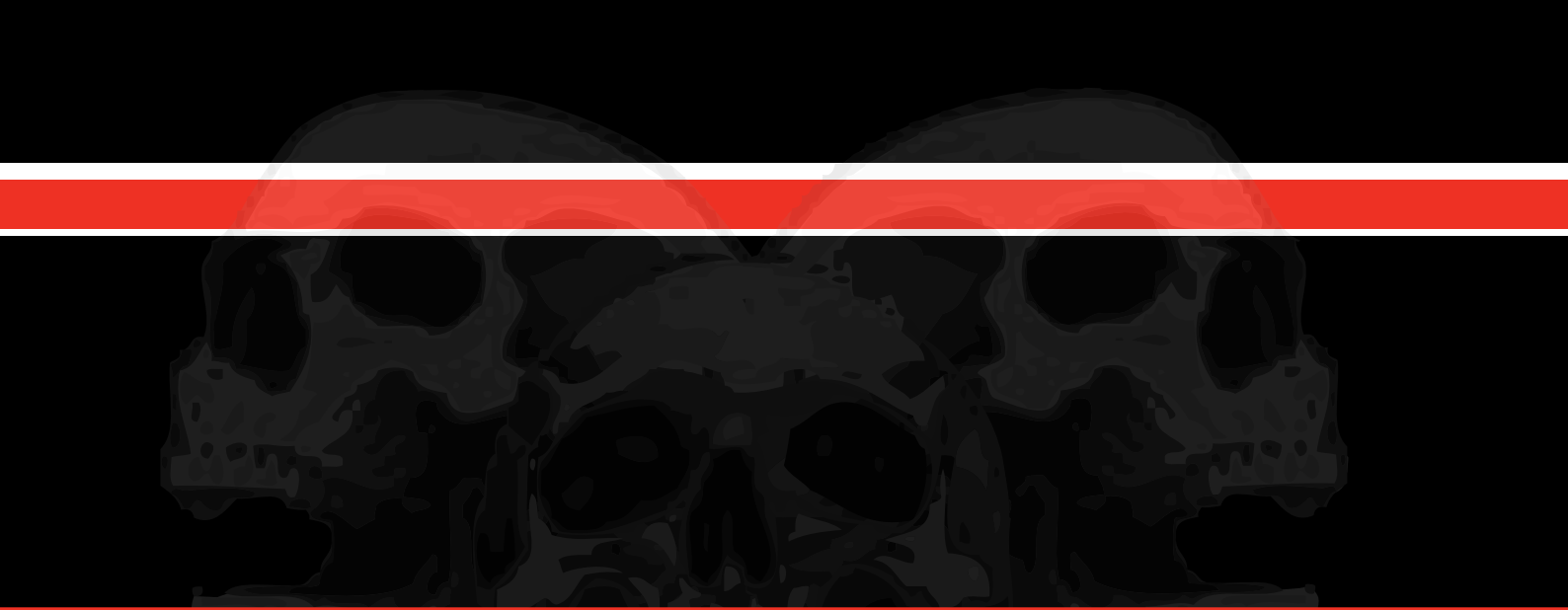

GEARWRENCH
GET IT DONE

THE Evolution OF Innovation

WEBSITE & FACEBOOK

Visit our websites www.gearwrench.com.au (Australasian website) and www.gearwrench.com (USA website) for the latest product reviews and information on what we're up to. Please note that not all products shown on the www.gearwrench.com (USA website) are available in the Australasian market. For Australasian product listing refer to www.apextoolgroup.com.au

- Australian Customer Service Line
- Get product dimensions and specifications
- Get images and other product details
- Get catalogues

TOOL SETS

Tool Sets

Introductory Sets
Career Builder Sets
Intermediate and Advanced Tool Sets

GearWrench® Tool Sets feature carefully designed sets to fully equip the Student Technician with the tools necessary to conquer the service and repair challenges in today's Automotive, Heavy Duty/Diesel, Machinery, and Aviation fields.

Each tool set features innovations in speed, access, and design; hallmarks that have established the GearWrench® brand as a leader in quality, professional hand tools.

Each Tool Set also includes storage for sockets, wrenches, screwdrivers, and other tools to help promote efficient tool organization.



GearWrench® understands the environment you work in because we work side-by-side with technicians to learn about frustrations firsthand, and develop innovative, new hand tools to solve day-to-day problems. We know you will make a living with your tools and you need just the right tools to help you work smarter and faster. Across various tool categories, we deliver superior products that do just that. Our commitment to delivering the most durable and reliable products while adding time-saving features makes this possible.

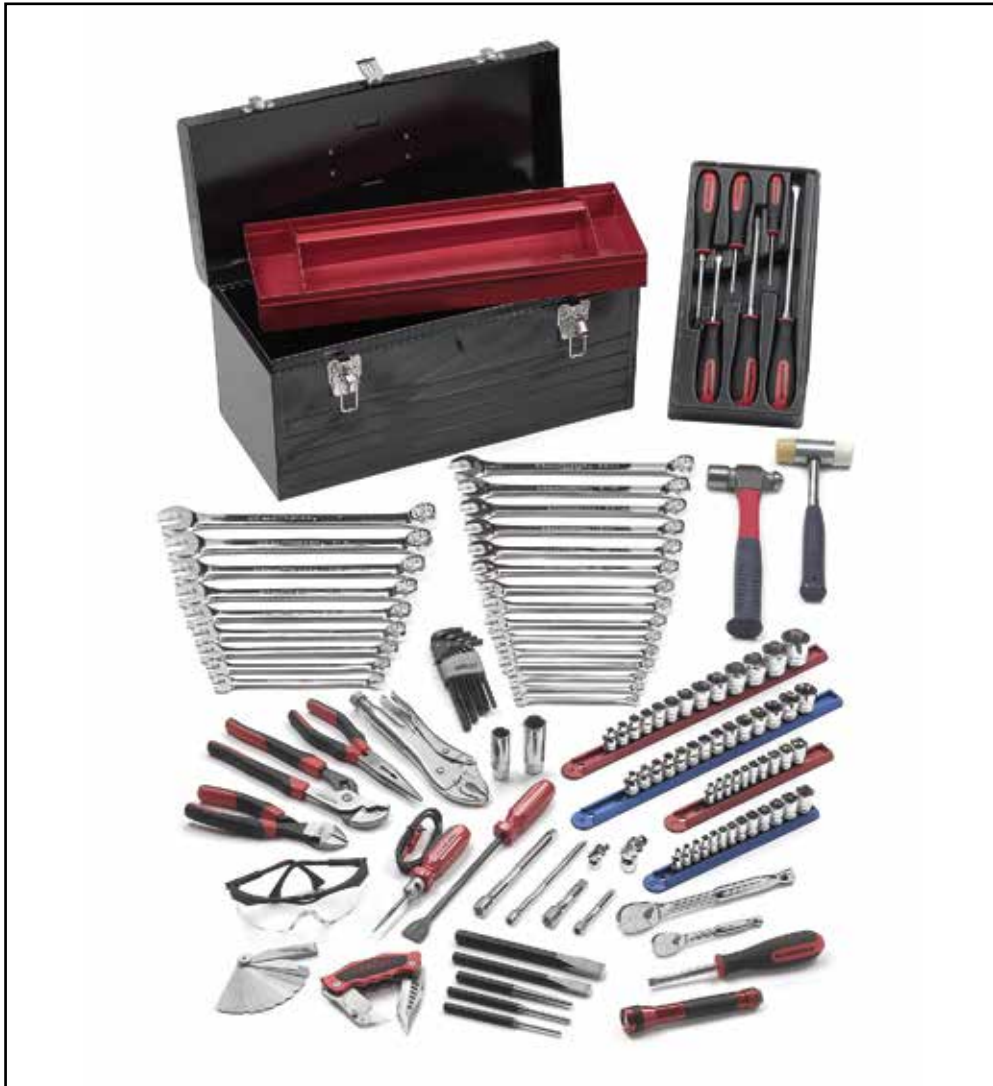

83090 - Auto Introductory Set SAE/METRIC

81658	5/8"	81670	13mm
81659	11/16"	81671	14mm
81660	3/4"	81672	15mm
81661	13/16"	81673	16mm
81662	7/8"	81674	17mm
81663	15/16"	81675	18mm
81664	1"	81676	19mm
81665	8mm	81677	20mm
81666	9mm	81678	21mm
81667	10mm	81679	22mm

Screwdrivers and Pliers

80050	6 Pc. Combination Screwdriver Set
80015	1/8" x 3" Slotted w/Cabinet Tip
80013	1/4" x 4" Slotted w/Hex Bolster
80023	5/16" x 6" Slotted w/Hex Bolster
80022	3/8" x 8" Slotted w/Hex Bolster
80001	#1 x 3" Phillips
80007	#2 x 4" Phillips w/Hex Bolster

82104 3 Pc. Mixed Pliers Set

82011	9.5" Tongue and Groove
82012	7" Diagonal Cutting
82013	8" Long Nose

Hex Keys

56603G 13 Pc. SAE ALLEN® Hex Key Set
 Sizes: 0.050", 1/16", 5/64", 3/32", 7/64", 1/8", 9/64", 5/32", 3/16", 7/32", 1/4", 5/16", 3/8"

Punches and Chisels

82304	5 Pc. Punch and Chisel Set
82270	3/8" x 5" Center Punch
82273	1/8" x 5" x 5/16" Pin Punch
82274	5/32" x 5-1/4" x 5/16" Pin Punch
82275	3/16" x 5-1/2" x 5/16" Pin Punch
82264	1/2" x 6" x 3/8" Cold Chisel

General Purpose Tools

82251	16 oz. Ball Pein Hammer - Fiberglass
82260	12 oz. Softface Hammer Removable Caps
82881	Folding Utility Knife
83132	Aluminum Flashlight
82041	10" Curved Jaw Locking Pliers
69-990	Safety Glasses

KD® Specialty Tools

KDS129	Low Voltage Circuit Tester
KDS162	16 Blade Feeler Gauge
KDS485	Gasket Scraper

Tool Storage

83130	Tote Box
-------	----------

Not all tools GearWrench® Branded

1/4" Drive Sockets

80302	13 Pc. 6 Pt. Metric Socket Set		
80125	4mm	80132	10mm
80126	5mm	80133	11mm
80127	5.5mm	80134	12mm
80128	6mm	80135	13mm
80129	7mm	80136	14mm
80130	8mm	80137	15mm
80131	9mm		
80303	10 Pc. 6 Pt. SAE Socket Set		
80105	3/16"	80110	11/32"
80106	7/32"	80111	3/8"
80107	1/4"	80112	7/16"
80108	9/32"	80113	1/2"
80109	5/16"	80114	9/16"

1/4" Drive Tools

81011	Full Polish Ratchet
81113	3" Extension
81116	6" Extension
81128	Spinner Handle

3/8" Drive Sockets

80552	14 Pc. 6 Pt. Metric Socket Set		
80374	6mm	80381	13mm
80375	7mm	80382	14mm
80376	8mm	80383	15mm
80377	9mm	80384	16mm
80378	10mm	80385	17mm
80379	11mm	80386	18mm
80380	12mm	80387	19mm
80553	13 Pc. 6 Pt. SAE Socket Set		
80350	1/4"	80357	11/16"
80351	5/16"	80358	3/4"

80352	3/8"	80359	13/16"
80353	7/16"	80360	7/8"
80354	1/2"	80361	15/16"
80355	9/16"	80362	1"
80356	5/8"		

3/8" Drive Tools

81211	Full Polish Teardrop Ratchet
81241	3" Extension
81242	6" Extension
80549	Universal Joint
80402	5/8" Spark Plug Socket
80403	13/16" Spark Plug Socket

Combination Wrenches

81900	24 Pc. SAE/Metric Long Pattern Combination Non-Ratcheting Wrench Set		
81656	1/2"	81668	11mm
81657	9/16"	81669	12mm

83091 - Career Builder Starter Set

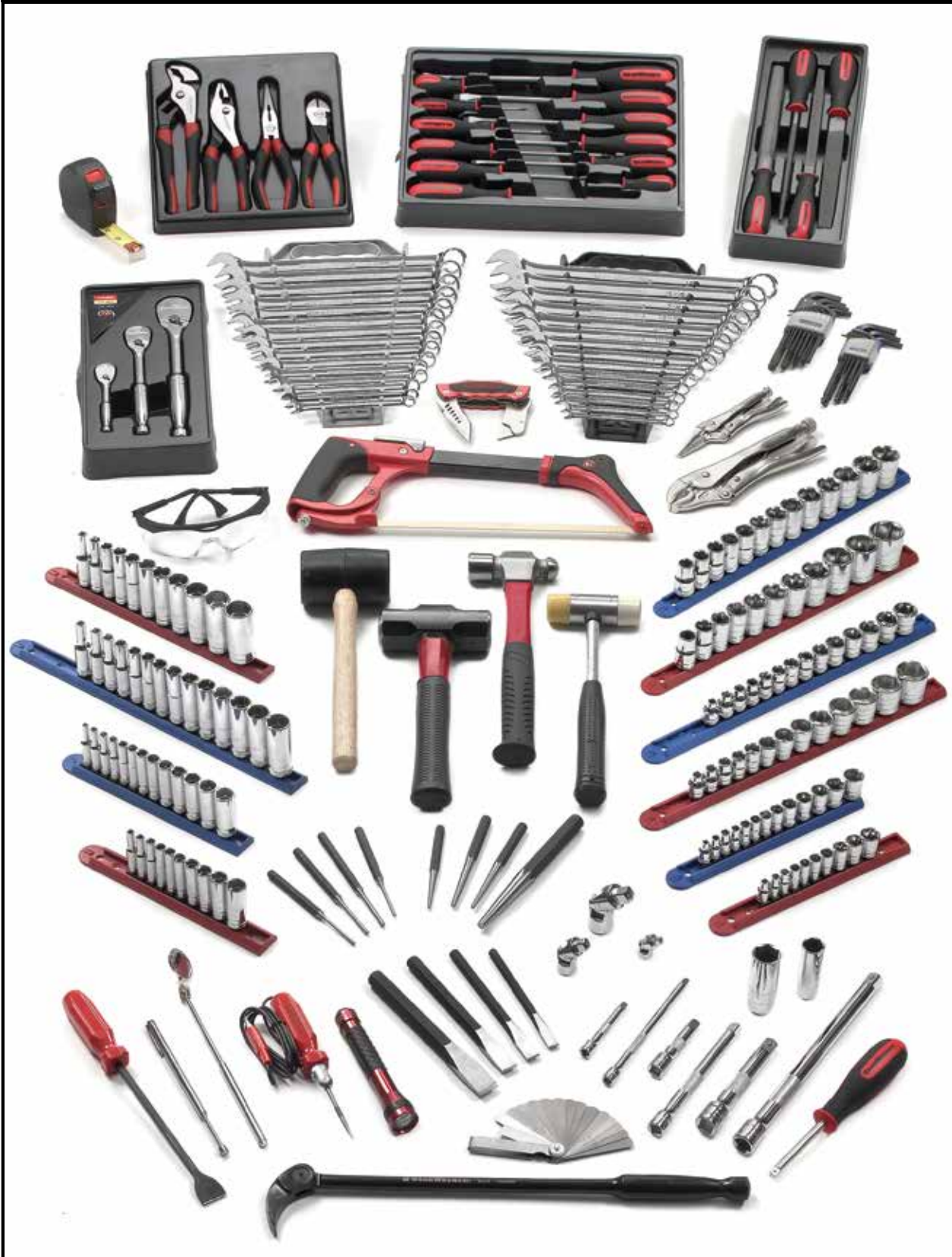

1/4" Drive Sockets

80302 13 Pc. 6 Pt. Metric Socket Set

80125	4mm	80132	10mm
80126	5mm	80133	11mm
80127	5.5mm	80134	12mm
80128	6mm	80135	13mm
80129	7mm	80136	14mm
80130	8mm	80137	15mm
80131	9mm		

80303 10 Pc. 6 Pt. SAE Socket Set

80105	3/16"	80110	11/32"
80106	7/32"	80111	3/8"
80107	1/4"	80112	7/16"
80108	9/32"	80113	1/2"
80109	5/16"	80114	9/16"

80304 13 Pc. 6 Pt. Deep Metric Socket Set

80138	4mm	80145	10mm
80139	5mm	80146	11mm
80140	5.5mm	80147	12mm
80141	6mm	80148	13mm
80142	7mm	80149	14mm
80143	8mm	80150	15mm
80144	9mm		

80305 10 Pc. 6 Pt. Deep SAE Socket Set

80115	3/16"	80120	11/32"
80116	7/32"	80121	3/8"
80117	1/4"	80122	7/16"
80118	9/32"	80123	1/2"
80119	5/16"	80124	9/16"

3/8" Drive Sockets

80552 14 Pc. 6 Pt. Metric Socket Set

80374	6mm	80381	13mm
80375	7mm	80382	14mm
80376	8mm	80383	15mm
80377	9mm	80384	16mm
80378	10mm	80385	17mm
80379	11mm	80386	18mm
80380	12mm	80387	19mm

80553 13 Pc. 6 Pt. SAE Socket Set

80350	1/4"	80357	11/16"
80351	5/16"	80358	3/4"
80352	3/8"	80359	13/16"
80353	7/16"	80360	7/8"
80354	1/2"	80361	15/16"
80355	9/16"	80362	1"
80356	5/8"		

80554 14 Pc. 6 Pt. Deep Metric Socket Set

80388	6mm	80395	13mm
80389	7mm	80396	14mm
80390	8mm	80397	15mm
80391	9mm	80398	16mm
80392	10mm	80399	17mm

80393	11mm	80400	18mm
80394	12mm	80401	19mm

80555 11 Pc. 6 Pt. Deep SAE Socket Set

80363	1/4"	80369	5/8"
80364	5/16"	80370	11/16"
80365	3/8"	80371	3/4"
80366	7/16"	80372	13/16"
80367	1/2"	80373	7/8"
80368	9/16"		

1/2" Drive Sockets

80702 13 Pc. 6 Pt. Metric Socket Set

81624	12mm	81631	19mm
81625	13mm	81632	20mm
81626	14mm	81633	21mm
81627	15mm	81634	22mm
81628	16mm	81635	23mm
81629	17mm	81636	24mm
81630	18mm		

80703 11 Pc. 6 Pt. SAE Socket Set

80603	1/2"	80609	7/8"
80604	9/16"	80610	15/16"
80605	5/8"	80611	1"
80606	11/16"	80612	1-1/16"
80607	3/4"	80613	1-1/8"
80608	13/16"		

1/4", 3/8", 1/2" Drive Tools

81206 3 Pc. Full Polish Ratchet Set 1/4", 3/8", & 1/2" Drive

81113	3" Extension 1/4" Drive
81116	6" Extension 1/4" Drive
80100	Universal Joint 1/4" Drive
81128	Spinner Handle 1/4" Drive
81241	3" Extension 3/8" Drive
81242	6" Extension 3/8" Drive
80549	Universal Joint 3/8" Drive
80402	5/8" Spark Plug Socket 3/8" Drive
80403	13/16" Spark Plug Socket 3/8" Drive
80600	Universal Joint 1/2" Drive
81341	5" Extension 1/2" Drive
81342	10" Extension 1/2" Drive

Combination Wrenches

81901 15 Pc. SAE Long Pattern Non-Ratcheting Wrench Set

81650	1/4"	81658	5/8"
81651	9/32"	81659	11/16"
81652	5/16"	81660	3/4"
81653	11/32"	81661	13/16"
81654	3/8"	81662	7/8"
81655	7/16"	81663	15/16"
81656	1/2"	81664	1"
81657	9/16"		

81902 15 Pc. Metric Long Pattern Non-Ratcheting Wrench Set

81665	8mm	81673	16mm
81666	9mm	81674	17mm
81667	10mm	81675	18mm
81668	11mm	81676	19mm
81669	12mm	81677	20mm
81670	13mm	81678	21mm
81671	14mm	81679	22mm
81672	15mm		

Screwdrivers and Pliers

80051 12 Pc. Combination Screwdriver Set

80012	1/4" x 1-1/2" Slotted
80018	3/16" x 6" Slotted w/ Cabinet Tip
80013	1/4" x 4" Slotted w/Hex Bolster
80014	1/4" x 6" Slotted w/Hex Bolster
80023	5/16" x 6" Slotted w/Hex Bolster
80022	3/8" x 8" Slotted w/Hex Bolster
80000	#0 x 2-1/2" Phillips
80001	#1 x 3" Phillips
80004	#1 x 6" Phillips
80005	#2 x 1-1/2" Phillips
80007	#2 x 4" Phillips w/Hex Bolster
80011	#3 x 6" Phillips w/Hex Bolster

82103 4 Pc. Mixed Pliers Set

82011	9.5" Tongue and Groove
82012	7" Diagonal Cutting
82013	8" Long Nose
82014	8" Slip Joint

Hex Keys

566126 13Pc. SAE ALLEN® Ball End Hex Key Set

Sizes: 0.050", 1/16", 5/64", 3/32", 7/64", 1/8", 9/64", 5/32", 3/16", 7/32", 1/4", 5/16", 3/8"

566156 9Pc. Metric ALLEN® Ball End Hex Key Set

Sizes: 1.5, 2, 2.5, 3, 4, 5, 6, 8, 10mm

Files, Punches & Chisels

82820 4 Pc. STD File Set

82822	8" Flat
82823	8" Round
82824	8" Half Round
82825	8" Triangle

82305 12 Pc. Punch and Chisel Set

82261	1/4" x 4-3/4" x 1/4" Cold Chisel
82262	3/8" x 5" x 5/16" Cold Chisel
82264	1/2" x 6" x 3/8" Cold Chisel
82265	5/8" x 6-1/2" x 3/8" Cold Chisel
82270	3/8" x 5" Center Punch
82272	3/32" x 4-3/4" x 5/16" Pin Punch
82273	1/8" x 5" x 5/16" Pin Punch

82274	5/32" x 5-1/4" x 5/16" Pin Punch
82275	3/16" x 5-1/2" x 5/16" Pin Punch
82278	1/8" x 8" x 3/8" Long Taper Punch
82283	3/16" x 5" x 3/8" Starter Punch
82285	1/8" x 4-1/2" x 5/16" Starter

General Purpose Tools

82216	16" Indexing Pry Bar
82880	High Tension Hacksaw
82251	16 oz. Ball Pain Hammer - Fiberglass
82260	12 oz. Sofface Hammer Removable Caps
82255	3 lb. Drilling Hammer
82259	16 oz. Rubber Mallet-Wood Hickory Handle
82881	Folding Utility Knife
83131	16" Tape Measure SAE/Metric
83132	Aluminum Flashlight
82041	10" Curved Jaw Locking Pliers
82043	6" Long Nose Locking Pliers
69-990	Safety Glasses

KD® Specialty Tools

KDS129	Low Voltage Circuit Tester
KDS162	16 Blade Feeler Gauge
KDS485	Gasket Scraper
KDS2109	Telescoping Mirror
KDS2281	Telescoping Magnetic Retrieving Tool

Not all tools GearWrench® Branded

83094 - Career Builder HVAC Add-on Tool Set

Wrenches

- 81910 5 Pc. SAE Flex Flare Nut Wrench Set
- 81693 1/4" x 5/16"
- 81694 3/8 x 7/16"
- 81695 1/2" x 9/16"
- 81696 5/8" x 11/16"
- 81697 3/4" x 7/8"
- 81911 6 Pc. Metric Flex Flare Nut Wrench Set
- 81686 9 x 11mm
- 81687 10 x 12mm
- 81688 13 x 14mm
- 81689 15 x 17mm
- 81690 16 x 18mm
- 81692 19 x 21mm
- 81990 3 Pc. Adjustable Wrench Set
- 81890 6"
- 81891 8"
- 81892 10"
- 85220 QuadBox™ HVAC Ratcheting Wrench
- Sizes: 1/4" x 3/16" square, 3/8" x 5/16" square
- 85221 QuadBox™ HVAC Ratcheting Wrench
- Sizes: 1/4" x 3/16" square, 9/16" x 1/2" hex

Cutting Tools

- 82841 Right Cutting Aviation Snips
- 82842 Left Cutting Aviation Snips
- 82843 3 Pc. Aviation Snip Set

General HVAC Tools

- 9-39829 Torpedo Level
- 69-350 10oz. Claw Hammer
- 73-014 14" Pipe Wrench
- MC33661 Manifold Set
- 66-843 7 Pc. SAE Nut Driver Set
- (1/4" x 9/32", 5/16", 11/32", 3/8", 7/16", 1/2")

KD® Specialty Tools

- 41590 Tubing Service Set
- 2107 Mini Tubing Cutter
- 2189 Tubing Bender
- 3905 Deburring Tool
- 41594 Flaring Adapter Kit
- 41595 Holding Bar
- 41596 Yoke
- 3457 Large Tubing Cutter



83095 - Intermediate Auto Tool Set



1/4" Drive Sockets

80302	13 Pc. Metric 6 Pt. Socket Set
80125	4mm 80132 10mm
80126	5mm 80133 11mm
80127	5.5mm 80134 12mm
80128	6mm 80135 13mm
80129	7mm 80136 14mm
80130	8mm 80137 15mm
80131	9mm

80303	10 Pc. 6 Pt. SAE Socket Set
80105	3/16" 80110 11/32"
80106	7/32" 80111 3/8"
80107	1/4" 80112 7/16"
80108	9/32" 80113 1/2"
80109	5/16" 80114 9/16"

80304	13 Pc. 6 Pt. Deep Metric Socket Set
80138	4mm 80145 10mm
80139	5mm 80146 11mm
80140	5.5mm 80147 12mm
80141	6mm 80148 13mm
80142	7mm 80149 14mm
80143	8mm 80150 15mm
80144	9mm

80305	10 Pc. 6 Pt. Deep SAE Socket Set
80115	3/16" 80120 11/32"
80116	7/32" 80121 3/8"
80117	1/4" 80122 7/16"
80118	9/32" 80123 1/2"
80119	5/16" 80124 9/16"

3/8" Drive Sockets

80552	14 Pc. 6 Pt. Metric Socket Set
80374	6mm 80381 13mm
80375	7mm 80382 14mm
80376	8mm 80383 15mm
80377	9mm 80384 16mm
80378	10mm 80385 17mm
80379	11mm 80386 18mm
80380	12mm 80387 19mm

80553	13 Pc. 6 Pt. SAE Socket Set
80350	1/4" 80357 11/16"
80351	5/16" 80358 3/4"
80352	3/8" 80359 13/16"
80353	7/16" 80360 7/8"
80354	1/2" 80361 15/16"
80355	9/16" 80362 1"
80356	5/8"

80554	14 Pc. 6 Pt. Deep Metric Socket Set
80388	6mm 80395 13mm
80389	7mm 80396 14mm
80390	8mm 80397 15mm
80391	9mm 80398 16mm

80392	10mm	80399	17mm
80393	11mm	80400	18mm
80394	12mm	80401	19mm
80555	11 Pc. 6 Pt. Deep SAE Socket Set		
80363	1/4" 80369 9/16"		
80364	5/16" 80370 5/8"		
80365	3/8" 80371 11/16"		
80366	1/4" 80372 3/4"		
80367	7/16" 80373 7/8"		
80368	1/2"		

1/2" Drive Sockets

80702	13 Pc. 6 Pt. Metric Socket Set
81624	12mm 81631 19mm
81625	13mm 81632 20mm
81626	14mm 81633 21mm
81627	15mm 81634 22mm
81628	16mm 81635 23mm
81629	17mm 81636 24mm
81630	18mm

80703	11 Pc. 6 Pt. SAE Socket Set
80603	1/2" 80609 7/8"
80604	9/16" 80610 15/16"
80605	5/8" 80611 1"
80606	11/16" 80612 1-1/16"
80607	3/4" 80613 1-1/8"
80608	13/16"

1/4", 3/8", 1/2" Drive Sockets

81206	3 Pc. Full Polish Ratchet Set (1/4", 3/8", 1/2" Drive)
81113	3" Extension 1/4" Drive
80100	Universal Joint 1/4" Drive
81128	Spinner Handle 1/4" Drive
81241	3" Extension 3/8" Drive
81242	6" Extension 3/8" Drive
80549	Universal Joint 3/8" Drive
80402	5/16" Spark Plug Socket 3/8" Drive
80403	13/16" Spark Plug Socket 3/8" Drive
80600	Universal Joint 1/2" Drive
81341	5" Extension 1/2" Drive
81307	Full Polish Flex Handle 1/2" Drive

Combination Wrenches

81901	15 Pc. SAE Long Pattern Combination Non-Ratcheting Wrench Set
81650	1/4" 81658 5/8"
81651	9/32" 81659 11/16"
81652	5/16" 81660 3/4"
81653	11/32" 81661 13/16"
81654	3/8" 81662 7/8"
81655	7/16" 81663 15/16"
81656	1/2" 81664 1"
81657	9/16"

81902	15 Pc. Metric Long Pattern Combination Non-Ratcheting Wrench Set
81665	8mm 81673 16mm
81666	9mm 81674 17mm
81667	10mm 81675 18mm
81668	11mm 81676 19mm
81669	12mm 81677 20mm
81670	13mm 81678 21mm
81671	14mm 81679 22mm
81672	15mm

Screwdrivers and Pliers

80051	12 Pc. Combination Screwdriver Set
80012	1/4" x 1-1/2" Slotted
80018	3/16" x 6" Slotted w/Cabinet Tip
80013	1/4" x 4" Slotted w/Hex Bolster
80014	1/4" x 6" Slotted w/Hex Bolster
80023	5/16" x 6" Slotted w/Hex Bolster
80022	3/8" x 8" Slotted w/Hex Bolster
80000	#0 x 2-1/2" Phillips
80001	#1 x 3" Phillips
80004	#1 x 6" Phillips
80005	#2 x 1-1/2" Phillips
80007	#2 x 4" Phillips w/Hex Bolster
80011	#3 x 6" Phillips w/Hex Bolster

82108	8 Pc. Mixed Pliers Set
82011	Tongue and Groove
82012	Diagonal Cutting
82013	Long Nose
82014	Slip Joint
82020	12" Groove Joint with Straight Jaw
82025	8" Linesman
82028	8" End Nipper
82005	Straight Double-X™ Pliers

Hex Keys

56603G	13 Pc. SAE ALLEN® Hex Key Set
Sizes: 0.050, 1/16", 5/64", 3/32", 7/64", 1/8", 9/64", 5/32", 3/16", 7/32", 1/4", 5/16", 3/8"	

56615G	9 Pc. Metric ALLEN® Ball End Hex Key Set
Sizes: 1.5, 2, 2.5, 3, 4, 5, 6, 8, 10mm	

Punch & Chisels

82305	12 Pc. Punch and Chisel Set
82261	1/4" x 4-3/4" x 1/4" Cold Chisel
82262	3/8" x 5" x 5/16" Cold Chisel
82264	1/2" x 6" x 3/8" Cold Chisel
82265	5/8" x 6-1/2" x 3/8" Cold Chisel
82270	3/8" x 5" Center Punch
82272	3/32" x 4-3/4" x 5/16" Pin Punch
82273	1/8" x 5" x 5/16" Pin Punch
82274	5/32" x 5-1/4" x 5/16" Pin Punch

82275	3/16" x 5-1/2" x 5/16" Pin Punch
82278	1/8" x 8" x 3/8" Long Taper Punch
82283	3/16" x 5" x 3/8" Starter Punch
82285	1/8" x 4-1/2" x 5/16" Starter

Torx® Bit Sockets

80723	13 Pc. Torx® Press Fit Bit Socket Set 1/4", 3/8", 1/2" Drive
80171	T-8, 1/4" Drive
80172	T-10, 1/4" Drive
80173	T-15, 1/4" Drive
80174	T-20, 1/4" Drive
80175	T-25, 1/4" Drive
80176	T-27, 1/4" Drive
80177	T-30, 1/4" Drive
80451	T-40, 3/8" Drive
80452	T-45, 3/8" Drive
80453	T-47, 3/8" Drive
80454	T-50, 3/8" Drive
80455	T-55, 3/8" Drive
80667	T-60, 1/2" Drive

General Purpose Tools

82880	High Tension Hackaw
82251	16 oz Ball Pain Hammer - Fiberglass
82260	12 oz Sofface Hammer Removable Caps
82255	3 lb Drilling Hammer
82259	16 oz Rubber Mallet - Wood Hickory
82881	Folding Utility Knife
83131	Intermediate Aviation Set
83132	Flashlight Aluminium
82102	3 Pc. Locking Pliers Set
82043	Long Nose Locking Pliers 6"
990	Curved Jaw Locking Pliers 5"
990	Curved Jaw Locking Pliers 10"
69-990	Safety Glasses

KD® Specialty Tools

KDS129	Low Voltage Circuit Tester
KDS162	16 Blade Feeler Gauge
KDS485	Gasket Scraper
KDS2282	Slotted Screw Starter
KDS2283	Phillips Screw Starter
KDS2774	Brake Retaining Spring Tool
KDS298	Brake Spring Pliers
KDS295	Brake Shoe Adjusting Tool
KDS3163	Rear Brake Piston Tool
KDS2840	Telescoping Mirror
KDS2593	Telescoping Magnetic Pick-Up Tool
KDS3151	Interchangeable Snap Ring Pliers
KDS2162	Wire Stripper Crimper

Not all tools GearWrench® Branded

83096 - Intermediate Diesel Tool Set



1/4" Drive Sockets

80302 13 Pc. 6 Pt. Metric Socket Set

80125	4mm	80132	10mm
80126	5mm	80133	11mm
80127	5.5mm	80134	12mm
80128	6mm	80135	13mm
80129	7mm	80136	14mm
80130	8mm	80137	15mm
80131	9mm		

80303 10 Pc. 6 Pt. SAE Socket Set

80105	3/16"	80110	11/32"
80106	7/32"	80111	3/8"
80107	1/4"	80112	7/16"
80108	9/32"	80113	1/2"
80109	5/16"	80114	9/16"

3/8" Drive Sockets

80552 14 Pc. 6 Pt. Metric Socket Set

80374	6mm	80381	13mm
80375	7mm	80382	14mm
80376	8mm	80383	15mm
80377	9mm	80384	16mm
80378	10mm	80385	17mm
80379	11mm	80386	18mm
80380	12mm	80387	19mm

80553 13 Pc. 6 Pt. SAE Socket Set

80350	1/4"	80357	11/16"
80351	5/16"	80358	3/4"
80352	3/8"	80359	13/16"
80353	7/16"	80360	7/8"
80354	1/2"	80361	15/16"
80355	9/16"	80362	1"
80356	5/8"		

80554 14 Pc. 6 Pt. Deep Metric Socket Set

80388	6mm	80395	13mm
80389	7mm	80396	14mm
80390	8mm	80397	15mm
80391	9mm	80398	16mm
80392	10mm	80399	17mm
80393	11mm	80400	18mm
80394	12mm	80401	19mm

80555 11 Pc. 6 Pt. Deep SAE Socket Set

80363	1/4"	80369	9/16"
80364	5/16"	80370	5/8"
80365	3/8"	80371	3/4"
80366	1/4"	80372	13/16"
80367	7/16"	80373	7/8"
80368	1/2"		

1/2" Drive Sockets

80702 13 Pc. 6 Pt. Metric Socket Set

81624	12mm	81631	19mm
81625	13mm	81632	20mm

81626	14mm	81633	21mm
81627	15mm	81634	22mm
81628	16mm	81635	23mm
81629	17mm	81636	24mm
81630	18mm		

80703 11 Pc. 6 Pt. SAE Socket Set

80603	1/2"	80609	7/8"
80604	9/16"	80610	15/16"
80605	5/8"	80611	1"
80606	11/16"	80612	1-1/16"
80607	3/4"	80613	1-1/8"
80608	13/16"		

80704 10 Pc. 6 Pt. Deep Metric Socket Set

80637	10mm	80642	15mm
80638	11mm	80643	16mm
80629	17mm	80644	17mm
80640	13mm	80645	18mm
80641	14mm	80646	19mm

80705 8 Pc. 6 Pt. Deep SAE Socket Set

80614	1/2"	80618	3/4"
80615	9/16"	80619	13/16"
80616	5/8"	80620	7/8"
80617	11/16"	80621	15/16"

1/4", 3/8", 1/2" Drive Sockets

81206 3 Pc. Full Polish Ratchet Set

81011	Full Polish Teardrop Ratchet 1/4" Drive
81211	Full Polish Teardrop Ratchet 3/8" Drive
81304	Full Polish Teardrop Ratchet 1/2" Drive

81113 3" Extension 1/4" Drive

80100	Universal Joint 1/4" Drive
81128	Spinner Handle 1/4" Drive
81241	3" Extension 3/8" Drive
81242	6" Extension 3/8" Drive
80549	Universal Joint 3/8" Drive
80402	Intermediate Diesel Set
80403	13/16" Spark Plug Socket 3/8" Dr.
80600	Universal Joint 1/2" Drive
81341	5" Extension 1/2" Drive
81307	Full Polish Flex Handle 1/2" Drive

Combinations Wrenches

81917 18 Pc. Long Pattern Combination Non-Ratcheting Wrench Set SAE

81650	1/4"	81659	11/16"
81651	9/32"	81660	3/4"
81652	5/16"	81661	13/16"
81653	11/32"	81662	7/8"
81654	3/8"	81663	15/16"
81655	7/16"	81664	1"
81656	1/2"	81733	1-1/6"
81657	9/16"	81734	1-1/8"
81658	5/8"	81735	1-1/4"

81916 22 Pc. Long Pattern Combination Non-Ratcheting Wrench Metric

81736	6mm	81674	17mm
81737	7mm	81675	18mm
81665	8mm	81676	19mm
81666	9mm	81677	20mm
81667	10mm	81678	21mm
81668	11mm	81679	22mm
81669	12mm	81741	23mm
81670	13mm	81742	24mm
81671	14mm	81743	27mm
81672	15mm	81744	30mm
81673	16mm	81745	32mm

Screwdrivers and Pliers

80051 12 Pc. Combination Screwdriver Set

80012	1/4" x 1-1/2" Slotted
80018	3/16" x 6" Slotted w/ Cabinet Tip
80013	1/4" x 4" Slotted w/Hex Bolster
80014	1/4" x 6" Slotted w/Hex Bolster
80023	5/16" x 6" Slotted w/Hex Bolster
80022	3/8" x 8" Slotted w/Hex Bolster
80000	#0 x 2-1/2" Phillips
80001	#1 x 3" Phillips
80004	#1 x 6" Phillips
80005	#2 x 1-1/2" Phillips
80007	#2 x 4" Phillips w/ Hex Bolster
80011	#3 x 6" Phillip w/Hex Bolster

82103 4 Pc. Mixed Pliers Set

82011	9.5" Tongue and Groove
82012	7" Diagonal Cutting
82013	8" Long Nose
82005	Straight Double-X™

Hex Keys

566036 13 Pc. SAE ALLEN® Hex Key Set

Sizes: 0.050", 1/16", 5/64", 3/32", 7/64", 1/8", 9/64", 5/32", 3/16", 7/32", 1/4", 5/16", 3/8"

566156 9 Pc. SAE ALLEN® Ball End Hex Key Set

Sizes: 1.5, 2, 2.5, 3, 4, 5, 6, 8, 10mm

Punch & Chisel

82305 12 Pc. Punch and Chisel Set

82261	1/4" x 4-3/4" x 1/4" Cold Chisel
82262	3/8" x 5" x 5/16" Cold Chisel
82264	1/2" x 6" x 3/8" Cold Chisel
82265	5/8" x 6-1/2" x 3/8" Cold Chisel
82270	3/8" x 5" Center Punch
82272	3/32" x 4-3/4" x 5/16" Pin Punch
82273	1/8" x 5" x 5/16" Pin Punch
82274	5/32" x 5-1/4" x 5/16" Pin Punch
82275	3/16" x 5-1/2" x 5/16" Pin Punch

82278	1/8" x 8" x 3/8" Long Taper Punch
82283	3/16" x 5" x 3/8" Starter Punch
82285	1/8" x 4-1/2" x 5/16" Long Taper Punch

Torx® Bit Sockets

80723 13 Pc. Torx® Press Fit Bit Socket Set

80171	T-8, 1/4" Drive
80172	T-10, 1/4" Drive
80173	T-15, 1/4" Drive
80174	T-20, 1/4" Drive
80175	T-25, 1/4" Drive
80176	T-27, 1/4" Drive
80177	T-30, 1/4" Drive
80451	T-40, 3/8" Drive
80452	T-45, 3/8" Drive
80453	T-47, 3/8" Drive
80454	T-50, 3/8" Drive
80455	T-55, 3/8" Drive
80667	T-60, 1/2" Drive

General Purpose Tools

82220	18" to 29" Extendable Pry Bar
82880	High Tension Hacksaw
82251	16 oz Ball Pein Hammer - Fiberglass
82260	12 oz Softface Hammer Removable Caps
82255	3 lb Drilling Hammer
82259	16 oz Rubber Mallet - Wood Hickory Handle
82881	Folding Utility Knife
83131	16' Tape Measure SAE/Metric
83132	Aluminum Flashlight
82102	3 Pc. Locking Pliers Set
82043	Long Nose Locking Pliers 6"
82040	Curved Jaw Locking Pliers 5"
82041	Curved Jaw Locking Pliers 10"
69-990	Safety Glasses

KD® Specialty Tools

KDS129	Low Voltage Circuit Tester
KDS162	16 Blade Feeler Gauge
KDS485	Gasket Scraper
KDS2282	Slotted Screw Starter
KDS2283	Phillips Screw Starter
KDS2840	Telescoping Mirror
KDS2593	Telescoping Magnetic Pick-Up Tool
KDS2162	Wire Stripper Crimper

Not all tools GearWrench® Branded

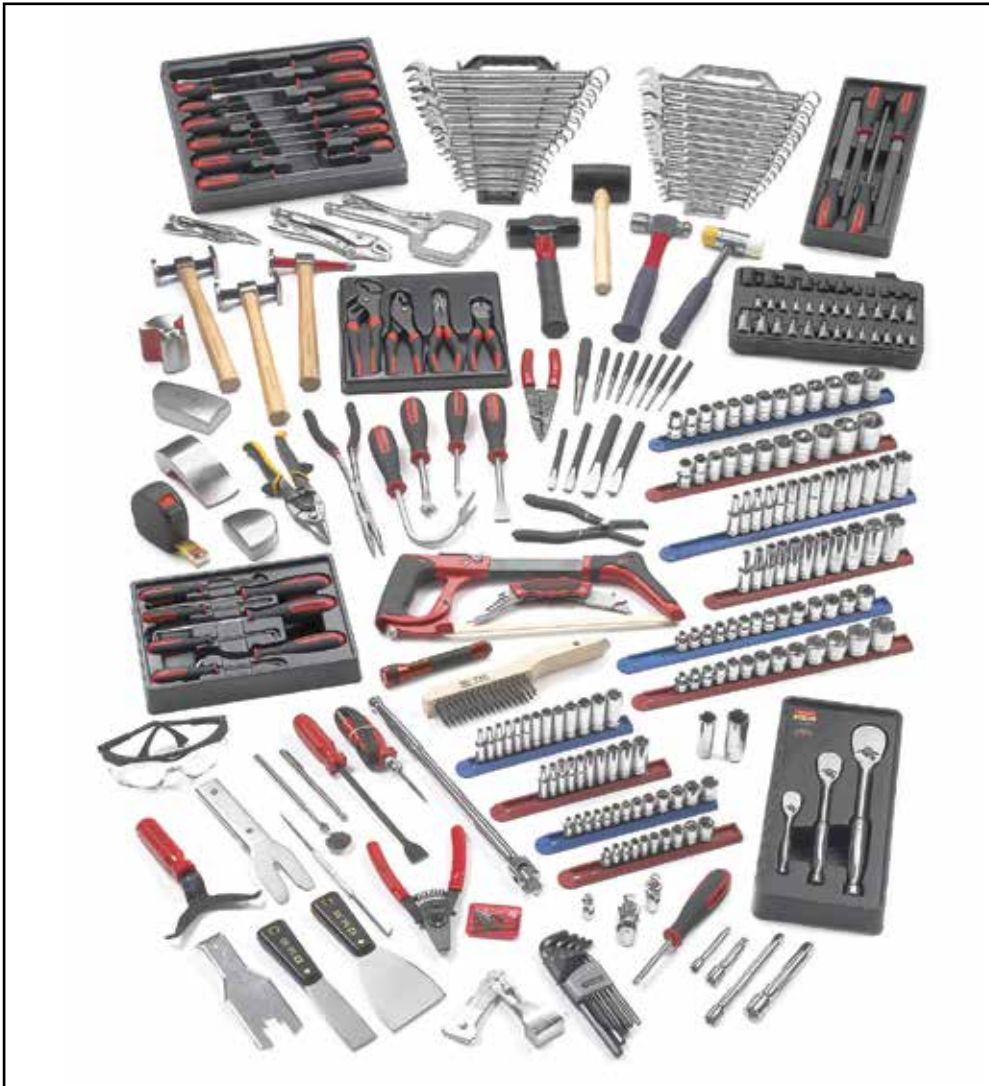

83097 - Intermediate Auto Body Tool Set

80392	10mm	80399	17mm
80393	11mm	80400	18mm
80394	12mm	80401	19mm

80555 11 Pc. 6 Pt. Deep SAE Socket Set			
80363	1/4"	80369	9/16"
80364	5/16"	80370	5/8"
80365	3/8"	80371	11/16"
80366	1/4"	80372	3/4"
80367	7/16"	80373	7/8"
80368	1/2"		

1/2" Drive Sockets

80702 13 Pc. 6 Pt. Metric Socket Set			
81624	12mm	81631	19mm
81625	13mm	81632	20mm
81626	14mm	81633	21mm
81627	15mm	81634	22mm
81628	16mm	81635	23mm
81629	17mm	81636	24mm
81630	18mm		

80703 11 Pc. 6 Pt. SAE Socket Set			
80603	1/2"	80609	7/8"
80604	9/16"	80610	15/16"
80605	5/8"	80611	1"
80606	11/16"	80612	1-1/16"
80607	3/4"	80613	1-1/8"
80608	13/16"		

1/4", 3/8", 1/2" Drive Sockets

81206 3 Pc. Full Polish Ratchet Set (1/4", 3/8", 1/2" Drive)			
---	--	--	--

81113	3" Extension 1/4" Drive
80100	Universal Joint 1/4" Drive
81128	Spinner Handle 1/4" Drive
81241	3" Extension 3/8" Drive
81242	6" Extension 3/8" Drive
80549	Universal Joint 3/8" Drive
80402	Intermediate Auto Body Set
80403	13/16" Spark Plug Socket 3/8" Dr.
80600	Universal Joint 1/2" Drive
81341	5" Extension 1/2" Drive
81307	Full Polish Flex Handle 1/2" Drive

81901 15 Pc. SAE Long Pattern Combination Non-Ratcheting Wrench Set

81650	1/4"	81658	5/8"
81651	9/32"	81659	11/16"
81652	5/16"	81660	3/4"
81653	11/32"	81661	13/16"
81654	3/8"	81662	7/8"
81655	7/16"	81663	15/16"

1/4" Drive Sockets

80302 13 Pc. 6 Pt. Metric Socket Set			
80125	4mm	80132	10mm
80126	5mm	80133	11mm
80127	5.5mm	80134	12mm
80128	6mm	80135	13mm
80129	7mm	80136	14mm
80130	8mm	80137	15mm
80131	9mm		
80303 10 Pc. 6 Pt. SAE Socket Set			
80105	3/16"	80110	11/32"
80106	7/32"	80111	3/8"
80107	1/4"	80112	7/16"
80108	9/32"	80113	1/2"
80109	5/16"	80114	9/16"
80304 13 Pc. 6 Pt. Deep Metric Socket Set			
80138	4mm	80145	10mm

80139	5mm	80146	11mm
80140	5.5mm	80147	12mm
80141	6mm	80148	13mm
80142	7mm	80149	14mm
80143	8mm	80150	15mm
80144	9mm		
80305 10 Pc. 6 Pt. Deep SAE Socket Set			
80115	3/16"	80120	11/32"
80116	7/32"	80121	3/8"
80117	1/4"	80122	7/16"
80118	9/32"	80123	1/2"
80119	5/16"	80124	9/16"
3/8" Drive Sockets			
80552 14 Pc. 6 Pt. Metric Socket Set			
80374	6mm	80381	13mm
80375	7mm	80382	14mm
80376	8mm	80383	15mm

80377	9mm	80384	16mm
80378	10mm	80385	17mm
80379	11mm	80386	18mm
80380	12mm	80387	19mm
80553 13 Pc. 6 Pt. SAE Socket Set			
80350	1/4"	80357	11/16"
80351	5/16"	80358	3/4"
80352	3/8"	80359	13/16"
80353	7/16"	80360	7/8"
80354	1/2"	80361	15/16"
80355	9/16"	80362	1"
80356	5/8"		
80554 14 Pc. 6 Pt. Deep Metric Socket Set			
80388	6mm	80395	13mm
80389	7mm	80396	14mm
80390	8mm	80397	15mm
80391	9mm	80398	16mm

81656	1/2"	81664	1"
81657	9/16"		
81902	15 Pc. Metric Long Pattern Combination Non-Ratcheting Wrench Set		
81665	8mm	81673	16mm
81666	9mm	81674	17mm
81667	10mm	81675	18mm
81668	11mm	81676	19mm
81669	12mm	81677	20mm
81670	13mm	81678	21mm
81671	14mm	81679	22mm
81672	15mm		

Screwdrivers and Pliers

80051	12 Pc. Combination Screwdriver Set		
80012	1/4" x 1-1/2"	Slotted	
80018	3/16" x 6"	Slotted w/Cabinet Tip	
80013	1/4" x 4"	Slotted w/Hex Bolster	
80014	1/4" x 6"	Slotted w/Hex Bolster	
80023	5/16" x 6"	Slotted w/Hex Bolster	
80022	3/8" x 8"	Slotted w/Hex Bolster	
80000	#0 x 2-1/2"	Phillips	
80001	#1 x 3"	Phillips	
80004	#1 x 6"	Phillips	
80005	#2 x 1-1/2"	Phillips	
80007	#2 x 4"	Phillips w/Hex Bolster	
80011	#3 x 6"	Phillips w/Hex Bolster	
82103	4 Pc. Mixed Pliers Set		
82011	9.5"	Tongue and Groove	
82012	7"	Diagonal Cutting	
82013	8"	Long Nose	

Hex Keys

566036 13 Pc. SAE ALLEN® Hex Key Set
 Sizes: 0.050", 1/16", 5/64", 3/32", 7/64", 1/8", 9/64", 5/32", 3/16", 7/32", 1/4", 5/16", 3/8"

Punch & Chisels

82305	12 Pc. Punch and Chisel Set		
82261	1/4" x 4-3/4" x 1/4"	Cold Chisel	
82262	3/8" x 5" x 5/16"	Cold Chisel	
82264	1/2" x 6" x 3/8"	Cold Chisel	
82265	5/8" x 6-1/2" x 3/8"	Cold Chisel	
82270	3/8" x 5"	Center Punch	
82272	3/32" x 4-3/4" x 5/16"	Pin Punch	
82273	1/8" x 5" x 5/16"	Pin Punch	
82274	5/32" x 5-1/4" x 5/16"	Pin Punch	
82275	3/16" x 5-1/2" x 5/16"	Pin Punch	
82278	1/8" x 8" x 3/8"	Long Taper Punch	
82283	3/16" x 5" x 3/8"	Starter Punch	
82285	1/8" x 4-1/2" x 5/16"	Long Taper Punch	

Hex and Torx® Bit Sockets

80726	36 Pc. Master Torx® Set with Hex Bit Sockets		
80172	T-10, 1/4"	Drive	
80173	T-15, 1/4"	Drive	
80174	T-20, 1/4"	Drive	
80175	T-25, 1/4"	Drive	
80176	T-27, 1/4"	Drive	
80177	T-30, 1/4"	Drive	
80187	E-5, 1/4"	Drive	
80188	E-6, 1/4"	Drive	
80189	E-7, 1/4"	Drive	
80190	E-8, 1/4"	Drive	
80451	T-40, 3/8"	Drive	
80452	T-45, 3/8"	Drive	
80453	T-47, 3/8"	Drive	
80454	T-50, 3/8"	Drive	
80455	T-55, 3/8"	Drive	
80416	5/32", 3/8"	Drive	
80417	3/16", 3/8"	Drive	
80418	7/32", 3/8"	Drive	
80419	1/4", 3/8"	Drive	
80420	5/16", 3/8"	Drive	
80421	3/8", 3/8"	Drive	
80422	2mm, 3/8"	Drive	
80423	2.5mm, 3/8"	Drive	
80424	3mm, 3/8"	Drive	
80425	4mm, 3/8"	Drive	
80426	5mm, 3/8"	Drive	
80427	6mm, 3/8"	Drive	
80428	7mm, 3/8"	Drive	
80429	8mm, 3/8"	Drive	
80430	9mm, 3/8"	Drive	
80431	10mm, 3/8"	Drive	
80460	E-10, 3/8"	Drive	
80461	E-12, 3/8"	Drive	
80462	E-14, 3/8"	Drive	
80463	E-16, 3/8"	Drive	
80669	E-18, 1/2"	Drive	

General Body Tools

84050	4 Pc. Door Pad and Panel Removal Kit		
84051	4"	V-Notch Puller	
84052	4"	Square Notch Puller	
84053	4"	Scraper	
84054	4"	Curved Blade V-Notch Puller	
84000	7 Pc. Hook And Pick Set		
84001	5"	Cotter Pin Puller	
84002	4"	Hose Pick Puller	
84003	4-1/2"	Awl	
84004	3-1/8	Mini Full Hook	
84005	3-1/8	90° Mini Hook	
84006	3-1/8	Straight Mini Hook	

84007	3-1/8	Mini Offset Hook	
82820	4 Pc. STD FileS Set		
82822	8"	Flat	
82823	8"	Round	
82824	8"	Half Round	
82825	8"	Triangle	

82302 7 Pc. Body Hammer Set

General Body Tools

82880	High Tension	Hacksaw	
82840	Straight Cutting	Aviation Snips	
82251	16 oz	Ball Pein Hammer - Fiberglass	
82260	12 oz	Softface Hammer Removable Caps	
82255	3 lb	Drilling Hammer	
82259	16 oz	Rubber Mallet-Wood Hickory Handle	
82881	Folding	Utility Knife	
83131	Intermediate	Aviation Set	
83132	Intermediate	Aviation Set	
82041	10"	Curved Jaw Locking Pliers	
82043	6"	Long Nose Locking Pliers	
82050	11"	Swivel Pad C-Clamp Locking Pliers	
69-990	Safety	Glasses	

KD® Specialty Tools

KDS129	Low Voltage	Circuit Tester	
KDS485	Gasket	Scraper	
KDS2840	Telescoping	Mirrors	
KDS2593	Telescoping	Magnetic Pick-Up Tool	
KDS3151	Interchangeable	Snap Ring Pliers	
KDS2162	Wire Stripper	Crimper	
KDS2038	Window Molding	Remover	
KDS431	Door Handle	Window Lift Remover	
KDS2822	Trim Pad	Removal Tool	
KDS3729	Push Pin	Pliers	
KDS2979	Scribe		
KDS2106	All Purpose	Sticker Scraper Tool	
KDS2311	Shoe Handle	Wire Scratch Brush	
KDS2426	3"	Putty/Knife Scraper	
KDS2425	1-1/4"	Putty/Knife Scraper	

Not all tools GearWrench® Branded

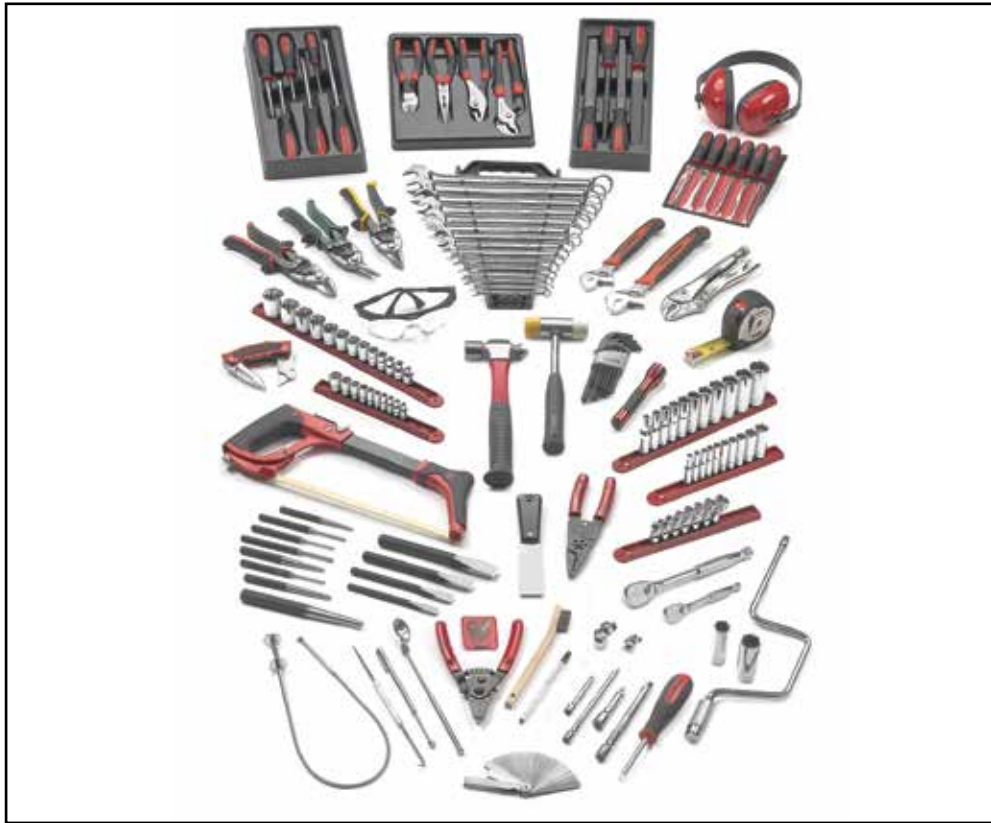

83098 - Intermediate Aviation Tool Set

82827	4" Half Round Mini
82828	4" Round Mini
82829	4" Triangle Mini
82830	4" Square Mini
82831	4" Knife Mini
82305	12 Pc. Punch and Chisel Set
82261	1/4" x 4-3/4" x 1/4" Cold Chisel
82262	3/8" x 5" x 5/16" Cold Chisel
82264	1/2" x 6" x 3/8" Cold Chisel
82265	5/8" x 6-1/2" x 3/8" Cold Chisel
82270	3/8" x 5" Center Punch
82272	3/32" x 4-3/4" x 5/16" Pin Punch
82273	1/8" x 5" x 5/16" Pin Punch
82274	5/32" x 5-1/4" x 5/16" Pin Punch
82275	3/16" x 5-1/2" x 5/16" Pin Punch
82278	1/8" x 8" x 3/8" Long Taper Punch
82283	3/16" x 5" x 3/8" Starter Punch
82285	1/8" x 4-1/2" x 5/16" Long Taper Punch

General Purpose Tools

81891	8" Adjustable Cushion Grip Wrench
81893	12" Adjustable Cushion Grip Wrench
82880	High Tension Hacksaw
82251	16 oz Ball Pein Hammer - Fiberglass
82260	12 oz Softface Hammer Removable Caps
82881	Folding Utility Knife
82131	16" Tape Measure SAE/Metric
83132	Aluminum Flashlight
82040	5" Curved Jaw Locking Pliers
69-990	Safety Glasses
9-HLQM24	Hearing Protection

KD® Specialty Tools

KDS2391	23" Flexible Pick-Up Tool
KDS2109	Telescoping Mirror
KDS2593	Telescoping Magnetic Pick-Up Tools
KDS2282	Slotted Screw Starter
KDS2283	Phillips Screw Starter
KDS2425	1-1/4" Putty Knife/Scrapper
KDS2979	Scribe
KDS2309	Stainless Steel Brush
KDS3151	Interchangeable Snap Ring Pliers
KDS2162	Wire Stripper Crimper
KDS162	16 Blade Feeler Gauge

Not all tools GearWrench® Branded

1/4" Drive Sockets

80307	10 Pc. 12 Pt. SAE Socket Set		
80210	3/16"	80215	11/32"
80211	7/32"	80216	3/8"
80212	1/4"	80217	7/16"
80213	9/32"	80218	1/2"
80214	5/16"	80219	9/16"

80305	10 Pc. 6 Pt. Deep SAE Socket Set		
80115	3/16"	80120	11/32"
80116	7/32"	80121	3/8"
80117	1/4"	80122	7/16"
80118	9/32"	80123	1/2"
80119	5/16"	80124	9/16"

80310	7 Pc. 6 Pt. SAE Flex Socket Set		
80262	3/16"	80266	7/16"
80263	1/4"	80267	1/2"
80264	5/16"	80268	9/16"
80265	3/8"		

1/4" Drive Tools

81011	Full Polish Teardrop Ratchet
81113	3" Extension
81116	6" Extension
81128	Spinner Handle
80100	Universal Joint

3/8" Drive Sockets

80561	13 Pc. 12 Pt. SAE Socket Set
--------------	-------------------------------------

80496	1/4"	80503	11/16"
80497	5/16"	80504	3/4"
80498	3/8"	80505	13/16"
80499	7/16"	80506	7/8"
80500	1/2"	80507	15/16"
80501	9/16"	80508	1"
80502	5/8"		

80563	11 Pc. 12 Pt. Deep SAE Socket Set		
80509	1/4"	80515	9/16"
80510	5/16"	80516	5/8"
80511	3/8"	80517	11/16"
80512	1/4"	80518	3/4"
80513	7/16"	80519	7/8"
80514	1/2"		

3/8" Drive Tools

81211	Full Polish Teardrop Ratchet
81241	3" Extension
81242	6" Extension
80549	Universal Joint
80402	5/8" Spark Plug Socket
80403	13/16" Spark Plug Socket
11-935	Speeder Handle

Hex Keys

566126	13 Pc. SAE ALLEN® Ball End Hex Key Set		
Sizes: Sizes: 0.050", 1/16", 5/64", 3/32", 7/64", 1/8", 9/64", 5/32", 3/16", 7/32", 1/4", 5/16", 3/8"			

Screwdrivers and Pliers

80050	6 Pc. Combination Screwdriver Set
80015	1/8" x 3" Slotted w/Cabinet Tip
80013	1/4" x 4" Slotted w/Hex Bolster
80023	5/16" x 6" Slotted w/Hex Bolster
80022	3/8" x 8" Slotted w/Hex Bolster
80001	#1 x 3" Phillips
80007	#2 x 4" Phillips w/Hex Bolster

82103	4 Pc. Mixed Pliers Set
82011	9.5" Tongue and Groove
82012	7" Diagonal Cutting
82013	8" Long Nose
82014	8" Slip Joint

Cutting Tools

82841	Right Cutting Aviation Snips
82842	Left Cutting Aviation Snips
82843	3 Pc. Aviation Snip Set

Files, Punches & Chisels

82820	4 Pc. STD File Set
82822	8" Flat
82823	8" Round
82824	8" Half Round
82825	8" Triangle File
82821	6 Pc. Mini File Set
82826	4" Flat Mini

**YOU'RE GONNA NEED
A BIGGER BOX**



CABINETS & STORAGE

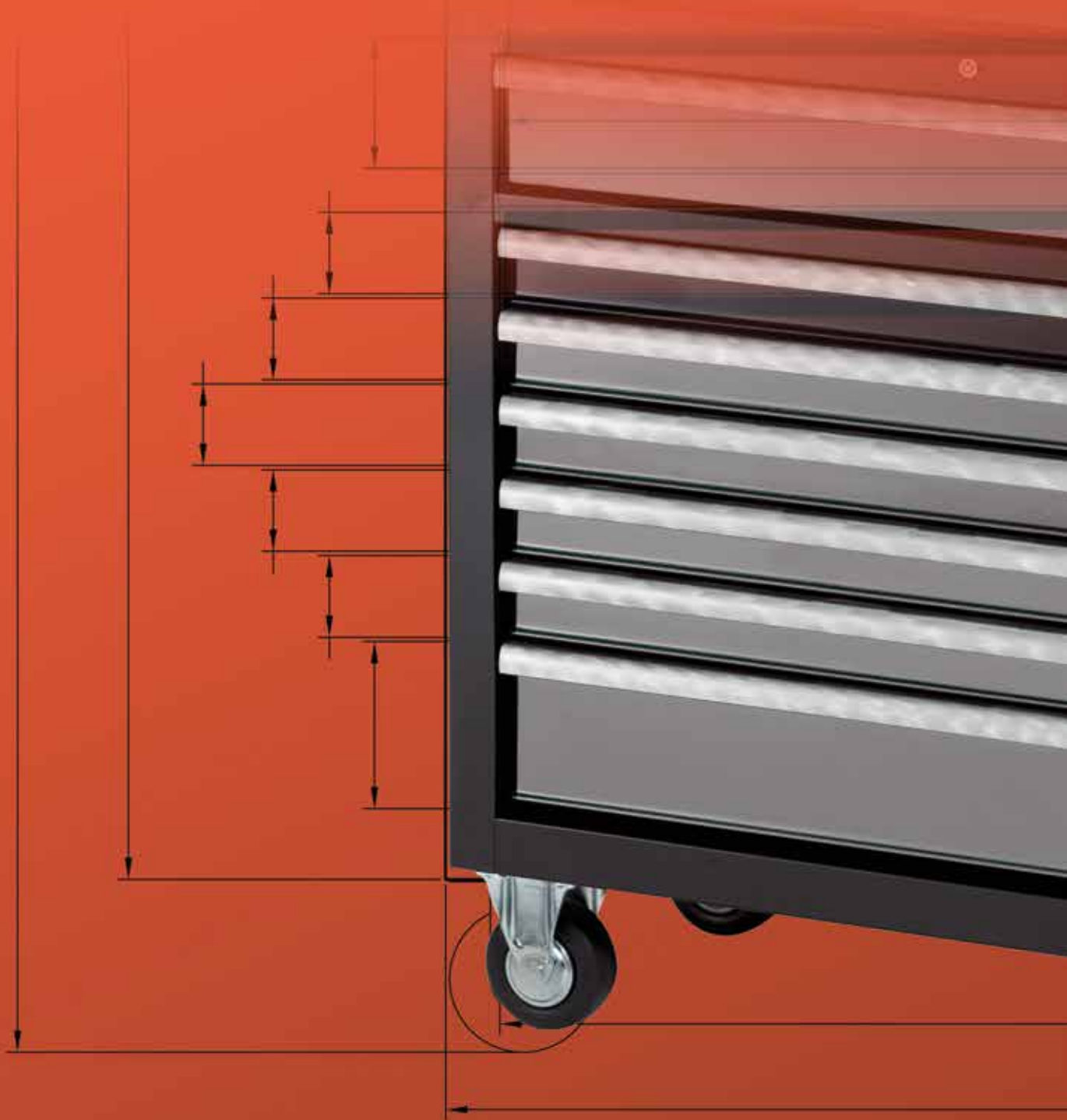

Cabinets & Storage

XL Series
Ball Bearing Series
Tool Storage Accessories
Modular Storage System

**GEARWRENCH XL SERIES
TOOL STORAGE**



Trigger Lock drawer system keeps drawers in place and opens with a natural pull operation (excluding 83159)

All drawers feature Auto Return, which snaps the drawers closed in the final inches of operation



Formed with rolled over drawer walls add strength and rigidity



Double Ball-Bearing construction offers exceptional load capacity and easy slide action

GearWrench now offers the industrial strength XL Tool Storage series. Professionals have come to expect innovation and increased productivity when using GearWrench products; with the XL series you can continue to expect the same superior design and construction to make you more productive on the job. Choose XL when you need a tool storage system that stands up to your growing demands. Formed with rolled over drawer walls, heavy gauge steel bodies, and stamped drawer bottoms; the XL series provides the required strength, durability and rigidity to withstand your professional demands.



All drawers come with drawer liners

CABINETS & STORAGE

AVAILABLE IN:

- XL Tool Chests
- XL Tool Roller Cabinets

CABINETS & STORAGE

Dual gas shocks on lids offer support and easily controlled closure



A 9 mm top mat provides protection and support on all cabinets



High strength side lift handles are integrated into the box wall for added durability and lift capacity



Barrel style lock and key are unique combination for security and durability

Durable powder-coated full-polished lacquer coating protects against scratches and marring



One set of locking casters on all cabinets and carts

26 SERIES

83154 - 26"/660mm 4 Drawer Chest

Width (mm)	Depth (mm)	Height (mm)	Weight (kg)	Volume (m³)		
660	406	483	33	0.13		
Drawer Dimensions			Width (mm)	Depth (mm)	Height (mm)	Load Wt. (kg)
4 Drawers			569	366	70	40
1 Tray			655	400	45	35



83159 - 26"/660mm 8 Drawer Chest

Width (mm)	Depth (mm)	Height (mm)	Weight (kg)	Load Wt. (kg)	Volume (m³)	
660	406	437	28	315	0.12	
Drawer Dimensions			Width (mm)	Depth (mm)	Height (mm)	Load Wt. (kg)
1 Tray			655	400	59	35
1 Drawer			168	366	124	35
4 Drawers			168	366	53	35
2 Drawers			569	366	55	35
1 Drawer			569	366	81	35



83155 - 26"/660mm 7 Drawer Roller Cabinet

Width (mm)	Depth (mm)	Height (mm)	Weight (kg)	Load Wt. (kg)	Volume (m³)	Casters
680	457	991	70	400	0.31	5" x 2" PP
Drawer Dimensions			Width (mm)	Depth (mm)	Height (mm)	Load Wt. (kg)
5 Drawers			565	394	57	40
2 Drawers			565	394	140	40

- Caster Type: PP (Polypropylene)



CABINETS & STORAGE

26 SERIES

CABINETS & STORAGE



26" 8 Drawer Chest - Red, Orange or Green

Width (mm)	Depth (mm)	Height (mm)	Weight (kg)
660	307	432	36

Drawer Dimensions	Width (mm)	Depth (mm)	Height (mm)	Load Wt. (kg)
4 Drawers	169	272	50	30
1 Drawer	169	272	102	30
2 Drawers	568	272	50	30
1 Drawer	568	272	75	30

Item No.	Description
83162R	660mm/26" 8 Drawer Chest, Red
83162O	660mm/26" 8 Drawer Chest, Orange
83162G	660mm/26" 8 Drawer Chest, Green

- Deluxe aluminium drawer pulls
- Auto-return drawers secure drawers closed
- Barrel locks for safely securing your tools
- Non-slip drawer liners
- Ball bearing construction on all drawers offers exceptional load capacity and easy slide action
- Dual gas struts on lids for support and easy controlled closure



26" 7 Drawer Roller Cabinet - Red, Orange or Green

Width (mm)	Depth (mm)	Height (mm)	Weight (kg)
680	459	859 - without casters	61

Drawer Dimensions	Width (mm)	Depth (mm)	Height (mm)	Load Wt. (kg)
5 Drawers	568	398	75	40
2 Drawers	568	398	154	40

Item No.	Description
83161R	680mm/27" 7 Drawer Roller Cabinet, Red
83161O	680mm/27" 7 Drawer Roller Cabinet, Orange
83161G	680mm/27" 7 Drawer Roller Cabinet, Green

- Deluxe aluminium drawer pulls
- Heavy duty 5" x 2" casters
- Auto-return drawers secure drawers closed
- Barrel locks for safely securing your tools
- Non-slip drawer liners
- Ball bearing construction on all drawers offers exceptional load capacity and easy slide action

42 SERIES

83156 - 42"/1066mm 8 Drawer Chest

Width (mm)	Depth (mm)	Height (mm)	Weight (kg)	Volume (m ³)		
1053	464	521	72	0.25		
Drawer Dimensions			Width (mm)	Depth (mm)	Height (mm)	Load Wt. (kg)
4 Drawers			572	394	57	40
4 Drawers			305	394	57	40
Tray			1048	459	39	80



83157 - 42"/1066mm 11 Drawer Roller Cabinet

Width (mm)	Depth (mm)	Height (mm)	Weight (kg)	Load Wt. (kg)	Volume (m ³)	Casters
1069	483	991	130	549	0.511	5"x 2" TPR
Drawer Dimensions			Width (mm)	Depth (mm)	Height (mm)	Load Wt. (kg)
5 Drawers			578	394	57	40
3 Drawers			311	394	57	40
1 Drawer			311	394	298	60
1 Drawer			578	394	140	40
1 Drawer			934	394	95	60

• Caster Type: TPR (Thermoplastic Rubber)



53 SERIES

83160 - 53"/1346mm 8 Drawer Tool Chest

Width (mm)	Depth (mm)	Height (mm)	Weight (kg)	Load Wt. (kg)	Volume (m ³)	
1340	471	523	134	450	0.330	
Drawer Inside Dimensions			Width (mm)	Depth (mm)	Height (mm)	Load Wt. (kg)
4 Drawers			753	397	60	45
4 Drawers			409	397	60	45
Tray			1336	466	39	90



83158 - 53"/1346mm 9 Drawer Roller Cabinet

Width (mm)	Depth (mm)	Height (mm)	Weight (kg)	Load Wt. (kg)	Volume (m ³)	Casters
1346	483	1003	148	800	0.652	5"x 2" PU
Drawer Inside Dimensions			Width (mm)	Depth (mm)	Height (mm)	Load Wt. (kg)
3 Drawers			409	397	60	40
2 Drawers			753	397	60	45
1 Drawer			753	397	139	45
1 Drawer			753	397	218	45
1 Drawer			409	397	297	90
1 Drawer			1223	397	96	90

• Caster Type: PU (Polyurethane)



TOTES & SMALL BOXES



83151 - 20"/508mm 3 Drawer Tool Box

Width (mm)	Depth (mm)	Height (mm)	Weight (kg)
508	216	305	8.09

- Portable tool box with ball bearing drawer slides
- Keyed center lock for security
- Includes cantilever tray



83147 - 16"/406mm Tool Bag

Width (mm)	Depth (mm)	Height (mm)	Weight (kg)
407	324	203	1.71

- All weather durable heavy-duty construction
- * Tools pictured not included



83140 - Technicians Tool Bag

Width (mm)	Depth (mm)	Height (mm)	Weight (kg)
410	150	360	2.4

- 32 Pockets - 26 Hand tool pockets, 3 large flap pockets with hook & loop seal, 2 side pockets with zips
- Pull out stand to keep bag upright
- Padded shoulder strap for quick and comfortable transportation
- Soft rubber carry handle



83148 - 16½"/419mm Plastic Tool Box

Width (mm)	Depth (mm)	Height (mm)	Weight (kg)
419	196	216	1.6

- Plastic hand box with comfort grip handle
- Includes tote tray and two compartments in lid



83130 - 19"/482mm Tote Box

Width (mm)	Depth (mm)	Height (mm)	Weight (kg)
483	152	165	4.5

- Dual latch with lock clasps
- Includes tote tray

MISCELLANEOUS

**83103 - 3 Pc. Slide Rail Socket System
1/4" 3/8" & 1/2" DRIVE**

Item No.	Description
83105	Red Slide Socket Rail 1/4" Drive
83101D	Red Slide Socket Rail 3/8" Drive
83102	Red Slide Socket Rail 1/2" Drive

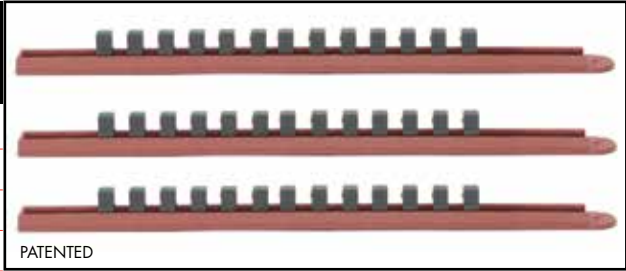

Open Stock - Socket Rails

Item No.	Description
83105	Red Slide Socket Rail 1/4" Drive
83101D	Red Slide Socket Rail 3/8" Drive
83102	Red Slide Socket Rail 1/2" Drive

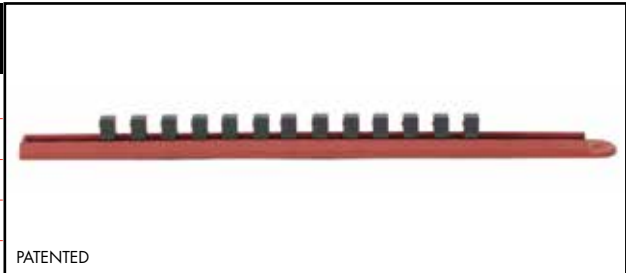

**83104 - Universal Magnetic Parts Tray -
Circular**



CABINETS & STORAGE

MODULAR STORAGE SYSTEM



Refer to the following pages for EVA Tray Sets, Metal Case Sets & Blow Moulded Case Sets which suit the drawer types A and B, as illustrated



The GearWrench Modular Storage System comprises a range of tools contained in EVA Trays, Metal Cases and Blow Moulded Cases, all designed to conveniently fit into most tool chests and trolleys/cabinets. The range also includes Combination Sets comprising Tool Chest and/or Trolley complete with Tools in EVA Trays

Modular Storage System

EVA Trays with Tools
Metal Case Sets
Blow Moulded Case Sets

For further information refer to the following pages or the GearWrench Modular Storage System brochure

COMBINATION STORAGE & TOOL SETS

83170 - Combination Tool Set - Chest + 90 Pc Socket Set METRIC/SAE

Item No.	Description
83159	Deep Tool Chest (660 x 406 x 437mm)
83071	90 Pc. Socket Set METRIC/SAE 1/4", 3/8", & 1/2" Drives
1/4" Drive 6pt. Sockets: 5/32", 3/16", 7/32", 1/4", 9/32", 5/16", 11/32", 3/8", 7/16", 1/2" 1/4"	
1/4" Drive 6pt. Sockets: 4mm, 5mm, 5.5mm, 6mm, 7mm, 8mm, 9mm, 10mm, 11mm, 12mm, 13mm	
1/4" Drive 6pt. Deep Sockets: 1/4", 9/32", 5/16", 11/32", 3/8", 7/16", 1/2"	
1/4" Drive 6pt. Deep Sockets: 7mm, 8mm, 9mm, 10mm, 11mm, 12mm, 13mm	
1/4" Drive Teardrop Quick Release Ratchet; 3" Extension Bar; 1/4" Drive Bit Holder Socket	
3/8" Drive 6pt. Deep Sockets: 9/16", 5/8", 11/16", 3/4"	
3/8" Drive 6pt. Deep Sockets: 14mm, 15mm, 16mm, 17mm, 18mm, 19mm	
3/8" Drive 12pt. Sockets: 3/8", 7/16", 1/2", 9/16", 5/8", 11/16", 3/4", 13/16", 7/8"	
3/8" Drive 12pt. Sockets: 10mm, 11mm, 12mm, 13mm, 14mm, 15mm, 16mm, 17mm, 18mm, 19mm, 21mm	
3/8" Drive Teardrop Quick Release Ratchet; 6" Extension Bar; 3/8" Drive Spark Plug Socket 5/8"	
1/2" Drive 12pt. Sockets: 11/16", 3/4", 13/16", 7/8", 15/16", 1", 1-1/8", 1-1/4"	
1/2" Drive 12pt. Sockets: 19mm, 20mm, 21mm, 22mm, 24mm, 25mm, 27mm, 30mm, 32mm	
1/2" Drive Quick Release Tear Drop Ratchet; 3" Extension Bar	
EVA Tray Included: uncut 655mm x 395mm, cut = 557mm x 360mm	



MODULAR STORAGE

6
POINT
SOCKETS

12
POINT
SOCKETS

1/4" DRIVE

3/8" DRIVE

1/2" DRIVE

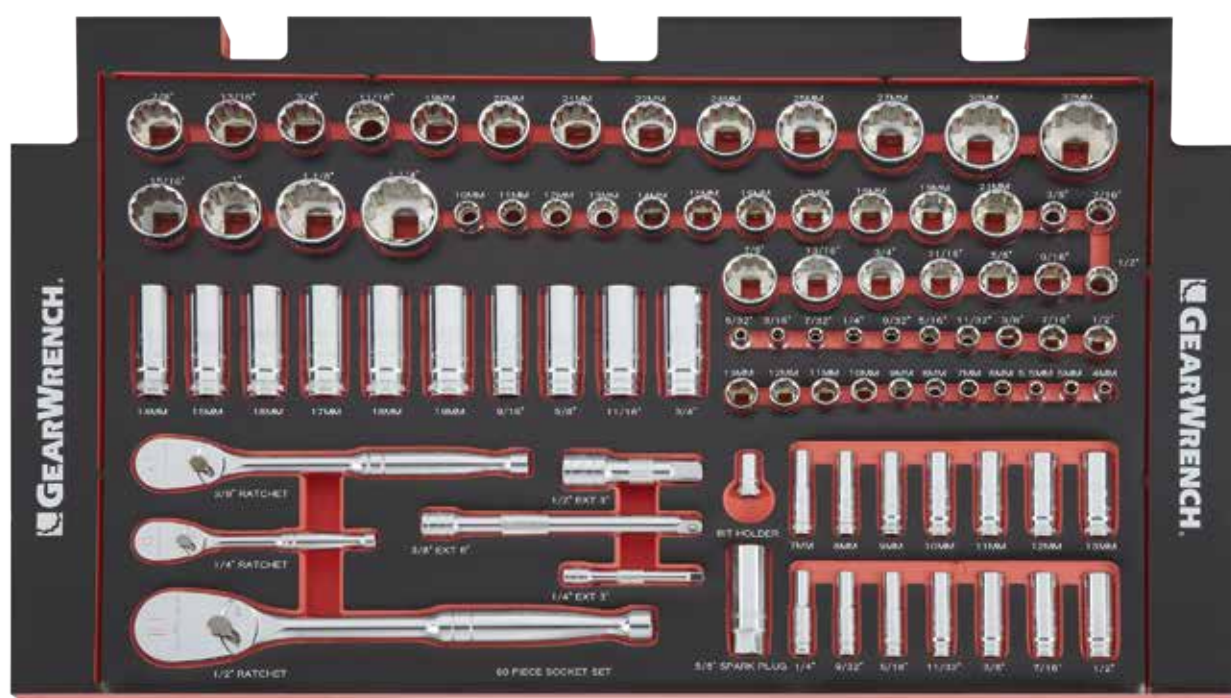

83071 90 pc. METRIC/SAE 6 & 12 Pt. SOCKET Set

COMBINATION STORAGE & TOOL SETS

MODULAR STORAGE



83171 - Combination Tool Set - Chest + 189 Pc Tools

Item No.	Description
83159	Deep Tool Chest (660 x 406 x 437mm)
83071	90 Pc. Socket Set METRIC/SAE 1/4", 3/8", & 1/2" Drives
83072	12 Pc. Plier Set
83073	52 Pc. Screwdriver Set
83075	24 Pc. Ratcheting Wrench Set
83076	3 Pc. Adjustable Wrench Set
83077	3 Pc. Snip Set
83078	4 Pc. File Set

Refer Pages 38, 39 & 40 for list of contents in the above sets.



1/4" DRIVE **3/8" DRIVE** **1/2" DRIVE**

83071 90 pc. METRIC/SAE 6 & 12 Pt. Socket Set

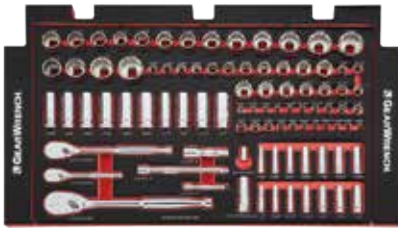

83072 12 pc. plier Set



83073 52 pc. screwdriver Set

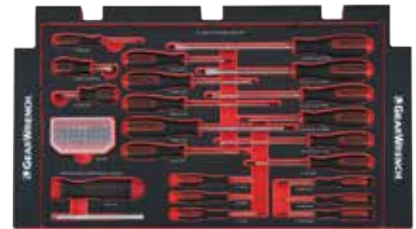

83075 24 pc. METRIC/SAE ratcheting wrench Set



83076 3 pc. adjustable wrench Set



83077 3 pc. Aviation Snip Set



83078 4 pc. File Set



COMBINATION STORAGE & TOOL SETS

83172 - Combination Tool Set - Chest + Trolley + 205 Pc Tools

Item No.	Description
83155	Trolley - Rolling, 7 Drawer 26"
83159	Deep Tool Chest (660 x 406 x 437mm)
83071	90 Pc. Socket Set METRIC/SAE 1/4", 3/8", & 1/2" Drives
83072	12 Pc. Plier Set
83073	52 Pc. Screwdriver Set
83074	15 Pc. Nutdriver & Hammer Set
83075	24 Pc. Ratcheting Wrench Set
83076	3 Pc. Adjustable Wrench Set
83077	3 Pc. Snip Set
83078	4 Pc. File Set

Refer Pages 38, 39 & 40 for list of contents in the above sets.



MODULAR STORAGE



83071 90 pc. METRIC/SAE 6 & 12 Pt. Socket Set

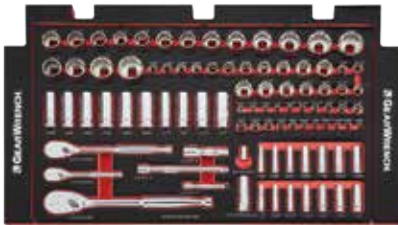

83072 12 pc. plier Set



83073 52 pc. screwdriver Set

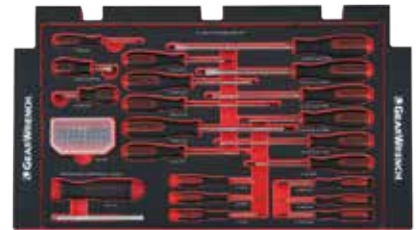

83074 15 pc. nutdriver & hammer Set



83075 24 pc. METRIC/SAE ratcheting wrench Set



83076 3 pc. adjustable wrench Set



83077 3 pc. Aviation Snip Set



83078 4 pc. File Set



EVA TRAYS WITH TOOLS



EVA tray can be reduced in size for convenient storage into most tool chests/trolley drawers

MODULAR STORAGE

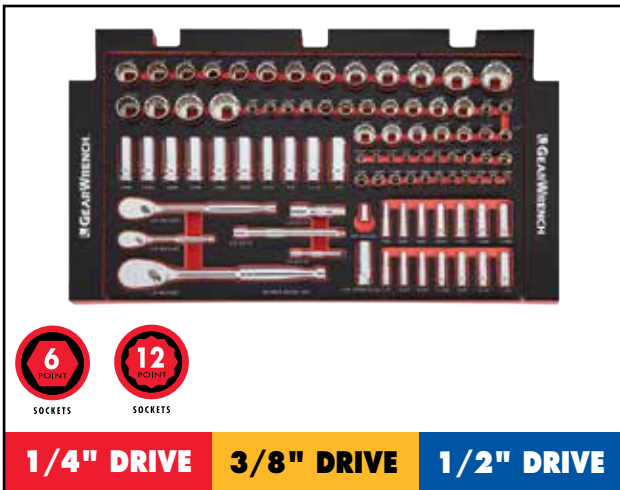

Fits drawer type **A** as shown on page 34.

**83071 - 90 Pc. Socket Set METRIC/SAE
1/4", 3/8" & 1/2" DRIVE**

Description

1/4" Drive 6pt. Sockets: 5/32", 3/16", 7/32", 1/4", 9/32", 5/16", 11/32", 3/8", 7/16", 1/2" 1/4"

1/4" Drive 6pt. Sockets: 4mm, 5mm, 5.5mm, 6mm, 7mm, 8mm, 9mm, 10mm, 11mm, 12mm, 13mm

1/4" Drive 6pt. Deep Sockets: 1/4", 9/32", 5/16", 11/32", 3/8", 7/16", 1/2"

1/4" Drive 6pt. Deep Sockets: 7mm, 8mm, 9mm, 10mm, 11mm, 12mm, 13mm

1/4" Drive Teardrop Quick Release Ratchet; 3" Extension Bar; 1/4" Drive Bit Holder Socket

3/8" Drive 6pt. Deep Sockets: 9/16", 5/8", 11/16", 3/4"

3/8" Drive 6pt. Deep Sockets: 14mm, 15mm, 16mm, 17mm, 18mm, 19mm

3/8" Drive 12pt. Sockets: 3/8", 7/16", 1/2", 9/16", 5/8", 11/16", 3/4", 13/16", 7/8"

3/8" Drive 12pt. Sockets: 10mm, 11mm, 12mm, 13mm, 14mm, 15mm, 16mm, 17mm, 18mm, 19mm, 21mm

3/8" Drive Teardrop Quick Release Ratchet; 6" Extension Bar; 3/8" Drive Spark Plug Socket 5/8"

1/2" Drive 12pt. Sockets: 11/16", 3/4", 13/16", 7/8", 15/16", 1", 1-1/8", 1-1/4"

1/2" Drive 12pt. Sockets: 19mm, 20mm, 21mm, 22mm, 24mm, 25mm, 27mm, 30mm, 32mm

1/2" Drive Quick Release Tear Drop Ratchet; 3" Extension Bar

EVA Tray Included: uncut 655mm x 395mm, cut = 557mm x 360mm



Fits drawer type **A** as shown on page 34.

83072 - 12 Pc. Plier Set

Description

Diagonal Cutting Plier: 178mm/7"

Long Nose Plier: 203mm/8"

Groove Joint with Straight Jaw: 305mm/12"

Universal Plier: 203mm/8"

End Nipper: 203mm/8"

Mini Diagonal Plier

Mini Long Nose Plier

Mini Needle Nose Plier

Mini End Nipper

Mini Duck Bill Plier

Long Nose Locking Plier with Wire Cutter: 152mm/6"

Curved Jaw Locking Plier with Wire Cutter: 254mm/10"

EVA Tray Included: uncut 655mm x 395mm, cut = 557mm x 360mm

EVA TRAYS WITH TOOLS

83073 - 52 Pc. Screwdriver Set

Description

Slotted Screwdrivers: 6mm x 38mm, 5mm x 150mm, 6mm x 100mm, 6mm x 150mm, 8mm x 150mm, 10mm x 200mm

Phillips Screwdrivers: PH#0 x 65mm, PH#1 x 75mm, PH#1 x 150mm, PH#2 x 38mm, PH#2 x 100mm, PH#3 x 150mm

Mini Slotted Screwdrivers: 1.5mm, 2.0mm, 2.5mm

Mini Phillips Screwdrivers: PH#00, PH#0, PH#1

Long Torx® Screwdrivers: T-15, T-20

Hex Bits: 1/8", 5/32", 3/16", 7/32", 1/4", 5/16"

Hex Bits: 3mm, 4mm, 5mm, 6mm, 7mm, 8mm

Slotted Bits: 5/32", 7/32", 1/4"

Slotted Bits: 4mm, 5.5mm, 6.5mm

Torx® Bits: T-8, T-10, T-15, T-20, T-25, T-27, T-30, T-40

Phillips Bits: PH#0, PH#1, PH#2, PH#3

Ratcheting Screwdriver Handle

6mm Shank Magnetic Bit Shaft 150mm

EVA Tray Included: uncut 655mm x 395mm, cut = 557mm x 360mm

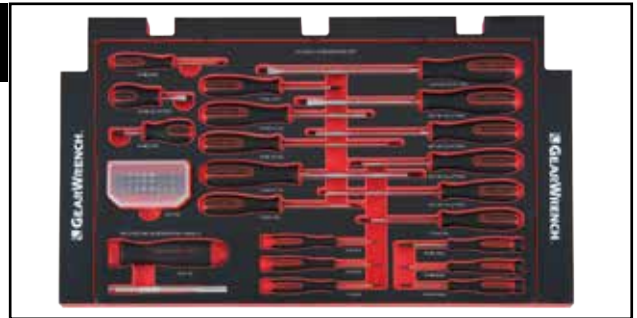

Fits drawer type **A** as shown on page 34.

**83074 - 15 Pc. Nut Driver + Hammer Set
METRIC/SAE**

Description

Nut Driver Hollow Shaft Metric: 6mm, 7mm, 8mm, 9mm, 10mm, 11mm, 12mm

Nut Driver Hollow Shaft SAE: 3/16", 1/4", 5/16", 11/32", 3/8", 7/16", 1/2"

16oz Ball Pein Hammer Fiberglass

EVA Tray Included: uncut 655mm x 395mm, cut = 557mm x 360mm

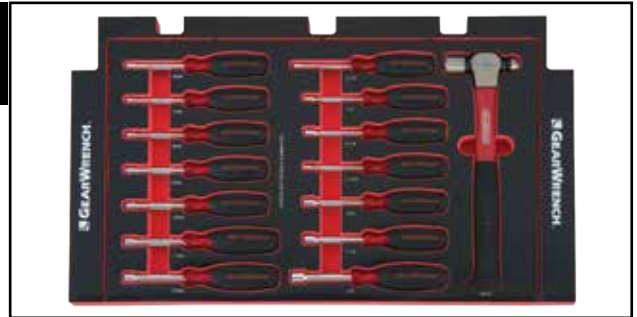

Fits drawer type **A** as shown on page 34.

**83075 - 24 Pc. Ratcheting Wrench Set
METRIC/SAE**

Description

Combination Ratcheting Wrench METRIC: 7mm, 8mm, 9mm, 10mm, 11mm, 12mm, 13mm, 14mm, 15mm, 16mm, 17mm, 19mm, 20mm, 21mm, 22mm

Combination Ratcheting Wrench SAE: 5/16", 3/8", 7/16", 1/2", 9/16", 3/8", 11/16", 3/4", 3/16"

EVA Tray Included: uncut 655mm x 395mm, cut = 557mm x 360mm



Fits drawer type **A** as shown on page 34.

MODULAR STORAGE

EVA TRAYS WITH TOOLS

MODULAR STORAGE

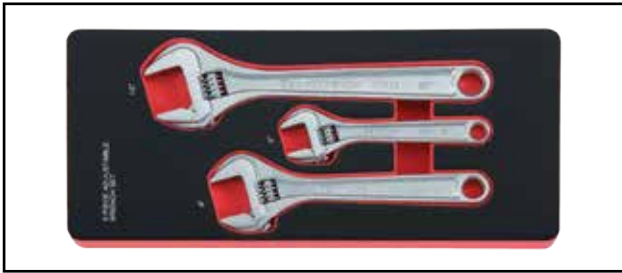

83076 - 3 Pc. Adjustable Wrench Set

Description

150mm/6" Chrome Adjustable wrench

200mm/8" Chrome adjustable wrench

250mm/10" Chrome adjustable wrench

EVA Tray Included: 161mm x 360mm

Fits drawer type **B** as shown on page 34.



83077 - 3 Pc. Aviation Snip Set

Description

Straight cutting aviation snip

Right cutting aviation snip

Left cutting aviation snip

EVA Tray Included: 161mm x 360mm

Fits drawer type **B** as shown on page 34.



83078 - 4 Pc. File Set

Description

File (Flat): 203mm/8"

File (Round): 203mm/8"

File (Half round): 203mm/8"

File (Triangle): 203mm/8"

EVA Tray Included: 161mm x 360mm

Fits drawer type **B** as shown on page 34.

METAL CASE SETS



EVA tray can be easily removed for convenient storage into a tool chest/ trolley drawer

**83050 - 42 Pc. Socket Set METRIC/SAE
1/4" & 3/8" DRIVE**

Description

- 1/4" Drive 6pt. Sockets: 3/16", 7/32", 1/4", 9/32", 5/16", 11/32", 3/8", 7/16", 1/2"
- 1/4" Drive 6pt. Sockets: 4mm, 5mm, 6mm, 7mm, 8mm, 9mm, 10mm, 11mm, 12mm
- 1/4" Drive Full Polish Teardrop Ratchet; 1/4"F x 3/8"M Adapter
- 3/8" Drive 12pt. Sockets: 3/8", 7/16", 1/2", 9/16", 5/8", 11/16", 3/4"
- 3/8" Drive 12pt. Sockets: 8mm, 10mm, 11mm, 12mm, 13mm, 14mm, 15mm, 17mm, 19mm
- 3/8" Drive Full Polish Teardrop Ratchet; 3" Extension Bar; Universal Joint; 3/8"F x 1/4"M Adapter; Spark Plug Socket 5/8"; Spark Plug Socket 13/16"
- EVA Tray Included: 168mm x 360mm



Fits drawer type B as shown on page 34.

**83051 - 39 Pc. Socket Set METRIC/SAE
1/4" DRIVE**

Description

- 1/4" Drive 6pt. Sockets: 3/16", 7/32", 1/4", 9/32", 5/16", 11/32", 3/8", 7/16", 1/2"
- 1/4" Drive 6pt. Sockets: 4mm, 5mm, 6mm, 7mm, 8mm, 9mm, 10mm, 11mm, 12mm, 13mm
- 1/4" Drive 6pt. Deep Sockets: 3/16", 1/4", 5/16", 11/32", 3/8", 7/16", 1/2"
- 1/4" Drive 6pt. Deep Sockets: 4mm, 5mm, 6mm, 7mm, 8mm, 10mm, 11mm, 12mm, 13mm
- 1/4" Drive Full Polish Teardrop Ratchet; 5 1/2" Flex Handle; Universal Joint; 3" Extension Bar
- EVA Tray Included: 168mm x 360mm



Fits drawer type B as shown on page 34.

**83052 - 10 Pc. Wrench Set Ratcheting
Combination METRIC**

Description

- Combination Ratcheting Wrench: 8mm, 10mm, 11mm, 12mm, 13mm, 14mm, 15mm, 16mm, 17mm, 19mm
- EVA Tray Included: 168mm x 360mm



Fits drawer type B as shown on page 34.

**83053 - 10 Pc. Wrench Set Ratcheting
Combination SAE**

Description

- Combination Ratcheting Wrench: 1/4", 5/16", 3/8", 7/16", 1/2", 9/16", 5/8", 11/16", 3/4", 13/16"
- EVA Tray Included: 168mm x 360mm



Fits drawer type B as shown on page 34.

MODULAR STORAGE

METAL CASE SETS



83054 - 10 Pc. Wrench Set Ratcheting Reversible Combination METRIC

Description

Combination Ratcheting Reversible Wrench: 8mm, 10mm, 11mm, 12mm, 13mm, 14mm, 15mm, 16mm, 17mm, 19mm

EVA Tray Included: 168mm x 360mm

Fits drawer type **B** as shown on page 34.



83055 - 8 Pc. Wrench Set Locking Flex Ratcheting Combination METRIC

Description

Locking Flex Ratcheting Combination Wrench: 8mm, 10mm, 11mm, 12mm, 13mm, 14mm, 15mm, 16mm

EVA Tray Included: 168mm x 360mm

Fits drawer type **B** as shown on page 34.



83056 - 10 Pc. Wrench Set Open End Ratcheting Combination METRIC

Description

Open Ended Ratcheting Combination Wrench: 8mm, 10mm, 11mm, 12mm, 13mm, 14mm, 15mm, 16mm, 17mm, 19mm

EVA Tray Included: 168mm x 360mm

Fits drawer type **B** as shown on page 34.



83057 - 42 Pc. Socket Set METRIC/SAE 3/8" DRIVE

Description

3/8" Drive 6pt. Deep Sockets: 8mm, 10mm, 11mm, 12mm, 13mm, 15mm

3/8" Drive 12pt. Sockets: 1/4", 5/16", 3/8", 7/16", 1/2", 9/16", 5/8", 11/16", 3/4", 13/16", 7/8", 15/16", 1"

3/8" Drive 12pt Sockets: 8mm, 9mm, 10mm, 11mm, 12mm, 13mm, 14mm, 15mm, 16mm, 17mm, 18mm, 19mm, 20mm, 21mm, 22mm

3/8" Drive Full Polish Teardrop Ratchet; 12" Full Polish Flex Handle; Universal Joint; 3" Extension Bar; 6" Extension Bar; 10" Extension Bar; Spark Plug Socket 5/8", Spark Plug Socket 13/16"

EVA tray included 250mm x 424mm

Fits drawer type **A** (loose fit).



83058 - 23 Pc. Socket Set METRIC 1/2" DRIVE

Description

1/2" Drive 12pt. Standard Sockets: 8mm, 10mm, 11mm, 12mm, 13mm, 14mm, 15mm, 16mm, 17mm, 18mm, 19mm, 21mm, 22mm, 23mm, 24mm, 27mm, 30mm, 32mm;

1/2" Drive Full Polish Teardrop Ratchet 11"; 1/2" Drive Full Polish Flex Handle 15"; 1/2" Drive Universal Joint; 1/2" Drive Standard Extension 3", 1/2" Drive Standard Extension 10"

EVA tray included 250mm x 424mm

Fits drawer type **A** (loose fit).

BLOW MOULDED CASE SETS



Clasps can be easily removed and the case separated into two halves for convenient storage into a tool chest/trolley drawer

**83060 - 31 Pc. Socket Set + Wrench Set
METRIC/SAE 1/4" DRIVE**

Description

1/4" Drive 6pt. Standard Sockets: 4mm, 5mm, 6mm, 7mm, 8mm, 9mm, 10mm, 11mm, 12mm, 13mm

1/4" Drive 6pt. Standard Sockets: 3/16", 7/32", 1/4", 9/32", 5/16", 11/32", 3/8", 7/16", 1/2"

1/4" Drive Full Polish Teardrop Ratchet; 1/4" Drive Flex Handle 5-1/2"; 1/4" Drive Universal Joint; 1/4" Drive Standard Extension 3"

Long Pattern Combination Non-Ratcheting Wrenches: 8mm, 9mm, 10mm, 11mm, 12mm, 13mm, 14mm, 15mm

Blow moulded case - 168mm x 360mm



1/4" DRIVE
Fits drawer type **B** as shown on page 34.

**83061 - 58 Pc. Socket Set + Wrench Set
METRIC/SAE 3/8" DRIVE**

Description

3/8" Drive 6pt. Deep Sockets: 8mm, 10mm, 11mm, 12mm, 13mm, 15mm

3/8" Drive 12pt. Sockets: 1/4", 5/16", 3/8", 7/16", 1/2", 9/16", 5/8", 11/16", 3/4", 13/16", 7/8", 15/16", 1"

3/8" Drive 12pt. Sockets: 8mm, 9mm, 10mm, 11mm, 12mm, 13mm, 14mm, 15mm, 16mm, 17mm, 18mm, 19mm, 20mm, 21mm, 22mm

3/8" Drive Full Polish Teardrop Ratchet; 12" Full Polish Flex Handle; 3" Extension Bar; 6" Extension Bar; 10" Extension Bar; Universal Joint; 5/8" Spark Plug Socket; 13/16" Spark Plug Socket

Combination Ratcheting Wrench: 8mm, 10mm, 11mm, 12mm, 13mm, 14mm, 15mm, 16mm, 19mm

Combination Ratcheting Wrench: 3/8", 7/16", 1/2", 9/16", 5/8", 11/16", 3/4"

Blow moulded case - 565mm x 360mm x 90mm



3/8" DRIVE
Fits drawer type **A** as shown on page 34.

**83062 - 34 Pc. Socket + Wrench Set
METRIC 1/2" DRIVE**

Description

1/2" Drive 12pt. Sockets: 8mm, 10mm, 11mm, 12mm, 13mm, 14mm, 15mm, 16mm, 17mm, 18mm, 19mm, 21mm, 22mm, 23mm, 24mm, 27mm, 30mm, 32mm;

1/2" Drive Full Polish Teardrop Ratchet; 15" Full Polish Flex Handle; 3" Extension Bar; 10" Extension Bar; Universal Joint

Reversible Combination Ratcheting Wrench: 10mm, 11mm, 12mm, 13mm, 14mm, 15mm, 16mm, 17mm, 19mm

Blow moulded case - 565mm x 360mm x 90mm



1/2" DRIVE
Fits drawer type **A** as shown on page 34.

RATCHETS, SOCKETS & DRIVE TOOLS

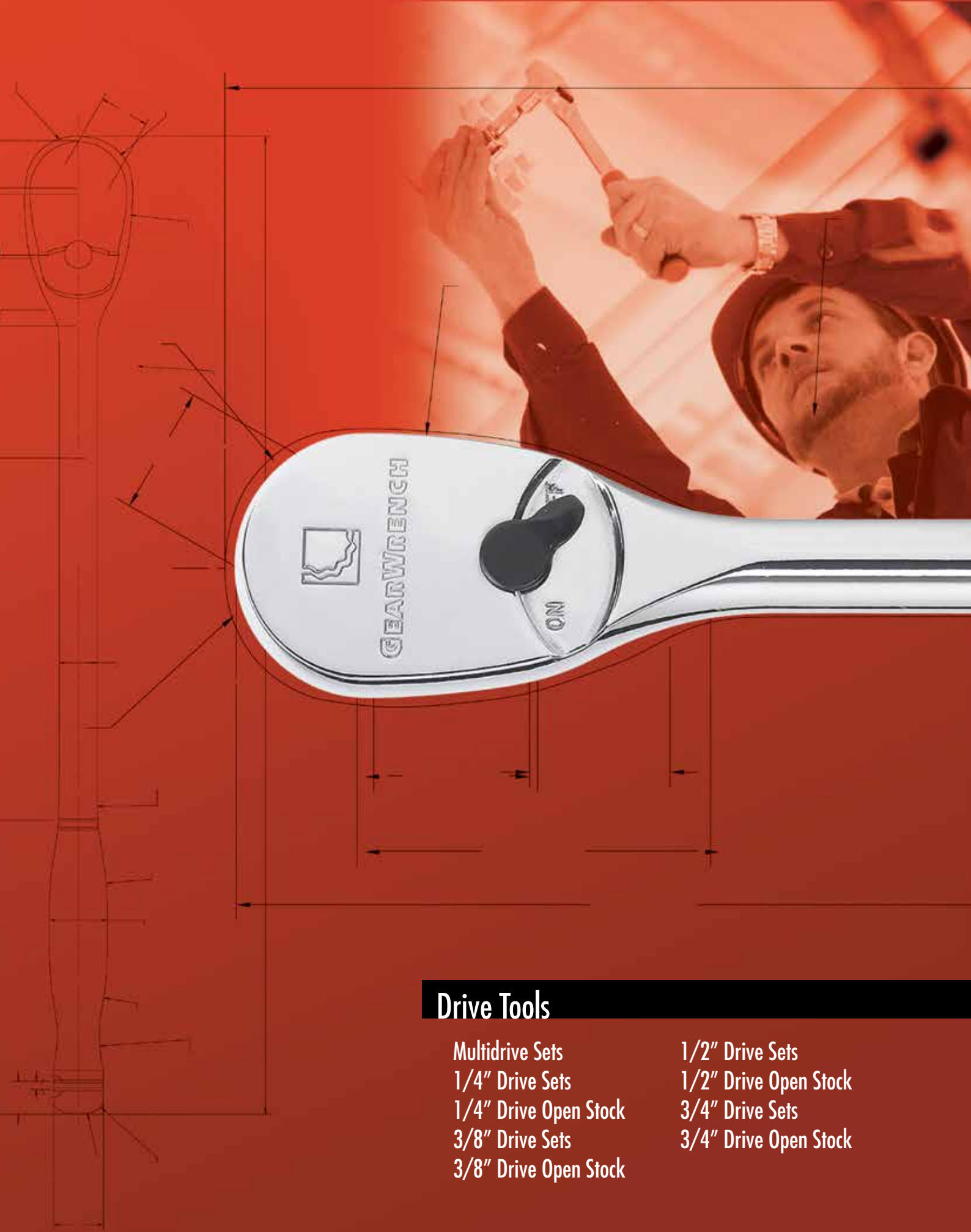

Drive Tools

Multidrive Sets
1/4" Drive Sets
1/4" Drive Open Stock
3/8" Drive Sets
3/8" Drive Open Stock

1/2" Drive Sets
1/2" Drive Open Stock
3/4" Drive Sets
3/4" Drive Open Stock

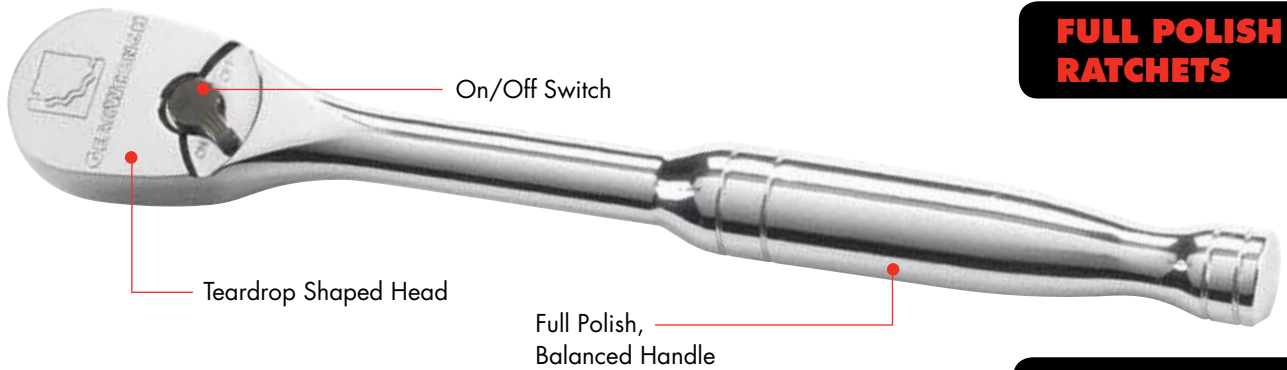

FULL POLISH RATCHETS



Lower profile head provides better access

- AVAILABLE IN:**
- Flex Head Ratchets
 - Teardrop Head Ratchets
 - Stubby Ratchets
 - Offset Ratchets

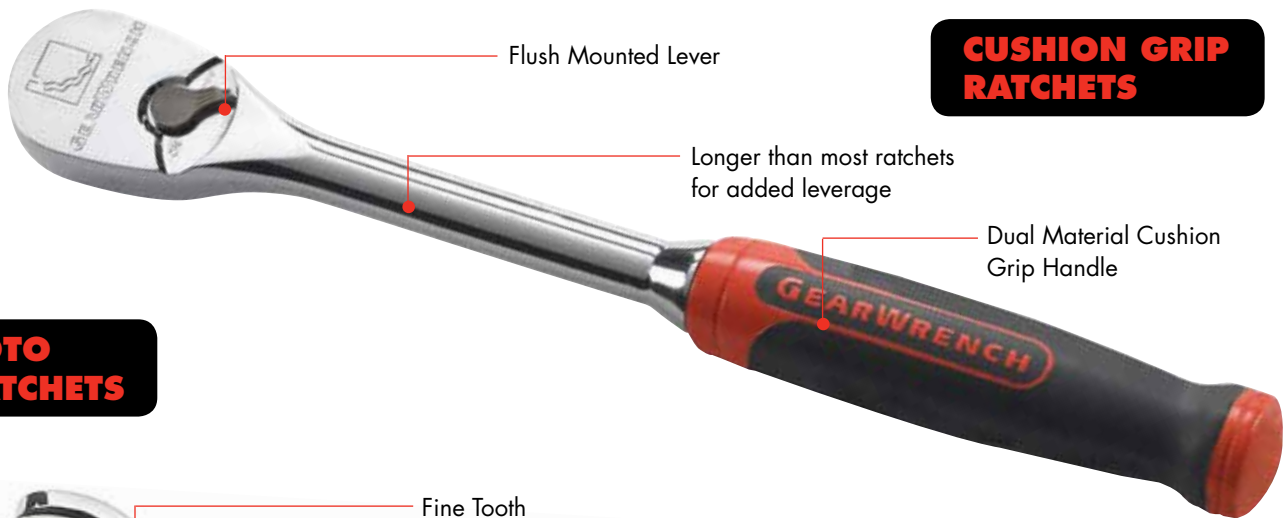

CUSHION GRIP RATCHETS

ROTO RATCHETS



Head Rotates 180 Degrees
 Less Than 5 Degree Swing Arc for Greater Access



- APPLICATIONS**
- Head bolts with variable obstructions
 - Spark plug service
 - In vertical position can speed down like a screwdriver
 - In horizontal position, provides increased torque

SOCKETS

AVAILABLE IN:

- Standard
- Deep
- Spark Plug
- Flex



Entry angle guides fastener

Serration depth as deep as the fastener



Large hard-stamped identification

Double Line (SAE) & Knurled Line (MM) to easily identify Standard vs. Metric Sockets



Ordinary socket

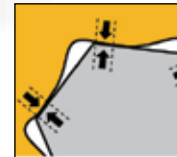

Surface Drive® Technology

MAGNETIC DRIVE TOOLS

Knurled grip provides non-slip surface



Magnetic tip keeps the fastener in the sockets



APPLICATIONS

- Under dashboard
- Tight engine compartments
- Clean environments, where there is a need to contain fasteners from falling between gaps
- Tight access where two hands cannot fit

Strong magnetic tips allow for contact through the base of the socket to hold nuts and bolts in place during use



Products are covered by one or more of the following patents:
 • US 7,185,566

MULTI-DRIVE SETS

80934 - 239 Pc. SAE/METRIC 6 & 12 Pt. Mechanics Tool Set MULTI DRIVE



1/4" DRIVE 3/8" DRIVE 1/2" DRIVE

Material No.	Description				
80104	5/32"	6 Pt.	Std. SAE Socket	1/4"Dr.	
80105	3/16"	6 Pt.	Std. SAE Socket	1/4"Dr.	
80106	7/32"	6 Pt.	Std. SAE Socket	1/4"Dr.	
80107	1/4"	6 Pt.	Std. SAE Socket	1/4"Dr.	
80108	9/32"	6 Pt.	Std. SAE Socket	1/4"Dr.	
80109	5/16"	6 Pt.	Std. SAE Socket	1/4"Dr.	
80110	11/32"	6 Pt.	Std. SAE Socket	1/4"Dr.	
80111	3/8"	6 Pt.	Std. SAE Socket	1/4"Dr.	
80112	7/16"	6 Pt.	Std. SAE Socket	1/4"Dr.	
80113D	1/2"	6 Pt.	Std. SAE Socket	1/4"Dr.	
80114D	9/16"	6 Pt.	Std. SAE Socket	1/4"Dr.	
80125	4 mm	6 Pt.	Std. Metric Socket	1/4"Dr.	
80126	5 mm	6 Pt.	Std. Metric Socket	1/4"Dr.	
80127	5.5 mm	6 Pt.	Std. Metric Socket	1/4"Dr.	
80128	6 mm	6 Pt.	Std. Metric Socket	1/4"Dr.	
80129	7 mm	6 Pt.	Std. Metric Socket	1/4"Dr.	
80130	8 mm	6 Pt.	Std. Metric Socket	1/4"Dr.	
80131	9 mm	6 Pt.	Std. Metric Socket	1/4"Dr.	
80132	10 mm	6 Pt.	Std. Metric Socket	1/4"Dr.	
80133	11 mm	6 Pt.	Std. Metric Socket	1/4"Dr.	
80134	12 mm	6 Pt.	Std. Metric Socket	1/4"Dr.	
80135	13 mm	6 Pt.	Std. Metric Socket	1/4"Dr.	
80136	14 mm	6 Pt.	Std. Metric Socket	1/4"Dr.	
80137	15 mm	6 Pt.	Std. Metric Socket	1/4"Dr.	
80115	3/16"	6 Pt.	Deep SAE Socket	1/4"Dr.	
80116D	7/32"	6 Pt.	Deep SAE Socket	1/4"Dr.	
80117	1/4"	6 Pt.	Deep SAE Socket	1/4"Dr.	
80118	9/32"	6 Pt.	Deep SAE Socket	1/4"Dr.	
80119	5/16"	6 Pt.	Deep SAE Socket	1/4"Dr.	
80120D	11/32"	6 Pt.	Deep SAE Socket	1/4"Dr.	
80121	3/8"	6 Pt.	Deep SAE Socket	1/4"Dr.	
80122D	7/16"	6 Pt.	Deep SAE Socket	1/4"Dr.	
80123	1/2"	6 Pt.	Deep SAE Socket	1/4"Dr.	
80124	9/16"	6 Pt.	Deep SAE Socket	1/4"Dr.	
80138	4 mm	6 Pt.	Deep Metric Socket	1/4"Dr.	
80139	5 mm	6 Pt.	Deep Metric Socket	1/4"Dr.	
80141	6 mm	6 Pt.	Deep Metric Socket	1/4"Dr.	
80142	7 mm	6 Pt.	Deep Metric Socket	1/4"Dr.	
80143	8 mm	6 Pt.	Deep Metric Socket	1/4"Dr.	
80144	9 mm	6 Pt.	Deep Metric Socket	1/4"Dr.	
80145	10 mm	6 Pt.	Deep Metric Socket	1/4"Dr.	

Material No.	Description				
80146	11 mm	6 Pt.	Deep Metric Socket	1/4"Dr.	
80147	12 mm	6 Pt.	Deep Metric Socket	1/4"Dr.	
80148	13 mm	6 Pt.	Deep Metric Socket	1/4"Dr.	
80149	14 mm	6 Pt.	Deep Metric Socket	1/4"Dr.	
80210	3/16"	12 Pt.	Std. SAE Socket	1/4"Dr.	
80211	7/32"	12 Pt.	Std. SAE Socket	1/4"Dr.	
80212	1/4"	12 Pt.	Std. SAE Socket	1/4"Dr.	
80213	9/32"	12 Pt.	Std. SAE Socket	1/4"Dr.	
80214	5/16"	12 Pt.	Std. SAE Socket	1/4"Dr.	
80215	11/32"	12 Pt.	Std. SAE Socket	1/4"Dr.	
80216	3/8"	12 Pt.	Std. SAE Socket	1/4"Dr.	
80217	7/16"	12 Pt.	Std. SAE Socket	1/4"Dr.	
80218	1/2"	12 Pt.	Std. SAE Socket	1/4"Dr.	
80219	9/16"	12 Pt.	Std. SAE Socket	1/4"Dr.	
81014	Quick-Release Teardrop Ratchet			1/4"Dr.	
81101	2" Extension			1/4"Dr.	
81113	3" Extension			1/4"Dr.	
81116	6" Extension			1/4"Dr.	
80350	1/4"	6 Pt.	Std. SAE Socket	3/8" Dr.	
80351	5/16"	6 Pt.	Std. SAE Socket	3/8" Dr.	
80352	3/8"	6 Pt.	Std. SAE Socket	3/8" Dr.	
80353	7/16"	6 Pt.	Std. SAE Socket	3/8" Dr.	
80354	1/2"	6 Pt.	Std. SAE Socket	3/8" Dr.	
80355	9/16"	6 Pt.	Std. SAE Socket	3/8" Dr.	
80356	5/8"	6 Pt.	Std. SAE Socket	3/8" Dr.	
80357	11/16"	6 Pt.	Std. SAE Socket	3/8" Dr.	

MULTI-DRIVE SETS
RATCHETS, SOCKETS & DRIVE TOOLS

MULTI-DRIVE SETS

80934 - Continued

Material No.	Description			
80358	3/4"	6 Pt.	Std. SAE Socket	3/8" Dr.
80359	13/16"	6 Pt.	Std. SAE Socket	3/8" Dr.
80360	7/8"	6 Pt.	Std. SAE Socket	3/8" Dr.
80374	6 mm	6 Pt.	Std. Metric Socket	3/8" Dr.
80375	7 mm	6 Pt.	Std. Metric Socket	3/8" Dr.
80376	8 mm	6 Pt.	Std. Metric Socket	3/8" Dr.
80377	9 mm	6 Pt.	Std. Metric Socket	3/8" Dr.
80378	10 mm	6 Pt.	Std. Metric Socket	3/8" Dr.
80379	11 mm	6 Pt.	Std. Metric Socket	3/8" Dr.
80380	12 mm	6 Pt.	Std. Metric Socket	3/8" Dr.
80381	13 mm	6 Pt.	Std. Metric Socket	3/8" Dr.
80382	14 mm	6 Pt.	Std. Metric Socket	3/8" Dr.
80383	15 mm	6 Pt.	Std. Metric Socket	3/8" Dr.
80384	16 mm	6 Pt.	Std. Metric Socket	3/8" Dr.
80385	17 mm	6 Pt.	Std. Metric Socket	3/8" Dr.
80386	18 mm	6 Pt.	Std. Metric Socket	3/8" Dr.
80387	19 mm	6 Pt.	Std. Metric Socket	3/8" Dr.
80330	20 mm	6 Pt.	Std. Metric Socket	3/8" Dr.
80331	21 mm	6 Pt.	Std. Metric Socket	3/8" Dr.
80332	22 mm	6 Pt.	Std. Metric Socket	3/8" Dr.
80365	3/8"	6 Pt.	Deep SAE Socket	3/8" Dr.
80366	1/4"	6 Pt.	Deep SAE Socket	3/8" Dr.
80367	7/16"	6 Pt.	Deep SAE Socket	3/8" Dr.
80368	1/2"	6 Pt.	Deep SAE Socket	3/8" Dr.
80369	9/16"	6 Pt.	Deep SAE Socket	3/8" Dr.
80370	5/8"	6 Pt.	Deep SAE Socket	3/8" Dr.
80371	11/16"	6 Pt.	Deep SAE Socket	3/8" Dr.
80391	9 mm	6 Pt.	Deep Metric Socket	3/8" Dr.
80392	10 mm	6 Pt.	Deep Metric Socket	3/8" Dr.
80393	11 mm	6 Pt.	Deep Metric Socket	3/8" Dr.
80394	12 mm	6 Pt.	Deep Metric Socket	3/8" Dr.
80395	13 mm	6 Pt.	Deep Metric Socket	3/8" Dr.
80396	14 mm	6 Pt.	Deep Metric Socket	3/8" Dr.
80397	15 mm	6 Pt.	Deep Metric Socket	3/8" Dr.
80398	16 mm	6 Pt.	Deep Metric Socket	3/8" Dr.
80399	17 mm	6 Pt.	Deep Metric Socket	3/8" Dr.
80400	18 mm	6 Pt.	Deep Metric Socket	3/8" Dr.
80401	19 mm	6 Pt.	Deep Metric Socket	3/8" Dr.
80496	1/4"	12 Pt.	Std. SAE Socket	3/8" Dr.
80498	5/16"	12 Pt.	Std. SAE Socket	3/8" Dr.
80498	3/8"	12 Pt.	Std. SAE Socket	3/8" Dr.
80499	7/16"	12 Pt.	Std. SAE Socket	3/8" Dr.

Material No.	Description			
80500	1/2"	12 Pt.	Std. SAE Socket	3/8" Dr.
80501	9/16"	12 Pt.	Std. SAE Socket	3/8" Dr.
80502	5/8"	12 Pt.	Std. SAE Socket	3/8" Dr.
80503	11/16"	12 Pt.	Std. SAE Socket	3/8" Dr.
80504	3/4"	12 Pt.	Std. SAE Socket	3/8" Dr.
80505	13/16"	12 Pt.	Std. SAE Socket	3/8" Dr.
80506	7/8"	12 Pt.	Std. SAE Socket	3/8" Dr.
80482	6 mm	12 Pt.	Std. Metric Socket	3/8" Dr.
80483	7 mm	12 Pt.	Std. Metric Socket	3/8" Dr.
80484	8 mm	12 Pt.	Std. Metric Socket	3/8" Dr.
80485	9 mm	12 Pt.	Std. Metric Socket	3/8" Dr.
80486	10 mm	12 Pt.	Std. Metric Socket	3/8" Dr.
80487	11 mm	12 Pt.	Std. Metric Socket	3/8" Dr.
80488	12 mm	12 Pt.	Std. Metric Socket	3/8" Dr.
80489	13 mm	12 Pt.	Std. Metric Socket	3/8" Dr.
80490	14 mm	12 Pt.	Std. Metric Socket	3/8" Dr.
80491	15 mm	12 Pt.	Std. Metric Socket	3/8" Dr.
80492	16 mm	12 Pt.	Std. Metric Socket	3/8" Dr.
80493	17 mm	12 Pt.	Std. Metric Socket	3/8" Dr.
80494	18 mm	12 Pt.	Std. Metric Socket	3/8" Dr.
80495	19 mm	12 Pt.	Std. Metric Socket	3/8" Dr.
80596	20 mm	12 Pt.	Std. SAE Socket	3/8" Dr.
80597	21 mm	12 Pt.	Std. SAE Socket	3/8" Dr.
80598	22 mm	12 Pt.	Std. SAE Socket	3/8" Dr.
81218	Quick-Release Teardrop Ratchet			3/8" Dr.
82783	1/4" Magnetic Bit Holding Screwdriver			
81241	3" Extension			3/8" Dr.
81242	6" Extension			3/8" Dr.
80402	5/8"	Spark Plug Socket		3/8" Dr.
80403	13/16"	Spark Plug Socket		3/8" Dr.
80760	7/16"	12 Pt.	Std. SAE Socket	1/2" Dr.
80761	1/2"	12 Pt.	Std. SAE Socket	1/2" Dr.
80762	9/16"	12 Pt.	Std. SAE Socket	1/2" Dr.
80763	5/8"	12 Pt.	Std. SAE Socket	1/2" Dr.
80764	11/16"	12 Pt.	Std. SAE Socket	1/2" Dr.
80765	3/4"	12 Pt.	Std. SAE Socket	1/2" Dr.
80766	13/16"	12 Pt.	Std. SAE Socket	1/2" Dr.
80767	7/8"	12 Pt.	Std. SAE Socket	1/2" Dr.
80768	15/16"	12 Pt.	Std. SAE Socket	1/2" Dr.
80769	1"	12 Pt.	Std. SAE Socket	1/2" Dr.
80770	1-1/16"	12 Pt.	Std. SAE Socket	1/2" Dr.

RATCHETS, SOCKETS & DRIVE TOOLS

MULTI-DRIVE SETS

MULTI-DRIVE SETS

80934 - Continued

Material No.	Description		
80771	1-1/8"	12 Pt.	Std. SAE Socket 1/2" Dr.
80793	1-3/16"	12 Pt.	Std. SAE Socket 1/2" Dr.
80794	1-1/4"	12 Pt.	Std. SAE Socket 1/2" Dr.
80680	1-1/2"	12 Pt.	Std. SAE Socket 1/2" Dr.
80750	15 mm	12 Pt.	Std. Metric Socket 1/2" Dr.
80751	16 mm	12 Pt.	Std. Metric Socket 1/2" Dr.
80752	17 mm	12 Pt.	Std. Metric Socket 1/2" Dr.
80753	18 mm	12 Pt.	Std. Metric Socket 1/2" Dr.
80754	19 mm	12 Pt.	Std. Metric Socket 1/2" Dr.
80755	20 mm	12 Pt.	Std. Metric Socket 1/2" Dr.
80756	21 mm	12 Pt.	Std. Metric Socket 1/2" Dr.
80757	22 mm	12 Pt.	Std. Metric Socket 1/2" Dr.
80758	23 mm	12 Pt.	Std. Metric Socket 1/2" Dr.
80759	24 mm	12 Pt.	Std. Metric Socket 1/2" Dr.
80811	25 mm	12 Pt.	Std. Metric Socket 1/2" Dr.
80681	26 mm	12 Pt.	Std. Metric Socket 1/2" Dr.
80812	27 mm	12 Pt.	Std. Metric Socket 1/2" Dr.
81309	Quick-Release Teardrop Ratchet		1/2" Dr.
81340	3" Extension		1/2" Dr.
81341	5" Extension		1/2" Dr.
81650	1/4"	12 Pt.	Non-Ratcheting Combination Wrench
81652	5/16"	12 Pt.	Non-Ratcheting Combination Wrench
81653	11/32"	12 Pt.	Non-Ratcheting Combination Wrench
81654	3/8"	12 Pt.	Non-Ratcheting Combination Wrench
81655	7/16"	12 Pt.	Non-Ratcheting Combination Wrench
81656	1/2"	12 Pt.	Non-Ratcheting Combination Wrench
81657	9/16"	12 Pt.	Non-Ratcheting Combination Wrench
81658	5/8"	12 Pt.	Non-Ratcheting Combination Wrench
81659	11/16"	12 Pt.	Non-Ratcheting Combination Wrench
81660	3/4"	12 Pt.	Non-Ratcheting Combination Wrench
81736	6 mm	12 Pt.	Non-Ratcheting Combination Wrench
81737	7 mm	12 Pt.	Non-Ratcheting Combination Wrench
81665	8 mm	12 Pt.	Non-Ratcheting Combination Wrench
81666	9 mm	12 Pt.	Non-Ratcheting Combination Wrench
81667	10 mm	12 Pt.	Non-Ratcheting Combination Wrench
81668	11 mm	12 Pt.	Non-Ratcheting Combination Wrench
81669	12 mm	12 Pt.	Non-Ratcheting Combination Wrench
81670	13 mm	12 Pt.	Non-Ratcheting Combination Wrench
81671	14 mm	12 Pt.	Non-Ratcheting Combination Wrench
81672	15 mm	12 Pt.	Non-Ratcheting Combination Wrench
81673	16 mm	12 Pt.	Non-Ratcheting Combination Wrench
81674	17 mm	12 Pt.	Non-Ratcheting Combination Wrench

Material No.	Description	
81675	18 mm	12 Pt. Non-Ratcheting Combination Wrench
81676	19 mm	12 Pt. Non-Ratcheting Combination Wrench
56603G	13 Pc. Hex Key	
56606G	9 Pc. Metric Hex Key	
	#1	Bit Phillips
	#2	Bit Phillips
	#3	Bit Phillips
	4mm	Bit Slotted
	5mm	Bit Slotted
	6mm	Bit Slotted
	T40	Bit Torx®
	T45	Bit Torx®
	T50	Bit Torx®
	3/16"	Nut Driver Bit
	1/4"	Nut Driver Bit
	5/16"	Nut Driver Bit
	11/32"	Nut Driver Bit
	3/8"	Nut Driver Bit
	7/16"	Nut Driver Bit
	1/2"	Nut Driver Bit
	5 mm	Nut Driver Bit
	6 mm	Nut Driver Bit
	7 mm	Nut Driver Bit
	8 mm	Nut Driver Bit
	9 mm	Nut Driver Bit
	10 mm	Nut Driver Bit
	11 mm	Nut Driver Bit

MULTI-DRIVE SETS
RATCHETS, SOCKETS & DRIVE TOOLS

MULTI-DRIVE SETS



80933 - 216 Pc. SAE/METRIC 6 & 12 Pt. Mechanics Tool Set MULTI DRIVE

Material No.	Description			
80115	3/16"	6 Pt.	Deep SAE Socket	1/4" Dr.
80116	7/32"	6 Pt.	Deep SAE Socket	1/4" Dr.
80117	1/4"	6 Pt.	Deep SAE Socket	1/4" Dr.
80118	9/32"	6 Pt.	Deep SAE Socket	1/4" Dr.
80119	5/16"	6 Pt.	Deep SAE Socket	1/4" Dr.
80120	11/32"	6 Pt.	Deep SAE Socket	1/4" Dr.
80121	3/8"	6 Pt.	Deep SAE Socket	1/4" Dr.
80122	7/16"	6 Pt.	Deep SAE Socket	1/4" Dr.
80123	1/2"	6 Pt.	Deep SAE Socket	1/4" Dr.
80124	9/16"	6 Pt.	Deep SAE Socket	1/4" Dr.
80138	4 mm	6 Pt.	Deep Metric Socket	1/4" Dr.
80139	5 mm	6 Pt.	Deep Metric Socket	1/4" Dr.
80141	6 mm	6 Pt.	Deep Metric Socket	1/4" Dr.
80142	7 mm	6 Pt.	Deep Metric Socket	1/4" Dr.
80143	8 mm	6 Pt.	Deep Metric Socket	1/4" Dr.
80144	9 mm	6 Pt.	Deep Metric Socket	1/4" Dr.
80145	10 mm	6 Pt.	Deep Metric Socket	1/4" Dr.
80146	11 mm	6 Pt.	Deep Metric Socket	1/4" Dr.
80147	12 mm	6 Pt.	Deep Metric Socket	1/4" Dr.
80148	13 mm	6 Pt.	Deep Metric Socket	1/4" Dr.
80149	14 mm	6 Pt.	Deep Metric Socket	1/4" Dr.
81014			Quick-Release Teardrop Ratchet	1/4" Dr.
81113			3" Extension	1/4" Dr.
81128			Spinner Handle	1/4" Dr.
80480	1/4"		Bit Holder Socket	1/4" Dr.
80350	1/4"	6 Pt.	Std. SAE Socket	3/8" Dr.
80351	5/16"	6 Pt.	Std. SAE Socket	3/8" Dr.
80352	3/8"	6 Pt.	Std. SAE Socket	3/8" Dr.
80353	7/16"	6 Pt.	Std. SAE Socket	3/8" Dr.
80354	1/2"	6 Pt.	Std. SAE Socket	3/8" Dr.
80355	9/16"	6 Pt.	Std. SAE Socket	3/8" Dr.
80356	5/8"	6 Pt.	Std. SAE Socket	3/8" Dr.
80357	11/16"	6 Pt.	Std. SAE Socket	3/8" Dr.
80358	3/4"	6 Pt.	Std. SAE Socket	3/8" Dr.
80359	13/16"	6 Pt.	Std. SAE Socket	3/8" Dr.
80360	7/8"	6 Pt.	Std. SAE Socket	3/8" Dr.
80377	9 mm	6 Pt.	Std. Metric Socket	3/8" Dr.
80378	10 mm	6 Pt.	Std. Metric Socket	3/8" Dr.
80379	11 mm	6 Pt.	Std. Metric Socket	3/8" Dr.

Material No.	Description			
80104	5/32"	6 Pt.	Std. SAE Socket	1/4" Dr.
80105	3/16"	6 Pt.	Std. SAE Socket	1/4" Dr.
80106	7/32"	6 Pt.	Std. SAE Socket	1/4" Dr.
80107	1/4"	6 Pt.	Std. SAE Socket	1/4" Dr.
80108	9/32"	6 Pt.	Std. SAE Socket	1/4" Dr.
80109	5/16"	6 Pt.	Std. SAE Socket	1/4" Dr.
80110	11/32"	6 Pt.	Std. SAE Socket	1/4" Dr.
80111	3/8"	6 Pt.	Std. SAE Socket	1/4" Dr.
80112	7/16"	6 Pt.	Std. SAE Socket	1/4" Dr.
80113	1/2"	6 Pt.	Std. SAE Socket	1/4" Dr.
80114	9/16"	6 Pt.	Std. SAE Socket	1/4" Dr.
80125	4 mm	6 Pt.	Std. Metric Socket	1/4" Dr.
80126	5 mm	6 Pt.	Std. Metric Socket	1/4" Dr.
80127	5.5 mm	6 Pt.	Std. Metric Socket	1/4" Dr.
80128	6 mm	6 Pt.	Std. Metric Socket	1/4" Dr.
80129	7 mm	6 Pt.	Std. Metric Socket	1/4" Dr.
80130	8 mm	6 Pt.	Std. Metric Socket	1/4" Dr.
80131	9 mm	6 Pt.	Std. Metric Socket	1/4" Dr.
80132	10 mm	6 Pt.	Std. Metric Socket	1/4" Dr.
80133	11 mm	6 Pt.	Std. Metric Socket	1/4" Dr.
80134	12 mm	6 Pt.	Std. Metric Socket	1/4" Dr.
80135	13 mm	6 Pt.	Std. Metric Socket	1/4" Dr.
80136	14 mm	6 Pt.	Std. Metric Socket	1/4" Dr.
80137	15 mm	6 Pt.	Std. Metric Socket	1/4" Dr.

RATCHETS, SOCKETS & DRIVE TOOLS

MULTI DRIVE SETS

MULTI-DRIVE SETS

80933 - Continued

Material No.	Description			
80380	12 mm	6 Pt.	Std. Metric Socket	3/8" Dr.
80381	13 mm	6 Pt.	Std. Metric Socket	3/8" Dr.
80382	14 mm	6 Pt.	Std. Metric Socket	3/8" Dr.
80383	15 mm	6 Pt.	Std. Metric Socket	3/8" Dr.
80384	16 mm	6 Pt.	Std. Metric Socket	3/8" Dr.
80385	17 mm	6 Pt.	Std. Metric Socket	3/8" Dr.
80386	18 mm	6 Pt.	Std. Metric Socket	3/8" Dr.
80387	19 mm	6 Pt.	Std. Metric Socket	3/8" Dr.
80330	20 mm	6 Pt.	Std. Metric Socket	3/8" Dr.
80331	21 mm	6 Pt.	Std. Metric Socket	3/8" Dr.
80332	22 mm	6 Pt.	Std. Metric Socket	3/8" Dr.
80365	3/8"	6 Pt.	Deep SAE Socket	3/8" Dr.
80366	1/4"	6 Pt.	Deep SAE Socket	3/8" Dr.
80367	7/16"	6 Pt.	Deep SAE Socket	3/8" Dr.
80368	1/2"	6 Pt.	Deep SAE Socket	3/8" Dr.
80369	9/16"	6 Pt.	Deep SAE Socket	3/8" Dr.
80370	5/8"	6 Pt.	Deep SAE Socket	3/8" Dr.
80371	11/16"	6 Pt.	Deep SAE Socket	3/8" Dr.
80391	9 mm	6 Pt.	Deep Metric Socket	3/8" Dr.
80392	10 mm	6 Pt.	Deep Metric Socket	3/8" Dr.
80393	11 mm	6 Pt.	Deep Metric Socket	3/8" Dr.
80394	12 mm	6 Pt.	Deep Metric Socket	3/8" Dr.
80395	13 mm	6 Pt.	Deep Metric Socket	3/8" Dr.
80396	14 mm	6 Pt.	Deep Metric Socket	3/8" Dr.
80397	15 mm	6 Pt.	Deep Metric Socket	3/8" Dr.
80398	16 mm	6 Pt.	Deep Metric Socket	3/8" Dr.
80399	17 mm	6 Pt.	Deep Metric Socket	3/8" Dr.
80400	18 mm	6 Pt.	Deep Metric Socket	3/8" Dr.
80401	19 mm	6 Pt.	Deep Metric Socket	3/8" Dr.
80496	1/4"	12 Pt.	Std. SAE Socket	3/8" Dr.
80497	5/16"	12 Pt.	Std. SAE Socket	3/8" Dr.
80498	3/8"	12 Pt.	Std. SAE Socket	3/8" Dr.
80499	7/16"	12 Pt.	Std. SAE Socket	3/8" Dr.
80500	1/2"	12 Pt.	Std. SAE Socket	3/8" Dr.
80501	9/16"	12 Pt.	Std. SAE Socket	3/8" Dr.
80502	5/8"	12 Pt.	Std. SAE Socket	3/8" Dr.
80503	11/16"	12 Pt.	Std. SAE Socket	3/8" Dr.
80504	3/4"	12 Pt.	Std. SAE Socket	3/8" Dr.
80505	13/16"	12 Pt.	Std. SAE Socket	3/8" Dr.
80506	7/8"	12 Pt.	Std. SAE Socket	3/8" Dr.

Material No.	Description			
80485	9 mm	12 Pt.	Std. Metric Socket	3/8" Dr.
80486	10 mm	12 Pt.	Std. Metric Socket	3/8" Dr.
80487	11 mm	12 Pt.	Std. Metric Socket	3/8" Dr.
80488	12 mm	12 Pt.	Std. Metric Socket	3/8" Dr.
80489	13 mm	12 Pt.	Std. Metric Socket	3/8" Dr.
80490	14 mm	12 Pt.	Std. Metric Socket	3/8" Dr.
80491	15 mm	12 Pt.	Std. Metric Socket	3/8" Dr.
80492	16 mm	12 Pt.	Std. Metric Socket	3/8" Dr.
80493	17 mm	12 Pt.	Std. Metric Socket	3/8" Dr.
80494	18 mm	12 Pt.	Std. Metric Socket	3/8" Dr.
80495	19 mm	12 Pt.	Std. Metric Socket	3/8" Dr.
80596	20 mm	12 Pt.	Std. SAE Socket	3/8" Dr.
80597	21 mm	12 Pt.	Std. SAE Socket	3/8" Dr.
80598	22 mm	12 Pt.	Std. SAE Socket	3/8" Dr.
81218	Quick-Release Teardrop Ratchet			3/8" Dr.
81241	3" Extension			3/8" Dr.
81242	6" Extension			3/8" Dr.
80402	5/8"	Spark Plug Socket		3/8" Dr.
80403	13/16"	Spark Plug Socket		3/8" Dr.
80760	7/16"	12 Pt.	Std. SAE Socket	1/2" Dr.
80761	1/2"	12 Pt.	Std. SAE Socket	1/2" Dr.
80762	9/16"	12 Pt.	Std. SAE Socket	1/2" Dr.
80763	5/8"	12 Pt.	Std. SAE Socket	1/2" Dr.
80764	11/16"	12 Pt.	Std. SAE Socket	1/2" Dr.
80765	3/4"	12 Pt.	Std. SAE Socket	1/2" Dr.
80766	13/16"	12 Pt.	Std. SAE Socket	1/2" Dr.
80767	7/8"	12 Pt.	Std. SAE Socket	1/2" Dr.
80768	15/16"	12 Pt.	Std. SAE Socket	1/2" Dr.
80769	1"	12 Pt.	Std. SAE Socket	1/2" Dr.
80770	1-1/16"	12 Pt.	Std. SAE Socket	1/2" Dr.
80771	1-1/8"	12 Pt.	Std. SAE Socket	1/2" Dr.
80793	1-3/16"	12 Pt.	Std. SAE Socket	1/2" Dr.
80794	1-1/4"	12 Pt.	Std. SAE Socket	1/2" Dr.
80680	1-1/2"	12 Pt.	Std. SAE Socket	1/2" Dr.
80750	15 mm	12 Pt.	Std. Metric Socket	1/2" Dr.
80751	16 mm	12 Pt.	Std. Metric Socket	1/2" Dr.
80752	17 mm	12 Pt.	Std. Metric Socket	1/2" Dr.
80753	18 mm	12 Pt.	Std. Metric Socket	1/2" Dr.
80754	19 mm	12 Pt.	Std. Metric Socket	1/2" Dr.
80756	21 mm	12 Pt.	Std. Metric Socket	1/2" Dr.

MULTI-DRIVE SETS
RATCHETS, SOCKETS & DRIVE TOOLS

MULTI-DRIVE SETS

80933 - Continued

Material No.	Description		
80757	22 mm	12 Pt.	Std. Metric Socket 1/2" Dr.
80759	24 mm	12 Pt.	Std. Metric Socket 1/2" Dr.
80811	25 mm	12 Pt.	Std. Metric Socket 1/2" Dr.
80812	27 mm	12 Pt.	Std. Metric Socket 1/2" Dr.
80682	28 mm	13 Pt.	Std. Metric Socket 1/2" Dr.
80813	30 mm	12 Pt.	Std. Metric Socket 1/2" Dr.
80814	32 mm	12 Pt.	Std. Metric Socket 1/2" Dr.
81309	Quick-Release Teardrop Ratchet		1/2" Dr.
81340	3" Extension		
81650	1/4"	12 Pt.	Non-Ratcheting Combination Wrench
81652	5/16"	12 Pt.	Non-Ratcheting Combination Wrench
81653	11/32"	12 Pt.	Non-Ratcheting Combination Wrench
81654	3/8"	12 Pt.	Non-Ratcheting Combination Wrench
81655	7/16"	12 Pt.	Non-Ratcheting Combination Wrench
81656	1/2"	12 Pt.	Non-Ratcheting Combination Wrench
81657	9/16"	12 Pt.	Non-Ratcheting Combination Wrench
81658	5/8"	12 Pt.	Non-Ratcheting Combination Wrench
81659	11/16"	12 Pt.	Non-Ratcheting Combination Wrench
81660	3/4"	12 Pt.	Non-Ratcheting Combination Wrench
81737	7 mm	12 Pt.	Non-Ratcheting Combination Wrench
81665	8 mm	12 Pt.	Non-Ratcheting Combination Wrench
81666	9 mm	12 Pt.	Non-Ratcheting Combination Wrench
81667	10 mm	12 Pt.	Non-Ratcheting Combination Wrench
81668	11 mm	12 Pt.	Non-Ratcheting Combination Wrench
81669	12 mm	12 Pt.	Non-Ratcheting Combination Wrench
81670	13 mm	12 Pt.	Non-Ratcheting Combination Wrench
81671	14 mm	12 Pt.	Non-Ratcheting Combination Wrench
81672	15 mm	12 Pt.	Non-Ratcheting Combination Wrench
56603G	13 Pc. SAE Hex Key		
56606G	9 Pc. Metric Hex Key		
	#1	Bit Phillips	
	#2	Bit Phillips	
	#3	Bit Phillips	
	4 mm	Bit Slotted	
	5 mm	Bit Slotted	
	6 mm	Bit Slotted	
	T40	Bit Torx®	
	T45	Bit Torx®	
	T50	Bit Torx®	
	3/16"	Nut Driver Bit	

Material No.	Description	
	1/4"	Nut Driver Bit
	5/16"	Nut Driver Bit
	11/32"	Nut Driver Bit
	3/8"	Nut Driver Bit
	7/16"	Nut Driver Bit
	1/2"	Nut Driver Bit
	5 mm	Nut Driver Bit
	6 mm	Nut Driver Bit
	7 mm	Nut Driver Bit
	8 mm	Nut Driver Bit
	9 mm	Nut Driver Bit
	10 mm	Nut Driver Bit
	11 mm	Nut Driver Bit

MULTI-DRIVE SETS

RATCHETS, SOCKETS & DRIVE TOOLS

MULTI-DRIVE SETS

80932 - 165 Pc. SAE/METRIC 6 & 12 Pt. Mechanics Tool Set MULTI DRIVE

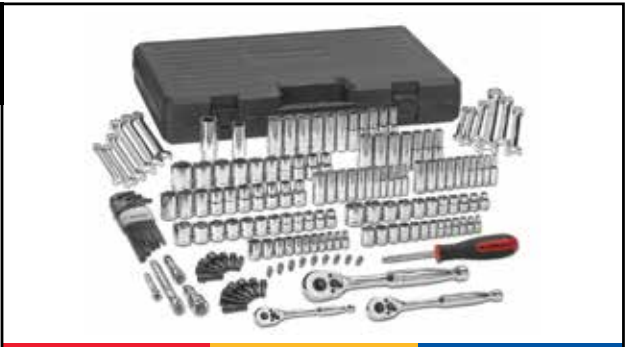

1/4" DRIVE 3/8" DRIVE 1/2" DRIVE

Material No.	Description	
80104	5/32"	6 Pt. Std. SAE Socket 1/4" Dr.
80105	3/16"	6 Pt. Std. SAE Socket 1/4" Dr.
80106	7/32"	6 Pt. Std. SAE Socket 1/4" Dr.
80107	1/4"	6 Pt. Std. SAE Socket 1/4" Dr.
80108	9/32"	6 Pt. Std. SAE Socket 1/4" Dr.
80109	5/16"	6 Pt. Std. SAE Socket 1/4" Dr.
80110	11/32"	6 Pt. Std. SAE Socket 1/4" Dr.
80111	3/8"	6 Pt. Std. SAE Socket 1/4" Dr.
80112	7/16"	6 Pt. Std. SAE Socket 1/4" Dr.
80113	1/2"	6 Pt. Std. SAE Socket 1/4" Dr.
80114	9/16"	6 Pt. Std. SAE Socket 1/4" Dr.
80125	4 mm	6 Pt. Std. Metric Socket 1/4" Dr.
80126	5 mm	6 Pt. Std. Metric Socket 1/4" Dr.
80127	5.5 mm	6 Pt. Std. Metric Socket 1/4" Dr.
80128	6 mm	6 Pt. Std. Metric Socket 1/4" Dr.
80129	7 mm	6 Pt. Std. Metric Socket 1/4" Dr.
80130	8 mm	6 Pt. Std. Metric Socket 1/4" Dr.
80131	9 mm	6 Pt. Std. Metric Socket 1/4" Dr.
80132	10 mm	6 Pt. Std. Metric Socket 1/4" Dr.
80133	11 mm	6 Pt. Std. Metric Socket 1/4" Dr.
80134	12 mm	6 Pt. Std. Metric Socket 1/4" Dr.
80135	13 mm	6 Pt. Std. Metric Socket 1/4" Dr.
80136	14 mm	6 Pt. Std. Metric Socket 1/4" Dr.
80137	15 mm	6 Pt. Std. Metric Socket 1/4" Dr.
80115	3/16"	6 Pt. Deep SAE Socket 1/4" Dr.
80116	7/32"	6 Pt. Deep SAE Socket 1/4" Dr.
80117	1/4"	6 Pt. Deep SAE Socket 1/4" Dr.
80118	9/32"	6 Pt. Deep SAE Socket 1/4" Dr.
80119	5/16"	6 Pt. Deep SAE Socket 1/4" Dr.
80120	11/32"	6 Pt. Deep SAE Socket 1/4" Dr.
80121	3/8"	6 Pt. Deep SAE Socket 1/4" Dr.
80122	7/16"	6 Pt. Deep SAE Socket 1/4" Dr.
80123	1/2"	6 Pt. Deep SAE Socket 1/4" Dr.
80124	9/16"	6 Pt. Deep SAE Socket 1/4" Dr.
80138	4 mm	6 Pt. Deep Metric Socket 1/4" Dr.
80139	5 mm	6 Pt. Deep Metric Socket 1/4" Dr.
80141	6 mm	6 Pt. Deep Metric Socket 1/4" Dr.
80142	7 mm	6 Pt. Deep Metric Socket 1/4" Dr.
80143	8 mm	6 Pt. Deep Metric Socket 1/4" Dr.
80144	9 mm	6 Pt. Deep Metric Socket 1/4" Dr.

Material No.	Description	
80145	10 mm	6 Pt. Deep Metric Socket 1/4" Dr.
80146	11 mm	6 Pt. Deep Metric Socket 1/4" Dr.
80147	12 mm	6 Pt. Deep Metric Socket 1/4" Dr.
80148	13 mm	6 Pt. Deep Metric Socket 1/4" Dr.
80149	14 mm	6 Pt. Deep Metric Socket 1/4" Dr.
81014	Quick-Release Teardrop Ratchet 1/4" Dr.	
81113	3" Extension 1/4" Dr.	
80480	1/4" Bit Holder Socket 1/4" Dr.	
81128	Spinner Handle 1/4" Dr.	
80350	1/4"	6 Pt. Std. SAE Socket 3/8" Dr.
80351	5/16"	6 Pt. Std. SAE Socket 3/8" Dr.
80352	3/8"	6 Pt. Std. SAE Socket 3/8" Dr.
80353	7/16"	6 Pt. Std. SAE Socket 3/8" Dr.
80354	1/2"	6 Pt. Std. SAE Socket 3/8" Dr.
80355	9/16"	6 Pt. Std. SAE Socket 3/8" Dr.
80356	5/8"	6 Pt. Std. SAE Socket 3/8" Dr.
80357	11/16"	6 Pt. Std. SAE Socket 3/8" Dr.
80358	3/4"	6 Pt. Std. SAE Socket 3/8" Dr.
80359	13/16"	6 Pt. Std. SAE Socket 3/8" Dr.
80360	7/8"	6 Pt. Std. SAE Socket 3/8" Dr.
80377	9 mm	6 Pt. Std. Metric Socket 3/8" Dr.
80378	10 mm	6 Pt. Std. Metric Socket 3/8" Dr.
80379	11 mm	6 Pt. Std. Metric Socket 3/8" Dr.
80380	12 mm	6 Pt. Std. Metric Socket 3/8" Dr.
80381	13 mm	6 Pt. Std. Metric Socket 3/8" Dr.
80382	14 mm	6 Pt. Std. Metric Socket 3/8" Dr.
80383	15 mm	6 Pt. Std. Metric Socket 3/8" Dr.
80384	16 mm	6 Pt. Std. Metric Socket 3/8" Dr.
80385	17 mm	6 Pt. Std. Metric Socket 3/8" Dr.
80386	18 mm	6 Pt. Std. Metric Socket 3/8" Dr.
80387	19 mm	6 Pt. Std. Metric Socket 3/8" Dr.
80330	20 mm	6 Pt. Std. Metric Socket 3/8" Dr.

MULTI-DRIVE SETS
RATCHETS, SOCKETS & DRIVE TOOLS

MULTI-DRIVE SETS

80932 - Continued

Material No.	Description		
80365	3/8"	6 Pt.	Deep SAE Socket 3/8" Dr.
80366	1/4"	6 Pt.	Deep SAE Socket 3/8" Dr.
80367	7/16"	6 Pt.	Deep SAE Socket 3/8" Dr.
80368	1/2"	6 Pt.	Deep SAE Socket 3/8" Dr.
80369	9/16"	6 Pt.	Deep SAE Socket 3/8" Dr.
80370	5/8"	6 Pt.	Deep SAE Socket 3/8" Dr.
80371	11/16"	6 Pt.	Deep SAE Socket 3/8" Dr.
80391	9 mm	6 Pt.	Deep Metric Socket 3/8" Dr.
80392	10 mm	6 Pt.	Deep Metric Socket 3/8" Dr.
80393	11 mm	6 Pt.	Deep Metric Socket 3/8" Dr.
80394	12 mm	6 Pt.	Deep Metric Socket 3/8" Dr.
80395	13 mm	6 Pt.	Deep Metric Socket 3/8" Dr.
80396	14 mm	6 Pt.	Deep Metric Socket 3/8" Dr.
80397	15 mm	6 Pt.	Deep Metric Socket 3/8" Dr.
80398	16 mm	6 Pt.	Deep Metric Socket 3/8" Dr.
80399	17 mm	6 Pt.	Deep Metric Socket 3/8" Dr.
80400	18 mm	6 Pt.	Deep Metric Socket 3/8" Dr.
80401	19 mm	6 Pt.	Deep Metric Socket 3/8" Dr.
81218	Quick-Release Teardrop Ratchet		3/8" Dr.
81241	3" Extension		3/8" Dr.
81242	6" Extension		3/8" Dr.
80402	5/8"	Spark Plug Socket	3/8" Dr.
80403	13/16"	Spark Plug Socket	3/8" Dr.
80602	7/16"	6 Pt. Std. SAE Socket	1/2" Dr.
80603	1/2"	6 Pt. Std. SAE Socket	1/2" Dr.
80604	9/16"	6 Pt. Std. SAE Socket	1/2" Dr.
80605	5/8"	6 Pt. Std. SAE Socket	1/2" Dr.
80606	11/16"	6 Pt. Std. SAE Socket	1/2" Dr.
80607	3/4"	6 Pt. Std. SAE Socket	1/2" Dr.
80608	13/16"	6 Pt. Std. SAE Socket	1/2" Dr.
80609	7/8"	6 Pt. Std. SAE Socket	1/2" Dr.
80610	15/16"	6 Pt. Std. SAE Socket	1/2" Dr.
80611	1"	6 Pt. Std. SAE Socket	1/2" Dr.
80622	10 mm	6 Pt. Std. Metric Socket	1/2" Dr.
80623	11 mm	6 Pt. Std. Metric Socket	1/2" Dr.
80624	12 mm	6 Pt. Std. Metric Socket	1/2" Dr.
80625	13 mm	6 Pt. Std. Metric Socket	1/2" Dr.
80626	14 mm	6 Pt. Std. Metric Socket	1/2" Dr.
80627	15 mm	6 Pt. Std. Metric Socket	1/2" Dr.
80628	16 mm	6 Pt. Std. Metric Socket	1/2" Dr.
80629	17 mm	6 Pt. Std. Metric Socket	1/2" Dr.

Material No.	Description		
80630	18 mm	6 Pt. Std. Metric Socket	1/2" Dr.
80631	19 mm	6 Pt. Std. Metric Socket	1/2" Dr.
81309	Quick-Release Teardrop Ratchet		1/2" Dr.
81340	3" Extension		1/2" Dr.
81652	5/16"	12 Pt. Non-Ratcheting Combination Wrench	
81654	3/8"	12 Pt. Non-Ratcheting Combination Wrench	
81655	7/16"	12 Pt. Non-Ratcheting Combination Wrench	
81656	1/2"	12 Pt. Non-Ratcheting Combination Wrench	
81657	9/16"	12 Pt. Non-Ratcheting Combination Wrench	
81660	3/4"	12 Pt. Non-Ratcheting Combination Wrench	
81666	9 mm	12 Pt. Non-Ratcheting Combination Wrench	
81667	10 mm	12 Pt. Non-Ratcheting Combination Wrench	
81669	12 mm	12 Pt. Non-Ratcheting Combination Wrench	
81670	13 mm	12 Pt. Non-Ratcheting Combination Wrench	
81671	14 mm	12 Pt. Non-Ratcheting Combination Wrench	
81672	15 mm	12 Pt. Non-Ratcheting Combination Wrench	
56603G	13 Pc SAE Hex Key		
	#1	Bit Phillips	
	#2	Bit Phillips	
	#3	Bit Phillips	
	4mm	Bit Slotted	
	5mm	Bit Slotted	
	6mm	Bit Slotted	
	T40	Bit Torx®	
	T45	Bit Torx®	
	T50	Bit Torx®	
	3/16"	Nut Driver Bit	
	1/4"	Nut Driver Bit	
	5/16"	Nut Driver Bit	
	11/32"	Nut Driver Bit	
	3/8"	Nut Driver Bit	
	7/16"	Nut Driver Bit	
	1/2"	Nut Driver Bit	
	5 mm	Nut Driver Bit	
	6 mm	Nut Driver Bit	
	7 mm	Nut Driver Bit	
	8 mm	Nut Driver Bit	
	9 mm	Nut Driver Bit	
	10 mm	Nut Driver Bit	
	11 mm	Nut Driver Bit	

MULTI DRIVE SETS
RATCHETS, SOCKETS & DRIVE TOOLS

MULTI-DRIVE SETS

80931 - 141 Pc. SAE/METRIC 6 & 12 Pt. Mechanics Tool Set MULTI DRIVE



1/4" DRIVE 3/8" DRIVE 1/2" DRIVE

Material No.	Description			
80104	5/32"	6 Pt.	Std. SAE Socket	1/4" Dr.
80105	3/16"	6 Pt.	Std. SAE Socket	1/4" Dr.
80106	7/32"	6 Pt.	Std. SAE Socket	1/4" Dr.
80107	1/4"	6 Pt.	Std. SAE Socket	1/4" Dr.
80108	9/32"	6 Pt.	Std. SAE Socket	1/4" Dr.
80109	5/16"	6 Pt.	Std. SAE Socket	1/4" Dr.
80110	11/32"	6 Pt.	Std. SAE Socket	1/4" Dr.
80111	3/8"	6 Pt.	Std. SAE Socket	1/4" Dr.
80112	7/16"	6 Pt.	Std. SAE Socket	1/4" Dr.
80113	1/2"	6 Pt.	Std. SAE Socket	1/4" Dr.
80125	4 mm	6 Pt.	Std. Metric Socket	1/4" Dr.
80126	5 mm	6 Pt.	Std. Metric Socket	1/4" Dr.
80127	5.5 mm	6 Pt.	Std. Metric Socket	1/4" Dr.
80128	6 mm	6 Pt.	Std. Metric Socket	1/4" Dr.
80129	7 mm	6 Pt.	Std. Metric Socket	1/4" Dr.
80130	8 mm	6 Pt.	Std. Metric Socket	1/4" Dr.
80131	9 mm	6 Pt.	Std. Metric Socket	1/4" Dr.
80132	10 mm	6 Pt.	Std. Metric Socket	1/4" Dr.
80133	11 mm	6 Pt.	Std. Metric Socket	1/4" Dr.
80134	12 mm	6 Pt.	Std. Metric Socket	1/4" Dr.
80135	13 mm	6 Pt.	Std. Metric Socket	1/4" Dr.
80117	1/4"	6 Pt.	Deep SAE Socket	1/4" Dr.
80118	9/32"	6 Pt.	Deep SAE Socket	1/4" Dr.
80119	5/16"	6 Pt.	Deep SAE Socket	1/4" Dr.
80120	11/32"	6 Pt.	Deep SAE Socket	1/4" Dr.
80121	3/8"	6 Pt.	Deep SAE Socket	1/4" Dr.
80122	7/16"	6 Pt.	Deep SAE Socket	1/4" Dr.
80123	1/2"	6 Pt.	Deep SAE Socket	1/4" Dr.
80142	7 mm	6 Pt.	Deep Metric Socket	1/4" Dr.
80143	8 mm	6 Pt.	Deep Metric Socket	1/4" Dr.
80144	9 mm	6 Pt.	Deep Metric Socket	1/4" Dr.
80145	10 mm	6 Pt.	Deep Metric Socket	1/4" Dr.
80146	11 mm	6 Pt.	Deep Metric Socket	1/4" Dr.
80147	12 mm	6 Pt.	Deep Metric Socket	1/4" Dr.
80148	13 mm	6 Pt.	Deep Metric Socket	1/4" Dr.
81014	Quick-Release Teardrop Ratchet			1/4" Dr.
81113	3" Extension			1/4" Dr.

Material No.	Description			
80480	1/4"		Bit Holder Socket	1/4" Dr.
80352	3/8"	6 Pt.	Std. SAE Socket	3/8" Dr.
80353	7/16"	6 Pt.	Std. SAE Socket	3/8" Dr.
80354	1/2"	6 Pt.	Std. SAE Socket	3/8" Dr.
80355	9/16"	6 Pt.	Std. SAE Socket	3/8" Dr.
80356	5/8"	6 Pt.	Std. SAE Socket	3/8" Dr.
80357	11/16"	6 Pt.	Std. SAE Socket	3/8" Dr.
80358	3/4"	6 Pt.	Std. SAE Socket	3/8" Dr.
80378	10 mm	6 Pt.	Std. Metric Socket	3/8" Dr.
80379	11 mm	6 Pt.	Std. Metric Socket	3/8" Dr.
80380	12 mm	6 Pt.	Std. Metric Socket	3/8" Dr.
80381	13 mm	6 Pt.	Std. Metric Socket	3/8" Dr.
80382	14 mm	6 Pt.	Std. Metric Socket	3/8" Dr.
80383	15 mm	6 Pt.	Std. Metric Socket	3/8" Dr.
80384	16 mm	6 Pt.	Std. Metric Socket	3/8" Dr.
80385	17 mm	6 Pt.	Std. Metric Socket	3/8" Dr.
80386	18 mm	6 Pt.	Std. Metric Socket	3/8" Dr.
80387	19 mm	6 Pt.	Std. Metric Socket	3/8" Dr.
80365	3/8"	6 Pt.	Deep SAE Socket	3/8" Dr.
80366	1/4"	6 Pt.	Deep SAE Socket	3/8" Dr.
80367	7/16"	6 Pt.	Deep SAE Socket	3/8" Dr.
80368	1/2"	6 Pt.	Deep SAE Socket	3/8" Dr.
80369	9/16"	6 Pt.	Deep SAE Socket	3/8" Dr.
80370	5/8"	6 Pt.	Deep SAE Socket	3/8" Dr.
80371	11/16"	6 Pt.	Deep SAE Socket	3/8" Dr.

MULTI-DRIVE SETS
RATCHETS, SOCKETS & DRIVE TOOLS

MULTI-DRIVE SETS

80931 - Continued

Material No.	Description		
80392	10 mm	6 Pt.	Deep Metric Socket 3/8" Dr.
80393	11 mm	6 Pt.	Deep Metric Socket 3/8" Dr.
80394	12 mm	6 Pt.	Deep Metric Socket 3/8" Dr.
80395	13 mm	6 Pt.	Deep Metric Socket 3/8" Dr.
80396	14 mm	6 Pt.	Deep Metric Socket 3/8" Dr.
80397	15 mm	6 Pt.	Deep Metric Socket 3/8" Dr.
80398	16 mm	6 Pt.	Deep Metric Socket 3/8" Dr.
80399	17 mm	6 Pt.	Deep Metric Socket 3/8" Dr.
80400	18 mm	6 Pt.	Deep Metric Socket 3/8" Dr.
80401	19 mm	6 Pt.	Deep Metric Socket 3/8" Dr.
80498	3/8"	12 Pt.	Std. SAE Socket 3/8" Dr.
80499	7/16"	12 Pt.	Std. SAE Socket 3/8" Dr.
80500	1/2"	12 Pt.	Std. SAE Socket 3/8" Dr.
80501	9/16"	12 Pt.	Std. SAE Socket 3/8" Dr.
80502	5/8"	12 Pt.	Std. SAE Socket 3/8" Dr.
80503	11/16"	12 Pt.	Std. SAE Socket 3/8" Dr.
80504	3/4"	12 Pt.	Std. SAE Socket 3/8" Dr.
80489	13 mm	12 Pt.	Std. Metric Socket 3/8" Dr.
80490	14 mm	12 Pt.	Std. Metric Socket 3/8" Dr.
80491	15 mm	12 Pt.	Std. Metric Socket 3/8" Dr.
80492	16 mm	12 Pt.	Std. Metric Socket 3/8" Dr.
80493	17 mm	12 Pt.	Std. Metric Socket 3/8" Dr.
80494	18 mm	12 Pt.	Std. Metric Socket 3/8" Dr.
80495	19 mm	12 Pt.	Std. Metric Socket 3/8" Dr.
81218	Quick-Release Teardrop Ratchet		3/8" Dr.
81242	6" Extension		3/8" Dr.
80402	5/8"	Spark Plug Socket	3/8" Dr.
80764	11/16"	12 Pt. Std. SAE Socket	1/2" Dr.
80765	3/4"	12 Pt. Std. SAE Socket	1/2" Dr.
80766	13/16"	12 Pt. Std. SAE Socket	1/2" Dr.
80767	7/8"	12 Pt. Std. SAE Socket	1/2" Dr.
80768	15/16"	12 Pt. Std. SAE Socket	1/2" Dr.
80769	1"	12 Pt. Std. SAE Socket	1/2" Dr.
80750	15 mm	12 Pt. Std. Metric Socket	1/2" Dr.
80751	16 mm	12 Pt. Std. Metric Socket	1/2" Dr.
80752	17 mm	12 Pt. Std. Metric Socket	1/2" Dr.
80753	18 mm	12 Pt. Std. Metric Socket	1/2" Dr.
80754	19 mm	12 Pt. Std. Metric Socket	1/2" Dr.
80756	21 mm	12 Pt. Std. Metric Socket	1/2" Dr.
81309	1/2" Quick Release Teardrop Ratchet		

Material No.	Description	
81340	3" Extension	1/2" Dr.
81794	10x12mm	Double Open End Wrench
81796	12x14mm	Double Open End Wrench
81799	3/8"x7/16"	Double Open End Wrench
81801	1/2"x9/16"	Double Open End Wrench
56603G	13 Pc. SAE Hex Key Set	
	#1	Bit Phillips
	#2	Bit Phillips
	#3	Bit Phillips
	4mm	Bit Slotted
	5mm	Bit Slotted
	6mm	Bit Slotted
	T40	Bit Torx®
	T45	Bit Torx®
	T50	Bit Torx®
	3/16"	Nut Driver Bit
	1/4"	Nut Driver Bit
	5/16"	Nut Driver Bit
	11/32"	Nut Driver Bit
	3/8"	Nut Driver Bit
	7/16"	Nut Driver Bit
	1/2"	Nut Driver Bit
	5 mm	Nut Driver Bit
	6 mm	Nut Driver Bit
	7 mm	Nut Driver Bit
	8 mm	Nut Driver Bit
	9 mm	Nut Driver Bit
	10 mm	Nut Driver Bit
	11 mm	Nut Driver Bit

RATCHETS, SOCKETS & DRIVE TOOLS

MULTI DRIVE SETS

MULTI-DRIVE SETS

83001D - 118 Pc. SAE/METRIC 6 & 12 Pt. Standard Socket Set MULTI DRIVE

Material No.	Description			
80105	3/16"	6 Pt.	Std. SAE Socket	1/4" Dr.
80106	7/32"	6 Pt.	Std. SAE Socket	1/4" Dr.
80107	1/4"	6 Pt.	Std. SAE Socket	1/4" Dr.
80108	9/32"	6 Pt.	Std. SAE Socket	1/4" Dr.
80109	5/16"	6 Pt.	Std. SAE Socket	1/4" Dr.
80110	11/32"	6 Pt.	Std. SAE Socket	1/4" Dr.
80111	3/8"	6 Pt.	Std. SAE Socket	1/4" Dr.
80112	7/16"	6 Pt.	Std. SAE Socket	1/4" Dr.
80113	1/2"	6 Pt.	Std. SAE Socket	1/4" Dr.
80114	9/16"	6 Pt.	Std. SAE Socket	1/4" Dr.
80117	1/4"	6 Pt.	Deep SAE Socket	1/4" Dr.
80118	9/32"	6 Pt.	Deep SAE Socket	1/4" Dr.
80119	5/16"	6 Pt.	Deep SAE Socket	1/4" Dr.
80120	11/32"	6 Pt.	Deep SAE Socket	1/4" Dr.
80121	3/8"	6 Pt.	Deep SAE Socket	1/4" Dr.
80122	7/16"	6 Pt.	Deep SAE Socket	1/4" Dr.
80123	1/2"	6 Pt.	Deep SAE Socket	1/4" Dr.
80125	4 mm	6 Pt.	Torx® Tamper-Proof Bit Socket	1/4" Dr.
80126	5 mm	6 Pt.	Std. Metric Socket	1/4" Dr.
80128	6 mm	6 Pt.	Std. Metric Socket	1/4" Dr.
80129	7 mm	6 Pt.	Std. Metric Socket	1/4" Dr.
80130	8 mm	6 Pt.	Std. SAE Socket	1/4" Dr.
80131	9 mm	6 Pt.	Std. Metric Socket	1/4" Dr.
80132	10 mm	6 Pt.	Std. Metric Socket	1/4" Dr.
80133	11 mm	6 Pt.	Std. Metric Socket	1/4" Dr.
80134	12 mm	6 Pt.	Std. Metric Socket	1/4" Dr.
80135	13 mm	6 Pt.	Std. Metric Socket	1/4" Dr.
80142	7 mm	6 Pt.	Deep Metric Socket	1/4" Dr.
80143	8 mm	6 Pt.	Deep Metric Socket	1/4" Dr.
80144	9 mm	6 Pt.	Deep SAE Socket	1/4" Dr.
80145	10 mm	6 Pt.	Deep Metric Socket	1/4" Dr.
80146	11 mm	6 Pt.	Deep Metric Socket	1/4" Dr.
80147	12 mm	6 Pt.	Deep Metric Socket	1/4" Dr.
80148	13 mm	6 Pt.	Deep Metric Socket	1/4" Dr.
80377	9 mm	6 Pt.	Std. Metric Socket	3/8" Dr.
80378	10 mm	6 Pt.	Std. Metric Socket	3/8" Dr.
80379	11 mm	6 Pt.	Std. Metric Socket	3/8" Dr.



Material No.	Description			
80380	12 mm	6 Pt.	Std. Metric Socket	3/8" Dr.
80381	13 mm	6 Pt.	Std. Metric Socket	3/8" Dr.
80382	14 mm	6 Pt.	Std. Metric Socket	3/8" Dr.
80383	15 mm	6 Pt.	Std. Metric Socket	3/8" Dr.
80385	17 mm	6 Pt.	Std. Metric Socket	3/8" Dr.
80387	19 mm	6 Pt.	Std. Metric Socket	3/8" Dr.
80392	10 mm	6 Pt.	Deep Metric Socket	3/8" Dr.
80394	12 mm	6 Pt.	Deep Metric Socket	3/8" Dr.
80395	13 mm	6 Pt.	Deep Metric Socket	3/8" Dr.
80396	14 mm	6 Pt.	Deep Metric Socket	3/8" Dr.
80397	15 mm	6 Pt.	Deep SAE Socket	3/8" Dr.
80398	16 mm	6 Pt.	Deep Metric Socket	3/8" Dr.
80399	17 mm	6 Pt.	Deep Metric Socket	3/8" Dr.
80210	3/16"	12 Pt.	Std. SAE Socket	1/4" Dr.
80211	7/32"	12 Pt.	Std. SAE Socket	1/4" Dr.
80212	1/4"	12 Pt.	Std. SAE Socket	1/4" Dr.
80213	9/32"	12 Pt.	Std. SAE Socket	1/4" Dr.
80214	5/16"	12 Pt.	Std. SAE Socket	1/4" Dr.
80215	11/32"	12 Pt.	Std. SAE Socket	1/4" Dr.
80216	3/8"	12 Pt.	Std. SAE Socket	1/4" Dr.
80217	7/16"	12 Pt.	Std. SAE Socket	1/4" Dr.
80218	1/2"	12 Pt.	Std. SAE Socket	1/4" Dr.
80485	9 mm	12 Pt.	Std. Metric Socket	3/8" Dr.
80486	10 mm	12 Pt.	Std. Metric Socket	3/8" Dr.

MULTI-DRIVE SETS
RATCHETS, SOCKETS & DRIVE TOOLS

MULTI-DRIVE SETS

83001D - Continued

Material No.	Description			
80487	11 mm	12 Pt.	Std. Metric Socket	3/8" Dr.
80488	12 mm	12 Pt.	Std. Metric Socket	3/8" Dr.
80489	13 mm	12 Pt.	Std. Metric Socket	3/8" Dr.
80490	14 mm	12 Pt.	Std. Metric Socket	3/8" Dr.
80491	15 mm	12 Pt.	Std. Metric Socket	3/8" Dr.
80492	16 mm	12 Pt.	Std. Metric Socket	3/8" Dr.
80493	17 mm	12 Pt.	Std. Metric Socket	3/8" Dr.
80494	18 mm	12 Pt.	Std. Metric Socket	3/8" Dr.
80495	19 mm	12 Pt.	Std. Metric Socket	3/8" Dr.
80498	3/8"	12 Pt.	Std. SAE Socket	3/8" Dr.
80499	7/16"	12 Pt.	Std. SAE Socket	1/4" Dr.
80500	1/2"	12 Pt.	Std. SAE Socket	3/8" Dr.
80501	9/16"	12 Pt.	Std. SAE Socket	3/8" Dr.
80502	5/8"	12 Pt.	Std. SAE Socket	3/8" Dr.
80503	11/16"	12 Pt.	Std. SAE Socket	3/8" Dr.
80504	3/4"	12 Pt.	Std. SAE Socket	3/8" Dr.
80505	13/16"	12 Pt.	Std. SAE Socket	3/8" Dr.
80510	5/16"	12 Pt.	Deep SAE Socket	3/8" Dr.
80511	3/8"	12 Pt.	Deep SAE Socket	3/8" Dr.
80512	1/4"	12 Pt.	Deep SAE Socket	3/8" Dr.
80513	7/16"	12 Pt.	Std. SAE Socket	3/8" Dr.
80514	1/2"	12 Pt.	Deep SAE Socket	3/8" Dr.
80515	9/16"	12 Pt.	Deep SAE Socket	3/8" Dr.
80516	5/8"	12 Pt.	Deep SAE Socket	3/8" Dr.
80772	7/16"	12 Pt.	Deep SAE Socket	1/4" Dr.
80773	1/2"	12 Pt.	Deep SAE Socket	1/4" Dr.
80774	9/16"	12 Pt.	Deep SAE Socket	1/2" Dr.
80775	5/8"	12 Pt.	Deep SAE Socket	1/4" Dr.
80776	11/16"	12 Pt.	Deep SAE Socket	1/4" Dr.
80777	3/4"	6 Pt.	Deep SAE Socket	1/4" Dr.
80778	13/16"	12 Pt.	Deep SAE Socket	1/2" Dr.
80402	5/8" Spark Plug Socket			3/8" Dr.
80178	T-7		Torx® Tamper-Proof Bit Socket	1/4" Dr.
80179	T-8		Torx® Tamper-Proof Bit Socket	1/4" Dr.
80180	T-10		Torx® Tamper-Proof Bit Socket	1/4" Dr.
80181	T-15		Torx® Tamper-Proof Bit Socket	1/4" Dr.
80182	T-20		Torx® Tamper-Proof Bit Socket	1/4" Dr.
80471	T-10		Torx® Tamper-Proof Bit Socket	3/8" Dr.
80472	1/4"		Std. SAE Socket	1/4" Dr.
80473	1/4"		Bit Holder Socket	1/4" Dr.

Material No.	Description			
80474	1/4"		Bit Holder Socket	1/4" Dr.
80475	1/4"		Bit Holder Socket	1/4" Dr.
80476	1/4"		Bit Holder Socket	1/4" Dr.
80480	1/4"		Bit Holder Socket	1/4" Dr.
81655	7/16"		Non-Ratcheting Combination Wrench	
81656	1/2"		Non-Ratcheting Combination Wrench	
81657	9/16"		Non-Ratcheting Combination Wrench	
81675	18 mm		Non-Ratcheting Combination Wrench	
81676	19 mm		Non-Ratcheting Combination Wrench	
81119	2" Wobble Socket			1/4" Dr.
81345	5" Wobble Socket			1/2" Dr.
81241	3" Extension Socket			3/8" Dr.
81242	6" Extension			3/8" Dr.
81128	Spinner Handle			1/4" Dr.
81011	Full Polish Teardrop Ratchet			1/4" Dr.
81211	Full Polish Teardrop Ratchet			3/8" Dr.
81304	Full Polish Teardrop Ratchet			1/4" Dr.
83001BM	Replacement Blow Mold Case			

RATCHETS, SOCKETS & DRIVE TOOLS

MULTI-DRIVE SETS

MULTI-DRIVE SETS

80930 - 88 Pc. SAE/METRIC 6 & 12 Pt. Mechanics Tool Set MULTI DRIVE



Material No.	Description			
80104	5/32"	6 Pt.	Std. SAE Socket	1/4" Dr.
80105	3/16"	6 Pt.	Std. SAE Socket	1/4" Dr.
80106	7/32"	6 Pt.	Std. SAE Socket	1/4" Dr.
80107	1/4"	6 Pt.	Std. SAE Socket	1/4" Dr.
80108	9/32"	6 Pt.	Std. SAE Socket	1/4" Dr.
80109	5/16"	6 Pt.	Std. SAE Socket	1/4" Dr.
80110	11/32"	6 Pt.	Std. SAE Socket	1/4" Dr.
80111	3/8"	6 Pt.	Std. SAE Socket	1/4" Dr.
80112	7/16"	6 Pt.	Std. SAE Socket	1/4" Dr.
80113	1/2"	6 Pt.	Std. SAE Socket	1/4" Dr.
80114	9/16"	6 Pt.	Std. SAE Socket	1/4" Dr.
80125	4 mm	6 Pt.	Std. Metric Socket	1/4" Dr.
80126	5 mm	6 Pt.	Std. Metric Socket	1/4" Dr.
80127	5.5 mm	6 Pt.	Std. Metric Socket	1/4" Dr.
80128	6 mm	6 Pt.	Std. Metric Socket	1/4" Dr.
80129	7 mm	6 Pt.	Std. Metric Socket	1/4" Dr.
80130	8 mm	6 Pt.	Std. Metric Socket	1/4" Dr.
80131	9 mm	6 Pt.	Std. Metric Socket	1/4" Dr.
80132	10 mm	6 Pt.	Std. Metric Socket	1/4" Dr.
80133	11 mm	6 Pt.	Std. Metric Socket	1/4" Dr.
80134	12 mm	6 Pt.	Std. Metric Socket	1/4" Dr.
80135	13 mm	6 Pt.	Std. Metric Socket	1/4" Dr.
80136	14 mm	6 Pt.	Std. Metric Socket	1/4" Dr.
80480	1/4"	Bit Holder Socket		1/4" Dr.
80496	1/4"	12 Pt.	Std. SAE Socket	3/8" Dr.
80497	5/16"	12 Pt.	Std. SAE Socket	3/8" Dr.
80498	3/8"	12 Pt.	Std. SAE Socket	3/8" Dr.
80499	7/16"	12 Pt.	Std. SAE Socket	3/8" Dr.
80500	1/2"	12 Pt.	Std. SAE Socket	3/8" Dr.
80501	9/16"	12 Pt.	Std. SAE Socket	3/8" Dr.
80502	5/8"	12 Pt.	Std. SAE Socket	3/8" Dr.
80503	11/16"	12 Pt.	Std. SAE Socket	3/8" Dr.
80504	3/4"	12 Pt.	Std. SAE Socket	3/8" Dr.
80505	13/16"	12 Pt.	Std. SAE Socket	3/8" Dr.
80506	7/8"	12 Pt.	Std. SAE Socket	3/8" Dr.
80485	9 mm	12 Pt.	Std. Metric Socket	3/8" Dr.
80486	10 mm	12 Pt.	Std. Metric Socket	3/8" Dr.
80487	11 mm	12 Pt.	Std. SAE Socket	3/8" Dr.

1/4" DRIVE 3/8" DRIVE

Material No.	Description			
80488	12 mm	12 Pt.	Std. Metric Socket	3/8" Dr.
80489	13 mm	12 Pt.	Std. Metric Socket	3/8" Dr.
80490	14 mm	12 Pt.	Std. Metric Socket	3/8" Dr.
80491	15 mm	12 Pt.	Std. Metric Socket	3/8" Dr.
80492	16 mm	12 Pt.	Std. Metric Socket	3/8" Dr.
80493	17 mm	12 Pt.	Std. Metric Socket	3/8" Dr.
80494	18 mm	12 Pt.	Std. Metric Socket	3/8" Dr.
80495	19 mm	12 Pt.	Std. Metric Socket	3/8" Dr.
81218	Quick-Release Teardrop Ratchet			3/8" Dr.
81128	Spinner Handle			1/4" Dr.
81241	3" Extension			3/8" Dr.
80402	5/8"	Spark Plug Socket		3/8" Dr.
81277	3/8" F x 1/4" M Adapter			3/8" Dr.
81794	10 x 12 mm Double Open End Wrench			
81796	12 x 14 mm Double Open End Wrench			
81799	3/8" x 7/16" Double Open End Wrench			
81801	1/2" x 9/16" Double Open End Wrench			
56603G	13 Pc. SAE Hex Key Set			
	#1	Bit Phillips		
	#2	Bit Phillips		
	#3	Bit Phillips		
	4 mm	Bit Slotted		
	5 mm	Bit Slotted		
	6 mm	Bit Slotted		

MULTI-DRIVE SETS
RATCHETS, SOCKETS & DRIVE TOOLS

MULTI-DRIVE SETS



1/4" DRIVE 3/8" DRIVE

83000 - 68 Pc. SAE/METRIC 6 & 12 Pt. Standard Socket Set MULTI DRIVE

RATCHETS, SOCKETS & DRIVE TOOLS

Material No.	Description			
80115	3/16"	6 Pt.	Deep SAE Socket	1/4" Dr.
80116	7/32"	6 Pt.	Deep SAE Socket	1/4" Dr.
80117	1/4"	6 Pt.	Deep SAE Socket	1/4" Dr.
80118	9/32"	6 Pt.	Deep SAE Socket	1/4" Dr.
80119	5/16"	6 Pt.	Deep SAE Socket	1/4" Dr.
80120	11/32"	6 Pt.	Deep SAE Socket	1/4" Dr.
80121	3/8"	6 Pt.	Deep SAE Socket	1/4" Dr.
80122	7/16"	6 Pt.	Deep SAE Socket	1/4" Dr.
80123	1/2"	6 Pt.	Deep SAE Socket	1/4" Dr.
80141	6 mm	6 Pt.	Deep Metric Socket	1/4" Dr.
80142	7 mm	6 Pt.	Deep SAE Socket	1/4" Dr.
80143	8 mm	6 Pt.	Deep Metric Socket	1/4" Dr.
80144	9 mm	6 Pt.	Deep Metric Socket	1/4" Dr.
80145	10 mm	6 Pt.	Deep Metric Socket	1/4" Dr.
80146	11 mm	6 Pt.	Deep Metric Socket	1/4" Dr.
80147	12 mm	6 Pt.	Deep Metric Socket	1/4" Dr.
80148	13 mm	6 Pt.	Deep Metric Socket	1/4" Dr.
80149	14 mm	6 Pt.	Deep Metric Socket	1/4" Dr.
80365	3/8"	6 Pt.	Deep SAE Socket	3/8" Dr.
80366	1/4"	6 Pt.	Deep SAE Socket	3/8" Dr.
80367	7/16"	6 Pt.	Deep SAE Socket	3/8" Dr.
80368	1/2"	6 Pt.	Deep SAE Socket	3/8" Dr.
80369	9/16"	12 Pt.	Deep SAE Socket	3/8" Dr.
80370	5/8"	6 Pt.	Deep SAE Socket	3/8" Dr.
80371	11/16"	6 Pt.	Deep SAE Socket	3/8" Dr.
80372	3/4"	6 Pt.	Deep SAE Socket	3/8" Dr.
80485	9 mm	12 Pt.	Std. Metric Socket	3/8" Dr.
80486	10 mm	12 Pt.	Std. Metric Socket	3/8" Dr.
80487	11 mm	12 Pt.	Std. Metric Socket	3/8" Dr.
80488	12 mm	12 Pt.	Std. Metric Socket	3/8" Dr.
80489	13 mm	12 Pt.	Std. Metric Socket	3/8" Dr.

Material No.	Description			
80490	14 mm	12 Pt.	Std. Metric Socket	3/8" Dr.
80491	15 mm	12 Pt.	Std. Metric Socket	3/8" Dr.
80492	16 mm	12 Pt.	Std. Metric Socket	3/8" Dr.
80493	17 mm	12 Pt.	Std. Metric Socket	3/8" Dr.
80498	3/8"	12 Pt.	Std. SAE Socket	3/8" Dr.
80499	7/16"	12 Pt.	Std. SAE Socket	3/8" Dr.
80500	1/2"	12 Pt.	Std. SAE Socket	3/8" Dr.
80501	9/16"	12 Pt.	Std. SAE Socket	3/8" Dr.
80502	5/8"	12 Pt.	Std. SAE Socket	3/8" Dr.
80503	11/16"	12 Pt.	Std. SAE Socket	3/8" Dr.
80504	3/4"	12 Pt.	Std. SAE Socket	3/8" Dr.
80505	13/16"	12 Pt.	Std. SAE Socket	3/8" Dr.
80506	7/8"	12 Pt.	Std. SAE Socket	3/8" Dr.
80197	4 mm	12 Pt.	Std. Metric Socket	1/4" Dr.
80198	5 mm	12 Pt.	Std. Metric Socket	1/4" Dr.
80200	6 mm	12 Pt.	Std. Metric Socket	1/4" Dr.
80201	7 mm	12 Pt.	Std. Metric Socket	1/4" Dr.
80202	8 mm	12 Pt.	Std. Metric Socket	1/4" Dr.
80203	9 mm	12 Pt.	Std. SAE Socket	1/4" Dr.
80204	10 mm	12 Pt.	Std. Metric Socket	1/4" Dr.
80205	11 mm	12 Pt.	Std. Metric Socket	1/4" Dr.
80206	12 mm	12 Pt.	Std. Metric Socket	1/4" Dr.
80210	3/16"	12 Pt.	Std. SAE Socket	1/4" Dr.
80211	7/32"	12 Pt.	Std. SAE Socket	1/4" Dr.
80212	1/4"	12 Pt.	Std. SAE Socket	1/4" Dr.
80213	9/32"	12 Pt.	Std. SAE Socket	1/4" Dr.
80214	5/16"	12 Pt.	Std. SAE Socket	1/4" Dr.
80215	11/32"	12 Pt.	Std. SAE Socket	1/4" Dr.
80216	3/8"	12 Pt.	Std. SAE Socket	1/4" Dr.
80217	7/16"	12 Pt.	Std. SAE Socket	1/4" Dr.
80218	1/2"	12 Pt.	Std. SAE Socket	1/4" Dr.
81101	2" Extension			1/4" Dr.
81116	6" Extension			1/4" Dr.
81241	3" Extension			3/8" Dr.
81242	6" Extension			3/8" Dr.
81011	Full Polish Teardrop Ratchet			1/4" Dr.
81211	Full Polish Teardrop Ratchet			3/8" Dr.
83000BM	Replacement Blow Mold Case			

MULTI-DRIVE SETS

**83071 - 90 Pc. Socket Set METRIC/SAE
1/4", 3/8" & 1/2" DRIVE**

Description

- 1/4" Drive 6pt. Sockets: 5/32", 3/16", 7/32", 1/4", 9/32", 5/16", 11/32", 3/8", 7/16", 1/2" 1/4"
- 1/4" Drive 6pt. Sockets: 4mm, 5mm, 5.5mm, 6mm, 7mm, 8mm, 9mm, 10mm, 11mm, 12mm, 13mm
- 1/4" Drive 6pt. Deep Sockets: 1/4", 9/32", 5/16", 11/32", 3/8", 7/16", 1/2"
- 1/4" Drive 6pt. Deep Sockets: 7mm, 8mm, 9mm, 10mm, 11mm, 12mm, 13mm
- 1/4" Drive Teardrop Quick Release Ratchet; 3" Extension Bar; 1/4" Drive Bit Holder Socket
- 3/8" Drive 6pt. Deep Sockets: 9/16", 5/8", 11/16", 3/4"
- 3/8" Drive 6pt. Deep Sockets: 14mm, 15mm, 16mm, 17mm, 18mm, 19mm
- 3/8" Drive 12pt. Sockets: 3/8", 7/16", 1/2", 9/16", 5/8", 11/16", 3/4", 13/16", 7/8"
- 3/8" Drive 12pt. Sockets: 10mm, 11mm, 12mm, 13mm, 14mm, 15mm, 16mm, 17mm, 18mm, 19mm, 21mm
- 3/8" Drive Teardrop Quick Release Ratchet; 6" Extension Bar; 3/8" Drive Spark Plug Socket 5/8"
- 1/2" Drive 12pt. Sockets: 11/16", 3/4", 13/16", 7/8", 15/16", 1", 1-1/8", 1-1/4"
- 1/2" Drive 12pt. Sockets: 19mm, 20mm, 21mm, 22mm, 24mm, 25mm, 27mm, 30mm, 32mm
- 1/2" Drive Quick Release Tear Drop Ratchet; 3" Extension Bar
- EVA Tray Included: uncut 655mm x 395mm, cut = 557mm x 360mm

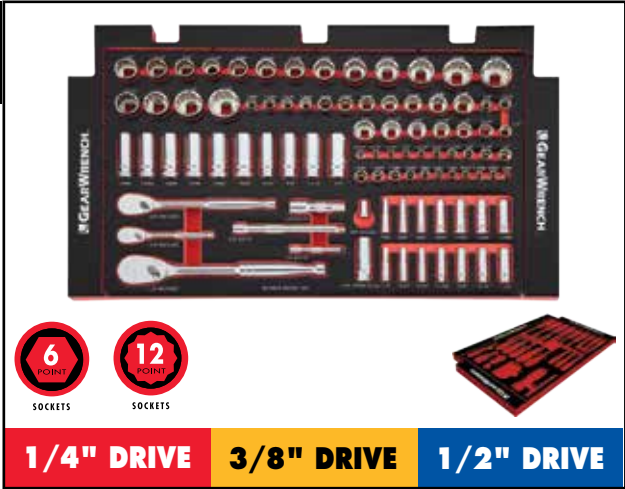

Fits drawer type **A** as shown on page 34.

**83050 - 42 Pc. Socket Set METRIC/SAE
1/4" & 3/8" DRIVE**

Description

- 1/4" Drive 6pt. Sockets: 3/16", 7/32", 1/4", 9/32", 5/16", 11/32", 3/8", 7/16", 1/2"
- 1/4" Drive 6pt. Sockets: 4mm, 5mm, 6mm, 7mm, 8mm, 9mm, 10mm, 11mm, 12mm
- 1/4" Drive Full Polish Teardrop Ratchet; 1/4"F x 3/8"M Adapter
- 3/8" Drive 12pt. Sockets: 3/8", 7/16", 1/2", 9/16", 5/8", 11/16", 3/4"
- 3/8" Drive 12pt. Sockets: 8mm, 10mm, 11mm, 12mm, 13mm, 14mm, 15mm, 17mm, 19mm
- 3/8" Drive Full Polish Teardrop Ratchet; 3" Extension Bar; Universal Joint; 3/8"F x 1/4"M Adapter; Spark Plug Socket 5/8"; Spark Plug Socket 13/16"
- Metal Case with EVA Tray Insert: 168mm x 360mm



MICRODRIVER SET

**85035 - 35 Pc. Microdriver Set
GEARWRENCH**

Description

- 1/4" x 5/16" Double Box MicroDriver™
- 1/4" Drive Socket Adapter
- 5/16", 3/8", 7/16", 1/2", 9/16" S.A.E. Sockets (6pt)
- 8mm, 10mm, 12mm, 14mm Metric Sockets (6pt)
- 5/32", 7/32", 9/32" 1/4" Bit, Slotted
- #1, #2, #3 Bit, Phillips
- 3/32", 1/8", 5/32", 3/16", 1/4", 5/16" Bit, Hex



- T20, T25, T30, T40 Bit, Torx®
- #2, #3 Bit, Square
- 5/16", 3/8" 5/16" Bit, Slotted
- 3/8" 5/16" Bit, Hex
- T45, T50 5/16" Bit, Torx®

MICRODRIVER SET
RATCHETS, SOCKETS & DRIVE TOOLS

RATCHETS/ADAPTERS

RATCHETS, SOCKETS & DRIVE TOOLS
RATCHETS/ADAPTERS



**81222 - 2 Pc. Thumbwheel Ratchet Set
MULTI DRIVE**

Material No.	Description	
81008	Thumbwheel Ratchet	1/4" Dr.
81226	Thumbwheel Ratchet	3/8" Dr.



**81205 - 10 Pc. Universal Adapter Set
MULTI DRIVE**

Material No.	Description	
80100	Universal Joint	1/4" Dr.
80549	Universal Joint	3/8" Dr.
80101	Impact Universal Joint	1/4" Dr.
80548	Universal Joint	3/8" Dr.
80671	Universal Joint	1/2" Dr.
81127	1/4" F x 3/8" M Adapter	1/4" Dr.
81277	3/8" F x 1/4" M Adapter	3/8" Dr.
81278	3/8" F x 1/2" M Adapter	3/8" Dr.
81354	1/2" F x 3/8" M Adapter	1/2" Dr.
81355	1/2" F x 3/4" M Adapter	1/2" Dr.



**81217 - 4 Pc. Clip Rail Adapter Set
MULTI DRIVE**

Material No.	Description	
81127	1/4" F x 3/8" M Adapter	1/4" Dr.
81277	3/8" F x 1/4" M Adapter	3/8" Dr.
81278	3/8" F x 1/2" M Adapter	3/8" Dr.
81354	1/2" F x 3/8" M Adapter	1/2" Dr.



**81206P - 3 Pc. 120XP Full Polish Teardrop Ratchet Set
MULTI DRIVE**

Material No.	Description	
81011	Full Polish Teardrop Ratchet	1/4" Dr.
81211	Full Polish Teardrop Ratchet	3/8" Dr.
81304	Full Polish Teardrop Ratchet	1/2" Dr.

- 120 positions
- 3 degree ratcheting arc

1/4" DRIVE SETS

80300 - 51 Pc. SAE/METRIC 6 Pt. Standard & Deep Socket Set 1/4" DRIVE



Material No.	Description				
80105	3/16"	6 Pt.	Std. SAE Socket	1/4" Dr.	
80106	7/32"	6 Pt.	Std. SAE Socket	1/4" Dr.	
80107	1/4"	6 Pt.	Std. SAE Socket	1/4" Dr.	
80108	9/32"	6 Pt.	Std. SAE Socket	1/4" Dr.	
80109	5/16"	6 Pt.	Std. SAE Socket	1/4" Dr.	
80110	11/32"	6 Pt.	Std. SAE Socket	1/4" Dr.	
80111	3/8"	6 Pt.	Std. SAE Socket	1/4" Dr.	
80112	7/16"	6 Pt.	Std. SAE Socket	1/4" Dr.	
80113	1/2"	6 Pt.	Std. SAE Socket	1/4" Dr.	
80114	9/16"	6 Pt.	Std. SAE Socket	1/4" Dr.	
80125	4 mm	6 Pt.	Std. Metric Socket	1/4" Dr.	
80126	5 mm	6 Pt.	Std. Metric Socket	1/4" Dr.	
80127	5.5 mm	6 Pt.	Std. Metric Socket	1/4" Dr.	
80128	6 mm	6 Pt.	Std. Metric Socket	1/4" Dr.	
80129	7 mm	6 Pt.	Std. Metric Socket	1/4" Dr.	
80130	8 mm	6 Pt.	Std. Metric Socket	1/4" Dr.	
80131	9 mm	6 Pt.	Std. Metric Socket	1/4" Dr.	
80132	10 mm	6 Pt.	Std. Metric Socket	1/4" Dr.	
80133	11 mm	6 Pt.	Std. Metric Socket	1/4" Dr.	
80134	12 mm	6 Pt.	Std. Metric Socket	1/4" Dr.	
80135	13 mm	6 Pt.	Std. Metric Socket	1/4" Dr.	
80136	14 mm	6 Pt.	Std. Metric Socket	1/4" Dr.	
80137	15 mm	6 Pt.	Std. Metric Socket	1/4" Dr.	
80115	3/16"	6 Pt.	Deep SAE Socket	1/4" Dr.	
80116	7/32"	6 Pt.	Deep SAE Socket	1/4" Dr.	
80117	1/4"	6 Pt.	Deep SAE Socket	1/4" Dr.	
80118	9/32"	6 Pt.	Deep SAE Socket	1/4" Dr.	
80119	5/16"	6 Pt.	Deep SAE Socket	1/4" Dr.	
80120	11/32"	6 Pt.	Deep SAE Socket	1/4" Dr.	
80121	3/8"	6 Pt.	Deep SAE Socket	1/4" Dr.	
80122	7/16"	6 Pt.	Deep SAE Socket	1/4" Dr.	
80123	1/2"	6 Pt.	Deep SAE Socket	1/4" Dr.	

Material No.	Description				
80124	9/16"	6 Pt.	Deep SAE Socket	1/4" Dr.	
80138	4 mm	6 Pt.	Deep Metric Socket	1/4" Dr.	
80139	5 mm	6 Pt.	Deep Metric Socket	1/4" Dr.	
80140	5.5 mm	6 Pt.	Deep Metric Socket	1/4" Dr.	
80141	6 mm	6 Pt.	Deep Metric Socket	1/4" Dr.	
80142	7 mm	6 Pt.	Deep Metric Socket	1/4" Dr.	
80143	8 mm	6 Pt.	Deep Metric Socket	1/4" Dr.	
80144	9 mm	6 Pt.	Deep Metric Socket	1/4" Dr.	
80145	10 mm	6 Pt.	Deep Metric Socket	1/4" Dr.	
80146	11 mm	6 Pt.	Deep Metric Socket	1/4" Dr.	
80147	12 mm	6 Pt.	Deep Metric Socket	1/4" Dr.	
80148	13 mm	6 Pt.	Deep Metric Socket	1/4" Dr.	
80149	14 mm	6 Pt.	Deep Metric Socket	1/4" Dr.	
80150	15 mm	6 Pt.	Deep Metric Socket	1/4" Dr.	
81101	2" Extension			1/4" Dr.	
81116	6" Extension			1/4" Dr.	
80100	Universal Joint			1/4" Dr.	
81008	Thumbwheel Ratchet			1/4" Dr.	
81011	Full Polish Teardrop Ratchet			1/4" Dr.	
80300BM	Replacement Blow Mold Case			1/4" Dr.	

**1/4" DRIVESETS
RATCHETS, SOCKETS & DRIVE TOOLS**

1/4" DRIVE SETS



80301 - 51 Pc. SAE/METRIC 12 Pt. Standard & Deep Socket Set 1/4" DRIVE

Material No.	Description			
80205	11 mm	12 Pt.	Std. Metric Socket	1/4" Dr.
80206	12 mm	12 Pt.	Std. Metric Socket	1/4" Dr.
80207	13 mm	12 Pt.	Std. Metric Socket	1/4" Dr.
80208	14 mm	12 Pt.	Std. Metric Socket	1/4" Dr.
80209	15 mm	12 Pt.	Std. Metric Socket	1/4" Dr.
80220	3/16"	12 Pt.	Deep SAE Socket	1/4" Dr.
80221	7/32"	12 Pt.	Deep SAE Socket	1/4" Dr.
80222	1/4"	12 Pt.	Deep SAE Socket	1/4" Dr.
80223	9/32"	12 Pt.	Deep SAE Socket	1/4" Dr.
80224	5/16"	12 Pt.	Deep SAE Socket	1/4" Dr.
80225	11/32"	12 Pt.	Deep SAE Socket	1/4" Dr.
80226	3/8"	12 Pt.	Deep SAE Socket	1/4" Dr.
80227	7/16"	12 Pt.	Deep SAE Socket	1/4" Dr.
80228	1/2"	12 Pt.	Deep SAE Socket	1/4" Dr.
80229	9/16"	12 Pt.	Deep SAE Socket	1/4" Dr.
80230	4 mm	12 Pt.	Deep Metric Socket	1/4" Dr.
80231	5 mm	12 Pt.	Deep Metric Socket	1/4" Dr.
80232	5.5 mm	12 Pt.	Deep Metric Socket	1/4" Dr.
80233	6 mm	12 Pt.	Deep Metric Socket	1/4" Dr.
80234	7 mm	12 Pt.	Deep Metric Socket	1/4" Dr.
80235	8 mm	12 Pt.	Deep Metric Socket	1/4" Dr.
80236	9 mm	12 Pt.	Deep Metric Socket	1/4" Dr.
80237	10 mm	6 Pt.	Deep Metric Socket	1/4" Dr.
80238	11 mm	6 Pt.	Deep Metric Socket	1/4" Dr.
80239	12 mm	6 Pt.	Deep Metric Socket	1/4" Dr.
80240	13 mm	6 Pt.	Deep Metric Socket	1/4" Dr.
80241	14 mm	6 Pt.	Deep Metric Socket	1/4" Dr.
80242	15 mm	6 Pt.	Deep Metric Socket	1/4" Dr.
81101	2" Extension			1/4" Dr.
81116	6" Extension			1/4" Dr.
80100	Universal Joint			1/4" Dr.
81008	Thumbwheel Ratchet			1/4" Dr.
81011	Full Polish Teardrop Ratchet			1/4" Dr.

Material No.	Description			
80210	3/16"	12 Pt.	Std. SAE Socket	1/4" Dr.
80211	7/32"	12 Pt.	Std. SAE Socket	1/4" Dr.
80212	1/4"	12 Pt.	Std. SAE Socket	1/4" Dr.
80213	9/32"	12 Pt.	Std. SAE Socket	1/4" Dr.
80214	5/16"	12 Pt.	Std. SAE Socket	1/4" Dr.
80215	11/32"	12 Pt.	Std. SAE Socket	1/4" Dr.
80216	3/8"	12 Pt.	Std. SAE Socket	1/4" Dr.
80217	7/16"	12 Pt.	Std. SAE Socket	1/4" Dr.
80218	1/2"	12 Pt.	Std. SAE Socket	1/4" Dr.
80219	9/16"	12 Pt.	Std. SAE Socket	1/4" Dr.
80197	4 mm	12 Pt.	Std. Metric Socket	1/4" Dr.
80198	5 mm	12 Pt.	Std. Metric Socket	1/4" Dr.
80199	5.5 mm	12 Pt.	Std. Metric Socket	1/4" Dr.
80200	6 mm	12 Pt.	Std. Metric Socket	1/4" Dr.
80201	7 mm	12 Pt.	Std. Metric Socket	1/4" Dr.
80202	8 mm	12 Pt.	Std. Metric Socket	1/4" Dr.
80203	9 mm	12 Pt.	Std. Metric Socket	1/4" Dr.
80204	10 mm	12 Pt.	Std. Metric Socket	1/4" Dr.



80327 - 22 Pc. METRIC 6 & 12 Pt. Standard & Deep Socket Set 1/4" DRIVE

Material No.	Description			
80147	12 mm	6 Pt.	Deep Metric Socket	1/4" Dr.
80148	13 mm	6 Pt.	Deep Metric Socket	1/4" Dr.
80149	14 mm	6 Pt.	Deep Metric Socket	1/4" Dr.
80197	4 mm	12 Pt.	Std. Metric Socket	1/4" Dr.
80198	5 mm	12 Pt.	Std. Metric Socket	1/4" Dr.
80200	6 mm	12 Pt.	Std. Metric Socket	1/4" Dr.
80201	7 mm	12 Pt.	Std. Metric Socket	1/4" Dr.
80202	8 mm	12 Pt.	Std. Metric Socket	1/4" Dr.
80203	9 mm	12 Pt.	Std. Metric Socket	1/4" Dr.
80204	10 mm	12 Pt.	Std. Metric Socket	1/4" Dr.
80205	11 mm	12 Pt.	Std. Metric Socket	1/4" Dr.
80206	12 mm	12 Pt.	Std. Metric Socket	1/4" Dr.
81101	2" Extension			1/4" Dr.
81116	6" Extension			1/4" Dr.
81128	Spinner Handle			1/4" Dr.
81011	Full Polish Teardrop Ratchet			1/4" Dr.

Material No.	Description			
80141	6 mm	6 Pt.	Deep Metric Socket	1/4" Dr.
80142	7 mm	6 Pt.	Deep Metric Socket	1/4" Dr.
80143	8 mm	6 Pt.	Deep Metric Socket	1/4" Dr.
80144	9 mm	6 Pt.	Deep Metric Socket	1/4" Dr.
80145	10 mm	6 Pt.	Deep Metric Socket	1/4" Dr.
80146	11 mm	6 Pt.	Deep Metric Socket	1/4" Dr.

RATCHETS, SOCKETS & DRIVE TOOLS 1/4" DRIVE SETS

1/4" DRIVE SETS

80325 - 22 Pc. SAE 6 & 12 Pt. Standard & Deep Socket Set 1/4" DRIVE

Material No.	Description
80115	3/16" 6 Pt. Deep SAE Socket 1/4" Dr.
80116	7/32" 6 Pt. Deep SAE Socket 1/4" Dr.
80117	1/4" 6 Pt. Deep SAE Socket 1/4" Dr.
80118	9/32" 6 Pt. Deep SAE Socket 1/4" Dr.
80119	5/16" 6 Pt. Deep SAE Socket 1/4" Dr.
80120	11/32" 6 Pt. Deep SAE Socket 1/4" Dr.
80121	3/8" 6 Pt. Deep SAE Socket 1/4" Dr.
80122	7/16" 6 Pt. Deep SAE Socket 1/4" Dr.
80123	1/2" 6 Pt. Deep SAE Socket 1/4" Dr.
80210	3/16" 12 Pt. Std. SAE Socket 1/4" Dr.
80211	7/32" 12 Pt. Std. SAE Socket 1/4" Dr.
80212	1/4" 12 Pt. Std. SAE Socket 1/4" Dr.
80213	9/32" 12 Pt. Std. SAE Socket 1/4" Dr.
80214	5/16" 12 Pt. Std. SAE Socket 1/4" Dr.
80215	11/32" 12 Pt. Std. SAE Socket 1/4" Dr.
80216	3/8" 12 Pt. Std. SAE Socket 1/4" Dr.



Material No.	Description
80217	7/16" 12 Pt. Std. SAE Socket 1/4" Dr.
80218	1/2" 12 Pt. Std. SAE Socket 1/4" Dr.
81101	2" Extension 1/4" Dr.
81116	6" Extension 1/4" Dr.
81128	Spinner Handle 1/4" Dr.
81011	Full Polish Teardrop Ratchet 1/4" Dr.

83051 - 39 Pc. Socket Set METRIC/SAE 1/4" DRIVE

Description

- 1/4" Drive 6pt. Sockets: 3/16", 7/32", 1/4", 9/32", 5/16", 11/32", 3/8", 7/16", 1/2"
- 1/4" Drive 6pt. Sockets: 4mm, 5mm, 6mm, 7mm, 8mm, 9mm, 10mm, 11mm, 12mm, 13mm
- 1/4" Drive 6pt. Deep Sockets: 3/16", 1/4", 5/16", 11/32", 3/8", 7/16", 1/2"
- 1/4" Drive 6pt. Deep Sockets: 4mm, 5mm, 6mm, 7mm, 8mm, 10mm, 11mm, 12mm, 13mm
- 1/4" Drive Full Polish Teardrop Ratchet; 5 1/2" Flex Handle; Universal Joint; 3" Extension Bar
- Metal Case with EVA Tray Insert: 168mm x 360mm



83060 - 31 Pc. Socket Set + Wrench Set METRIC/SAE 1/4" DRIVE

Description

- 1/4" Drive 6pt. Standard Sockets: 4mm, 5mm, 6mm, 7mm, 8mm, 9mm, 10mm, 11mm, 12mm, 13mm
- 1/4" Drive 6pt. Standard Sockets: 3/16", 7/32", 1/4", 9/32", 5/16", 11/32", 3/8", 7/16", 1/2"
- 1/4" Drive Full Polish Teardrop Ratchet; 1/4" Drive Flex Handle 5-1/2"; 1/4" Drive Universal Joint; 1/4" Drive Standard Extension 3"
- Long Pattern Combination Non-Ratcheting Wrenches: 8mm, 9mm, 10mm, 11mm, 12mm, 13mm, 14mm, 15mm
- Blow moulded case - 168mm x 360mm



**1/4" DRIVESETS
RATCHETS, SOCKETS & DRIVE TOOLS**

Fits drawer type **B** as shown on page 34.

1/4" DRIVE SETS



80302 - 13 Pc. METRIC 6 Pt. Standard Socket Set 1/4" DRIVE

Material No.	Description			
80130	8 mm	6 Pt.	Std. Metric Socket	1/4" Dr.
80131	9 mm	6 Pt.	Std. Metric Socket	1/4" Dr.
80132	10 mm	6 Pt.	Std. Metric Socket	1/4" Dr.
80133	11 mm	6 Pt.	Std. Metric Socket	1/4" Dr.
80134	12 mm	6 Pt.	Std. Metric Socket	1/4" Dr.
80135	13 mm	6 Pt.	Std. Metric Socket	1/4" Dr.
80136	14 mm	6 Pt.	Std. Metric Socket	1/4" Dr.
80137	15 mm	6 Pt.	Std. Metric Socket	1/4" Dr.

Material No.	Description			
80125	4 mm	6 Pt.	Std. Metric Socket	1/4" Dr.
80126	5 mm	6 Pt.	Std. Metric Socket	1/4" Dr.
80127	5.5 mm	6 Pt.	Std. Metric Socket	1/4" Dr.
80128	6 mm	6 Pt.	Std. Metric Socket	1/4" Dr.
80129	7 mm	6 Pt.	Std. Metric Socket	1/4" Dr.



80303 - 10 Pc. SAE 6 Pt. Standard Socket Set 1/4" DRIVE

Material No.	Description			
80109	5/16"	6 Pt.	Std. SAE Socket	1/4" Dr.
80110	11/32"	6 Pt.	Std. SAE Socket	1/4" Dr.
80111	3/8"	6 Pt.	Std. SAE Socket	1/4" Dr.
80112	7/16"	6 Pt.	Std. SAE Socket	1/4" Dr.
80113	1/2"	6 Pt.	Std. SAE Socket	1/4" Dr.
80114	9/16"	6 Pt.	Std. SAE Socket	1/4" Dr.

Material No.	Description			
80105	3/16"	6 Pt.	Std. SAE Socket	1/4" Dr.
80106	7/32"	6 Pt.	Std. SAE Socket	1/4" Dr.
80107	1/4"	6 Pt.	Std. SAE Socket	1/4" Dr.
80108	9/32"	6 Pt.	Std. SAE Socket	1/4" Dr.



80304 - 13 Pc. METRIC 6 Pt. Deep Socket Set 1/4" DRIVE

Material No.	Description			
80143	8 mm	6 Pt.	Deep Metric Socket	1/4" Dr.
80144	9 mm	6 Pt.	Deep Metric Socket	1/4" Dr.
80145	10 mm	6 Pt.	Deep Metric Socket	1/4" Dr.
80146	11 mm	6 Pt.	Deep Metric Socket	1/4" Dr.
80147	12 mm	6 Pt.	Deep Metric Socket	1/4" Dr.
80148	13 mm	6 Pt.	Deep Metric Socket	1/4" Dr.
80149	14 mm	6 Pt.	Deep Metric Socket	1/4" Dr.
80150	15 mm	6 Pt.	Deep Metric Socket	1/4" Dr.

Material No.	Description			
80138	4 mm	6 Pt.	Deep Metric Socket	1/4" Dr.
80139	5 mm	6 Pt.	Deep Metric Socket	1/4" Dr.
80140	5.5 mm	6 Pt.	Deep Metric Socket	1/4" Dr.
80141	6 mm	6 Pt.	Deep Metric Socket	1/4" Dr.
80142	7 mm	6 Pt.	Deep Metric Socket	1/4" Dr.



80305 - 10 Pc. SAE 6 Pt. Deep Socket Set 1/4" DRIVE

Material No.	Description			
80118	9/32"	6 Pt.	Deep SAE Socket	1/4" Dr.
80119	5/16"	6 Pt.	Deep SAE Socket	1/4" Dr.
80120	11/32"	6 Pt.	Deep SAE Socket	1/4" Dr.
80121	3/8"	6 Pt.	Deep SAE Socket	1/4" Dr.
80122	7/16"	6 Pt.	Deep SAE Socket	1/4" Dr.
80123	1/2"	6 Pt.	Deep SAE Socket	1/4" Dr.
80124	9/16"	6 Pt.	Deep SAE Socket	1/4" Dr.

Material No.	Description			
80115	3/16"	6 Pt.	Deep SAE Socket	1/4" Dr.
80116	7/32"	6 Pt.	Deep SAE Socket	1/4" Dr.
80117	1/4"	6 Pt.	Deep SAE Socket	1/4" Dr.

RATCHETS, SOCKETS & DRIVE TOOLS 1/4" DRIVE SETS

1/4" DRIVE SETS

80306 - 13 Pc. METRIC 12 Pt. Standard Socket Set 1/4" DRIVE

Material No.	Description		
80197	4 mm	12 Pt. Std. Metric Socket	1/4" Dr.
80198	5 mm	12 Pt. Std. Metric Socket	1/4" Dr.
80199	5.5 mm	12 Pt. Std. Metric Socket	1/4" Dr.
80200	6 mm	12 Pt. Std. Metric Socket	1/4" Dr.
80201	7 mm	12 Pt. Std. Metric Socket	1/4" Dr.
80202	8 mm	12 Pt. Std. Metric Socket	1/4" Dr.
80203	9 mm	12 Pt. Std. Metric Socket	1/4" Dr.
80204	10 mm	12 Pt. Std. Metric Socket	1/4" Dr.



Material No.	Description		
80205	11 mm	12 Pt. Std. Metric Socket	1/4" Dr.
80206	12 mm	12 Pt. Std. Metric Socket	1/4" Dr.
80207	13 mm	12 Pt. Std. Metric Socket	1/4" Dr.
80208	14 mm	12 Pt. Std. Metric Socket	1/4" Dr.
80209	15 mm	12 Pt. Std. Metric Socket	1/4" Dr.

80307D - 10 Pc. SAE 12 Pt. Standard Socket Set 1/4" DRIVE

Material No.	Description		
80210	3/16"	12 Pt. Std. SAE Socket	1/4" Dr.
80211	7/32"	12 Pt. Std. SAE Socket	1/4" Dr.
80212	1/4"	12 Pt. Std. SAE Socket	1/4" Dr.
80213	9/32"	12 Pt. Std. SAE Socket	1/4" Dr.
80214	5/16"	12 Pt. Std. SAE Socket	1/4" Dr.
80215	11/32"	12 Pt. Std. SAE Socket	1/4" Dr.



Material No.	Description		
80216	3/8"	12 Pt. Std. SAE Socket	1/4" Dr.
80217	7/16"	12 Pt. Std. SAE Socket	1/4" Dr.
80218	1/2"	12 Pt. Std. SAE Socket	1/4" Dr.
80219	9/16"	12 Pt. Std. SAE Socket	1/4" Dr.

80311 - 12 Pc. METRIC 6 Pt. Flex Socket Set 1/4" DRIVE

Material No.	Description		
80250	5 mm	6 Pt. Flex Metric Socket	1/4" Dr.
80251	5.5 mm	6 Pt. Flex Metric Socket	1/4" Dr.
80252	6 mm	6 Pt. Flex Metric Socket	1/4" Dr.
80253	7 mm	6 Pt. Flex Metric Socket	1/4" Dr.
80254	8 mm	6 Pt. Flex Metric Socket	1/4" Dr.
80255	9 mm	6 Pt. Flex Metric Socket	1/4" Dr.
80256	10 mm	6 Pt. Flex Metric Socket	1/4" Dr.



Material No.	Description		
80257	11 mm	6 Pt. Flex Metric Socket	1/4" Dr.
80258	12 mm	6 Pt. Flex Metric Socket	1/4" Dr.
80259	13 mm	6 Pt. Flex Metric Socket	1/4" Dr.
80260	14 mm	6 Pt. Flex Metric Socket	1/4" Dr.
80261	15 mm	6 Pt. Flex Metric Socket	1/4" Dr.

80310D - 7 Pc. SAE 6 Pt. Flex Socket Set 1/4" DRIVE

Material No.	Description		
80262	3/16"	6 Pt. Flex SAE Socket	1/4" Dr.
80263	1/4"	6 Pt. Flex SAE Socket	1/4" Dr.
80264	5/16"	6 Pt. Flex SAE Socket	1/4" Dr.
80265	3/8"	6 Pt. Flex SAE Socket	1/4" Dr.
80266	7/16"	6 Pt. Flex SAE Socket	1/4" Dr.



Material No.	Description		
80267	1/2"	6 Pt. Flex SAE Socket	1/4" Dr.
80268	9/16"	6 Pt. Flex SAE Socket	1/4" Dr.

**1/4" DRIVESETS
RATCHETS, SOCKETS & DRIVE TOOLS**

1/4" DRIVE OPEN STOCK

RATCHETS, SOCKETS & DRIVE TOOLS



PATENTED

Full Polish Teardrop Ratchet 1/4" DRIVE

Material No.	Description	Overall Length (mm)	Weight (g)
81011F	Full Polish Teardrop Ratchet	130	100

- 60 tooth low profile ratchet



PATENTED

NEW PRODUCT

Full Polish Flex Teardrop Ratchet 1/4" DRIVE

Material No.	Description	Overall Length (mm)	Weight (g)
81012D	Full Polish Flex Teardrop Ratchet	177	150

- 60 tooth low profile ratchet



PATENTED

NEW PRODUCT

120XP Full Polish Teardrop Ratchet 1/4" DRIVE

Material No.	Description	Overall Length (mm)	Weight (g)
81011P	Full Polish Teardrop Ratchet	130	100

- 120 positions
- 3 degree ratcheting arc



PATENTED

NEW PRODUCT

120XP Full Polish Flex Teardrop Ratchet 1/4" DRIVE

Material No.	Description	Overall Length (mm)	Weight (g)
81012P	Full Polish Flex Teardrop Ratchet	177	150

- 120 positions
- 3 degree ratcheting arc

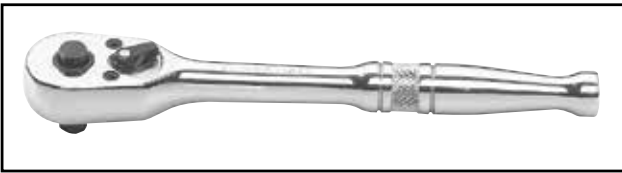

Quick-Release Teardrop Ratchet 1/4" DRIVE

Material No.	Description	Overall Length (mm)	Weight (g)
81014	Quick-Release Teardrop Ratchet	143	90

- 45 tooth standard ratchet



PATENTED

Cushion Grip Teardrop Ratchet 1/4" DRIVE

Material No.	Description	Overall Length (mm)	Weight (g)
81007F	Cushion Grip Teardrop Ratchet	163	132

- 60 tooth low profile ratchet



PATENTED

Cushion Grip Flex Teardrop Ratchet 1/4" DRIVE

Material No.	Description	Overall Length (mm)	Weight (g)
81009F	Cushion Grip Flex Teardrop Ratchet	197	181

- 60 tooth low profile ratchet

1/4" DRIVE OPEN STOCK

Cushion Grip Roto Ratchet 1/4" DRIVE

Material No.	Description	Weight (g)
81224	Cushion Grip Roto Ratchet	132

- 72 tooth roto ratchet



Spinner Handle 1/4" DRIVE

Material No.	Description	Weight (g)
81128	Spinner Handle	120



Thumbwheel Ratchet 1/4" DRIVE

Material No.	Description	Weight (g)
81008	Thumbwheel Ratchet	46



1/4" OPEN STOCK
RATCHETS, SOCKETS & DRIVE TOOLS

1/4" DRIVE OPEN STOCK

1/4" OPEN STOCK
RATCHETS, SOCKETS & DRIVE TOOLS



Flex handle 1/4" DRIVE

Material No.	Description	Overall Length (inch)	Weight (g)
81013	Flex Handle	5.43"	133



Universal Joint 1/4" DRIVE

Material No.	Description	Weight (g)
80100	Universal Joint	20



PATENTED

Spring Universal Joint 1/4" DRIVE

Material No.	Description	Weight (g)
81232	Spring Universal Joint	32



Adapter 1/4" DRIVE

Material No.	Description	Weight (g)
81127	Adapter 1/4" F x 3/8" M	20



Standard Extension 1/4" DRIVE

Material No.	Description	Weight (g)
81101	2" Standard Extension	30
81116	6" Standard Extension	80
81117D	10" Standard Extension	110
81118	14" Standard Extension	150



Wobble Extensions 1/4" DRIVE

Material No.	Description	Weight (g)
81119	2" Wobble Extension	30
81121	6" Wobble Extension	80



Locking Extension 1/4" DRIVE

Material No.	Description	Weight (g)
81126	6" Locking Extension	80

Ratchet Repair Kit 1/4" DRIVE

Material No.	Description
81099	Ratchet Repair Kit

- for non-quick release and non-ROTO ratchets

1/4" OPEN STOCK

6 & 12 Pt. Standard Socket METRIC/SAE 1/4" DRIVE

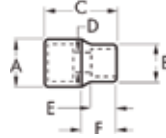

Material No.	Size	Description	Drive End	Wrench	Overall	Bolt	Wrench	Length to	Weight (g)
			(mm)	End (mm)	Length (mm)	Clearance	Depth (mm)	Shoulder	
			A	B	C	D	E	F	
80125	4 mm	6 Pt. Std. Metric	11.8	6.7	24.5	3.4	8.0	11.5	10
80126	5 mm	6 Pt. Std. Metric	11.8	8.0	24.5	4.0	8.0	11.5	10
80127	5.5 mm	6 Pt. Std. Metric	11.8	8.6	24.5	4.0	8.0	11.5	10
80128	6 mm	6 Pt. Std. Metric	11.8	9.2	24.5	4.0	9.0	11.5	10
80129	7 mm	6 Pt. Std. Metric	11.8	10.7	24.5	5.6	9.5	11.5	10
80130	8 mm	6 Pt. Std. Metric	11.8	11.5	24.5	5.6	10.0	11.5	12
80131D	9 mm	6 Pt. Std. Metric	13.1	13.1	24.5	5.6	10.5	11.5	15
80132	10 mm	6 Pt. Std. Metric	14.3	14.3	24.5	5.6	12.5	11.5	18
80133	11 mm	6 Pt. Std. Metric	15.8	15.8	24.5	5.6	12.5	11.5	20
80134	12 mm	6 Pt. Std. Metric	10.2	10.2	24.5	5.6	12.5	11.5	22
80135D	13 mm	6 Pt. Std. Metric	17.9	17.9	24.5	5.6	12.5	11.5	27
80136	14 mm	6 Pt. Std. Metric	19.5	19.5	24.5	5.6	14.5	11.5	27
80137	15 mm	6 Pt. Std. Metric	20.8	20.8	24.5	5.6	14.5	11.5	30
80104D	5/32"	6 Pt. Std. SAE	11.8	6.9	24.5	3.4	7.5	11.5	10
80105	3/16"	6 Pt. Std. SAE	11.8	7.8	24.5	4.0	8.0	11.5	10
80106	7/32"	6 Pt. Std. SAE	11.8	8.5	24.5	4.0	8.0	11.5	10
80107	1/4"	6 Pt. Std. SAE	11.8	9.5	24.5	4.0	9.0	11.5	10
80108	9/32"	6 Pt. Std. SAE	11.8	10.7	24.5	5.6	9.0	11.5	10
80109	5/16"	6 Pt. Std. SAE	11.8	11.5	24.5	5.6	10.5	11.5	12
80110	11/32"	6 Pt. Std. SAE	12.5	12.5	24.5	5.6	10.5	11.5	15
80111	3/8"	6 Pt. Std. SAE	13.8	13.8	24.5	5.6	12.5	11.5	20
80112	7/16"	6 Pt. Std. SAE	15.7	15.7	24.5	5.6	12.5	11.5	20
80113D	1/2"	6 Pt. Std. SAE	17.3	17.3	24.5	5.6	12.5	11.5	25
80114D	9/16"	6 Pt. Std. SAE	19.5	19.5	24.5	5.6	14.5	11.5	27

1/4" OPEN STOCK
RATCHETS, SOCKETS & DRIVE TOOLS

1/4" OPEN STOCK



6 & 12 Pt. Deep Socket METRIC/SAE 1/4" DRIVE

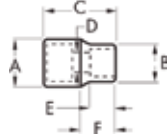

RATCHETS, SOCKETS & DRIVE TOOLS

Material No.	Size	Description	Drive End	Wrench	Overall	Bolt	Wrench	Length to	Weight (g)	
			(mm)	End (mm)	Length (mm)	Clearance	Depth (mm)	Shoulder		
			A	B	C	D	E	F		
80138	4 mm	6 Pt. Deep Metric	11.9	6.7	49.0	3.5	3.0	22.0	18	
80139	5 mm	6 Pt. Deep Metric	11.9	8.0	49.0	4.5	3.5	22.0	18	
80140	5.5 mm	6 Pt. Deep Metric	11.9	8.6	49.0	5.0	3.5	22.0	18	
80141	6 mm	6 Pt. Deep Metric	11.9	9.2	49.0	5.5	4.0	22.0	21	
80142	7 mm	6 Pt. Deep Metric	11.9	10.8	49.0	5.5	5.0	22.0	25	
80143	8 mm	6 Pt. Deep Metric	11.9	11.5	49.0	5.5	5.0	22.0	25	
80144	9 mm	6 Pt. Deep Metric	13.1	13.1	49.0	5.5	5.0	22.0	32	
80145	10 mm	6 Pt. Deep Metric	14.6	14.6	49.0	5.5	5.5	22.0	38	
80146D	11 mm	6 Pt. Deep Metric	15.9	15.9	49.0	5.5	6.5	22.0	48	
80147	12 mm	6 Pt. Deep Metric	16.9	16.9	49.0	5.5	6.5	22.0	50	
80148	13 mm	6 Pt. Deep Metric	17.9	17.9	49.0	5.5	7.7	22.0	55	
80149	14 mm	6 Pt. Deep Metric	19.6	19.6	49.0	5.5	8.9	22.0	60	
80150	15 mm	6 Pt. Deep Metric	20.8	20.8	49.0	5.5	8.9	22.0	70	
80115	3/16"	6 Pt. Deep SAE	11.9	7.8	49.0	4.5	3.5	22.0	18	
80116D	7/32"	6 Pt. Deep SAE	11.9	8.8	49.0	5.0	3.5	22.0	20	
80117	1/4"	6 Pt. Deep SAE	11.9	9.9	49.0	5.5	4.0	22.0	21	
80118	9/32"	6 Pt. Deep SAE	11.9	11.0	49.0	5.5	5.0	22.0	21	
80119	5/16"	6 Pt. Deep SAE	11.9	11.5	49.0	5.5	5.0	22.0	21	
80120D	11/32"	6 Pt. Deep SAE	13.1	13.1	49.0	5.5	5.0	22.0	29	
80121	3/8"	6 Pt. Deep SAE	14.6	14.6	49.0	5.5	5.1	22.0	40	
80122D	7/16"	6 Pt. Deep SAE	15.9	15.9	49.0	5.5	6.0	22.0	46	
80123	1/2"	6 Pt. Deep SAE	17.9	17.9	49.0	5.5	7.3	22.0	58	
80124	9/16"	6 Pt. Deep SAE	19.6	19.6	49.0	5.5	8.9	22.0	60	

3/8" DRIVE SETS

80550 - 57 Pc. SAE/METRIC 6 Pt. Standard & Deep Socket Set 3/8" DRIVE

Material No.	Description			
80350	1/4"	6 Pt.	Std. SAE Socket	3/8" Dr.
80351	5/16"	6 Pt.	Std. SAE Socket	3/8" Dr.
80352	3/8"	6 Pt.	Std. SAE Socket	3/8" Dr.
80353	7/16"	6 Pt.	Std. SAE Socket	3/8" Dr.
80354	1/2"	6 Pt.	Std. SAE Socket	3/8" Dr.
80355	9/16"	6 Pt.	Std. SAE Socket	3/8" Dr.
80356	5/8"	6 Pt.	Std. SAE Socket	3/8" Dr.
80357	11/16"	6 Pt.	Std. SAE Socket	3/8" Dr.
80358	3/4"	6 Pt.	Std. Metric Socket	3/8" Dr.
80359	13/16"	6 Pt.	Std. SAE Socket	3/8" Dr.
80360	7/8"	6 Pt.	Std. SAE Socket	3/8" Dr.
80361	15/16"	6 Pt.	Std. SAE Socket	3/8" Dr.
80362	1"	6 Pt.	Std. SAE Socket	3/8" Dr.
80363	1/4"	6 Pt.	Deep SAE Socket	3/8" Dr.
80364	5/16"	6 Pt.	Deep SAE Socket	3/8" Dr.
80365	3/8"	6 Pt.	Deep SAE Socket	3/8" Dr.
80366	1/4"	6 Pt.	Deep SAE Socket	3/8" Dr.
80367	7/16"	6 Pt.	Deep SAE Socket	3/8" Dr.
80368	1/2"	6 Pt.	Deep SAE Socket	3/8" Dr.
80369	9/16"	6 Pt.	Deep SAE Socket	3/8" Dr.
80370	5/8"	6 Pt.	Deep SAE Socket	3/8" Dr.
80371	11/16"	6 Pt.	Deep SAE Socket	3/8" Dr.
80372	3/4"	6 Pt.	Deep SAE Socket	3/8" Dr.
80373	7/8"	6 Pt.	Deep SAE Socket	3/8" Dr.
80374	6 mm	6 Pt.	Std. Metric Socket	3/8" Dr.
80375	7 mm	6 Pt.	Std. Metric Socket	3/8" Dr.
80376	8 mm	6 Pt.	Std. Metric Socket	3/8" Dr.
80377	9 mm	6 Pt.	Std. Metric Socket	3/8" Dr.
80378	10 mm	6 Pt.	Std. SAE Socket	3/8" Dr.
80379	11 mm	6 Pt.	Std. Metric Socket	3/8" Dr.
80380	12 mm	6 Pt.	Std. Metric Socket	3/8" Dr.
80381	13 mm	6 Pt.	Std. Metric Socket	3/8" Dr.
80382	14 mm	6 Pt.	Std. Metric Socket	3/8" Dr.
80383	15 mm	6 Pt.	Std. Metric Socket	3/8" Dr.
80384	16 mm	6 Pt.	Std. Metric Socket	3/8" Dr.



Material No.	Description			
80385	17 mm	6 Pt.	Std. Metric Socket	3/8" Dr.
80386	18 mm	6 Pt.	Std. Metric Socket	3/8" Dr.
80387	19 mm	6 Pt.	Std. Metric Socket	3/8" Dr.
80388	6 mm	6 Pt.	Deep Metric Socket	3/8" Dr.
80389	7 mm	6 Pt.	Deep Metric Socket	3/8" Dr.
80390	8 mm	6 Pt.	Deep Metric Socket	3/8" Dr.
80391	9 mm	6 Pt.	Deep Metric Socket	3/8" Dr.
80392	10 mm	6 Pt.	Deep Metric Socket	3/8" Dr.
80393	11 mm	6 Pt.	Deep Metric Socket	3/8" Dr.
80394	12 mm	6 Pt.	Deep Metric Socket	3/8" Dr.
80395	13 mm	6 Pt.	Deep Metric Socket	3/8" Dr.
80396	14 mm	6 Pt.	Deep Metric Socket	3/8" Dr.
80397	15 mm	6 Pt.	Deep Metric Socket	3/8" Dr.
80398	16 mm	6 Pt.	Deep Metric Socket	3/8" Dr.
80399	17 mm	6 Pt.	Deep Metric Socket	3/8" Dr.
80400	18 mm	6 Pt.	Deep Metric Socket	3/8" Dr.
80401	19 mm	6 Pt.	Deep Metric Socket	3/8" Dr.
81241	3" Extension			3/8" Dr.
81242	6" Extension			3/8" Dr.
80549	Universal Joint			3/8" Dr.
81209	Full Polish Stubby Teardrop Ratchet			3/8" Dr.
81211	Full Polish Teardrop Ratchet			3/8" Dr.
80550BM	Replacement Blow Mold Case			

**3/8" DRIVESETS
RATCHETS, SOCKETS & DRIVE TOOLS**

3/8" DRIVE SETS



80551 - 57 Pc. SAE/METRIC 12 Pt. Standard & Deep Socket Set 3/8" DRIVE

RATCHETS, SOCKETS & DRIVE TOOLS
3/8" DRIVE SETS

Material No.	Description			
80496	1/4"	12 Pt. Std. SAE Socket		3/8" Dr.
80497D	5/16"	12 Pt. Std. SAE Socket		3/8" Dr.
80498	3/8"	12 Pt. Std. SAE Socket		3/8" Dr.
80499	7/16"	12 Pt. Std. SAE Socket		3/8" Dr.
80500	1/2"	12 Pt. Std. SAE Socket		3/8" Dr.
80501	9/16"	12 Pt. Std. SAE Socket		3/8" Dr.
80502	5/8"	12 Pt. Std. SAE Socket		3/8" Dr.
80503	11/16"	12 Pt. Std. SAE Socket		3/8" Dr.
80504	3/4"	12 Pt. Std. SAE Socket		3/8" Dr.
80505	13/16"	12 Pt. Std. SAE Socket		3/8" Dr.
80506	7/8"	12 Pt. Std. SAE Socket		3/8" Dr.
80507	15/16"	12 Pt. Std. SAE Socket		3/8" Dr.
80508	1"	12 Pt. Std. SAE Socket		3/8" Dr.
80509	1/4"	12 Pt. Deep SAE Socket		3/8" Dr.
80510	5/16"	12 Pt. Deep SAE Socket		3/8" Dr.
80511	3/8"	12 Pt. Deep SAE Socket		3/8" Dr.
80512	1/4"	12 Pt. Deep SAE Socket		3/8" Dr.
80513	7/16"	12 Pt. Deep SAE Socket		3/8" Dr.
80514	1/2"	12 Pt. Deep SAE Socket		3/8" Dr.
80515	9/16"	12 Pt. Deep SAE Socket		3/8" Dr.
80516	5/8"	12 Pt. Deep SAE Socket		3/8" Dr.
80517	11/16"	12 Pt. Deep SAE Socket		3/8" Dr.
80518	3/4"	12 Pt. Deep SAE Socket		3/8" Dr.

Material No.	Description			
80519	7/8"	12 Pt. Deep SAE Socket		3/8" Dr.
80482	6 mm	12 Pt. Std. Metric Socket		3/8" Dr.
80483	7 mm	12 Pt. Std. Metric Socket		3/8" Dr.
80484	8 mm	12 Pt. Std. Metric Socket		3/8" Dr.
80485	9 mm	12 Pt. Std. Metric Socket		3/8" Dr.
80486	10 mm	12 Pt. Std. Metric Socket		3/8" Dr.
80487	11 mm	12 Pt. Std. Metric Socket		3/8" Dr.
80488	12 mm	12 Pt. Std. Metric Socket		3/8" Dr.
80489	13 mm	12 Pt. Std. Metric Socket		3/8" Dr.
80490	14 mm	12 Pt. Std. Metric Socket		3/8" Dr.
80491	15 mm	12 Pt. Std. Metric Socket		3/8" Dr.
80492	16 mm	12 Pt. Std. Metric Socket		3/8" Dr.
80493	17 mm	12 Pt. Std. Metric Socket		3/8" Dr.
80494	18 mm	12 Pt. Std. Metric Socket		3/8" Dr.
80495	19 mm	12 Pt. Std. Metric Socket		3/8" Dr.
80520	6 mm	12 Pt. Deep Metric Socket		3/8" Dr.
80521	7 mm	12 Pt. Deep Metric Socket		3/8" Dr.
80522	8 mm	12 Pt. Deep Metric Socket		3/8" Dr.
80523	9 mm	12 Pt. Deep Metric Socket		3/8" Dr.
80524	10 mm	12 Pt. Deep Metric Socket		3/8" Dr.
80525	11 mm	12 Pt. Deep Metric Socket		3/8" Dr.
80526	12 mm	12 Pt. Deep Metric Socket		3/8" Dr.
80527	13 mm	12 Pt. Deep Metric Socket		3/8" Dr.
80528	14 mm	12 Pt. Deep Metric Socket		3/8" Dr.
80529	15 mm	12 Pt. Deep Metric Socket		3/8" Dr.
80530	16 mm	12 Pt. Deep Metric Socket		3/8" Dr.
80531	17 mm	12 Pt. Deep Metric Socket		3/8" Dr.
80532	18 mm	12 Pt. Deep Metric Socket		3/8" Dr.
80533	19 mm	12 Pt. Deep Metric Socket		3/8" Dr.
81241	3" Extension			3/8" Dr.
81242	6" Extension			3/8" Dr.
80549	Universal Joint			3/8" Dr.
81209	Full Polish Stubby Teardrop Ratchet			3/8" Dr.
81211	Full Polish Teardrop Ratchet			3/8" Dr.
80550BM	Replacement Blow Mold Case			

3/8" DRIVE SETS

80559 - 24 Pc. METRIC 6 Pt. & 12 Pt. Standard & Deep Socket Set 3/8" DRIVE

Material No.	Description
80392	10 mm 6 Pt. Deep Metric Socket 3/8" Dr.
80393	11 mm 6 Pt. Deep Metric Socket 3/8" Dr.
80394	12 mm 6 Pt. Deep Metric Socket 3/8" Dr.
80395	13 mm 6 Pt. Std. Metric Socket 3/8" Dr.
80396	14 mm 6 Pt. Std. Metric Socket 3/8" Dr.
80397	15 mm 6 Pt. Deep Metric Socket 3/8" Dr.
80398	16 mm 6 Pt. Deep Metric Socket 3/8" Dr.
80399	17 mm 6 Pt. Deep Metric Socket 3/8" Dr.
80400	18 mm 6 Pt. Deep Metric Socket 3/8" Dr.
80484	8 mm 12 Pt. Std. Metric Socket 3/8" Dr.
80485	9 mm 12 Pt. Std. Metric Socket 3/8" Dr.
80486	10 mm 12 Pt. Std. Metric Socket 3/8" Dr.
80487	11 mm 12 Pt. Std. Metric Socket 3/8" Dr.
80488	12 mm 12 Pt. Std. Metric Socket 3/8" Dr.
80489	13 mm 12 Pt. Std. Metric Socket 3/8" Dr.
80490	14 mm 12 Pt. Std. Metric Socket 3/8" Dr.
80491	15 mm 12 Pt. Deep Metric Socket 3/8" Dr.
80492	16 mm 12 Pt. Std. Metric Socket 3/8" Dr.



Material No.	Description
80493	17 mm 12 Pt. Std. Metric Socket 3/8" Dr.
80494	18 mm 12 Pt. Std. Metric Socket 3/8" Dr.
80495	19 mm 12 Pt. Std. Metric Socket 3/8" Dr.
81241	3" Extension 3/8" Dr.
81242	6" Extension 3/8" Dr.
81211	Full Polish Teardrop Ratchet 3/8" Dr.

80557 - 21 Pc. SAE 6 Pt. & 12 Pt. Standard & Deep Socket Set 3/8" DRIVE

Material No.	Description
80365	3/8" 6 Pt. Deep SAE Socket 3/8" Dr.
80366	1/4" 6 Pt. Deep SAE Socket 3/8" Dr.
80367	7/16" 6 Pt. Std. SAE Socket 3/8" Dr.
80368	1/2" 6 Pt. Deep SAE Socket 3/8" Dr.
80369	9/16" 6 Pt. Deep SAE Socket 3/8" Dr.
80370	5/8" 6 Pt. Deep SAE Socket 3/8" Dr.
80371	11/16" 6 Pt. Deep SAE Socket 3/8" Dr.
80372	3/4" 6 Pt. Deep SAE Socket 3/8" Dr.
80373	7/8" 6 Pt. Deep SAE Socket 3/8" Dr.
80496	1/4" 12 Pt. Std. SAE Socket 3/8" Dr.
80497	5/16" 12 Pt. Std. SAE Socket 3/8" Dr.
80498	3/8" 12 Pt. Std. SAE Socket 3/8" Dr.
80499	7/16" 12 Pt. Std. SAE Socket 3/8" Dr.
80500	1/2" 12 Pt. Std. SAE Socket 3/8" Dr.
80501	9/16" 12 Pt. Std. SAE Socket 3/8" Dr.
80502	5/8" 12 Pt. Std. SAE Socket 3/8" Dr.



Material No.	Description
80503	11/16" 12 Pt. Std. SAE Socket 3/8" Dr.
80504	3/4" 12 Pt. Std. SAE Socket 3/8" Dr.
81241	3" Extension 3/8" Dr.
81242	6" Extension 3/8" Dr.
81211	Full Polish Teardrop Ratchet 3/8" Dr.

83057 - 42 Pc. Socket Set METRIC/SAE 3/8" DRIVE

Description

3/8" Drive 6pt. Deep Sockets: 8mm, 10mm, 11mm, 12mm, 13mm, 15mm

3/8" Drive 12pt. Sockets: 1/4", 5/16", 3/8", 7/16", 1/2", 9/16", 5/8", 11/16", 3/4", 13/16", 7/8", 15/16", 1"

3/8" Drive 12pt Sockets: 8mm, 9mm, 10mm, 11mm, 12mm, 13mm, 14mm, 15mm, 16mm, 17mm, 18mm, 19mm, 20mm, 21mm, 22mm

3/8" Drive Full Polish Teardrop Ratchet: 12" Full Polish Flex Handle; Universal Joint; 3" Extension Bar; 6" Extension Bar; 10" Extension Bar; Spark Plug Socket 5/8", Spark Plug Socket 13/16"

Metal Case with EVA Tray Insert: 250mm x 424mm



**3/8" DRIVESETS
RATCHETS, SOCKETS & DRIVE TOOLS**

3/8" DRIVE SETS



80560 - 14 Pc. METRIC 12 Pt. Standard Socket Set 3/8" DRIVE

Material No.	Description						
80482	6 mm	12 Pt. Std. Metric Socket	3/8" Dr.	80489	13 mm	12 Pt. Std. Metric Socket	3/8" Dr.
80483	7 mm	12 Pt. Std. Metric Socket	3/8" Dr.	80490	14 mm	12 Pt. Std. Metric Socket	3/8" Dr.
80484	8 mm	12 Pt. Std. Metric Socket	3/8" Dr.	80491	15 mm	12 Pt. Std. Metric Socket	3/8" Dr.
80485	9 mm	12 Pt. Std. Metric Socket	3/8" Dr.	80492	16 mm	12 Pt. Std. Metric Socket	3/8" Dr.
80486	10 mm	12 Pt. Std. Metric Socket	3/8" Dr.	80493	17 mm	12 Pt. Std. Metric Socket	3/8" Dr.
80487	11 mm	12 Pt. Std. Metric Socket	3/8" Dr.	80494	18 mm	12 Pt. Std. Metric Socket	3/8" Dr.
80488	12 mm	12 Pt. Std. Metric Socket	3/8" Dr.	80495	19 mm	12 Pt. Std. Metric Socket	3/8" Dr.



80561 - 13 Pc. SAE 12 Pt. Standard Socket Set 3/8" DRIVE

Material No.	Description						
80496	1/4"	12 Pt. Std. SAE Socket	3/8" Dr.	80503	11/16"	12 Pt. Std. SAE Socket	3/8" Dr.
80497D	5/16"	12 Pt. Std. SAE Socket	3/8" Dr.	80504	3/4"	12 Pt. Std. SAE Socket	3/8" Dr.
80498	3/8"	12 Pt. Std. SAE Socket	3/8" Dr.	80505	13/16"	12 Pt. Std. SAE Socket	3/8" Dr.
80499	7/16"	12 Pt. Std. SAE Socket	3/8" Dr.	80506	7/8"	12 Pt. Std. SAE Socket	3/8" Dr.
80500	1/2"	12 Pt. Std. SAE Socket	3/8" Dr.	80507	15/16"	12 Pt. Std. SAE Socket	3/8" Dr.
80501	9/16"	12 Pt. Std. SAE Socket	3/8" Dr.	80508	1"	12 Pt. Std. SAE Socket	3/8" Dr.
80502	5/8"	12 Pt. Std. SAE Socket	3/8" Dr.				



80554 - 14 Pc. METRIC 6 Pt. Deep Socket Set 3/8" DRIVE

Material No.	Description						
80388	6 mm	6 Pt. Deep Metric Socket	3/8" Dr.	80395	13 mm	6 Pt. Deep Metric Socket	3/8" Dr.
80389	7 mm	6 Pt. Deep Metric Socket	3/8" Dr.	80396	14 mm	6 Pt. Deep Metric Socket	3/8" Dr.
80390	8 mm	6 Pt. Deep Metric Socket	3/8" Dr.	80397	15 mm	6 Pt. Deep Metric Socket	3/8" Dr.
80391	9 mm	6 Pt. Deep Metric Socket	3/8" Dr.	80398	16 mm	6 Pt. Deep Metric Socket	3/8" Dr.
80392	10 mm	6 Pt. Deep Metric Socket	3/8" Dr.	80399	17 mm	6 Pt. Deep Metric Socket	3/8" Dr.
80393	11 mm	6 Pt. Deep Metric Socket	3/8" Dr.	80400	18 mm	6 Pt. Deep Metric Socket	3/8" Dr.
80394	12 mm	6 Pt. Deep Metric Socket	3/8" Dr.	80401	19 mm	6 Pt. Deep Metric Socket	3/8" Dr.

RATCHETS, SOCKETS & DRIVE TOOLS 3/8" DRIVE SETS

3/8" DRIVE SETS

**80555 - 11 Pc. SAE 6 Pt. Deep Socket Set
3/8" DRIVE**



Material No.	Description			
80363	1/4"	6 Pt.	Deep SAE Socket	3/8" Dr.
80364	5/16"	6 Pt.	Deep SAE Socket	3/8" Dr.
80365	3/8"	6 Pt.	Deep SAE Socket	3/8" Dr.
80366	1/4"	6 Pt.	Deep SAE Socket	3/8" Dr.
80367	7/16"	6 Pt.	Deep SAE Socket	3/8" Dr.
80368	1/2"	6 Pt.	Deep SAE Socket	3/8" Dr.

80369	9/16"	6 Pt.	Deep SAE Socket	3/8" Dr.
80370	5/8"	6 Pt.	Deep SAE Socket	3/8" Dr.
80371	1 1/16"	6 Pt.	Deep SAE Socket	3/8" Dr.
80372	3/4"	6 Pt.	Deep SAE Socket	3/8" Dr.
80373	7/8"	6 Pt.	Deep SAE Socket	3/8" Dr.

**80565 - 10 Pc. METRIC 6 Pt. Flex Socket Set
3/8" DRIVE**



Material No.	Description			
80333	10 mm	6 Pt.	Flex Metric Socket	3/8" Dr.
80334	11 mm	6 Pt.	Flex Metric Socket	3/8" Dr.
80335	12 mm	6 Pt.	Flex Metric Socket	3/8" Dr.
80336	13 mm	6 Pt.	Flex Metric Socket	3/8" Dr.
80337	14 mm	6 Pt.	Flex Metric Socket	3/8" Dr.
80338	15 mm	6 Pt.	Flex Metric Socket	3/8" Dr.
80339	16 mm	6 Pt.	Flex Metric Socket	3/8" Dr.
80340	17 mm	6 Pt.	Flex Metric Socket	3/8" Dr.
80341	18 mm	6 Pt.	Flex Metric Socket	3/8" Dr.
80342	19 mm	6 Pt.	Flex Metric Socket	3/8" Dr.

**80564 - 7 Pc. SAE 6 Pt. Flex Socket Set
3/8" DRIVE**



Material No.	Description			
80343	3/8"	6 Pt.	Flex SAE Socket	3/8" Dr.
80344	7/16"	6 Pt.	Flex SAE Socket	3/8" Dr.
80345	1/2"	6 Pt.	Flex SAE Socket	3/8" Dr.
80346	9/16"	6 Pt.	Flex SAE Socket	3/8" Dr.
80347	5/8"	6 Pt.	Flex SAE Socket	3/8" Dr.
80348	1 1/16"	6 Pt.	Flex SAE Socket	3/8" Dr.
80349	3/4"	6 Pt.	Flex SAE Socket	3/8" Dr.

**3/8" DRIVESETS
RATCHETS, SOCKETS & DRIVE TOOLS**

3/8" DRIVE OPEN STOCK

RATCHETS, SOCKETS & DRIVE TOOLS

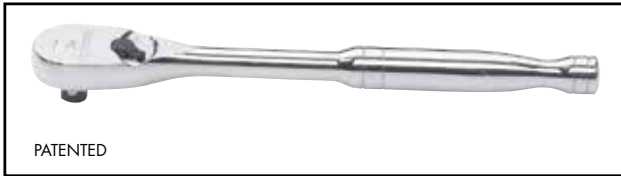

PATENTED

Full Polish Teardrop Ratchet 3/8" DRIVE

Material No.	Description	Overall Length (mm)	Wt (g)
81211F	Full Polish Teardrop Ratchet	213	308

- 60 tooth low profile ratchet

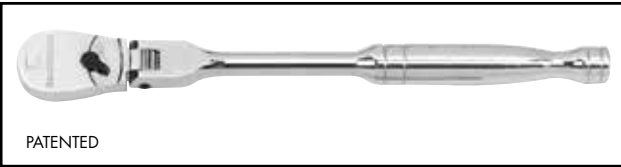

PATENTED

Full Polish Flex Teardrop Ratchet 3/8" DRIVE

Material No.	Description	Overall Length (mm)	Weight (g)
81215	Full Polish Flex Teardrop Ratchet	330	386

- 60 tooth low profile ratchet

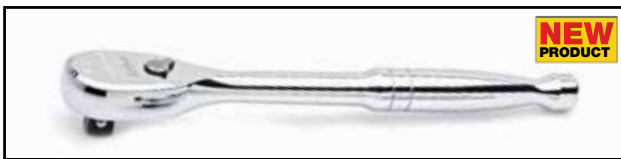

NEW PRODUCT

120XP Full Polish Teardrop Ratchet 3/8" DRIVE

Material No.	Description	Overall Length (mm)	Wt (g)
81211P	Full Polish Teardrop Ratchet	276	358

- 120 positions
- 3 degree ratcheting arc



NEW PRODUCT

120XP Flex Head Full Polish Teardrop Ratchet 3/8" DRIVE

Material No.	Description	Overall Length (mm)	Wt (g)
81215P	Full Polish Flex Teardrop Ratchet	213	450

- 120 positions
- 3 degree ratcheting arc

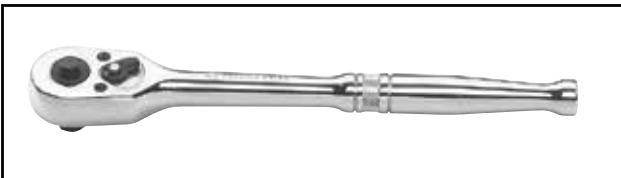

Quick-Release Teardrop Ratchet 3/8" DRIVE

Material No.	Description	Overall Length (mm)	Wt (g)
81218	Quick-Release Teardrop Ratchet	199.9	250

- 45 tooth standard ratchet



Full Polish Stubby Teardrop Ratchet 3/8" DRIVE

Material No.	Description	Overall Length (mm)	Wt (g)
81209F	Full Polish Stubby Teardrop Ratchet	120	186

- 60 tooth low profile ratchet



PATENTED

Full Polish Stubby Flex Teardrop Ratchet 3/8" DRIVE

Material No.	Description	Overall Length (mm)	Wt (g)
81212	Full Polish Stubby Flex Teardrop Ratchet	127.5	236

- 60 tooth low profile ratchet



Cushion Grip Teardrop Ratchet 3/8" DRIVE

Material No.	Description	Overall Length (mm)	Wt (g)
81208F	Cushion Grip Teardrop Ratchet	229	290

- 60 tooth low profile ratchet

3/8" DRIVE OPEN STOCK

Cushion Grip Flex Teardrop Ratchet 3/8" DRIVE

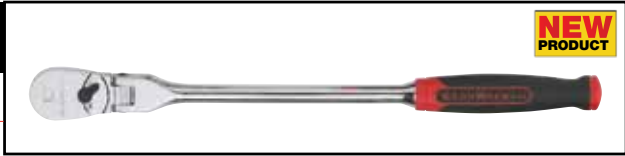

Material No.	Description	Overall Length (mm)	Wt (g)
81210	Cushion Grip Flex Teardrop Ratchet	13.13"	426

- 60 tooth low profile ratchet

Cushion Grip Offset Flex Teardrop Ratchet 3/8" DRIVE



Material No.	Description	Overall Length (mm)	Weight (g)
81213F	Cushion Grip Offset Flex Teardrop Ratchet	311	450

- 60 tooth low profile ratchet

Cushion Grip Roto Ratchet 3/8" DRIVE



Material No.	Description	Overall Length (mm)	Weight (g)
81225	Cushion Grip Roto Ratchet	250	345

- 72 tooth ratchet

Ratchet Repair Kit 3/8" DRIVE

Material No.	Description
81227	Ratchet Repair Kit

- for non-quick release and non-roto ratchets

Full Polish Flex Handle 3/8" DRIVE



Material No.	Description	Overall Length (mm)	Weight (g)
81221	Full Polish Flex Handle	305	181

Thumbwheel Ratchet 3/8" DRIVE



Material No.	Description	Weight (g)
81226	Thumbwheel Ratchet	50

Universal Joint 3/8" DRIVE



Material No.	Description	Weight (g)
80549	Universal Joint	60

Spring Universal Joint 3/8" DRIVE



Material No.	Description	Weight (g)
81233	Spring Universal Joint	73

3/8" OPEN STOCK
RATCHETS, SOCKETS & DRIVE TOOLS

3/8" DRIVE OPEN STOCK

RATCHETS, SOCKETS & DRIVE TOOLS

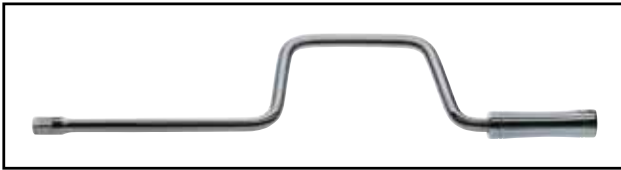

Speeder Handle 3/8" DRIVE

Material No.	Description	Weight (g)
81239	Speeder Handle	499



Standard Extension 3/8" DRIVE

Material No.	Description mm/in	Weight (g)
81240	38mm/1-1/2" Standard Extension	40
81241	76mm/3" Standard Extension	70
81242	152mm/6" Standard Extension	150
81243	254mm/10" Standard Extension	240
81244	305mm/12" Standard Extension	280



Wobble Extensions 3/8" DRIVE

Material No.	Description mm/in	Weight (g)
81246	76mm/3" Extension	70
81247	152mm/6" Extension	150
81248	254mm/10" Extension	240
81249	305mm/12" Extension	280



81202 - Locking Extension Set 3/8" DRIVE

Material No.	Description mm/in	Weight (g)
81250	76mm/ 3" Locking Extension	70
81251	152mm/ 6" Locking Extension	150
81272	254mm/10" Locking Extension	240



Adapter 3/8" DRIVE

Material No.	Description	Weight (g)
81277	Adapter 3/8"F X 1/4"M	7
81278	Adapter 3/8"F X 1/2"M	21



Spark Plug Socket SAE 3/8" DRIVE

Material No.	Description	Weight (g)
80402	5/8" Spark Plug	43
80403	13/16" Spark Plug	75

3/8" OPEN STOCK

6 Pt. & 12 Pt. Standard Socket METRIC/SAE 3/8" DRIVE

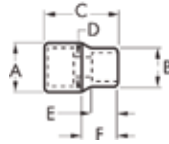

Material No.	Size	Description	Drive End (mm) A	Wrench End (mm) B	Overall Length (mm) C	Bolt Clearance D	Wrench Depth (mm) E	Length to Shoulder F	Weight (g)
80482	6 mm	12 Pt. Std. Metric	17.0	9.3	25.0	5.0	7.5	11.5	18
80483	7 mm	12 Pt. Std. Metric	17.0	10.8	25.0	5.0	7.5	11.5	18
80484	8 mm	12 Pt. Std. Metric	17.0	12.0	25.0	7.2	7.5	11.5	20
80485	9 mm	12 Pt. Std. Metric	17.0	12.9	25.0	7.2	7.5	11.5	20
80486	10 mm	12 Pt. Std. Metric	17.0	14.5	25.0	7.2	7.5	11.5	20
80487	11 mm	12 Pt. Std. Metric	17.0	15.8	25.0	9.0	7.5	11.5	20
80488	12 mm	12 Pt. Std. Metric	17.0	16.7	25.0	9.0	8.0	11.5	21
80489	13 mm	12 Pt. Std. Metric	18.9	17.7	25.0	9.0	8.0	11.5	27
80490	14 mm	12 Pt. Std. Metric	19.5	19.6	25.0	9.0	12.5	11.5	27
80491	15 mm	12 Pt. Std. Metric	20.8	20.8	25.0	9.0	12.5	11.5	32
80492	16 mm	12 Pt. Std. Metric	22.0	22.0	25.0	9.0	12.5	11.5	38
80493	17 mm	12 Pt. Std. Metric	23.3	23.3	25.0	9.0	12.5	11.5	43
80494	18 mm	12 Pt. Std. Metric	23.8	23.8	25.0	9.0	12.5	11.5	43
80495	19 mm	12 Pt. Std. Metric	24.3	25.5	25.0	9.0	12.5	11.5	55
80596	20 mm	12 Pt. Std. Metric	25.8	27.0	28.0	9.0	15.0	11.5	59
80597	21 mm	12 Pt. Std. Metric	26.7	27.9	28.0	9.0	15.0	11.5	64
80598	22 mm	12 Pt. Std. Metric	28.3	29.5	28.0	9.0	15.0	11.5	68
80496	1/4"	12 Pt. Std. SAE	17.2	10.0	25.0	5.0	7.5	11.5	20
80497D	5/16"	12 Pt. Std. SAE	17.0	11.8	25.0	7.2	7.5	11.5	20
80498	3/8"	12 Pt. Std. SAE	17.0	13.8	25.0	7.2	7.5	11.5	21
80499	7/16"	12 Pt. Std. SAE	17.0	16.0	25.0	9.0	7.5	11.5	21
80500D	1/2"	12 Pt. Std. SAE	17.9	17.4	25.0	9.0	7.5	11.5	25
80501	9/16"	12 Pt. Std. SAE	19.7	19.7	25.0	9.0	12.5	11.5	30
80502	5/8"	12 Pt. Std. SAE	22.2	22.2	25.0	9.0	12.5	11.5	40
80503	11/16"	12 Pt. Std. SAE	23.9	23.9	25.0	9.0	12.5	11.5	48
80504	3/4"	12 Pt. Std. SAE	25.9	25.9	25.0	9.0	12.5	11.5	55
80505	13/16"	12 Pt. Std. SAE	27.9	27.9	28.0	9.0	15.0	11.5	72
80506D	7/8"	12 Pt. Std. SAE	29.7	29.7	28.0	9.0	15.0	11.5	72
80507	15/16"	12 Pt. Std. SAE	32.0	32.0	29.5	9.0	15.0	11.5	72
80508	1"	12 Pt. Std. SAE	33.9	33.9	33.5	9.0	18.0	11.5	73

3/8" OPEN STOCK RATCHETS, SOCKETS & DRIVE TOOLS

3/8" OPEN STOCK



6 Pt. & 12 Pt. Deep Socket METRIC/SAE 3/8" DRIVE

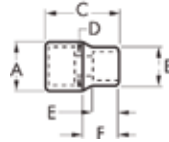

Material No.	Size	Description	Drive End (mm) A	Wrench End (mm) B	Overall Length (mm) C	Bolt Clearance D	Wrench Depth (mm) E	Length to Shoulder F	Weight (g)
80388	6 mm	6 Pt. Deep Metric	16.8	13.0	63.5	8.0	5.0	29.0	24
80389	7 mm	6 Pt. Deep Metric	16.8	13.0	63.5	8.0	5.0	29.0	24
80390	8 mm	6 Pt. Deep Metric	16.8	13.0	63.5	8.0	5.0	29.0	24
80391	9 mm	6 Pt. Deep Metric	16.8	13.0	63.5	8.0	5.0	29.0	24
80392	10 mm	6 Pt. Deep Metric	16.8	14.5	63.5	8.6	5.1	29.0	26
80393D	11 mm	6 Pt. Deep Metric	16.8	15.8	63.5	8.6	6.0	29.0	27
80394D	12 mm	6 Pt. Deep Metric	16.8	16.7	63.5	8.6	6.6	29.0	30
80395	13 mm	6 Pt. Deep Metric	18.8	17.7	63.5	8.6	7.3	29.0	34
80396	14 mm	6 Pt. Deep Metric	19.5	19.5	63.5	8.6	8.9	29.0	37
80397	15 mm	6 Pt. Deep Metric	20.8	20.8	63.5	8.6	8.9	29.0	42
80398	16 mm	6 Pt. Deep Metric	22.0	22.0	63.5	8.6	10.1	29.0	46
80399	17 mm	6 Pt. Deep Metric	23.8	23.8	63.5	8.6	10.1	29.0	54
80400	18 mm	6 Pt. Deep Metric	23.8	23.8	63.5	8.6	10.7	29.0	57
80401	19 mm	6 Pt. Deep Metric	25.5	25.5	63.5	8.6	11.6	29.0	64
80406	20 mm	6 Pt. Deep Metric	25.8	27.0	63.5	8.6	12.2	29.0	68
80407	21 mm	6 Pt. Deep Metric	26.6	27.8	63.5	8.6	12.2	29.0	73
80408	22 mm	6 Pt. Deep Metric	28.3	29.5	63.5	8.6	13.2	29.0	77
80409	24 mm	6 Pt. Deep Metric	30.6	31.8	63.5	8.6	14.4	29.0	82
80363	1/4"	6 Pt. Deep SAE	16.8	10.0	63.5	5.6	2.4	29.0	24
80364	5/16"	6 Pt. Deep SAE	16.8	11.7	63.5	7.1	5.0	29.0	25
80365	3/8"	6 Pt. Deep SAE	16.8	13.8	63.5	8.6	5.1	29.0	27
80366	7/16"	6 Pt. Deep SAE	16.8	16.0	63.5	8.6	6.0	29.0	27
80367	1/2"	6 Pt. Deep SAE	18.3	17.4	63.5	8.6	7.3	29.0	29
80368	9/16"	6 Pt. Deep SAE	19.9	19.9	63.5	8.6	8.9	29.0	39
80369	5/8"	6 Pt. Deep SAE	22.0	22.0	63.5	8.6	10.1	29.0	49
80370D	11/16"	6 Pt. Deep SAE	23.8	23.8	63.5	8.6	10.1	29.0	58
80371	3/4"	6 Pt. Deep SAE	25.8	25.8	63.5	8.6	11.6	29.0	67
80372	13/16"	6 Pt. Deep SAE	27.8	27.8	63.5	8.6	12.2	29.0	75
80373	7/8"	6 Pt. Deep SAE	29.8	29.8	63.5	8.6	13.2	29.0	89
80592	15/16"	6 Pt. Deep SAE	30.6	31.8	63.5	8.6	14.4	29.0	72
80593	1"	6 Pt. Deep SAE	32.3	33.5	63.5	8.6	14.4	29.0	72

RATCHETS, SOCKETS & DRIVE TOOLS 3/8" OPEN STOCK

1/2" DRIVE SETS

80701 - 49 Pc. SAE/METRIC 12 Pt. Standard & Deep Socket Set 1/2" DRIVE

Material No.	Description			
80760	7/16"	12 Pt.	Std. SAE Socket	1/2" Dr.
80761	1/2"	12 Pt.	Std. SAE Socket	1/2" Dr.
80762	9/16"	12 Pt.	Std. SAE Socket	1/2" Dr.
80763	5/8"	12 Pt.	Std. SAE Socket	1/2" Dr.
80764	11/16"	12 Pt.	Std. SAE Socket	1/2" Dr.
80765	3/4"	12 Pt.	Std. SAE Socket	1/2" Dr.
80766	13/16"	12 Pt.	Std. SAE Socket	1/2" Dr.
80767	7/8"	12 Pt.	Std. SAE Socket	1/2" Dr.
80768	15/16"	12 Pt.	Std. SAE Socket	1/2" Dr.
80769	1"	12 Pt.	Std. SAE Socket	1/2" Dr.
80770	1-1/16"	12 Pt.	Std. SAE Socket	1/2" Dr.
80771	1-1/8"	12 Pt.	Std. SAE Socket	1/2" Dr.
80773	1/2"	12 Pt.	Deep SAE Socket	1/2" Dr.
80774	9/16"	12 Pt.	Deep SAE Socket	1/2" Dr.
80775	5/8"	12 Pt.	Deep SAE Socket	1/2" Dr.
80776	11/16"	12 Pt.	Deep SAE Socket	1/2" Dr.
80777	3/4"	12 Pt.	Std. SAE Socket	1/2" Dr.
80778	13/16"	12 Pt.	Std. SAE Socket	1/2" Dr.
80779	7/8"	12 Pt.	Deep SAE Socket	1/2" Dr.
80780	15/16"	12 Pt.	Deep SAE Socket	1/2" Dr.
80745	10 mm	12 Pt.	Std. Metric Socket	1/2" Dr.
80746	11 mm	12 Pt.	Std. Metric Socket	1/2" Dr.
80747	12 mm	12 Pt.	Std. Metric Socket	1/2" Dr.
80748	13 mm	12 Pt.	Std. Metric Socket	1/2" Dr.
80749	14 mm	12 Pt.	Std. Metric Socket	1/2" Dr.
80750	15 mm	12 Pt.	Std. Metric Socket	1/2" Dr.
80751	16 mm	12 Pt.	Std. Metric Socket	1/2" Dr.
80752	17 mm	12 Pt.	Std. Metric Socket	1/2" Dr.
80753	18 mm	12 Pt.	Std. Metric Socket	1/2" Dr.
80754	19 mm	12 Pt.	Std. Metric Socket	1/2" Dr.
80755	20 mm	12 Pt.	Std. Metric Socket	1/2" Dr.
80756	21 mm	12 Pt.	Std. Metric Socket	1/2" Dr.
80757	22 mm	12 Pt.	Std. Metric Socket	1/2" Dr.
80758	23mm	12 Pt.	Std. Metric Socket	1/2" Dr.
80759	24 mm	12 Pt.	Std. Metric Socket	1/2" Dr.
80781	10 mm	12 Pt.	Deep Metric Socket	1/2" Dr.
80782	11 mm	12 Pt.	Deep Metric Socket	1/2" Dr.
80783	12 mm	12 Pt.	Deep Metric Socket	1/2" Dr.



Material No.	Description			
80784	13 mm	12 Pt.	Deep Metric Socket	1/2" Dr.
80785	14 mm	12 Pt.	Deep Metric Socket	1/2" Dr.
80786	15 mm	12 Pt.	Deep Metric Socket	1/2" Dr.
80787	16 mm	12 Pt.	Std. Metric Socket	1/2" Dr.
80788	17 mm	12 Pt.	Std. Metric Socket	1/2" Dr.
80789	18 mm	12 Pt.	Deep Metric Socket	1/2" Dr.
80790	19 mm	12 Pt.	Deep Metric Socket	1/2" Dr.
81340	3" Extension			1/2" Dr.
81341	5" Extension			1/2" Dr.
80600	Universal Joint			1/2" Dr.
81304	Full Polish Teardrop Ratchet			1/2" Dr.
80700BM	Replacement Blow Mold Case			

**1/2" DRIVESETS
RATCHETS, SOCKETS & DRIVE TOOLS**

1/2" DRIVE SETS

1/2" DRIVE SETS

RATCHETS, SOCKETS & DRIVE TOOLS



80709 - 28 Pc. METRIC Standard & Deep Socket Set 1/2" DRIVE

Material No.	Description
80645	18 mm 6 Pt. Deep Metric Socket 1/2" Dr.
80646	19 mm 6 Pt. Deep Metric Socket 1/2" Dr.
80745	10 mm 12 Pt. Std. Metric Socket 1/2" Dr.
80746	11 mm 12 Pt. Std. Metric Socket 1/2" Dr.
80747	12 mm 12 Pt. Std. Metric Socket 1/2" Dr.
80748	13 mm 12 Pt. Std. Metric Socket 1/2" Dr.
80749	14 mm 12 Pt. Std. Metric Socket 1/2" Dr.
80750	15 mm 12 Pt. Std. Metric Socket 1/2" Dr.
80751	16 mm 12 Pt. Std. Metric Socket 1/2" Dr.
80752	17 mm 12 Pt. Std. Metric Socket 1/2" Dr.
80753	18 mm 12 Pt. Std. Metric Socket 1/2" Dr.
80754	19 mm 12 Pt. Std. Metric Socket 1/2" Dr.
80755	20 mm 12 Pt. Std. Metric Socket 1/2" Dr.
80756	21 mm 12 Pt. Std. Metric Socket 1/2" Dr.
80757	22 mm 12 Pt. Std. Metric Socket 1/2" Dr.
80758	23 mm 12 Pt. Std. Metric Socket 1/2" Dr.
80759	24 mm 12 Pt. Std. Metric Socket 1/2" Dr.
81341	127mm Extension 1/2" Dr.
81343	381mm Extension 1/2" Dr.
81304	Full Polish Teardrop Ratchet 1/2" Dr.

Material No.	Description
80637	10 mm 6 Pt. Deep Metric Socket 1/2" Dr.
80638	11 mm 6 Pt. Deep Metric Socket 1/2" Dr.
80639	12 mm 6 Pt. Deep Metric Socket 1/2" Dr.
80640	13 mm 6 Pt. Deep Metric Socket 1/2" Dr.
80641	14 mm 6 Pt. Deep Metric Socket 1/2" Dr.
80642	15 mm 6 Pt. Deep Metric Socket 1/2" Dr.
80643	16 mm 6 Pt. Deep Metric Socket 1/2" Dr.
80644	17 mm 6 Pt. Deep Metric Socket 1/2" Dr.



80707 - 23 Pc. SAE Standard & Deep Socket Set 1/2" DRIVE

Material No.	Description
80619	13/16" 6 Pt. Deep SAE Socket 1/2" Dr.
80620	7/8" 6 Pt. Deep SAE Socket 1/2" Dr.
80621	15/16" 6 Pt. Deep SAE Socket 1/2" Dr.
80602	7/16" 6 Pt. Std. SAE Socket 1/2" Dr.
80603	1/2" 6 Pt. Std. SAE Socket 1/2" Dr.
80604	9/16" 6 Pt. Std. SAE Socket 1/2" Dr.
80605	5/8" 6 Pt. Std. SAE Socket 1/2" Dr.
80606	11/16" 6 Pt. Std. SAE Socket 1/2" Dr.
80607	3/4" 6 Pt. Std. SAE Socket 1/2" Dr.
80608	13/16" 6 Pt. Std. SAE Socket 1/2" Dr.
80609	7/8" 6 Pt. Std. SAE Socket 1/2" Dr.
80610	15/16" 6 Pt. Std. SAE Socket 1/2" Dr.
80611	1" 6 Pt. Std. SAE Socket 1/2" Dr.
80612	1-1/16" 6 Pt. Std. SAE Socket 1/2" Dr.
80613	1-1/8" 6 Pt. Std. SAE Socket 1/2" Dr.
81341	127mm Extension 1/2" Dr.
81343	381mm Extension 1/2" Dr.
81304	Full Polish Teardrop Ratchet 1/2" Dr.

Material No.	Description
80615	1/2" 6 Pt. Deep SAE Socket 1/2" Dr.
80614	9/16" 6 Pt. Deep SAE Socket 1/2" Dr.
80616	5/8" 6 Pt. Deep SAE Socket 1/2" Dr.
80617	11/16" 6 Pt. Deep SAE Socket 1/2" Dr.
80618	3/4" 6 Pt. Deep SAE Socket 1/2" Dr.



83058 - 23 Pc. Socket Set METRIC 1/2" DRIVE

Description

1/2" Drive 12pt. Standard Sockets: 8mm, 10mm, 11mm, 12mm, 13mm, 14mm, 15mm, 16mm, 17mm, 18mm, 19mm, 21mm, 22mm, 23mm, 24mm, 27mm, 30mm, 32mm;

1/2" Drive Full Polish Teardrop Ratchet 11"; 1/2" Drive Full Polish Flex Handle 15"; 1/2" Drive Universal Joint; 1/2" Drive Standard Extension 3", 1/2" Drive Standard Extension 10"

Metal Case with EVA Tray Insert: 250mm x 424mm



1/2" DRIVE SETS

80710D - 13 Pc. METRIC 12 Pt. Standard Socket Set 1/2" DRIVE

Material No.	Description			
80747	12 mm	12 Pt.	Std. Metric Socket	1/2" Dr.
80748	13 mm	12 Pt.	Std. Metric Socket	1/2" Dr.
80749	14 mm	12 Pt.	Std. Metric Socket	1/2" Dr.
80750	15 mm	12 Pt.	Std. Metric Socket	1/2" Dr.
80751	16 mm	12 Pt.	Std. Metric Socket	1/2" Dr.
80752	17 mm	12 Pt.	Std. Metric Socket	1/2" Dr.
80753	18 mm	12 Pt.	Std. Metric Socket	1/2" Dr.
80754	19 mm	12 Pt.	Std. Metric Socket	1/2" Dr.



80755	20 mm	12 Pt.	Std. Metric Socket	1/2" Dr.
80756	21 mm	12 Pt.	Std. Metric Socket	1/2" Dr.
80757	22 mm	12 Pt.	Std. Metric Socket	1/2" Dr.
80758	23 mm	12 Pt.	Std. Metric Socket	1/2" Dr.
80759	24 mm	12 Pt.	Std. Metric Socket	1/2" Dr.

80711 - 11 Pc. SAE 12 Pt. Standard Socket Set 1/2" DRIVE

Material No.	Description			
80761	1/2"	12 Pt.	Std. SAE Socket	1/2" Dr.
80762	9/16"	12 Pt.	Std. SAE Socket	1/2" Dr.
80763	5/8"	12 Pt.	Std. SAE Socket	1/2" Dr.
80764	11/16"	12 Pt.	Std. SAE Socket	1/2" Dr.
80765	3/4"	12 Pt.	Std. SAE Socket	1/2" Dr.
80766	13/16"	12 Pt.	Std. SAE Socket	1/2" Dr.



80767	7/8"	12 Pt.	Std. SAE Socket	1/2" Dr.
80768	15/16"	12 Pt.	Std. SAE Socket	1/2" Dr.
80769	1"	12 Pt.	Std. SAE Socket	1/2" Dr.
80770	1-1/16"	12 Pt.	Std. SAE Socket	1/2" Dr.
80771	1-1/8"	12 Pt.	Std. SAE Socket	1/2" Dr.

80704 - 10 Pc. METRIC 6 Pt. Deep Socket Set 1/2" DRIVE

Material No.	Description			
80637	10 mm	6 Pt.	Deep Metric Socket	1/2" Dr.
80638	11 mm	6 Pt.	Deep Metric Socket	1/2" Dr.
80639	12 mm	6 Pt.	Deep Metric Socket	1/2" Dr.
80640	13 mm	6 Pt.	Deep Metric Socket	1/2" Dr.
80641	14 mm	6 Pt.	Deep Metric Socket	1/2" Dr.
80642	15 mm	6 Pt.	Deep Metric Socket	1/2" Dr.



80643	16 mm	6 Pt.	Deep Metric Socket	1/2" Dr.
80644	17 mm	6 Pt.	Deep Metric Socket	1/2" Dr.
80645	18 mm	6 Pt.	Deep Metric Socket	1/2" Dr.
80646	19 mm	6 Pt.	Deep Metric Socket	1/2" Dr.

80705 - 8 Pc. SAE 6 Pt. Deep Socket Set 1/2" DRIVE

Material No.	Description			
80614	1/2"	6 Pt.	Deep SAE Socket	1/2" Dr.
80615	9/16"	6 Pt.	Deep SAE Socket	1/2" Dr.
80616	5/8"	6 Pt.	Deep SAE Socket	1/2" Dr.
80617	11/16"	6 Pt.	Deep SAE Socket	1/2" Dr.
80618	3/4"	6 Pt.	Deep SAE Socket	1/2" Dr.
80619	13/16"	6 Pt.	Deep SAE Socket	1/2" Dr.



80620	7/8"	6 Pt.	Deep SAE Socket	1/2" Dr.
80621	15/16"	6 Pt.	Deep SAE Socket	1/2" Dr.

80712 - 10 Pc. METRIC 12 Pt. Deep Socket Set 1/2" DRIVE

Material No.	Description			
80781	10 mm	12 Pt.	Deep Metric Socket	1/2" Dr.
80782	11 mm	12 Pt.	Deep Metric Socket	1/2" Dr.
80783	12 mm	12 Pt.	Deep Metric Socket	1/2" Dr.
80784	13 mm	12 Pt.	Deep Metric Socket	1/2" Dr.
80785	14 mm	12 Pt.	Deep Metric Socket	1/2" Dr.
80786	15 mm	12 Pt.	Deep Metric Socket	1/2" Dr.



80787	16 mm	12 Pt.	Deep Metric Socket	1/2" Dr.
80788	17 mm	12 Pt.	Deep Metric Socket	1/2" Dr.
80789	18 mm	12 Pt.	Deep Metric Socket	1/2" Dr.
80790	19 mm	12 Pt.	Deep Metric Socket	1/2" Dr.

**1/2" DRIVESETS
RATCHETS, SOCKETS & DRIVE TOOLS**

1/2" DRIVE OPEN STOCK

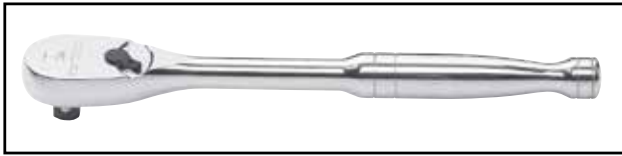

Patented

Full Polish Teardrop Ratchet 1/2" DRIVE

Material No.	Description	Overall Length (mm)	Weight (g)
81304F	Full Polish Teardrop Ratchet	280	740

- 60 tooth low profile ratchet

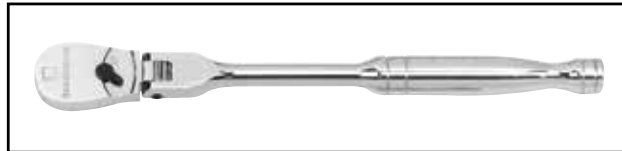

Patented

Full Polish Flex Teardrop Ratchet 1/2" DRIVE

Material No.	Description	Overall Length (mm)	Weight (g)
81306F	Full Polish Flex Teardrop Ratchet	431	740

- 60 tooth low profile ratchet



NEW PRODUCT

120XP Full Polish Teardrop Ratchet 1/2" DRIVE

Material No.	Description	Overall Length (mm)	Weight (g)
81304P	Full Polish Teardrop Ratchet	280	848

- 120 positions
- 3 degree ratcheting arc



NEW PRODUCT

120XP Full Polish Flex Head Ratchet 1/2" DRIVE

Material No.	Description	Overall Length (mm)	Weight (g)
81306P	Full Polish Teardrop Ratchet	430	1107

- 120 positions
- 3 degree ratcheting arc



Quick Release Tear Drop Ratchet 1/2" DRIVE

Material No.	Description	Weight (g)
81309	Quick Release Tear Drop Ratchet	740

- 45 tooth standard ratchet



Patented

Cushion Grip Teardrop Ratchet 1/2" DRIVE

Material No.	Description	Overall Length (mm)	Weight (g)
81303F	Cushion Grip Teardrop Ratchet	295	1360

- 60 tooth low profile ratchet

RATCHETS, SOCKETS & DRIVE TOOLS
1/2" OPEN STOCK

1/2" DRIVE OPEN STOCK

Ratchet Repair Kit 1/2" DRIVE

Material No.	Description
81339	Ratchet Repair Kit

- for non-quick release and non-ROTO ratchets

Sliding T handle 1/2" DRIVE

Material No.	Description	Weight (g)
81311	Sliding T handle	599



Speeder Handle 1/2" DRIVE

Material No.	Description	Weight (g)
81312	Speeder Handle	816



Full Polish Flex Handle SAE 1/2" DRIVE

Material No.	Description	Overall Length (mm)	Weight (g)
81307	Full Polish Flex Handle	381	363
81308D	Full Polish Flex Handle	610	454



Universal Joint SAE 1/2" DRIVE

Material No.	Description	Weight (g)
80600D	Universal Joint	145



1/2" OPEN STOCK
RATCHETS, SOCKETS & DRIVE TOOLS

1/2" DRIVE OPEN STOCK



Patented

Spring Universal Joint SAE 1/2" DRIVE

Material No.	Description	Weight (g)
81234	Spring Universal Joint	150



Standard Adapter SAE 1/2" DRIVE

Material No.	Description	Weight (g)
81354	Standard Adapter 1/2" F x 3/8" M	50
81355	Standard Adapter 1/2" F x 3/4" M	200



Standard Extension SAE 1/2" DRIVE

Material No.	Description	Weight (g)
81340	76mm Standard Extension	127
81341	127mm Standard Extension	200
81342	254mm Standard Extension	390
81343	381mm Standard Extension	617



Wobble Extension SAE 1/2" DRIVE

Material No.	Description	Weight (g)
81344	76mm Wobble Extension	127
81345	127mm Wobble Extension	200
81346	254mm Wobble Extension	390
81347	381mm Wobble Extension	617



81302 - 3 Pc. Locking Extension Set 1/2" DRIVE

Material No.	Description	
81348	76mm Locking Extension	1/2" Dr.
81349	254mm Locking Extension	1/2" Dr.
81350	381mm Locking Extension	1/2" Dr.

1/2" OPEN STOCK

6 Pt. & 12 Pt. Standard Socket METRIC 1/2" DRIVE

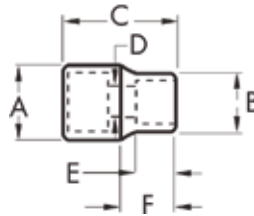

Material No.	Size	Description	Drive End (mm) A	Wrench End (mm) B	Overall Length (mm) C	Bolt Clearance D	Wrench Depth (mm) E	Length to Shoulder F	Weight (g)
80805	8mm	12 Pt. Std. Metric	22.0	13.4	37.8	7.2	14.0	19.0	150
80806	9mm	12 Pt. Std. Metric	22.0	14.3	37.8	7.2	14.0	19.0	59
80745	10mm	12 Pt. Std. Metric	22.0	15.3	37.8	7.2	14.0	19.0	49
80746	11mm	12 Pt. Std. Metric	22.0	16.5	37.8	9.0	14.0	19.0	52
80747	12mm	12 Pt. Std. Metric	22.0	17.8	37.8	9.0	14.0	19.0	52
80748D	13mm	12 Pt. Std. Metric	22.0	19.0	37.8	10.7	14.0	19.0	55
80749	14mm	12 Pt. Std. Metric	22.0	20.3	37.8	10.7	14.5	19.0	57
80750	15mm	12 Pt. Std. Metric	22.0	21.4	37.8	10.7	14.5	19.0	57
80751	16mm	12 Pt. Std. Metric	22.0	21.6	37.8	12.0	14.5	19.0	60
80752	17mm	12 Pt. Std. Metric	23.9	23.9	37.8	12.0	15.0	19.0	72
80753	18mm	12 Pt. Std. Metric	24.9	24.9	37.8	12.0	15.0	19.0	78
80754	19mm	12 Pt. Std. Metric	26.0	26.0	37.8	12.0	19.5	19.0	80
80755D	20mm	12 Pt. Std. Metric	27.8	27.8	37.8	12.0	19.5	19.0	90
80756	21mm	12 Pt. Std. Metric	27.9	27.9	37.8	12.0	19.5	19.0	85
80757	22mm	12 Pt. Std. Metric	29.9	29.9	37.8	12.0	19.5	19.0	100
80758	23mm	12 Pt. Std. Metric	31.9	31.9	37.8	12.0	20.5	19.0	120
80759	24mm	12 Pt. Std. Metric	31.9	31.9	37.8	12.0	20.5	19.0	125
80811	25mm	12 Pt. Std. Metric	32.1	33.3	37.8	0.000	20.5	19.0	56
80681	26 mm	12 Pt. Std. Metric	32.7	33.9	40.0	11.5	22.5	38.0	127
80812	27mm	12 Pt. Std. Metric	34.7	35.9	40.0	0.000	22.5	19.0	125
80682	28 mm	12 Pt. Std. Metric	36.4	37.6	40.0	11.5	22.5	38.0	136
80683	29 mm	12 Pt. Std. Metric	36.7	37.9	40.0	11.5	22.5	38.0	150
80813	30mm	12 Pt. Std. Metric	38.7	40.0	42.0	0.000	24.5	19.0	125
80814D	32mm	12 Pt. Std. Metric	40.7	42.0	42.0	0.000	24.5	19.0	125
80815D	36mm	12 Pt. Std. Metric	48.8	50.0	50.0	0.000	28.0	19.0	136

1/2" OPEN STOCK
RATCHETS, SOCKETS & DRIVE TOOLS

1/2" OPEN STOCK



6 Pt. & 12 Pt. Standard Socket SAE 1/2" DRIVE

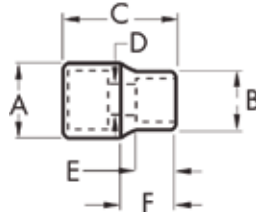

RATCHETS, SOCKETS & DRIVE TOOLS

Material No.	Size	Description	Drive End (mm) A	Wrench End (mm) B	Overall Length (mm) C	Bolt Clearance D	Wrench Depth (mm) E	Length to Shoulder F	Weight (g)
80760	7/16"	12 Pt. Std. SAE	22.2	17.0	37.8	7.2	14.0	19.0	54
80761	1/2"	12 Pt. Std. SAE	22.2	18.6	37.8	9.0	14.0	19.0	54
80763	5/8"	12 Pt. Std. SAE	22.2	18.6	37.8	9.0	14.0	19.0	54
80762	9/16"	12 Pt. Std. SAE	22.2	18.6	37.8	9.0	14.0	19.0	54
80764	11/16"	12 Pt. Std. SAE	23.8	23.8	37.8	12.0	15.0	19.0	75
80765	3/4"	12 Pt. Std. SAE	25.9	25.9	37.8	12.0	19.5	19.0	75
80766	13/16"	12 Pt. Std. SAE	27.9	27.9	37.8	12.0	19.5	19.0	87
80767	7/8"	12 Pt. Std. SAE	29.9	29.9	37.8	12.0	19.5	19.0	102
80768	15/16"	12 Pt. Std. SAE	31.9	31.9	37.8	12.0	20.5	19.0	115
80769	1"	12 Pt. Std. SAE	33.9	33.9	40.0	12.0	22.5	19.0	145
80770	1-1/16"	12 Pt. Std. SAE	35.9	35.9	40.0	12.0	22.5	19.0	155
80771	1-1/8"	12 Pt. Std. SAE	37.9	37.9	42.0	12.0	24.5	38.0	159
80793	1-3/16"	12 Pt. Std. SAE	38.7	39.9	42.0	12.0	24.5	38.0	227
80794	1-1/4"	12 Pt. Std. SAE	40.7	41.9	42.0	12.0	24.5	38.0	227
80680	1-1/2"	12 Pt. Std. SAE	48.6	49.8	50.0	12.0	31.0	38.0	227

1/2" OPEN STOCK

6 Pt. & 12 Pt. Deep Socket METRIC/SAE 1/2" DRIVE

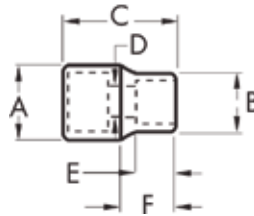

Material No.	Size	Description	Drive End	Wrench	Overall	Bolt	Wrench	Length to	Weight (g)
			(mm) A	End (mm) B	Length (mm) C	Clearance D	Depth (mm) E	Shoulder F	
80781	10mm	12 Pt. Deep Metric	22.0	15.3	77.0	9.5	5.1	38.0	105
80782	11mm	12 Pt. Deep Metric	22.0	16.5	77.0	10.0	6.0	38.0	105
80783	12mm	12 Pt. Deep Metric	22.0	17.8	77.0	11.0	6.6	38.0	108
80784	13mm	12 Pt. Deep Metric	22.0	19.0	77.0	11.5	7.3	38.0	112
80785	14mm	12 Pt. Deep Metric	22.0	20.3	77.0	11.5	8.9	38.0	112
80786	15mm	12 Pt. Deep Metric	22.0	21.4	77.0	11.5	8.9	38.0	112
80787	16mm	12 Pt. Deep Metric	22.0	21.6	77.0	11.5	10.1	38.0	130
80788	17mm	12 Pt. Deep Metric	23.8	23.8	77.0	11.5	10.1	38.0	138
80789	18mm	12 Pt. Deep Metric	24.8	24.8	77.0	11.5	10.7	38.0	150
80790	19mm	12 Pt. Deep Metric	25.8	25.8	77.0	11.5	11.6	38.0	155
80817D	20mm	12 Pt. Deep Metric	26.6	27.8	77.0	11.5	12.2	19.0	181
80818	21mm	12 Pt. Deep Metric	26.6	27.8	77.0	11.5	12.2	19.0	195
80820	22mm	12 Pt. Deep Metric	28.6	29.8	77.0	11.5	13.2	19.0	204
80822	24mm	12 Pt. Deep Metric	30.6	39.8	77.0	11.5	14.4	19.0	209
80824	27mm	12 Pt. Deep Metric	34.6	35.8	77.0	11.5	16.3	19.0	218
80826	30mm	12 Pt. Deep Metric	38.6	39.8	77.0	11.5	17.2	19.0	227
80827	32mm	12 Pt. Deep Metric	40.6	41.8	77.0	11.5	19.6	19.0	249
80772	7/16"	12 Pt. Deep SAE	22.1	42.4	77.0	9.9	6.1	38.1	105
80773	1/2"	12 Pt. Deep SAE	22.0	18.6	77.0	11.5	7.3	38.0	110
80774	9/16"	12 Pt. Deep SAE	22.0	20.6	77.0	11.5	8.9	38.0	115
80775	5/8"	12 Pt. Deep SAE	22.0	21.6	77.0	11.5	10.1	38.0	130
80776	11/16"	12 Pt. Deep SAE	23.8	23.8	77.0	11.5	10.1	38.0	155
80777D	3/4"	12 Pt. Deep SAE	25.8	31.7	77.0	11.5	11.6	38.0	170
80778	13/16"	12 Pt. Deep SAE	27.8	27.8	77.0	11.5	12.2	38.0	190
80779	7/8"	12 Pt. Deep SAE	29.8	29.8	77.0	11.5	13.2	38.0	225
80780	15/16"	12 Pt. Deep SAE	39.8	39.8	77.0	11.5	14.4	38.0	249
80795	1"	12 Pt. Deep SAE	32.6	33.8	77.0	11.5	16.3	38.0	249
80796	1-1/16"	12 Pt. Deep SAE	34.6	35.8	77.0	11.5	17.2	38.0	249
80797	1-1/8"	12 Pt. Deep SAE	36.6	37.8	77.0	11.5	19.6	38.0	127
80798	1-1/4"	12 Pt. Deep SAE	40.6	41.8	77.0	11.5	22.1	38.0	136
80687	1-1/2"	12 Pt. Deep SAE	40.6	41.8	77.0	11.5	22.1	38.0	136

1/2" OPEN STOCK
RATCHETS, SOCKETS & DRIVE TOOLS

3/4" DRIVE SETS



**80879 - 13 Pc. SAE Standard Socket Set
3/4" DRIVE**

Material No.	Description			
80830	7/8"	12 Pt.	Std. SAE Socket	3/4" Dr.
80831	15/16"	12 Pt.	Std. SAE Socket	3/4" Dr.
80833	1"	12 Pt.	Std. SAE Socket	3/4" Dr.
80834	1-1/16"	12 Pt.	Std. SAE Socket	3/4" Dr.
80835	1-1/8"	12 Pt.	Std. SAE Socket	3/4" Dr.
80838	1-3/16"	12 Pt.	Std. SAE Socket	3/4" Dr.
80839	1-1/4"	12 Pt.	Std. SAE Socket	3/4" Dr.
80840	1-5/16"	12 Pt.	Std. SAE Socket	3/4" Dr.
80841	1-7/16"	12 Pt.	Std. SAE Socket	3/4" Dr.
80852	1-1/2"	12 Pt.	Std. SAE Socket	3/4" Dr.
80854	1-1/2"	12 Pt.	Std. SAE Socket	3/4" Dr.
81412	8" Extension			3/4" Dr.
81400	Quick-Release Teardrop Ratchet			3/4" Dr.



**80880 - 27 Pc. SAE Standard Socket Set
3/4" DRIVE**

Material No.	Description			
80852	1-7/16"	12 Pt.	Std. SAE Socket	3/4" Dr.
80854	1-1/2"	12 Pt.	Std. SAE Socket	3/4" Dr.
80855	1-5/8"	12 Pt.	Std. SAE Socket	3/4" Dr.
80856	1-11/16"	12 Pt.	Std. SAE Socket	3/4" Dr.
80857	1-3/4"	12 Pt.	Std. SAE Socket	3/4" Dr.
80859	1-13/16"	12 Pt.	Std. SAE Socket	3/4" Dr.
80860	1-7/8"	12 Pt.	Std. SAE Socket	3/4" Dr.
80861	2"	12 Pt.	Std. SAE Socket	3/4" Dr.
80862	2-1/8"	12 Pt.	Std. SAE Socket	3/4" Dr.
80863	2-3/16"	12 Pt.	Std. SAE Socket	3/4" Dr.
80864	2-1/4"	12 Pt.	Std. SAE Socket	3/4" Dr.
80865	2-3/8"	12 Pt.	Std. SAE Socket	3/4" Dr.
81411	5" Extension			3/4" Dr.
81412	8" Extension			3/4" Dr.
81413	16" Extension			3/4" Dr.
81400	Quick-Release Teardrop Ratchet			3/4" Dr.
81401	18"	Sliding T Handle		3/4" Dr.
81404	19"	Flex Handle		3/4" Dr.

Material No.	Description			
80830	7/8"	12 Pt.	Std. SAE Socket	3/4" Dr.
80831	15/16"	12 Pt.	Std. SAE Socket	3/4" Dr.
80833	1"	12 Pt.	Std. SAE Socket	3/4" Dr.
80834	1-1/16"	12 Pt.	Std. SAE Socket	3/4" Dr.
80835	1-1/8"	12 Pt.	Std. SAE Socket	3/4" Dr.
80838	1-3/16"	12 Pt.	Std. SAE Socket	3/4" Dr.
80839	1-1/4"	12 Pt.	Std. SAE Socket	3/4" Dr.
80840	1-5/16"	12 Pt.	Std. SAE Socket	3/4" Dr.
80841	1-3/8"	12 Pt.	Std. SAE Socket	3/4" Dr.

3/4" DRIVE OPEN STOCK

Quick Release Ratchet 3/4" DRIVE

Material No.	Description	Overall Length (mm)	Weight (g)
81400	Quick-Release Ratchet	502	2395

- 24 tooth standard ratchet



Sliding T Handle 3/4" DRIVE

Material No.	Description	Overall Length (mm)	Weight (g)
81401	Sliding T	483	1377



Flex Handle 3/4" DRIVE

Material No.	Description	Overall Length (mm)	Weight (g)
81404	Flex Handle	483	1846

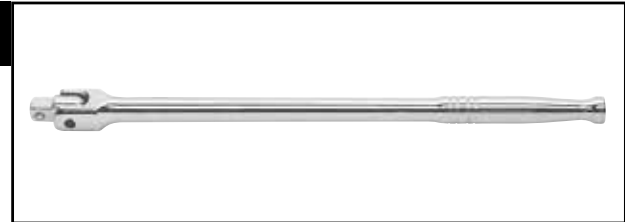

Standard Extension 3/4" DRIVE

Material No.	Description	Weight (g)
81411	5" Standard Extension	499
81412	8" Standard Extension	907
81413	16" Standard Extension	1387



81499 - Ratchet Repair Kit 3/4" DRIVE

3/4" OPEN STOCK
RATCHETS, SOCKETS & DRIVE TOOLS

3/4" OPEN STOCK



12 Pt. Standard Socket SAE 3/4" DRIVE

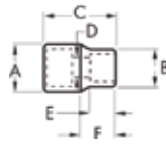

RATCHETS, SOCKETS & DRIVE TOOLS

Material No.	Size	Description	Drive End (mm) A	Wrench End (mm) B	Overall Length (mm) C	Bolt Clearance D	Wrench Depth (mm) E	Length to Shoulder F	Weight (g)
80830	7/8"	12 Pt. Std. SAE	36.0	32.2	50.0	N/A	14.0	22.0	210
80831	15/16"	12 Pt. Std. SAE	36.0	34.2	51.0	N/A	16.0	22.0	220
80833	1"	12 Pt. Std. SAE	36.0	37.0	52.0	N/A	16.0	30.0	220
80834	1-1/16"	12 Pt. Std. SAE	36.0	38.0	52.0	N/A	22.0	30.0	220
80835D	1-1/8"	12 Pt. Std. SAE	38.0	40.0	52.0	N/A	22.0	30.0	250
80838	1-3/16"	12 Pt. Std. SAE	38.0	42.0	54.0	N/A	24.0	32.0	270
80839	1-1/4"	12 Pt. Std. SAE	38.0	44.0	56.0	N/A	24.0	33.0	290
80840	1-5/16"	12 Pt. Std. SAE	38.0	46.0	56.0	N/A	26.0	33.0	309
80841	1-3/8"	12 Pt. Std. SAE	42.0	48.0	58.0	N/A	26.0	35.0	369
80852	1-7/16"	12 Pt. Std. SAE	42.0	50.0	58.0	N/A	28.0	35.0	389
80854	1-1/2"	12 Pt. Std. SAE	45.0	52.0	60.0	N/A	28.0	36.0	449
80855D	1-5/8"	12 Pt. Std. SAE	45.0	56.0	64.0	N/A	30.0	40.0	529
80856	1-11/16"	12 Pt. Std. SAE	45.0	58.0	65.0	N/A	32.0	39.0	549
80857	1-3/4"	12 Pt. Std. SAE	48.0	60.0	66.0	N/A	32.0	40.0	599
80859	1-13/16"	12 Pt. Std. SAE	47.0	62.0	68.0	N/A	34.0	40.0	649
80860	1-7/8"	12 Pt. Std. SAE	48.0	64.0	70.0	N/A	34.0	42.0	699
80861	2"	12 Pt. Std. SAE	48.0	68.0	72.0	N/A	36.0	42.0	738
80862	2-1/8"	12 Pt. Std. SAE	48.0	72.0	74.0	N/A	38.0	44.0	818
80863	2-3/16"	12 Pt. Std. SAE	48.0	74.0	76.0	N/A	38.0	45.0	868
80864	2-1/4"	12 Pt. Std. SAE	48.0	76.0	76.0	N/A	40.0	45.0	918
80865	2-3/8"	12 Pt. Std. SAE	48.0	80.0	78.0	N/A	40.0	46.0	998

XL PASS-THROUGH

LOCKING FLEX GEARWRENCH PASS-THRU™ RATCHET

Pass-Thru® Ratchet & Socket System features the Vortex™ drive system that links drivetools and sockets

5° Ratcheting arc versus 12° on conventional ratchets

One touch release for 11 locking positions

Up to 50% thinner than conventional ratchet systems

Pass-Thru® Ratchet & Socket System eliminates the need for deep sockets

Dual material handle for improved ergonomics

Up to 40% stronger by eliminating drive tang

Reach fasteners in tight spaces with ease

VORTEX™ BIT SOCKETS

Vortex™ Bit Sockets are available in Hex, Torx®, Phillips, and Slotted

Vortex™ Bit Sockets are broached for use with 1/4" and 3/8" Conventional Square Drive Ratchets

Products are covered by one or more of the following patents:
 • US 7,1168,346 US 6,868,709 US 7,231,851

XL PASS-THROUGH

XL PASS-THROUGH SETS

SETS
XL PASS-THROUGH



8921 - 21 Pc. METRIC Pass Thru® Ratchet Set 3/8" DRIVE

Material No.	Description		
132220	11/16"	Vortex SAE Socket	3/8" Dr.
132240	3/4"	Vortex SAE Socket	3/8" Dr.
532100	10 mm	Vortex Metric Socket	3/8" Dr.
532110	11 mm	Vortex Metric Socket	3/8" Dr.
532120	12 mm	Vortex Metric Socket	3/8" Dr.
532130	13 mm	Vortex Metric Socket	3/8" Dr.
532140	14 mm	Vortex Metric Socket	3/8" Dr.
532150	15 mm	Vortex Metric Socket	3/8" Dr.
532160	16 mm	Vortex Metric Socket	3/8" Dr.
532170	17 mm	Vortex Metric Socket	3/8" Dr.
532180	18 mm	Vortex Metric Socket	3/8" Dr.
532190	19 mm	Vortex Metric Socket	3/8" Dr.
231060	3" Pass-Thru® Extension		3/8" Dr.
231061	0.89 Pass-Thru® Adapter		3/8" Dr.
231062	1.17 Pass-Thru® Adapter		3/8" Dr.

Material No.	Description		
132120	3/8"	Vortex SAE Socket	3/8" Dr.
132140	7/16"	Vortex SAE Socket	3/8" Dr.
132160	1/2"	Vortex SAE Socket	3/8" Dr.
132180	9/16"	Vortex SAE Socket	3/8" Dr.
132200	5/8"	Vortex SAE Socket	3/8" Dr.

Featuring • Locking Flex • Gear Ratchet™ Handle



891226 - 25 Pc. SAE/METRIC Pass-Thru® Ratchet Set Featuring Locking Flex GearRatchet™ Handle 1/2" DRIVE

Material No.	Description		
142360	1-1/8"	Vortex SAE Socket	1/2" Dr.
142380	1-1/4"	Vortex SAE Socket	1/2" Dr.
542150	15 mm	Vortex SAE Socket	1/2" Dr.
542160	16 mm	Vortex Metric Socket	1/2" Dr.
542170	17 mm	Vortex Metric Socket	1/2" Dr.
542180	18 mm	Vortex Metric Socket	1/2" Dr.
542190	19 mm	Vortex Metric Socket	1/2" Dr.
542200	20 mm	Vortex Metric Socket	1/2" Dr.
542210	21 mm	Vortex Metric Socket	1/2" Dr.
542220	22 mm	Vortex Metric Socket	1/2" Dr.
542240	24 mm	Vortex Metric Socket	1/2" Dr.
542270	27 mm	Vortex Metric Socket	1/2" Dr.
542300	30 mm	Vortex Metric Socket	1/2" Dr.
542320	32 mm	Vortex Metric Socket	1/2" Dr.
241080	6"	Vortex Metric Socket	1/2" Dr.
241062	1/2" Sq. Dr. Quick-Release Adapter		1/2" Dr.
891200	Locking Flex GearRatchet™ Handle		1/2" Dr.

Material No.	Description		
142200	5/8"	Vortex SAE Socket	1/2" Dr.
142220	1/16"	Vortex SAE Socket	1/2" Dr.
142240	3/4"	Vortex SAE Socket	1/2" Dr.
142260	3/16"	Vortex SAE Socket	1/2" Dr.
142280	7/8"	Vortex SAE Socket	1/2" Dr.
142300	5/16"	Vortex SAE Socket	1/2" Dr.
142320	1"	Vortex SAE Socket	1/2" Dr.
142340	1-1/16"	Vortex SAE Socket	1/2" Dr.

Locking Flex GearRatchet™ Handle



Material No.	Description	Length (mm)	Weight (g)
893800	3/8" Dr.	305	390

VORTEX ADAPTERS/SOCKETS

Vortex Sockets 3/8" DRIVE

Material No.	Description	Length (mm)	Weight (g)
132120GR	3/8"	32	25
132140GR	7/16"	32	25
132160GR	1/2"	32	25
132180GR	9/16"	32	30
132200GR	5/8"	32	30
132220GR	11/16"	32	30
132240GR	3/4"	33	35
132260GR	13/16"	35	40
132280GR	7/8"	35	40
532100GR	10 mm	32	25
532110GR	11 mm	32	25
532120GR	12 mm	32	25
532130GR	13 mm	32	25



Material No.	Description	Length (mm)	Weight (g)
532140GR	14 mm	32	27
532150GR	15 mm	32	27
532160GR	16 mm	32	30
532170GR	17 mm	32	30
532180GR	18 mm	32	32
532190GR	19 mm	33	35

Pass-Thru® Quick-Release Adapters

Material No.	Description	Length (mm)	Weight (g)
231062GR	3/8" Sq. Dr.	29	20



VORTEX ADAPTERS/
SOCKETS
XL PASS-THROUGH

BIT SOCKETS & FLEX HEX KEYS



Bit Sockets

- 1/4" Drive Sets
- 3/8" Drive Sets
- 1/2" Drive Sets

Flex Hex™ Keys

- Long Ball Hex Sets

BIT SOCKETS

Ball and Standard Hex in All Sizes

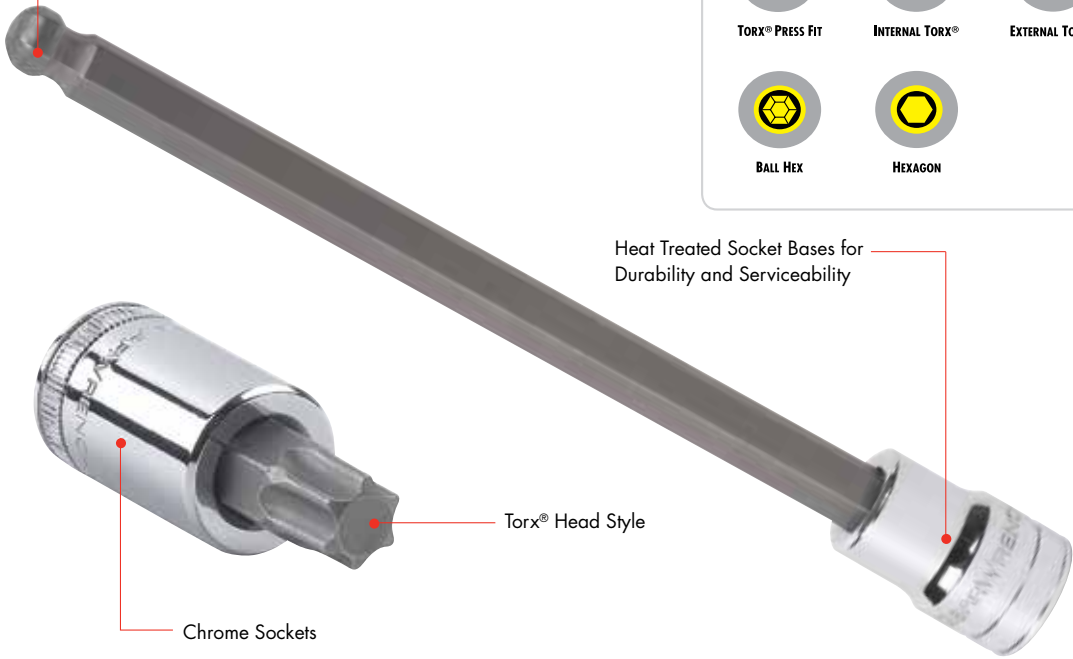





Heat Treated Socket Bases for Durability and Serviceability

Torx® Head Style

Chrome Sockets

AVAILABLE IN:

		
TORX® PRESS FIT	INTERNAL TORX®	EXTERNAL TORX®
		
BALL HEX	HEXAGON	

Hex Head Style



Packed on Clip Rail Sets



Phillips Head Style



Internal Torx® Style



Triple Square Head Style



Slotted Head Style



Pozidrive® Head Style



Tamper-Proof Torx® Head Style

Insert Bits and Bit Holders

Torx® is a registered trademark of Acument Intellectual Properties, LLC.

MULTI DRIVE SETS



TORX® PRESS FIT

**80723 - 13 Pc. TORX® Press Fit Bit Socket Set
1/4", 3/8" & 1/2" DRIVE**

Material No.	Description	
80171	T-8 Torx® Press Fit Bit Socket	1/4" Drive
80172	T-10 Torx® Press Fit Bit Socket	1/4" Drive
80173	T-15 Torx® Press Fit Bit Socket	1/4" Drive
80174	T-20 Torx® Press Fit Bit Socket	1/4" Drive
80175	T-25 Torx® Press Fit Bit Socket	1/4" Drive
80176	T-27 Torx® Press Fit Bit Socket	1/4" Drive
80177	T-30 Torx® Press Fit Bit Socket	1/4" Drive
80451	T-40 Torx® Press Fit Bit Socket	3/8" Drive
80452	T-45 Torx® Press Fit Bit Socket	3/8" Drive
80453	T-47 Torx® Press Fit Bit Socket	3/8" Drive
80454	T-50 Torx® Press Fit Bit Socket	3/8" Drive
80455	T-55 Torx® Press Fit Bit Socket	3/8" Drive
80667	T-60 Torx® Press Fit Bit Socket	1/2" Drive

MULTI DRIVE SETS

BIT SOCKETS



INTERNAL TORX®

**80588 - 10 Pc. Long TORX® Bit Socket Set
1/4" & 3/8" DRIVE**

Material No.	Description	
82510	T-8 Long Torx® Bit Socket	1/4" Drive
82511	T-10 Long Torx® Bit Socket	1/4" Drive
82512	T-15 Long Torx® Bit Socket	1/4" Drive
82513	T-20 Long Torx® Bit Socket	1/4" Drive
82514	T-25 Long Torx® Bit Socket	1/4" Drive
82515	T-27 Long Torx® Bit Socket	1/4" Drive
82516	T-30 Long Torx® Bit Socket	1/4" Drive
82517	T-40 Long Torx® Bit Socket	3/8" Drive
82518	T-45 Long Torx® Bit Socket	3/8" Drive
82519	T-50 Long Torx® Bit Socket	3/8" Drive



HEXAGON

**80578 - 10 Pc. METRIC HEX Bit Socket Set
3/8" & 1/2" DRIVE**

Material No.	Description	
80425	4mm Hex Bit Socket	3/8" Drive
80426	5mm Hex Bit Socket	3/8" Drive
80427	6mm Hex Bit Socket	3/8" Drive
80428	7mm Hex Bit Socket	3/8" Drive
80429	8mm Hex Bit Socket	3/8" Drive
80430	9mm Hex Bit Socket	3/8" Drive
80431	10mm Hex Bit Socket	3/8" Drive
80661	12mm Hex Bit Socket	1/2" Drive
80662	14mm Hex Bit Socket	1/2" Drive
80663	17mm Hex Bit Socket	1/2" Drive

1/4" & 3/8" DRIVE SETS

**80322 - 6 Pc. DEEP External TORX® Socket Set
1/4" DRIVE**

Material No.	Description	
80191	E-4 Deep External Torx® Socket	1/4" Drive
80192	E-5 Deep External Torx® Socket	1/4" Drive
80193	E-6 Deep External Torx® Socket	1/4" Drive
80194	E-7 Deep External Torx® Socket	1/4" Drive
80195	E-8 Deep External Torx® Socket	1/4" Drive
80196	E-10 Deep External Torx® Socket	1/4" Drive



**80580 - 12 Pc. METRIC HEX Bit Socket Set
3/8" DRIVE**

Material No.	Description	
80422	2mm Hex Bit Socket	3/8" Drive
80423	2.5mm Hex Bit Socket	3/8" Drive
80424	3mm Hex Bit Socket	3/8" Drive
80425	4mm Hex Bit Socket	3/8" Drive
80426	5mm Hex Bit Socket	3/8" Drive
80427	6mm Hex Bit Socket	3/8" Drive
80428	7mm Hex Bit Socket	3/8" Drive
80429	8mm Hex Bit Socket	3/8" Drive
80430	9mm Hex Bit Socket	3/8" Drive
80431	10mm Hex Bit Socket	3/8" Drive
80432	11mm Hex Bit Socket	3/8" Drive
80433	12mm Hex Bit Socket	3/8" Drive



**80581 - 12 Pc. SAE HEX Bit Socket Set
3/8" DRIVE**

Material No.	Description	
80410	1/16" Hex Bit Socket	3/8" Drive
80411	5/64" Hex Bit Socket	3/8" Drive
80412	3/32" Hex Bit Socket	3/8" Drive
80413	7/64" Hex Bit Socket	3/8" Drive
80414	1/8" Hex Bit Socket	3/8" Drive
80415	9/64" Hex Bit Socket	3/8" Drive
80416	5/32" Hex Bit Socket	3/8" Drive
80417	3/16" Hex Bit Socket	3/8" Drive
80418	7/32" Hex Bit Socket	3/8" Drive
80419	1/4" Hex Bit Socket	3/8" Drive
80420	5/16" Hex Bit Socket	3/8" Drive
80421	3/8" Hex Bit Socket	3/8" Drive



1/4" & 3/8" DRIVE SETS
BIT SOCKETS

Torx® is a registered trademark of Acument Intellectual Properties, LLC.

3/8" DRIVE SETS



80573 - 8 Pc. METRIC LONG BALL HEX Bit Socket Set 3/8" DRIVE

Material No.	Description	
80441	3mm Long Ball Hex Bit Socket	3/8" Drive
80442	4mm Long Ball Hex Bit Socket	3/8" Drive
80443	5mm Long Ball Hex Bit Socket	3/8" Drive
80444	6mm Long Ball Hex Bit Socket	3/8" Drive
80445	7mm Long Ball Hex Bit Socket	3/8" Drive
80446	8mm Long Ball Hex Bit Socket	3/8" Drive
80447	9mm Long Ball Hex Bit Socket	3/8" Drive
80448	10mm Long Ball Hex Bit Socket	3/8" Drive



80574 - 7 Pc. SAE LONG BALL HEX Bit Socket Set 3/8" DRIVE

Material No.	Description	
80434	1/8" Long Ball Hex Bit Socket	3/8" Drive
80435	5/32" Long Ball Hex Bit Socket	3/8" Drive
80436	3/16" Long Ball Hex Bit Socket	3/8" Drive
80437	7/32" Long Ball Hex Bit Socket	3/8" Drive
80438	1/4" Long Ball Hex Bit Socket	3/8" Drive
80439	5/16" Long Ball Hex Bit Socket	3/8" Drive
80440	3/8" Long Ball Hex Bit Socket	3/8" Drive



LONG BALL HEX Bit Sockets 3/8" DRIVE

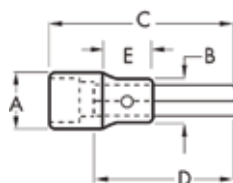

Item No.	Bit Size	Drive End (mm) A	Nose Dia. (mm) B	Overall Length (mm) C	Bit Length (mm) D	Length to Shoulder (mm) E	Weight (g)
80441	3 mm	17.5	15.0	152	132	14.0	50
80442	4 mm	17.5	15.0	152	132	14.0	50
80443	5 mm	17.5	15.0	152	132	14.0	58
80444	6 mm	17.5	15.0	152	135	14.0	67
80445	7 mm	17.5	15.0	152	137	14.0	93
80446	8 mm	17.5	15.0	152	137	14.0	93
80447	9 mm	19.0	19.0	152	134	14.0	180
80448	10 mm	19.0	19.0	152	134	14.0	180

3/8" DRIVE SETS
BIT SOCKETS

IMPACT SOCKETS



Impact Sockets

1/2" Drive Sets

1/2" Drive Open Stock

IMPACT SOCKETS

AVAILABLE IN:

- 1/2" Drive
- Universal Sockets
- Hex Sockets
- Adapters and Drive Tools

Reinforced Moulded cases with sizes marked for quick identification and storage

Reinforced Steel hinges for added durability

Steel Buckles provide security and strength

High Visibility Laser Etched Markings

Additional Hard Stamping (on opposite side)

Surface Drive™ Technology

Chrome Molybdenum Alloy Steel (CR-MO) for exceptional strength and long lasting durability

Pin hole available for use with pin and o-ring for secure socket retention

IMPACT SOCKETS



1/2" DRIVE SETS

84930 - 12 Pc. Impact METRIC Standard Socket Set 1/2" DRIVE

Material No.	Description			
84520	8 mm	6 Pt.	Std. Metric Socket	1/2" Dr.
84521	9 mm	6 Pt.	Std. Metric Socket	1/2" Dr.
84522	10 mm	6 Pt.	Std. Metric Socket	1/2" Dr.
84523	11 mm	6 Pt.	Std. Metric Socket	1/2" Dr.
84524	12 mm	6 Pt.	Std. Metric Socket	1/2" Dr.
84525	13 mm	6 Pt.	Std. Metric Socket	1/2" Dr.
84526	14 mm	6 Pt.	Std. Metric Socket	1/2" Dr.
84527	15 mm	6 Pt.	Std. Metric Socket	1/2" Dr.
84528	16 mm	6 Pt.	Std. Metric Socket	1/2" Dr.



Material No.	Description			
84529	17 mm	6 Pt.	Std. Metric Socket	1/2" Dr.
84530	18 mm	6 Pt.	Std. Metric Socket	1/2" Dr.
84531	19 mm	6 Pt.	Std. Metric Socket	1/2" Dr.

84931 - 12 Pc. Impact SAE Standard Socket Set 1/2" DRIVE

Material No.	Description			
84500	3/8"	6 Pt.	Std. SAE Socket	1/2" Dr.
84501	7/16"	6 Pt.	Std. SAE Socket	1/2" Dr.
84502	1/2"	6 Pt.	Std. SAE Socket	1/2" Dr.
84503	9/16"	6 Pt.	Std. SAE Socket	1/2" Dr.
84504	5/8"	6 Pt.	Std. SAE Socket	1/2" Dr.
84505	11/16"	6 Pt.	Std. SAE Socket	1/2" Dr.
84506	3/4"	6 Pt.	Std. SAE Socket	1/2" Dr.
84507	13/16"	6 Pt.	Std. SAE Socket	1/2" Dr.
84508	7/8"	6 Pt.	Std. SAE Socket	1/2" Dr.



Material No.	Description			
84509	15/16"	6 Pt.	Std. SAE Socket	1/2" Dr.
84510	1"	6 Pt.	Std. SAE Socket	1/2" Dr.
84511	1-1/16"	6 Pt.	Std. SAE Socket	1/2" Dr.

84944 - 12 Pc. Impact METRIC Deep Socket Set 1/2" DRIVE

Material No.	Description			
84566	8 mm	6 Pt.	Deep Metric Socket	1/2" Dr.
84567	9 mm	6 Pt.	Deep Metric Socket	1/2" Dr.
84568	10 mm	6 Pt.	Deep Metric Socket	1/2" Dr.
84569	11 mm	6 Pt.	Deep Metric Socket	1/2" Dr.
84570	12 mm	6 Pt.	Deep Metric Socket	1/2" Dr.
84571	13 mm	6 Pt.	Deep Metric Socket	1/2" Dr.
84572	14 mm	6 Pt.	Deep Metric Socket	1/2" Dr.
84573	15 mm	6 Pt.	Deep Metric Socket	1/2" Dr.
84574	16 mm	6 Pt.	Deep Metric Socket	1/2" Dr.
84575	17 mm	6 Pt.	Deep Metric Socket	1/2" Dr.
84576	18 mm	6 Pt.	Deep Metric Socket	1/2" Dr.
84577	19 mm	6 Pt.	Deep Metric Socket	1/2" Dr.



1/2" DRIVES SETS
IMPACT SOCKETS

1/2" DRIVE SETS



**84942 - 12 Pc. Impact SAE Deep Socket Set
1/2" DRIVE**

Material No.	Description		
84546	3/8"	6 Pt. Deep SAE Socket	1/2" Dr.
84547	7/16"	6 Pt. Deep SAE Socket	1/2" Dr.
84548	1/2"	6 Pt. Deep SAE Socket	1/2" Dr.
84549	9/16"	6 Pt. Deep SAE Socket	1/2" Dr.
84550	5/8"	6 Pt. Deep SAE Socket	1/2" Dr.
84551	11/16"	6 Pt. Deep SAE Socket	1/2" Dr.
84552	3/4"	6 Pt. Deep SAE Socket	1/2" Dr.
84553	13/16"	6 Pt. Deep SAE Socket	1/2" Dr.
84554	7/8"	6 Pt. Deep SAE Socket	1/2" Dr.
84555	15/16"	6 Pt. Deep SAE Socket	1/2" Dr.
84556	1"	6 Pt. Deep SAE Socket	1/2" Dr.
84557	1-1/16"	6 Pt. Deep SAE Socket	1/2" Dr.



**84940 - 7 Pc. Impact SAE HEX Socket Set
1/2" DRIVE**

Material No.	Description		
84634	3/8"	6 Pt. Hex Bit SAE Socket	1/2" Dr.
84635	7/16"	6 Pt. Hex Bit SAE Socket	1/2" Dr.
84636	1/2"	6 Pt. Hex Bit SAE Socket	1/2" Dr.
84637	9/16"	6 Pt. Hex Bit SAE Socket	1/2" Dr.
84638	5/8"	6 Pt. Hex Bit SAE Socket	1/2" Dr.
84639	11/16"	6 Pt. Hex Bit SAE Socket	1/2" Dr.
84640	3/4"	6 Pt. Hex Bit SAE Socket	1/2" Dr.

1/2" DRIVE SETS
IMPACT SOCKETS

1/2" OPEN STOCK

Impact Extension Bars SAE 1/2" DRIVE

Material No.	Description	Weight (g)
84646	5" Extension Bar	226
84644	10" Extension Bar	223



Standard Impact Adapters SAE 1/2" DRIVE

Material No.	Description	Weight (g)
84643	1/2" F x 3/8" M	70



Universal Impact Joints SAE 1/2" DRIVE

Material No.	Description	Weight (g)
80671	1/2" Universal Joint	170



6 Pt. Standard Impact Sockets SAE/METRIC 1/2" DRIVE



Material No.	Size	Description	Drive End (mm) A	Wrench End (mm) B	Overall Length (mm) C	Weight (g)
84500D	3/8"	6 Pt. Std. SAE	22.0	16.0	38.0	65
84501	7/16"	6 Pt. Std. SAE	22.0	18.0	38.0	65
84502	1/2"	6 Pt. Std. SAE	22.0	18.0	38.0	65
84503	9/16"	6 Pt. Std. SAE	24.0	22.0	38.0	80
84504D	5/8"	6 Pt. Std. SAE	25.0	25.0	38.0	88
84505D	11/16"	6 Pt. Std. SAE	26.0	26.0	38.0	95
84506D	3/4"	6 Pt. Std. SAE	28.0	28.0	38.0	106
84507D	13/16"	6 Pt. Std. SAE	30.0	30.0	38.0	120
84508D	7/8"	6 Pt. Std. SAE	32.0	32.0	38.0	145
84509D	15/16"	6 Pt. Std. SAE	34.0	34.0	38.0	162
84510D	1"	6 Pt. Std. SAE	36.0	36.0	38.0	190
84511D	1-1/16"	6 Pt. Std. SAE	38.0	38.0	40.0	212
84512D	1-1/8"	6 Pt. Std. SAE	38.0	40.0	40.0	224
84513D	1-3/16"	6 Pt. Std. SAE	38.0	42.0	40.0	235
84514D	1-1/4"	6 Pt. Std. SAE	38.0	44.0	40.0	250

1/2" OPEN STOCK
IMPACT SOCKETS

1/2" OPEN STOCK



6 Pt. Standard Impact Sockets METRIC/SAE 1/2" DRIVE



Material No.	Size	Description	Drive End (mm) A	Wrench End (mm) B	Overall Length (mm) C	Weight (g)
84520	8 mm	6 Pt. Std. Metric	22.0	14.5	38.0	50
84521D	9 mm	6 Pt. Std. Metric	22.0	15.59	38.0	50
84522D	10 mm	6 Pt. Std. Metric	22.0	16.7	38.0	65
84523D	11 mm	6 Pt. Std. Metric	22.0	18.0	38.0	65
84524D	12 mm	6 Pt. Std. Metric	22.0	19.0	38.0	65
84525D	13 mm	6 Pt. Std. Metric	24.0	20.2	38.0	80
84526D	14 mm	6 Pt. Std. Metric	24.0	21.5	38.0	80
84527D	15 mm	6 Pt. Std. Metric	25.0	23.0	38.0	88
84528D	16 mm	6 Pt. Std. Metric	25.0	25.0	38.0	88
84529D	17 mm	6 Pt. Std. Metric	26.0	26.0	38.0	95
84530D	18 mm	6 Pt. Std. Metric	27.0	27.0	38.0	102
84531	19 mm	6 Pt. Std. Metric	28.0	28.0	38.0	106
84532	20 mm	6 Pt. Std. Metric	30.0	30.0	38.0	125
84533	21 mm	6 Pt. Std. Metric	30.0	30.0	38.0	125
84534	22 mm	6 Pt. Std. Metric	32.0	32.0	38.0	145
84535	23 mm	6 Pt. Std. Metric	33.0	33.0	38.0	154
84536	24 mm	6 Pt. Std. Metric	34.0	34.0	38.0	162
84537	25 mm	6 Pt. Std. Metric	36.0	36.0	42.0	201
84538	26 mm	6 Pt. Std. Metric	36.0	36.0	42.0	195
84539	28 mm	6 Pt. Std. Metric	38.0	38.0	42.0	224
84540	29 mm	6 Pt. Std. Metric	41.0	41.0	42.0	260
84541	30 mm	6 Pt. Std. Metric	38.0	42.0	42.0	250
84542	31 mm	6 Pt. Std. Metric	38.0	42.0	42.0	250
84543	32 mm	6 Pt. Std. Metric	38.0	44.0	42.0	260
84544	36 mm	6 Pt. Std. Metric	38.0	50.0	50.0	260
84515D	1-5/16"	6 Pt. Std. SAE	38.0	45.0	43.0	294
84516D	1-3/8"	6 Pt. Std. SAE	38.0	47.0	43.0	306
84517D	1-7/16"	6 Pt. Std. SAE	38.0	48.0	43.0	306
84518D	1-1/2"	6 Pt. Std. SAE	38.0	50.0	43.0	347

IMPACT SOCKETS 1/2" OPEN STOCK

1/2" OPEN STOCK

6 Pt. Deep Impact Sockets METRIC 1/2" DRIVE



Material No.	Size	Description	Drive End (mm) A	Wrench End (mm) B	Overall Length (mm) C	Weight (g)
84571 NEW PRODUCT	13 mm	6 Pt. Deep Metric	24.0	20.2	78.0	175
84572	14 mm	6 Pt. Deep Metric	24.0	21.5	78.0	168
84573	15 mm	6 Pt. Deep Metric	24.0	24.0	78.0	168
84574	16 mm	6 Pt. Deep Metric	25.0	25.0	78.0	194
84575D	17 mm	6 Pt. Deep Metric	26.0	26.0	78.0	190
84576	18 mm	6 Pt. Deep Metric	26.0	26.0	78.0	180
84577	19 mm	6 Pt. Deep Metric	28.0	28.0	78.0	220
84578	20 mm	6 Pt. Deep Metric	30.0	30.0	78.0	260
84579	21 mm	6 Pt. Deep Metric	30.0	30.0	78.0	245
84580	22 mm	6 Pt. Deep Metric	32.0	32.0	78.0	286
84581	23 mm	6 Pt. Deep Metric	32.0	32.0	78.0	277
84582	24 mm	6 Pt. Deep Metric	34.0	34.0	78.0	314
84583	25 mm	6 Pt. Deep Metric	36.0	36.0	78.0	360
84584	26 mm	6 Pt. Deep Metric	36.0	36.0	78.0	362
84585D	27 mm	6 Pt. Deep Metric	38.0	38.0	78.0	405
84586D	28 mm	6 Pt. Deep Metric	40.0	40.0	78.0	445
84587	29 mm	6 Pt. Deep Metric	40.0	40.0	78.0	435
84588	30 mm	6 Pt. Deep Metric	38.0	42.0	78.0	454
84589D	31 mm	6 Pt. Deep Metric	38.0	44.0	78.0	470
84590D	32 mm	6 Pt. Deep Metric	38.0	44.0	78.0	495

1/2" OPEN STOCK
IMPACT SOCKETS

1/2" OPEN STOCK



6 Pt. Deep Impact Sockets SAE 1/2" DRIVE

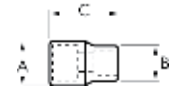

Material No.	Size	Description	Drive End (mm) A	Wrench End (mm) B	Overall Length (mm) C	Weight (g)
84546	3/8"	6 Pt. Deep SAE	22.0	16.0	78.0	150
84547	7/16"	6 Pt. Deep SAE	22.0	18.0	78.0	152
84548	1/2"	6 Pt. Deep SAE	22.0	18.0	78.0	152
84549	9/16"	6 Pt. Deep SAE	24.0	22.0	78.0	167
84550	5/8"	6 Pt. Deep SAE	25.0	25.0	78.0	182
84551	11/16"	6 Pt. Deep SAE	26.0	26.0	78.0	190
84552D	3/4"	6 Pt. Deep SAE	28.0	28.0	78.0	220
84553	13/16"	6 Pt. Deep SAE	30.0	30.0	78.0	245
84554D	7/8"	6 Pt. Deep SAE	32.0	32.0	78.0	283
84555D	15/16"	6 Pt. Deep SAE	34.0	34.0	78.0	320
84556	1"	6 Pt. Deep SAE	36.0	36.0	78.0	366
84557	1-1/16"	6 Pt. Deep SAE	38.0	38.0	78.0	415
84558	1-1/8"	6 Pt. Deep SAE	38.0	40.0	78.0	425
84560	1-1/4"	6 Pt. Deep SAE	38.0	44.0	78.0	489

1/2" OPEN STOCK
IMPACT SOCKETS

WRENCHES



Ratcheting Wrenches

Non-Ratcheting Wrenches

**RATCHETING
WRENCHES**

Surface Drive® box reduces fastener rounding

Ratcheting box end needs as little as 5° to move fasteners versus 30° for standard box end wrenches

Patented award-winning design

Hex head set screw, instead of being pinned

Flexible Head

XL - Up to 25% longer to access hard-to-reach fasteners

X-Beam™ allows you to apply force to the flat side of the wrench, reducing hand fatigue

XL X-Beam Flex Ratcheting Wrench™

AVAILABLE IN:



XL Combination



XL X-Beam™



XL Locking Flex



XL Spline



XL GearBox™



Reversible



Flex



Stubby Flex



Combination



Stubby



QuadBox™



Double Box



Half Moon



S-Shape



E-Torx®

WRENCHES

RATCHETING WRENCHES

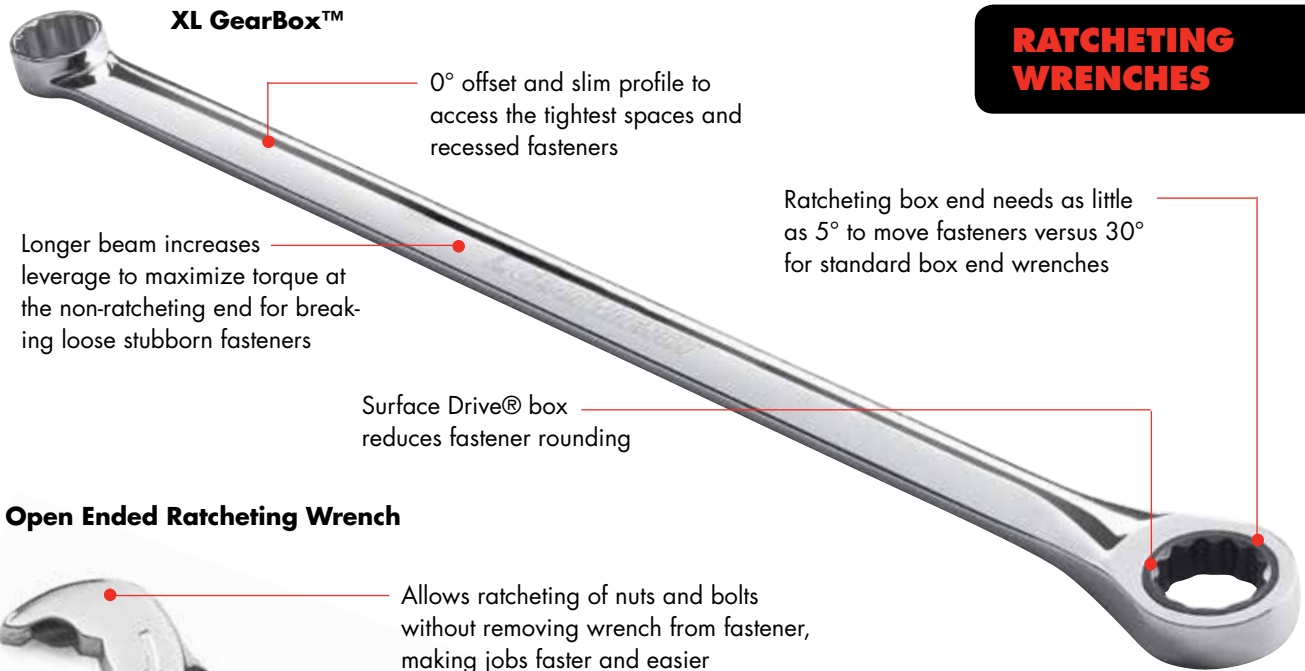

Open Ended Ratcheting Wrench

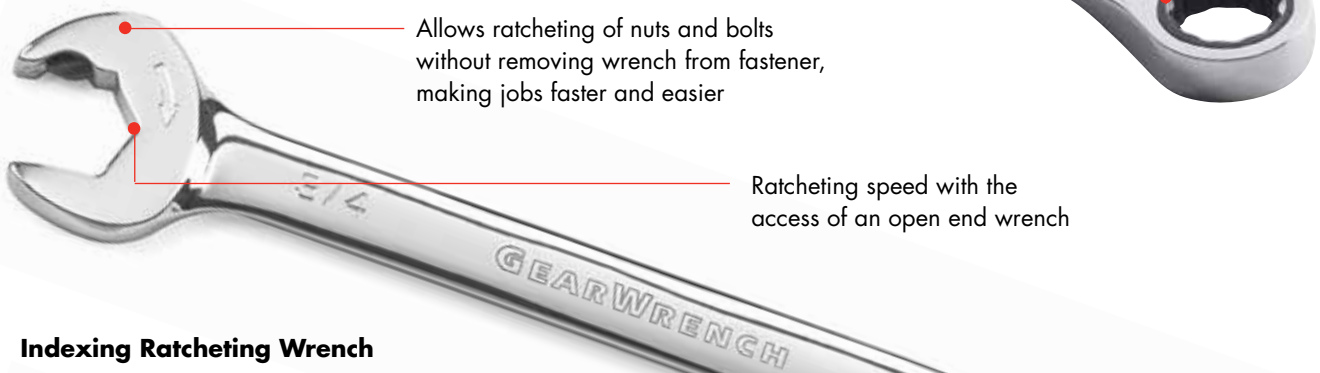

Indexing Ratcheting Wrench

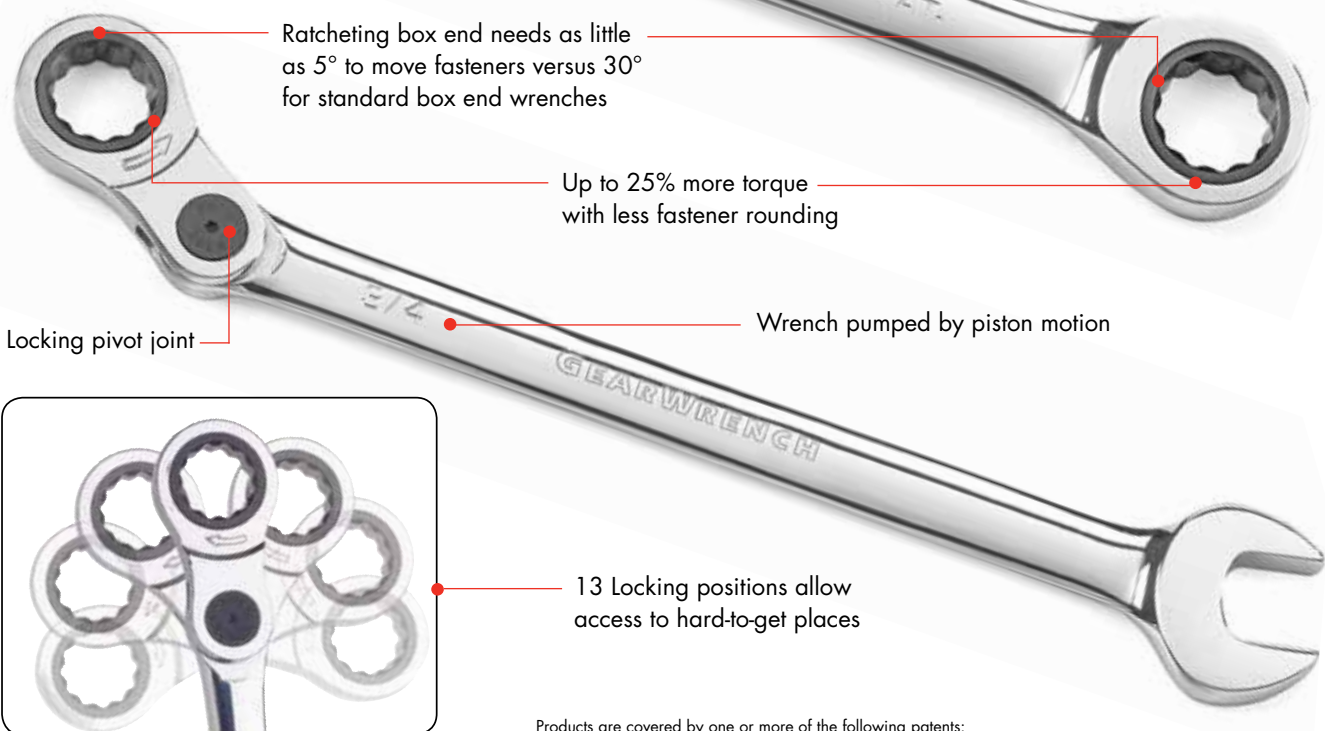

Products are covered by one or more of the following patents:
 • US 5,636,557 US 6,629,477 US 6,918,477 US 7,131,356 US 7,000,507
 US 7,165,480 US 6,868,709 US 7,231,851 US 6,840,141

WRENCHES

**COMBINATION RATCHETING WRENCH
- OPEN STOCK**



Open Stock - Combination Ratcheting Wrench METRIC

Packaging	Material No.	Opening Inches/Metric	Overall Length (mm) A	Width Open End (mm) B	Thickness Open End (mm) C	Width Box End (mm) D	Thickness Box End (mm) E	Weight (g)
Carded	9106	6 mm	125	15	4.6	15.5	6.5	32
Carded	9107	7 mm	133	16	4.8	15.8	6.5	40
Carded	9108D	8 mm	140	20	5.0	16.9	6.9	45
Carded	9109	9 mm	149	20	5.4	17.8	6.9	50
Carded	9110D	10 mm	159	22	5.7	19.8	7.7	68
Carded	9111	11 mm	165	24	6.4	21.7	8.2	68
Carded	9112	12 mm	171	27	7.4	23.0	8.6	91
Carded	9113D	13 mm	178	29	8.1	25.0	8.6	104
Carded	9114D	14 mm	190	31	8.3	26.2	9.4	123
Carded	9115D	15 mm	200	34	8.3	28.7	9.9	113
Carded	9116D	16 mm	208	35	8.8	30.5	10.3	150
Carded	9117D	17 mm	226	38	9.2	32.3	10.7	172
Carded	9118D	18 mm	237	40	9.4	33.2	11.2	207
Carded	9119	19 mm	248	42	9.5	34.0	11.2	213
Carded	9120	20 mm	292	46	9.9	39.0	13.0	353
Carded	9121	21 mm	292	46	9.9	39.0	13.0	367
Carded	9122	22 mm	292	46	9.9	39.0	13.0	363
Carded	9124	24 mm	333	53	10.9	45.5	14.5	522
Carded	9125D	25 mm	333	53	10.9	45.5	14.5	527
Carded	9127D	27 mm	359	57	14.5	49.0	15.5	599
Carded	9130D	30 mm	402	63	12.5	54.8	17.0	794
Carded	9132	32 mm	426	67	12.9	58.0	17.5	1002
Carded	9134D	34 mm	460	70	13.7	60.0	17.5	1184
Boxed	9136	36 mm	500	79	16.4	65.0	20.5	2018
Boxed	9141D	41 mm	575	87	18.0	68.0	22.0	2599
Boxed	9146D	46 mm	645	98	21.0	76.0	25.0	3592
Boxed	9150	50 mm	655	105	21.0	80.0	26.5	3982

PATENTED

OPEN STOCK
WRENCHES

**COMBINATION RATCHETING WRENCH
- OPEN STOCK**



Open Stock - Combination Ratcheting Wrench SAE

Material No.	Opening Inches/Metric	Overall Length (mm) A	Width Open End (mm) B	Thickness Open End (mm) C	Width Box End (mm) D	Thickness Box End (mm) E	Weight (g)
9008	1/4"	125	15	4.6	15.5	6.5	45
9010D	5/16"	140	20	5.0	16.9	6.9	54
9011D	11/32"	149	20	5.4	17.8	6.9	54
9012D	3/8"	159	22	5.7	19.8	7.7	64
9014	7/16"	165	24	6.4	21.7	8.2	77
9016D	1/2"	178	29	8.1	25.0	8.6	100
9018D	9/16"	190	31	8.3	26.2	9.4	104
9020	5/8"	208	35	8.8	30.5	10.3	150
9022	11/16"	226	38	9.2	32.3	10.7	172
9024	3/4"	248	42	9.5	34.0	11.2	213
9026D	13/16"	292	46	9.9	39.0	13.0	390
9028D	7/8"	292	46	9.9	39.0	13.0	363
9030	15/16"	333	53	10.9	45.5	14.5	531
9032	1"	333	53	10.9	45.5	14.5	522
9034	1-1/16"	359	57	14.5	49.0	15.5	599
9036	1-1/8"	402	63	12.5	54.8	17.0	894
9038D	1-1/4"	426	67	12.9	58.0	17.5	988
9060D	1-5/16"	460	70	13.7	60.0	17.5	1198
9062D	1-3/8"	460	70	13.7	60.0	17.5	1198
9040	1-7/16"	500	79	16.4	65.0	20.5	1751
9042	1-1/2"	500	79	16.4	65.0	20.5	1733
9044	1-9/16"	575	87	18.0	68.0	22.0	2351
9046D	1-5/8"	575	87	18.0	68.0	22.0	2332
9048	1-11/16"	615	92	20.0	72.0	23.5	2581
9050D	1-3/4"	615	92	20.0	72.0	23.5	2559
9052D	1-13/16"	645	98	21.0	76.0	25.0	3470
9054D	1-7/8"	645	98	21.0	76.0	25.0	3443
9056D	2"	655	105	21.0	80.0	26.5	3783

OPEN STOCK
WRENCHES

COMBINATION RATCHETING WRENCH SETS

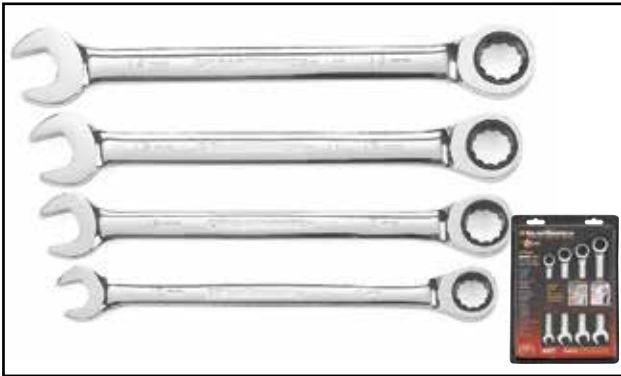

9404 - 4 Pc. Combination Ratcheting Wrench Set METRIC

Material No.	Description	
9110	10 mm	Combination Ratcheting Wrench
9112	12 mm	Combination Ratcheting Wrench
9113	13 mm	Combination Ratcheting Wrench
9114	14 mm	Combination Ratcheting Wrench



9304 - 4 Pc. Combination Ratcheting Wrench Set SAE

Material No.	Description	
9012	3/8"	Combination Ratcheting Wrench
9014	17/16"	Combination Ratcheting Wrench
9016	1/2"	Combination Ratcheting Wrench
9018	9/16"	Combination Ratcheting Wrench



93004D - 5 Pc. Combination Ratcheting Wrench Set METRIC

Material No.	Description	
9110	10 mm	Combination Ratcheting Wrench
9112	12 mm	Combination Ratcheting Wrench
9113	13 mm	Combination Ratcheting Wrench
9114	14 mm	Combination Ratcheting Wrench
9115	15 mm	Combination Ratcheting Wrench



93005 - 5 Pc. Combination Ratcheting Wrench Set SAE

Material No.	Description	
9012	3/8"	Combination Ratcheting Wrench
9014	7/16"	Combination Ratcheting Wrench
9016	1/2"	Combination Ratcheting Wrench
9018	9/16"	Combination Ratcheting Wrench
9020	5/8"	Combination Ratcheting Wrench

SETS
WRENCHES

PATENTED

COMBINATION RATCHETING WRENCH SETS

9417 - 7 Pc. Combination Ratcheting Wrench Set METRIC

Material No.	Description	
9108	8 mm	Combination Ratcheting Wrench
9110	10 mm	Combination Ratcheting Wrench
9112	12 mm	Combination Ratcheting Wrench
9113	13 mm	Combination Ratcheting Wrench
9114	14 mm	Combination Ratcheting Wrench
9115	15 mm	Combination Ratcheting Wrench
9118	18 mm	Combination Ratcheting Wrench



9317 - 7 Pc. Combination Ratcheting Wrench Set SAE

Material No.	Description	
9010	5/16"	Combination Ratcheting Wrench
9012	3/8"	Combination Ratcheting Wrench
9014	7/16"	Combination Ratcheting Wrench
9016	1/2"	Combination Ratcheting Wrench
9018	9/16"	Combination Ratcheting Wrench
9020	5/8"	Combination Ratcheting Wrench
9024	3/4"	Combination Ratcheting Wrench



9418 - 10 Pc. Combination Ratcheting Wrench Set SAE/METRIC

Material No.	Description	
9010	5/16"	Combination Ratcheting Wrench
9012	3/8"	Combination Ratcheting Wrench
9014	7/16"	Combination Ratcheting Wrench
9016	1/2"	Combination Ratcheting Wrench
9018	9/16"	Combination Ratcheting Wrench
9108	8 mm	Combination Ratcheting Wrench
9110	10 mm	Combination Ratcheting Wrench
9112	12 mm	Combination Ratcheting Wrench
9113	13 mm	Combination Ratcheting Wrench
9114	14 mm	Combination Ratcheting Wrench



SETS
WRENCHES

COMBINATION RATCHETING WRENCH SETS



9416 - 16 Pc. Combination Ratcheting Wrench Set METRIC

Material No.	Description	
9108	8 mm	Combination Ratcheting Wrench
9109	9 mm	Combination Ratcheting Wrench
9110	10 mm	Combination Ratcheting Wrench
9111	11 mm	Combination Ratcheting Wrench
9112	12 mm	Combination Ratcheting Wrench
9113	13 mm	Combination Ratcheting Wrench
9114	14 mm	Combination Ratcheting Wrench
9115	15 mm	Combination Ratcheting Wrench
9116	16 mm	Combination Ratcheting Wrench
9117	17 mm	Combination Ratcheting Wrench
9118	18 mm	Combination Ratcheting Wrench
9119	19 mm	Combination Ratcheting Wrench
9120	20 mm	Combination Ratcheting Wrench
9121	21 mm	Combination Ratcheting Wrench
9122	22 mm	Combination Ratcheting Wrench
9124	24 mm	Combination Ratcheting Wrench

SETS
WRENCHES



9312 - 13 Pc. Combination Ratcheting Wrench Set SAE

Material No.	Description	
9008	1/4"	Combination Ratcheting Wrench
9010	5/16"	Combination Ratcheting Wrench
9012	3/8"	Combination Ratcheting Wrench
9014	7/16"	Combination Ratcheting Wrench
9016	1/2"	Combination Ratcheting Wrench
9018	9/16"	Combination Ratcheting Wrench
9020	5/8"	Combination Ratcheting Wrench
9022	11/16"	Combination Ratcheting Wrench
9024	3/4"	Combination Ratcheting Wrench
9026	13/16"	Combination Ratcheting Wrench
9028	7/8"	Combination Ratcheting Wrench
9030	15/16"	Combination Ratcheting Wrench
9032	1"	Combination Ratcheting Wrench

PATENTED

COMBINATION RATCHETING WRENCH SETS

9412 - 12 Pc. Combination Ratcheting Wrench Set METRIC

Material No.	Description
9108	8 mm Combination Ratcheting Wrench
9109	9 mm Combination Ratcheting Wrench
9110	10 mm Combination Ratcheting Wrench
9111	11 mm Combination Ratcheting Wrench
9112	12 mm Combination Ratcheting Wrench
9113	13 mm Combination Ratcheting Wrench
9114	14 mm Combination Ratcheting Wrench
9115	15 mm Combination Ratcheting Wrench
9116	16 mm Combination Ratcheting Wrench
9117	17 mm Combination Ratcheting Wrench
9118	18 mm Combination Ratcheting Wrench
9119	19 mm Combination Ratcheting Wrench



9308D - 8 Pc. Combination Ratcheting Wrench Set SAE

Material No.	Description
9010	5/16" Combination Ratcheting Wrench
9012	3/8" Combination Ratcheting Wrench
9014	7/16" Combination Ratcheting Wrench
9016	1/2" Combination Ratcheting Wrench
9018	9/16" Combination Ratcheting Wrench
9020	5/8" Combination Ratcheting Wrench
9022	11/16" Combination Ratcheting Wrench
9024	3/4" Combination Ratcheting Wrench



83052 - 10 Pc. Wrench Set Ratcheting Combination METRIC

Description

Combination Ratcheting Wrench: 8mm, 10mm, 11mm, 12mm, 13mm, 14mm, 15mm, 16mm, 17mm, 19mm

Metal Case with EVA Tray Insert: 168mm x 360mm



83053 - 10 Pc. Wrench Set Ratcheting Combination SAE

Description

Combination Ratcheting Wrench: 1/4", 5/16", 3/8", 7/16", 1/2", 9/16", 5/8", 11/16", 3/4", 13/16"

Metal Case with EVA Tray Insert: 168mm x 360mm



83075 - 24 Pc. Ratcheting Wrench Set METRIC/SAE

Description

Combination Ratcheting Wrench METRIC: 7mm, 8mm, 9mm, 10mm, 11mm, 12mm, 13mm, 14mm, 15mm, 16mm, 17mm, 19mm, 20mm, 21mm, 22mm

Combination Ratcheting Wrench SAE: 5/16", 3/8", 7/16", 1/2", 9/16", 5/8", 11/16", 3/4", 13/16"

EVA Tray Included: uncut 655mm x 395mm, cut = 557mm x 360mm

PATENTED



Fits drawer type **A** as shown on page 34.

**REVERSIBLE COMBINATION
RATCHETING WRENCH - OPEN STOCK**



Open Stock - Reversible Combination Ratcheting Wrench METRIC/SAE

Material No.	Opening Inches/Metric	Overall Length (mm) A	Width Open End (mm) B	Thickness Open End (mm) C	Width Box End (mm) D	Thickness Box End (mm) E	Weight (g)
9608	8 mm	138.0	20.0	5.0	16.9	6.9	33
9609D	9 mm	147.2	20.0	5.4	17.8	6.9	41
9610D	10 mm	156.7	22.0	5.7	19.8	7.7	52
9611	11 mm	162.9	24.0	6.4	21.7	8.2	73
9612D	12 mm	169.1	26.6	7.4	23.0	8.6	76
9613D	13 mm	175.3	29.0	8.1	25.0	8.6	88
9614D	14 mm	187.9	31.0	8.3	26.2	9.4	110
9615D	15 mm	196.8	34.0	8.3	28.7	9.9	128
9616D	16 mm	205.4	35.0	8.8	30.5	10.3	158
9617	17 mm	222.0	38.0	9.2	32.3	10.7	182
9618D	18 mm	232.9	41.0	9.4	33.2	11.2	209
9619	19 mm	243.7	42.0	9.5	34.0	11.2	243
9621D	21 mm	291.5	46.0	9.9	39.0	13.0	356
9622	22 mm	291.5	46.0	9.9	39.0	13.0	345
9624D	24 mm	355.6	53.0	10.9	45.5	14.5	532
9625	25 mm	355.6	53.0	10.9	45.5	14.5	522
9525D	5/16"	138.0	19.5	5.0	16.9	6.9	360
9521D	11/32"	147.2	19.5	5.4	17.8	6.9	408
9526	3/8"	156.7	21.9	5.7	19.8	7.7	62
9527	7/16"	162.9	24.2	6.4	21.7	8.2	70
9528	1/2"	175.3	29.0	8.1	25.0	8.6	93
9529	9/16"	187.9	31.0	8.3	26.2	9.4	110
9530	5/8"	205.4	35.0	8.8	30.5	10.3	156
9531DD	11/16"	222.0	38.0	9.2	32.3	10.7	181
9532D	3/4"	243.7	42.0	9.5	34.0	11.2	243
9534D	13/16"	291.5	46.0	9.9	39.0	13.0	356
9538	7/8"	291.5	46.0	9.9	39.0	13.0	345
9539	15/16"	355.6	53.0	10.9	45.5	14.5	532
9540	1"	355.6	53.0	10.9	45.5	14.5	598

PATENTED

OPEN STOCK
WRENCHES

REVERSIBLE COMBINATION RATCHETING WRENCH SETS

9543 - 8 Pc. Reversible Combination Ratcheting Wrench Set METRIC

Material No.	Description
9608	8 mm Reversible Combination Ratcheting Wrench
9610	10 mm Reversible Combination Ratcheting Wrench
9612	12 mm Reversible Combination Ratcheting Wrench
9613	13 mm Reversible Combination Ratcheting Wrench
9614	14 mm Reversible Combination Ratcheting Wrench
9615	15 mm Reversible Combination Ratcheting Wrench
9617	17 mm Reversible Combination Ratcheting Wrench
9619	19 mm Reversible Combination Ratcheting Wrench



9533DD - 8 Pc. Reversible Combination Ratcheting Wrench Set SAE

Material No.	Description
9525	5/16" Reversible Combination Ratcheting Wrench
9526	3/8" Reversible Combination Ratcheting Wrench
9527	7/16" Reversible Combination Ratcheting Wrench
9528	1/2" Reversible Combination Ratcheting Wrench
9529	9/16" Reversible Combination Ratcheting Wrench
9530	5/8" Reversible Combination Ratcheting Wrench
9531	11/16" Reversible Combination Ratcheting Wrench
9532	3/4" Reversible Combination Ratcheting Wrench



9620D - 12 Pc. Reversible Combination Ratcheting Wrench Set METRIC

Material No.	Description
9608	8 mm Reversible Combination Ratcheting Wrench
9609	9 mm Reversible Combination Ratcheting Wrench
9610	10 mm Reversible Combination Ratcheting Wrench
9611	11 mm Reversible Combination Ratcheting Wrench
9612	12 mm Reversible Combination Ratcheting Wrench
9613	13 mm Reversible Combination Ratcheting Wrench
9614	14 mm Reversible Combination Ratcheting Wrench
9615	15 mm Reversible Combination Ratcheting Wrench
9616	16 mm Reversible Combination Ratcheting Wrench
9617	17 mm Reversible Combination Ratcheting Wrench
9618	18 mm Reversible Combination Ratcheting Wrench
9619	19 mm Reversible Combination Ratcheting Wrench



SETS
WRENCHES

PATENTED

REVERSIBLE COMBINATION RATCHETING WRENCH SETS



9602 - 16 Pc. Reversible Combination Ratcheting Wrench Set METRIC

Material No.	Description	
9608	8 mm	Reversible Combination Ratcheting Wrench
9609	9 mm	Reversible Combination Ratcheting Wrench
9610	10 mm	Reversible Combination Ratcheting Wrench
9611	11 mm	Reversible Combination Ratcheting Wrench
9612	12 mm	Reversible Combination Ratcheting Wrench
9613	13 mm	Reversible Combination Ratcheting Wrench
9614	14 mm	Reversible Combination Ratcheting Wrench
9615	15 mm	Reversible Combination Ratcheting Wrench
9616	16 mm	Reversible Combination Ratcheting Wrench
9617	17 mm	Reversible Combination Ratcheting Wrench
9618	18 mm	Reversible Combination Ratcheting Wrench
9619	19 mm	Reversible Combination Ratcheting Wrench
9621	21 mm	Reversible Combination Ratcheting Wrench
9622	22 mm	Reversible Combination Ratcheting Wrench
9624	24 mm	Reversible Combination Ratcheting Wrench
9625	25 mm	Reversible Combination Ratcheting Wrench



9509N - 13 Pc. Reversible Combination Ratcheting Wrench Set SAE

Material No.	Description	
9525	5/16"	Reversible Combination Ratcheting Wrench
9521	11/32"	Reversible Combination Ratcheting Wrench
9526	3/8"	Reversible Combination Ratcheting Wrench
9527	7/16"	Reversible Combination Ratcheting Wrench
9528	1/2"	Reversible Combination Ratcheting Wrench
9529	9/16"	Reversible Combination Ratcheting Wrench
9530	5/8"	Reversible Combination Ratcheting Wrench
9531	11/16"	Reversible Combination Ratcheting Wrench
9532	3/4"	Reversible Combination Ratcheting Wrench
9534	13/16"	Reversible Combination Ratcheting Wrench
9538	7/8"	Reversible Combination Ratcheting Wrench
9539	15/16"	Reversible Combination Ratcheting Wrench
9540	1"	Reversible Combination Ratcheting Wrench

SETS
WRENCHES

PATENTED

REVERSIBLE COMBINATION RATCHETING WRENCH SETS

9602R - 16 Pc. Reversible Combination Ratcheting Wrench Set Roll METRIC

Material No.	Description	
9608	8 mm	Reversible Combination Ratcheting Wrench
9609	9 mm	Reversible Combination Ratcheting Wrench
9610	10 mm	Reversible Combination Ratcheting Wrench
9611	11 mm	Reversible Combination Ratcheting Wrench
9612	12 mm	Reversible Combination Ratcheting Wrench
9613	13 mm	Reversible Combination Ratcheting Wrench
9614	14 mm	Reversible Combination Ratcheting Wrench
9615	15 mm	Reversible Combination Ratcheting Wrench
9616	16 mm	Reversible Combination Ratcheting Wrench
9617	17 mm	Reversible Combination Ratcheting Wrench
9618	18 mm	Reversible Combination Ratcheting Wrench
9619	19 mm	Reversible Combination Ratcheting Wrench
9621	21 mm	Reversible Combination Ratcheting Wrench
9622	22 mm	Reversible Combination Ratcheting Wrench
9624	24 mm	Reversible Combination Ratcheting Wrench
9625	25 mm	Reversible Combination Ratcheting Wrench



9509R - 13 Pc. Reversible Combination Ratcheting Wrench Set Roll SAE

Material No.	Description	
9525	5/16"	Reversible Combination Ratcheting Wrench
9521	11/32"	Reversible Combination Ratcheting Wrench
9526	3/8"	Reversible Combination Ratcheting Wrench
9527	7/16"	Reversible Combination Ratcheting Wrench
9528	1/2"	Reversible Combination Ratcheting Wrench
9529	9/16"	Reversible Combination Ratcheting Wrench
9530	5/8"	Reversible Combination Ratcheting Wrench
9531	11/16"	Reversible Combination Ratcheting Wrench
9532	3/4"	Reversible Combination Ratcheting Wrench
9534	13/16"	Reversible Combination Ratcheting Wrench
9538	7/8"	Reversible Combination Ratcheting Wrench
9539	15/16"	Reversible Combination Ratcheting Wrench
9540	1"	Reversible Combination Ratcheting Wrench



83054 - 10 Pc. Wrench Set Ratcheting Reversible Combination METRIC

Description
 Combination Ratcheting Reversible Wrench: 8mm, 10mm, 11mm, 12mm, 13mm, 14mm, 15mm, 16mm, 17mm, 19mm
 Metal Case with EVA Tray Insert: 168mm x 360mm



SETS
WRENCHES

PATENTED

**OPEN END RATCHETING WRENCH
- OPEN STOCK**

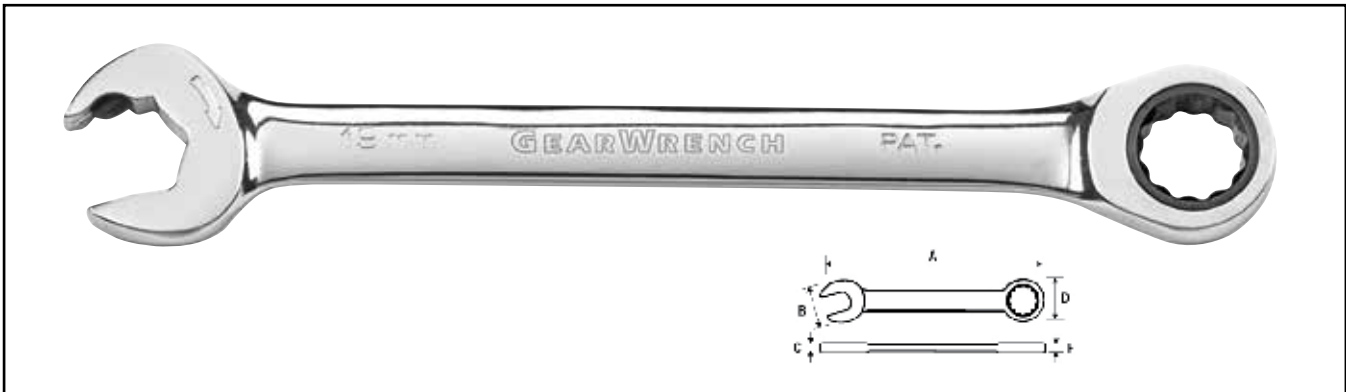

Open Stock - Open End Ratcheting Wrenches METRIC/SAE

Material No.	Opening Metric/Inches	Overall Length (mm) A	Width Open End (mm) B	Thickness Open End (mm) C	Width Box End (mm) D	Thickness Box End (mm) E	Weight (g)
85508	8 mm	139.9	16.71	5.004	15.87	6.502	29
85509	9 mm	149.4	18.82	5.309	17.50	6.908	41
85510	10 mm	158.9	20.88	5.588	19.05	7.289	56
85511	11 mm	165.3	22.99	6.096	20.60	7.696	64
85512D	12 mm	171.6	25.09	6.604	21.72	8.205	80
85513	13 mm	178.0	27.15	7.697	23.62	8.611	84
85514D	14 mm	190.6	29.26	7.798	25.91	8.992	107
85515	15 mm	199.5	31.32	8.001	27.18	9.398	130
85516	16 mm	208.3	33.43	8.789	28.70	9.906	154
85517	17 mm	225.5	35.54	9.398	30.51	10.313	188
85518	18 mm	236.6	37.59	9.398	31.48	10.694	194
85519	19 mm	248.0	39.70	9.804	32.46	11.201	321
85570	5/16"	139.9	16.72	5.00	15.88	6.502	21
85572	3/8"	158.9	20.88	5.588	19.05	7.289	28
85574	7/16"	165.3	22.99	6.096	20.59	7.696	32
85576	1/2"	178.0	27.15	7.696	23.62	8.611	42
85578	9/16"	190.6	29.26	7.798	25.90	8.992	55
85580	5/8"	208.3	33.43	8.789	28.70	9.906	65
85582	11/16"	225.5	35.54	9.398	30.51	10.313	89
85584	3/4"	248.0	39.70	9.804	32.46	11.201	124

OPEN STOCK
WRENCHES

OPEN END RATCHETING WRENCH SETS

85597 - 12 Pc. Open End Ratcheting Set METRIC

Material No.	Description
85508	8 mm Ratcheting Open End Wrench
85509	9 mm Ratcheting Open End Wrench
85510	10 mm Ratcheting Open End Wrench
85511	11 mm Ratcheting Open End Wrench
85512	12 mm Ratcheting Open End Wrench
85513	13 mm Ratcheting Open End Wrench
85514	14 mm Ratcheting Open End Wrench
85515	15 mm Ratcheting Open End Wrench
85516	16 mm Ratcheting Open End Wrench
85517	17 mm Ratcheting Open End Wrench
85518	18 mm Ratcheting Open End Wrench
85519	19 mm Ratcheting Open End Wrench



85599 - 8 Pc. Open End Ratcheting Set SAE

Material No.	Description
85570	5/16" Ratcheting Open End Wrench
85572	3/8" Ratcheting Open End Wrench
85574	7/16" Ratcheting Open End Wrench
85576	1/2" Ratcheting Open End Wrench
85578	9/16" Ratcheting Open End Wrench
85580	5/8" Ratcheting Open End Wrench
85582	11/16" Ratcheting Open End Wrench
85584	3/4" Ratcheting Open End Wrench



83056 - 10 Pc. Wrench Set Open End Ratcheting Combination METRIC

Description

Open Ended Ratcheting Combination Wrench: 8mm, 10mm, 11mm, 12mm, 13mm, 14mm, 15mm, 16mm, 17mm, 19mm

Metal Case with EVA Tray Insert: 168mm x 360mm



SETS
WRENCHES

PATENTED

FLEX COMBINATION RATCHETING WRENCH - OPEN STOCK



Open Stock - Flex Combination Ratcheting Wrench METRIC/SAE

Material No.	Opening Metric/Inches	Overall Length (mm) A	Width Open End (mm) B	Thickness Open End (mm) C	Width Box End (mm) D	Thickness Box End (mm) E	Weight (g)
9908D	8 mm	139.9	19.5	5.0	16.89	6.90	39.01
9909D	9 mm	149.4	19.5	5.41	17.81	6.90	46.72
9910D	10 mm	158.8	21.89	5.68	19.81	7.70	62.59
9911D	11 mm	165.2	24.21	6.40	21.69	7.70	73.48
9912D	12 mm	144.2	26.60	7.40	23.01	8.61	89.35
9913D	13 mm	177.9	29.10	8.10	25.00	8.61	107.9
9914D	14 mm	190.6	31.18	8.30	26.29	9.40	126.5
9915D	15 mm	199.5	33.71	8.30	28.70	9.90	151.5
9916D	16 mm	208.2	34.5	8.78	30.50	10.31	173.7
9917	17 mm	225.5	37.89	9.19	32.31	10.70	204.5
9918	18 mm	236.6	40.20	9.40	33.19	11.20	234.5
9919D	19 mm	248.0	41.30	9.49	34.01	11.20	267.6
9921D	21 mm	291.5	46.0	9.91	38.99	13.0	401.8
9922D	22 mm	291.5	46.0	9.91	38.99	13.0	393.7
9924D	24 mm	333.1	52.18	10.90	45.49	14.50	594.2
9925D	25 mm	355.6	52.19	10.90	45.49	14.50	521.6
9704D	11/32"	149.4	19.50	5.41	17.81	6.90	49.89
9705	5/16"	139.9	19.50	5.00	16.89	6.90	39.46
9706	3/8"	158.8	21.9	5.68	19.81	7.70	62.59
9707	7/16"	165.2	24.2	6.0	21.69	7.70	76.20
9708	1/2"	177.9	29.1	8.10	25.00	8.61	107.9
9709	9/16"	190.6	31.19	8.31	26.29	9.40	127.9
9710	5/8"	208.2	34	8.79	30.51	10.31	173.7
9711	11/16"	225.5	37.49	9.19	32.31	10.70	203.2
9712	3/4"	248.0	41.30	9.49	34.01	11.20	266.7
9713	13/16"	291.5	46.00	9.90	38.99	13.00	408.2
9714D	7/8"	291.5	46.00	9.90	38.99	13.00	391.9
9715D	15/16"	333.1	52.19	10.90	45.49	14.50	596.9
9716D	1"	333.1	52.19	10.90	45.49	14.50	586.0

PATENTED

OPEN STOCK
WRENCHES

FLEX COMBINATION RATCHETING WRENCH SETS

9900D - 7 Pc. Flex Combination Ratcheting Wrench Set METRIC

Material No.	Description
9910	10 mm Flex Combination Ratcheting Wrench
9912	12 mm Flex Combination Ratcheting Wrench
9913	13 mm Flex Combination Ratcheting Wrench
9914	14 mm Flex Combination Ratcheting Wrench
9915	15 mm Flex Combination Ratcheting Wrench
9917	17 mm Flex Combination Ratcheting Wrench
9919	19 mm Flex Combination Ratcheting Wrench



9700 - 7 Pc. Flex Combination Ratcheting Wrench Set SAE

Material No.	Description
9706	3/8" Flex Combination Ratcheting Wrench
9707	7/16" Flex Combination Ratcheting Wrench
9708	1/2" Flex Combination Ratcheting Wrench
9709	9/16" Flex Combination Ratcheting Wrench
9710	5/8" Flex Combination Ratcheting Wrench
9711	11/16" Flex Combination Ratcheting Wrench
9712	3/4" Flex Combination Ratcheting Wrench



9901D - 12 Pc. Flex Combination Ratcheting Wrench Set METRIC

Material No.	Description
9908	8 mm Flex Combination Ratcheting Wrench
9909	9 mm Flex Combination Ratcheting Wrench
9910	10 mm Flex Combination Ratcheting Wrench
9911	11 mm Flex Combination Ratcheting Wrench
9912	12 mm Flex Combination Ratcheting Wrench
9913	13 mm Flex Combination Ratcheting Wrench
9914	14 mm Flex Combination Ratcheting Wrench
9915	15 mm Flex Combination Ratcheting Wrench
9916	16 mm Flex Combination Ratcheting Wrench
9917	17 mm Flex Combination Ratcheting Wrench
9918	18 mm Flex Combination Ratcheting Wrench
9919	19 mm Flex Combination Ratcheting Wrench



SETS
WRENCHES

PATENTED

FLEX COMBINATION RATCHETING WRENCH SETS



9701 - 8 Pc. Flex Combination Ratcheting Wrench Set SAE

Material No.	Description
9705	5/16" Flex Combination Ratcheting Wrench
9706	3/8" Flex Combination Ratcheting Wrench
9707	7/16" Flex Combination Ratcheting Wrench
9708	1/2" Flex Combination Ratcheting Wrench
9709	9/16" Flex Combination Ratcheting Wrench
9710	5/8" Flex Combination Ratcheting Wrench
9711	11/16" Flex Combination Ratcheting Wrench
9712	3/4" Flex Combination Ratcheting Wrench



9902D - 16 Pc. Flex Combination Ratcheting Wrench Set METRIC

Material No.	Description
9908	8 mm Flex Combination Ratcheting Wrench
9909	9 mm Flex Combination Ratcheting Wrench
9910	10 mm Flex Combination Ratcheting Wrench
9911	11 mm Flex Combination Ratcheting Wrench
9912	12 mm Flex Combination Ratcheting Wrench
9913	13 mm Flex Combination Ratcheting Wrench
9914	14 mm Flex Combination Ratcheting Wrench
9915	15 mm Flex Combination Ratcheting Wrench
9916	16 mm Flex Combination Ratcheting Wrench
9917	17 mm Flex Combination Ratcheting Wrench
9918	18 mm Flex Combination Ratcheting Wrench
9919	19 mm Flex Combination Ratcheting Wrench
9921	21 mm Flex Combination Ratcheting Wrench
9922	22 mm Flex Combination Ratcheting Wrench
9924	24 mm Flex Combination Ratcheting Wrench
9925	25 mm Flex Combination Ratcheting Wrench



9702D - 13 Pc. Flex Combination Ratcheting Wrench Set SAE

Material No.	Description
9705	5/16" Flex Combination Ratcheting Wrench
9704	11/32" Flex Combination Ratcheting Wrench
9706	3/8" Flex Combination Ratcheting Wrench
9707	7/16" Flex Combination Ratcheting Wrench
9708	1/2" Flex Combination Ratcheting Wrench
9709	9/16" Flex Combination Ratcheting Wrench
9710	5/8" Flex Combination Ratcheting Wrench
9711	11/16" Flex Combination Ratcheting Wrench
9712	3/4" Flex Combination Ratcheting Wrench
9713	13/16" Flex Combination Ratcheting Wrench
9714	7/8" Flex Combination Ratcheting Wrench
9715	15/16" Flex Combination Ratcheting Wrench
9716	1" Flex Combination Ratcheting Wrench

PATENTED

SETS
WRENCHES

STUBBY COMBINATION RATCHETING WRENCH - OPEN STOCK



Open Stock - Stubby Combination Ratcheting Wrench METRIC

Item No.	Opening Metric	Overall Length (mm) A	Width Open End (mm) B	Thickness Open End (mm) C	Width Box End (mm) D	Thickness Box End (mm) E	Weight (g)
9510DD	10 mm	94.0	21.89	0.224	0.780	0.303	73
9511D	11 mm	102.0	24.20	0.252	0.854	0.323	99
9512D	12 mm	105.0	26.60	0.291	0.906	0.339	115
9513D	13 mm	107.0	29.10	0.319	0.984	0.339	128
9514D	14 mm	114.0	31.19	0.327	1.035	0.370	158
9516D	16 mm	122.0	34.49	0.346	1.201	0.406	207
9517D	17 mm	126.0	37.89	0.362	1.272	0.421	244
9518D	18 mm	130.0	1.583	0.370	1.307	0.441	282
9519D	19 mm	138.0	1.626	0.374	1.339	0.441	316

OPEN STOCK
WRENCHES

STUBBY COMBINATION RATCHETING WRENCH SETS



9520D - 10 Pc. Stubby Combination Ratcheting Wrench Set METRIC

Material No.	Description	
9510	10 mm	Stubby Combination Ratcheting Wrench
9511	11 mm	Stubby Combination Ratcheting Wrench
9512	12 mm	Stubby Combination Ratcheting Wrench
9513	13 mm	Stubby Combination Ratcheting Wrench
9514	14 mm	Stubby Combination Ratcheting Wrench
9515	15 mm	Stubby Combination Ratcheting Wrench
9516	16 mm	Stubby Combination Ratcheting Wrench
9517	17 mm	Stubby Combination Ratcheting Wrench
9518	18 mm	Stubby Combination Ratcheting Wrench
9519	19 mm	Stubby Combination Ratcheting Wrench



9507D - 7 Pc. Stubby Combination Ratcheting Wrench Set SAE

Material No.	Description	
9500	3/8"	Stubby Combination Ratcheting Wrench
9501	7/16"	Stubby Combination Ratcheting Wrench
9502	1/2"	Stubby Combination Ratcheting Wrench
9503	9/16"	Stubby Combination Ratcheting Wrench
9504	5/8"	Stubby Combination Ratcheting Wrench
9505	11/16"	Stubby Combination Ratcheting Wrench
9506	3/4"	Stubby Combination Ratcheting Wrench

SETS
WRENCHES

PATENTED

STUBBY FLEX COMBINATION RATCHETING WRENCH SETS

9550 - 10 Pc. Stubby Flex Combination Ratcheting Wrench Set METRIC

Material No.	Description
9551	10 mm Stubby Flex Combination Ratcheting Wrench
9552	11 mm Stubby Flex Combination Ratcheting Wrench
9553	12 mm Stubby Flex Combination Ratcheting Wrench
9554	13 mm Stubby Flex Combination Ratcheting Wrench
9555	14 mm Stubby Flex Combination Ratcheting Wrench
9556	15 mm Stubby Flex Combination Ratcheting Wrench
9557	16 mm Stubby Flex Combination Ratcheting Wrench
9558	17 mm Stubby Flex Combination Ratcheting Wrench
9559	18 mm Stubby Flex Combination Ratcheting Wrench
9560	19 mm Stubby Flex Combination Ratcheting Wrench



9570 - 7 Pc. Stubby Flex Combination Ratcheting Wrench Set SAE

Material No.	Description
9571	3/8" Stubby Flex Combination Ratcheting Wrench
9572	7/16" Stubby Flex Combination Ratcheting Wrench
9573	1/2" Stubby Flex Combination Ratcheting Wrench
9574	9/16" Stubby Flex Combination Ratcheting Wrench
9575	5/8" Stubby Flex Combination Ratcheting Wrench
9576	11/16" Stubby Flex Combination Ratcheting Wrench
9577	3/4" Stubby Flex Combination Ratcheting Wrench



SETS
WRENCHES

PATENTED

INDEXING COMBINATION RATCHETING WRENCH SETS



85488 - 12 Pc. Indexing Combination Wrench Set METRIC

Material No.	Description
85418	8 mm Indexing Combination Wrench
85439	9 mm Indexing Combination Wrench
85440	10 mm Indexing Combination Wrench
85441	11 mm Indexing Combination Wrench
85442	12 mm Indexing Combination Wrench
85443	13 mm Indexing Combination Wrench
85444	14 mm Indexing Combination Wrench
85445	15 mm Indexing Combination Wrench
85446	16 mm Indexing Combination Wrench
85447	17 mm Indexing Combination Wrench
85448	18 mm Indexing Combination Wrench
85449	19 mm Indexing Combination Wrench



85498 - 8 Pc. Indexing Combination Wrench Set SAE

Material No.	Description
85450	5/16" Indexing Combination Wrench
85452	3/8" Indexing Combination Wrench
85454	7/16" Indexing Combination Wrench
85456	1/2" Indexing Combination Wrench
85458	9/16" Indexing Combination Wrench
85460	5/8" Indexing Combination Wrench
85462	11/16" Indexing Combination Wrench
85464	3/4" Indexing Combination Wrench

SETS
WRENCHES

HALF MOON & S-SHAPE RATCHETING WRENCH SETS

9850 - 5 Pc. Half Moon Reversible Double Box Ratcheting Wrench Set METRIC

Material No.	Description
9851	10 x 12 mm Half Moon Ratcheting Wrench
9852	11 x 13 mm Half Moon Ratcheting Wrench
9853	14 x 16 mm Half Moon Ratcheting Wrench
9854	15 x 17 mm Half Moon Ratcheting Wrench
9855	19 x 22 mm Half Moon Ratcheting Wrench



9840D - 4 Pc. Half Moon Reversible Double Box Ratcheting Wrench Set SAE

Material No.	Description
9841	3/8" x 7/16" Half Moon Ratcheting Wrench
9842	1/2" x 9/16" Half Moon Ratcheting Wrench
9843	5/8" x 11/16" Half Moon Ratcheting Wrench
9844	3/4" x 7/8" Half Moon Ratcheting Wrench



85299 - 5 Pc. S-Shape Reversible Double Box Ratcheting Wrench Set METRIC

Material No.	Description
85222	10 x 12 mm S-Shape Ratcheting Wrench
85224	11 x 13 mm S-Shape Ratcheting Wrench
85230	14 x 16 mm S-Shape Ratcheting Wrench
85232	15 x 17 mm S-Shape Ratcheting Wrench
85241	19 x 22 mm S-Shape Ratcheting Wrench



85399 - 4 Pc. S-Shape Reversible Double Box Ratcheting Wrench Set SAE

Material No.	Description
85326	3/8" x 7/16" S-Shape Ratcheting Wrench
85334	1/2" x 9/16" S-Shape Ratcheting Wrench
85342	5/8" x 11/16" S-Shape Ratcheting Wrench
85352	3/4" x 7/8" S-Shape Ratcheting Wrench



PATENTED

SETS
WRENCHES

FLARE NUT RATCHETING WRENCH SETS



89101D - 6 Pc. Ratcheting Flex Flare Nut Wrench Set METRIC

Material No.	Description
89102	9 x 11 mm Ratcheting Flex Flare Nut Wrench
89103	10 x 12 mm Ratcheting Flex Flare Nut Wrench
89104	13 x 14 mm Ratcheting Flex Flare Nut Wrench
89105	15 x 17 mm Ratcheting Flex Flare Nut Wrench
89106	16 x 18 mm Ratcheting Flex Flare Nut Wrench
89107	19 x 21 mm Ratcheting Flex Flare Nut Wrench

- Quickly ratchet flare nuts and bolts without removing the wrench from the fastener
- Flex head provides access to difficult-to-reach hose fittings and gets around other obstructions
- Flare nut wrench head easily slips over lines
- Flex flare nut wrench design exceeds ANSI requirements for strength and durability



89100 - 5 Pc. Ratcheting Flex Flare Nut Wrench Set SAE

Material No.	Description
89109	1/4" x 5/16" Ratcheting Flex Flare Nut Wrench
89110	3/8" x 7/16" Ratcheting Flex Flare Nut Wrench
89111	1/2" x 9/16" Ratcheting Flex Flare Nut Wrench
89112	5/8" x 11/16" Ratcheting Flex Flare Nut Wrench
89113	3/4" x 7/8" Ratcheting Flex Flare Nut Wrench

- Quickly ratchet flare nuts and bolts without removing the wrench from the fastener
- Flex head provides access to difficult-to-reach hose fittings and gets around other obstructions
- Flare nut wrench head easily slips over lines
- Flex flare nut wrench design exceeds ANSI requirements for strength and durability

SETS
WRENCHES

CROWFOOT RATCHETING WRENCH SETS

89119 - 10 Pc. Ratcheting Crowfoot Wrench Set METRIC 3/8" DRIVE

Material No.	Description
89140	10 mm Drive Ratcheting Crowfoot Wrench
89141	11 mm Drive Ratcheting Crowfoot Wrench
89142	12 mm Drive Ratcheting Crowfoot Wrench
89143	13 mm Drive Ratcheting Crowfoot Wrench
89144	14 mm Drive Ratcheting Crowfoot Wrench
89145	15 mm Drive Ratcheting Crowfoot Wrench
89146	16 mm Drive Ratcheting Crowfoot Wrench
89147	17 mm Drive Ratcheting Crowfoot Wrench
89148	18 mm Drive Ratcheting Crowfoot Wrench
89149	19 mm Drive Ratcheting Crowfoot Wrench



- Quickly ratchet nuts and bolts without removing the wrench from the fastener
- Exceeds ASME requirements for torque performance
- Size laser etched on both sides of head for easy identification
- Bright chrome finish

89118 - 11 Pc. Ratcheting Crowfoot Wrench Set SAE 3/8" DRIVE

Material No.	Description
89120	3/8" Drive Ratcheting Crowfoot Wrench
89121	7/16" Drive Ratcheting Crowfoot Wrench
89122	1/2" Drive Ratcheting Crowfoot Wrench
89123	9/16" Drive Ratcheting Crowfoot Wrench
89124	5/8" Drive Ratcheting Crowfoot Wrench
89125	11/16" Drive Ratcheting Crowfoot Wrench
89126	3/4" Drive Ratcheting Crowfoot Wrench
89127	13/16" Drive Ratcheting Crowfoot Wrench
89128	7/8" Drive Ratcheting Crowfoot Wrench
89129	15/16" Drive Ratcheting Crowfoot Wrench
89130	1" Drive Ratcheting Crowfoot Wrench



- Quickly ratchet nuts and bolts without removing the wrench from the fastener
- Exceeds ASME requirements for torque performance
- Size laser etched on both sides of head for easy identification
- Bright chrome finish

SETS
WRENCHES

PATENTED

**DOUBLE BOX RATCHETING WRENCH
- OPEN STOCK & SETS**



Open Stock - Double Box Ratcheting Wrench METRIC/SAE

Material No.	Opening Metric/Inches	Overall Length (mm) A	Width Open End (mm) B	Thickness Open End (mm) C	Width Box End (mm) D	Thickness Box End (mm) E	Weight (g)
9210D	8 x 9 mm	130	16.9	6.9	17.9	6.9	50
9211D	10 x 11 mm	150	19.8	7.7	21.7	8.2	64
9212D	12 x 13 mm	170	23.0	8.6	24.5	8.6	100
9215D	17 x 19 mm	230	32.3	10.7	34.0	11.2	209
9201D	5/16" x 3/8"	130	16.6	6.9	17.9	6.9	59
9202D	7/16" x 1/2"	160	21.7	8.2	24.5	8.6	73

SETS
WRENCHES



9260 - 6 Pc. Double Box Ratcheting Wrench Set METRIC

Material No.	Description
9210	8 X 9 mm Double Box Ratcheting Wrench
9211	10 X 11 mm Double Box Ratcheting Wrench
9212	12 X 13 mm Double Box Ratcheting Wrench
9213	14 X 15 mm Double Box Ratcheting Wrench
9214	16 X 18 mm Double Box Ratcheting Wrench
9215	17 X 19 mm Double Box Ratcheting Wrench



9240D - 4 Pc. Double Box Ratcheting Wrench Set SAE

Material No.	Description
9201	5/16" x 3/8" Double Box Ratcheting Wrench
9202	7/16" x 1/2" Double Box Ratcheting Wrench
9203	9/16" x 5/8" Double Box Ratcheting Wrench
9204	11/16" x 3/4" Double Box Ratcheting Wrench

PATENTED

E-TORX® RATCHETING WRENCH SET

9224D - 4 Pc. E-Torx® Double Box Ratcheting Wrench Set TORX®

Material No.	Description	
9220	E6 x E8	E-Torx Ratcheting Wrench
9221	E10 x E12	E-Torx Ratcheting Wrench
9222	E14 x E18	E-Torx Ratcheting Wrench
9223	E20 x E24	E-Torx Ratcheting Wrench

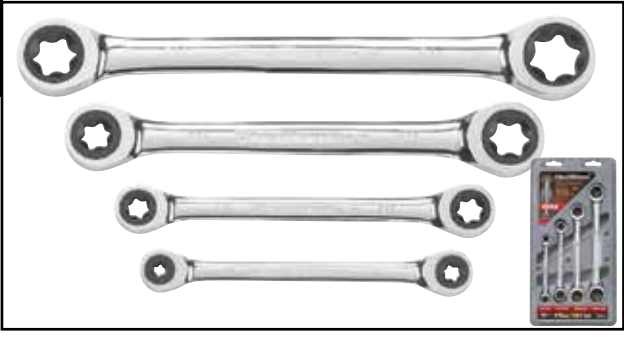

QUADBOX™ RATCHETING WRENCH - OPEN STOCK

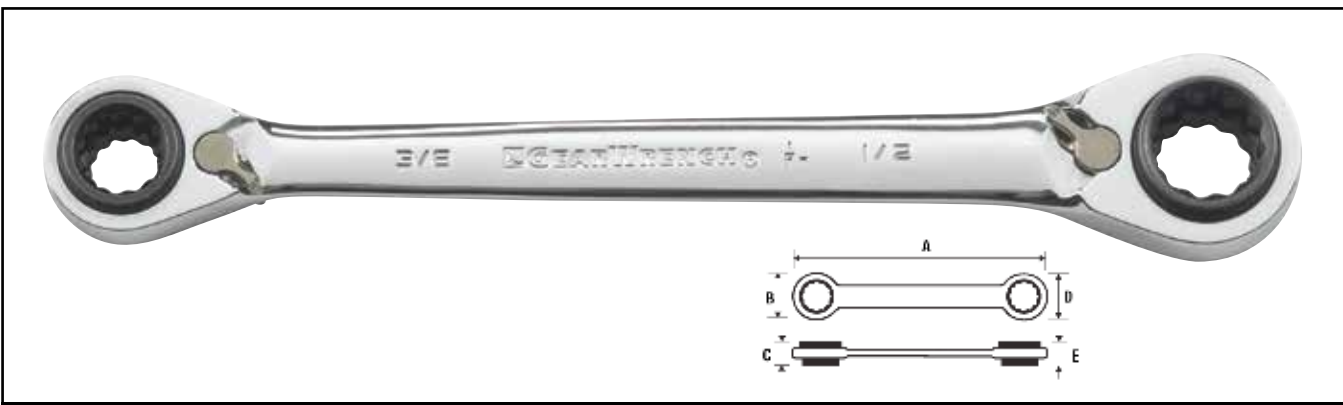

Open Stock - QuadBox™ Ratcheting Wrench METRIC/SAE

Material No.	Opening Metric/Inches	Overall Length (mm) A	Width Box End (mm) B	Thickness Box End (mm) C	Width Box End (mm) D	Thickness Box End (mm) E	Weight (g)
85211	8, 10, 12, 13 mm	160	19.8	11.9	24.9	15.0	85
85212	16, 17, 18, 19 mm	230	32.3	18.03	34.0	20.0	223
85213	9, 11, 14, 15 mm	180	21.7	12.9	28.7	16.0	114
85214	20, 21, 22, 24 mm	290	39.1	23.1	45.5	28.0	479
85201	5/16", 3/8", 7/16", 1/2"	160	19.8	11.9	24.9	15.0	84
85202D	9/16", 5/8", 11/16", 3/4"	210	30.5	17.0	34.0	19.1	204
85203	13/16", 7/8", 15/16", 1"	290	39.1	23.1	45.5	28.0	499

SETS
WRENCHES

PATENTED

QUADBOX™ RATCHETING WRENCH SETS



85215 - 4 Pc. QuadBox™ Double Box Ratcheting Wrench Set METRIC

Material No.	Description
85211	8, 10, 12, 13 mm QuadBox™ Ratcheting Wrench
85212	16, 17, 18, 19 mm QuadBox™ Ratcheting Wrench
85213	9, 11, 14, 15 mm QuadBox™ Ratcheting Wrench
85214	20, 21, 22, 24 mm QuadBox™ Ratcheting Wrench

Metal hinged case with EVA insert



85204 - 3 Pc. QuadBox™ Double Box Ratcheting Wrench Set SAE

Material No.	Description
85201	5/16", 3/8", 7/16", 1/2" QuadBox™ Ratcheting Wrench
85202	9/16", 5/8", 11/16", 3/4" QuadBox™ Ratcheting Wrench
85203	13/16", 7/8", 15/16", 1" QuadBox™ Ratcheting Wrench

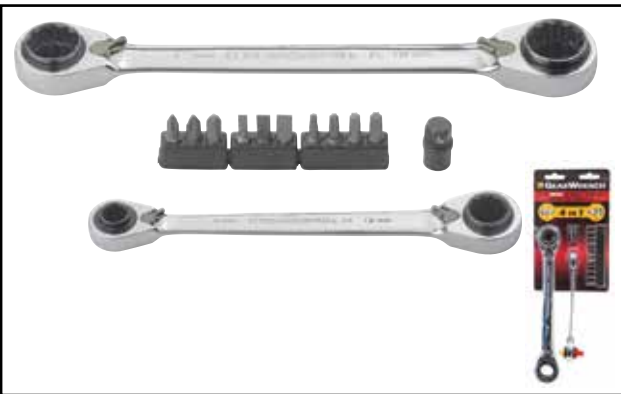

85210D - 13 Pc. QuadBox™ Double Box Ratcheting Wrench Set METRIC

Material No.	Description
85211	8, 10, 12, 13 mm QuadBox™ Ratcheting Wrench
85212	16, 17, 18, 19 mm QuadBox™ Ratcheting Wrench
	1/4" Access Bit Adapter Access Bit Adapter
	#1 Phillips Bit 1/4"
	#2 Phillips Bit 1/4"
	#3 Phillips Bit 1/4"
	5/32 Slotted Bit 1/4"
	7/32 Slotted Bit 1/4"
	1/4 Slotted Bit 1/4"
	T-15 Torx® Bit 1/4"
	T-20 Torx® Bit 1/4"
	T-25 Torx® Bit 1/4"
	T-27 Torx® Bit 1/4"



PATENTED

SETS

WRENCHES

QUADBOX™ REVERSIBLE RATCHETING WRENCH SETS

95552 - 13 Pc. QuadBox™ Reversible Ratcheting Wrench Set METRIC

Material No.	Description	
85211	8, 10, 12, 13 mm	QuadBox™ Reversible Ratcheting Wrench
85212	16, 17, 18, 19 mm	QuadBox™ Reversible Ratcheting Wrench
	1/4" Access Bit Adapter	Access Bit Adapter
	#1	Phillips Bit 1/4"
	#2	Phillips Bit 1/4"
	#3	Phillips Bit 1/4"
	5/32	Slotted Bit 1/4"
	7/32	Slotted Bit 1/4"
	1/4	Slotted Bit 1/4"
	T-15	Torx® Bit 1/4"
	T-20	Torx® Bit 1/4"
	T-25	Torx® Bit 1/4"
	T-27	Torx® Bit 1/4"

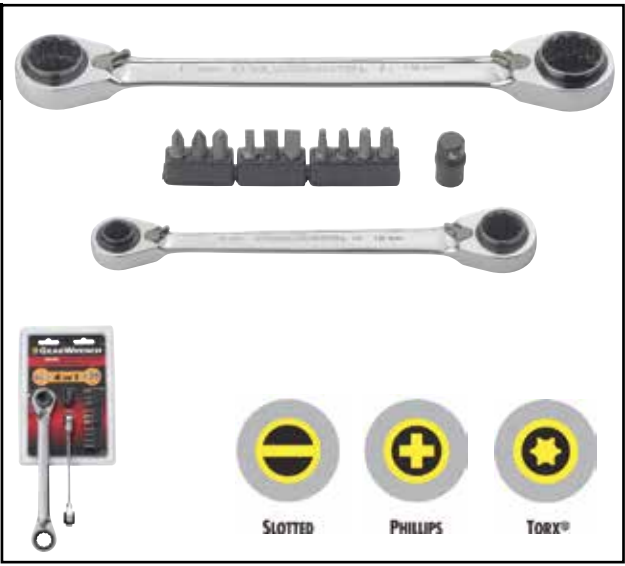

95551 - 13 Pc. QuadBox™ Reversible Ratcheting Wrench Set SAE

Material No.	Description	
85201	5/16", 3/8", 7/16", 1/2"	QuadBox™ Reversible Ratcheting Wrench
85202	9/16", 5/8", 11/16", 3/4"	QuadBox™ Reversible Ratcheting Wrench
	1/4"	Access Bit Adapter
	#1	Phillips Bit 1/4"
	#2	Phillips Bit 1/4"
	#3	Phillips Bit 1/4"
	5/32	Slotted Bit 1/4"
	7/32	Slotted Bit 1/4"
	1/4	Slotted Bit 1/4"
	T-15	Torx® Bit 1/4"
	T-20	Torx® Bit 1/4"
	T-25	Torx® Bit 1/4"
	T-27	Torx® Bit 1/4"

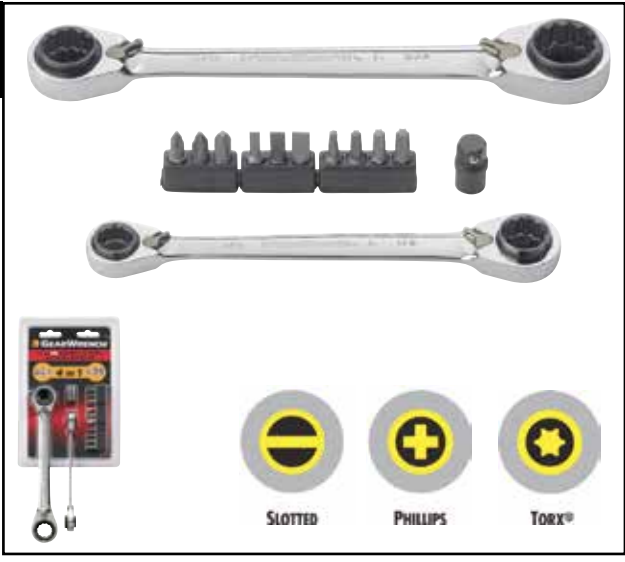

SETS
WRENCHES

PATENTED

XL COMBINATION RATCHETING WRENCH SETS

20% Longer & 25% Stronger



85098 - 12 Pc. XL Combination Ratcheting Wrench Set METRIC

Material No.	Description	
85008	8 mm	XL Combination Ratcheting Wrench
85009	9 mm	XL Combination Ratcheting Wrench
85010	10 mm	XL Combination Ratcheting Wrench
85011	11 mm	XL Combination Ratcheting Wrench
85012	12 mm	XL Combination Ratcheting Wrench
85013	13 mm	XL Combination Ratcheting Wrench
85014	14 mm	XL Combination Ratcheting Wrench
85015	15 mm	XL Combination Ratcheting Wrench
85016	16 mm	XL Combination Ratcheting Wrench
85017	17 mm	XL Combination Ratcheting Wrench
85018	18 mm	XL Combination Ratcheting Wrench
85019	19 mm	XL Combination Ratcheting Wrench



85198 - 8 Pc. XL Combination Ratcheting Wrench Set SAE

Material No.	Description	
85110	5/16"	XL Combination Ratcheting Wrench
85112	3/8"	XL Combination Ratcheting Wrench
85114	7/16"	XL Combination Ratcheting Wrench
85116	1/2"	XL Combination Ratcheting Wrench
85118	9/16"	XL Combination Ratcheting Wrench
85120	5/8"	XL Combination Ratcheting Wrench
85122	11/16"	XL Combination Ratcheting Wrench
85124	3/4"	XL Combination Ratcheting Wrench

SETS
WRENCHES

PATENTED

XL COMBINATION RATCHETING WRENCH SETS

20% Longer & 25% Stronger

85099R - 16 Pc. XL Combination Ratcheting Wrench Set METRIC - Wrench Roll

Material No.	Description	
85008	8 mm	XL Combination Ratcheting Wrench
85009	9 mm	XL Combination Ratcheting Wrench
85010	10 mm	XL Combination Ratcheting Wrench
85011	11 mm	XL Combination Ratcheting Wrench
85012	12 mm	XL Combination Ratcheting Wrench
85013	13 mm	XL Combination Ratcheting Wrench
85014	14 mm	XL Combination Ratcheting Wrench
85015	15 mm	XL Combination Ratcheting Wrench
85016	16 mm	XL Combination Ratcheting Wrench
85017	17 mm	XL Combination Ratcheting Wrench
85018	18 mm	XL Combination Ratcheting Wrench
85019	19 mm	XL Combination Ratcheting Wrench
85020	20 mm	XL Combination Ratcheting Wrench
85021	21 mm	XL Combination Ratcheting Wrench
85022	22 mm	XL Combination Ratcheting Wrench
85024	24 mm	XL Combination Ratcheting Wrench



85199R - 13 Pc. XL Combination Ratcheting Wrench Set SAE - Wrench Roll

Material No.	Description	
85108	1/4"	XL Combination Ratcheting Wrench
85110	5/16"	XL Combination Ratcheting Wrench
85112	3/8"	XL Combination Ratcheting Wrench
85114	7/16"	XL Combination Ratcheting Wrench
85116	1/2"	XL Combination Ratcheting Wrench
85118	9/16"	XL Combination Ratcheting Wrench
85120	5/8"	XL Combination Ratcheting Wrench
85122	11/16"	XL Combination Ratcheting Wrench
85124	3/4"	XL Combination Ratcheting Wrench
85126	13/16"	XL Combination Ratcheting Wrench
85128	7/8"	XL Combination Ratcheting Wrench
85130	15/16"	XL Combination Ratcheting Wrench
85132	1"	XL Combination Ratcheting Wrench



SETS
WRENCHES

PATENTED

XL LOCKING FLEX COMBINATION RATCHETING WRENCH - OPEN STOCK & SETS



Open Stock - XL Locking Flex Combination Ratcheting Wrench METRIC

Item No.	Opening Metric	Overall Length (mm) A	Width Open End (mm) B	Thickness Open End (mm) C	Width Box End (mm) D	Thickness Box End (mm) E	Weight (g)
85608	8 mm	146	19.6	5.08	17.02	6.86	40
85609	9 mm	159	19.6	5.33	17.78	6.86	50
85610	10 mm	171	21.85	5.58	19.81	7.62	68
85611	11 mm	183	24.13	6.35	21.59	8.13	82
85612	12 mm	195	26.67	7.37	23.11	8.64	100
85613	13 mm	207	29.21	8.13	24.89	8.64	118
85614	14 mm	219	31.24	8.38	26.42	9.40	145
85615	15 mm	231	33.78	8.38	28.70	9.91	163
85616	16 mm	242	34.54	8.89	30.48	10.41	200
85617	17 mm	254	37.85	9.14	32.26	10.67	227

SETS
WRENCHES



85698 - 12 Pc. XL Locking Flex Combination Ratcheting Wrench Set METRIC

Material No.	Description
85608	8 mm XL Locking Flex Combination Ratcheting Wrench
85609	9 mm XL Locking Flex Combination Ratcheting Wrench
85610	10 mm XL Locking Flex Combination Ratcheting Wrench
85611	11 mm XL Locking Flex Combination Ratcheting Wrench
85612	12 mm XL Locking Flex Combination Ratcheting Wrench
85613	13 mm XL Locking Flex Combination Ratcheting Wrench
85614	14 mm XL Locking Flex Combination Ratcheting Wrench
85615	15 mm XL Locking Flex Combination Ratcheting Wrench
85616	16 mm XL Locking Flex Combination Ratcheting Wrench
85617	17 mm XL Locking Flex Combination Ratcheting Wrench
85618	18 mm XL Locking Flex Combination Ratcheting Wrench
85619	19 mm XL Locking Flex Combination Ratcheting Wrench

XL LOCKING FLEX COMBINATION RATCHETING WRENCH SETS

85798 - 8 Pc. XL Locking Flex Combination Ratcheting Wrench Set SAE

Material No.	Description
85710	5/16" XL Locking Flex Combination Ratcheting Wrench
85712	3/8" XL Locking Flex Combination Ratcheting Wrench
85714	7/16" XL Locking Flex Combination Ratcheting Wrench
85716	1/2" XL Locking Flex Combination Ratcheting Wrench
85718	9/16" XL Locking Flex Combination Ratcheting Wrench
85720	5/8" XL Locking Flex Combination Ratcheting Wrench
85722	11/16" XL Locking Flex Combination Ratcheting Wrench
85724	3/4" XL Locking Flex Combination Ratcheting Wrench



85698R - 12 Pc. XL Locking Flex Combination Ratcheting Wrench Set Roll METRIC

Material No.	Description
85608	8 mm XL Locking Flex Combination Ratcheting Wrench
85609	9 mm XL Locking Flex Combination Ratcheting Wrench
85610	10 mm XL Locking Flex Combination Ratcheting Wrench
85611	11 mm XL Locking Flex Combination Ratcheting Wrench
85612	12 mm XL Locking Flex Combination Ratcheting Wrench
85613	13 mm XL Locking Flex Combination Ratcheting Wrench
85614	14 mm XL Locking Flex Combination Ratcheting Wrench
85615	15 mm XL Locking Flex Combination Ratcheting Wrench
85616	16 mm XL Locking Flex Combination Ratcheting Wrench
85617	17 mm XL Locking Flex Combination Ratcheting Wrench
85618	18 mm XL Locking Flex Combination Ratcheting Wrench
85619	19 mm XL Locking Flex Combination Ratcheting Wrench



85798R - 8 Pc. XL Locking Flex Combination Ratcheting Wrench Set Roll SAE

Material No.	Description
85710	5/16" XL Locking Flex Combination Ratcheting Wrench
85712	3/8" XL Locking Flex Combination Ratcheting Wrench
85714	7/16" XL Locking Flex Combination Ratcheting Wrench
85716	1/2" XL Locking Flex Combination Ratcheting Wrench
85718	9/16" XL Locking Flex Combination Ratcheting Wrench
85720	5/8" XL Locking Flex Combination Ratcheting Wrench
85722	11/16" XL Locking Flex Combination Ratcheting Wrench
85724	3/4" XL Locking Flex Combination Ratcheting Wrench



83055 - 8 Pc. Wrench Set Locking Flex Ratcheting Combination METRIC

Description
 Locking Flex Ratcheting Combination Wrench: 8mm, 10mm, 11mm, 12mm, 13mm, 14mm, 15mm, 16mm
 Metal Case with EVA Tray Insert: 168mm x 360mm



PATENTED

SETS
WRENCHES

**XL GEARBOX™ RATCHETING WRENCH
- OPEN STOCK**



Open Stock - XL GearBox™ Double Box Ratcheting Wrench METRIC

Item No.	Opening Metric	Overall Length (mm) A	Width Box End (mm) B	Thickness Box End (mm) C	Width Box End (mm) D	Thickness Box End (mm) E	Weight (g)
85908	8 mm	221	17.02	6.86	11.69	6.09	54.8
85910	10 mm	241	19.81	7.62	14.48	6.86	75.8
85911	11 mm	251	21.59	8.13	15.75	7.87	88.9
85912	12 mm	267	23.11	8.64	17.28	8.38	117.9
85913	13 mm	287	24.89	8.64	18.79	8.89	149.7
85914	14 mm	305	26.42	9.40	20.32	9.91	171.5
85915	15 mm	323	28.7	9.91	21.85	10.92	209.6
85916	16 mm	348	30.48	10.41	22.86	10.92	225.4
85917	17 mm	374	32.26	10.67	23.88	10.92	302.6
85918	18 mm	384	33.28	11.17	24.89	11.43	313.4
85919	19 mm	396	34.03	11.17	26.42	11.94	348.9
85922	22 mm	432	39.12	12.96	30.99	14.48	489.9

OPEN STOCK

WRENCHES

PATENTED

XL GEARBOX™ RATCHETING WRENCH SETS

85987 - 5 Pc. XL GearBox™ Double Box Ratcheting Wrench Add-On Set METRIC

Material No.	Description
85920	20 mm XL GearBox™ Ratcheting Wrench
85921	21 mm XL GearBox™ Ratcheting Wrench
85922	22 mm XL GearBox™ Ratcheting Wrench
85924	24 mm XL GearBox™ Ratcheting Wrench
85925	25 mm XL GearBox™ Ratcheting Wrench



ADD-ON SET (Complement to 85988)

85996 - 4 Pc. XL GearBox™ Double Box Ratcheting Wrench Add-On Set SAE

Material No.	Description
85966	13/16" XL GearBox™ Ratcheting Wrench
85968	7/8" XL GearBox™ Ratcheting Wrench
85970	15/16" XL GearBox™ Ratcheting Wrench
85972	1" XL GearBox™ Ratcheting Wrench



ADD-ON SET (Complement to 85998)

85988 - 12 Pc. XL GearBox™ Double Box Ratcheting Wrench Set METRIC

Material No.	Description
85908	8 mm XL GearBox™ Double Box Ratcheting Wrench
85909	9 mm XL GearBox™ Double Box Ratcheting Wrench
85910	10 mm XL GearBox™ Double Box Ratcheting Wrench
85911	11 mm XL GearBox™ Double Box Ratcheting Wrench
85912	12 mm XL GearBox™ Double Box Ratcheting Wrench
85913	13 mm XL GearBox™ Double Box Ratcheting Wrench
85914	14 mm XL GearBox™ Double Box Ratcheting Wrench
85915	15 mm XL GearBox™ Double Box Ratcheting Wrench
85916	16 mm XL GearBox™ Double Box Ratcheting Wrench



85917	17 mm	XL GearBox™ Double Box Ratcheting Wrench
85918	18 mm	XL GearBox™ Double Box Ratcheting Wrench
85919	19 mm	XL GearBox™ Double Box Ratcheting Wrench

PATENTED

XL GEARBOX™ RATCHETING WRENCH SETS



85998 - 9 Pc. XL GearBox™ Double Box Ratcheting Wrench Set SAE

Material No.	Description	
85950	5/16"	XL GearBox™ Double Box Ratcheting Wrench
85951	11/32"	XL GearBox™ Double Box Ratcheting Wrench
85952	3/8"	XL GearBox™ Double Box Ratcheting Wrench
85954	7/16"	XL GearBox™ Double Box Ratcheting Wrench
85956	1/2"	XL GearBox™ Double Box Ratcheting Wrench
85958	9/16"	XL GearBox™ Double Box Ratcheting Wrench
85960	5/8"	XL GearBox™ Double Box Ratcheting Wrench
85962	11/16"	XL GearBox™ Double Box Ratcheting Wrench
85964	3/4"	XL GearBox™ Double Box Ratcheting Wrench

XL SPLINE COMBINATION RATCHETING WRENCH SET



85598 - 9 Pc. XL Spline Combination Ratcheting Wrench Set SAE

Material No.	Description	
85548	#8 x 1/4"	XL Spline Combination Ratcheting Wrench
85550	#10 x 5/16"	XL Spline Combination Ratcheting Wrench
85552	#12 x 3/8"	XL Spline Combination Ratcheting Wrench
85554	#14 x 7/16"	XL Spline Combination Ratcheting Wrench
85556	#16 x 1/2"	XL Spline Combination Ratcheting Wrench
85558	#18 x 9/16"	XL Spline Combination Ratcheting Wrench
85560	#20 x 5/8"	XL Spline Combination Ratcheting Wrench
85562	#22 x 11/16"	XL Spline Combination Ratcheting Wrench
85564	#24 x 3/4"	XL Spline Combination Ratcheting Wrench

SETS

WRENCHES

PATENTED

XL X-BEAM™ COMBINATION RATCHETING WRENCH SETS

85888 - 12 Pc. XL X-Beam™ Combination Ratcheting Wrench Set METRIC

Material No.	Description
85808	8 mm XL X-Beam™ Combination Ratcheting Wrench
85809	9 mm XL X-Beam™ Combination Ratcheting Wrench
85810	10 mm XL X-Beam™ Combination Ratcheting Wrench
85811	11 mm XL X-Beam™ Combination Ratcheting Wrench
85812	12 mm XL X-Beam™ Combination Ratcheting Wrench
85813	13 mm XL X-Beam™ Combination Ratcheting Wrench
85814	14 mm XL X-Beam™ Combination Ratcheting Wrench
85815	15 mm XL X-Beam™ Combination Ratcheting Wrench
85816	16 mm XL X-Beam™ Combination Ratcheting Wrench
85817	17 mm XL X-Beam™ Combination Ratcheting Wrench
85818	18 mm XL X-Beam™ Combination Ratcheting Wrench
85819	19 mm XL X-Beam™ Combination Ratcheting Wrench



85898 - 9 Pc. XL X-Beam™ Combination Ratcheting Wrench Set SAE

Material No.	Description
85850	5/16" XL X-Beam™ Combination Ratcheting Wrench
85851	11/32" XL X-Beam™ Combination Ratcheting Wrench
85852	3/8" XL X-Beam™ Combination Ratcheting Wrench
85854	7/16" XL X-Beam™ Combination Ratcheting Wrench
85856	1/2" XL X-Beam™ Combination Ratcheting Wrench
85858	9/16" XL X-Beam™ Combination Ratcheting Wrench
85860	5/8" XL X-Beam™ Combination Ratcheting Wrench
85862	11/16" XL X-Beam™ Combination Ratcheting Wrench
85864	3/4" XL X-Beam™ Combination Ratcheting Wrench



SETS
WRENCHES

PATENTED

XL X-BEAM™ REVERSIBLE COMBINATION RATCHETING WRENCH SETS



85388 - 12 Pc. XL X-Beam™ Reversible Combination Ratcheting Wrench Set METRIC

Material No.	Description
85308	8 mm XL X-Beam™ Reversible Combo Ratcheting Wrench
85309	9 mm XL X-Beam™ Reversible Combo Ratcheting Wrench
85310	10 mm XL X-Beam™ Reversible Combo Ratcheting Wrench
85311	11 mm XL X-Beam™ Reversible Combo Ratcheting Wrench
85312	12 mm XL X-Beam™ Reversible Combo Ratcheting Wrench
85313	13 mm XL X-Beam™ Reversible Combo Ratcheting Wrench
85314	14 mm XL X-Beam™ Reversible Combo Ratcheting Wrench
85315	15 mm XL X-Beam™ Reversible Combo Ratcheting Wrench
85316	16 mm XL X-Beam™ Reversible Combo Ratcheting Wrench
85317	17 mm XL X-Beam™ Reversible Combo Ratcheting Wrench
85318	18 mm XL X-Beam™ Reversible Combo Ratcheting Wrench
85319	19 mm XL X-Beam™ Reversible Combo Ratcheting Wrench



85398 - 9 Pc. XL X-Beam™ Reversible Combination Ratcheting Wrench Set SAE

Material No.	Description
85360	5/16" XL X-Beam™ Reversible Combo Ratcheting
85361	11/32" XL X-Beam™ Reversible Combo Ratcheting
85362	3/8" XL X-Beam™ Reversible Combo Ratcheting
85364	7/16" XL X-Beam™ Reversible Combo Ratcheting
85366	1/2" XL X-Beam™ Reversible Combo Ratcheting
85368	9/16" XL X-Beam™ Reversible Combo Ratcheting
85370	5/8" XL X-Beam™ Reversible Combo Ratcheting
85372	11/16" XL X-Beam™ Reversible Combo Ratcheting
85374	3/4" XL X-Beam™ Reversible Combo Ratcheting

SETS

WRENCHES

XL X-BEAM™ FLEX COMBINATION RATCHETING WRENCH SETS

85288 - 12 Pc. XL X-Beam™ Flex Combination Ratcheting Wrench Set METRIC

Material No.	Description
85258	8 mm XL X-Beam™ Flex Combination Ratcheting Wrench
85259	9 mm XL X-Beam™ Flex Combination Ratcheting Wrench
85260	10 mm XL X-Beam™ Flex Combination Ratcheting Wrench
85261	11 mm XL X-Beam™ Flex Combination Ratcheting Wrench
85262	12 mm XL X-Beam™ Flex Combination Ratcheting Wrench
85263	13 mm XL X-Beam™ Flex Combination Ratcheting Wrench
85264	14 mm XL X-Beam™ Flex Combination Ratcheting Wrench
85265	15 mm XL X-Beam™ Flex Combination Ratcheting Wrench
85266	16 mm XL X-Beam™ Flex Combination Ratcheting Wrench
85267	17 mm XL X-Beam™ Flex Combination Ratcheting Wrench
85268	18 mm XL X-Beam™ Flex Combination Ratcheting Wrench
85269	19 mm XL X-Beam™ Flex Combination Ratcheting Wrench

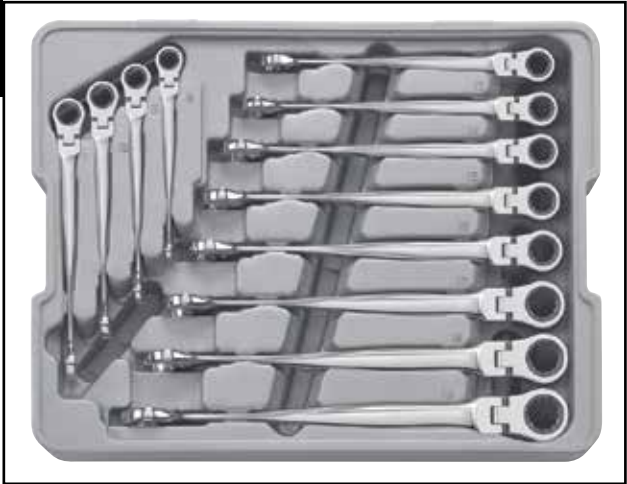

85298 - 9 Pc. XL X-Beam™ Flex Combination Ratcheting Wrench Set SAE

Material No.	Description
85270	5/16" XL X-Beam™ Flex Combination Ratcheting Wrench
85271	11/32" XL X-Beam™ Flex Combination Ratcheting Wrench
85272	3/8" XL X-Beam™ Flex Combination Ratcheting Wrench
85274	7/16" XL X-Beam™ Flex Combination Ratcheting Wrench
85276	1/2" XL X-Beam™ Flex Combination Ratcheting Wrench
85278	9/16" XL X-Beam™ Flex Combination Ratcheting Wrench
85280	5/8" XL X-Beam™ Flex Combination Ratcheting Wrench
85282	11/16" XL X-Beam™ Flex Combination Ratcheting Wrench
85284	3/4" XL X-Beam™ Flex Combination Ratcheting Wrench



SETS
WRENCHES

PATENTED

**NON-RATCHETING
WRENCHES**



Offset Box End

Long Pattern Length

Non-Ratcheting Box End

AVAILABLE IN:

- 6 Point
- 12 Point

Surface Drive Plus™

- Provides stronger grip on fasteners
- Reduces fastener rounding
- Delivers up to 25% more torque

Unique beam design reduces hand fatigue

Up to 25% longer to access hard-to-reach fasteners

Size stamped on both sides and head

Chrome Vanadium

Offset Box End

Stubby Pattern Length

Products are covered by one or more of the following patents:
 • US 6,263,769 US 6,267,028 US 6,082,228 D412819 D437536

WRENCHES

LONG PATTERN COMBINATION NON-RATCHETING WRENCHES - OPEN STOCK



Open Stock - Long Pattern Combination Non-Ratcheting Wrenches METRIC/SAE

Material No.	Opening Metric/Inches	Overall Length (mm) A	Width Open End (mm) B	Thickness Open End (mm) C	Width Box End (mm) D	Thickness Box End (mm) E	Weight (g)
81736	6 mm	129	13.2	4.1	11.4	5.0	30
81737	7 mm	138	14.4	4.3	12.3	5.3	35
81665	8 mm	147	16.6	4.5	13.6	5.5	29
81666	9 mm	158	18.5	4.7	14.8	6.2	41
81667	10 mm	166	20.5	5.4	16.1	6.9	56
81668	11 mm	185	22.7	6.0	17.4	7.5	64
81669	12 mm	197	24.6	6.2	18.5	8.3	80
81670	13 mm	206	26.7	6.4	19.8	8.5	84
81671	14 mm	222	28.9	7.0	21.5	9.3	107
81672	15 mm	232	30.8	7.4	22.6	9.9	130
81673	16 mm	242	32.8	7.7	23.9	10.5	154
81674	17 mm	260	35.1	8.1	25.8	11.0	188
81675	18 mm	269	37.1	8.6	26.6	11.5	194
81676	19 mm	279	39.3	9.1	27.4	12.0	250
81677	20 mm	290	41.9	9.7	28.2	12.5	281
81678	21 mm	301	43.2	10.1	28.9	12.9	310
81679	22 mm	318	45.3	10.3	32.1	13.7	321
81741	23 mm	324	47.5	10.6	32.7	14.2	409
81742	24 mm	337	49.4	10.9	33.7	14.7	469
81751	25 mm	357	51.4	11.3	35.5	15.2	942
81752	26 mm	364	54.3	11.4	37.4	15.8	1311
81743	27 mm	375	56.0	11.9	38.9	16.5	1152
81753	28 mm	406	62.7	12.7	42.8	17.7	1329
81744	30 mm	432	64.9	13.3	42.8	18.3	1381
81745D	32 mm	441	66.9	13.3	46.0	18.3	1382
81650	1/4"	129	13.2	4.1	11.4	5.0	21
81651D	9/32"	138	14.4	4.3	12.3	5.3	28
81652D	5/16"	147	16.6	4.5	13.6	5.5	32
81653	11/32"	158	18.5	4.7	14.8	6.2	42
81654	3/8"	166	20.5	5.4	16.1	6.9	55
81655	7/16"	185	22.7	6.0	17.4	7.5	65

OPEN STOCK
WRENCHES

LONG PATTERN COMBINATION NON-RATCHETING WRENCHES - OPEN STOCK & SETS



Open Stock - Long Pattern Combination Non-Ratcheting Wrenches SAE Continued

Item No.	Opening Inches	Overall Length (mm) A	Width Open End (mm) B	Thickness Open End (mm) C	Width Box End (mm) D	Thickness Box End (mm) E	Weight (g)
81656	1/2"	206	26.7	6.4	19.8	8.5	89
81657	9/16"	222	28.9	7.0	21.5	9.3	124
81658	5/8"	242	30.8	7.7	23.9	10.5	149
81659	11/16"	260	35	8.0	25.8	11.0	185
81660	3/4"	279	39	9.2	27.9	12.1	240
81661	13/16"	300	43	9.9	30.5	13.2	288
81662	7/8"	318	45	10.3	32.1	13.7	320
81663	15/16"	337	49	10.9	33.71	14.7	408
81664	1"	356	52	11.3	35.5	15.2	443
81733	1-1/16"	375	57	11.9	38.9	16.5	679
81734	1-1/8"	406	63	12.7	42.8	17.7	838
81735	1-1/4"	406	66	13.3	46.0	18.4	968
81749	1-5/16"	400	79	15.5	55.5	23.5	933
81750	1-1/2"	501	79	15.5	55.5	23.5	935

SETS
WRENCHES



81902 - 15 Pc. Long Pattern Combination Non-Ratcheting Wrench Set METRIC

Material No.	Description
81665	8 mm Long Pattern Combination Wrench
81666	9 mm Long Pattern Combination Wrench
81667	10 mm Long Pattern Combination Wrench
81668	11 mm Long Pattern Combination Wrench
81669	12 mm Long Pattern Combination Wrench
81670	13 mm Long Pattern Combination Wrench
81671	14 mm Long Pattern Combination Wrench
81672	15 mm Long Pattern Combination Wrench
81673	16 mm Long Pattern Combination Wrench
81674	17 mm Long Pattern Combination Wrench
81675	18 mm Long Pattern Combination Wrench
81676	19 mm Long Pattern Combination Wrench
81677	20 mm Long Pattern Combination Wrench
81678	21 mm Long Pattern Combination Wrench
81679	22 mm Long Pattern Combination Wrench

LONG PATTERN COMBINATION NON-RATCHETING WRENCH SETS

81901 - 15 Pc. Long Pattern Combination Non-Ratcheting Wrench Set SAE

Material No.	Description	
81652	5/16"	Long Pattern Combination Wrench
81653	11/32"	Long Pattern Combination Wrench
81654	3/8"	Long Pattern Combination Wrench
81655	7/16"	Long Pattern Combination Wrench
81656	1/2"	Long Pattern Combination Wrench
81657	9/16"	Long Pattern Combination Wrench
81658	5/8"	Long Pattern Combination Wrench
81659	11/16"	Long Pattern Combination Wrench
81660	3/4"	Long Pattern Combination Wrench
81661	13/16"	Long Pattern Combination Wrench
81662	7/8"	Long Pattern Combination Wrench
81663	15/16"	Long Pattern Combination Wrench
81664	1"	Long Pattern Combination Wrench
81650	1/4"	Long Pattern Combination Wrench
81651	9/32"	Long Pattern Combination Wrench



81920 - 18 Pc. Long Pattern Combination Non-Ratcheting Wrench Set METRIC

Material No.	Description	
81737	7 mm	Long Pattern Combination Wrench
81665	8 mm	Long Pattern Combination Wrench
81666	9 mm	Long Pattern Combination Wrench
81667	10 mm	Long Pattern Combination Wrench
81668	11 mm	Long Pattern Combination Wrench
81669	12 mm	Long Pattern Combination Wrench
81670	13 mm	Long Pattern Combination Wrench
81671	14 mm	Long Pattern Combination Wrench
81672	15 mm	Long Pattern Combination Wrench
81673	16 mm	Long Pattern Combination Wrench
81674	17 mm	Long Pattern Combination Wrench
81675	18 mm	Long Pattern Combination Wrench
81676	19 mm	Long Pattern Combination Wrench
81677	20 mm	Long Pattern Combination Wrench
81678	21 mm	Long Pattern Combination Wrench
81679	22 mm	Long Pattern Combination Wrench
81741	23 mm	Long Pattern Combination Wrench
81742	24 mm	Long Pattern Combination Wrench



SETS
WRENCHES

LONG PATTERN COMBINATION NON-RATCHETING WRENCH SETS



81917 - 18 Pc. Long Pattern Combination Non-Ratcheting Wrench Set SAE

Material No.	Description
81650	1/4" Long Pattern Combination Wrench
81651	9/32" Long Pattern Combination Wrench
81652	5/16" Long Pattern Combination Wrench
81653	11/32" Long Pattern Combination Wrench
81654	3/8" Long Pattern Combination Wrench
81655	7/16" Long Pattern Combination Wrench
81656	1/2" Long Pattern Combination Wrench
81657	9/16" Long Pattern Combination Wrench
81658	5/8" Long Pattern Combination Wrench
81659	11/16" Long Pattern Combination Wrench
81660	3/4" Long Pattern Combination Wrench
81661	13/16" Long Pattern Combination Wrench
81662	7/8" Long Pattern Combination Wrench
81663	15/16" Long Pattern Combination Wrench
81664	1" Long Pattern Combination Wrench
81733	1-1/6" Long Pattern Combination Wrench
81734	1-1/8" Long Pattern Combination Wrench
81735	1-1/4" Long Pattern Combination Wrench

SETS
WRENCHES

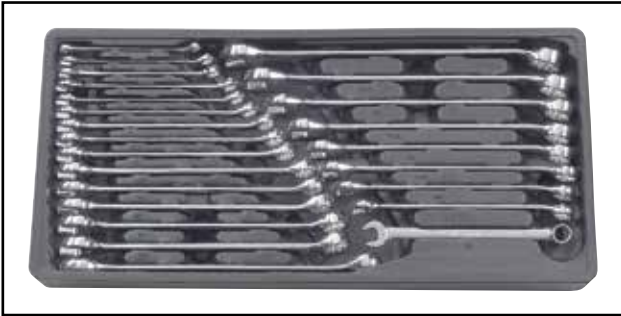

81900 - 24 Pc. Long Pattern Combination Non-Ratcheting Wrench Set SAE/METRIC

Material No.	Description
81656	1/2" Long Pattern Combination Wrench
81657	9/16" Long Pattern Combination Wrench
81658	5/8" Long Pattern Combination Wrench
81659	11/16" Long Pattern Combination Wrench
81660	3/4" Long Pattern Combination Wrench
81661	13/16" Long Pattern Combination Wrench
81662	7/8" Long Pattern Combination Wrench
81663	15/16" Long Pattern Combination Wrench
81664	1" Long Pattern Combination Wrench

Material No.	Description
81665	8 mm Long Pattern Combination Wrench
81666	9 mm Long Pattern Combination Wrench
81667	10 mm Long Pattern Combination Wrench
81668	11 mm Long Pattern Combination Wrench
81669	12 mm Long Pattern Combination Wrench
81670	13 mm Long Pattern Combination Wrench
81671	14 mm Long Pattern Combination Wrench
81672	15 mm Long Pattern Combination Wrench
81673	16 mm Long Pattern Combination Wrench
81674	17 mm Long Pattern Combination Wrench
81675	18 mm Long Pattern Combination Wrench
81676	19 mm Long Pattern Combination Wrench
81677	20 mm Long Pattern Combination Wrench
81678	21 mm Long Pattern Combination Wrench
81679	22 mm Long Pattern Combination Wrench

FULL POLISH COMBINATION NON-RATCHETING WRENCH SETS

81925 - 14 Pc. Full Polish Combination Non-Ratcheting Wrench Set METRIC

Material No.	Description
81754	6 mm Full Polish Combination Wrench
81755	7 mm Full Polish Combination Wrench
81756	8 mm Full Polish Combination Wrench
81757	9 mm Full Polish Combination Wrench
81758	10 mm Full Polish Combination Wrench
81759	11 mm Full Polish Combination Wrench
81760	12 mm Full Polish Combination Wrench
81761	13 mm Full Polish Combination Wrench
81762	14 mm Full Polish Combination Wrench
81763	15 mm Full Polish Combination Wrench
81764	16 mm Full Polish Combination Wrench
81765	17 mm Full Polish Combination Wrench
81766	18 mm Full Polish Combination Wrench
81767	19 mm Full Polish Combination Wrench



81924 - 14 Pc. Full Polish Combination Non-Ratcheting Wrench Set SAE

Material No.	Description
81768	1/4" Full Polish Combination Wrench
81769	15/16" Full Polish Combination Wrench
81770	11/32" Full Polish Combination Wrench
81771	3/8" Full Polish Combination Wrench
81772	7/16" Full Polish Combination Wrench
81773	1/2" Full Polish Combination Wrench
81774	9/16" Full Polish Combination Wrench
81775	5/8" Full Polish Combination Wrench
81776	11/16" Full Polish Combination Wrench
81777	3/4" Full Polish Combination Wrench
81778	13/16" Full Polish Combination Wrench
81779	7/8" Full Polish Combination Wrench
81780	15/16" Full Polish Combination Wrench
81781	1" Full Polish Combination Wrench

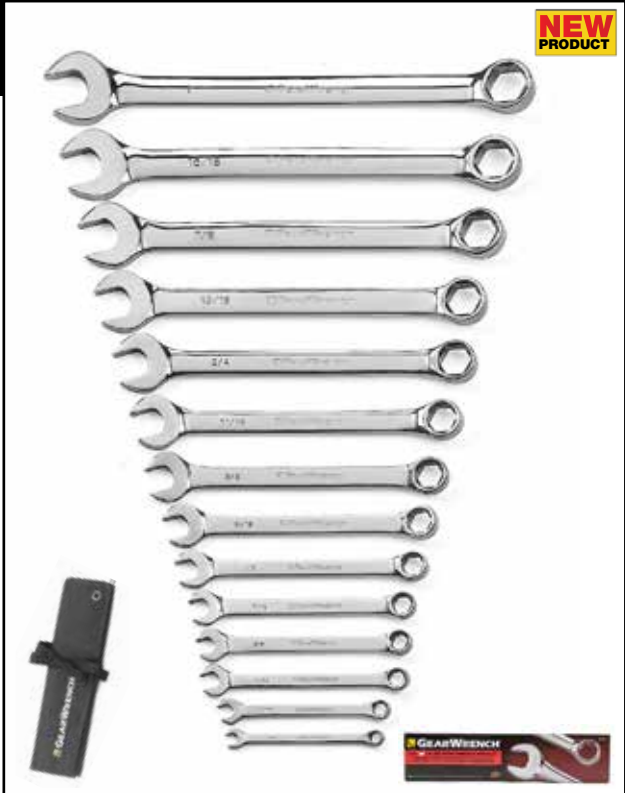

SETS
WRENCHES

30 DEGREE DEEP OFFSET NON-RATCHETING WRENCH - OPEN STOCK & SETS



Open Stock - 30 Degree Deep Offset Box Non-Ratcheting Wrenches METRIC/SAE

Material No.	Opening Metric/Inches	Overall Length (mm) A	Width Open End (mm) B	Width Open End (mm) D	Weight (g)
81782	8 x 10 mm	185	14.2	16.3	84
81783	10 x 12 mm	195	16.3	18.4	204
81784	11 x 13 mm	205	18.4	20.8	499
81785	12 x 14 mm	220	19.7	21.8	857
81786	17 x 19 mm	250	26.6	27.8	
81787	3/8" x 1"	195	16.3	18.4	84
81788	1/2" x 9/16"	220	19.7	21.8	204
81789	11/16" x 3/4"	250	26.6	27.8	499
81790	13/16" x 7/8"	290	30.7	33.2	857
81791	15/16" x 1"	360	34.1	37.3	



81927 - 5 Pc. 30 Degree Deep Offset Box Non-Ratcheting Wrench Set METRIC

Material No.	Description
81782	8 x 10 mm 30 Degree Deep Offset Box Wrench
81783	10 x 12 mm 30 Degree Deep Offset Box Wrench
81784	11 X 13 mm 30 Degree Deep Offset Box Wrench
81785	12 x 14 mm 30 Degree Deep Offset Box Wrench
81786	17 x 19 mm 30 Degree Deep Offset Box Wrench



81926 - 5 Pc. 30 Degree Deep Offset Box Non-Ratcheting Wrench Set SAE

Material No.	Description
81787	3/8 X 1" 30 Degree Deep Offset Box Wrench
81788	1/2" x 9/16" 30 Degree Deep Offset Box Wrench
81789	11/16 X 3/4" 30 Degree Deep Offset Box Wrench
81790	13/16 X 7/8" 30 Degree Deep Offset Box Wrench
81791	15/16 X 1" 30 Degree Deep Offset Box Wrench

SETS
WRENCHES

FULL POLISH OPEN END NON-RATCHETING WRENCH - OPEN STOCK & SETS



Open Stock - Full Polish Open End Non-Ratcheting Wrenches METRIC/SAE

Material No.	Opening Metric/Inches	Overall Length (mm) A	Width Open End (mm) B	Thickness Open End (mm) C	Width Open End (mm) D	Thickness Open End (mm) E	Weight (g)
81792	6 x 7 mm	124	12.5	3.3	16.71	3.71	84
81793	8 x 10 mm	149	16.7	5.51	20.87	5.52	204
81794D	10 x 12 mm	162	20.9	5.89	25.09	5.89	499
81795	11 x 13 mm	174	23.0	6.19	17.15	6.20	86
81796	12 x 14 mm	186	25.1	6.60	29.27	6.60	223
81797	17 x 19 mm	227	35.5	6.80	39.71	7.80	238
81798	1/4" x 5/16"	124	12.5	3.30	16.7	3.71	84
81799	3/8" x 7/16"	150	20.9	4.40	22.99	4.80	204
81801	1/2" x 9/16"	176	27.2	5.41	29.27	5.79	458
81802	5/8" x 11/16"	202	33.4	6.40	35.54	6.8	86
81803	13/16" x 3/4"	228	35.5	6.81	39.70	7.8	223
81804	15/16" x 1"	280	50.1	9.29	52.24	9.7	238
81805	1-1/8" x 1-1/4"	310	62.7	11.3	66.86	11.71	279

81928 - 6 Pc. Full Polish Open End Non-Ratcheting Wrench Set METRIC

Material No.	Description
81792	6 x 7 mm Full Polish Open End Wrench
81793	8 x 10 mm Full Polish Open End Wrench
81794	10 x 12 mm Full Polish Open End Wrench
81795	11 x 13 mm Full Polish Open End Wrench
81796	12 x 14 mm Full Polish Open End Wrench
81797	17 x 19 mm Full Polish Open End Wrench



81929 - 7 Pc. Full Polish Open End Non-Ratcheting Wrench Set SAE

Material No.	Description
81798	1/4 X 5/16" Full Polish Open End Wrench
81799	3/8" x 7/16" Full Polish Open End Wrench
81801	1/2 X 9/16" Full Polish Open End Wrench
81802	5/8 X 11/16" Full Polish Open End Wrench
81803	13/16 X 3/4" Full Polish Open End Wrench
81804	15/16" x 1" Full Polish Open End Wrench
81805	1-1/8 X 1-1/4" Full Polish Open End Wrench



SETS WRENCHES

**STUBBY COMBINATION
NON-RATCHETING WRENCH SETS**



**81904 - 10 Pc. Stubby Combination
Non-Ratcheting Wrench Set METRIC**

Material No.	Description	
81634	10 mm	Stubby Combination Wrench
81635	11 mm	Stubby Combination Wrench
81636	12 mm	Stubby Combination Wrench
81637	13 mm	Stubby Combination Wrench
81638	14 mm	Stubby Combination Wrench
81639	15 mm	Stubby Combination Wrench
81640	16 mm	Stubby Combination Wrench
81641	17 mm	Stubby Combination Wrench
81642	18 mm	Stubby Combination Wrench
81643	19 mm	Stubby Combination Wrench



**81905 - 10 Pc. Stubby Combination
Non-Ratcheting Wrench Set SAE**

Material No.	Description	
81624	3/8"	Stubby Combination Wrench
81625	7/16"	Stubby Combination Wrench
81626	1/2"	Stubby Combination Wrench
81627	9/16"	Stubby Combination Wrench
81628	5/8"	Stubby Combination Wrench
81629	11/16"	Stubby Combination Wrench
81630	3/4"	Stubby Combination Wrench
81631	13/16"	Stubby Combination Wrench
81632	7/8"	Stubby Combination Wrench
81633	15/16"	Stubby Combination Wrench

SETS
WRENCHES

FLEX FLARE NUT NON-RATCHETING WRENCH SETS

81911 - 6 Pc. Flex Flare Nut Non-Ratcheting Wrench Set METRIC

Material No.	Description	
81686	9 x 11 mm	Flex Flare Nut Wrench
81687	10 x 12 mm	Flex Flare Nut Wrench
81688	13 x 14 mm	Flex Flare Nut Wrench
81689	15 x 17 mm	Flex Flare Nut Wrench
81690	16 x 18 mm	Flex Flare Nut Wrench
81692	19 x 21 mm	Flex Flare Nut Wrench



81910 - 5 Pc. Flex Flare Nut Non-Ratcheting Wrench Set SAE

Material No.	Description	
81693	1/4" x 5/16"	Flex Flare Nut Wrench
81694	3/8 x 7/16"	Flex Flare Nut Wrench
81695	1/2" x 9/16"	Flex Flare Nut Wrench
81696	5/8" x 11/16"	Flex Flare Nut Wrench
81697	3/4" x 7/8"	Flex Flare Nut Wrench



SETS
WRENCHES

CROWFOOT DRIVE NON-RATCHETING WRENCH SETS



81909 - 10 Pc. Crowfoot Drive Non-Ratcheting Wrench Set METRIC

Material No.	Description	
81614	10 mm	Crowfoot Drive Wrench
81615	11 mm	Crowfoot Drive Wrench
81616	12 mm	Crowfoot Drive Wrench
81617	13 mm	Crowfoot Drive Wrench
81618	14 mm	Crowfoot Drive Wrench
81619	15 mm	Crowfoot Drive Wrench
81620	16 mm	Crowfoot Drive Wrench
81621	17 mm	Crowfoot Drive Wrench
81622	18 mm	Crowfoot Drive Wrench
81623	19 mm	Crowfoot Drive Wrench



81908 - 11 Pc. Crowfoot Drive Non-Ratcheting Wrench Set SAE

Material No.	Description	
81603	3/8"	Crowfoot Drive Wrench
81604	7/16"	Crowfoot Drive Wrench
81605	1/2"	Crowfoot Drive Wrench
81606	9/16"	Crowfoot Drive Wrench
81607	5/8"	Crowfoot Drive Wrench
81608	11/16"	Crowfoot Drive Wrench
81609	3/4"	Crowfoot Drive Wrench
81610	13/16"	Crowfoot Drive Wrench
81611	7/8"	Crowfoot Drive Wrench
81612	15/16"	Crowfoot Drive Wrench
81613	1"	Crowfoot Drive Wrench

SETS
WRENCHES

XL X-BEAM™ NON-RATCHETING WRENCH SETS

81912 - 12 Pc. XL X-Beam™ Combination Non-Ratcheting Wrench Set METRIC

Material No.	Description	
81698	8 mm	XL X-Beam™ Combination Wrench
81699	9 mm	XL X-Beam™ Combination Wrench
81700	10 mm	XL X-Beam™ Combination Wrench
81701	11 mm	XL X-Beam™ Combination Wrench
81703	12 mm	XL X-Beam™ Combination Wrench
81705	13 mm	XL X-Beam™ Combination Wrench
81706	14 mm	XL X-Beam™ Combination Wrench
81707	15 mm	XL X-Beam™ Combination Wrench
81709	16 mm	XL X-Beam™ Combination Wrench
81710	17 mm	XL X-Beam™ Combination Wrench
81711	18 mm	XL X-Beam™ Combination Wrench
81713	19 mm	XL X-Beam™ Combination Wrench



81913 - 9 Pc. XL X-Beam™ Combination Non-Ratcheting Wrench Set SAE

Material No.	Description	
81714	5/16"	XL X-Beam™ Combination Wrench
81715	11/32"	XL X-Beam™ Combination Wrench
81717	3/8"	XL X-Beam™ Combination Wrench
81718	7/16"	XL X-Beam™ Combination Wrench
81719	1/2"	XL X-Beam™ Combination Wrench
81721	9/16"	XL X-Beam™ Combination Wrench
81722	5/8"	XL X-Beam™ Combination Wrench
81723	11/16"	XL X-Beam™ Combination Wrench
81725	3/4"	XL X-Beam™ Combination Wrench



SETS
WRENCHES

DRIVE ADAPTER SETS



9230D - 3 Pc. Drive Adapter Set METRIC

Material No.	Description	Weight (g)
9207	1/4" Dr. x 10 mm	12
9208	3/8" Dr. x 13 mm	26
9209	1/2" Dr. x 19 mm	55



9231D - 3 Pc. Drive Adapter Set SAE

Material No.	Description	Weight (g)
9217	1/4" Dr. x 3/8"	12
9218	3/8" Dr. x 1/2"	26
9219	1/2" Dr. x 3/4"	55

ADJUSTABLE CUSHION GRIP WRENCH - OPEN STOCK



Open Stock - Adjustable Cushion Grip Wrenches

Material No.	Overall Length (mm/inch)	Capacity (mm)	Weight (g)
81891	230/9	23.8	282
81892	280/11	28.6	461
81893	330/11	33.3	726



83076 - 3 Pc. Adjustable Wrench Set

Description
150mm/6" Chrome Adjustable wrench
200mm/8" Chrome adjustable wrench
250mm/10" Chrome adjustable wrench
EVA Tray Included: 161mm x 360mm

Fits drawer type **B** as shown on page 34.

OPEN STOCK
WRENCHES

TORQUE WRENCHES



Torque Wrenches

Electronic Torque Wrenches
Micrometer Torque Wrenches

ELECTRONIC TORQUE WRENCHES WITH ANGLE



Sealed design guards against dirt infiltration

Backlit LCD Screen makes reading torque and angle values quick and easy



Digitally tracks torque and angle measurements. Buzzer with Red, Yellow and Green lights alerts you when targets are reached. (Models 85073, 85074)

Shock-resistant housing provides durability



Thin-profile, high-strength teardrop head flexes for easier access and features a 60-tooth gear with 6° ratcheting arc

Torque Accuracy: +/- 2% CW, +/- 3% CCW from 20% to 100% full scale.
Angle Accuracy: +/- 1% of reading

Knurled Aluminum Grip resists slipping

MICROMETER TORQUE WRENCHES

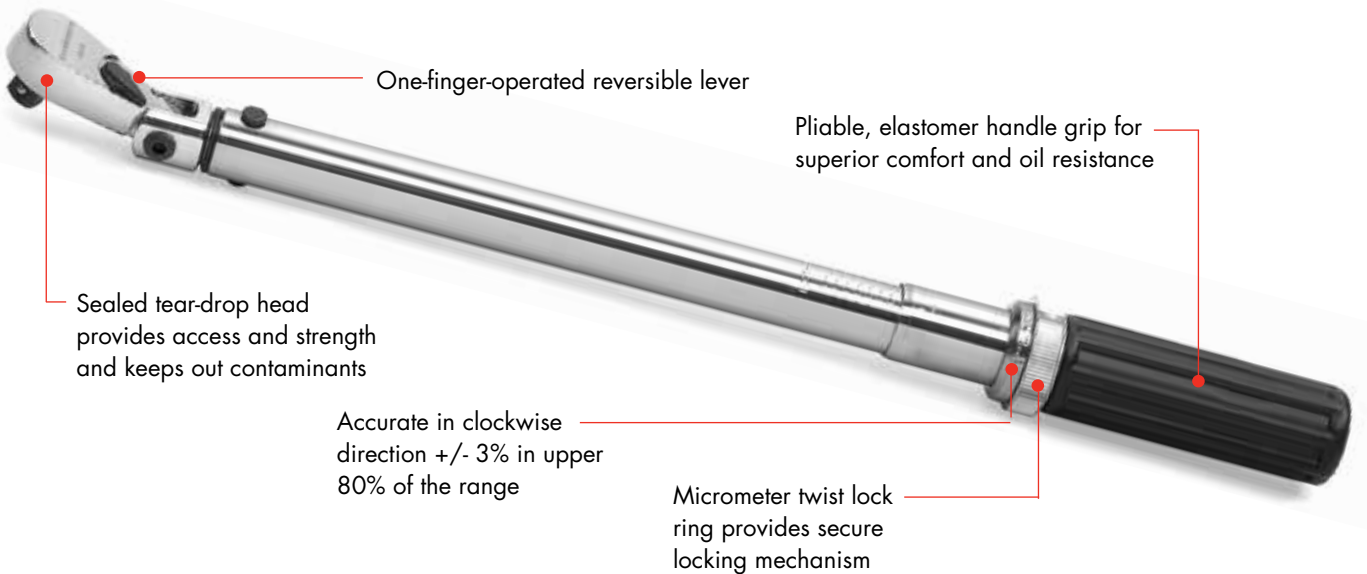

One-finger-operated reversible lever

Pliable, elastomer handle grip for superior comfort and oil resistance

Sealed tear-drop head provides access and strength and keeps out contaminants

Accurate in clockwise direction +/- 3% in upper 80% of the range

Micrometer twist lock ring provides secure locking mechanism

TORQUE WRENCHES

All torque wrenches have a dual scale American standard (ft/lbs) and metric (Newton meters).

Electronic Flex Head Torque Wrench with Angle

Material No.	Drive Size	Torque Range	Weight (kg)
85073	3/8"	1.12-11.30 Nm/ 10 - 100 in/lbs	0.95
85074	1/2"	2.82-28.25 Nm/ 25 - 250 in/lbs	1.6

Calibration Certificate provided.



Electronic Torque Wrench - Not Angled

Material No.	Drive Size	Torque Range	Weight (kg)
85070	3/8"	14-136 Nm/ 10 - 100 ft/lbs	1.5
85071	1/2"	34-339 Nm/ 25 - 250 ft/lbs	2.2

Calibration Certificate provided.



85050 - Micrometer Torque Wrench 1/4" Drive

Torque Range	Weight (kg)
41-271 Nm/ 30 - 200 ft/lbs	0.61



Micrometer Torque Wrench 3/8" Drive

Material No.	Torque Range	Weight (kg)
85051	34-339 Nm/ 25 - 250 ft/lbs	1.1
85052	14-136 Nm/ 10 - 100 ft/lbs	1.5

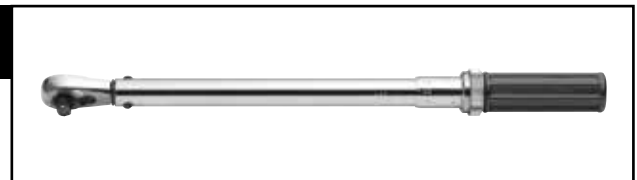

Micrometer Torque Wrench 1/2" Drive

Material No.	Torque Range	Weight (kg)
85053	27-204 Nm/ 20 - 150 ft/lbs	1.9
85054	27-339 Nm/ 20 - 250 ft/lbs	2.3



85055 - Micrometer Torque Wrench 3/4" Drive

Torque Range	Weight (kg)
136-814 Nm/ 100 - 600 ft/lbs	7.3



SCREWDRIVERS & NUTDRIVERS

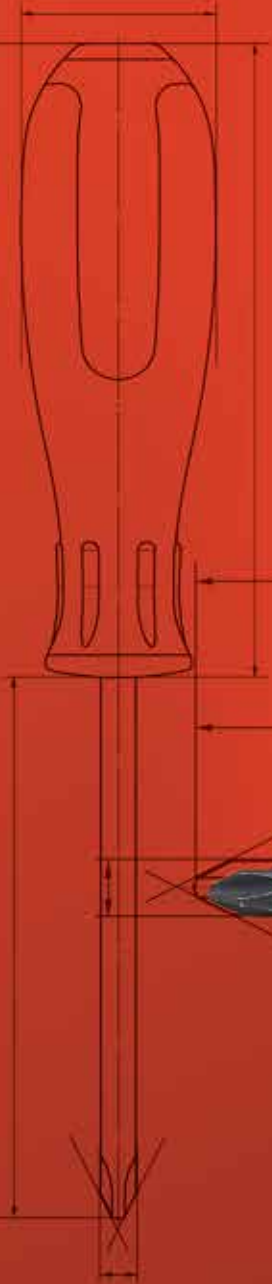
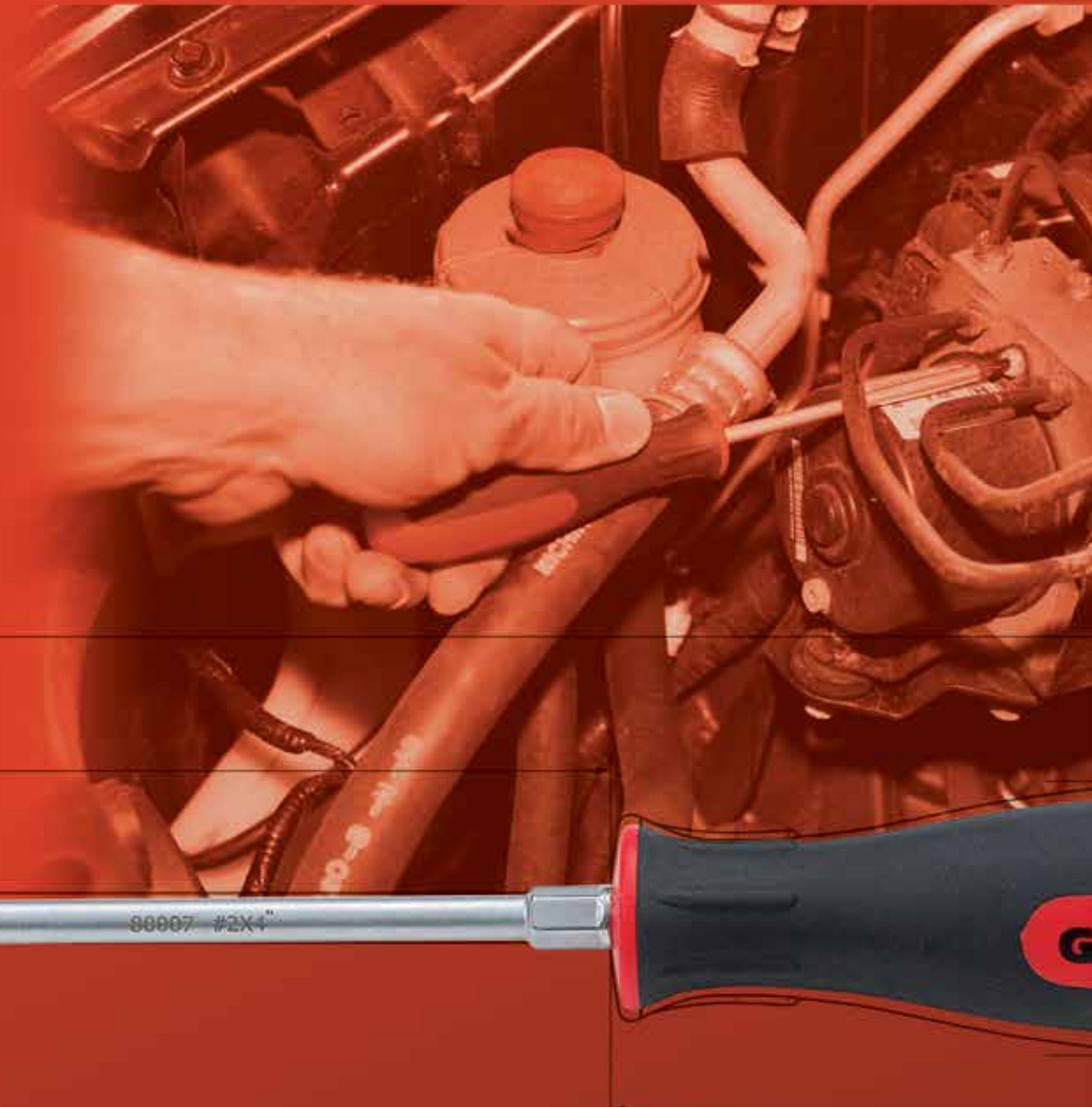

Screwdrivers & Nutdrivers

Dual Material Screwdrivers
Cushion Grip Screwdrivers
Nutdrivers
Ratcheting Nutdrivers

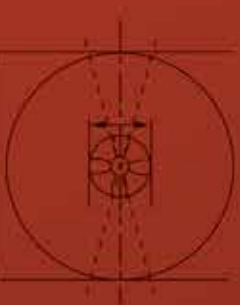

**DUAL MATERIAL
SCREWDRIVERS**

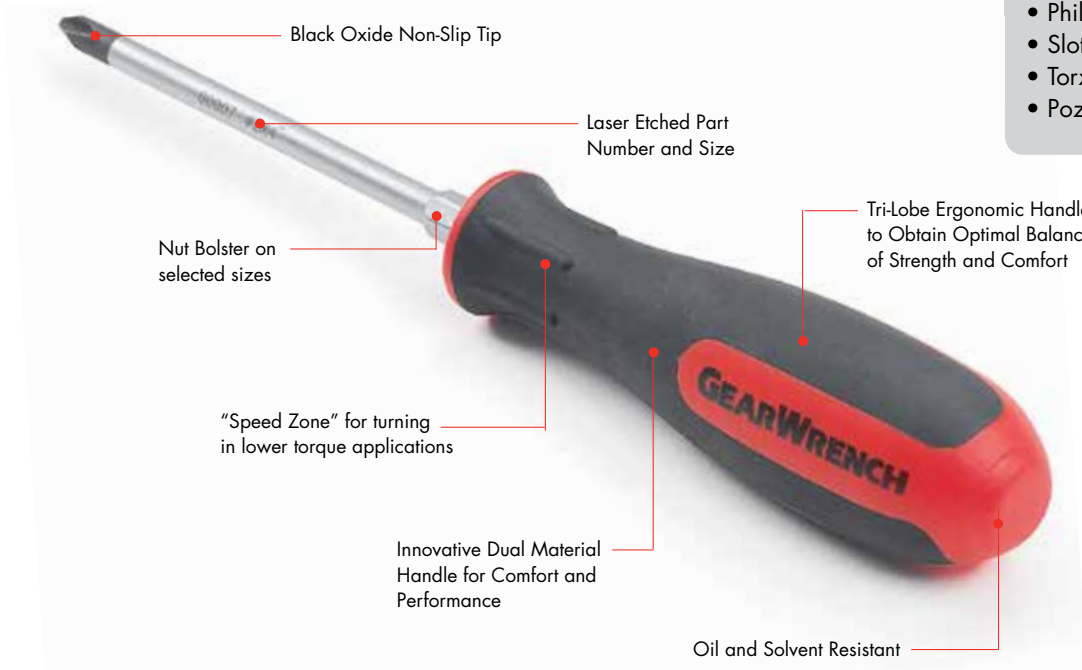

- AVAILABLE IN:**
- Phillips
 - Slotted
 - Torx®
 - Pozidrive®

**MINI
SCREWDRIVERS**

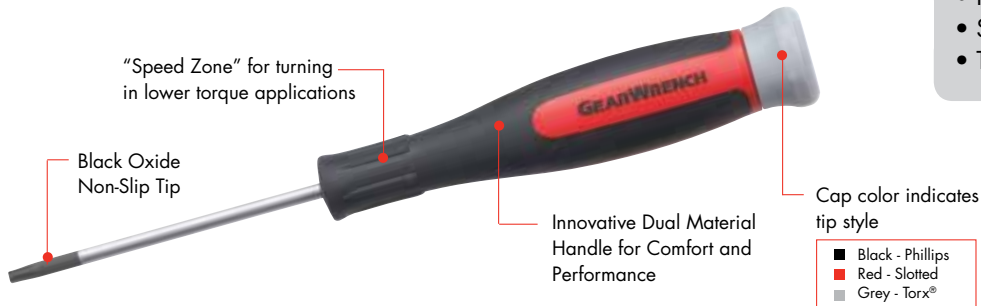

- AVAILABLE IN:**
- Phillips
 - Slotted
 - Torx®



**RATCHETING
SCREWDRIVERS**

- AVAILABLE IN:**
- Standard
 - T-Handle
 - Stubby

Products are covered by one or more of the following patents:
 • US 7,137,320

SCREWDRIVER SETS

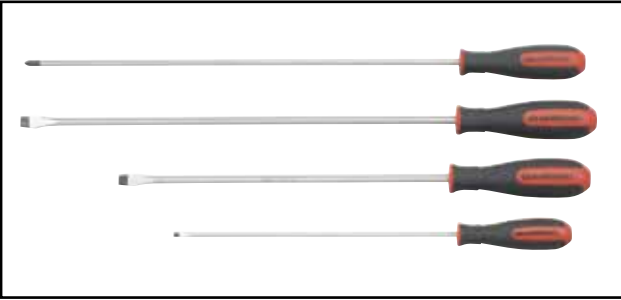

80059 - 4 Pc. Long Dual Material Screwdriver Set

Material No.	Description
80021	3/8" x 16" Long Slotted Screwdriver
80019	3/16" x 10" Long Slotted Screwdriver
80020	3/8" x 12" Long Slotted Screwdriver
80006	#2 x 16" Long Phillips Screwdriver

*Packaged on Re-usable Hang Up Card



80050 - 6 Pc. Combination Dual Material Screwdriver Set

Material No.	Description
80015	1/8" x 3" Slotted Screwdriver
80013	1/4" x 4" Slotted Screwdriver
80023	5/16" x 6" Slotted Screwdriver
80022	3/8" x 8" Slotted Screwdriver
80001	#1 x 3" Phillips Screwdriver
80007	#2 x 4" Phillips Screwdriver



80060 - 10 Pc. Combination and Pozidriv® Dual Material Screwdriver Set

Material No.	Description
80043	#0 x 2-1/2" Pozidriv® Screwdriver
80044	#1 x 3" Pozidriv® Screwdriver
80045	#2 x 4" Pozidriv® Screwdriver
80046	#3 x 6" Pozidriv® Screwdriver
80015	1/8" x 3" Slotted Screwdriver
80017	3/16" x 4" Slotted Screwdriver
80013	1/4" x 4" Slotted Screwdriver
80023	5/16" x 6" Slotted Screwdriver
80001	#1 x 3" Phillips Screwdriver
80007	#2 x 4" Phillips Screwdriver

SETS

SCREWDRIVERS

SCREWDRIVER SETS

80051 - 12 Pc. Combination Dual Material Screwdriver Set

Material No.	Description
80012	1/4" x 1-1/2" Slotted Screwdriver
80018	3/16" x 6" Slotted Screwdriver
80013	1/4" x 4" Slotted Screwdriver
80014	1/4" x 6" Slotted Screwdriver
80023	5/16" x 6" Slotted Screwdriver
80022	3/8" x 8" Slotted Screwdriver
80000	#0 x 2-1/2" Phillips Screwdriver
80001	#1 x 3" Phillips Screwdriver
80004	#1 x 6" Phillips Screwdriver
80005	#2 x 1-1/2" Phillips Screwdriver
80007	#2 x 4" Phillips Screwdriver
80011	#3 x 6" Phillips Screwdriver

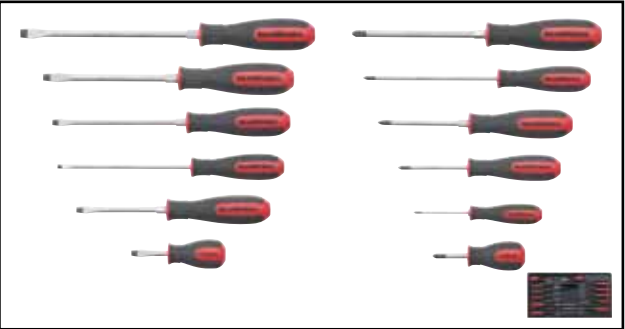

80066 - 20 Pc. Master Dual Material Screwdriver Set

Material No.	Description
80012	1/4" x 1-1/2" Slotted Screwdriver
80018	3/16" x 6" Slotted Screwdriver
80013	1/4" x 4" Slotted Screwdriver
80014	1/4" x 6" Slotted Screwdriver
80023	5/16" x 6" Slotted Screwdriver
80022	3/8" x 8" Slotted Screwdriver
80000	#0 x 2-1/2" Phillips Screwdriver
80001	#1 x 3" Phillips Screwdriver
80004	#1 x 6" Phillips Screwdriver
80005	#2 x 1-1/2" Phillips Screwdriver
80007	#2 x 4" Phillips Screwdriver
80011	#3 x 6" Phillips Screwdriver
80034	1.5mm Mini Slotted Screwdriver
80035	2.0mm Mini Slotted Screwdriver
80036	2.5mm Mini Slotted Screwdriver
80031	#00 Mini Phillips Screwdriver
80032	#0 Mini Phillips Screwdriver
80033	#1 Mini Phillips Screwdriver
80025	T-15 Torx® Screwdriver
80026	T-20 Torx® Screwdriver



83073 - 52 Pc. Screwdriver Set

Description

- Slotted Screwdrivers: 6mm x 38mm, 5mm x 150mm, 6mm x 100mm, 6mm x 150mm, 8mm x 150mm, 10mm x 200mm
- Phillips Screwdrivers: PH#0 x 65mm, PH#1 x 75mm, PH#1 x 150mm, PH#2 x 38mm, PH#2 x 100mm, PH#3 x 150mm
- Mini Slotted Screwdrivers: 1.5mm, 2.0mm, 2.5mm
- Mini Phillips Screwdrivers: PH#00, PH#0, PH#1
- Long Torx® Screwdrivers: T-15, T-20
- Hex Bits: 1/8", 5/32", 3/16", 7/32", 1/4", 5/16"
- Hex Bits: 3mm, 4mm, 5mm, 6mm, 7mm, 8mm
- Slotted Bits: 5/32", 7/32", 1/4"
- Slotted Bits: 4mm, 5.5mm, 6.5mm
- Torx® Bits: T-8, T-10, T-15, T-20, T-25, T-27, T-30, T-40
- Phillips Bits: PH#0, PH#1, PH#2, PH#3
- Ratcheting Screwdriver Handle
- 6mm Shank Magnetic Bit Shaft 150mm
- EVA Tray Included: uncut 655mm x 395mm, cut = 557mm x 360mm

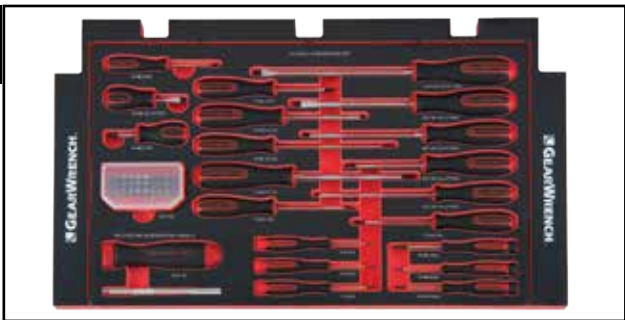

Fits drawer type **A** as shown on page 34.

SCREWDRIVER SETS



8939 - 39 Pc. Ratcheting Screwdriver Set

Material No.	Description
890001GD	Ratcheting Screwdriver Handle - Red
310901GR	3-1/2" 1/4" Shank Magnetic Bit Shaft
310902GR	6" 1/4" Shank Magnetic Bit Shaft
310903GR	10" 1/4" Shank Magnetic Bit Shaft
311901GR	3-1/2" 1/4" Shank Socket Shaft
311902GR	6" 1/4" Shank Socket Shaft
311904GR	10" 1/4" Shank Socket Shaft
311903GR	6" 1/4" Flexible Socket Shaft
890002GD	1/4" Hex Shank Bit Adapter
890003GD	30 Pc. Bit Set in Case
	3 mm Hex Bit
	4 mm Hex Bit
	5 mm Hex Bit
	6 mm Hex Bit
	7 mm Hex Bit
	8 mm Hex Bit
	1/8" Hex Bit
	5/32" Hex Bit
	3/16" Hex Bit
	7/32" Hex Bit
	1/4" Hex Bit
	5/16" Hex Bit
	#0 Phillips Bit
	#1 Phillips Bit
	#2 Phillips Bit
	#3 Phillips Bit
	4mm Slotted Bit
	5.5mm Slotted Bit
	6.5mm Slotted Bit
	5/32" Slotted Bit
	7/32" Slotted Bit
	1/4" Slotted Bit
	T-8 Torx® Bit
	T-10 Torx® Bit
	T-15 Torx® Bit
	T-20 Torx® Bit
	T-25 Torx® Bit
	T-27 Torx® Bit
	T-30 Torx® Bit
	T-40 Torx® Bit

SCREWDRIVER SETS

80055 - 6 Pc. Mini Dual Material Screwdriver Set

Material No.	Description
80034	1.5mm Mini Slotted Screwdriver
80035	2.0mm Mini Slotted Screwdriver
80036	2.5mm Mini Slotted Screwdriver
80031	#00 Mini Phillips Screwdriver
80032	#0 Mini Phillips Screwdriver
80033	#1 Mini Phillips Screwdriver

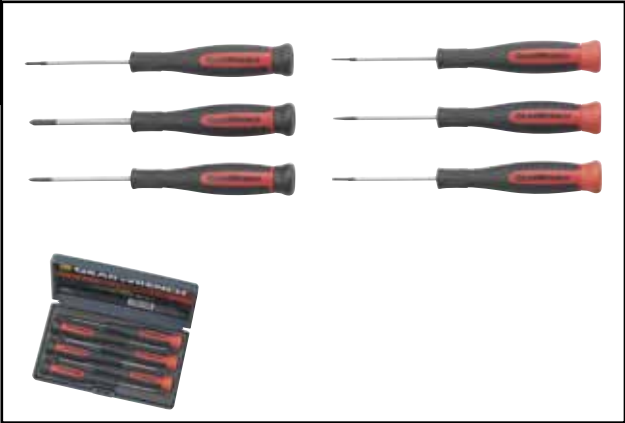

80072 - 2 Pc. Offset Screwdriver Set

Material No.	Description
	1/4" Slotted x #2 Phillips Offset Screwdriver
	3/16" Slotted x #1 Phillips Offset Screwdriver



NUT DRIVER SETS



82764 - 7 Pc. Full Hollow Shaft Cushion Grip Nut Driver Set METRIC

Material No.	Description
82757D	6 mm Nut Driver, Hollow Shaft
82758	7 mm Nut Driver, Hollow Shaft
82759	8 mm Nut Driver, Hollow Shaft
82760	9 mm Nut Driver, Hollow Shaft
82761	10 mm Nut Driver, Hollow Shaft
82762	11 mm Nut Driver, Hollow Shaft
82763	12 mm Nut Driver, Hollow Shaft



82765 - 7 Pc. Full Hollow Shaft Cushion Grip Nut Driver Set SAE

Material No.	Description	
82750	3/16" Nut Driver, Hollow Shaft	Black
82751	1/4" Nut Driver, Hollow Shaft	Red
82752	5/16" Nut Driver, Hollow Shaft	Yellow
82753	11/32" Nut Driver, Hollow Shaft	Green
82754	3/8" Nut Driver, Hollow Shaft	Blue
82755	7/16" Nut Driver, Hollow Shaft	Brown
82756	1/2" Nut Driver, Hollow Shaft	Red

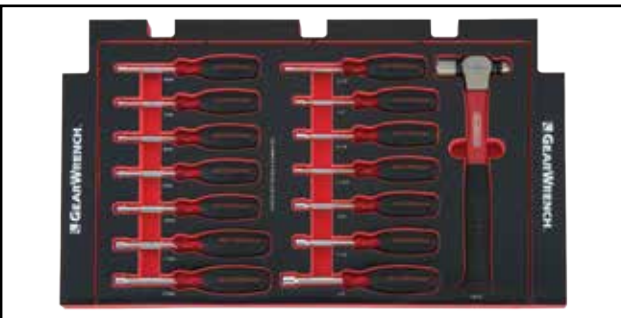

83074 - 15 Pc. Nut Driver + Hammer Set METRIC/SAE

Description
Nut Driver Hollow Shaft Metric: 6mm, 7mm, 8mm, 9mm, 10mm, 11mm, 12mm
Nut Driver Hollow Shaft SAE: 3/16", 1/4", 5/16", 11/32", 3/8", 7/16", 1/2"
16oz Ball Pein Hammer Fiberglass
EVA Tray Included: uncut 655mm x 395mm, cut = 557mm x 360mm

Fits drawer type **A** as shown on page 34.

NUT DRIVER SETS

8909D - 9 Pc. Ratcheting Nut Driver Set METRIC

Material No.	Description
890005GD	Ratcheting Screwdriver Stubby Handle - Red
891050GD	5mm Nut Driver Shaft
891060GD	6mm Nut Driver Shaft
891070GD	7mm Nut Driver Shaft
891080GD	8mm Nut Driver Shaft
891090GD	9mm Nut Driver Shaft
891100GD	10mm Nut Driver Shaft
891110GD	11mm Nut Driver Shaft
891120GD	12mm Nut Driver Shaft



8916D - 16 Pc. Ratcheting Nut Driver Set SAE/ METRIC

Material No.	Description
890005GD	Ratcheting Screwdriver Stubby Handle - Red
890060GD	3/16" Nut Driver Shaft
890080GD	1/4" Nut Driver Shaft
890100GD	5/16" Nut Driver Shaft
890110GD	11/32" Nut Driver Shaft
890120GD	3/8" Nut Driver Shaft
890140GD	7/16" Nut Driver Shaft
890160GD	1/2" Nut Driver Shaft
891050GD	5mm Nut Driver Shaft
891060GD	6mm Nut Driver Shaft
891070GD	7mm Nut Driver Shaft
891080GD	8mm Nut Driver Shaft
891090GD	9mm Nut Driver Shaft
891100GD	10mm Nut Driver Shaft
891110GD	11mm Nut Driver Shaft
891120GD	12mm Nut Driver Shaft



PLIERS

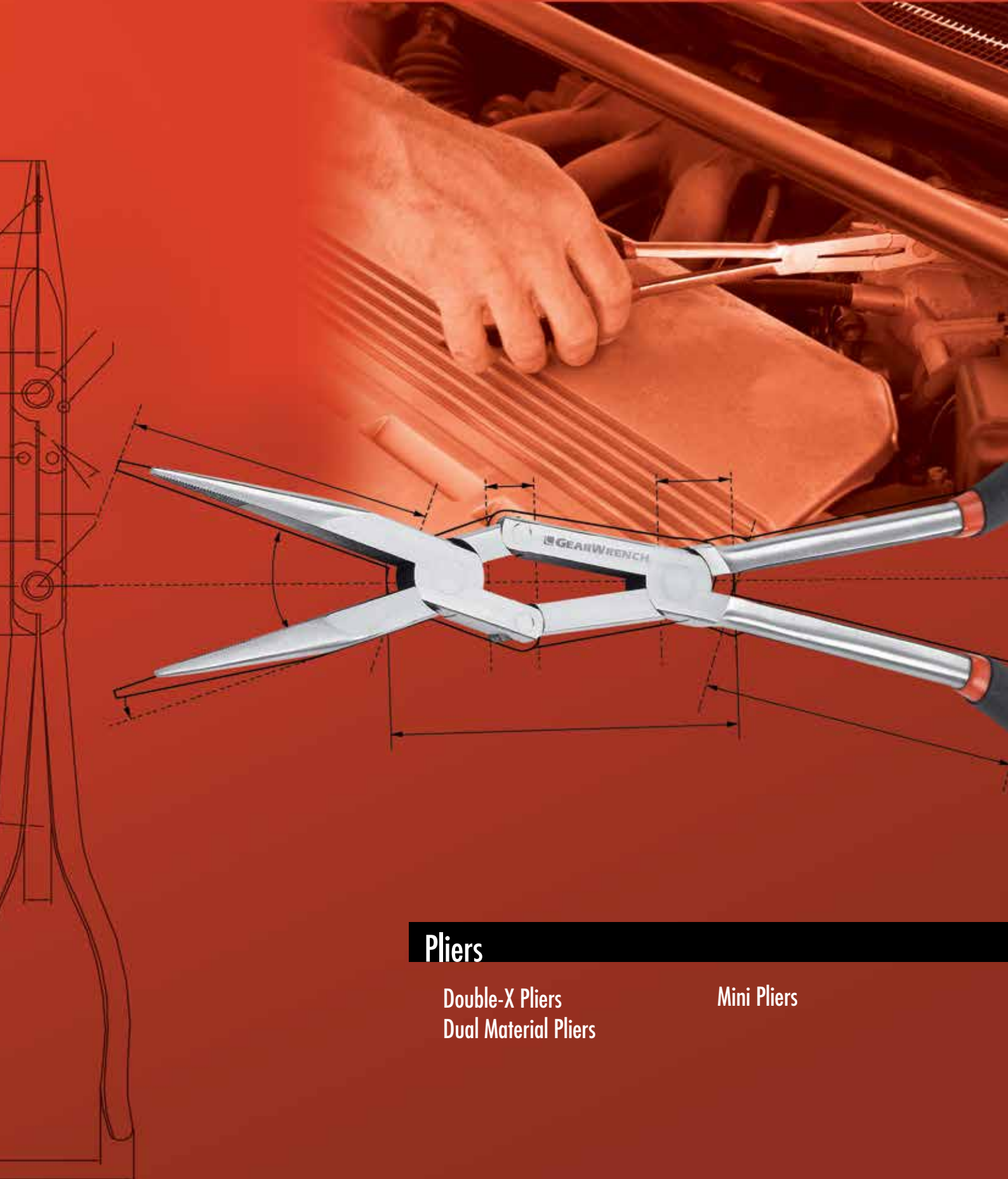

Pliers

Double-X Pliers
Dual Material Pliers

Mini Pliers

**DOUBLE-X™
PLIERS**

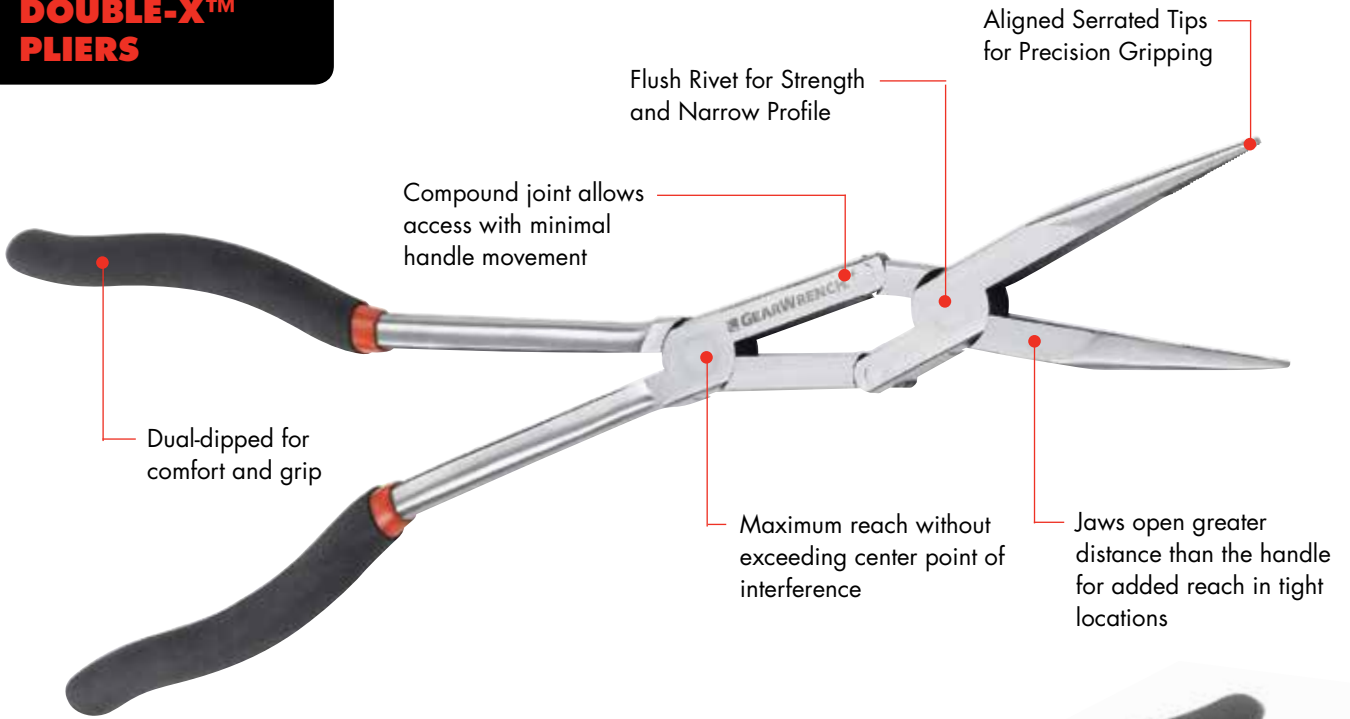

- AVAILABLE IN:**
- Straight Standard Pliers
 - 45° Standard Pliers
 - Duck Bill Standard Pliers
 - Internal / External Snap Ring Pliers
 - Straight Hemostat Pliers
 - 45° Hemostat Pliers

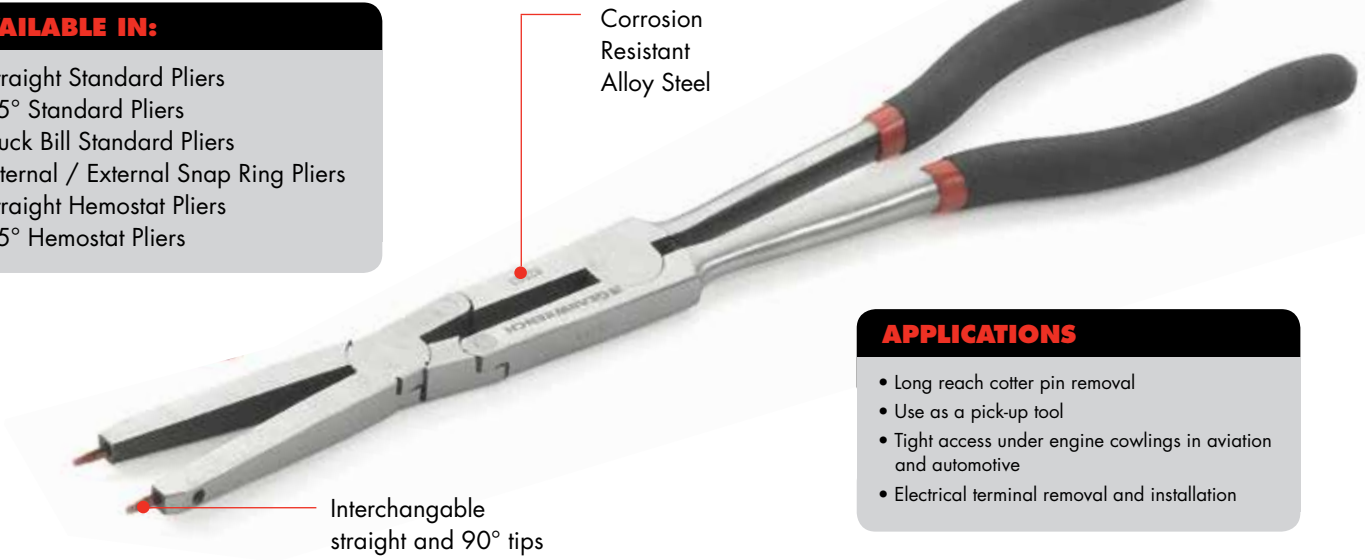

- APPLICATIONS**
- Long reach cotter pin removal
 - Use as a pick-up tool
 - Tight access under engine cowlings in aviation and automotive
 - Electrical terminal removal and installation

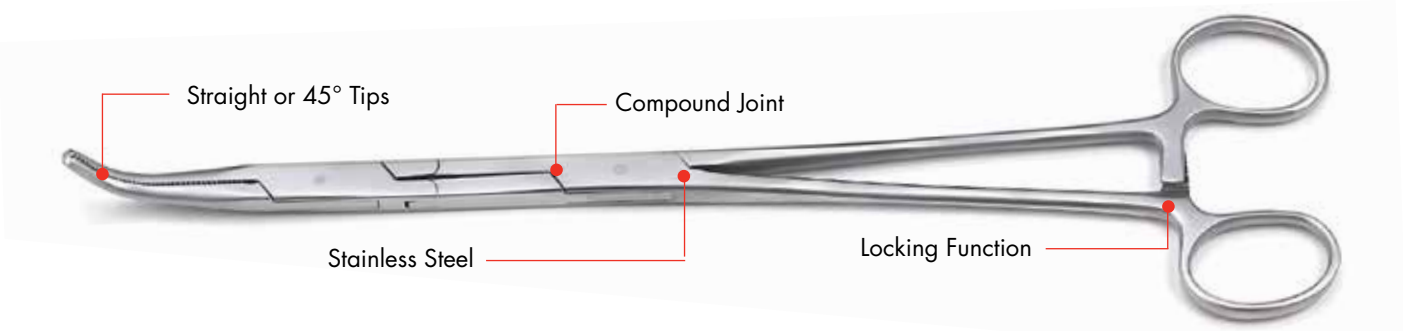

DUAL MATERIAL GRIP PLIERS

AVAILABLE IN:

- Slip Joint Pliers
- Duck Bill Pliers
- Diagonal Pliers
- Linesmans Pliers
- Bent Nose Pliers
- Groove Joint Pliers
- Long Nose Pliers
- Fence Pliers



PLIERS - SETS

82103 - 4 Pc. Mixed Pliers Set

Material No.	Description
82011	Tongue and Groove Pliers
82012	Diagonal Cutting Pliers
82013	Long Nose Pliers
82014	Slip Joint Pliers

Weight 1.406 kg

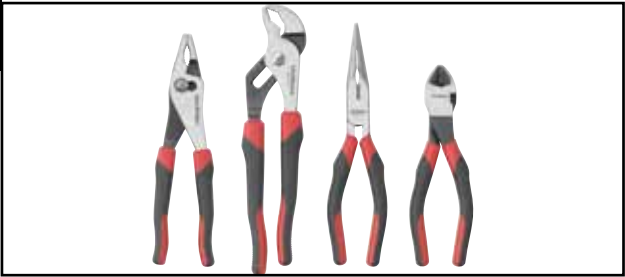

82100 - 5 Pc. Mixed Mini Pliers Set

Material No.	Description
82000	Diagonal Cutting Mini Pliers
82001	Long Nose Mini Pliers
82002	Needle Nose Mini Pliers
82003	End Cutting Nipper Mini Pliers
82004	Flat Nose Mini Pliers

Weight 0.450 kg

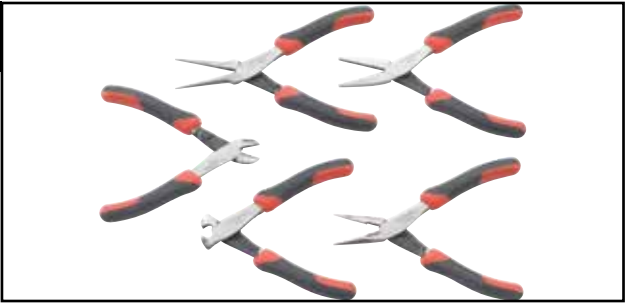

82108 - 7 Pc. Mixed Pliers Set

Material No.	Description
82011	Tongue and Groove Pliers
82012	Diagonal Cutting Pliers
82013	Long Nose Pliers
82014	Slip Joint Pliers
82020	12" Groove Joint Pliers with Straight Jaw
82025	8" Linesman Pliers
82028	8" End Nipper Pliers

Weight 2.495 kg

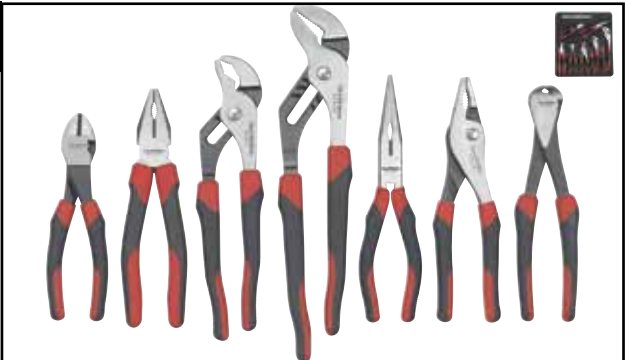

80058 - 8 Pc. Mini Screwdriver & Pliers Set

Material No.	Description
82001	Long Nose Mini Pliers
82000	Diagonal Cutting Mini Pliers
80034	1.5 mm Mini Slotted Screwdriver
80035	2.0 mm Mini Slotted Screwdriver
80036	2.5 mm Mini Slotted Screwdriver
80031	#00 Mini Phillips Screwdriver
80032	#0 Mini Phillips Screwdriver
80033	#1 Mini Phillips Screwdriver

Weight 0.680 kg



83072 - 12 Pc. Plier Set

Description

- Diagonal Cutting Plier: 178mm/7"
- Long Nose Plier: 203mm/8"
- Groove Joint with Straight Jaw: 305mm/12"
- Universal Plier: 203mm/8"
- End Nipper: 203mm/8"
- Mini Diagonal Plier, Mini Long Nose Plier
- Mini Needle Nose Plier, Mini End Nipper, Mini Duck Bill Plier
- Long Nose Locking Plier with Wire Cutter: 152mm/6"
- Curved Jaw Locking Plier with Wire Cutter: 254mm/10"
- EVA Tray Included: uncut 655mm x 395mm, cut = 557mm x 360mm

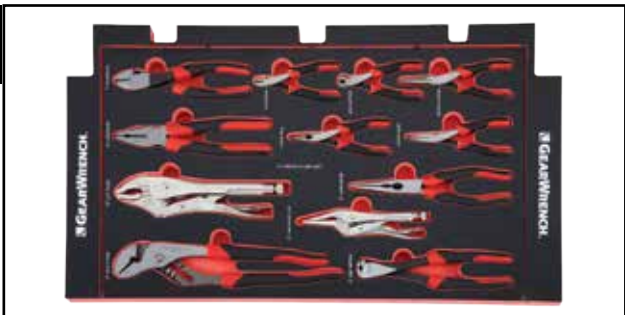

Fits drawer type **A** as shown on page 34.

PLIERS - SETS & OPEN STOCK

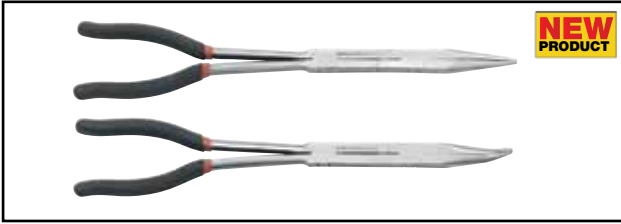

82106 - 2 Pc. Double-X™ Pliers Set

Material No.	Description
82005	Straight Double-X™ Pliers
82006	45 Degree Double-X™ Pliers

Weight 821gm



82005D - Straight Double-X™ Pliers

Jaw Length A (mm)	Jaw Width B (mm)	Jaw Thickness C (mm)	Overall Length D (mm)	Weight (g)
80	17	10	594	381

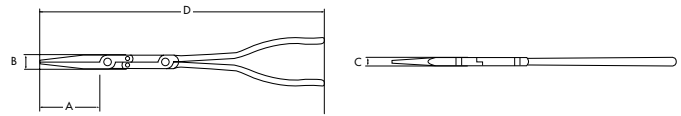

82006D - 45 Degree Double-X™ Pliers

Jaw Length A (mm)	Jaw Width B (mm)	Jaw Thickness C (mm)	Overall Length D (mm)	Weight (g)
75	17	10	337	390

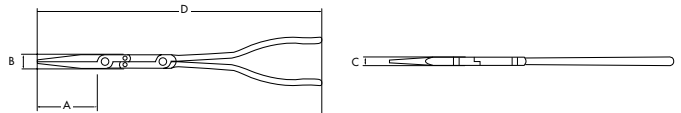

82007 - Duck Bill Double-X™ Pliers

Jaw Length A (mm)	Jaw Width B (mm)	Jaw Thickness C (mm)	Overall Length D (mm)	Weight (g)
42	17	10	304	358

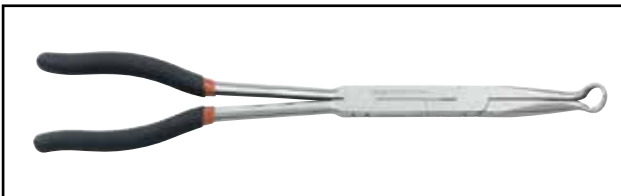
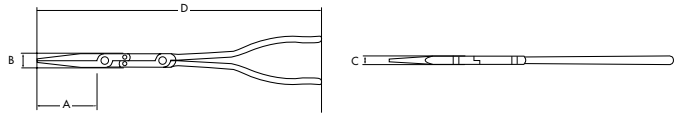

Open Stock - Hose Grip Double-X™ Pliers

Material No.	Size	Jaw Length A (mm)	Jaw Width B (mm)	Jaw Thickness C (mm)	Overall Length D (mm)	Weight (g)
82017	5/16"	73	17.3	10	335	376
82018	1/2"	71	17.3	10	333	376
82019	3/4"	69	17.3	10	330	376

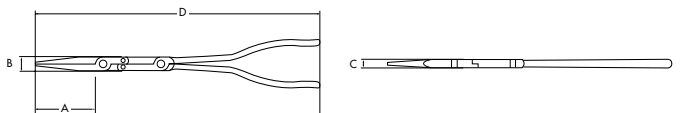

PLIERS - OPEN STOCK

82032 - Double-X™ Internal Snap Ring Pliers

Jaw Length A (mm)	Jaw Width B (mm)	Jaw Thickness C (mm)	Overall Length D (mm)	Weight (g)
80	17	10	342	399

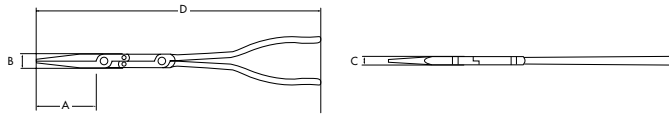

82033 - Double-X™ External Snap Ring Pliers

Jaw Length A (mm)	Jaw Width B (mm)	Jaw Thickness C (mm)	Overall Length D (mm)	Weight (g)
80	17	10	342	399

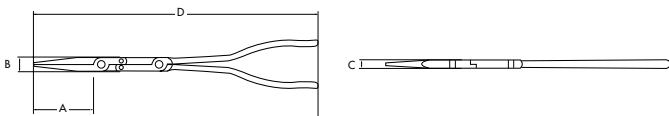

82034 - Double-X™ Straight Hemostat Pliers

Jaw Length A (mm)	Jaw Width B (mm)	Jaw Thickness C (mm)	Overall Length D (mm)	Weight (g)
107	4	3.3	250	95

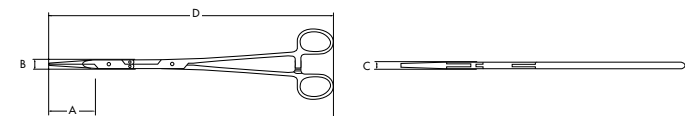

82035 - Double-X™ 45 Degree Hemostat Pliers

Jaw Length A (mm)	Jaw Width B (mm)	Jaw Thickness C (mm)	Overall Length D (mm)	Weight (g)
104	4	3.3	247	95

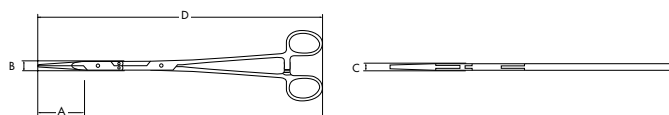

PRY BARS



Pry Bars

Indexing Pry Bar
Extendable Pry Bar

INDEXING PRY BARS

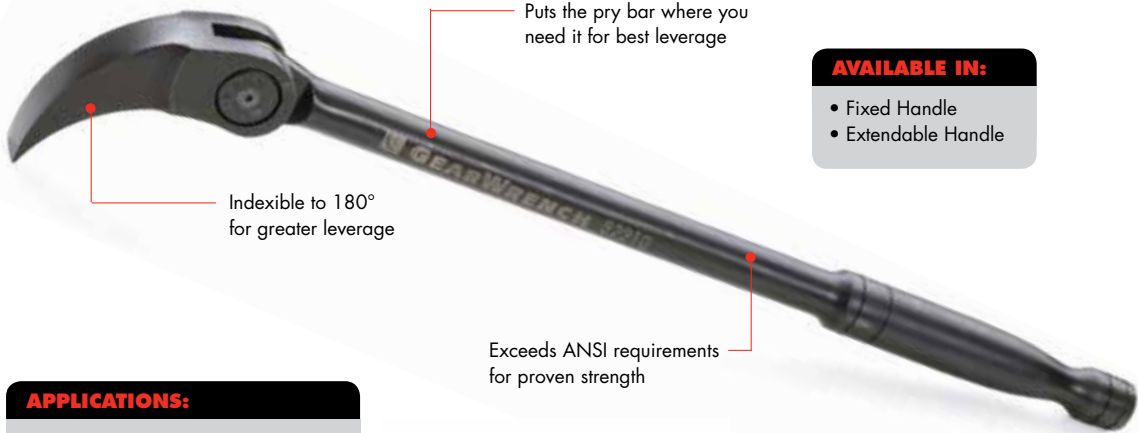

- AVAILABLE IN:**
- Fixed Handle
 - Extendable Handle

- APPLICATIONS:**
- Demolition of roof rafters and floor joists
 - Removing broken concrete
 - Repositioning equipment
 - Aligning steel components and fabrications
 - Engine repositioning and placement



Products are covered by one or more of the following patents:
 • US 6,840,141

PRY BARS

PRY BARS

PRY BARS



82300 - 2 Pc. Pry Bar Set

Material No.	Description
82216	406mm/16" Indexing Pry Bar
82208	203mm/8" Indexing Pry Bar



Open Stock - Indexing Pry Bar

Material No.	Description
82208	NEW PRODUCT 203mm/8" Indexing Pry Bar
82210	NEW PRODUCT 254mm/10" Indexing Pry Bar
82216	NEW PRODUCT 406mm/16" Indexing Pry Bar
82224	609mm/24" Indexing Pry Bar
82233	NEW PRODUCT 838mm/33" Indexing Pry Bar



Open Stock - Extendable Pry Bar

Material No.	Description
82220	457mm/18" to 736mm/29" Extendable Pry Bar
82248	NEW PRODUCT 736mm/29" to 1219mm/48" Extendable Pry Bar

PUNCHES & CHISELS

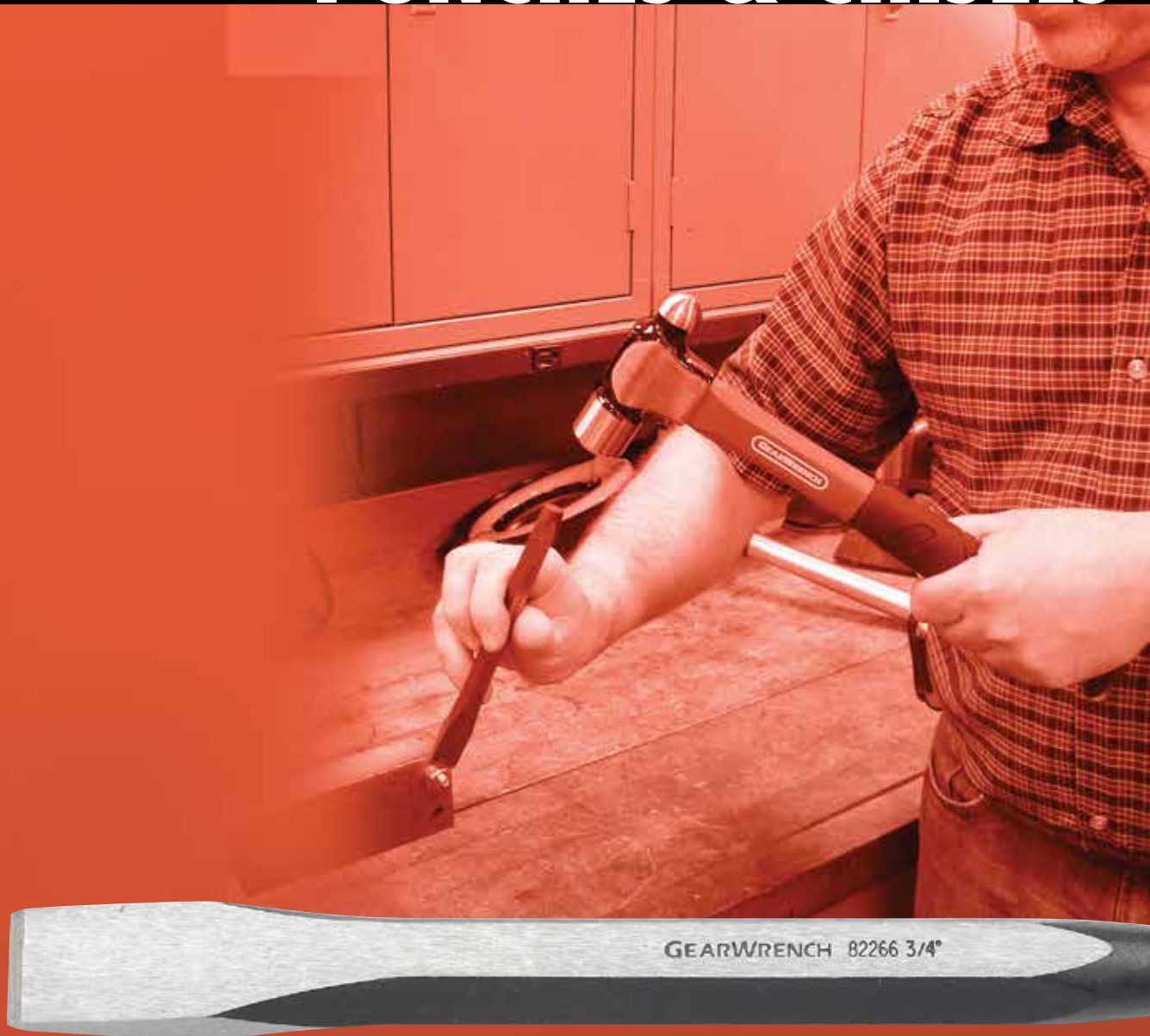

Punches & Chisels

Punches
Chisels

PUNCHES AND CHISELS

AVAILABLE IN:

- Cold Chisels
- Centre Punches
- Pin Punches
- Long Taper Punches

Hardened Tips

Precision Hardened Alloy Steel

Surface Ground for Easy Size identification

Softened Striking Surface



PUNCHES AND CHISELS

82304 - 5 Pc. Punch and Chisel Set

Material No.	Description
82270	3/8" x 5" Center Punch
82273	1/8" x 5" x 5/16" Pin Punch
82274	5/32" x 5-1/4" x 5/16" Pin Punch
82275	3/16" x 5-1/2" x 5/16" Pin Punch
82264	1/2" x 6" x 3/8" Cold Chisel



82308 - 4 Pc. Cold Chisel Set

Material No.	Description
82263	7/16" x 5-1/2" x 3/8" Cold Chisel
82264	1/2" x 6" x 3/8" Cold Chisel
82265	5/8" x 6-1/2" x 3/8" Cold Chisel
82266	3/4" x 7" x 5/8" Cold Chisel



82309 - 5 Pc. Pin Punch Set

Material No.	Description
82273	1/8" x 5" x 5/16" Pin Punch
82274	5/32" x 5-1/4" x 5/16" Pin Punch
82275	3/16" x 5-1/2" x 5/16" Pin Punch
82276	1/4" x 7" x 3/8" Pin Punch
82277	5/16" x 7" x 1/2" Pin Punch



82307 - 4 Pc. Long Taper Punch Set

Material No.	Description
82278	1/8" x 8" x 3/8" Long Taper Punch
82279	5/32" x 8-1/2" x 1/2" Long Taper
82280	3/16" x 9" x 1/2" Long Taper Punch
82281	1/4" x 11" x 5/8" Long Taper Punch



SECS
PUNCHES AND CHISELS

RATCHETING TAPS & DIES

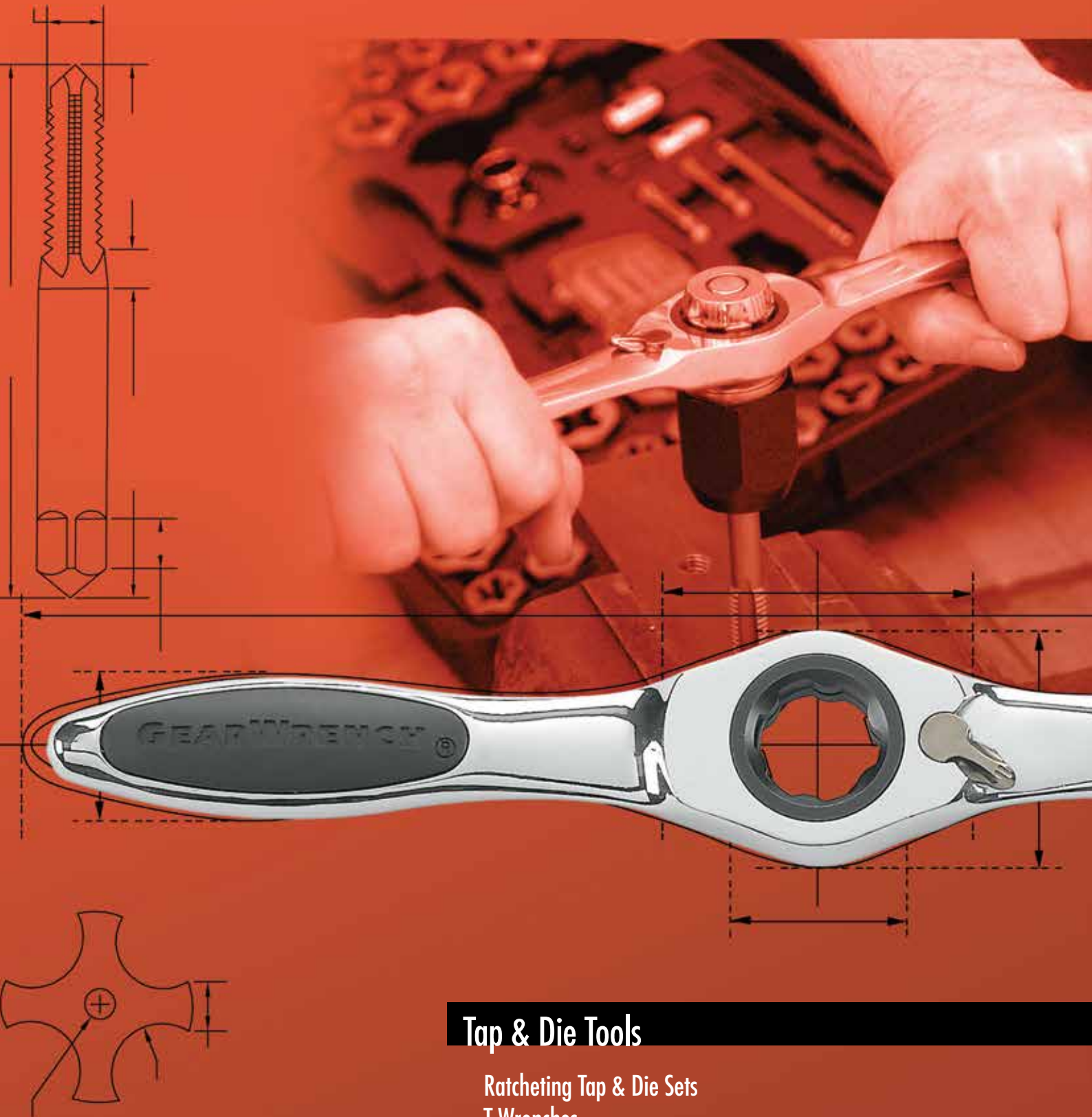

Tap & Die Tools

Ratcheting Tap & Die Sets
T-Wrenches
Adapters

RATCHETING TAP AND DIE DRIVE TOOLS

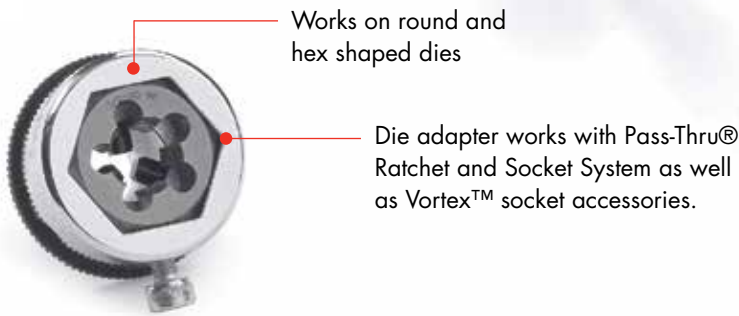

5° Ratcheting arc with reversible lever eliminates hand over hand turning

Patented Twist Lock Guide System reduces "back walk" of die guard



Products are covered by one or more of the following patents:

- US 6,868,759
- US 7,231,851
- US 7,168,346

RATCHETING TAPS & DIES

RATCHETING TAPS AND DIE SETS



3886 - 40 Pc. Medium Ratcheting Tap and Die Drive Tool Set METRIC

Material No.	Description
3881	Medium Tap and Die Ratcheting "T" Wrench
3882	Small Tap Adapter
3883	Medium Tap Adapter
3884	Medium Hex Die Adapter
	Sliding "T" for adapters
	Thread gauge
	#5 screwdriver

Taps	Hex Dies
3 x .50 taper	3 x .60
3 x .60 taper	4 x .70
4 x .70 taper	4 x .75
4 x .75 taper	5 x .80
5 x .80 taper	5 x .90
5 x .90 taper	6 x 1.00
6 x 1.00 taper	7 x 1.00
7 x 1.00 taper	8 x 1.25
8 x 1.25 plug	9 x 1.00
9 x 1.00 plug	9 x 1.25
9 x 1.25 plug	10 x 1.25
10 x 1.25 plug	10 x 1.50
10 x 1.50 plug	11 x 1.50
11 x 1.50 plug	12 x 1.50
12 x 1.50 plug	12 x 1.75
12 x 1.75 plug	1/8 - 28BSP

SETS

RATCHETING TAPS & DIES

RATCHETING TAPS AND DIE SETS

3885 - 40 Pc. Medium Ratcheting Tap and Die Drive Tool Set SAE

Material No.	Description
3881	Medium Tap and Die Ratcheting "T" Wrench
3882	Small Tap Adapter
3883	Medium Tap Adapter
3884	Medium Hex Die Adapter
	Sliding "T" for adapters
	Thread gauge
	#5 screwdriver

Taps

1/4 - 20 NC taper
1/4 - 28 NF taper
5/16 - 18 NC taper
5/16 - 24 NF taper
3/8 - 16 NC plug
3/8 - 24 NF plug
7/16 - 14 NC plug
7/16 - 20 NF plug
1/2 - 13 NC plug
1/2 - 20 NF plug
4 - 40 taper
6 - 32 taper
8 - 32 taper
10 - 24 taper
10 - 32 taper
12 - 24 taper
1/8 - 27 NPT

Hex Dies

1/4 - 20 NC
1/4 - 28 NF
5/16 - 18 NC
5/16 - 24 NF
3/8 - 16 NC
3/8 - 24 NF
7/16 - 14 NC
7/16 - 20 NF
1/2 - 13 NC
1/2 - 20 NF
4 - 40 taper
6 - 32 taper
8 - 32 taper
10 - 24 taper
10 - 32 taper
12 - 24 taper
1/8 - 27 NPT



SETS
RATCHETING TAPS & DIES

RATCHETING TAPS AND DIE SETS



3887 - 75 Pc. Medium Ratcheting Tap and Die Drive Tool Set SAE/METRIC

Material No.	Description
3881	Medium Tap and Die Ratcheting "T" Wrench
3882	Small Tap Adapter
3883	Medium Tap Adapter
3884	Medium Hex Die Adapter
	Sliding "T" for adapters
	SAE screw pitch gauge
	METRIC screw pitch gauge
	#5 screwdriver

SETS
RATCHETING TAPS & DIES

PATENTED

Taps

1/4 - 20 NC taper	1/4 - 20 NC taper
1/4 - 28 NF taper	1/4 - 28 NF taper
5/16 - 18 NC taper	5/16 - 18 NC taper
5/16 24 NF taper	5/16 24 NF taper
3/8 - 16 NC plug	3/8 - 16 NC plug
3/8 - 24 NF plug	3/8 - 24 NF plug
7/16 -14 NC plug	7/16 -14 NC plug
7/16 - 20 NF plug	7/16 - 20 NF plug
1/2 - 13 NC plug	1/2 - 13 NC plug
1/2 - 20 NF plug	1/2 - 20 NF plug
4 - 40 taper	4 - 40 taper
6 - 32 taper	6 - 32 taper
8 - 32 taper	8 - 32 taper
10 - 24 taper	10 - 24 taper
10 - 32 taper	10 - 32 taper
12 - 24 taper	12 - 24 taper
1/8 - 27 NPT	1/8 - 27 NPT

Hex Dies

1/4 - 20 NC	3 x .50 taper
1/4 - 28 NF	3 x .60 taper
5/16 - 18 NC	4 x .70 taper
5/16 - 24 NF	4 x .75 taper
3/8 - 16 NC	5 x .80 taper
3/8 - 24 NF	5 x .90 taper
7/16 -14 NC	6 x 1.00 taper
7/16 - 20 NF	7 x 1.00 taper
1/2 -13 NC	8 x 1.25 plug
1/2 - 20 NF	9 x 1.00 plug
4 - 40 taper	9 x 1.25 plug
6 - 32 taper	10 x 1.25 plug
8 - 32 taper	10 x 1.50 plug
10 - 24 taper	11 x 1.50 plug
10 - 32 taper	12 x 1.50 plug
12 - 24 taper	12 x 1.75 plug
1/8 - 27 NPT	1/8 - 28BSP



PATENTED

82805D - 2 Pc. Ratcheting Tap and Die 3/8" Drive Extension Adapter Set

Material No.	Description
82803	Male Extension Adapter - 3/8" Drive
82804	Female Extension Adapter - 3/8" Drive

SPECIALTY & GENERAL PURPOSE TOOLS

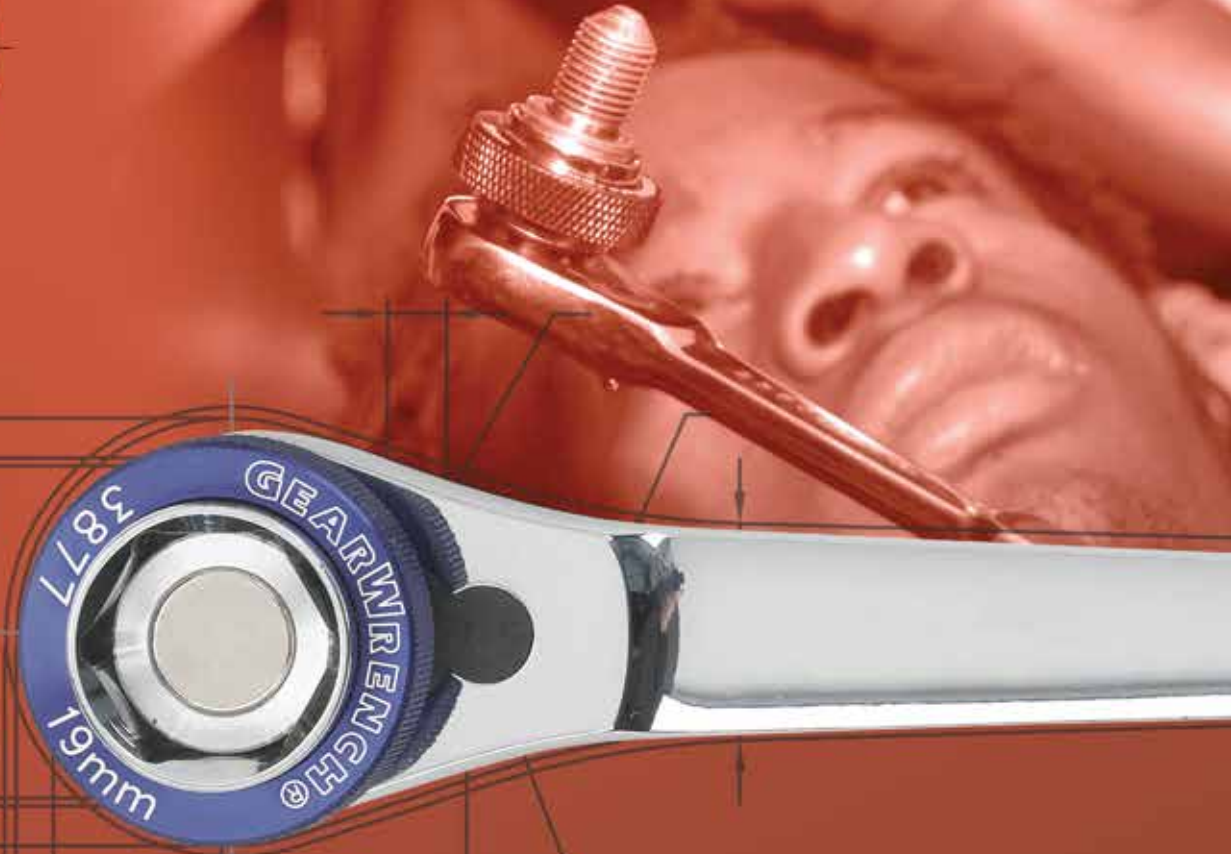
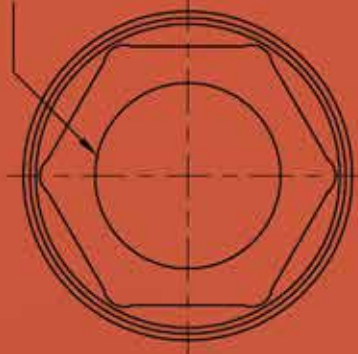

Specialty Tools

Oil Drain Plug Sockets

General Purpose Tools

Flashlight
Gloves
Snips
Files

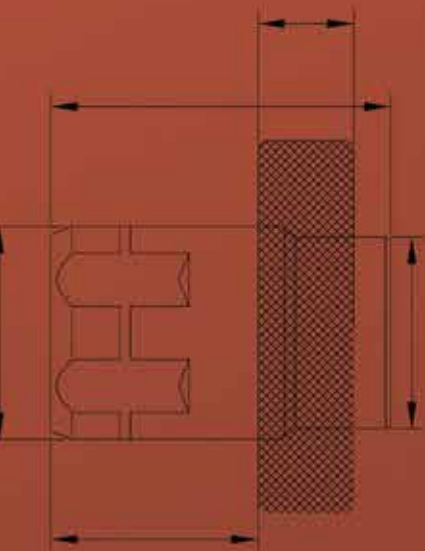

**OIL DRAIN
PLUG SOCKETS**

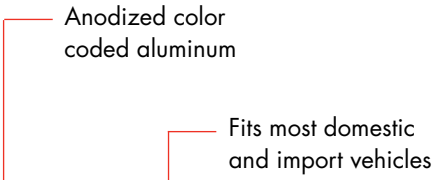
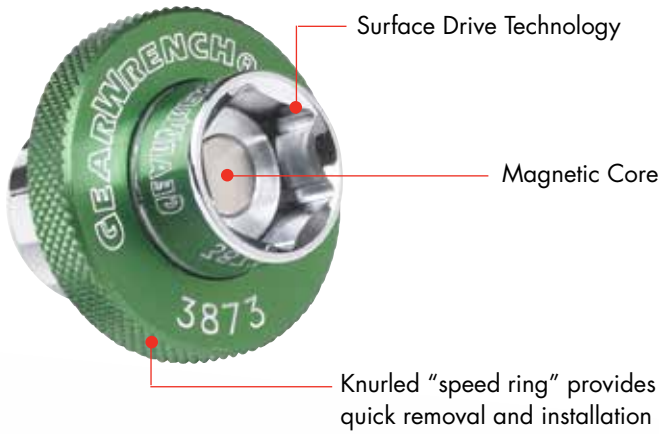

Can be used with Pass-Thru® Ratchets Featuring GearRatchet™ handles, or standard 3/8" Drive ratchets

SPECIALTY & GENERAL



Products are covered by one or more of the following patents:

- US 7,159,491
- US 7,658,132

SPECIALTY & GENERAL TOOLS

3870D - 7 Pc. Magnetic Oil Drain Plug Socket Set

Material No.	Description
235080GR	3/8" GearRatchet® Handle
3872	13 mm Magnetic Oil Drain Plug Socket
3873	14 mm Magnetic Oil Drain Plug Socket
3874	15 mm Magnetic Oil Drain Plug Socket
3875	16 mm Magnetic Oil Drain Plug Socket
3876	17 mm Magnetic Oil Drain Plug Socket
3877	19 mm Magnetic Oil Drain Plug Socket



83077 - 3 Pc. Aviation Snip Set

Description

Straight cutting aviation snip
Right cutting aviation snip
Left cutting aviation snip
EVA Tray Included: 161mm x 360mm



Fits drawer type **B** as shown on page 34.

83078 - 4 Pc. File Set

Description

File (Flat): 203mm/8"
File (Round): 203mm/8"
File (Half round): 203mm/8"
File (Triangle): 203mm/8"
EVA Tray Included: 161mm x 360mm



Fits drawer type **B** as shown on page 34.

83132 - Flashlight Aluminium

- Aluminium body with rubber grip.
- Five LED bulbs above 13000 mcd, white light.
- Weatherproof.
- Rubber ring around head of flashlight.
- Includes carry case.



86990 - Mechanics Gloves



86991 - Fender Cover

- Magnetic
- Oil Resistant
- Measure 876mm/34½"W x 470mm/18½"L



SETS
SPECIALTY & GENERAL

Material No.	Description	Page No.	Barcode Prefix	
			■ 082171	● 099575 ▲ 09337103
132120GR	3/8"Dr Vortex Socket 3/8"	97	■	991134
132140GR	3/8"Dr Vortex Socket 7/16"	97	■	991141
132160GR	3/8"Dr Vortex Socket 1/2"	97	■	991158
132180GR	3/8"Dr Vortex Socket 9/16"	97	■	991165
132200GR	3/8"Dr Vortex Socket 5/8"	97	■	322006
132220GR	3/8"Dr Vortex Socket 11/16"	97	■	322204
132240GR	3/8"Dr Vortex Socket 3/4"	97	■	322402
132260GR	3/8"Dr Vortex Socket 13/16"	97	■	132261
132280GR	3/8"Dr Vortex Socket 7/8"	97	■	132285
231062GR	3/8"Dr 3/8"Squ Pass-Thru QR Adapter	97	■	236211
3870D	7 pc. Magnetic Oil Drain Plug Socket Set	193	■	387050
3885	40pc SAE Tap & Die Set	189	■	388514
3886	40pc Metric Tap & Die Set	188	■	388620
3887	75pc Medium Ratcheting Tap & Die Tool Set SAE/Metric	190	■	388736
532100GR	3/8" Vortex Socket 10mm	97	■	321009
532110GR	3/8" Vortex Socket 11mm	97	■	321108
532120GR	3/8" Vortex Socket 12mm	97	■	321207
532130GR	3/8" Vortex Socket 13mm	97	■	321306
532140GR	3/8" Vortex Socket 14mm	97	■	321405
532150GR	3/8" Vortex Socket 15mm	97	■	321504
532160GR	3/8" Vortex Socket 16mm	97	■	321603
532170GR	3/8" Vortex Socket 17mm	97	■	321702
532180GR	3/8" Vortex Socket 18mm	97	■	321801
532190GR	3/8" Vortex Socket 19mm	97	■	321900
80050	6Pc. Combination Screwdriver Set	168	●	800504
80051	12Pc. Combination Screwdriver Set	169	●	800511
80055	6Pc. Mini Screwdriver Set	171	●	800559
80058	8Pc. Mini Screwdriver & Pliers Set	177	●	800580
80059	4Pc. Long Screwdriver Set	168	●	800597
80060	10Pc. Combination & Positive Screwdriver Set	168	●	800603
80066	20Pc. Master Screwdriver Set	169	●	800665
80072	2Pc. Screwdriver Set Offset Phillips	171	●	800726
80100	1/4"Dr Universal Joint	70	●	801006
80104D	1/4"Dr 6pt Standard Socket 5/32"	71	●	801044
80105	1/4"Dr 6pt Standard SAE Socket 3/16"	71	●	801051
80106	1/4"Dr 6pt Standard SAE Socket 7/32"	71	●	810060
80107	1/4"Dr 6pt Standard SAE Socket 1/4"	71	●	801075
80108	1/4"Dr 6pt Standard SAE Socket 9/32"	71	●	801082
80109	1/4"Dr 6pt Standard SAE Socket 5/16"	71	●	801099
80110	1/4"Dr 6pt Standard SAE Socket 11/32"	71	●	801105
80111	1/4"Dr 6pt Standard SAE Socket 3/8"	71	●	801112
80112	1/4"Dr 6pt Standard SAE Socket 7/16"	71	●	801129
80113D	1/4"Dr 6pt Standard SAE Socket 1/2"	71	●	801136
80114D	1/4"Dr 6pt Standard SAE Socket 9/16"	71	●	801143
80115	1/4"Dr 6pt Deep SAE Socket 3/16"	72	●	801150
80116D	1/4"Dr 6pt Deep SAE Socket 7/32"	72	●	801167
80117	1/4"Dr 6pt Deep SAE Socket 1/4"	72	●	801174
80118	1/4"Dr 6pt Deep SAE Socket 9/32"	72	●	801181
80119	1/4"Dr 6pt Deep SAE Socket 5/16"	72	●	801198
80120D	1/4"Dr 6pt Deep SAE Socket 11/32"	72	●	801204
80121	1/4"Dr 6pt Deep SAE Socket 3/8"	72	●	801211
80122D	1/4"Dr 6pt Deep SAE Socket 7/16"	72	●	801228
80123	1/4"Dr 6pt Deep SAE Socket 1/2"	72	●	801235
80124	1/4"Dr 6pt Deep SAE Socket 9/16"	72	●	801242
80125	1/4"Dr 6pt Standard Metric Socket 4mm	71	●	801259
80126	1/4"Dr 6pt Standard Metric Socket 5mm	71	●	801266
80127	1/4"Dr 6pt Standard Metric Socket 5.5mm	71	●	801273
80128	1/4"Dr 6pt Standard Metric Socket 6mm	71	●	801280
80129	1/4"Dr 6pt Standard Metric Socket 7mm	71	●	801297
80130	1/4"Dr 6pt Standard Metric Socket 8mm	71	●	801303
80131D	1/4"Dr 6pt Standard Metric Socket 9mm	71	●	801310
80132	1/4"Dr 6pt Standard Metric Socket 10mm	71	●	801327
80133	1/4"Dr 6pt Standard Metric Socket 11mm	71	●	801334
80134	1/4"Dr 6pt Standard Metric Socket 12mm	71	●	801341

Material No.	Description	Page No.	Barcode Prefix	
			■ 082171	● 099575 ▲ 09337103
80135D	1/4"Dr 6pt Standard Metric Socket 13mm	71	●	801358
80136	1/4"Dr 6pt Standard Metric Socket 14mm	71	●	801365
80137	1/4"Dr 6pt Standard Metric Socket 15mm	71	●	801372
80138	1/4"Dr 6pt Deep Metric Socket 4mm	72	●	801389
80139	1/4"Dr 6pt Deep Metric Socket 5mm	72	●	801396
80140	1/4"Dr 6pt Deep Metric Socket 5.5mm	72	●	801402
80141	1/4"Dr 6pt Deep Metric Socket 6mm	72	●	801419
80142	1/4"Dr 6pt Deep Metric Socket 7mm	72	●	801426
80143	1/4"Dr 6pt Deep Metric Socket 8mm	72	●	801433
80144	1/4"Dr 6pt Deep Metric Socket 9mm	72	●	801440
80145	1/4"Dr 6pt Deep Metric Socket 10mm	72	●	801457
80146D	1/4"Dr 6pt Deep Metric Socket 11mm	72	●	801464
80147	1/4"Dr 6pt Deep Metric Socket 12mm	72	●	811470
80148	1/4"Dr 6pt Deep Metric Socket 13mm	72	●	801488
80149	1/4"Dr 6pt Deep Metric Socket 14mm	72	●	801495
80150	1/4"Dr 6pt Deep Metric Socket 15mm	72	●	801501
80300	51pc 1/4"Dr 6pt Socket Set	63	●	803000
80301	51pc 1/4"Dr 12pt Socket Set	64	●	803017
80302	13pc 1/4"Dr 6pt Standard Metric Socket	66	●	803024
80303	10pc 1/4"Dr 6pt Standard SAE Socket Set	66	●	803031
80304	13pc 1/4"Dr 6pt Deep Metric Socket Set	66	●	803048
80305	10pc 1/4"Dr 6pt Deep SAE Socket Set	66	●	803055
80306	13pc 1/4"Dr 12pt Standard Metric Socket Set	67	●	803062
80307D	10pc 1/4"Dr 12pt Standard SAE Socket Set	67	●	803079
80310D	SET SKT Flex SAE 1/4Dr 6PT 7PC	67	●	803109
80311	SET SKT Flex MET 1/4Dr 6PT 12PC	67	●	803116
80322	6pc 1/4"Dr Deep E Socket Set	101	●	803222
80325	22pc 1/4"Dr SAE Socket Set	65	●	803253
80327	22pc 1/4"Dr Metric Socket Set	64	●	803277
80363	3/8"Dr 6pt Deep SAE Socket 1/4"	82	●	803635
80364	3/8"Dr 6pt Deep SAE Socket 5/16"	82	●	803642
80365	3/8"Dr 6pt Deep SAE Socket 3/8"	82	●	803659
80366	3/8"Dr 6pt Deep SAE Socket 7/16"	82	●	803666
80367	3/8"Dr 6pt Deep SAE Socket 1/2"	82	●	803673
80368	3/8"Dr 6pt Deep SAE Socket 9/16"	82	●	803680
80369	3/8"Dr 6pt Deep SAE Socket 5/8"	82	●	803697
80370D	3/8"Dr 6pt Deep SAE Socket 11/16"	82	●	803703
80371	3/8"Dr 6pt Deep SAE Socket 3/4"	82	●	803710
80372	3/8"Dr 6pt Deep SAE Socket 13/16"	82	●	803727
80373	3/8"Dr 6pt Deep SAE Socket 7/8"	82	●	803734
80388	3/8"Dr 6pt Deep Metric Socket 6mm	82	●	803888
80389	3/8"Dr 6pt Deep Metric Socket 7mm	82	●	803895
80390	3/8"Dr 6pt Deep Metric Socket 8mm	82	●	803901
80391	3/8"Dr 6pt Deep Metric Socket 9mm	82	●	803918
80392	3/8"Dr 6pt Deep Metric Socket 10mm	82	●	803925
80393D	3/8"Dr 6pt Deep Metric Socket 11mm	82	●	803932
80394D	3/8"Dr 6pt Deep Metric Socket 12mm	82	●	803949
80395	3/8"Dr 6pt Deep Metric Socket 13mm	82	●	803956
80396	3/8"Dr 6pt Deep Metric Socket 14mm	82	●	803963
80397	3/8"Dr 6pt Deep Metric Socket 15mm	82	●	803970
80398	3/8"Dr 6pt Deep Metric Socket 16mm	82	●	803987
80399	3/8"Dr 6pt Deep Metric Socket 17mm	82	●	803994
80400	3/8"Dr 6pt Deep Metric Socket 18mm	82	●	804007
80401	3/8"Dr 6pt Deep Metric Socket 19mm	82	●	804014
80402	3/8"Dr Spark Plug Socket 5/8"	80	●	804021
80403	3/8"Dr Spark Plug Socket 13/16"	80	●	804038
80406	3/8"Dr 6pt Deep Metric Socket 20mm	82	●	804069
80407	3/8"Dr 6pt Deep Metric Socket 21mm	82	●	804076
80408	3/8"Dr 6pt Deep Metric Socket 22mm	82	●	804083
80409	3/8"Dr 6pt Deep Metric Socket 24mm	82	●	804090
80441	Socket Hex Bit Long Ball 3/8Dr. 3mm	102	●	804410
80442	Socket Hex Bit Long Ball 3/8Dr. 4mm	102	●	804427
80443	Socket Hex Bit Long Ball 3/8Dr. 5mm	102	●	804434
80444	Socket Hex Bit Long Ball 3/8Dr. 6mm	102	●	804441
80445	Socket Hex Bit Long Ball 3/8Dr. 7mm	102	●	804458

Material No.	Description	Page No.	Barcode Prefix	
			■ 082171	● 099575
80446	Socket Hex Bit Long Ball 3/8Dr. 8mm	102	●	804465
80447	Socket Hex Bit Long Ball 3/8Dr. 9mm	102	●	804472
80448	Socket Hex Bit Long Ball 3/8Dr. 10mm	102	●	804489
80482	3/8"Dr 12pt Standard Metric Socket 6mm	81	●	804823
80483	3/8"Dr 12pt Standard Metric Socket 7mm	81	●	804830
80484	3/8"Dr 12pt Standard Metric Socket 8mm	81	●	804847
80485	3/8"Dr 12pt Standard Metric Socket 9mm	81	●	804854
80486	3/8"Dr 12pt Standard Metric Socket 10mm	81	●	804861
80487	3/8"Dr 12pt Standard Metric Socket 11mm	81	●	804878
80488	3/8"Dr 12pt Standard Metric Socket 12mm	81	●	804885
80489	3/8"Dr 12pt Standard Metric Socket 13mm	81	●	804892
80490	3/8"Dr 12pt Standard Metric Socket 14mm	81	●	804908
80491	3/8"Dr 12pt Standard Metric Socket 15mm	81	●	804915
80492	3/8"Dr 12pt Standard Metric Socket 16mm	81	●	804922
80493	3/8"Dr 12pt Standard Metric Socket 17mm	81	●	804939
80494	3/8"Dr 12pt Standard Metric Socket 18mm	81	●	804946
80495	3/8"Dr 12pt Standard Metric Socket 19mm	81	●	804953
80496	3/8"Dr 12pt Standard SAE Socket 1/4"	81	●	804960
80497D	3/8"Dr 12pt Standard SAE Socket 5/16"	81	●	804977
80498	3/8"Dr 12pt Standard SAE Socket 3/8"	81	●	804984
80499	3/8"Dr 12pt Standard SAE Socket 7/16"	81	●	804991
80500D	3/8"Dr 12pt Standard SAE Socket 1/2"	81	●	805004
80501	3/8"Dr 12pt Standard SAE Socket 9/16"	81	●	805011
80502	3/8"Dr 12pt Standard SAE Socket 5/8"	81	●	805028
80503	3/8"Dr 12pt Standard SAE Socket 11/16"	81	●	805035
80504	3/8"Dr 12pt Standard SAE Socket 3/4"	81	●	805042
80505	3/8"Dr 12pt Standard SAE Socket 13/16"	81	●	805059
80506D	3/8"Dr 12pt Standard SAE Socket 7/8"	81	●	805066
80507	3/8"Dr 12pt Standard SAE Socket 15/16"	81	●	805073
80508	3/8"Dr 12pt Standard SAE Socket 1"	81	●	805080
80549	3/8"Dr Universal Joint	79	●	805493
80550	57pc 3/8"Dr 6pt Socket Set	73	●	805509
80551	57pc 3/8"Dr 12pt Socket Set	74	●	805516
80554	14pc 3/8"Dr 6pt Deep Metric Socket Set	75	●	805547
80555	11pc 3/8"Dr 6pt Deep SAE Socket Set	77	●	805554
80557	21pc 3/8"Dr SAE Socket Set	75	●	805578
80559	24pc 3/8"Dr Metric Socket Set	75	●	805592
80560	14pc 3/8"Dr 12pt Standard Metric Socket Set	76	●	805608
80561	13pc 3/8"Dr SAE 12pt Socket Set	74	●	805615
80564	SET SKT Flex SAE 3/8Dr 6PT 7PC	77	●	805646
80565	SET SKT Flex Socket Metric 3/8Dr 6PT 10PC	77	●	805653
80573	8pc 3/8Dr Socket Metric Ball Hex Bit Socket Set-Long	102	●	805738
80574	7pc 3/8"Dr SAE Ball Hex Bit Socket Set-Long	102	●	805745
80578	10pc 3/8"&1/2"Dr Socket Metric Hex Bit Socket Set	100	●	805783
80580	12pc 3/8"Dr Metric Hex Bit Socket Set	101	●	805806
80581	12pc 3/8"Dr SAE Hex Bit Socket Set	101	●	805813
80588	10pc Long Torx Set T8-T50	100	●	805882
80592	3/8"Dr 6pt Deep SAE Socket 15/16"	82	●	805929
80593	3/8"Dr 6pt Deep SAE Socket 1"	82	●	805936
80596	3/8"Dr 12pt Standard Metric Socket 20mm	81	●	805967
80597	3/8"Dr 12pt Standard Metric Socket 21mm	81	●	805974
80598	3/8"Dr 12pt Standard Metric Socket 22mm	81	●	805981
80600D	1/2"Dr Universal Joint	87	●	806001
80671	1/2"Dr Impact Universal Joint	107	●	806711
80680	1/2"Dr 12pt Standard SAE Socket 1-1/2"	90	●	806803
80681	1/2"Dr 12pt Standard Metric Socket 26mm	89	●	806810
80682	1/2"Dr 12pt Standard Metric Socket 28mm	89	●	806827
80683	1/2"Dr 12pt Standard Metric Socket 29mm	89	●	806834
80687	1/2"Dr 12pt Deep SAE Socket 1-1/2"	91	●	806872
80701	49pc 1/2"Dr 12pt Socket Set	83	●	807015
80704	10pc 1/2"Dr 6pt Deep Metric Socket Set	85	●	807046
80705	8pc 1/2"Dr 6pt Deep SAE Socket Set	85	●	807053
80707	23pc 1/2"Dr SAE Socket Set	84	●	807077
80709	28pc 1/2"Dr Metric Socket Set	84	●	807091

Material No.	Description	Page No.	Barcode Prefix	
			■ 082171	● 099575
80710D	13pc 1/2"Dr 12pt Standard Metric Socket Set	85	●	807107
80711	11pc 1/2"Dr 12pt Standard SAE Socket Set	85	●	807114
80712	10pc 1/2"Dr Deep Metric Socket Set	85	●	807121
80723	13pc Torx Press Fit (2pc) Bit Socket Set	100	●	807237
80745	1/2"Dr 12pt Standard Metric Socket 10mm	89	●	807459
80746	1/2"Dr 12pt Standard Metric Socket 11mm	89	●	807466
80747	1/2"Dr 12pt Standard Metric Socket 12mm	89	●	807473
80748D	1/2"Dr 12pt Standard Metric Socket 13mm	89	●	807480
80749	1/2"Dr 12pt Standard Metric Socket 14mm	89	●	807497
80750	1/2"Dr 12pt Standard Metric Socket 15mm	89	●	807503
80751	1/2"Dr 12pt Standard Metric Socket 16mm	89	●	807510
80752	1/2"Dr 12pt Standard Metric Socket 17mm	89	●	807527
80753	1/2"Dr 12pt Standard Metric Socket 18mm	89	●	807534
80754	1/2"Dr 12pt Standard Metric Socket 19mm	89	●	807541
80755D	1/2"Dr 12pt Standard Metric Socket 20mm	89	●	807558
80756	1/2"Dr 12pt Standard Metric Socket 21mm	89	●	807565
80757	1/2"Dr 12pt Standard Metric Socket 22mm	89	●	807572
80758	1/2"Dr 12pt Standard Metric Socket 23mm	89	●	807589
80759	1/2"Dr 12pt Standard Metric Socket 24mm	89	●	807596
80760	1/2"Dr 12pt Standard SAE Socket 7/16"	90	●	807602
80761	1/2"Dr 12pt Standard SAE Socket 1/2"	90	●	807619
80762	1/2"Dr 12pt Standard SAE Socket 9/16"	90	●	807626
80763	1/2"Dr 12pt Standard SAE Socket 5/8"	90	●	807633
80764	1/2"Dr 12pt Standard SAE Socket 11/16"	90	●	807640
80765	1/2"Dr 12pt Standard SAE Socket 3/4"	90	●	807657
80766	1/2"Dr 12pt Standard SAE Socket 13/16"	90	●	807664
80767	1/2"Dr 12pt Standard SAE Socket 7/8"	90	●	807671
80768	1/2"Dr 12pt Standard SAE Socket 15/16"	90	●	807688
80769	1/2"Dr 12pt Standard SAE Socket 1"	90	●	807695
80770	1/2"Dr 12pt Standard SAE Socket 1-1/16"	90	●	807701
80771	1/2"Dr 12pt Standard SAE Socket 1-1/8"	90	●	807718
80772	1/2"Dr 12pt Deep SAE Socket 7/16"	91	●	807725
80773	1/2"Dr 12pt Deep SAE Socket 1/2"	91	●	807732
80774	1/2"Dr 12pt Deep SAE Socket 9/16"	91	●	807749
80775	1/2"Dr 12pt Deep SAE Socket 5/8"	91	●	807756
80776	1/2"Dr 12pt Deep SAE Socket 11/16"	91	●	807763
80777D	1/2"Dr 12pt Deep SAE Socket 3/4"	91	●	807770
80778	1/2"Dr 12pt Deep SAE Socket 13/16"	91	●	807787
80779	1/2"Dr 12pt Deep SAE Socket 7/8"	91	●	807794
80780	1/2"Dr 12pt Deep SAE Socket 15/16"	91	●	807800
80781	1/2"Dr 12pt Deep Metric Socket 10mm	89	●	807817
80782	1/2"Dr 12pt Deep Metric Socket 11mm	91	●	807824
80783	1/2"Dr 12pt Deep Metric Socket 12mm	91	●	807831
80784	1/2"Dr 12pt Deep Metric Socket 13mm	91	●	807848
80785	1/2"Dr 12pt Deep Metric Socket 14mm	91	●	807855
80786	1/2"Dr 12pt Deep Metric Socket 15mm	91	●	807862
80787	1/2"Dr 12pt Deep Metric Socket 16mm	91	●	807879
80788	1/2"Dr 12pt Deep Metric Socket 17mm	91	●	807886
80789	1/2"Dr 12pt Deep Metric Socket 18mm	91	●	807893
80790	1/2"Dr 12pt Deep Metric Socket 19mm	91	●	807909
80793	1/2"Dr 12pt Standard Socket 1-3/16"	90	●	807930
80794	1/2"Dr 12pt Standard Socket 1-1/4"	90	●	807947
80795	1/2"Dr 12pt Deep Socket 1"	91	●	807954
80796	1/2"Dr 12pt Deep Socket 1-1/16"	91	●	807961
80797	1/2"Dr 12pt Deep Socket 1-1/8"	91	●	807978
80798	1/2"Dr 12pt Deep Socket 1-1/4"	91	●	807985
80805	1/2"Dr 12pt Standard Socket 8mm	89	●	808050
80806	1/2"Dr 12pt Standard Socket 9mm	89	●	808067
80811	1/2"Dr 12pt Standard Socket 25mm	89	●	808111
80812	1/2"Dr 12pt Standard Socket 27mm	89	●	808128
80813	1/2"Dr 12pt Standard Socket 30mm	89	●	808135
80814D	1/2"Dr 12pt Standard Socket 32mm	89	●	808142
80815D	1/2"Dr 12pt Standard Socket 36mm	89	●	808159
80817D	1/2"Dr 12pt Deep Metric Socket 20mm	91	●	808173
80818	1/2"Dr 12pt Deep Metric Socket 21mm	91	●	808180

Material No.	Description	Page No.	Barcode Prefix	
			■ 082171 ● 099575 ▲ 09337103	
80820	1/2"Dr 12pt Deep Metric Socket 22mm	91	●	808203
80822	1/2"Dr 12pt Deep Metric Socket 24mm	91	●	808227
80824	1/2"Dr 12pt Deep Metric Socket 27mm	91	●	808241
80826	1/2"Dr 12pt Deep Metric Socket 30mm	91	●	808265
80827	1/2"Dr 12pt Deep Metric Socket 32mm	91	●	808272
80830	3/4"Dr 12pt Standard Socket 7/8"	94	●	808302
80831	3/4"Dr 12pt Standard Socket 15/16"	94	●	808319
80833	3/4"Dr 12pt Standard Socket 1"	94	●	808333
80834	3/4"Dr 12pt Standard Socket 1-1/16"	94	●	808340
80835D	3/4"Dr 12pt Standard Socket 1-1/8"	94	●	808357
80838	3/4"Dr 12pt Standard Socket 1-3/16"	94	●	808388
80839	3/4"Dr 12pt Standard Socket 1-1/4"	94	●	808395
80840	3/4"Dr 12pt Standard Socket 1-5/16"	94	●	808401
80841	3/4"Dr 12pt Standard Socket 1-3/8"	94	●	808418
80852	3/4"Dr 12pt Standard Socket 1-7/16"	94	●	808524
80854	3/4"Dr 12pt Standard Socket 1-1/2"	94	●	808548
80855D	3/4"Dr 12pt Standard Socket 1-5/8"	94	●	808555
80856	3/4"Dr 12pt Standard Socket 1-11/16"	94	●	808562
80857	3/4"Dr 12pt Standard Socket 1-3/4"	94	●	808579
80859	3/4"Dr 12pt Standard Socket 1-13/16"	94	●	808593
80860	3/4"Dr 12pt Standard Socket 1-7/8"	94	●	808609
80861	3/4"Dr 12pt Standard Socket 2"	94	●	808616
80862	3/4"Dr 12pt Standard Socket 2-1/8"	94	●	808623
80863	3/4"Dr 12pt Standard Socket 2-3/16"	94	●	808630
80864	3/4"Dr 12pt Standard Socket 2-1/4"	94	●	808647
80865	3/4"Dr 12pt Standard Socket 2-3/8"	94	●	808654
80879	13pc 3/4"Dr SAE 12pt Standard Socket Set	92	●	808791
80880	27pc 3/4"Dr SAE 12pt Standard Socket Set	92	●	808807
80930	88pc 1/4&3/8"Dr ópt&12pt Socket SAE/Metric	59	●	809309
80931	141pc 1/4&3/8&1/2"Drópt&12pt Socket SAE/Metric	55 - 56	●	809316
80932	165pc 1/4&3/8&1/2"Drópt&12pt Socket SAE/Metric	53 - 54	●	809323
80933	216pc 1/4&3/8&1/2"Drópt&13pt Socket SAE/Metric	50 - 52	●	809330
80934	239pc 1/4 &3/8&1/2"Dr ópt & 13pt Scats SAE/Metric	47 - 49	●	809347
81007	1/4"Dr Ratchet w/Cushion Grip	68	●	810077
81008	1/4"Dr Thumbwheel Ratchet	69	●	810084
81009F	1/4"Dr Flex Ratchet w/Cushion Grip	68	●	810091
81011F	1/4"Dr Full Polish Teardrop Ratchet	68	●	810114
81011P	RAT Teardrop 1/4Dr FP 120XP	68	●	810176
81012D	1/4"Dr Full Polish Flex Ratchet Handle	68	●	810121
81012P	RAT Flex Teardrop 1/4" 120XP FP	68	●	80128
81013	1/4"Dr Flex Handle 5-1/2"	70	●	810138
81014	1/4"Dr Quick-Release Ratchet Handle-L5	68	●	810145
81099	1/4"DrRatchet Repair Kit	70	●	810992
81101	1/4"Dr Extension 2"	70	●	811012
81116	1/4"Dr Extension 6"	70	●	811166
81117D	1/4"Dr Extension 10"	70	●	811173
81118	1/4"Dr Extension 14"	70	●	811180
81119	1/4"Dr Wobble Extension 2"	70	●	811197
81121	1/4"Dr Wobble Extension 6"	70	●	811210
81126	1/4"Dr Locking Extension 6"	70	●	811265
81127	1/4"fx 3/8"m Dr. Adapter	70	●	811272
81128	1/4"Dr Spinner Handle	69	●	811289
81202	3pc 3/8"Dr Locking Extension Set	80	●	812026
81205	10pc Universal and Adapter Set	62	●	812057
81206P	SET RAT MIXED 3PC FP 1/4,3/8,1/2, 120XP	62	●	816024
81208F	3/8"Dr Ratchet w/Cushion Grip	78	●	812088
81209F	3/8"Dr Stubby Ratchet	78	●	812095
81210	3/8"Dr Flex Ratchet w/Cushion Grip	79	●	812101
81211F	3/8"Dr Full Polish Teardrop Ratchet	78	●	812118
81211P	Ratchet Teardrop 3/8Dr FP 120XP	78	●	822223
81212	3/8"Dr Stubby Flex Ratchet - FP	78	●	812125

Material No.	Description	Page No.	Barcode Prefix	
			■ 082171 ● 099575 ▲ 09337103	
81213F	3/8"Dr Offset Flex Ratchet - CG	78	●	812132
81215	3/8"Dr Full Polish Flex Ratchet Handle	78	●	812156
81215P	Ratchet Flex Teardrop 3/8" 120XP FP	78	●	812150
81217	4pc Adapter Set	62	●	812170
81218	3/8"Dr Quick-Release Ratchet Handle-L5	78	●	812187
81221	3/8"DrFlex FP Handle 12"	79	●	812217
81222	2pc Ratchet Finger 1/4" x 3/8"	62	●	812224
81224	1/4"Dr Roto Ratchet Set	69	●	812248
81225	3/8"Dr Roto Ratchet Set	78	●	812255
81226	3/8" Thumbwheel Ratchet	79	●	812262
81227	3/8"Dr Ratchet Repair Kit	79	●	812279
81232	1/4"Dr Springing Universal Joint	70	●	812323
81233	3/8"Dr Springing Universal Joint	79	●	812330
81234	1/2"Dr Springing Universal Joint	88	●	812347
81239	3/8"Dr Speeder Handle 16"	80	●	812392
81240	3/8"Dr Extension 1-1/2"	80	●	812408
81241	3/8"Dr Extension 3"	80	●	812415
81242	3/8"Dr Extension 6"	80	●	812422
81243	3/8"Dr Extension 10"	80	●	812439
81244	3/8"Dr Extension 12"	80	●	812446
81246	3/8"Dr Wobble Extension 3"	80	●	812460
81247	3/8"Dr Wobble Extension 6"	80	●	812477
81248	3/8"Dr Wobble Extension 10"	80	●	812484
81249	3/8"Dr Wobble Extension 12"	80	●	812491
81277	3/8"fx1/4"m Dr. Adapter	80	●	812774
81278	3/8"fx1/2"m Dr. Adapter	80	●	812781
81302	3pc 1/2"Dr Locking Extension Set	88	●	813023
81303F	1/2"Dr Ratchet w/Cushion Grip	86	●	813030
81304F	1/2"Dr Full Polish Teardrop Ratchet	86	●	813047
81304P	RAT Teardrop 1/2Dr FP 120XP	86	●	830402
81306F	1/2"Dr Full Polish Flex Ratchet Handle	86	●	813061
81306P	RAT Flex Teardrop 1/2" 120XP FP	86	●	003066
81307	1/2"Dr Flex Handle 15"	87	●	813078
81308D	1/2"Dr Flex Handle 24"	87	●	813085
81309	1/2"Dr Quick-Release Ratchet Handle L5	86	●	813092
81311	1/2"Dr Sliding T Handle 15"	87	●	813115
81312	1/2"DrSpeeder Handle 16"	87	●	813122
81339	1/2"DrRatchet Repair Kit	87	●	813399
81340	1/2"Dr Extension 3"	88	●	813405
81341	1/2"Dr Extension 5"	88	●	813412
81342	1/2"Dr Extension 10"	88	●	813429
81343	1/2"Dr Extension 15"	88	●	813436
81344	1/2"Dr Wobble Extension 3"	88	●	813443
81345	1/2"Dr Wobble Extension 5"	88	●	813450
81346	1/2"Dr Wobble Extension 10"	88	●	813467
81347	1/2"Dr Wobble Extension 15"	88	●	813474
81354	1/2"fx3/8"m Dr. Adapter	88	●	813542
81355	1/2"fx3/4"m Dr. Adapter	88	●	813559
81400	3/4"Dr Teardrop Ratchet 19-3/4"	93	●	814006
81401	3/4"Dr Sliding T Handle 18"	93	●	814013
81404	3/4"Dr Flex Handle 19"	93	●	814044
81411	3/4"Dr Extension 5"	93	●	814112
81412	3/4"Dr Extension 8"	93	●	814129
81413	3/4"Dr Extension 16"	93	●	814136
81499	Ratchet Repair Kit 3/4" Drive	93	●	814990
81650	XL Combination Wrench 1/4"	149	●	816505
81651D	XL Combination Wrench 9/32"	151	●	816512
81652D	XL Combination Wrench 5/16"	151	●	816529
81653	XL Combination Wrench 11/32"	151	●	816536
81654	XL Combination Wrench 3/8"	151	●	816543
81655	XL Combination Wrench 7/16"	151	●	816550
81656	XL Combination Wrench 1/2"	151	●	816567
81657	XL Combination Wrench 9/16"	151	●	816574
81658	XL Combination Wrench 5/8"	151	●	816581
81659	XL Combination Wrench 11/16"	151	●	816598

Material No.	Description	Page No.	Barcode Prefix	
			■ 082171	● 099575
81660	XL Combination Wrench 3/4"	151	●	816604
81661	XL Combination Wrench 13/16"	151	●	816611
81662	XL Combination Wrench 7/8"	151	●	816628
81663	XL Combination Wrench 15/16"	151	●	816635
81664	XL Combination Wrench 1"	151	●	816642
81665	XL Combination Wrench 8mm	151	●	816659
81666	XL Combination Wrench 9mm	151	●	816666
81667	XL Combination Wrench 10mm	151	●	816673
81668	XL Combination Wrench 11mm	151	●	816680
81669	XL Combination Wrench 12mm	151	●	816697
81670	XL Combination Wrench 13mm	151	●	816703
81671	XL Combination Wrench 14mm	151	●	816710
81672	XL Combination Wrench 15mm	151	●	816727
81673	XL Combination Wrench 16mm	151	●	816734
81674	XL Combination Wrench 17mm	151	●	816741
81675	XL Combination Wrench 18mm	151	●	816758
81676	XL Combination Wrench 19mm	151	●	816765
81677	XL Combination Wrench 20mm	151	●	816772
81678	XL Combination Wrench 21mm	151	●	816789
81679	XL Combination Wrench 22mm	151	●	816796
81733	XL Combination Wrench 1-1/16"	151	●	817335
81734	XL Combination Wrench 1-1/8"	151	●	817342
81735	XL Combination Wrench 1-1/4"	151	●	817359
81736	XL Combination Wrench 6mm	151	●	817366
81737	XL Combination Wrench 7mm	151	●	817373
81741	XL Combination Wrench 23mm	151	●	817410
81742	XL Combination Wrench 24mm	151	●	817427
81743	XL Combination Wrench 27mm	151	●	817434
81744	XL Combination Wrench 30mm	151	●	817441
81745D	XL Combination Wrench 32mm	151	●	817458
81749	XL Combination Wrench 1-5/16"	151	●	817496
81750	XL Combination Wrench 1-1/2"	151	●	817502
81751	XL Combination Wrench 25mm	151	●	817519
81752	XL Combination Wrench 26mm	151	●	817526
81753	XL Combination Wrench 28mm	151	●	817533
81782	Deep Offset Double Box cw 8x10mm	156	●	817823
81783	Deep Offset Double Box cw 10x12mm	156	●	817830
81784	Deep Offset Double Box cw 11x13mm	156	●	817847
81785	Deep Offset Double Box cw 12x14mm	156	●	817854
81786	Deep Offset Double Box cw 17x19mm	156	●	817861
81787	Deep Offset Double Box cw 3/8"x7/16"	156	●	817878
81788	Deep Offset Double Box cw 1/2"x9/16"	156	●	817885
81789	Deep Offset Double Box cw 11/16"x3/4"	156	●	817892
81790	Deep Offset Double Box cw 13/16"x7/8"	156	●	817908
81791	Deep Offset Double Box cw 15/16"x1"	156	●	817915
81792	Double Open End Full Polish 6mm x 7mm	157	●	817922
81793	Double Open End Full Polish 8mm x 10mm	157	●	817939
81794D	Double Open End Full Polish 10mm x 12mm	157	●	817946
81795	Double Open End Full Polish 11mm x 13mm	157	●	817953
81796	Double Open End Full Polish 12mm x 14mm	157	●	817960
81797	Double Open End Full Polish 17mm x 19mm	157	●	817977
81798	Double Open End Full Polish 1/4" x 5/16"	157	●	817984
81799	Double Open End Full Polish 3/8"x7/16"	157	●	817991
81801	Double Open End Full Polish 1/2" x 9/16"	157	●	818011
81802	Double Open End Full Polish 5/8" x 11/16"	157	●	818028
81803	Double Open End Full Polish 13/16" x 3/4"	157	●	818035
81804	Double Open End Full Polish 15/16" x 1"	157	●	818042
81805	Double Open End Full Polish 1-1/8" x 1-1/4"	157	●	818059
81891	8"Adjustable Wrench w/Cushion Grip	162	●	818912
81892	10"Adjustable Wrench w/Cushion Grip	162	●	818929
81893	12"Adjustable Wrench w/Cushion Grip	162	●	818936
81900	24pc Combination Wrench Set SAE/Metric	154	●	819001
81901	15pc Combination Wrench Set SAE	153	●	819018
81902	15pc Combination Wrench Set Metric	152	●	819025
81904	10pc Stubby Wrench Set Metric	158	●	819049

Material No.	Description	Page No.	Barcode Prefix	
			■ 082171	● 099575
81905	10pc Stubby Wrench Set SAE	158	●	819056
81908	SET WR CRFT SAE 11PC	160	●	819087
81909	SET WR CRFT METRIC 10 PC	160	●	819094
81910	5pc Flex Flare Nut Wrench Set SAE	159	●	819100
81911	6pc Flex Flare Nut Wrench Set Metric	159	●	819117
81912	12pc XL XL X-Beam Combination Wrench Set Metric	161	●	819124
81913	9pc XL XL X-Beam Combination Wrench Set SAE	161	●	819131
81917	18pc XL Combination Wrench Set SAE(macor)	154	●	819179
81920	18pc XL Combo Wrench Set Metric	153	●	819209
81924	SET WR COMB FP SAE 6PT 14PC	155	●	819247
81925	SET WR COMB FP MET 6PT 14PC	155	●	819254
81926	5pc Deep Offset Box Wrench SAE	156	●	819261
81927	5pc Deep Offset Box Wrench Metric	156	●	819278
81928	6pc Open End Wrench Set Metric	157	●	819285
81929	7pc Open End Wrench Set SAE	157	●	819292
82005D	Double X Long Nose Pliers	178	●	820151
82006D	Double X Bent Nose Pliers	178	●	820168
82007	Double X Duck Bill Pliers	178	●	820175
82017	Double X Hose Grip Pliers 5/16" (8 mm)	178	●	821073
82018	Double X Hose Grip Pliers 1/2" (13 mm)	178	●	820182
82019	Double X Hose Grip Pliers 3/4" (19 mm)	178	●	820199
82032	Double X Internal Snap Ring Pliers	179	●	820328
82033	Double X External Snap Ring Pliers	179	●	820335
82034	Double X Straight Hemostat Pliers	179	●	820342
82035	Double X 45 Degree Hemostat Pliers	179	●	820359
82100	5pc Mini Pliers Set	177	●	821004
82103	4pc Standard Plier Set	177	●	821035
82106	SET PLR DBL X 2PC	178	●	821165
82108	7pc Mixed Pliers Set	177	●	821080
82208	8" INDEXING PRY BAR	182	●	822087
82210	10" INDEXING PRY BAR	182	●	822100
82216	16" INDEXING PRY BAR	182	●	822162
82220	Extendable Index Pry Bar457mm to 736mm	182	●	822209
82224	609mm/24" Index Pry Bar w/Single Joint	182	●	822247
82233	838mm/33" Index Pry Bar w/Single Joint	182	●	822339
82248	Extendable Index Pry Bar 736mm to 1219mm	182	●	822483
82300	2 Pc. Pry Bar Set	182	●	823008
82304	5Pc. Punch and Chisel Set	185	●	823046
82307	4Pc. Long Taper Punch Set	185	●	823077
82308	4Pc. Cold Chisel Set	185	●	823084
82309	5Pc. Pin Punch Set	185	●	823091
82764	7Pc. Metric Nut Teardrop Driver Set, Hollow Shaft	172	●	827648
82765	7Pc. SAE Nut Driver Set, Hollow Shaft	172	●	827655
82805D	2Pc. 3/8"Dr Ext Adapter Set	190	●	828058
83000	68Pc. 1/4"&3/8"Dr SAE/Metric Socket Set	60	●	830006
83001D	118Pc. 1/4"&3/8"&1/2"Dr cwl & Socket SAE/Metric	57-58	●	830013
83050	42 Pc. 1/4" + 3/8" Socket Set Metric + SAE	41, 61	▲	007287
83051	39 Pc. 1/4" Socket Set Metric + SAE	41, 65	▲	007294
83052	10 Pc. Wrench Set Ratcheting Metric	41, 119	▲	007300
83053	10 Pc. Wrench Set Ratcheting SAE	41, 119	▲	007317
83054	10 Pc. Wrench Set Ratcheting REV Metric	42, 123	▲	007324
83055	8 Pc. Locking FLEX Ratcheting Metric	42, 143	▲	007331
83056	10 Pc. Wrench Set Open End Ratchet Metric	42	▲	007348
83057	42 Pc. 3/8 Socket Set Metric + SAE	42, 75	▲	007355
83058	23 Pc. 1/2" Socket Set Metric	42, 84	▲	007362
83060	31 Pc. 1/4 SKT Set + 8 Non Ratcheting Wrenches	43, 65	▲	007379
83061	58 Pc. 3/8 SKT Set + 16 Ratcheting WR SAE + Metric	43	▲	007386
83062	34 Pc. 1/2 SKT Set + 11 Ratcheting REV Wrenches	43	▲	007393
83071	90 Pc. 1/4, 3/8, 1/2 Socket Set Metric + SAE	38, 61	▲	007232
83072	12 Pc. Plier Set	38, 177	▲	007249
83073	52 Pc. Screwdriver Set	39, 169	▲	007256
83074	15 Pc. Nut Driver & Hammer	39, 172	▲	007263
83075	24pce Ratcheting Wrench Set	39, 119	▲	007065

Material No.	Description	Page No.	Barcode Prefix	
			■ 082171	● 099575 ▲ 09337103
83076	3 Pc. Adjustable Wrench Set	40, 162	▲	007270
83077	3 Pc. Snip Set	40, 193	▲	007072
83078	4 Pc. File Set	40, 193	▲	007089
83090	Auto Introductory Tool Set SAE/Metric	13	●	830907
83091	Career Builder Starter Set	14 - 15	●	830914
83092	Career Builder Diesel Set	16	●	830921
83093	Career Builder Auto Body Set	16	●	830938
83094	Career Builder HVAC Add On	17	●	830945
83095	Intermediate Auto Tool Set	18 - 19	●	830952
83096	Intermediate Diesel Tool Set	20 - 21	●	830969
83097	Intermediate Auto Body SE	22 - 23	●	830976
83098	Intermediate Aviation Tool Set	24	●	830983
83101D	3/8" Dr. Slide Socket Rail	33	●	831010
83102	1/2"Dr. Slide Socket Rail	33	●	831027
83103	3pc Socket Rack Sets	33	●	831034
83104	Universal Magnetic Parts Tray -Circular	33	●	831041
83105	1/4" Dr. Slide Socket Rail	33	●	831058
83130	19" Tote Box	32	●	831300
83132	Flashlight Aluminum	193	●	831324
83140	Technicians Tool/Shoulder Bag 32 pocket	32	▲	007997
83147	16" Tool Bag	32	●	831478
83148	Plastic Tool Box	32	●	831485
83151	3 Drawer Tool Box	32	●	831515
83154	26" 4 Drawer Top Chest	29	●	831546
83155	26" 7 Drawer Roller Cabinet	29	●	831553
83156	42" 8 Drawer Top Chest	31	●	831560
83157	42" 11 Drawer Roller Cabinet	31	●	831577
83158	Cabinet Roll 9DrW 53	31	●	831584
83159	Deep Tool Chest [660 x 406 x 437]	29	▲	007102
83160	53" 8 Drawer Tool Chest	31	▲	008185
83161G	26" 7 Drawer Roller Cabinet GREEN	30	▲	008369
83161O	26" 7 Drawer Roller Cabinet ORANGE	30	▲	008376
83161R	26" 7 Drawer Roller Cabinet RED	30	▲	008383
83162G	26" 8 Drawer Top Chest GREEN	30	▲	008390
83162O	26" 8 Drawer Top Chest ORANGE	30	▲	008406
83162R	26" 8 Drawer Top Chest RED	30	▲	008413
83170	91PC Combination Tool Set	35	▲	007942
83171	189PC Combination Tool Set	36	▲	007959
83172	239PC Combination Tool Set + Trolley	37	▲	007966
84500D	1/2"Dr Impact Socket 3/8"	107	●	845000
84501	1/2"Dr Impact Socket 7/16"	107	●	845017
84502	1/2"Dr Impact Socket 1/2"	107	●	845024
84503	1/2"Dr Impact Socket 9/16"	107	●	845031
84504D	1/2"Dr Impact Socket 5/8"	107	●	845048
84505D	1/2"Dr Impact Socket 11/16"	107	●	845055
84506D	1/2"Dr Impact Socket 3/4"	107	●	845062
84507D	1/2"Dr Impact Socket 13/16"	107	●	845079
84508D	1/2"Dr Impact Socket 7/8"	107	●	845086
84509D	1/2"Dr Impact Socket 15/16"	107	●	845093
84510D	1/2"Dr Impact Socket 1"	107	●	845109
84511D	1/2"Dr Impact Socket 1-1/16"	107	●	845116
84512D	1/2"Dr Impact Socket 1-1/8"	107	●	845123
84513D	1/2"Dr Impact Socket 1-3/16"	107	●	845130
84514D	1/2"Dr Impact Socket 1-1/4"	107	●	845147
84515D	1/2"Dr Impact Socket 1-5/16"	108	●	845154
84516D	1/2"Dr Impact Socket 1-3/8"	108	●	845161
84517D	1/2"Dr Impact Socket 1-7/16"	108	●	845178
84518D	1/2"Dr Impact Socket 1-1/2"	108	●	845185
84520	1/2"Dr Impact Socket 8mm	108	●	845208
84521D	1/2"Dr Impact Socket 9mm	108	●	845215
84522D	1/2"Dr Impact Socket 10mm	108	●	845222
84523D	1/2"Dr Impact Socket 11mm	108	●	845239
84524D	1/2"Dr Impact Socket 12mm	108	●	845246
84525D	1/2"Dr Impact Socket 13mm	108	●	845253
84526D	1/2"Dr Impact Socket 14mm	108	●	845260

Material No.	Description	Page No.	Barcode Prefix	
			■ 082171	● 099575 ▲ 09337103
84527D	1/2"Dr Impact Socket 15mm	108	●	845277
84528D	1/2"Dr Impact Socket 16mm	108	●	845284
84529D	1/2"Dr Impact Socket 17mm	108	●	845291
84530D	1/2"Dr Impact Socket 18mm	108	●	845307
84531	1/2"Dr Impact Socket 19mm	108	●	845314
84532	1/2"Dr Impact Socket 20mm	108	●	845321
84533	1/2"Dr Impact Socket 21mm	108	●	845338
84534	1/2"Dr Impact Socket 22mm	108	●	845345
84535	1/2"Dr Impact Socket 23mm	108	●	845352
84536	1/2"Dr Impact Socket 24mm	108	●	845369
84537	1/2"Dr Impact Socket 25mm	108	●	845376
84538	1/2"Dr Impact Socket 26mm	108	●	845383
84539	1/2"Dr Impact Socket 28mm	108	●	845390
84540	1/2"Dr Impact Socket 29mm	108	●	845406
84541	1/2"Dr Impact Socket 30mm	108	●	845413
84542	1/2"Dr Impact Socket 31mm	108	●	845420
84543	1/2"Dr Impact Socket 32mm	108	●	845437
84544	1/2"Dr Impact Socket 36mm	108	●	845444
84546	1/2"Dr Deep Impact Socket 3/8"	110	●	845468
84547	1/2"Dr Deep Impact Socket 7/16"	110	●	845475
84548	1/2"Dr Deep Impact Socket 1/2"	110	●	845482
84549	1/2"Dr Deep Impact Socket 9/16"	110	●	845499
84550	1/2"Dr Deep Impact Socket 5/8"	110	●	845505
84551	1/2"Dr Deep Impact Socket 11/16"	110	●	845512
84552D	1/2"Dr Deep Impact Socket 3/4"	110	●	845529
84553	1/2"Dr Deep Impact Socket 13/16"	110	●	845536
84554D	1/2"Dr Deep Impact Socket 7/8"	110	●	845543
84555D	1/2"Dr Deep Impact Socket 15/16"	110	●	845550
84556	1/2"Dr Deep Impact Socket 1"	110	●	845567
84557	1/2"Dr Deep Impact Socket 1-1/16"	110	●	845574
84558	1/2"Dr Deep Impact Socket 1-1/8"	110	●	845581
84560	1/2"Dr Deep Impact Socket 1-1/4"	110	●	845604
84571	1/2"Dr Deep Impact Socket 13mm	109	●	845710
84572	1/2"Dr Deep Impact Socket 14mm	109	●	845727
84573	1/2"Dr Deep Impact Socket 15mm	109	●	845734
84574	1/2"Dr Deep Impact Socket 16mm	109	●	845741
84575D	1/2"Dr Deep Impact Socket 17mm	109	●	845758
84576D	1/2"Dr Deep Impact Socket 18mm	109	●	845765
84577	1/2"Dr Deep Impact Socket 19mm	109	●	845772
84578	1/2"Dr Deep Impact Socket 20mm	109	●	845789
84579	1/2"Dr Deep Impact Socket 21mm	109	●	845796
84580	1/2"Dr Deep Impact Socket 22mm	109	●	845802
84581	1/2"Dr Deep Impact Socket 23mm	109	●	845819
84582	1/2"Dr Deep Impact Socket 24mm	109	●	845826
84583	1/2"Dr Deep Impact Socket 25mm	109	●	845833
84584	1/2"Dr Deep Impact Socket 26mm	109	●	845840
84585D	1/2"Dr Deep Impact Socket 27mm	109	●	845857
84586D	1/2"Dr Deep Impact Socket 28mm	109	●	845864
84587	1/2"Dr Deep Impact Socket 29mm	109	●	845871
84588	1/2"Dr Deep Impact Socket 30mm	109	●	845888
84589D	1/2"Dr Deep Impact Socket 31mm	109	●	845895
84590D	1/2"Dr Deep Impact Socket 32mm	109	●	845901
84643	1/2"Dr Impact Adapter 1/2fx3/8m	107	●	846434
84644	1/2"Dr Impact Extension Bar 10"	107	●	846441
84646	1/2"Dr Impact Extension Bar 5"	107	●	846465
84930	12pc 1/2"Dr Impact Socket Set Metric	105	●	849305
84931	12pc 1/2"Dr Impact Socket Set SAE	105	●	849312
84940	7 pc. 1/2" Dr. Hex Impact Socket Set SAE	106	●	849404
84942	12pc 1/2 Drive SAE Deep	106	●	849428
84944	12pc 1/2 Drive Metric Deep	105	●	849442
85035	35pc GearWrench MicroDriver Set	61	■	850356
85050	1/4" Dr. Micrometer Torque Wrench (30 - 200 in./lbs.)	165	■	850509
85051	3/8" Dr. Micrometer Torque Wrench(25 - 250 in./lbs.)	165	■	850516
85052	3/8" Dr. Micrometer Torque Wrench(10 - 100 ft./lbs.)	165	■	850523
85053	1/2" Dr. Micrometer Torque Wrench(20 - 150 ft./lbs.)	165	■	850530

Material No.	Description	Page No.	Barcode Prefix	
			■ 082171	● 099575
85054	1/2" Dr. Micrometer Torque Wrench (20 - 250 ft./lbs.)	165	■	850547
85055	3/4" Dr. Micrometer Torque Wrench (100-600ft./lbs.)	165	■	850554
85070	3/8" Electronic Torque Wrench(10 - 100 ft./lbs.)	165	■	850707
85071	1/2" Electronic Torque Wrench(25 - 250 ft./lbs.)	165	■	850714
85073	3/8" Electronic Flex Head Torque Wrench	165	■	850738
85074	1/2" Electronic Flex Head Torque Wrench	165	■	850745
85098	12pc GearWrench XL Set Metric	140	■	850981
85099R	16pc GearWrench XL Set Metric (Roll)	141	■	850929
85198	8pc GearWrench XL Set SAE	140	■	851988
85199R	13pc GearWrench XL Set SAE (Roll)	141	■	851919
85201	QuadBox 4in1 Wrench 5/16 x 3/8 + 7/16x1/2	137	●	852015
85202D	QuadBox 4in1 Wrench 9/16x5/8+11/16x3/4	137	●	852022
85203	QuadBox 4in1 Wrench 13/16x7/8+15/16x1"	137	●	852039
85204	3 pc. QuadBox™ Dble Box Ratcheting Wrench Set SAE	138	●	852046
85210D	Ratcheting Wrench Set QuadboxMetric 13Pc.	138	●	852107
85211	QuadBox 4in1 Wrench 8x10 + 12x13mm	137	●	852114
85212	QuadBox 4in1 Wrench 16x17 + 18x19mm	137	●	852121
85512D	Ratcheting Open End Wrench 12mm	124	●	855122
85213	QuadBox 4in1 Wrench 9x11+14x15mm	137	●	852138
85214	QuadBox 4in1 Wrench 20x21+22x24mm	137	●	852145
85215	4 pc. QuadBox™ Dble Box Ratcheting Wrench Set Metric	138	●	852152
85288	12pc XL X-Beam(Ergo) Flex.GearWrench Set Metric	149	●	852886
85298	9px XL X-Beam(Ergo) Flex.GearWrench Set SAE	149	●	852985
85299	5pc S Type Reversible GearWrench Set Metric	133	■	852992
85388	12pc XL X-Beam(Ergo) Rev.GearWrench Set Metric	148	●	853883
85398	9pc XL X-Beam(Ergo) Rev.GearWrench Set SAE	148	●	853982
85399	4pc S Type Reversible GearWrench Set SAE	133	■	853999
85488	12pc Metric Indexing Combination Wrench Set	132	●	854880
85498	8pc SAE Indexing Combination Wrench Set	132	●	854989
85508	Ratcheting Open End Wrench 8mm	124	●	855085
85509	Ratcheting Open End Wrench 9mm	124	●	855092
85510	Ratcheting Open End Wrench 10mm	124	●	855108
85511	Ratcheting Open End Wrench 11mm	124	●	855115
85513	Ratcheting Open End Wrench 13mm	124	●	855139
85514D	Ratcheting Open End Wrench 14mm	124	●	855146
85515	Ratcheting Open End Wrench 15mm	124	●	855153
85516	Ratcheting Open End Wrench 16mm	124	●	855160
85517	Ratcheting Open End Wrench 17mm	124	●	855177
85518	Ratcheting Open End Wrench 18mm	124	●	855184
85519	Ratcheting Open End Wrench 19mm	124	●	855191
85570	Ratcheting Open End Wrench 5/16"	124	●	855702
85572	Ratcheting Open End Wrench 3/8"	124	●	855726
85574	Ratcheting Open End Wrench 7/16"	124	●	855740
85576	Ratcheting Open End Wrench 1/2"	124	●	855764
85578	Ratcheting Open End Wrench 9/16"	124	●	855788
85580	Ratcheting Open End Wrench 5/8"	124	●	855801
85582	Ratcheting Open End Wrench 11/16"	124	●	855825
85584	Ratcheting Open End Wrench 3/4"	124	●	855849
85597	12pc Metric Ratcheting Open End Set	125	●	855979
85598	9pc XL Spline COM.Ratcheting Wrench SAE	146	●	855986
85599	8pc SAE Ratcheting Open End Set	125	●	855993
85608	XL Flex Ratcheting Locking Wrench 8mm	142	■	856082
85610	XL Flex Ratcheting Locking Wrench 10mm	142	■	856105
85611	XL Flex Ratcheting Locking Wrench 11mm	142	■	856112
85612	XL Flex Ratcheting Locking Wrench 12mm	142	■	856129
85613	XL Flex Ratcheting Locking Wrench 13mm	142	■	856136
85614	XL Flex Ratcheting Locking Wrench 14mm	142	■	856143
85615	XL Flex Ratcheting Locking Wrench 15mm	142	■	856150
85616	XL Flex Ratcheting Locking Wrench 16mm	142	■	856167
85617	XL Flex Ratcheting Locking Wrench 17mm	142	■	856174
85698	12pc XL Locking Flex GearWrench Metric	142	■	856983
85698R	12pc XL Locking Flex GearWrench Set Metric (Roll)	143	■	856907
85798	8pc XL Locking Flex GearWrench SAE	143	■	857980
85798R	8pc XL Locking Flex GearWrench Set SAE (Roll)	143	■	857997

Material No.	Description	Page No.	Barcode Prefix	
			■ 082171	● 099575
85888	12pc XL X-Beam(Ergo) GearWrench Set Metric	147	■	858888
85898	9pc XL X-Beam(Ergo) GearWrench Set SAE	147	■	858987
85908	XL Ratcheting Wrench Gearbox Dbl. Box 8mm	144	■	859083
85910	XL Ratcheting Wrench Gearbox Dbl. Box 10mm	144	■	859106
85911	XL Ratcheting Wrench Gearbox Dbl. Box 11mm	144	■	859113
85912	XL Ratcheting Wrench Gearbox Dbl. Box 12mm	144	■	859120
85913	XL Ratcheting Wrench Gearbox Dbl. Box 13mm	144	■	859137
85914	XL Ratcheting Wrench Gearbox Dbl. Box 14mm	144	■	859144
85915	XL Ratcheting Wrench Gearbox Dbl. Box 15mm	144	■	859151
85916	XL Ratcheting Wrench Gearbox Dbl. Box 16mm	144	■	859168
85917	XL Ratcheting Wrench Gearbox Dbl. Box 17mm	144	■	859175
85918	XL Ratcheting Wrench Gearbox Dbl. Box 18mm	144	■	859182
85919	XL Ratcheting Wrench Gearbox Dbl. Box 19mm	144	■	859199
85922	XL Ratcheting Wrench GEARBX DBL BX 22mm	144	■	859229
85987	5pc XL GearWrench Box Set Metric	145	■	859878
85988	12pc XL GearWrench Box Set Metric	145	■	859885
85996	4pc XL GearWrench Box Set SAE	145	■	859960
85998	9pc XL GearWrench Box Set SAE	146	■	859984
86990	Mechanics Gloves	193	●	869907
86991	GearWrench Fender Cover	193	●	869914
8909D	Ratcheting Nut Driver Set, Metric 9PC	173	■	089091
89100	5Pc. Ratcheting Flex Flare Nut Wrench Set - SAE	134		714994912330
89101D	6Pc. Ratcheting Flex Flare Nut Wrench Set - Metric	132	●	891014
89118	Crowfoot 11 Piece SAE - Ratcheting	135	●	891182
89119	Crowfoot 10 Piece Metric - Ratcheting	135	●	891199
891226	25 Pc 1/2"Dr XL Locking Flex Handle Set SAE/Metric	96	■	891229
8916D	16pc GearDriver Nut Driver Set SAE/Metric	173	■	089169
8921	Pass-Thru 3/8" Dr. Metric 21Pc.	96	■	089213
893800	3/8"Dr. XL Locking Flex w/- Handle	96	■	893803
8939	Ratcheting Screwdriver Set - 39 Pc.	170	■	089398
9008	Original Ratcheting, Combination Wrench 1/4"	115	■	90080
9010D	Original Ratcheting, Combination Wrench 5/16"	115	■	90103
9011D	Original Ratcheting, Combination Wrench 11/32"	115	■	90110
9012D	Original Ratcheting, Combination Wrench 3/8"	115	■	90127
9014	Original Ratcheting, Combination Wrench 7/16"	115	■	90141
9016D	Original Ratcheting, Combination Wrench 1/2"	115	■	90165
9018D	Original Ratcheting, Combination Wrench 9/16"	115	■	90189
9020	Original Ratcheting, Combination Wrench 5/8"	115	■	90202
9022	Original Ratcheting, Combination Wrench 11/16"	115	■	90226
9024	Original Ratcheting, Combination Wrench 3/4"	115	■	90240
9026D	Original Ratcheting, Combination Wrench 13/16"	115	■	90264
9028D	Original Ratcheting, Combination Wrench 7/8"	115	■	90288
9030	Original Ratcheting, Combination Wrench 15/16"	115	■	90301
9032	Original Ratcheting, Combination Wrench 1"	115	■	90325
9034	Original Ratcheting, Combination Wrench 1-1/16"	115	■	90349
9036	Original Ratcheting, Combination Wrench 1-1/8"	115	■	90363
9038D	Original Ratcheting, Combination Wrench 1-1/4"	115	■	90387
9040	Original Ratcheting, Combination Wrench 1-7/16" (Jumbo)	115	■	90400
9042	Original Ratcheting, Combination Wrench 1-1/2" (Jumbo)	115	■	90424
9044	Original Ratcheting, Combination Wrench 1-9/16"(Jumbo)	115	■	90448
9046D	Original Ratcheting, Combination Wrench 1-5/8"(Jumbo)	115	■	90462
9048	Original Ratcheting, Combination Wrench 1-11/16"(Jumbo)	115	■	90486
9050D	Original Ratcheting, Combination Wrench 1-3/4"(Jumbo)	115	■	90509
9052D	Original Ratcheting, Combination Wrench 1-13/16"(Jumbo)	115	■	90523
9054D	Original Ratcheting, Combination Wrench 1-7/8"(Jumbo)	115	■	90547
9056D	Original Ratcheting, Combination Wrench 2" (Jumbo)	115	■	90561

Material No.	Description	Page No.	Barcode Prefix	
			■ 082171	● 099575 ▲ 09337103
9060D	Original Ratcheting, Combination Wrench 1-5/16" (Jumbo)	115	■	90608
9062D	Original Ratcheting, Combination Wrench 1-3/8" (Jumbo)	115	■	90622
9106	Original Ratcheting, Combination Wrench 6mm	114	■	91063
9107	Original Ratcheting, Combination Wrench 7mm	114	■	91070
9108D	Original Ratcheting, Combination Wrench 8mm	114	■	91087
9109	Original Ratcheting, Combination Wrench 9mm	114	■	91094
9110D	Original Ratcheting, Combination Wrench 10mm	114	■	91100
9111	Original Ratcheting, Combination Wrench 11mm	114	■	91117
9112	Original Ratcheting, Combination Wrench 12mm	114	■	91124
9113D	Original Ratcheting, Combination Wrench 13mm	114	■	91131
9114D	Original Ratcheting, Combination Wrench 14mm	114	■	91148
9115D	Original Ratcheting, Combination Wrench 15mm	114	■	91155
9116D	Original Ratcheting, Combination Wrench 16mm	114	■	91162
9117D	Original Ratcheting, Combination Wrench 17mm	114	■	91179
9118D	Original Ratcheting, Combination Wrench 18mm	114	■	91186
9119	Original Ratcheting, Combination Wrench 19mm	114	■	91193
9120	Original Ratcheting, Combination Wrench 20mm	114	■	91209
9121	Original Ratcheting, Combination Wrench 21mm	114	■	91216
9122	Original Ratcheting, Combination Wrench 22mm	114	■	91223
9124	Original Ratcheting, Combination Wrench 24mm	114	■	91247
9125D	Original Ratcheting, Combination Wrench 25mm	114	■	91254
9127D	Original Ratcheting, Combination Wrench 27mm	114	■	91278
9130D	Original Ratcheting, Combination Wrench 30mm	114	■	91308
9132	Original Ratcheting, Combination Wrench 32mm	114	■	91322
9134D	Original Ratcheting, Combination Wrench 34mm	114	■	91346
9136	Original Ratcheting, Combination Wrench 36mm (Jumbo)	114	■	91360
9141D	Original Ratcheting, Combination Wrench 41mm (Jumbo)	114	■	91414
9146D	Original Ratcheting, Combination Wrench 46mm (Jumbo)	114	■	91469
9150	Original Ratcheting, Combination Wrench 50mm (Jumbo)	114	■	91506
9201D	Ratcheting Double Box Wrench 5/16" X 3/8"	136	■	92015
9202D	Ratcheting Double Box Wrench 7/16" X 1/2"	136	■	092022
9210D	Ratcheting Double Box Wrench 8mm X 9mm	136	■	92107
9211D	Ratcheting Double Box Wrench 10mm X 11mm	136	■	92114
9212D	Ratcheting Double Box Wrench 12mm X 13mm	136	■	92121
9215D	Ratcheting Double Box Wrench 17mm X 19mm	136	■	92152
9224D	4Pc. Torx GearWrench Set	137	■	92244
9230D	3Pc. Drive Adapter Set Metric	162	■	092305
9231D	3Pc. Drive Adapter Set SAE	162	■	092312
9240D	4Pc. Double Box End GearWrench Set SAE	136	■	92404
9260	6Pc. Double Box End GearWrench Set Metric	136	■	92602
93004D	5Pc. Original Comb, Ratchet Wrench Set Metric	116	●	930041
93005	5Pc. Original Comb, Ratchet Wrench Set SAE	116	●	930058
9304	SET WR RAT COMB SAE 4Pc.	116	■	93043
9308D	8Pc. Original Comb, Ratchet Wrench Set SAE	119	■	93081
9312	13Pc. Original Comb, Ratchet Wrench Set SAE	118	■	93128
9317	7Pc. Original Comb, Ratchet Wrench Set SAE	117	■	93173
9404	4Pc. Original Comb, Ratchet Wrench Set Metric	116	■	94040
9412	12Pc. Original Comb, Ratchet Wrench Set Metric	119	■	94125
9416	16Pc. Original Comb, Ratchet Wrench Set Metric	118	■	94163
9417	7Pc. Original Comb, Ratchet Wrench Set Metric	117	■	94170
9418	10Pc. Original Comb, Ratchet Wrench Set SAE/Metric	117	■	94187
9507D	7Pc. Stubby GearWrench Set SAE	130	■	95078
9509N	13Pc. Reversible GearWrench Set SAE	123	■	95092
9509R	13Pc. Reversible GearWrench Set SAE(Roll)	123	■	950919
9510DD	Ratcheting Wrench Combination Stubby 10mm	129	■	095108
9511D	Ratcheting Wrench Combination Stubby 11mm	129	■	95115
9512D	Ratcheting Wrench Combination Stubby 12mm	129	■	95122
9513D	Ratcheting Wrench Combination Stubby 13mm	129	■	095139
9514D	Ratcheting Wrench Combination Stubby 14mm	129	■	095146

Material No.	Description	Page No.	Barcode Prefix	
			■ 082171	● 099575 ▲ 09337103
9516D	Ratcheting Wrench Combination Stubby 16mm	129	■	095160
9517D	Ratcheting Wrench Combination Stubby 17mm	129	■	095184
9518D	Ratcheting Wrench Combination Stubby 18mm	129	■	095184
9519D	Ratcheting Wrench Combination Stubby 19mm	129	■	095191
9520D	Ratcheting Wrench Combination Stubby Set Metric 10PC	130	■	95207
9521D	Reversible GearWrench 11/32"	120	■	95214
9525D	Reversible GearWrench 5/16"	120	■	95252
9526	Reversible GearWrench 3/8"	120	■	95269
9527	Reversible GearWrench 7/16"	120	■	95276
9528	Reversible GearWrench 1/2"	120	■	95283
9529	Reversible GearWrench 9/16"	120	■	95290
9530	Reversible GearWrench 5/8"	120	■	95306
9531DD	Reversible GearWrench 11/16"	120	■	95313
9532D	Reversible GearWrench 3/4"	120	■	95320
9533DD	8pc Reversible GearWrench Set SAE	121	■	95337
9534D	Reversible GearWrench 13/16"	120	■	95344
9538	Reversible GearWrench 7/8"	120	■	95382
9539	Reversible GearWrench 15/16"	120	■	95399
9540	Reversible GearWrench 1"	120	■	95405
9543	8pc Reversible GearWrench Set Metric	121	●	95436
9550	10pcs Stubby Flex GearWrench Set Metric	131	■	95504
95551	13 pace QuadBox GearWrench(442) Set SAE	139	■	714994955511
95552	13 pace QuadBox GearWrench(442) Set Metric	139	■	714994955528
9570	7pcs Stubby Flex GearWrench Set SAE	131	■	95702
9602	16pc Reversible GearWrench Set Metric	122	■	96020
9602R	16pc Reversible GearWrench Set Metric (Roll)	123	■	96020
9608	Reversible GearWrench 8mm	120	■	96082
9609D	Reversible GearWrench 9mm	120	■	96099
9610D	Reversible GearWrench 10mm	120	■	96105
9611	Reversible GearWrench 11mm	120	■	96112
9612D	Reversible GearWrench 12mm	120	■	96129
9613D	Reversible GearWrench 13mm	120	■	96136
9614D	Reversible GearWrench 14mm	120	■	96143
9615D	Reversible GearWrench 15mm	120	■	96150
9616D	Reversible GearWrench 16mm	120	■	96167
9617	Reversible GearWrench 17mm	120	■	96174
9618D	Reversible GearWrench 18mm	120	■	96181
9619	Reversible GearWrench 19mm	120	■	96198
9620D	12pc Reversible GearWrench Set Metric	121	■	96204
9621D	Reversible GearWrench 21mm	120	■	96211
9622	Reversible GearWrench 22mm	120	■	96228
9624D	Reversible GearWrench 24mm	120	■	96242
9625	Reversible GearWrench 25mm	120	■	96259
9700	7pc Flex GearWrench Set SAE	127	■	97003
9701	8pc Flex GearWrench Set SAE	128	■	97010
9702D	13pc Flex Combination Ratcheting Set SAE	128	■	97027
9704D	Flex GearWrench 11/32"	126	■	97041
9705	Flex GearWrench 5/16"	126	■	97058
9706	Flex GearWrench 3/8"	126	■	97065
9707	Flex GearWrench 7/16"	126	■	97072
9708	Flex GearWrench 1/2"	126	■	97089
9709	Flex GearWrench 9/16"	126	■	97096
9710	Flex GearWrench 5/8"	126	■	97102
9711	Flex GearWrench 11/16"	126	■	97119
9712	Flex GearWrench 3/4"	126	■	97126
9713	Flex GearWrench 13/16"	126	■	97133
9714D	Flex GearWrench 7/8"	126	■	97140
9715D	Flex GearWrench 15/16"	126	■	97157
9716D	Flex GearWrench 1"	126	■	97164
9840D	4pcs Half Moon GearWrench Set SAE	133	■	98406
9850	5pcs Half Moon GearWrench Set Metric	133	■	98505
9900D	7pc Flex GearWrench Set Metric	127	■	99007
9901D	12pc Flex GearWrench Set Metric	127	■	99014
9902D	Set Wrench Ratcheting Combination Flex Metric 16Pc	128	■	092022

Material No.	Description	Page No.	Barcode Prefix	
			■ 082171	● 099575
9908D	Flex GearWrench 8mm	126	■	99083
9909D	Flex GearWrench 9mm	126	■	99090
9910D	Flex GearWrench 10mm	126	■	99106
9911D	Flex GearWrench 11mm	126	■	99113
9912D	Flex GearWrench 12mm	126	■	99120
9913D	Flex GearWrench 13mm	126	■	99137
9914D	Flex GearWrench 14mm	126	■	99144
9915D	Flex GearWrench 15mm	126	■	99151
9916D	Flex GearWrench 16mm	126	■	99168
9917	Flex GearWrench 17mm	126	■	99175
9918	Flex GearWrench 18mm	126	■	99182
9919D	Flex GearWrench 19mm	126	■	99199
9921D	Flex GearWrench 21mm	126	■	99212
9922D	Flex GearWrench 22mm	126	■	99229
9924D	Flex GearWrench 24mm	126	■	99243
9925D	Flex GearWrench 25mm	126	■	99250

The prices shown are recommended and exclusive of G.S.T. Net prices can be derived by applying your appropriate discount, unless otherwise authorised by Apex Tool Group Pty. Limited, Albury NSW and are subject to change without notice. All orders are subject to acceptance by the factory in Albury. Orders are accepted only on the basis of prices ruling on the date of shipment, unless otherwise agreed.

Credit Claim

Claims for shortages, breakages, etc., must be made within 14 days on receipt of goods.

All orders will be shipped CPT Carriage Paid to destination, or as negotiated.

Small Order Charge

For orders of less than \$100.00 excluding GST an order processing charge of \$10.00 + GST will apply. Back orders and spare parts are exempt from this condition.

Finish

We reserve the right to furnish, without notice, whatever finish is available regardless of catalogue descriptions.

Trading Terms

Payment received within 30 days of the last day of the month in which the invoice was raised. Cash Discounts 2% for Payment received within 10 days of the last day of the month in which the invoice was raised.

Minimum Annual Spend

To maintain an account with Apex Tool Group Pty. Limited, a minimum annual spend of \$5,000 excluding GST, is required each year. Should sales fall below this amount in any one calendar year, you will be given the opportunity to discuss your situation with Apex Tool Group and to increase your sales over the following 6 month period. Should this not occur, your account will be closed at Apex's discretion.

Rebates

All rebates are dependent on the recipients account being conducted as per our Terms and Conditions.

Freight

Chargeable freight to the customer will be prepaid and charged on our invoice.

Shelf Packs

All orders must be for standard packs as indicated. Where indicated Shelf Packs may be broken, at a 5% surcharge.

Product Returns

All returns of Apex Tool Group products should be to the factory, via our specified carrier.

Apex Tool Group Pty. Limited
519 Nuringong Street
Albury NSW 2640

Goods Returned Under Warranty

Postal or freight charges via our specified carrier both to the factory and on return will be for the account of Apex Tool Group.

Goods Returned for Repair

Postal or freight charges to the factory will be for customers account and return charges will be for account of Apex Tool Group.

Goods Returned for Credit

Any Apex Tool Group product may only be returned with written permission of Apex Tool Group Albury. All products must be new, of current design and in a resaleable condition. Credit will then be issued at the original purchase price, less a 15% handling service fee.

Apex Tool Group Pty. Limited
A.B.N. 50 002 965 826
PO Box 366, 519 Nuringong Street
Albury NSW 2640 Australia
(02) 6058 0300, 6021 5511, Fax 6021 7403
Sales (02) 6021 6666

Stock Adjustment Policy

All requests to return merchandise must be approved by the Apex Tool Group National Divisional Sales Manager. An offsetting order of equivalent value must accompany the request for stock adjustment. An offsetting order must be for standard price listed items at current prices and standard terms (no promotions, specials, dating orders, contract items or merchandisers).

Proof of purchase must be established on all items.

Apex Tool Group will not accept the return of a product as part of a stock adjustment return which was not originally purchased from Apex Tool Group. The price shown on the Request for Return must coincide with the price list in effect at the time of original supply. The inclusion of a copy of the original Apex Tool Group invoice on which the item was shipped, will expedite the processing of the adjustment. Inventory adjustments will be credited at the actual cost paid by the distributor as determined by proof of purchase, going back one year. A 15% handling service fee will be assessed.

After authorisation is received, all returns must be shipped to the Albury factory, freight prepaid.

All returned products must be of current design and finish, in current production, and must be in a restockable condition upon receipt at the Albury factory. Any returned products which are not in a restockable condition will not be accepted and the distributor will be notified for disposition.

Returns will not be allowed for special made to order items.

Individually packed items must be in the original factory-sealed package when returned.

Guarantee/Warranty

Apex Tool Group quality products are Guaranteed against any defect in material or workmanship. Electronic products however, have a limited Warranty of one year from date of purchase. Damage caused by abuse, improper use or excessive wear is not covered by this warranty.

Our goods come with guarantees that cannot be excluded under the Australian Consumer Law. You are entitled to a replacement or refund for a major failure and for compensation for any other reasonably foreseeable loss or damage. You are also entitled to have the goods repaired or replaced if the goods fail to be of acceptable quality and the failure does not amount to a major failure. Claims should be returned, with proof of purchase, to the place of purchase or returned prepaid to the address below. Repaired or replacement goods will be returned at our cost.

Apex Tool Group Pty Limited

(ABN 50 002 965 826)
519 Nuringong Street, Albury
NSW 2640, AUSTRALIA
PH: (02) 60580300
apextoolaus@apextoolgroup.com

Recommended Prices

The price set out or referred to herein is a recommended price only and there is no obligation to comply with the recommendation.

**PRICES HEREIN DO NOT
INCLUDE G.S.T.**

APEX TOOL GROUP - CUSTOMER SUPPORT

Sales Phone: 02 6021 6666

Sales Fax: 1800 021 940

Sales E-Mail: alburysales@apextoolgroup.com

HEAD OFFICE

Apex Tool Group Pty Ltd

519 Nuringong Street

ALBURY NSW 2640

Phone: 02 6058 0300

Email: apextoolaus@apextoolgroup.com

Web: www.apextoolgroup.com.au

PO Box 366

ALBURY NSW 2640

Fax: 02 6021 7403

REGIONAL SALES TEAM & AGENTS

NSW

DONN TRAYLEN

Regional Sales Manager

Mobile: 0457 750 475

donn.traylen@apextoolgroup.com

IAN BROWN

Sales Supervisor

Mobile: 0417 028 221

Fax: 02 9648 1990
ian.brown2@apextoolgroup.com

PHIL CROWE

Sales Supervisor

Mobile: 0418 474 949

Fax: 02 4735 2296
phil.crowe@apextoolgroup.com

PAUL GROSS

Sales Supervisor

Mobile: 0408 666 478

paul.gross@apextoolgroup.com

GEOFF NELSON

Sales Supervisor

Mobile: 0418 478 086

Fax: 02 4920 8936
geoff.nelson@apextoolgroup.com

QLD

PETER HANNAN

Regional Sales Manager

Mobile: 0419 282 426

Fax: 07 3324 8847

peter.hannan@apextoolgroup.com

MARK LINDNER

Sales Supervisor

Mobile: 0418 475 804

mark.lindner@apextoolgroup.com

WARWICK STONE

Sales Supervisor

Mobile: 0417 028 088

Fax: 07 3264 5258
warwick.stone@apextoolgroup.com

North QLD

TAMBAR PTY LTD

Phone: 07 4774 5124

Fax: 07 4774 5292

RAYMOND CHRISTENSEN

Mobile: 0418 771 098

sales@tambar.com.au

VIC

BRIAN KIDD

Regional Sales Manager

Mobile: 0419 289 557

brian.kidd@apextoolgroup.com

LISA COTTON

Sales Supervisor

Mobile: 0419 293 611

lisa.cotton@apextoolgroup.com

JASON KEMP

Sales Supervisor

Mobile: 0418 471 297

jason.kemp@apextoolgroup.com

MICHAEL MANNING

Sales Supervisor

Mobile: 0448 063 489

michael.manning@apextoolgroup.com

WA

APEX TOOL GROUP

52 Clavering Rd

BAYSWATER WA 6053

Phone: 08 9370 3377

Fax: 08 9272 3903

BRETT RAPONI

Regional Sales Manager

Mobile: 0419 293 909

Fax: 08 9272 3903

brett.raponi@apextoolgroup.com

GILLIAN BRAIN

Sales Supervisor

Mobile: 0438 681 704

Fax: 08 9272 3903

gillian.brain@apextoolgroup.com

GRAHAM DOOLAN

Sales Supervisor

Mobile: 0418 476 179

Fax: 08 9272 3903

graham.doolan@apextoolgroup.com

SA

CHRIS HERMAN

Regional Sales Manager

Mobile: 0419 295 033

chris.herman@apextoolgroup.com

KATINA STOTT

Sales Supervisor

Mobile: 0419 291 763

katina.stott@apextoolgroup.com

TAS

L & J PRETORIUS PTY LTD

Phone: 03 6344 2686

Fax: 03 6344 7220

LEW PRETORIUS

Mobile: 0438 131 669

lewp@precons.com

IVAN PRETORIUS

Mobile: 0419 338 173

ivanp@precons.com

NT

TERRITORY HARDWARE AGENCIES

GREG MELVILLE

Phone: 0417 887 280

greg@tha-nt.com.au

NOLAN CALDWELL

Phone: 0418 892 371

nolan@tha-nt.com.au

NEW ZEALAND

STEPHEN COLE

ISL INDUSTRIAL

40 Crooks Road

East Tamaki, AUCKLAND, 2013

NEW ZEALAND

Phone: +64 9 272 8788

Fax: 0800 301302

stephen.cole@isl-industrial.co.nz

FIJI

ARSHAD DAUD

MIDLINK MARKETING

19 Ackland Street, Vatuwaqa,

SUVA, FIJI

Phone: (+679) 338 6300

Fax: (+679) 338 6290

Mobile: (+679) 992 9227

midlink@connect.com.fj

ELECTRONICS

MICHAEL NAISSEN

Product Engineer /

Professional Tools

Phone: 02 6058 0300

Fax: 02 6021 7403

michael.naissen@apextoolgroup.com

BUSINESS DEVELOPMENT

JEFF BECKER

Manager, Business Development

& Key Accounts

Phone: 03 9852 0400

Mobile: 0417 520 400

jeff.becker@apextoolgroup.com

PATRICK McINTOSH

Manager, Business Development

& Key Accounts

Mobile: 0418 673 361

Fax: 02 6336 0273

patrick.mcintosh@apextoolgroup.com

STUART NAYLOR

Manager, Business Development

& Key Accounts

Mobile: 0418 476 655

stuart.naylor@apextoolgroup.com



CERTIFICATE OF REGISTRATION

This is to certify that:

APEX Tool Group

ABN 50 002 965 526

519 Nurigong Street ALBURY NSW 2640 AUSTRALIA

operates a

QUALITY MANAGEMENT SYSTEM

which complies with the requirements of

ISO 9001:2008

for the following scope:

The registration covers the Quality Management System for the manufacture and distribution of premium hand and power tools for the hardware, electronic, industrial and assembly markets throughout Asia Pacific.

Certificate No: QEC0166

Issued: 1 December 2010
Expires: 8 March 2014

Originally Certified: 8 March 1996
Current Certification: 30 November 2010

Alex Ezrakhovitch
General Manager – Certification Services

Duncan Lilley
Global Head – Assurance Services



Registered by:
SAI Global Certification Services Pty Ltd (ACN 108 176 862) 250 Sussex Street, Sydney, NSW 2000 Australia (SAI Global Limited)
250 Sussex Street, Sydney, NSW 2000 Australia (SAI Global) and subject to the SAI Global Terms and Conditions for Certification.
Where all true copies and not be exercised in carrying out the assessment. SAI Global accepts responsibility only for those
and general. This certificate remains the property of SAI Global and must be returned to SAI Global upon its request. To verify that this
certification is current please refer to SAI Global On-line Certification register at www.sai-global.com

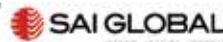

QUALITY POLICY STATEMENT

Management at Apex Tool Group recognises quality is paramount to its continuing commitment to customer satisfaction. Apex Tool Group is proud of its reputation as a vertically integrated Manufacturer and Distributor of Quality Products, including tools and hardware. Apex Tool Group aligns its corporate goals of maximizing customer service through a commitment to providing quality products and technical backup, with an assurance to the end user that its products will perform to their designed application will continue to function for a reasonable period and will represent fair value.

It is Apex Tool Group's objective, that when the name Apex Tool Group is attached to one of its products, its customers can expect a high level of quality and after sales serviced which is recognized as the standard in the industry.

Apex Tool Group's strategy of continuous improvement will enable it to achieve this objective and provide its customers with the 'best value delivered' the same time every time.

Apex Tool Group will review and adhere to documented procedures and standards. We will ensure the integrity of its systems by maintaining accreditation to the International Quality Management Systems Standard ISO 9001:2008.

Apex Tool Group management and all its employees are committed to this policy.

Apex Tool Group
519 Nurigong Street
Albury NSW 2640
Tel: Sales (02) 6021 6666
Fax: Sales 1800 021 940
Email: alburysales@apextoolgroup.com
www.apextoolgroup.com.au



Your Authorised Apex Tool Group Distributor is:

