

Use this number when searching for this item:

9002850025000

Center Drill, 2.5mm, HSS, Uncoated



>> Item Info

EDP #	9002850025000
Series	285
Order Code	2.500
Coating	Uncoated
Coolant Through	No
Cutting Direction	RH
Material	HSS
Point Angle	118°
Shank	Straight
Type	Center Drill

>> Features

- relieved cone
- for centre holes acc. to DIN 332 sheet 1 (issue 09.1960x retracted), Form B
- with protective 120° countersink

>> Suggested Materials

- Aluminum
- Alloyed Steels
- Free Cutting Steels
- Tool Steels
- Stainless Steels
- Ti and Ti-alloys
- Cast Iron
- Brass
- Bronze
- Copper
- Magnesium
- Special Alloys
- Plastic
- Hardened Steels

>> Technical Specs

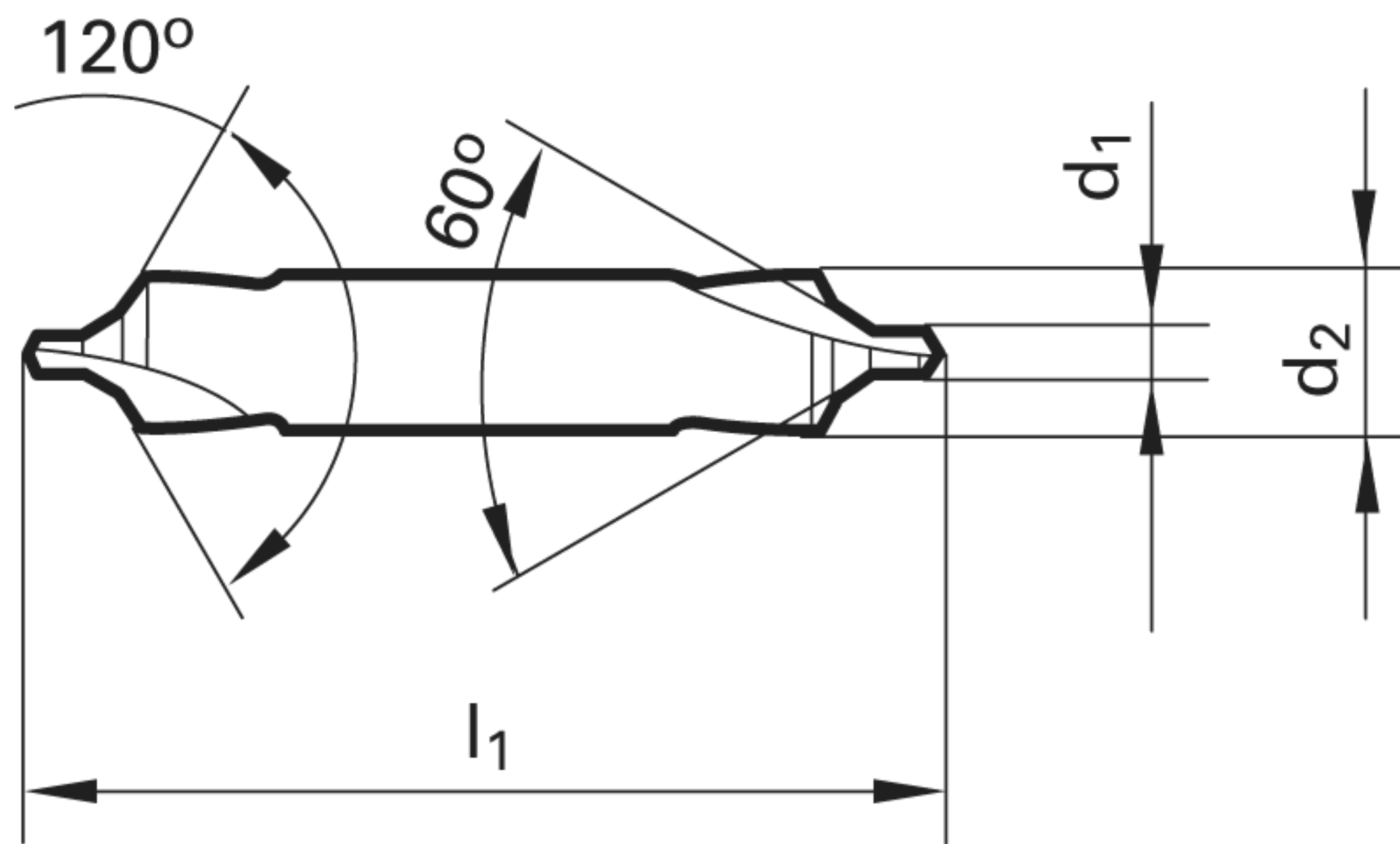

EDP #	Code No.	Cut Ø	Cut Ø	Cut Ø	Cut Ø	Shank Ø	OAL	Flute Length	Drilling Depth	Drilling Depth	Shank Type	Flutes
		d1	d1	d1	d1	d2	l1	l2	tmax	tmax		
		mm	inch	frac.	wire / letter	mm	mm	mm	mm	inch		
9002850025000	2.500	2.500	0.0984			11.200	63.00	18.00	14.25	0.561	Straight	2

*** DISCLAIMER: Data on this PDF is subject to change at any time without notice.