

Use this number when searching for this item:

9002890050000

Center Drill, 5mm, HSS, Uncoated



>> Item Info

EDP #	9002890050000
Series	289
Order Code	5.000
Coating	Uncoated
Coolant Through	No
Cutting Direction	RH
Material	HSS
Point Angle	118°
Shank	Straight
Type	Center Drill

>> Features

- relieved cone
- for centre holes acc. to DIN 332 sheet 1 (issue 09.1960x retracted), Form B
- with protective 120° countersink

>> Suggested Materials

- Aluminum
- Alloyed Steels
- Free Cutting Steels
- Tool Steels
- Stainless Steels
- Ti and Ti-alloys
- Cast Iron
- Brass
- Bronze
- Copper
- Magnesium
- Special Alloys
- Plastic
- Hardened Steels

>> Technical Specs

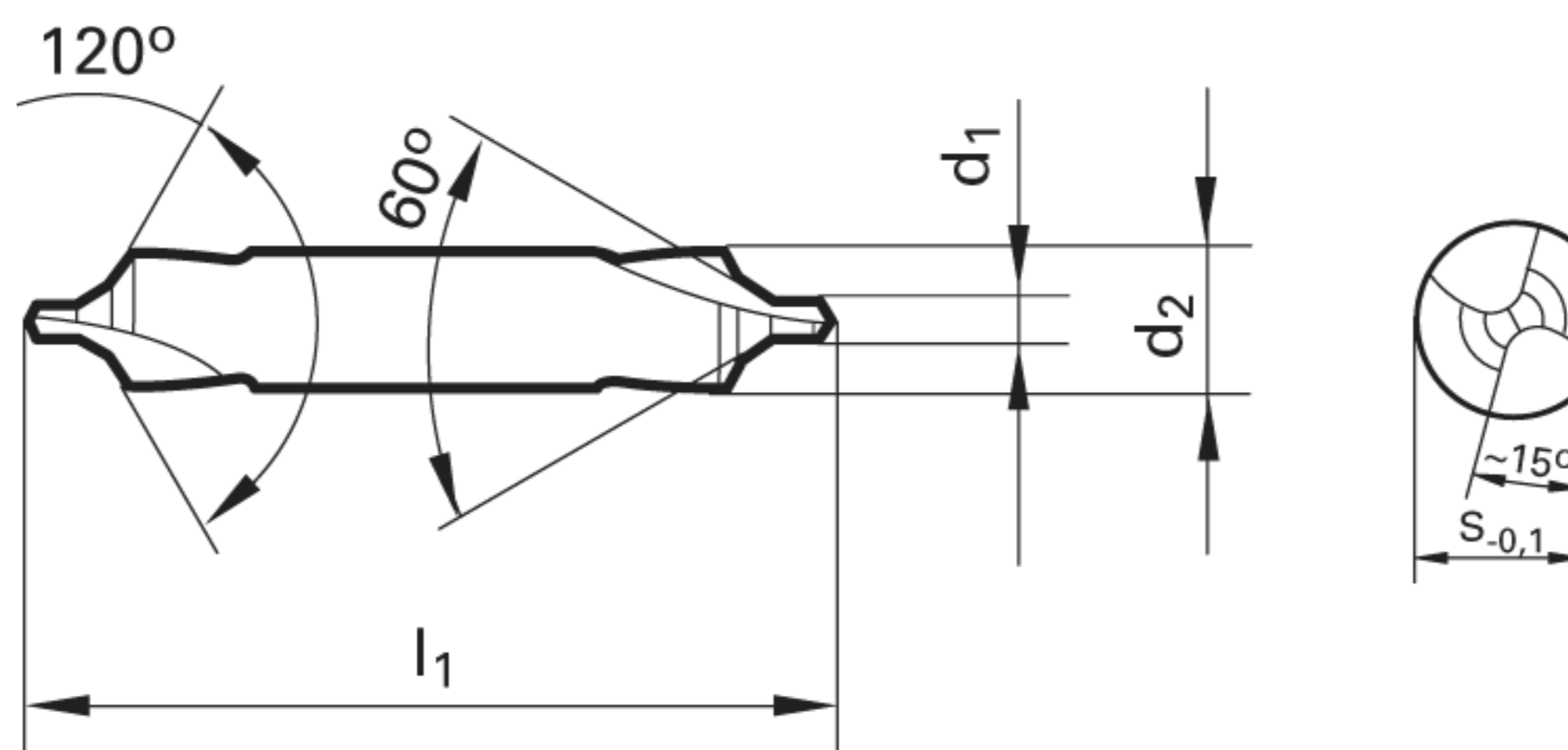

EDP #	Code No.	Cut Ø		Cut Ø		Shank Ø	OAL	Flute Length	Drilling Depth		Shank Type	Flutes
		d1	d1	d1	d1				tmax	tmax		
		mm	inch	frac.	wire / letter				mm	mm		
9002890050000	5.000	5.000	0.1969			20.000	90.00	32.00	24.50	0.965	Straight	2

*** DISCLAIMER: Data on this PDF is subject to change at any time without notice.