

Use this number when searching for this item:

9005870080000

Center Drill, 8mm, HSS, Uncoated



>> Item Info

EDP #	9005870080000
Series	587
Order Code	8.000
Coating	Uncoated
Coolant Through	No
Cutting Direction	RH
Material	HSS
Point Angle	118°
Shank	Straight
Type	Center Drill

>> Features

- relieved cone
- for centre holes to DIN 332, part 1, form A
- without protective countersink

>> Suggested Materials

- Aluminum
- Alloyed Steels
- Free Cutting Steels
- Tool Steels
- Stainless Steels
- Ti and Ti-alloys
- Cast Iron
- Brass
- Bronze
- Copper
- Magnesium
- Special Alloys
- Plastic
- Hardened Steels

>> Technical Specs

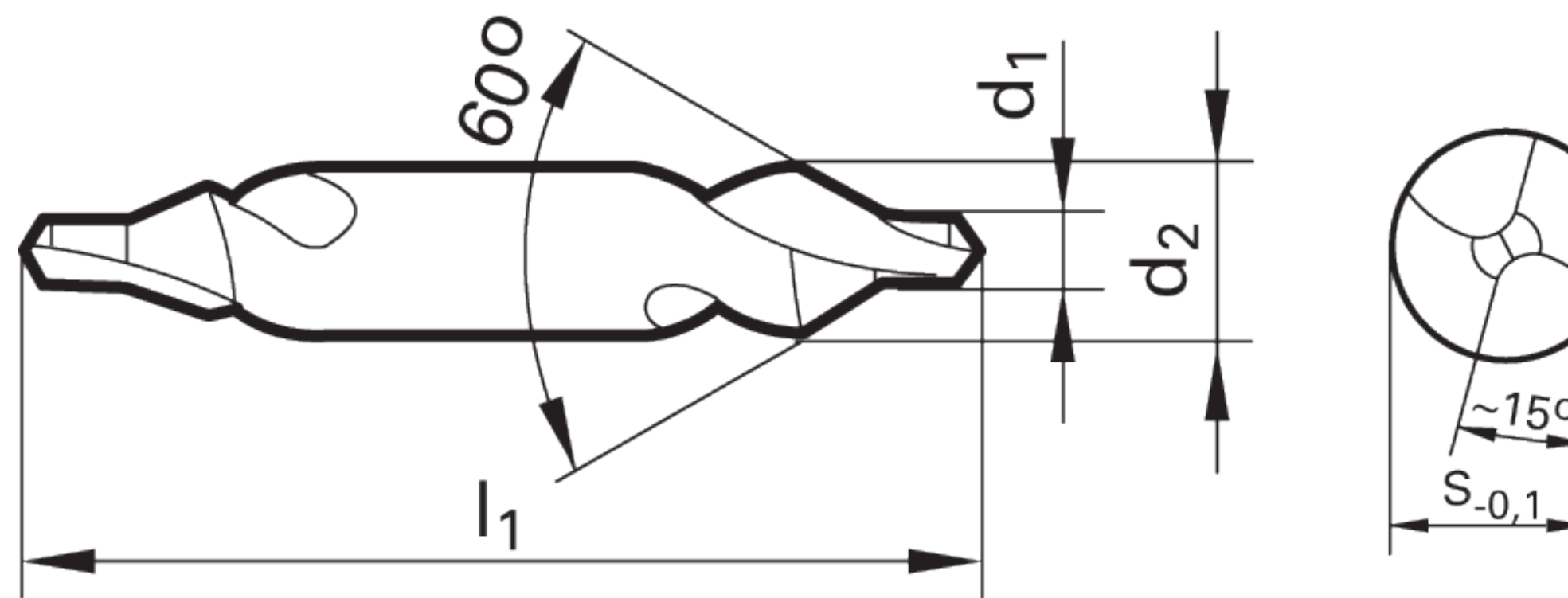

EDP #	Code No.	Cut Ø		Cut Ø		Shank Ø	OAL	Flute Length	Drilling Depth		Shank Type	Flutes
		d1	d1	d1	d1				tmax	tmax		
		mm	inch	frac.	wire / letter	mm	mm	mm	mm	inch		
9005870080000	8.000	8.000	0.3150			20.000	80.00	32.00	20.00	0.787	Straight	2

*** DISCLAIMER: Data on this PDF is subject to change at any time without notice.