

Use this number when searching for this item:

## 9005890040000

### Center Drill, 4mm, HSS, Uncoated



#### >> Item Info

EDP #	9005890040000
Series	589
Order Code	4.000
Coating	Uncoated
Coolant Through	No
Cutting Direction	RH
Material	HSS
Point Angle	118°
Shank	Straight
Type	Center Drill

#### >> Features

- relieved cone
- for centre holes acc. to DIN 332, sheet 1, form B
- with protective 120° countersink

#### >> Suggested Materials

- Aluminum
- Alloyed Steels
- Free Cutting Steels
- Tool Steels
- Stainless Steels
- Ti and Ti-alloys
- Cast Iron
- Brass
- Bronze
- Copper
- Magnesium
- Special Alloys
- Plastic
- Hardened Steels

#### >> Technical Specs

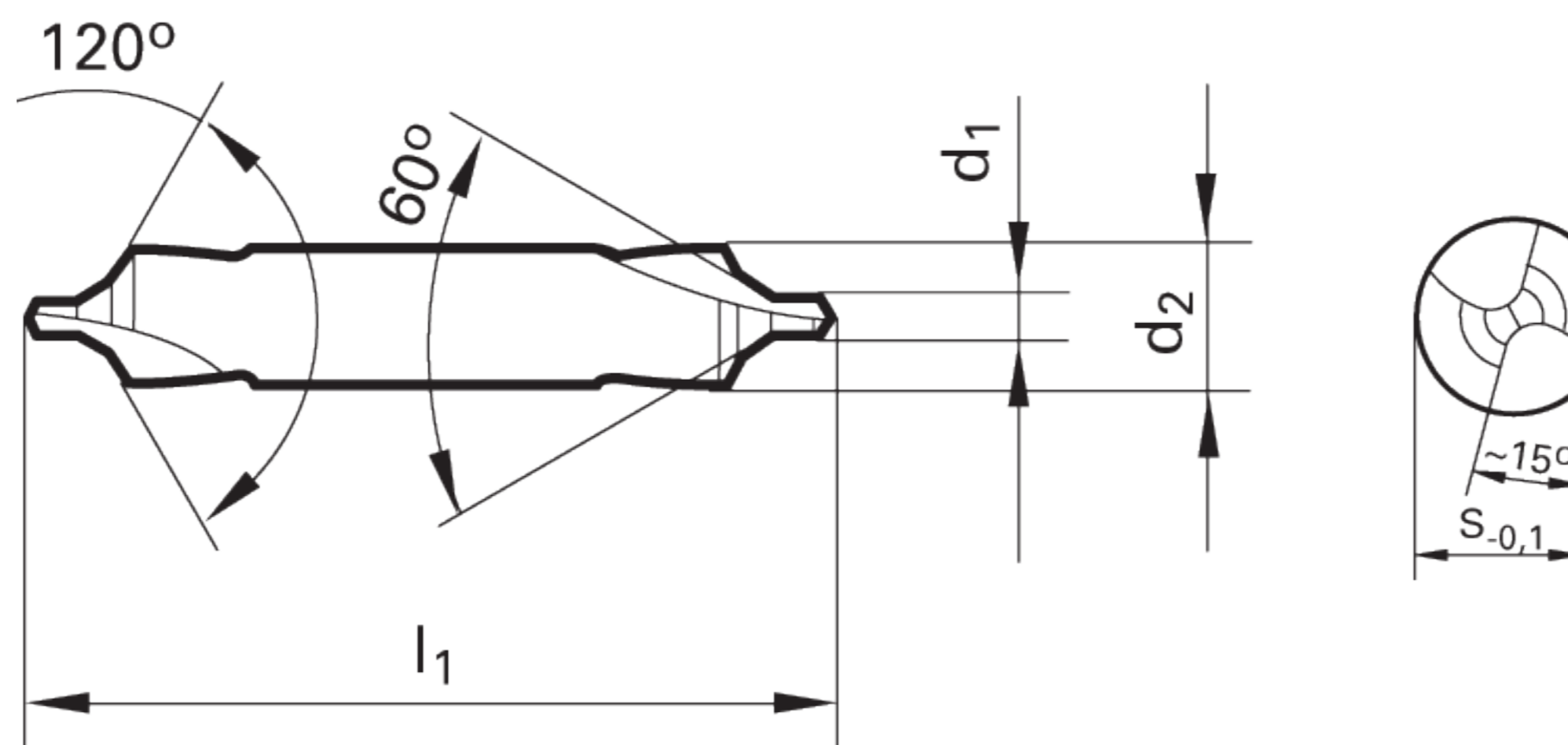

EDP #	Code No.	Cut Ø		Cut Ø		Shank Ø	OAL	Flute Length	Drilling Depth		Shank Type	Flutes
		d1	d1	d1	d1				tmax	tmax		
		mm	inch	frac.	wire / letter				mm	mm		
9005890040000	4.000	4.000	0.1575			14.000	67.00	23.00	17.00	0.669	Straight	2

\*\*\* DISCLAIMER: Data on this PDF is subject to change at any time without notice.