

Use this number when searching for this item:

9005910020000

Center Drill, 2mm, HSS, Uncoated



>> Item Info

EDP #	9005910020000
Series	591
Order Code	2.000
Coating	Uncoated
Coolant Through	No
Cutting Direction	RH
Material	HSS
Point Angle	118°
Shank	Straight
Type	Center Drill

>> Features

- relieved cone
- with re-inforced neck to provide high fracture resistance
- recess between countersink and hole for additional lubricant space
- for centre holes acc. to DIN 332, sheet 1, form B
- with protective 120° countersink

>> Suggested Materials

- Aluminum
- Alloyed Steels
- Free Cutting Steels
- Tool Steels
- Stainless Steels
- Ti and Ti-alloys
- Cast Iron
- Brass
- Bronze
- Copper
- Magnesium
- Special Alloys
- Plastic
- Hardened Steels

>> Technical Specs

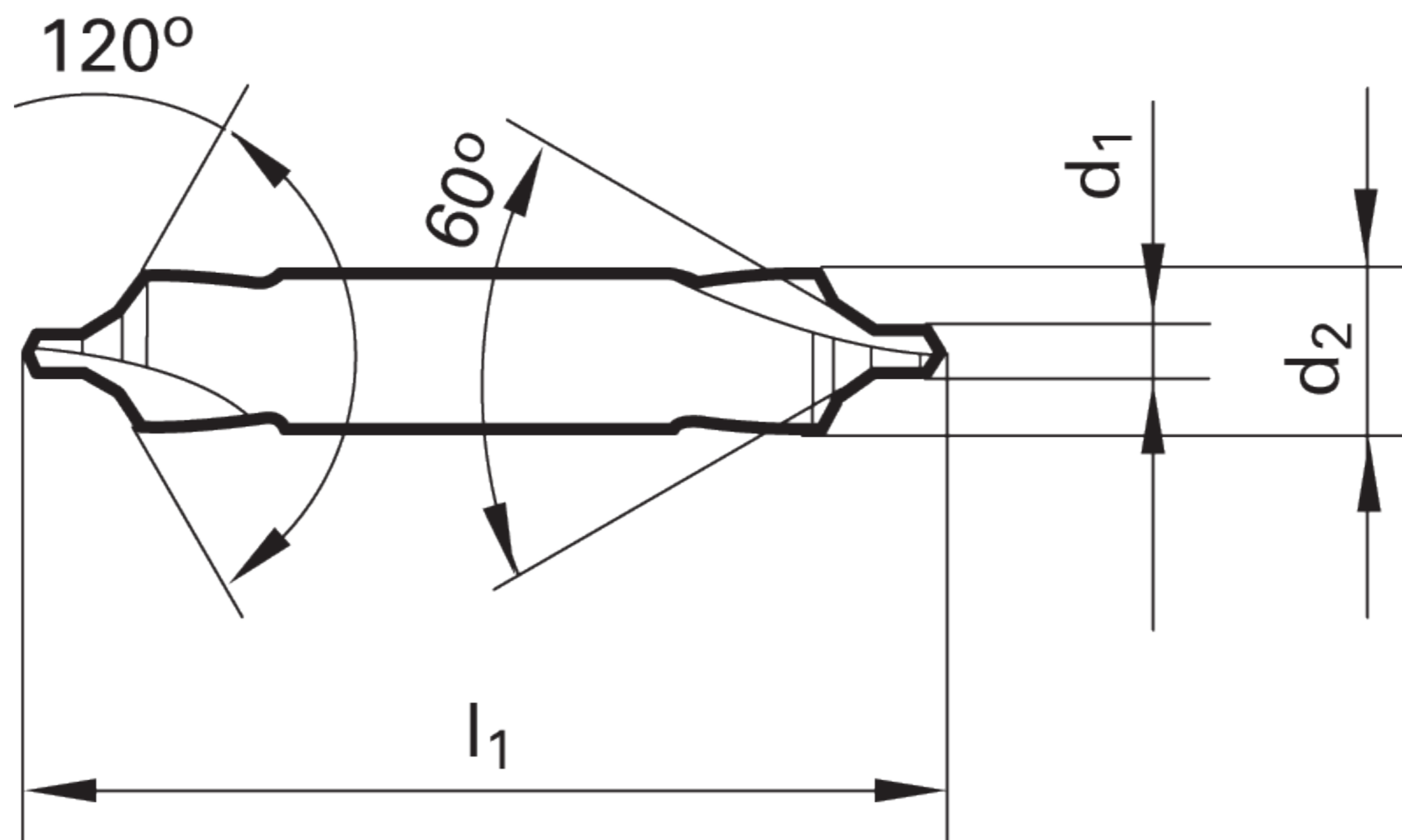

EDP #	Code No.	Cut Ø				Shank Ø	OAL	Flute Length	Drilling Depth		Shank Type	Flutes
		d1	d1	d1	d1				tmax	tmax		
		mm	inch	frac.	wire / letter	mm	mm	mm	mm	inch		
9005910020000	2.000	2.000	0.0787			8.000	50.00	14.00	11.00	0.433	Straight	2

*** DISCLAIMER: Data on this PDF is subject to change at any time without notice.