

Use this number when searching for this item:

## 9005950015900

### Center Drill, 1/16, HSS, Uncoated



#### >> Item Info

EDP #	9005950015900
Series	595
Order Code	1.590
Coating	Uncoated
Coolant Through	No
Cutting Direction	RH
Material	HSS
Point Angle	118°
Shank	Straight
Type	Center Drill

#### >> Features

- relieved cone
- for centre holes form B to US standards

#### >> Suggested Materials

- Aluminum
- Alloyed Steels
- Free Cutting Steels
- Tool Steels
- Stainless Steels
- Ti and Ti-alloys
- Cast Iron
- Brass
- Bronze
- Copper
- Magnesium
- Special Alloys
- Plastic
- Hardened Steels

#### >> Technical Specs

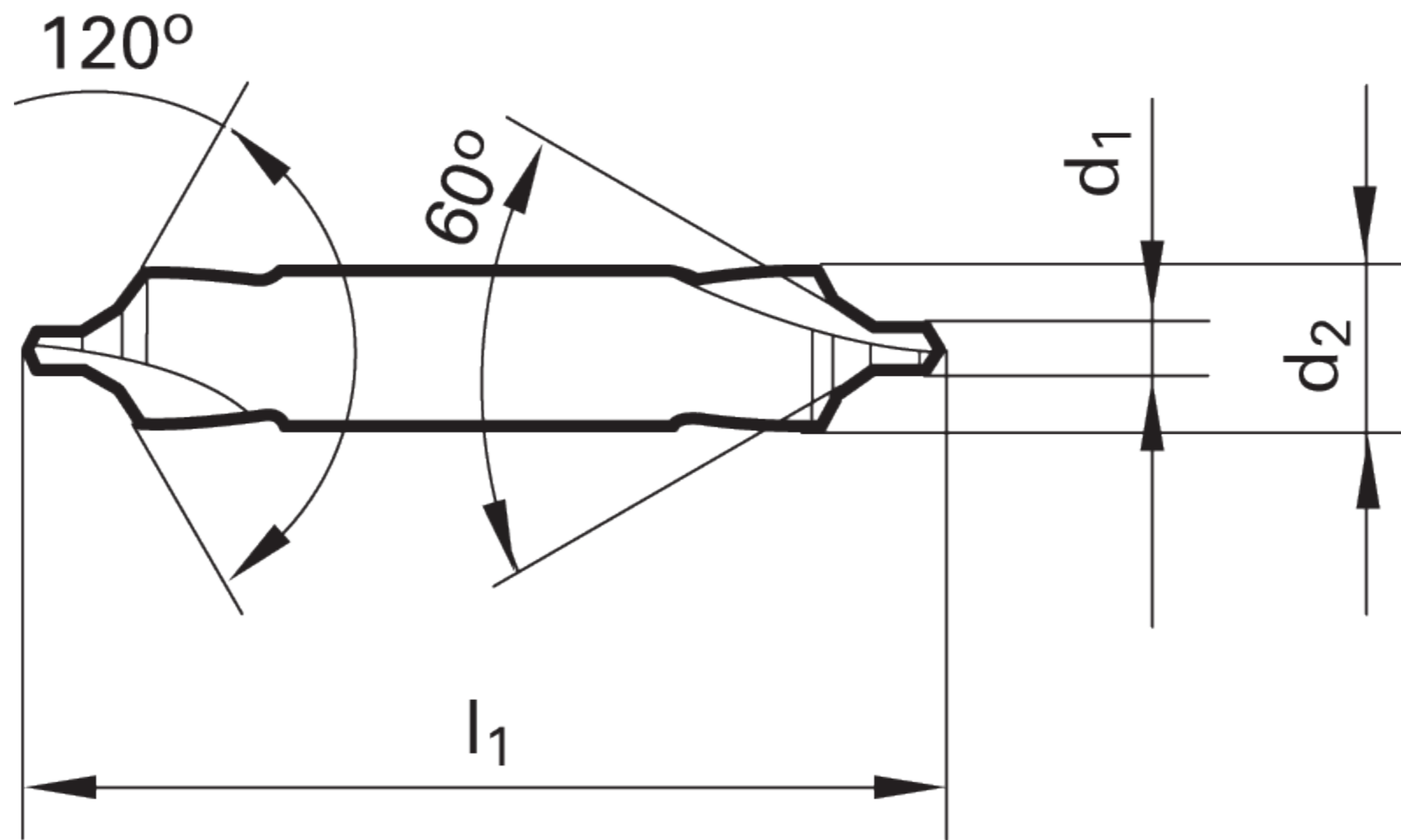

EDP #	Code No.	Cut Ø	Cut Ø	Cut Ø	Cut Ø	Shank Ø	OAL	Flute Length	Drilling Depth	Drilling Depth	Shank Type	Flutes
		d1	d1	d1	d1	d2	l1	l2	tmax	tmax		
		mm	inch	frac.	wire / letter	mm	mm	mm	mm	inch		
9005950015900	1.590	1.590	0.0626	1/16		4.760	48.00	11.00	8.62	0.339	Straight	2

\*\*\* DISCLAIMER: Data on this PDF is subject to change at any time without notice.