

Use this number when searching for this item:

9005950027800

Center Drill, 7/64, HSS, Uncoated



>> Item Info

EDP #	9005950027800
Series	595
Order Code	2.780
Coating	Uncoated
Coolant Through	No
Cutting Direction	RH
Material	HSS
Point Angle	118°
Shank	Straight
Type	Center Drill

>> Features

- relieved cone
- for centre holes form B to US standards

>> Suggested Materials

- Aluminum
- Alloyed Steels
- Free Cutting Steels
- Tool Steels
- Stainless Steels
- Ti and Ti-alloys
- Cast Iron
- Brass
- Bronze
- Copper
- Magnesium
- Special Alloys
- Plastic
- Hardened Steels

>> Technical Specs

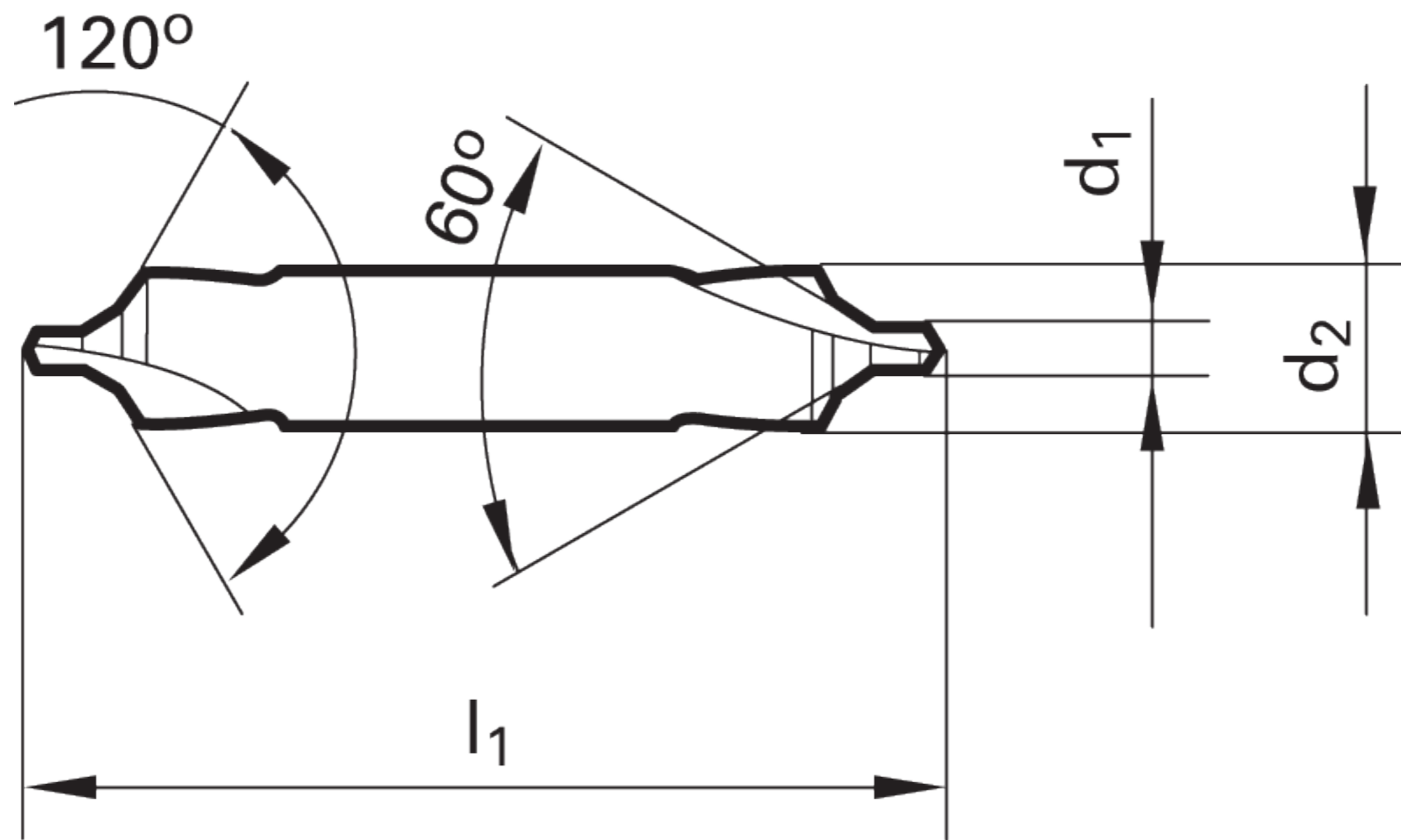

EDP #	Code No.	Cut Ø	Cut Ø	Cut Ø	Cut Ø	Shank Ø	OAL	Flute Length	Drilling Depth	Drilling Depth	Shank Type	Flutes
		d1	d1	d1	d1	d2	l1	l2	tmax	tmax		
		mm	inch	frac.	wire / letter	mm	mm	mm	mm	inch		
9005950027800	2.780	2.780	0.1094	7/64		7.940	54.00	19.00	14.83	0.584	Straight	2

*** DISCLAIMER: Data on this PDF is subject to change at any time without notice.