

Use this number when searching for this item:

## 9024790113000

### Drill, 11.3mm 5xD, RT 100 X, Carbide, nano-FIREX, Coolant through



#### >> Item Info

EDP #	9024790113000
Series	2479
Order Code	11.300
Coating	nano-FIREX
Coolant Through	Yes
Cutting Direction	RH
Drilling Depth	5xD
Material	Carbide
Point Angle	140°
Shank	HA
Type	RT 100 X
Tolerance	m7

#### >> Features

- facet point grind
- main cutting edge form straight
- optimized cutting geometry

#### >> Suggested Materials

- Aluminum
- Alloyed Steels
- Free Cutting Steels
- Tool Steels
- Stainless Steels
- Ti and Ti-alloys
- Cast Iron
- Brass
- Bronze
- Magnesium
- Special Alloys
- Hardened Steels

#### >> Technical Specs

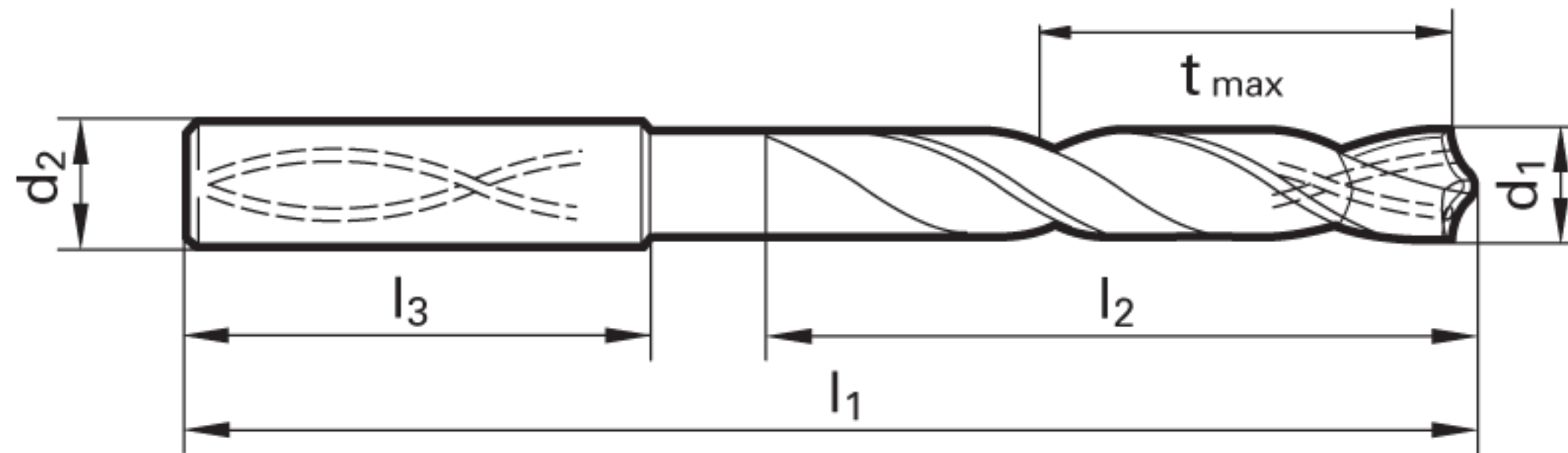

EDP #	Code No.	Cut Ø	Cut Ø	Cut Ø	Cut Ø	Shank Ø	OAL	Flute Length	Drilling Depth	Drilling Depth	Shank Length	Shank Type	Flutes
		d1	d1	d1	d1	d2	l1	l2	tmax	tmax	l3		
		mm	inch	frac.	wire / letter	mm	mm	mm	mm	inch	mm		
9024790113000	11.300	11.300	0.4449			12.00	118.00	71.00	54.05	2.128	45.00	Straight	2



**WARNING:**  
This product contains Cobalt, a chemical known to the State of California to cause cancer. For more information go to [www.P65Warnings.ca.gov](http://www.P65Warnings.ca.gov)

\*\*\* **DISCLAIMER:** Data on this PDF is subject to change at any time without notice.