

Use this number when searching for this item:

9040440085000

Drill, 8.5mm 7xD, RT 100 X, Carbide, nano-FIREX, Coolant through



>> Item Info

EDP #	9040440085000
Series	4044
Order Code	8.500
Coating	nano-FIREX
Coolant Through	Yes
Cutting Direction	RH
Drilling Depth	7xD
Material	Carbide
Point Angle	140°
Shank	HA
Type	RT 100 X
Tolerance	m7

>> Features

- facet point grind
- main cutting edge form straight
- optimized cutting geometry
- double margin

>> Suggested Materials

- Aluminum
- Alloyed Steels
- Free Cutting Steels
- Tool Steels
- Stainless Steels
- Ti and Ti-alloys
- Cast Iron
- Brass
- Bronze
- Magnesium
- Special Alloys
- Hardened Steels

>> Technical Specs

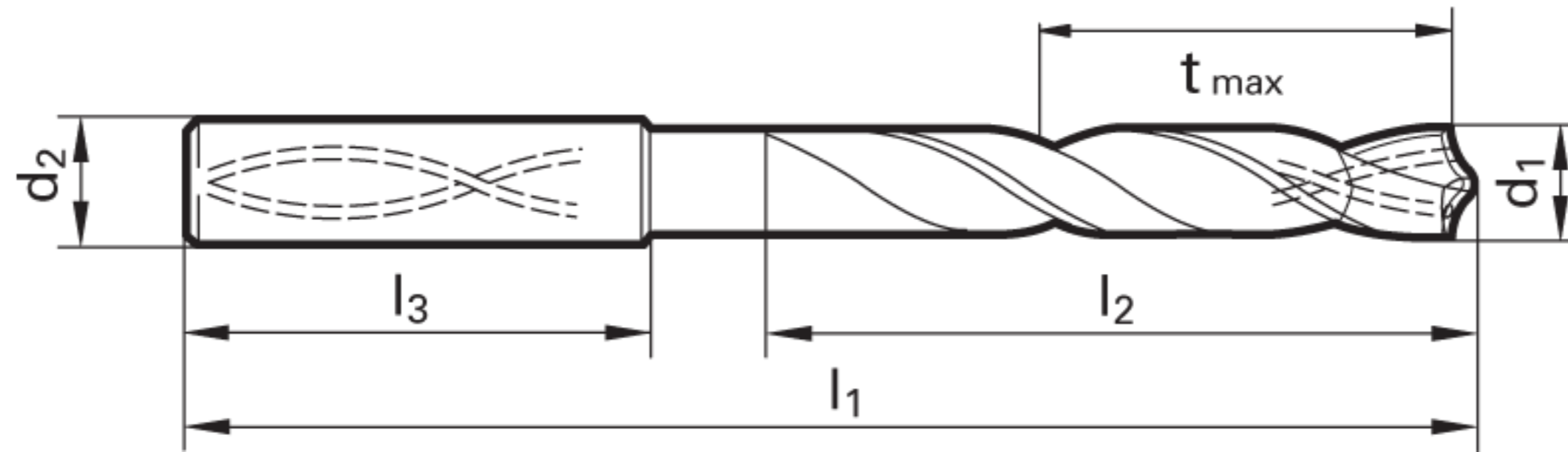

EDP #	Code No.	Cut Ø	Cut Ø	Cut Ø	Cut Ø	Shank Ø	OAL	Flute Length	Drilling Depth	Drilling Depth	Shank Length	Shank Type	Flutes
		d1	d1	d1	d1	d2	l1	l2	tmax	tmax	l3		
		mm	inch	frac.	wire / letter	mm	mm	mm	mm	inch	mm		
9040440085000	8.500	8.500	0.3346			10.00	131.00	87.00	74.25	2.923	40.00	Straight	2



WARNING:
This product contains Cobalt, a chemical known to the State of California to cause cancer. For more information go to www.P65Warnings.ca.gov

*** **DISCLAIMER:** Data on this PDF is subject to change at any time without notice.