

Use this number when searching for this item:

9056120095000

Drill, 9.5mm 7xD, RT 100 U, Carbide, nano-FIREX, Coolant through



>> Item Info

EDP #	9056120095000
Series	5612
Order Code	9.500
Coating	nano-FIREX
Coolant Through	Yes
Cutting Direction	RH
Drilling Depth	7xD
Material	Carbide
Point Angle	140°
Shank	HE
Type	RT 100 U
Tolerance	m7

>> Features

- facet point grind
- main cutting edge form straight
- optimized cutting geometry

>> Suggested Materials

- Aluminum
- Alloyed Steels
- Free Cutting Steels
- Tool Steels
- Stainless Steels
- Ti and Ti-alloys
- Cast Iron
- Brass
- Bronze
- Copper
- Magnesium
- Special Alloys
- Hardened Steels

>> Technical Specs

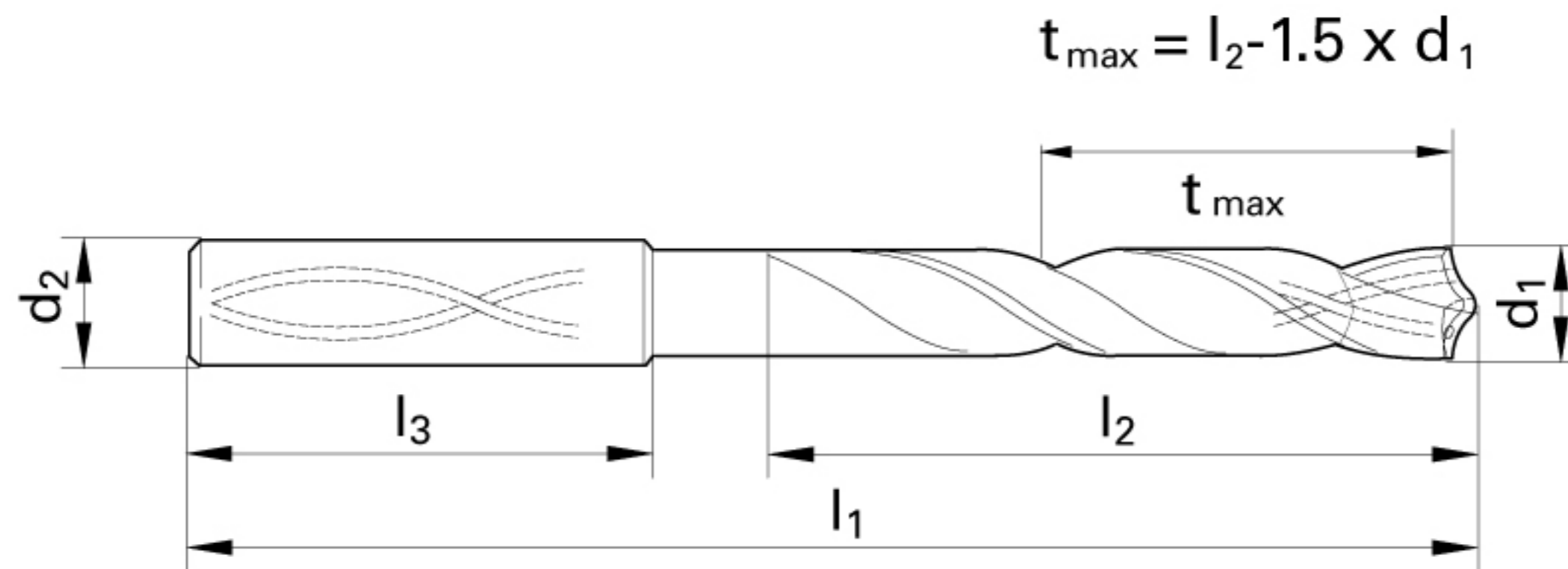

EDP #	Code No.	Cut Ø	Cut Ø	Cut Ø	Cut Ø	Shank Ø	OAL	Flute Length	Drilling Depth	Drilling Depth	Shank Length	Shank Type	Flutes
		d1	d1	d1	d1	d2	l1	l2	tmax	tmax	l3		
		mm	inch	frac.	wire / letter	mm	mm	mm	mm	inch	mm		
9056120095000	9.500	9.500	0.3740			10.00	139.00	95.00	80.75	3.179	40.00	whistle notch	2



WARNING:
This product contains Cobalt, a chemical known to the State of California to cause cancer. For more information go to www.P65Warnings.ca.gov

*** **DISCLAIMER:** Data on this PDF is subject to change at any time without notice.