

Use this number when searching for this item:

9076350620400

HT 800 C-Sink Insert, CPGT060204R, Uncoated

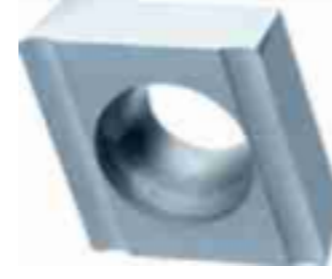

>> Item Info

EDP #	9076350620400
Series	7635
Order Code	62.040
Coating	Uncoated
Coolant Through	No
Cutting Direction	RH
Material	Carbide
Point Angle	°
Shank	N/A
Type	HT 800 C-Sink Insert

>> Features

- clamping screws art. no. 6128 not included

>> Suggested Materials

- Aluminum
- Alloyed Steels
- Free Cutting Steels
- Tool Steels
- Stainless Steels
- Ti and Ti-alloys
- Cast Iron
- Brass
- Bronze
- Copper
- Magnesium
- Special Alloys
- Plastic
- Hardened Steels

>> Technical Specs

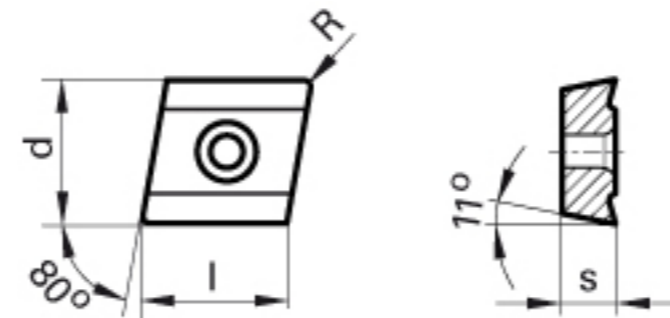

EDP #	Code No.	Cut Ø		Cut Ø		Shank Ø	OAL	Flute Length		Drilling Depth		Shank Length	Shank Type	Flutes
		d1	d1	d1	d1	d2	l1	l2	tmax	tmax	l3			
		mm	inch	frac.	wire / letter	mm	mm	mm	mm	inch	mm			
9076350620400	62.040	62.040					2.38					50.00	N/A	



WARNING:
This product contains Cobalt, a chemical known to the State of California to cause cancer. For more information go to www.P65Warnings.ca.gov

*** **DISCLAIMER:** Data on this PDF is subject to change at any time without notice.