

Use this number when searching for this item:

## 9085200195000

### Drill, 19.5mm 3xD, RT 100 HF, Carbide, nano-Si, Coolant through



#### >> Item Info

EDP #	9085200195000
Series	8520
Order Code	19.500
Coating	nano-Si
Coolant Through	Yes
Cutting Direction	RH
Drilling Depth	3xD
Material	Carbide
Point Angle	140°
Shank	HA
Type	RT 100 HF
Tolerance	m7

#### >> Features

- relieved cone
- main cutting edge is slightly concave
- optimized cutting geometry
- double margin

#### >> Suggested Materials

- Tool Steels
- Ti and Ti-alloys
- Special Alloys
- Hardened Steels

#### >> Technical Specs

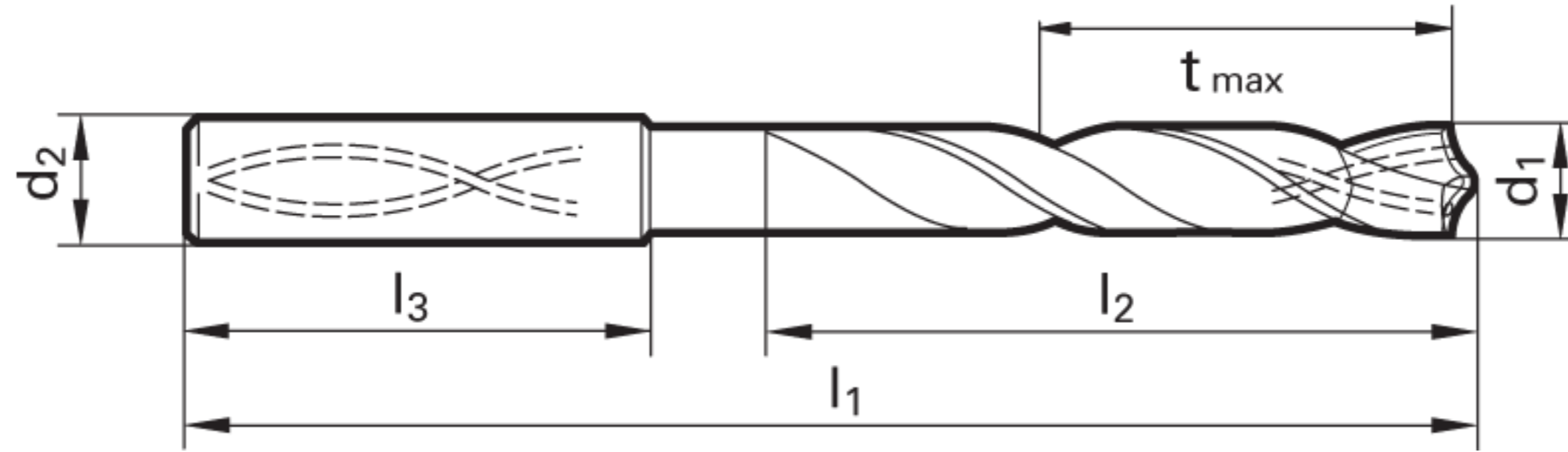

EDP #	Code No.	Cut Ø	Cut Ø	Cut Ø	Cut Ø	Shank Ø	OAL	Flute Length	Drilling Depth	Drilling Depth	Shank Length		
		d1	d1	d1	d1	d2	l1	l2	tmax	tmax	l3	Shank Type	Flutes
		mm	inch	frac.	wire / letter	mm	mm	mm	mm	inch	mm		
9085200195000	19.500	19.500	0.7677			20.00	131.00	79.00	49.75	1.959	50.00	Straight	2



**WARNING:**  
This product contains Cobalt, a chemical known to the State of California to cause cancer. For more information go to [www.P65Warnings.ca.gov](http://www.P65Warnings.ca.gov)

\*\*\* **DISCLAIMER:** Data on this PDF is subject to change at any time without notice.