

Use this number when searching for this item:

## 9085210097000

### Drill, 9.7mm 5xD, RT 100 HF, Carbide, nano-Si, Coolant through



#### >> Item Info

|                   |               |
|-------------------|---------------|
| EDP #             | 9085210097000 |
| Series            | 8521          |
| Order Code        | 9.700         |
| Coating           | nano-Si       |
| Coolant Through   | Yes           |
| Cutting Direction | RH            |
| Drilling Depth    | 5xD           |
| Material          | Carbide       |
| Point Angle       | 140°          |
| Shank             | HA            |
| Type              | RT 100 HF     |
| Tolerance         | m7            |

#### >> Features

- relieved cone
- main cutting edge is slightly concave
- optimized cutting geometry
- double margin

#### >> Suggested Materials

- Tool Steels
- Ti and Ti-alloys
- Special Alloys
- Hardened Steels

#### >> Technical Specs

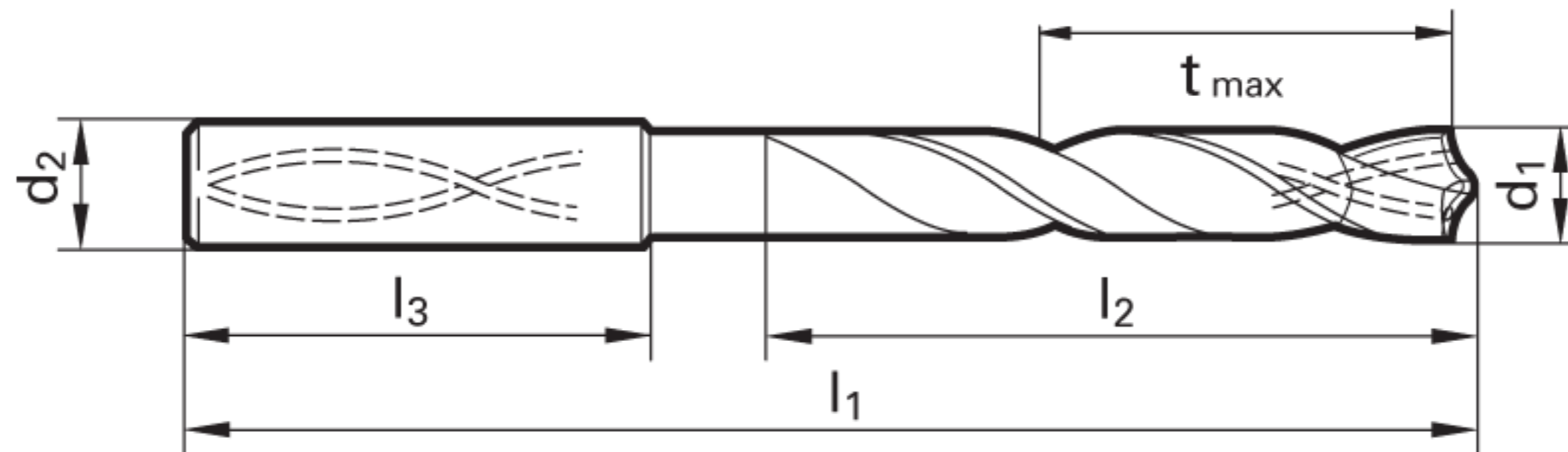

| EDP #         | Code No. | Cut Ø | Cut Ø  | Cut Ø | Cut Ø         | Shank Ø | OAL    | Flute Length | Drilling Depth | Drilling Depth | Shank Length | Shank Type | Flutes |
|---------------|----------|-------|--------|-------|---------------|---------|--------|--------------|----------------|----------------|--------------|------------|--------|
|               |          | d1    | d1     | d1    | d1            | d2      | l1     | l2           | tmax           | tmax           | l3           |            |        |
|               |          | mm    | inch   | frac. | wire / letter | mm      | mm     | mm           | mm             | inch           | mm           |            |        |
| 9085210097000 | 9.700    | 9.700 | 0.3819 |       |               | 10.00   | 103.00 | 61.00        | 46.45          | 1.829          | 40.00        | Straight   | 2      |



**WARNING:**  
This product contains Cobalt, a chemical known to the State of California to cause cancer. For more information go to [www.P65Warnings.ca.gov](http://www.P65Warnings.ca.gov)

\*\*\* **DISCLAIMER:** Data on this PDF is subject to change at any time without notice.