

Use this number when searching for this item:

9085210106000

Drill, 10.6mm 5xD, RT 100 HF, Carbide, nano-Si, Coolant through



>> Item Info

| | |
|-------------------|---------------|
| EDP # | 9085210106000 |
| Series | 8521 |
| Order Code | 10.600 |
| Coating | nano-Si |
| Coolant Through | Yes |
| Cutting Direction | RH |
| Drilling Depth | 5xD |
| Material | Carbide |
| Point Angle | 140° |
| Shank | HA |
| Type | RT 100 HF |
| Tolerance | m7 |

>> Features

- relieved cone
- main cutting edge is slightly concave
- optimized cutting geometry
- double margin

>> Suggested Materials

- Tool Steels
- Ti and Ti-alloys
- Special Alloys
- Hardened Steels

>> Technical Specs

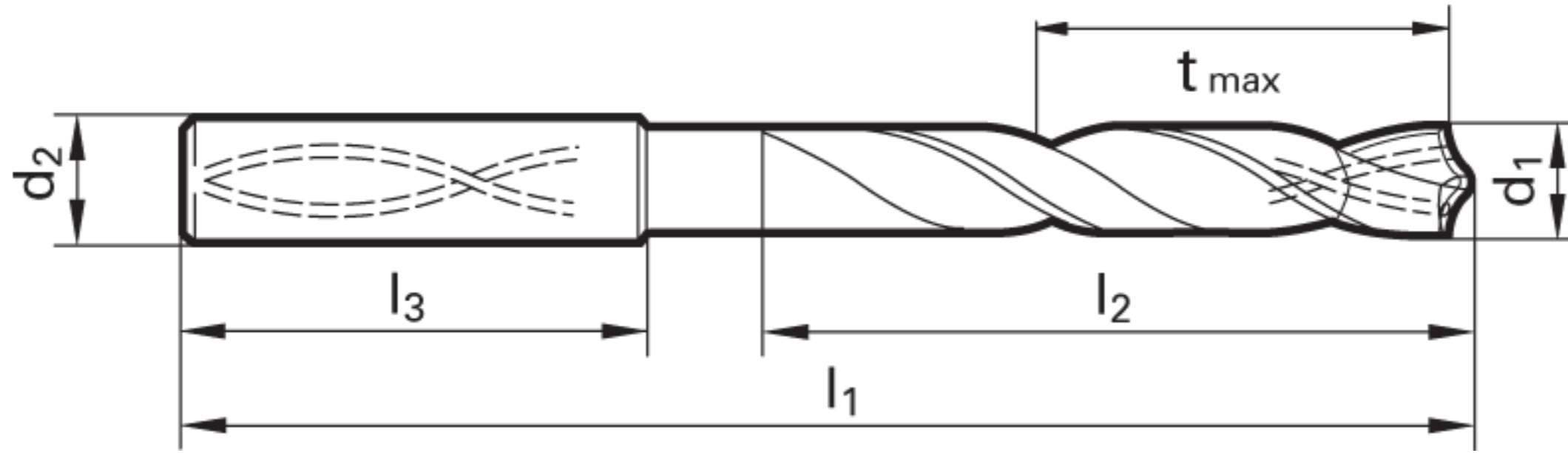

| EDP # | Code No. | Cut Ø | Cut Ø | Cut Ø | Cut Ø | Shank Ø | OAL | Flute Length | Drilling Depth | Drilling Depth | Shank Length | Shank Type | Flutes |
|---------------|----------|--------|--------|-------|---------------|---------|--------|--------------|----------------|----------------|--------------|------------|--------|
| | | d1 | d1 | d1 | d1 | d2 | l1 | l2 | tmax | tmax | l3 | | |
| | | mm | inch | frac. | wire / letter | mm | mm | mm | mm | inch | mm | | |
| 9085210106000 | 10.600 | 10.600 | 0.4173 | | | 12.00 | 118.00 | 71.00 | 55.10 | 2.169 | 45.00 | Straight | 2 |



WARNING:
This product contains Cobalt, a chemical known to the State of California to cause cancer. For more information go to www.P65Warnings.ca.gov

*** **DISCLAIMER:** Data on this PDF is subject to change at any time without notice.