

Use this number when searching for this item:

9085210125000

Drill, 12.5mm 5xD, RT 100 HF, Carbide, nano-Si, Coolant through



>> Item Info

EDP #	9085210125000
Series	8521
Order Code	12.500
Coating	nano-Si
Coolant Through	Yes
Cutting Direction	RH
Drilling Depth	5xD
Material	Carbide
Point Angle	140°
Shank	HA
Type	RT 100 HF
Tolerance	m7

>> Features

- relieved cone
- main cutting edge is slightly concave
- optimized cutting geometry
- double margin

>> Suggested Materials

- Tool Steels
- Ti and Ti-alloys
- Special Alloys
- Hardened Steels

>> Technical Specs

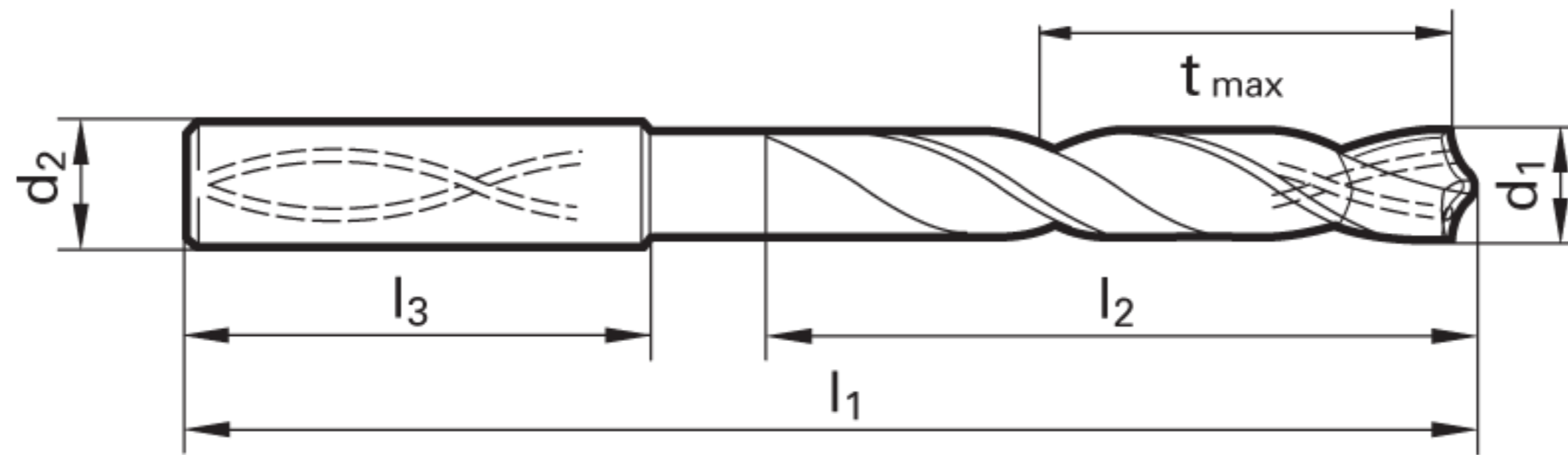

EDP #	Code No.	Cut Ø	Cut Ø	Cut Ø	Cut Ø	Shank Ø	OAL	Flute Length	Drilling Depth	Drilling Depth	Shank Length	Shank Type	Flutes
		d1	d1	d1	d1	d2	l1	l2	tmax	tmax	l3		
		mm	inch	frac.	wire / letter	mm	mm	mm	mm	inch	mm		
9085210125000	12.500	12.500	0.4921			14.00	124.00	77.00	58.25	2.293	45.00	Straight	2



WARNING:
This product contains Cobalt, a chemical known to the State of California to cause cancer. For more information go to www.P65Warnings.ca.gov

*** **DISCLAIMER:** Data on this PDF is subject to change at any time without notice.