

HAIMER®
Quality Wins.

BASIC LINE

REDUCED TO THE ESSENTIALS



www.haimer-usa.com

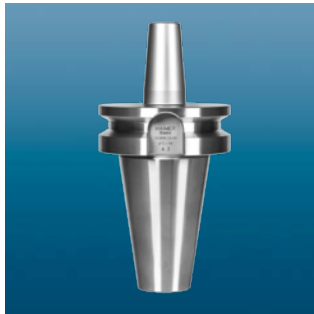

Basic Line	Page
Basic CAT40 Shrink Fit Chuck	4
Basic CAT50 Shrink Fit Chuck	5
Basic BT30 Shrink Fit Chuck	6
Basic BT40 Shrink Fit Chuck	7
Basic BT50 Shrink Fit Chuck	8
Basic HSK-A63 Shrink Fit Chuck	9
Basic HSK-A100 Shrink Fit Chuck	10
Basic HAIMER CAPTO™ C6 Shrink Fit Chuck	11
Basic SK40 Shrink Fit Chuck	12
Basic SK50 Shrink Fit Chuck	13

Why Shrink Fit?

Features	Benefits
<ul style="list-style-type: none"> 360° clamping, multiple planes Precision bore, no wear components No mechanical moving parts Induction shrink technology Tapered design, AT3 taper No screws, nuts or threads 	<ul style="list-style-type: none"> Highest gripping torque < 0.00012" (3 μm) runout Repeatable clamping Tool changes less than 5 seconds on average Carbide and HSS shrinkable Rigid interface Repeatable balance (G2.5@ 25,000 RPM)

HAIMER Shrink Fit Chucks	NEW	Basic Series	Standard Series	Power Series	Heavy Duty Series
					
0.00012" T.I.R. Accuracy	✓	✓	✓	✓	
Balance G2.5 at 25,000 RPM	✓	✓	✓	✓	
Certified AT3 Taper	✓	✓	✓	✓	
Plumbed Cool-Jet Bores (Through-Holder Coolant Delivery)		✓	✓	✓	
Balancing Threads (For Fine Balancing)		✓	✓	✓	
Safe-Lock™ Optional		✓	✓	✓	
Reinforced Body (For Higher MRR in Roughing)			✓	✓	
> 1 ¼" (32 mm) Cutter Capacity				✓	

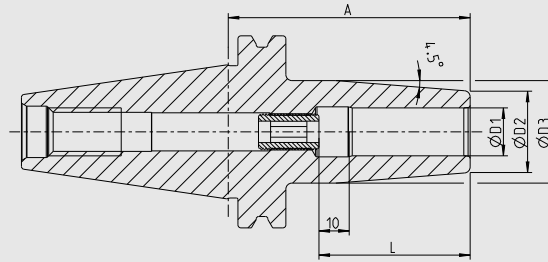

CERTIFICATE OF QUALITY

<input checked="" type="checkbox"/> Chuck body fine balanced G2.5 25,000 rpm
<input checked="" type="checkbox"/> All functional surfaces fine machined
<input checked="" type="checkbox"/> Taper tolerance AT3
<input checked="" type="checkbox"/> T.I.R. < 0.00012" (3 µm)
<input checked="" type="checkbox"/> Coolant supply form AD

Use:

Shrink fit chuck suitable for all shrinking units.

CAT 40 FORM AD

Form AD means: central coolant supply through retention knob.

- Heat resistant hot-working steel
- For HSS (1/4"–1"; 6–25 mm) and solid carbide tools
- Shank tolerance h6
- Included in delivery: Shrink fit chuck with back-up screw
- Balanceable by rings, milling or drilling

INCH	Clamping Ø D1 [inch]	1/8"	3/16"	1/4"	5/16"	3/8"	7/16"	1/2"
	Ø D2 [inch]	0.39	0.39	0.83	0.83	0.94	0.94	0.94
	Ø D3 [inch]	—	—	1.06	1.06	1.26	1.26	1.26
	L [inch]	0.35	0.47	1.42	1.42	1.65	1.65	1.85
Gage length A [inch]	short	3.15 ¹⁾	3.15 ¹⁾	3.15	3.15	3.15	3.15	3.15
Order No.	40.840...	.1/8Z.00	.3/16Z.00	.1/4Z.00	.5/16Z.00	.3/8Z.00	.7/16Z.00	.1/2Z.00

INCH	Clamping Ø D1 [inch]	9/16"	5/8"	11/16"	3/4"	7/8"	1"
	Ø D2 [inch]	1.06	1.06	1.30	1.30	1.30	1.73
	Ø D3 [inch]	1.34	1.34	1.59	1.65	1.65	2.09
	L [inch]	1.85	1.97	1.97	2.05	2.05	2.28
Gage length A [inch]	short	3.15	3.15	3.15	3.15	3.15	3.94
Order No.	40.840...	.9/16Z.00	.5/8Z.00	11/16Z.00	.3/4Z.00	7/8Z.00	.1Z.00

METRIC	Clamping Ø D1 [mm]	03	04	06	08	10	12	14	16	18	20	25
	Ø D2 [mm]	10	10	21	21	24	24	27	27	33	33	44
	Ø D3 [mm]	—	—	27	27	32	32	34	34	40,5	42	53
	L [mm]	09	12	36	36	42	47	47	50	50	52	58
Gage length A [mm]	short	80 ¹⁾	80 ¹⁾	80	80	80	80	80	80	80	80	100
Order No.	40.840...	.03.00	.04.00	.06.00	.08.00	.10.00	.12.00	.14.00	.16.00	.18.00	.20.00	.25.00

Accessories

Pull studs



See Tool Holder Catalog

Back-up screws



1) Without back-up screw

BASIC SHRINK FIT CHUCK CAT50 · ASME B5.50

CERTIFICATE OF QUALITY

<input checked="" type="checkbox"/>	Chuck body fine balanced G2.5 25,000 rpm
<input checked="" type="checkbox"/>	All functional surfaces fine machined
<input checked="" type="checkbox"/>	Taper tolerance AT3
<input checked="" type="checkbox"/>	T.I.R. < 0.00012" (3 µm)
<input checked="" type="checkbox"/>	Coolant supply form AD

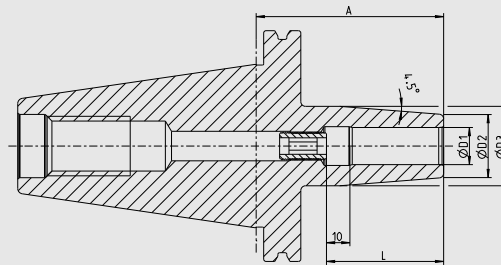

Use:

Shrink fit chuck suitable for all shrinking units.

CAT 50 FORM AD

Form AD means: central coolant supply through retention knob.

- Heat resistant hot-working steel
- For HSS and solid carbide tools
- Shank tolerance h6
- Included in delivery: Shrink fit chuck with back-up screw
- Balanceable by rings, milling or drilling

INCH	Clamping Ø D1 [inch]	1/4"	5/16"	3/8"	7/16"	1/2"	9/16"
	ØD2 [inch]	0.83	0.83	0.94	0.95	0.94	1.06
	ØD3 [inch]	1.06	1.06	1.26	1.26	1.26	1.34
	L [inch]	1.42	1.42	1.65	1.65	1.85	1.85
Gage length A [inch]	short	3.15	3.15	3.15	3.15	3.15	3.15
Order No.	50.840...	.1/4Z.00	.5/16Z.00	.3/8Z.00	.7/16Z.00	.1/2Z.00	.9/16Z.00

INCH	Clamping Ø D1 [inch]	5/8"	3/4"	7/8"	1"	1 1/4"
	ØD2 [inch]	1.06	1.30	1.30	1.73	1.73
	ØD3 [inch]	1.34	1.65	1.65	2.09	2.09
	L [inch]	1.97	2.05	2.05	2.28	2.28
Gage length A [inch]	short	3.15	3.15	3.15	3.94	3.94
Order No.	50.840...	.5/8Z.00	.3/4Z.00	.7/8Z.00	.1Z.00	.11/4Z.00

METRIC	Clamping Ø D1 [mm]	06	08	10	12	14	16	18	20	25	32
	Ø D2 [mm]	21	21	24	24	27	27	33	33	44	44
	Ø D3 [mm]	27	27	32	32	34	34	42	42	53	53
	L [mm]	36	36	42	47	47	50	50	52	58	58
Gage length A [mm]	short	80	80	80	80	80	80	80	80	100	100
Order No.	50.840...	.06.00	.08.00	.10.00	.12.00	.14.00	.16.00	.18.00	.20.00	.25.00	.32.00

Accessories

Pull studs



See Tool Holder Catalog

Back-up screws



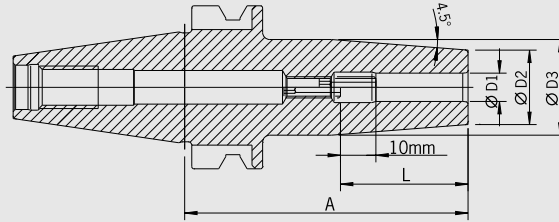

CERTIFICATE OF QUALITY

- Chuck body fine balanced
G2.5 25,000 rpm
- All functional surfaces fine machined
- Taper tolerance AT3
- T.I.R. < 0.00012" (3 µm)
- Coolant supply form AD

Use:

Suitable for all shrinking units.

JIS B 6339 BT30 Form AD

Form AD means: central coolant supply through retention knob.

- Heat resistant hot-working steel
- For HSS (1/4" - 3/4"; 6-20 mm) and solid carbide tools
- Shank tolerance h6
- Included in delivery: Shrink fit chuck with back-up screw
- Balanceable by rings, milling or drilling

INCH	Clamping Ø D1 [inch]	1/8"	3/16"	1/4"	5/16"	3/8"	1/2"	5/8"	3/4"
	Ø D2 [inch]	0.39	0.39	0.83	0.83	0.94	0.94	1.06	1.30
	Ø D3 [inch]	—	—	1.06	1.06	1.26	1.26	1.34	1.65
	L [inch]	0.35	0.59	1.42	1.42	1.65	1.85	1.97	2.05
Gage length A [inch]	short	3.15 ¹⁾	3.15 ¹⁾	3.15	3.15	3.15	3.15	3.15	3.54
Order No.	30.640...	.1/8Z.00	3/16Z.00	.1/4Z.00	.5/16Z.00	.3/8Z.00	.1/2Z.00	.5/8Z.00	.3/4Z.00

METRIC	Clamping Ø D1 [mm]	06	08	10	12	16	20
	Ø D2 [mm]	21	21	24	24	27	33
	Ø D3 [mm]	27	27	32	32	34	40.5
	L [mm]	36	36	42	47	50	52
Gage length A [mm]	short	80	80	80	80	80	90
Order No.	30.640...	.06.00	.08.00	.10.00	.12.00	.16.00	.20.00

Accessories

Pull studs



See Tool Holder Catalog

Back-up screws



1) Without back-up screw

BASIC SHRINK FIT CHUCK BT40 · JIS B 6339

CERTIFICATE OF QUALITY	
<input checked="" type="checkbox"/>	Chuck body fine balanced G2.5 25,000 rpm
<input checked="" type="checkbox"/>	All functional surfaces fine machined
<input checked="" type="checkbox"/>	Taper tolerance AT3
<input checked="" type="checkbox"/>	T.I.R. < 0.00012" (3 µm)
<input checked="" type="checkbox"/>	Coolant supply form AD

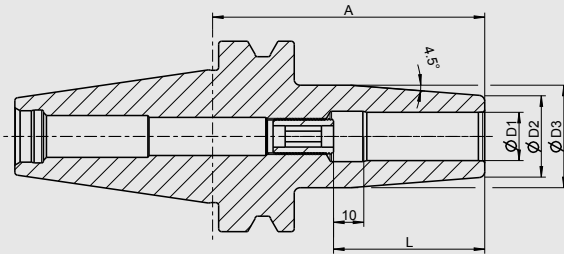

Use:

Suitable for all shrinking units.

JIS B 6339 BT40 form AD

Form AD means: central coolant supply through retention knob.

- Heat resistant hot-working steel
- For HSS and solid carbide tools
- Shank tolerance h6
- Included in delivery: Shrink fit chuck with back-up screw
- Balanceable by rings, milling or drilling

INCH	Clamping Ø D1 [inch]	1/4"	5/16"	3/8"	1/2"	5/8"	3/4"	1"
	ØD2 [inch]	0.83	0.83	0.94	0.94	1.06	1.30	1.73
	ØD3 [inch]	1.06	1.06	1.26	1.26	1.34	1.65	2.09
	L [inch]	1.42	1.42	1.65	1.85	1.97	2.05	2.28
Gage length A [inch]	short	3.54	3.54	3.54	3.54	3.54	3.54	3.94
Order No.	40.640...	.1/4Z.00	.5/16Z.00	.3/8Z.00	.1/2Z.00	.5/8Z.00	.3/4Z.00	.1Z.00

METRIC	Clamping Ø D1 [mm]	06	08	10	12	16	20	25
	Ø D2 [mm]	21	21	24	24	27	33	44
	Ø D3 [mm]	27	27	32	32	34	42	53
	L [mm]	36	36	42	47	50	52	58
Gage length A [mm]	short	90	90	90	90	90	90	100
Order No.	40.640...	.06.00	.08.00	.10.00	.12.00	.16.00	.20.00	.25.00

Accessories

Pull studs



See Tool Holder Catalog

Back-up screws



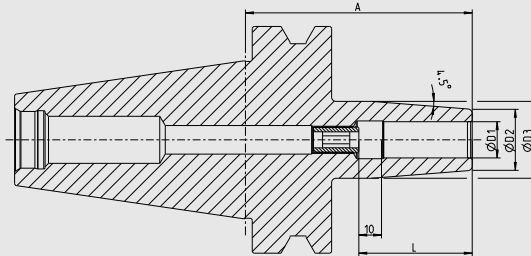

CERTIFICATE OF QUALITY	
<input checked="" type="checkbox"/>	Chuck body fine balanced G2.5 25,000 rpm
<input checked="" type="checkbox"/>	All functional surfaces fine machined
<input checked="" type="checkbox"/>	Taper tolerance AT3
<input checked="" type="checkbox"/>	T.I.R. < 0.00012" (3 µm)
<input checked="" type="checkbox"/>	Coolant supply form AD

Use:

Suitable for all shrinking units.

JIS B 6339 BT50 form AD

Form AD means: central coolant supply through retention knob.

- Heat resistant hot-working steel
- For HSS and solid carbide tools
- Shank tolerance h6
- Included in delivery: Shrink fit chuck with back-up screw
- Balanceable by rings, milling or drilling

METRIC	Clamping Ø D1 [mm]	06	08	10	12	16	20	25
	Ø D2 [mm]	21	21	24	24	27	33	44
	Ø D3 [mm]	27	27	32	32	34	42	53
	L [mm]	36	36	42	47	50	52	58
Gage length A [mm]	short	100	100	100	100	100	100	100
Order No.	50.640...	.06.00	.08.00	.10.00	.12.00	.16.00	.20.00	.25.00



Accessories

Pull studs



Back-up screws



BASIC SHRINK FIT CHUCK HSK-A63 · DIN 69893-1

CERTIFICATE OF QUALITY

- Chuck body fine balanced
G2.5 25,000 rpm
- All functional surfaces fine machined
- T.I.R. < 0.00012" (3 µm)
- More accurate than DIN

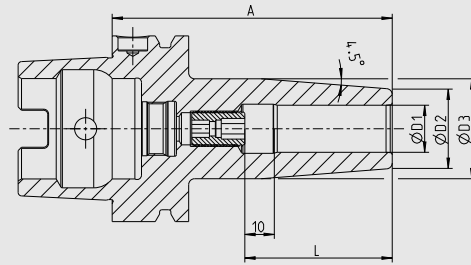

Use:

Shrink fit chuck suitable for all shrinking units.

DIN 69893-1

- Heat resistant hot-working steel
- For HSS (1/4"-1"; 6-25 mm) and solid carbide tools
- Shank tolerance h6
- Included in delivery: Shrink fit chuck with back-up screw
- Balanceable by rings, milling or drilling

INCH	Clamping Ø D1 [inch]	1/8"	3/16"	1/4"	5/16"	3/8"	1/2"	5/8"	3/4"	1"
	ØD2 [inch]	0.39	0.39	0.83	0.83	0.94	0.94	1.06	1.30	1.73
	ØD3 [inch]	—	—	1.06	1.06	1.26	1.26	1.34	1.65	2.09
	L [inch]	0.35	0.47	1.42	1.42	1.65	1.85	1.97	2.05	2.28
Gage length A [inch]	short	3.15 ¹⁾	3.15 ¹⁾	3.15	3.15	3.35	3.54	3.74	3.94	4.53
Order No.	A63.140...	.1/8Z.00	.3/16Z.00	.1/4Z.00	.5/16Z.00	.3/8Z.00	.1/2Z.00	.5/8Z.00	.3/4Z.00	.1Z.00

METRIC	Clamping Ø D1 [inch]	03	04	06	08	10	12	16	20	25
	Ø D2 [mm]	10	10	21	21	24	24	27	33	44
	Ø D3 [mm]	—	—	27	27	32	32	34	42	53
	L [mm]	09	12	36	36	42	47	50	52	58
Gage length A [mm]	short	80 ¹⁾	80 ¹⁾	80	80	85	90	95	100	115
Order No.	A63.140...	.03.00	.04.00	.06.00	.08.00	.10.00	.12.00	.16.00	.20.00	.25.00

Accessories

Coolant tube



See Tool Holder Catalog

Back-up screws



1) Without back-up screw

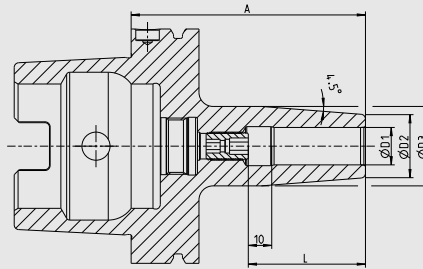

CERTIFICATE OF QUALITY

- Chuck body fine balanced
G2.5 25,000 rpm
- All functional surfaces fine machined
- T.I.R. < 0.00012" (3 µm)
- More accurate than DIN

Use:

Shrink fit chuck suitable for all shrinking units.

DIN 69893-1

- Heat resistant hot-working steel
- For HSS and solid carbide tools
- Shank tolerance h6
- Included in delivery: Shrink fit chuck with back-up screw
- Balanceable by rings, milling or drilling

INCH	Clamping Ø D1 [inch]	1/4"	5/16"	3/8"	1/2"	5/8"	3/4"	1"
	ØD2 [inch]	0.83	0.83	0.94	0.94	1.06	1.30	1.73
	ØD3 [inch]	1.06	1.06	1.26	1.26	1.34	1.65	2.09
	L [inch]	1.42	1.42	1.65	1.85	1.97	2.05	2.28
Gage length A [inch]	short	3.35	3.35	3.54	3.74	3.94	4.13	4.53
Order No.	A10.140...	.1/4Z.00	.5/16Z.00	.3/8Z.00	.1/2Z.00	.5/8Z.00	.3/4Z.00	.1Z.00

METRIC	Clamping Ø D1 [inch]	06	08	10	12	16	20	25
	Ø D2 [mm]	21	21	24	24	27	33	44
	Ø D3 [mm]	27	27	32	32	34	42	53
	L [mm]	36	36	42	47	50	52	58
Gage length A [mm]	short	85	85	90	95	100	105	115
Order No.	A10.140...	.06.00	.08.00	.10.00	.12.00	.16.00	.20.00	.25.00

Accessories

Coolant tube



See Tool Holder Catalog

Back-up screws



BASIC SHRINK FIT CHUCK HAIMER CAPTO™ C6 · ISO 26623-1

CERTIFICATE OF QUALITY

- Chuck body fine balanced
G2.5 25,000 rpm
- All functional surfaces fine machined
- T.I.R. < 0.00012" (3 µm)
- More accurate than DIN

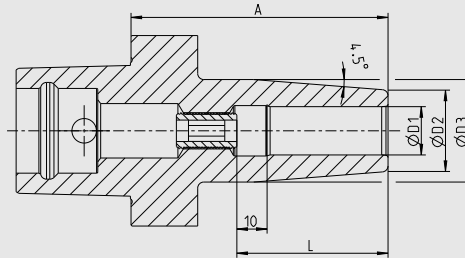

Use:

Shrink fit chuck suitable for all shrinking units.

- Interface with a unique tapered polygon and flange location face
- Exact positioning in the spindle
- Highest runout accuracy, torque and rigidity
- Innovative modular tool system with highest precision
- Suitable for both turning and milling centres
- Heat resistant hot-working steel
- For HSS (1/4" - 1"; 6-25 mm) and solid carbide tools
- Shank tolerance h6
- Included in delivery: Shrink fit chuck with back-up screw
- Balanceable by rings, milling or drilling

INCH	Clamping Ø D1 [mm]	1/4"	3/8"	1/2"	5/8"	3/4"	1"
	Ø D2 [mm]	0.83	0.94	0.94	1.06	1.30	1.73
	Ø D3 [mm]	1.06	1.26	1.26	1.34	1.65	2.09
	L [mm]	1.42	1.65	1.85	1.97	2.05	2.28
Gage length A [inch]	short 	3.15	3.15	3.15	3.35	3.35	3.54
Order No.	CC6.140...	.1/4Z.00	.3/8Z.00	.1/2Z.00	.5/8Z.00	.3/4Z.00	.1Z.00

METRIC	Clamping Ø D1 [mm]	03	04	05	06	08	10	12	16	20	25
	Ø D2 [mm]	10	10	10	21	21	24	24	27	33	44
	Ø D3 [mm]	—	—	—	27	27	32	32	34	42	53
	L [mm]	09	12	15	36	36	42	47	50	52	58
Gage Length A [mm]	short 	80 ¹⁾	80 ¹⁾	80 ¹⁾	80	80	80	80	85	85	90
Order No.	CC6.140...	.03.00	.04.00	.05.00	.06.00	.08.00	.10.00	.12.00	.16.00	.20.00	.25.00

Accessories

Back-up screws



See Tool Holder Catalog

1) Without back-up screw

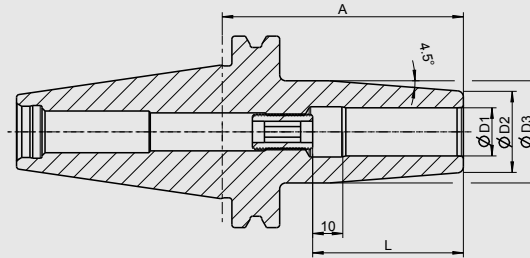

CERTIFICATE OF QUALITY

- Chuck body fine balanced
G2.5 25,000 rpm
- All functional surfaces fine machined
- T.I.R. < 0.00012" (3 µm)
- Coolant supply form AD

Use:

Suitable for all shrinking units.

With taper **SK40 form AD** DIN 69871.

Form AD means: central coolant supply through retention knob.

- Heat resistant hot-working steel
- For HSS and solid carbide tools
- Shank tolerance h6
- Included in delivery: Shrink fit chuck with back-up screw
- Balanceable by rings, milling or drilling

METRIC	Clamping Ø D1 [mm]	06	08	10	12	16	20	25
	Ø D2 [mm]	21	21	24	24	27	33	44
	Ø D3 [mm]	27	27	32	32	34	42	53
	L [mm]	36	36	42	47	50	52	58
Gage Length A [mm]	short	80	80	80	80	80	80	100
Order No.	40.440...	.06.00	.08.00	.10.00	.12.00	.16.00	.20.00	.25.00

Accessories

Pull studs



See Tool Holder Catalog

Back-up screws



BASIC SHRINK FIT CHUCK SK50 · DIN 69871

CERTIFICATE OF QUALITY

- Chuck body fine balanced
G2.5 25,000 rpm
- All functional surfaces fine machined
- T.I.R. < 0.00012" (3 µm)
- Coolant supply form AD

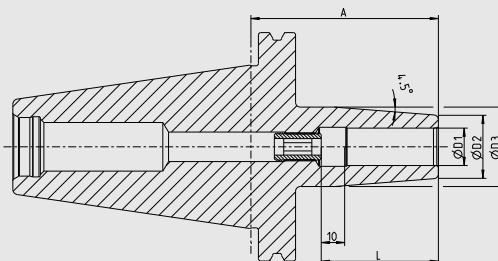

Use:

Suitable for all shrinking units.

With taper **SK50 form AD** DIN 69871.

Form AD means: central coolant supply through retention knob.

- Heat resistant hot-working steel
- For HSS and solid carbide tools
- Shank tolerance h6
- Included in delivery: Shrink fit chuck with back-up screw
- Balanceable by rings, milling or drilling

METRIC	Clamping Ø D1 [mm]	06	08	10	12	16	20	25
	Ø D2 [mm]	21	21	24	24	27	33	44
	Ø D3 [mm]	27	27	32	32	34	42	53
	L [mm]	36	36	42	47	50	52	58
Gage Length A [mm]	short	80	80	80	80	80	80	100
Order No.	50.440...	.06.00	.08.00	.10.00	.12.00	.16.00	.20.00	.25.00

Accessories

Pull studs



See Tool Holder Catalog

Back-up screws



HAIMER Shrink Fit can give you the edge that will allow you to sustain a long-term competitive advantage for your company.

1. Unsurpassed machining accuracy

We guarantee 0.00012" runout at 3xD. This degree of accuracy is consistently repeatable for any number of operators from shift to shift.

2. Slim profiles

HAIMER Shrink Fit tool holders have very slim profiles. They can also be modified to a straight-walled design if needed in order to prevent tool holder collision with the workpiece.

3. Gripping torque

Our shrink fit chucks grip the cutting tool 360° around the shank on multiple planes, delivering very high gripping torque that prevents chatter during roughing or finishing operations.

4. Consistency of setup

A unique benefit of HAIMER shrink fit is that it eliminates any variation between tool changes. Removing these variables means regardless of the operator and their experience level, you will get repeatable uniformity in tooling setup and equally consistent results.

5. Extended reach options

Shrink fit extensions provide many options. For example, when machining deep cavities, you can place shrink fit extensions into standard shrink fit chucks, getting unsurpassed gage lengths with minimal runout.

6. Balance accuracy and repeatability

We hold our shrink fit holders to the highest balance accuracy standards (G2.5 @ 25,000 RPM). Since shrink fit holders have no moving parts, it offers the best balance repeatability of any tool holding system on the market.

7. Reduction of tool changing time and less tool holder accessory inventory

Nothing beats the tool change time of our shrink fit chucks when combined with our Power Clamp shrink fit machines. Tool changes can be done in less than 5 seconds.

8. Clean bores

Runout accuracy is often compromised if contaminants are introduced to the bore of a tool holder during machining. A shrink fit chuck is a sealed system by design. This minimizes the introduction of contaminants.

9. Coolant options

Our shrink fit chucks are available with a variety of coolant options, including our Cool Jet and Cool Flash technology, which delivers coolant down to the cutting edge of the tool. This helps clean out chips and can aid in providing better part finishes.

10. Availability

All of our products are available and stocked locally for North American customers and come in a wide variety of tapers and sizes – both in inch and metric.



HAIMER has the right shrink fit technology for any need with the largest range of shrink fit equipment and coils in the world.



Power Clamp Mini: HAIMER Quality in a small package

An economical introduction to shrink fit technology

Features:

- Intelligent coil technology makes shrinking simple and fast
- Tool changes in less than 5 seconds
- Ideal for the price-conscious user who only shrinks a few tools daily
- Shrinks solid carbide and HSS tools Ø 1/8" – 5/8" (3 – 16 mm)



Power Clamp Special Edition: All you need at a great price

High performance shrink fit machine for all tools

Features:

- Intelligent coil technology makes shrinking simple and fast
- Tool changes in less than 5 seconds
- Contact cooling stations guarantee increased productivity with rapid cooling
- One-handed operations - all at the touch of a button
- Shrinks solid carbide and HSS tools Ø 1/8" – 1¼" (3 – 32 mm)



Power Clamp Comfort NG: A premium shrink fit solution

Full performance with unbeatable efficiency

Features:

- All of the high performance features you know, with added capabilities to increase your output
- Rotary table allows for even faster shrinking and cooling
- New Generation Coil eliminates the need for stop discs, further simplifying the shrink process
- Additional HD Coil optional (shrink up to Ø 2")
- Shrinks solid carbide and HSS tools Ø 1/8" – 1¼" (3 – 32 mm)

See the HAIMER Power Clamp
Shrink Fit System in Action:



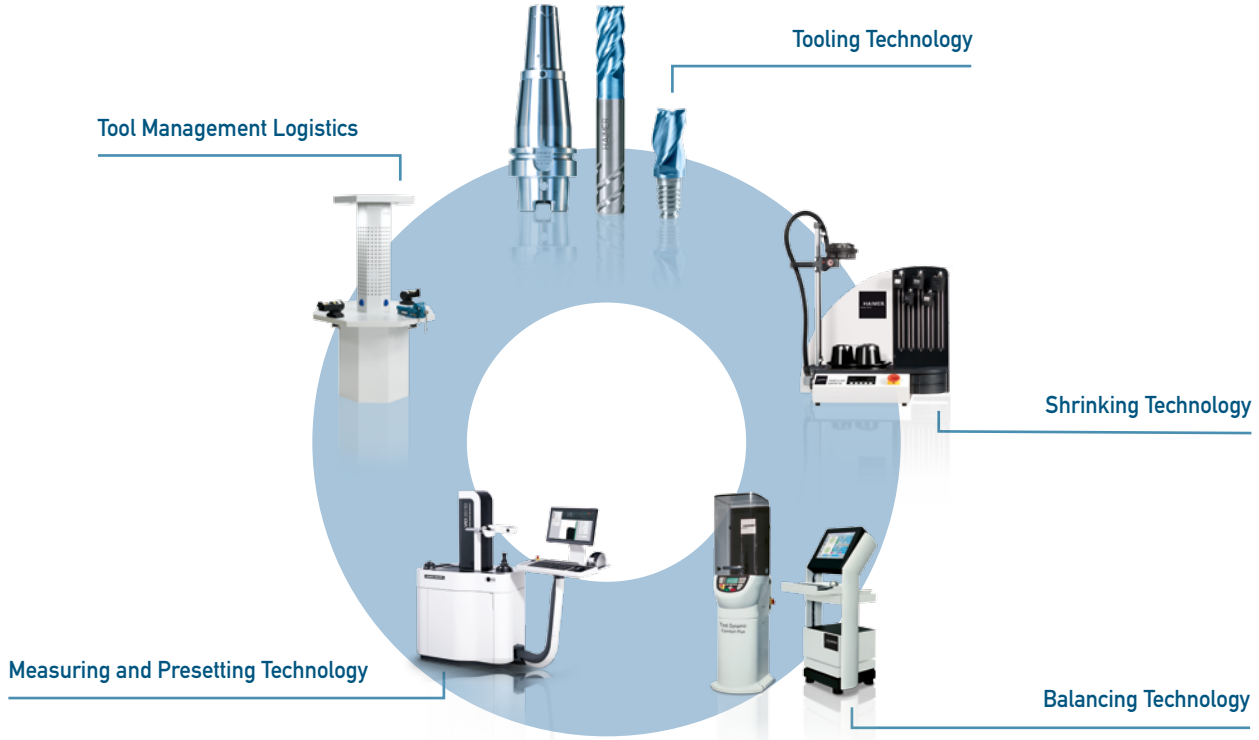

Haimer USA, LLC | 134 E. Hill Street | Villa Park, IL 60181 | USA

Phone 1-866-837-3265 | Fax (630) 833-1507 | Mail: haimer@haimer-usa.com | www.haimer-usa.com

Haimer Mexico | Anillo Vial Fray Junipero Serra No. 16950 Bodega 2 | Micro Parque Industrial Sotavento

Querétaro., QRO. C.P 76127 | Mexico | Phone +442-243-0950 | www.haimer-mexico.com | haimer@haimermx.com