

Owner's MANUAL

FA Series Electric Chain Hoists - Heavy Duty

Prod. No. 107202 - 107206
Mod. No. FA1-0.5S - FA-1-5S

Prod. No. 107212 - 107216
Mod. No. FA-0.5S - FA-5S

Prod. No. 107262 - 107266
Mod. No. FA-0.5S - FA-5S



TABLE OF CONTENTS

Warranty.....	3
1. Installation.....	4
2. Operation.....	9
3. Inspection & Maintenance.....	10
4. Wiring Diagram	15

ONE YEAR LIMITED WARRANTY

JET Electric Chain Hoists are guaranteed to be free of defects in material and workmanship. If one of these products fails during the first year of operation due to defective material or workmanship it will be repaired or replaced at our discretion. Normal wear and tear on moving parts is excluded from this guarantee. This guarantee does not apply to any product showing signs of misuse, overloading, alteration, or improper maintenance.

WARRANTY PROCEDURE

JET EQUIPMENT & TOOLS LTD. (JET) , makes every effort to ensure its products are manufactured to the highest standards and are guaranteed against defects in materials and workmanship when the product is used for the purpose for which it was designed.

This guarantee applies only to JET products purchased new from a JET authorized distributor.

JET product warranties are extended to the original retail purchaser only.

This warranty does not apply to any product showing signs of abuse, misuse, alteration, or having been improperly maintained or repaired.

This warranty does not cover damage attributable to normal wear and tear.

Any JET product that fails during normal use and is within the specified warranty period for that product will be repaired or replaced at JET'S discretion. Repairs and/or replacements are warranted as described for the specific product and only for the remainder of the original warranty period.

Repair or replacement is the exclusive remedy for defective product under this warranty.

Warranty is expressly in lieu of all other warranties, including the implied warranty of merchantability or any implied warranty of fitness for a particular application.

Any JET product for which there is a warranty claim should be returned PREPAID to an authorized JET distributor or service center. Authorized Warranty Depots are found at www.jetgroupbrands.com, ALL warranty claims must be accompanied by proof of purchase and an explanation of the defect or failure. It is the customer's responsibility to provide this information.

JET shall not be held liable for any consequential or incidental damages for breach of any expressed or implied warranty on their products. No claims for damages of any type will be considered and all products are sold with this understanding.

Any costs incurred to obtain warranty consideration or services are the Customer's responsibility including shipping and handling, travel, lost time, or lost production.

General information on JET chain hoists and pullers

Customs Lifts – Custom lift lengths are available, however, custom lift hoists and pullers are NOT returnable.

CAUTION: Be sure that supporting structures and load-attaching devices used in conjunction with hoists, provide an adequate safety factor to handle the rated load plus the weight of the equipment. If in doubt, consult a qualified structural engineer.

This equipment is not to be used for lifting, supporting, or transporting people, or lifting, supporting, or transporting loads over people.

IMPORTANT: Before installation and operation, see maintenance and operations manual for additional warnings, precautions and operating instructions.

1. INSTALLATION

1.1 DESIGNATION OF ELEMENTS OF THE UNIT (fig 1) (example with electric trolley)

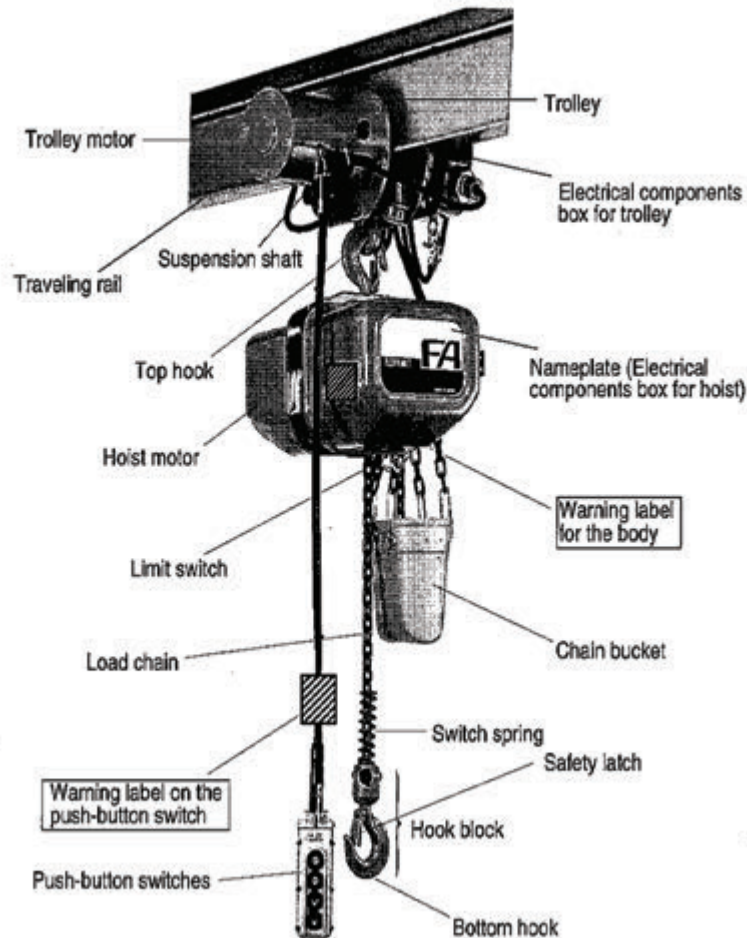

Figure 1

1.2 PRECAUTIONS THAT MUST BE CONSIDERED WHEN INSTALLING

1.2.1. USE OF YOUR HOIST UNDER SPECIFIC CONDITIONS

- Your hoist should not be used in an environment that is exposed to a possible danger of explosion. (Area where organic solvents or explosive dusts exist.)
- The electric chain hoist may not be used in areas where extremely low or high temperatures, high humidity, or chemicals predominate. Consult your local JET distributor when the electric chain hoist is used in a special environment such as HIGH TEMPERATURE (hotter than 104° F or 40° C) LOW TEMPERATURE (colder than 0° F or -18° C), HIGH HUMIDITY (more than 90%) or CHEMICAL EFFECTS.

1.2.2. THE SUPPORTING STRUCTURE SHOULD HAVE A LOAD RATING AT LEAST EQUAL TO THE HOIST

1.2.3. SWINGING OF THE HOIST IN NORMAL CONDITIONS

- The body of the hoist is designed to hang right under the hook or trolley and swings towards the load as the load sheave spins. **DON'T PREVENT THIS NATURAL SWINGING.** (Figure 2)

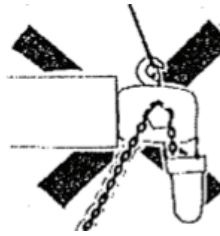

Figure 2

1.2.4. DON'T USE LIMIT SWITCHES TO STOP THE HOIST IN NORMAL OPERATION

- The built-in over-winding limit switches of the hoist should be set to function only in an emergency. The hoist should be installed so that the limit switches will never function in normal operation.

1.2.5. PREVENT THE HOIST FROM BEING EXPOSED TO RAIN

- Exposing your hoist to rain will significantly reduce the service life of the hoist. The hoist is designed to be safely operated even in the rain, if the grounding work has been completely performed. But in order to prolong its service life, a cover should be provided, if you install the hoist outside.

1.3. BEFORE CONNECTING POWER TO THE HOIST

1.3.1. POWER SETTING OF HOIST

- Make sure that the power supply corresponds to the hoist power setting. If your hoist is a dual-voltage type, **NEVER FAIL TO SET** its wiring so that it will correspond to the voltage of power source, before supplying power.

Do not remove the motor cover or the gear side cover. If the hoist body is not on the ground. If removing the cover is necessary while the hoist is suspended, use extra caution when removing the covers as the hook holding pin is held in place by both covers. Removing the covers can potentially cause the hook holding pin to be removed causing the hoist body to fall.

HOW TO SET UP THE WIRING (3-PHASE 220/440V MODEL)

Remove the motor side cover (No. 364). to expose the connector panel with female sockets L1, L2, L3, L4, H1, H2, H3 and H4, and male plugs 1, 2, 3 and 4. (Fig.3)

Engage them as specified below, corresponding to the voltage of power supply. (Fig. 4 & 5)

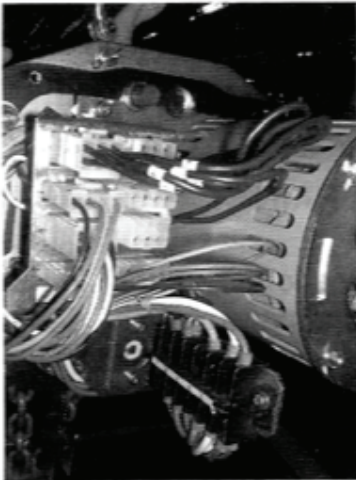

Figure 3

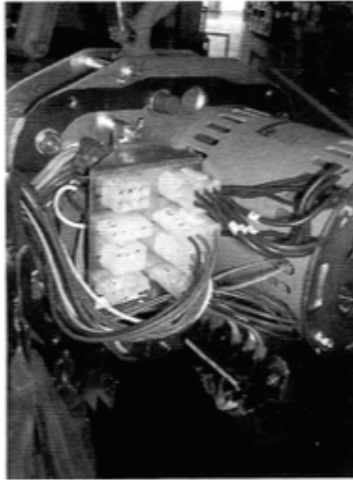

Figure 4

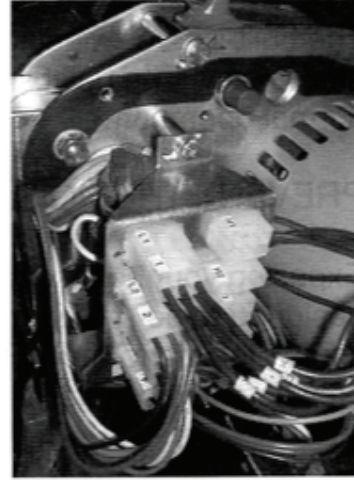

Figure 5

How to connect the Voltage

220V	Male 1-Female L1, Male 2-Female L2, Male 3-Female L3, and Male 4-Female L4
440V	Male 1-Female H1, Male 2-Female H2, Male 3-Female H3, and Male 4-Female H4

Install the motor side cover (No. 364) again, with care to ensure the wires are not caught and pressed between the cover and the hoist body.

HOW TO SET UP THE WIRING (1-PHASE 115/230V MODEL)

Remove the motor side cover (No. 364). to expose the connector panel with 2 female sockets (one marked 115V, and another marked 230V) as well as one male plug. If the voltage of the power source is 115V, engage the male plug to the female socket marked 115V, and if the voltage is 230V, engage the male plug to the female socket 230V.

NOTE: Once the power source is disconnected, you must wait 3 minutes before converting to a new voltage power source. This allows the capacitors to discharge, and protects the pins in the housings from sparking.

After the power supply wiring has been correctly connected, install the motor side cover (No. 364) again, taking care to ensure the wires are not caught and pressed between the cover and the hoist body.

NOTE: when engaging the plug into the socket, be sure that they are fully engaged when they are connected and that the tab is locked together with the socket. Press down the tab on the male plug when you want to disengage them.

1.3.2. VOLTAGE OF POWER SUPPLY

- The voltage of the power supply should be within plus or minus 10% of rated voltage.

1.3.3. SUPPLY CABLE MUST BE THICK ENOUGH

- Too large a resistance (in Q) of the cable (or other power supply system) used between the power supply and the hoist will cause the voltage to drop. It may not only damage the hoist but also give overheating of the supply cable. Choose such a supply cable that the calculated voltage drop is less than 4V (or 2V in the case of 1-phase power supply).

HOW TO CALCULATE THE VOLTAGE DROP

3 - phase, foreseen voltage drop = $30.8 \times L \times I \div A \div 10000$

1 - phase, foreseen voltage drop = $35.6 \times L \times I \div A \div 10000$

Where

L = cable length (in m)

I = stationary current consumption (in A) (use the value shown on the name plate)

A = cross section of the cable (in mm²)

1.3.4. ALWAYS GROUND THE CHAIN HOIST

1.3.5. CONNECTING WORK OF OPERATING MODULE AND POWER SUPPLYING MODULE

- How to connect and install the above mentioned modules are explained in the instructions attached to them. Install them correctly in accordance with the instructions.

1.3.6. REVERSE PHASE INSPECTION RELAY (For 3-phase model only)

- If the electric chain hoist does not work after connecting to the power supply, the negative phase inspection relay has operated. In this case, DO NOT MAKE ANY CHANGE TO THE HOIST'S WIRING in its body or in the push button switch case. Reverse any 2 of the 3 wires in the main power supply in order to disengage the negative inspection relay. (Fig.6)

Figure 6

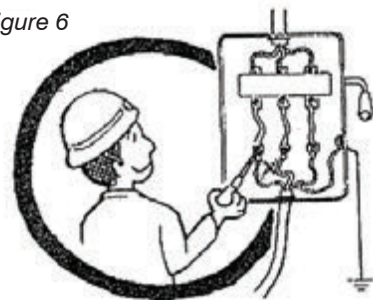

1.3.7. DO NOT USE THE CHAIN HOIST IF:

- The hoist is not hung correctly from the top hook
- The vinyl band or caution tag attached to the load chain has not been removed
- The load chain is kinked or twisted

NOTE: the vinyl band is provided to keep the load chain in good condition during transportation. You should remove the vinyl band after the hoist is located in the final working position and suspended correctly.

KINKED OR TWISTED LOAD CHAIN

Kinked load chain should not pass through the chain hoist body. With multi-fall models (2~5t rated load models) the load chain sometimes gets twisted by the lower hook turning a somersault between hanging chains. (Fig.7) Such a twist by somersault will not only lower the chain's load supporting capability, but will damage the load sheave or chain when the lower hook winds up near the upper limit even if unloaded. Such a twist by somersault shall be corrected before operating the chain hoist.

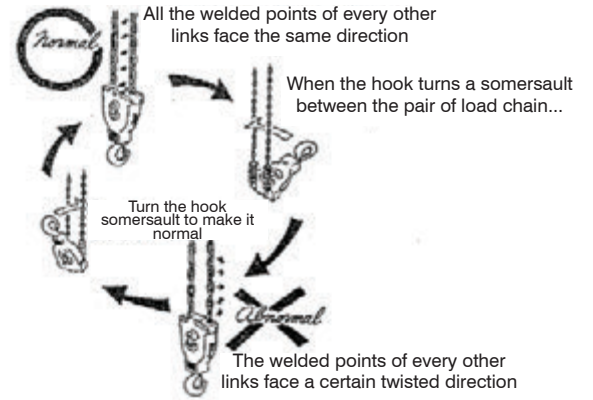

Figure 7

1.4. PROPER MOUNTING OF CHAIN BUCKET

1.4.1. HOW TO MOUNT THE BUCKET CORRECTLY

- The chain bucket must be mounted correctly. Do not operate the hoist without the chain bucket.
- The chain bucket should be mounted to the hoist with the chain on the no load side (under the operating element B) with less than 50 cm of load chain to avoid kinks and jamming of the load chain. Refer to the illustrations and mounting position.

Fig.8, Choose the right mounting position.

Fig.9, Don't twist any hanging chain.

Fig.10, Cables should not go between any 2 of the 4 hanging links.

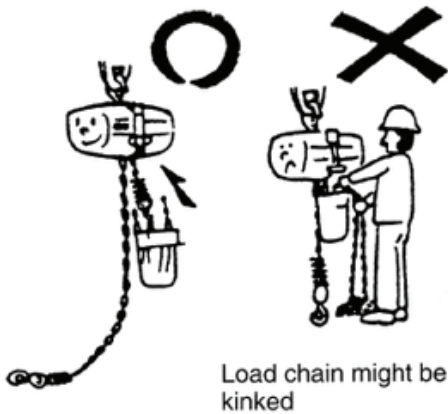

Figure 8

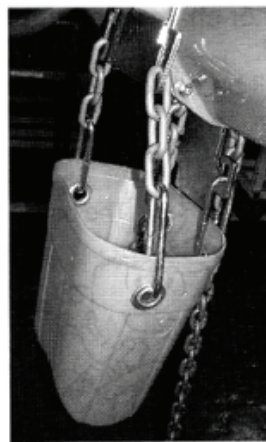

Figure 9

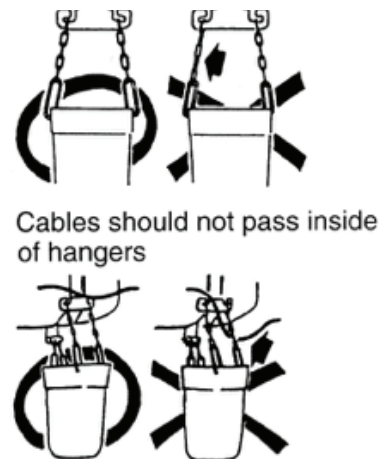

Figure 10

1.4.2. USE THE CORRECT SIZE BUCKET

- If the chain bucket is too small compared with the length of the load chain, the load chain will dangerously overflow from the bucket. Too big a chain bucket tends to be pushed upward by the load. Choose the correct size bucket corresponding to the hoist's lift by referring to the table below:

rated load capacity	lift in m														
	3	4	5	6	7	8	9	10	11	12	13	14	15		
0.5 t	size 1			size 2			size 3								
1 t	size 1	size 2		size 3			size 4								
2 t	size 2	size 3		size 4			size 5								
3 t	size 3		size 4		size 5										
5 t	size 4		size 5												
	10	13	19	29			36	39	49						
	lift in ft														

2. OPERATION

2.1. IMPORTANT INSTRUCTIONS FOR OPERATORS

- Do not use hoist to lift people or carry loads over people
- Do not lift more than the rated capacity of the hoist
- Do not operate a damaged or malfunctioning hoist until necessary adjustments or repairs have been made
- Do not operate hoist with a twisted, kinked or damaged chain
- Do not leave a load suspended in the air unattended
- Align hoist for a straight line lift. Avoid side lift or end lift
- Avoid jogging push buttons or quick reversing of load
- Be sure to use the hook latch. If the latch is malfunctioning, do not use the hoist until repairs have been made.
- Do practice daily inspection before starting operation every day

2.2. GOOD OPERATING PRACTICES

- The operator should not engage in any practice which will divert his attention while operating the hoist.
- Before starting the hoist, the operator should be certain that all personnel is clear.
- Make it a rule to perform the 3 important checks below, before lifting the load high in the air. (Fig.11)
 1. First, check the slinging position, when the load chain and lifting slings becomes stretched tight.
 2. Next, check the balance of the load while only inches above the ground.
 3. Then check the hoist's braking function by operating up and down a few inches several times.
- If you are uncertain or feel something is not correct, lower the load immediately, and investigate what is not operating correctly.

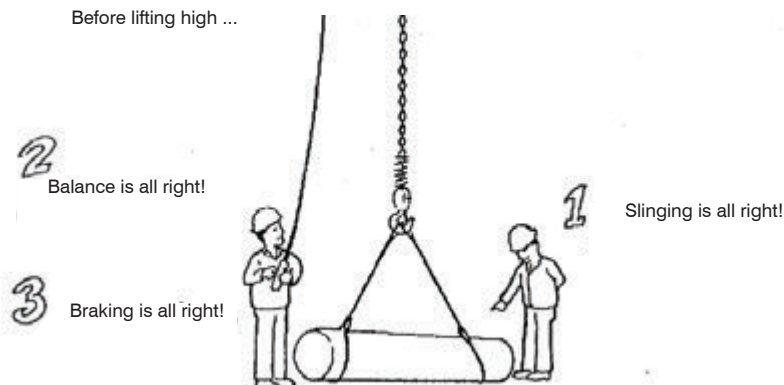

Figure 11

2.3. SLINGING

2.3.1. CHECK LIFTING SLINGS

- Never use any lifting sling underrated for the load being lifted. Never use any lifting sling inferior in quality or condition.

2.3.2. SAFE AND SURE SLINGINGS

Note: The load capacity of the sling should always be rated higher than the load being lifted. Always ensure the sling is not improperly hooked as shown in Fig.12~14.

Fig.12, Always ensure the sling is located in the hook properly
 Fig.13, Sling the load up with the ANGLE BEING 60° OR LESS.
 Fig.14, ENSURE THE HOOK LATCH IS CLOSED CORRECTLY.



Figure 12



Figure 13



Figure 14

THE LOAD CHAIN SHOULD NOT BE WRAPPED AROUND THE LOAD (Fig. 15)



Figure 15

3. INSPECTION & MAINTENANCE

Inspection procedures are divided into 3 general classifications based upon the service intervals. Deficiencies should be carefully examined and corrected. The intervals between inspection will vary depending on the operating conditions.

3.1. DAILY INSPECTION

Inspect the following items daily before operating hoist.

3.1.1. TOP HOOK & PARTS

- Check the hook latch to ensure it is opening and closing properly
- Inspect the top hook and parts for flaws or deformations that are visibly noticeable
- Ensure the idle sheave, where applicable, rotates smoothly (Check to ensure it fits the load chain correctly)
- Inspect for any loose or missing parts

3.1.2. LOWER HOOK & PARTS

- Check the hook latch to ensure it is opening and closing properly
- Ensure the bottom hook is rotating smoothly
- Inspect the top hook and parts for flaws or deformations that are visibly noticeable
- Where there are two or more load chain falls, check to ensure the idle sheaves rotate smoothly
- Do they fit the load chain correctly?
- Inspect for any loose or missing parts

3.1.3. SWITCH SPRINGS

- Ensure switch springs are not damaged or missing

NOTE: operation without either one of the springs is dangerous and is prohibited

3.1.4. LOAD CHAIN

- Check the load chain for proper lubrication
- Check the load chain for any damage, wear, or twisting

3.1.5. PUSH BUTTON SWITCH

- Check the case for cracks
- Does the push button work smoothly? Return of the push button should also be smooth
- Check for dirt or contamination around the switch

3.1.6. OVERALL OPERATION (Final check)

- Is the upper & lower limit switch functioning correctly?
- Is the brake functioning correctly?
- Are there any unusual noises caused during the up-down, transverse and travel movement of the hoist?

3.2. MONTHLY INSPECTION

NOTE: before the body is disassembled first perform the following:

1. Unload the hoist
2. Lower the chain until about 10 cm before the lower limit switch engages
3. Disconnect the power supply

3.2.1. MOTOR BRAKE

- Thickness of 531 lining
 - o The minimum thickness of the 531 lining is 7.5mm. The brake disc must be replaced when the thickness (Fig.16) is less than 7.5 mm. (Initial thickness is 8 mm)
- How to measure:
 1. Remove all the connectors connected to A and B in Fig.17.
 2. Remove 361 electric component cover case.
 3. Pull and remove the insulated terminal shown (C) Fig.17. (Wiring can be interchanged when reassembling).
The brake coil of 575V model has 3 black wires and 2 red. Loosen the screws and remove. (2 red lines can be interchanged when rewiring. The black wire must be connected to the same terminal).
 4. Remove 543 rubber brake cover and 5442 and 5443 nuts to dismantle the brake assembly (Fig.17) The lining thickness can then be measured remembering that the minimum thickness is 7.5 mm. (Fig.16) Follow the reverse sequence to reassemble.

Figure 16

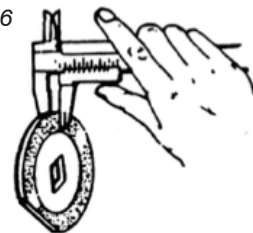
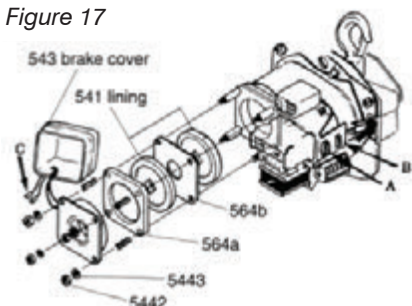

Figure 17



NOTE: Some models have only 1 lining with no 564b in use.

- When assembling 564a and 564b, the same sequence must be followed during reassembly or the brake will not function properly.
- Where 2 linings are in use, the notch of one lining must be in the opposite direction to that of the other.

3.2.2. LOAD CHAIN

PITCH EXPANSION

The load chain must be carefully checked over its full length. Insert a chain gauge at about every 50 cm and check to see if the pitch has expanded. If the pitch expansion is within the allowable limits the chain gauge will not go through, because its inserted part will strike the load chain as illustrated in Fig.18.

If the pitch expansion has exceeded the allowable limit, the gauge will go through as illustrated in Fig.19. Replace the chain if pitch expansion has occurred.

Figure 18

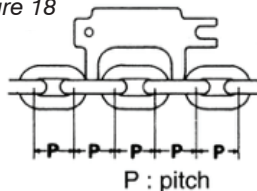

Figure 19

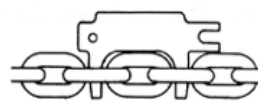
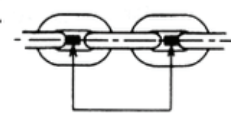

Figure 20

Correct chain gauge position illustrated. Insert the gauge along the center line with the chain straight.



CHAIN DIAMETER THICKNESS

A load chain containing a link with its diameter decreased due to corrosion or any other reason must be replaced. Inspect chain link thickness, where critical pitch expansion appears, using the gauge. If the mouth of the gauge applied fits the link as illustrated in Fig.20, that means diameter is less than the allowable limit.

• OTHER VISUAL DEFECTS

If any **FLAWS** or **BENDS** are found, or if any person has welded the load chain, the load chain must be replaced. The load chain must also be replaced if any thermal effects are apparent.

NOTE: if the load chain is in good condition except for only one part or one link, the chain must be replaced with a new one.

REPLACING THE LOAD CHAIN

NOTE: The welded part of each vertical link must always face the outside in relation to the load sheave.

In the case of 2 or more chain falls to the lower hook, the end link which is fixed by a chain stopper pin must be a vertical link, so that the chain can be installed without twisting.

3.2.3. HOOKS ASSEMBLIES

UPPER AND LOWER HOOKS

HOOK MOUTH

- If the hook has stretched it must be replaced since it has lost the required strength and shock absorbing capability.
- Replacement must be made when the dimension A shown in Fig.21 has exceeded the limit shown in the table below.
- Do not use heat to repair the hook as the strength of the hook would be substantially reduced.

rated load capacity	Initial value A	Limit value A
0.5 t	33 ± 1mm	36mm
1 t	40 ± 1mm	43mm
2 t	49 ± 1mm	53mm
3 t	55 ± 1mm	59mm
5 t	63 ± 1mm	68mm

Figure 21



FLAWED, WORN OR BENT HOOKS

Such hooks as are found in Fig.22-24 must also be replaced.

- Fig.22, A flaw is clearly apparent.
- Fig.23, Wear exceeds the allowable limit (specified below).
- Fig.24, A bend can be visually detected.

rated load capacity	Initial value H	Limit value H
0.5 t	19mm	17.1mm
1 t	25mm	22.5mm
2 t	35mm	31.5mm
3 t	49mm	44.1mm
5 t	53mm	47.7mm

Figure 22



Figure 23

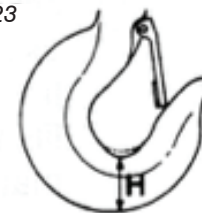

Figure 24



IDLE SHEAVE ROTATION & DEFORMATION (Not applicable to 0.5 Ton model)

The idle sheave must be cleaned and checked if there is foreign matter on it. The following three points must be checked:

- Abnormalities on the sheave bearings or axis of rotation
- Foreign matter collected on the idle sheave pocket
- Deformed idle sheave projections (Fig.25)

Figure 25

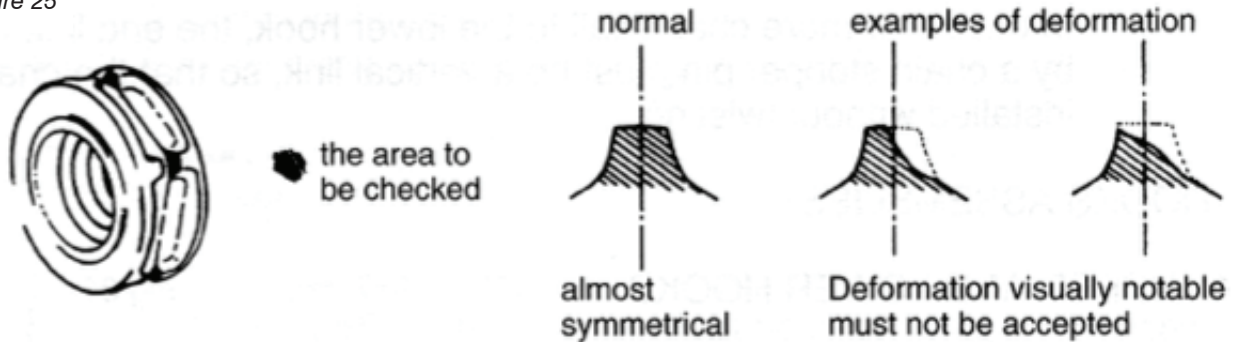

3.2.4. OTHER ITEMS TO BE CHECKED MONTHLY:

- Check For Loose Bolts, Screws And Nuts
- Inspect For Worn, Corroded, Cracked Or Distorted Parts Such As Pins, Bearings, Shafts And Gears
- Check Electrical Parts For Signs Of Pitting Or Any Deterioration Of Controls, Limit Switch And Push Button Station
- Finally, Perform The Daily Inspection Before Operating The Hoist

3.3. ANNUAL INSPECTION

- Check the entire range of movement of hoist with rated load.
- Carefully check that even with rated load and at the highest speed, the hoist operates safely and smoothly.

4. WIRING DIAGRAM
4.1. 3 PHASE SINGLE VOLTAGE SINGLE SPEED MODEL (575V)

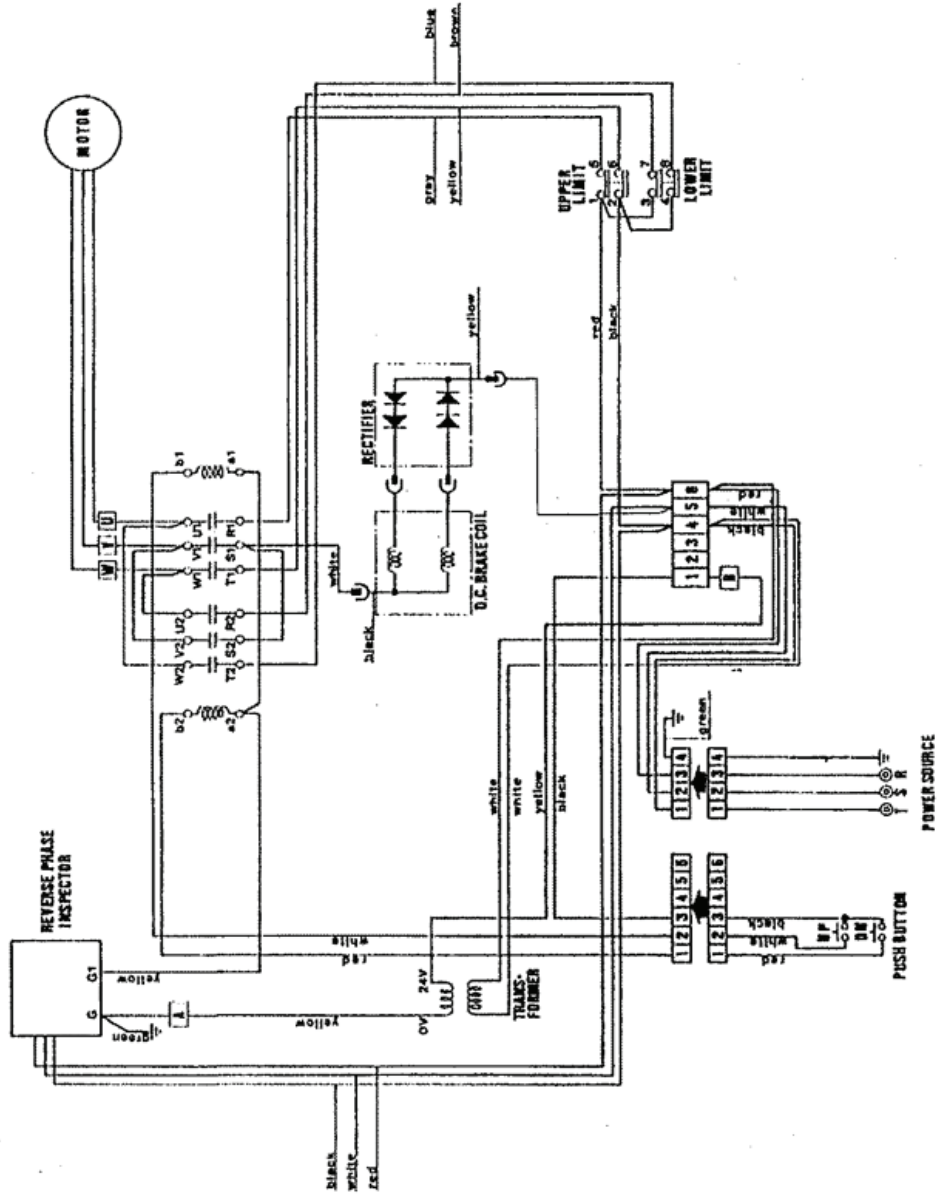

4. WIRING DIAGRAM
4.2. 3 PHASE DUAL VOLTAGE SINGLE SPEED MODEL

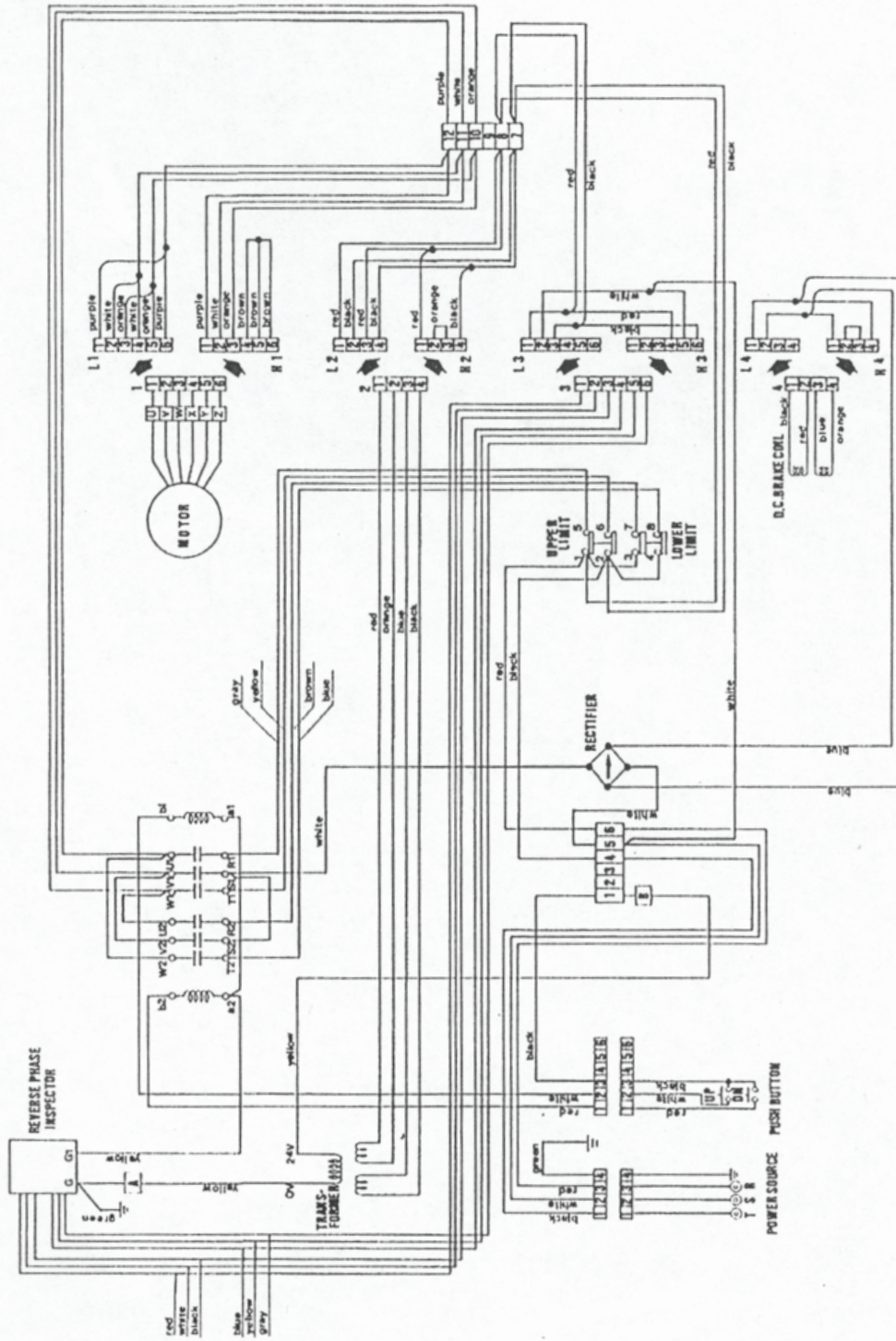

4. WIRING DIAGRAM
4.3. 3 PHASE SINGLE VOLTAGE DUAL SPEED MODEL (575V)

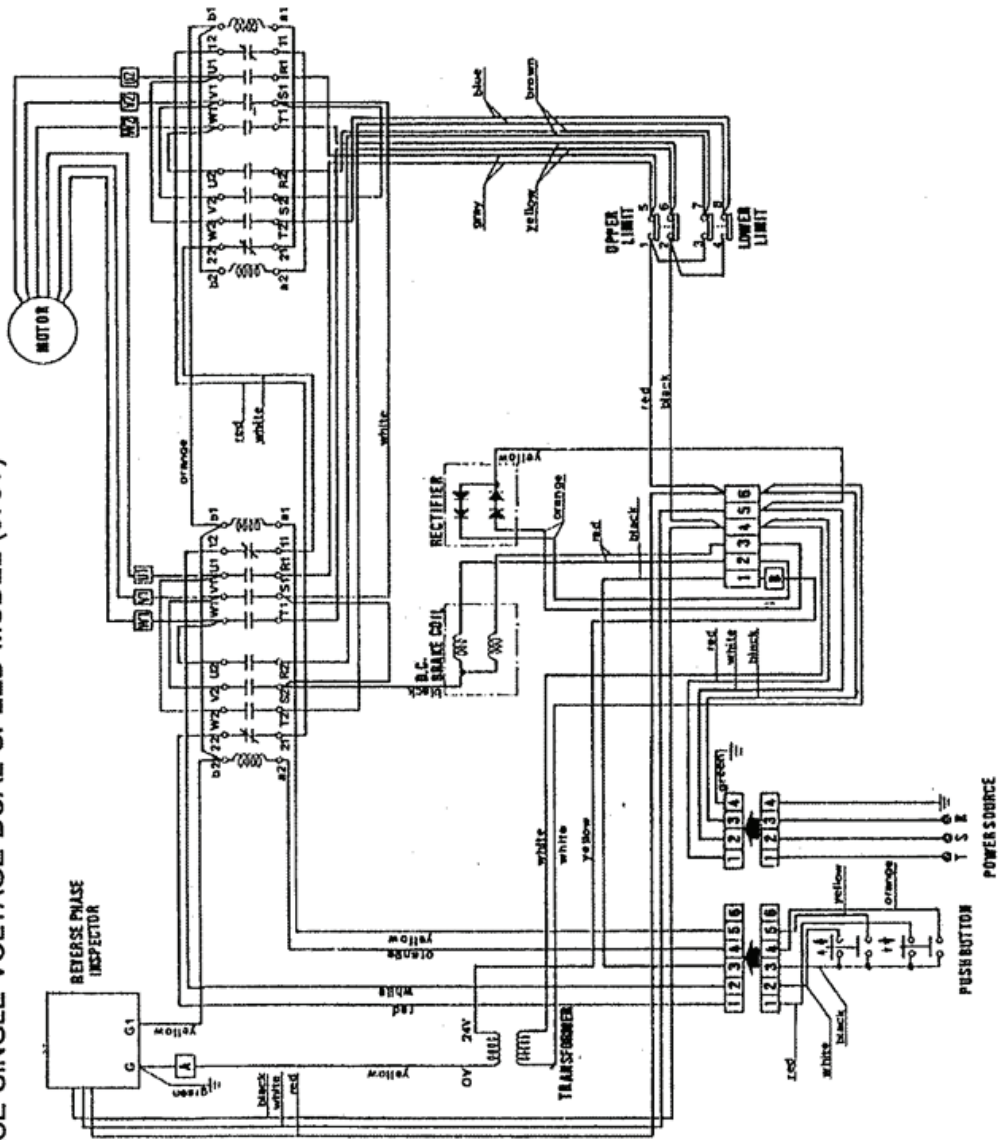

4. WIRING DIAGRAM
 4.4. 3 PHASE SINGLE VOLTAGE DUAL SPEED MODEL (220V ~440V)

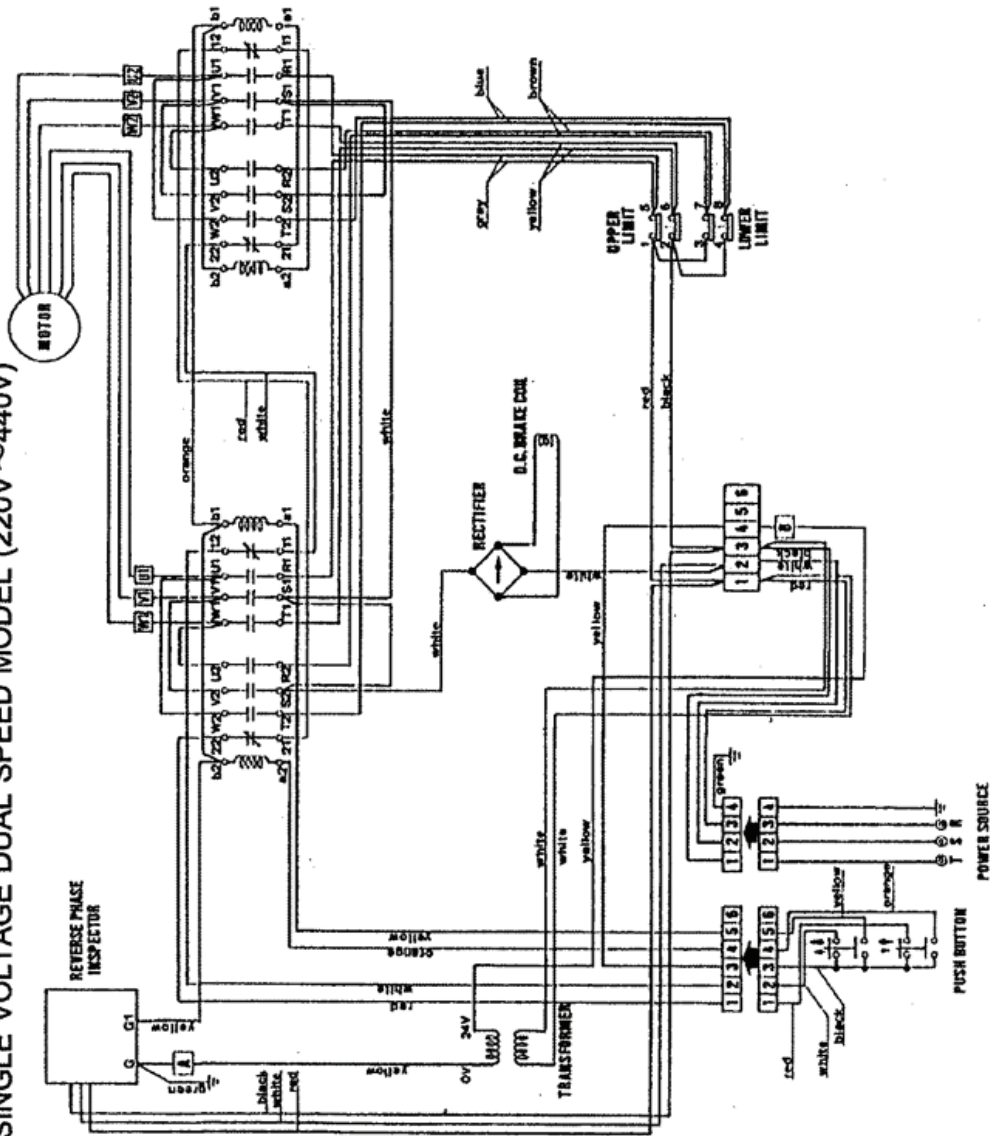

4. WIRING DIAGRAM
4.5. 1 PHASE MODEL

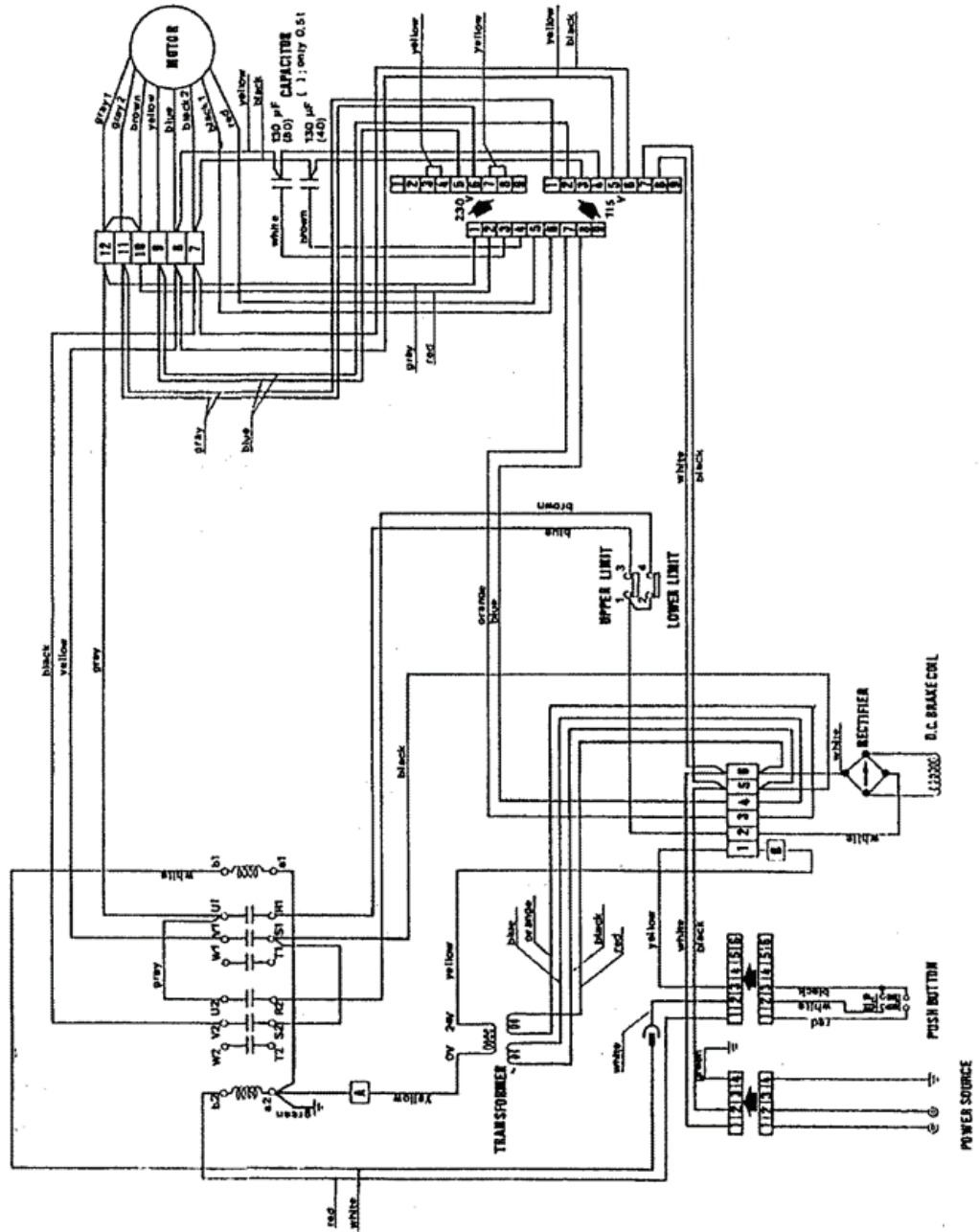

WARNING: To Avoid Injury

1. DO read ANSI B30.16 safety standard for overhead hoists and hoist manufacturer's Operating and Maintenance Instructions.
2. DO be familiar with hoist operating controls, procedures and warnings.
3. DO make sure hook travel is in the same direction as shown on controls.
4. DO make sure hoist limit switches function properly.
5. DO maintain firm footing when operating hoist.
6. DO make sure that load slings or other approved slinging attachments are properly sized and seated in the hook saddle.
7. DO make sure that the hook latch is closed and not supporting any part of load.
8. DO make sure that load is free to move and will clear all obstructions.
9. DO take up slack carefully, check load balance, lift a few inches and check load holding action before continuing.
10. DO avoid swinging of load or load hook.
11. DO make sure that all persons stay clear of the suspended load.
12. DO warn personnel of an approaching load.
13. DO protect load chain from weld spatter or other damaging contaminants.
14. DO promptly report any malfunction, unusual performance, or damage of the hoist.
15. DO inspect hoist regularly, replace damaged or worn parts, and keep appropriate records of maintenance.
16. DO use the hoist manufacturer's recommended parts when repairing a hoist.
17. DO use hook latches whenever possible. DO NOT remove the hook latch.
18. DO apply lubricant to the load chain as recommended by the hoist manufacturer.
19. DO not lift more than rated load.

20. DO NOT use the hoist load limiting device to measure the load.
21. DO NOT use damaged hoist or hoist that is not working correctly.
22. DO NOT use the hoist with twisted, kinked, damaged or worn chain.
23. DO NOT lift a load unless chain is properly seated in chain wheel(s) or sprocket(s).
24. DO NOT use load chain as a sling or wrap chain around the load.
25. DO NOT lift a load if any binding prevents equal loading on all supporting ropes or chains.
26. DO NOT apply the load to the tip of the hook.
27. DO NOT operate unless load is centered under hoist.
28. DO NOT allow your attention to be diverted from operating the hoist.
29. DO NOT operate the hoist beyond limits of load chain travel.
30. DO NOT use limit switches as routine operating stops unless recommended. They are emergency devices only.
31. DO NOT use hoist to lift, support, or transport people.
32. DO NOT lift loads over people.
33. DO NOT leave a suspended load unattended unless specific precautions have been taken.
34. DO NOT allow sharp contact between two hoists or between hoist and obstructions.
35. DO NOT allow any part of hoist to be used as a ground for welding. When gas welding ensure that the load chain or hook is not subject to heat.
36. DO NOT allow any part of hoist to be touched by a live welding electrode.
37. DO NOT remove or obscure the warnings on the hoist.
38. DO NOT adjust or repair a hoist unless qualified to perform hoist maintenance.
39. DO NOT attempt to lengthen the load chain or repair damaged load chain.
40. DO NOT apply a sudden load to the chain such as pushing a load off a ledge and allowing the chain to 'catch' it.
41. DO be sure that the hoist is unloaded and power supply is disconnected before performing maintenance and repair procedures.