

Operator's Manual

Electric Chain Hoist



WAREHOUSE LOCATIONS/EMPLACEMENT DES ENTREPÔTS:

Vancouver

3260 Production Way
Burnaby, B.C.
V5A 4W4

Edmonton

5239 86th Street
Edmonton, Alberta
T6E 6T1

Winnipeg

951 Powell Avenue
Winnipeg, Manitoba
R3H 0H4

Toronto

416 Watline Avenue
Mississauga, Ontario
L4Z 1X2

Montréal

4620, rue Garand
St-Laurent (Québec)
H4R 2A2

Halifax

#110-11 Morris Drive
Dartmouth, Nova Scotia
B3B 1M2

CUSTOMER SERVICE CALL CENTERS

CENTRES D'APPEL POUR LE SERVICE À LA CLIENTÈLE

B.C./Alberta/Saskatchewan

Tel: (604) 444-5300
Fax: (604) 444-9227
Toll Free:
Tel: 1-800-472-7685
Fax: 1-800-663-7742

Manitoba/Northwest Ontario

Tel: (204) 632-6970
Fax: (204) 694-9534
Toll Free:
Tel: 1-800-665-7524

Ontario/Quebec

Tel: (905) 502-8665
Fax: (905) 502-7707
Toll Free:
Tel: 1-800-387-3879
Fax: 1-800-267-3310
En français
Sans frais: Tél: 1-800-363-2885

Atlantic Canada

Tel: (902) 468-8324
Fax: (902) 468-3461
Toll Free:
Tel: 1-800-472-7686

TABLE OF CONTENTS

1. INSTALLING	1
1.1 PRECAUTIONS THAT MUST BE CONSIDERED WHEN INSTALLING	
1.1.1. USE OF YOUR HOIST UNDER SPECIFIC CONDITIONS	
1.1.2. THE SUPPORTING STRUCTURE SHOULD HAVE A LOAD RATING AT LEAST EQUAL TO THE HOIST	
1.1.3. SWINGING OF THE HOIST IN NORMAL CONDITIONS	
1.1.4. DON'T USE LIMIT SWITCHES TO	
1.1.5. PREVENT THE HOIST FROM BEING EXPOSED TO RAIN	
1.2. DO AND DON'T BEFORE CONNECTING POWER TO THE HOIST	3
1.2.1. POWER SETTING OF HOIST	
1.2.2. POWER SUPPLY, DO AND DON'T	5
1.2.3. DON'T USE THE CHAIN HOIST IF	
1.3. PROPER MOUNTING OF CHAIN BUCKET	9
1.3.1. HOW TO MOUNT THE BUCKET CORRECTLY	
1.3.2. USE THE CORRECT SIZE BUCKET	
2. OPERATION	11
2.1. IMPORTANT INSTRUCTIONS FOR OPERATORS	
2.2. GOOD OPERATING PRACTICES	
2.3. SLINGING	
2.3.1. CHECK LIFTING SLINGS	
2.3.2. SAFE AND SURE SLINGINGS	
3. INSPECTION & MAINTENANCE	13
3.1. DAILY INSPECTION	
3.1.1. TOP HOOK & PARTS	
3.1.2. LOWER HOOK & PARTS	
3.1.3. SWITCH SPRINGS	
3.1.4. LOAD CHAIN	
3.1.5. PUSH BUTTON SWITCH	
3.1.6. OVERALL OPERATION	
3.2. MONTHLY INSPECTION	15
3.2.1. MOTOR BRAKE	
3.2.2. LOAD CHAIN	
3.2.3. HOOKS ASSEMBLIES	17
3.2.4. OTHER ITEMS TO BE CHECKED MONTHLY	19
3.3. ANNUAL INSPECTION	
4. WIRING DIAGRAM	20
4.1. 3 PHASE SINGLE VOLTAGE, SINGLE SPEED MODEL(575V)	
4.2. 3 PHASE DUAL VOLTAGE, SINGLE SPEED MODEL	21
4.3. 3 PHASE SINGLE VOLTAGE, DUAL SPEED MODEL (575V)	22
4.4. 3 PHASE SINGLE VOLTAGE, DUAL SPEED MODEL (220~440V)	23
4.5. 1 PHASE MODEL	24

1. INSTALLING

1.1. PRECAUTIONS MUST BE CONSIDERED WHEN INSTALLING

1.1.1. USE OF YOUR HOIST UNDER SPECIFIC CONDITIONS

Your hoist should not be used in the environment that is exposed to a possible danger of EXPLOSION. Please consult with your dealer when you use your hoist under special conditions, such as HIGH TEMPERATURE (hotter than 104° F or 40° C), LOW TEMPERATURE (colder than 0° F—18° C), HIGH HUMIDITY (more than 90%) or CHEMICAL EFFECTS.

1.1.2. THE SUPPORTING STRUCTURE SHOULD HAVE A LOAD RATING AT LEAST EQUAL TO THE HOIST

1.1.3. SWINGING OF THE HOIST IN NORMAL CONDITIONS

The body of the hoist is designed to hang right under the hook or trolley and swings towards the load as the load sheave spins. DON'T PREVENT THIS NATURAL SWINGING. (Fig.1)

1.1.4. DON'T USE LIMIT SWITCHES TO STOP THE HOIST IN NORMAL OPERATION

The built-in over-winding limit switches of the hoist should be set to function only in an emergency. The hoist should be installed so that the limit switches will never function in normal operation.

1.1.5. PREVENT THE HOIST FROM BEING EXPOSED TO RAIN

Exposing your hoist to rain makes its service life extremely short. The hoist is designed to be safely operated even in the rain, if the grounding work has been completely performed. But in order to prolong its service life, a cover should be provided, if you install the hoist in the open air. (Fig.2)

Fig.1

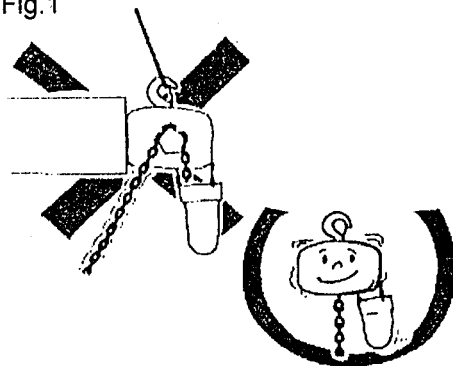


Fig.2

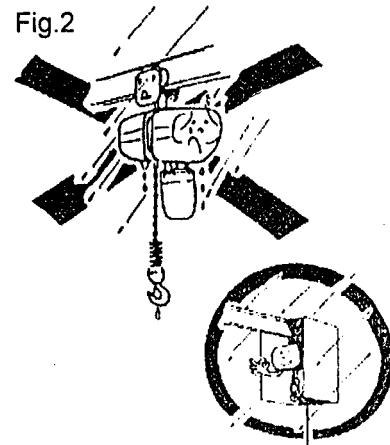


Fig.3 connector panel for 3phase dual voltage model

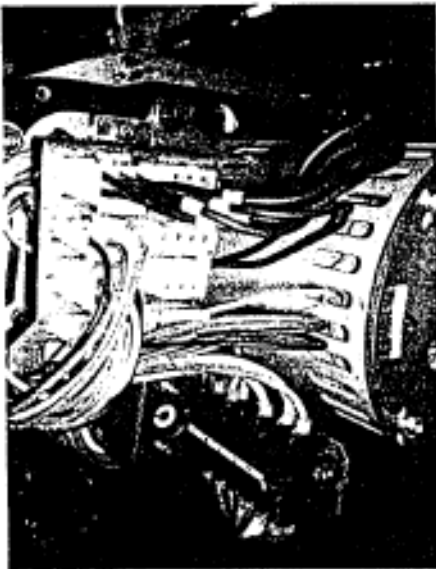


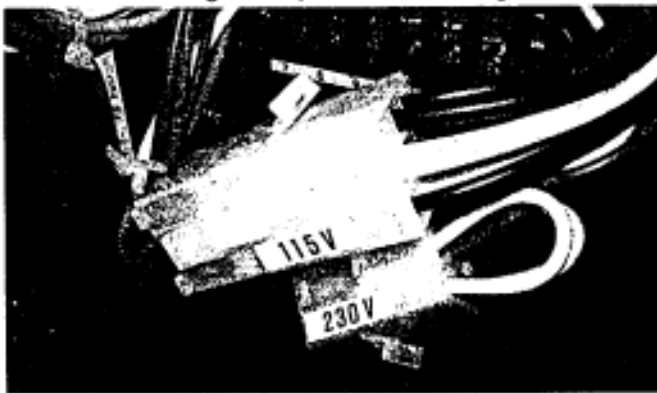
Fig.4 set up for 440V



Fig.5 set up for 220V

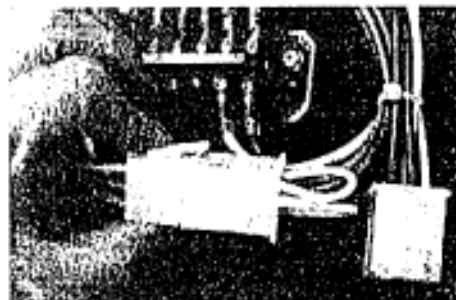


Fig.6 male & female housings for 1phase dual voltage model



now, set up for 115V

Fig.7 now, pressing down the projection



1.2. DO AND DON'T BEFORE CONNECTING POWER TO THE HOIST

Please follow these instructions

1.2.1. POWER SETTING OF HOIST

Make sure that the power supply corresponds to the hoist power setting. If your hoist is a dual-voltage type, NEVER FAIL TO SET its wiring so that it will correspond to the voltage of power source, before supplying power. DON'T REMOVE THE MOTOR COVER OR THE GEAR SIDE COVER, IF THE BODY IS NOT ON THE GROUND. IF COVER REMOVING OPERATION IS ESSENTIAL WHILE HOIST IS HUNG, PAY CLOSE ATTENTION TO THE HOOK HOLDING PIN'S REMOVAL. WITHOUT BOTH COVERS THE HOOK HOLDING PIN CAN MOVE AWAY AND MAY CAUSE BODY FALLING ACCIDENT.

HOW TO SET UP THE WIRING 3-PHASE 220/440V MODEL

Remove the motor side cover (No.364). And then you find a connector panel with female socket L1,L2,L3,L4,H1,H2,H3 and H4, and male plugs 1, 2, 3 and 4, (Fig.3)

Engage them as specified below, corresponding to the voltage of power supply. (Fig.4&5)

Voltage	How to connect
220V	Male 1-Female L1, Male 2-Female L2, Male 3-Female L3, and Male 4-Female L4
440V	Male 1-Female H1, Male 2-Female H2, Male 3-Female H3, and Male 4-Female H4

That's all for setting up. Install the motor side cover (No.364) again, with care not to let the wires be caught and pressed between parts.

HOW TO SET UP THE WIRING 1-PHASE 115/230V MODEL

Remove the motor side cover (No.364). And then you find 2 female sockets (one marked 115V, and another marked 230V). And one male plug is there. (Fig.6) If the voltage of power source is 115, engage the male plug to the female socket marked 115V, and if the voltage is 230, engage the male plug to the female socket 230V.

NOTE! After the hoist be used with either voltage of power source, you must wait more than 2 minutes from when the power source disconnected, before you start the resetting work for new voltage power source. The 2 minutes is to let the capacitors discharge, and protects the pins in the housings from sparking. After the power supply wiring has been correctly connected, install the motor side cover (No.364) again, with care not to let the wires be caught and pressed between parts.

Fig.8

NOTE! WHEN ENGAGING SOCKET & PLUG, BE SURE THAT THEIR PROJECTIONS ENGAGE COMPLETELY, WHEN THEY ARE CONNECTED FULLY, THE PLUG AND SOCKET ARE LOCKED TOGETHER. PRESS DOWN THE TAIL OF THE PROJECTION ON THE MALE PLUG WHEN YOU WANT TO DISENGAGE THEM.(Fig.7)

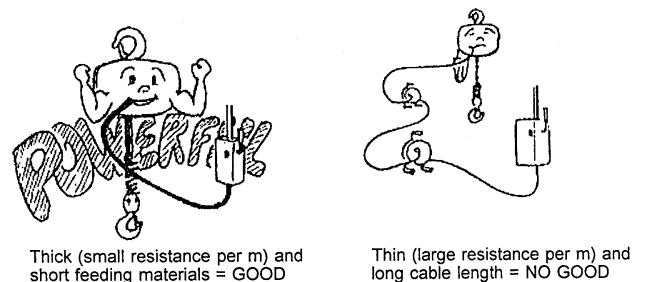
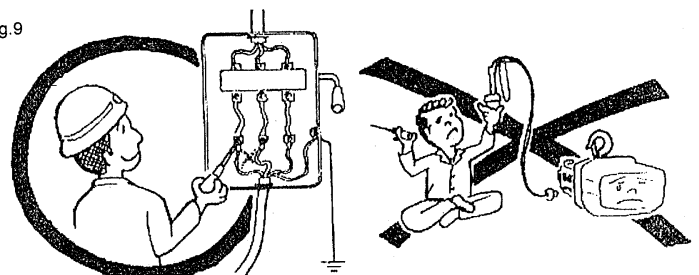


Fig.9



All you have to do is simple !
Change two phase wires over.

1.2.2. POWER SUPPLY DO AND DON'T

1.2.2.1. VOLTAGE OF POWER SUPPLY

Voltage of power supply should be within plus or minus 10% of rated voltage.

1.2.2.2. SUPPLY CABLE MUST BE THICK ENOUGH (Fig.8)

Too large a resistance (in Q) of the cable (or other power supply system) used between the power supply and the hoist will cause the voltage to drop. It may not only damage the hoist but also give overheating of the supply cable. Choose such a supply cable that the calculated voltage drop is less then 4V (or 2V in the case of 1-phase power supply).

HOW TO CALCULATE THE VOLTAGE DROP

3 - phase, foreseen voltage drop = $30.8 \times L \times I \div A \div 10000$

1 - phase, foreseen voltage drop = $35.6 \times L \times I \div A \div 10000$

where L = cable length (in m)

I = stationary current consumption (in A) (use the value shown on the name plate)

A = cross section of the cable (in mm²)

1.2.2.3. ALWAYS GROUND THE CHAIN HOIST

1.2.2.4. CONNECTING WORK OF OPERATING MODULE AND POWER SUPPLYING MODULE

How to connect and install the above mentioned modules are explained in the instructions attached to them. Install them correctly in accordance with the instructions.

1.2.2.5. REVERSE PHASE INSPECTION RELAY (Device for 3-phase model only)

If the electric chain block does not work after connecting to the power supply, the negative phase inspection relay has operated. In this case, Don't MAKE ANY GHANGE TO THE HOIST'S WIRING in its body or in the push button switch case. All you have to do is reverse any 2 of the 3 wires in the main power supply. (Fig.9)

rated load capacity	lift in m														
	3	4	5	6	7	8	9	10	11	12	13	14	15		
0.5t	size 1			size 2			size 3								
1t	size 1	size 2		size 3			size 4		size 5						
2t	size 2	size 3		size 4			size 5		size 6						
3t	size 3		size 4		size 5			size 6							
5t	size 4		size 5		size 6			size 7							
	10	13		19		29		36	39					49	
	lift in ft														

Fig.10 Do not operate if load chain cannot run freely.

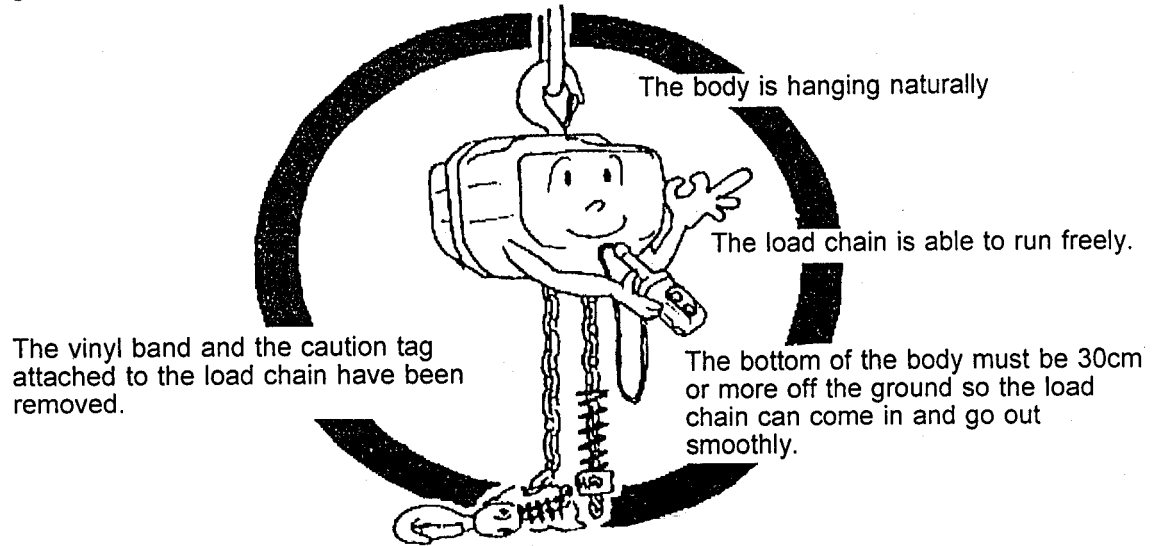


Fig.11

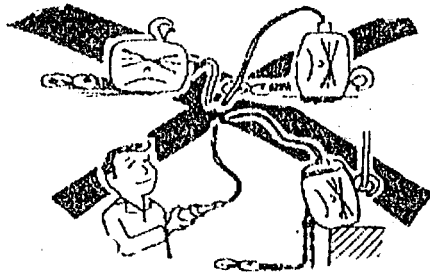


Fig.12

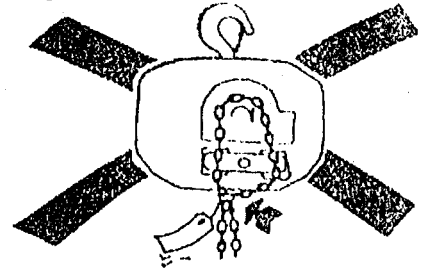
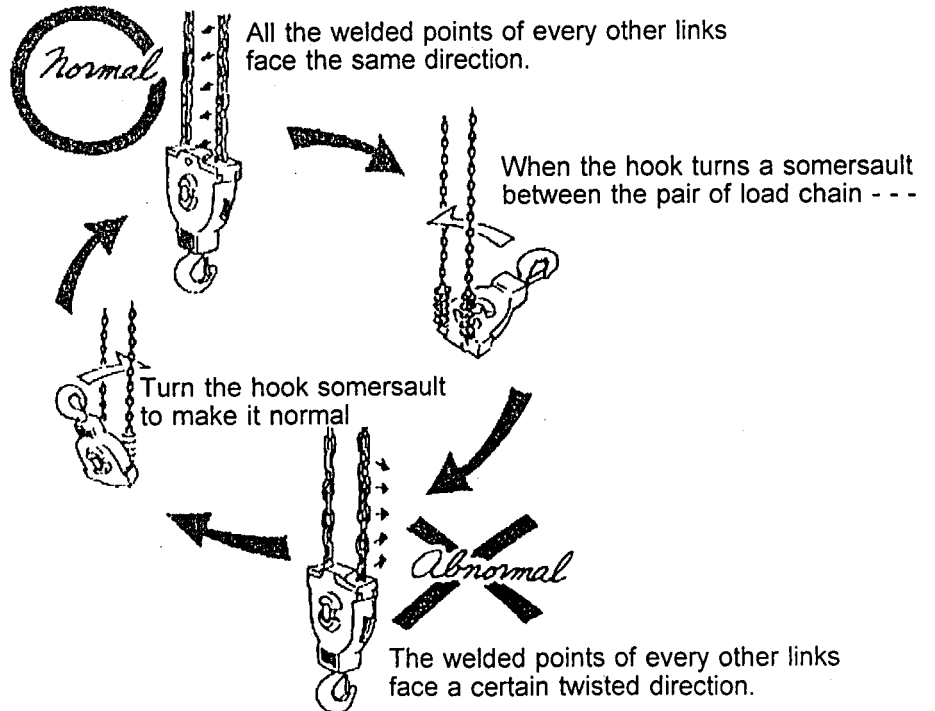


Fig.13 somersault



1.2.3. DON'T USE THE CHAIN HOIST IF

- the hoist is not hanged correctly.
- the vinyl band or the caution tag attached on the load chain is not removed.
- the load chain kinked or twisted. (Fig.10~13)

NOTE! The vinyl band is provided to keep good condition of load chain during transportation. You should remove the vinyl band AFTER THE HOIST IS LOCATED IN THE FINAL WORKING POSITION, AND HANGED CORRECTLY.

ABOUT KINKED OR TWISTED LOAD CHAIN

Kinked load chain should not be motored through the chain hoist body. With multi-fall models (2~5t rated load models) the load chain sometimes gets twisted by the lower hook turning a somersault between hanging chains. (Fig.13) Such a twist by somersault will not only lower the chain's load supporting capability, but would damage the load sheave or chain when the lower hook winded up near the upper limit even if unloaded. Such a twist by somersault shall be corrected before operating the chain hoist.

Fig.14

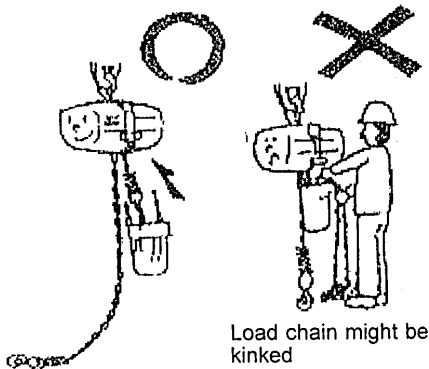


Fig.15

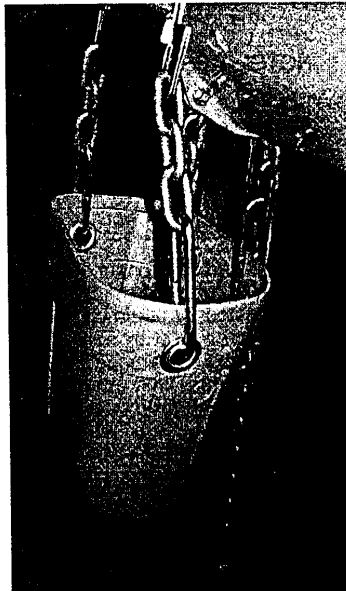


Fig.16 Do not twist the hanging links

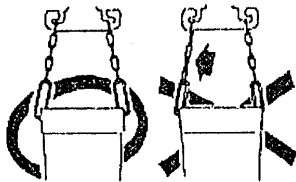


Fig.18 Too big is no good, too

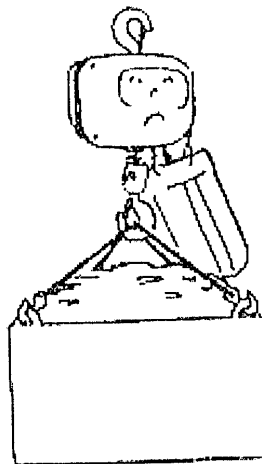


Fig.17 Cables should not pass inside of hangers



1.3. PROPER MOUNTING OF CHAIN BUCKET :

1.3.1. HOW TO MOUNT THE BUCKET CORRECTLY

The chain bucket must be mounted correctly. Do not operate without the chain bucket.

The chain bucket should be mounted to the hoist with the chain on the no load side (under the operating element B) with less than 50cm of load chain to avoid kinks and jamming of the load chain. (Fig.14)

Refer to the illustrations and mounting position.

Fig.15; Choose the right mounting position.

Fig.16; Don't twist any hanging chain.

Fig.17; Cables should not go between any 2 of the 4 hanging links.

1.3.2. USE THE CORRECT SIZE BUCKET

If the chain bucket is too small compared with the length of the load chain, the load chain will dangerously overflow the bucket.

Too big a chain bucket tends to be pushed upward by the load. (Fig.18)

Choose the correct size bucket corresponding to the hoist's lift, refer to the table below.

If you replace the load chain with a new one not equal to the primary one :

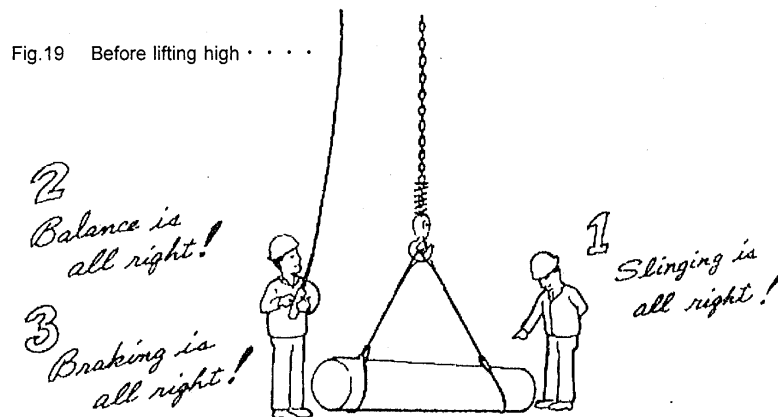


Fig.20



Fig.21

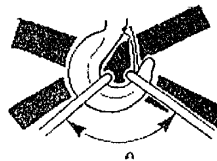
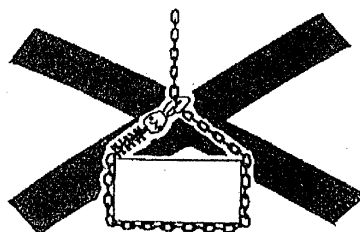


Fig.22



Fig.23



2. OPERATION

2.1. IMPORTANT INSTRUCTIONS FOR OPERATORS

DO NOT USE HOIST TO LIFT PEOPLE OR CARRY LOADS OVER PEOPLE
DO NOT LIFT MORE THAN THE RATED CAPACITY OF THE HOIST
DO NOT OPERATE A DAMAGED OR MALFUNCTIONING HOIST until necessary adjustments or repairs have been made
DO NOT OPERATE HOIST WITH A TWISTED, KINKED OR DAMAGED CHAIN
DO NOT LEAVE A LOAD suspended in the air UNATTENDED
ALIGN HOIST FOR A STRAIGHT LINE PULL. AVOID SIDE PULL OR END PULL
AVOID JOGGING PUSH BUTTONS OR QUICK REVERSING OF LOAD
BE SURE TO USE THE HOOK LATCH. If the latch is malfunctioning, do not use the hoist until repairs have been made.
DO PRACTICE DAILY INSPECTION BEFORE STARTING OPERATION EVERY DAY

2.2. GOOD OPERATING PRACTICES

The operator should not engage in any practice which will divert his attention while operating the hoist.
Before starting the hoist, the operator should be certain that all personal are clear.

Make it a rule to perform the 3 important checks below, before lifting the load high in the air. (Fig.19)

1. First, check the slinging position, when the load chain and lifting slings became stretched tight.
2. Next, check the balance of the load kept while only inches above the ground.
3. Then check the hoist's braking function by operating up and down a few inches several times.

If you felt something is not correct, lower the load immediately, and investigate what is not operating correctly.

2.3. SLINGING

2.3.1. CHECK LIFTING SLINGS

Never use any lifting sling not adequate for load capacity. Never use any lifting sling inferior in quality or condition.

2.3.2. SAFE AND SURE SLINGINGS

Note the load capacity of the lifting sling well enough, and at the same time, make sure the sling is not improperly hooked as shown in Fig.20~22.

Fig.20; DO LOCATE the sling PROPERLY.

Fig.21; Sling the load up with THE ANGLE BEING 60° OR LESS.

Fig.22; DO FUNCTION THE HOOK LATCH CORRECTLY.

THE LOAD CHAIN SHOULD NOT BE WRAPPED AROUND THE LOAD!! (Fig.23)

3. INSPECTION & MAINTENANCE

Inspection procedures are divided into 3 general classifications based upon the service intervals. Deficiencies should be carefully examined and corrected. The intervals between inspection will vary due to operating conditions.

3.1. DAILY INSPECTION

INSPECT THE FOLLOWING ITEMS DAILY BEFORE OPERATING HOIST.

3.1.1. T O P HOOK & PARTS

- Does the hook latch work perfectly?
- Isn't there any flaw or deformation, visually notable, on the hook or other major parts~
- Does the idle sheave, where applicable, rotate smoothly? Does it fit the load chain correctly?
- Are there any loose or missing parts?

3.1.2. LOWER HOOK & PARTS

- Does the hook latch work perfectly?
- Is hook rotation light and smooth?
- Isn't there any flaw or deformation, visually notable, on the hook or other major parts?
- Where there are two or more load chain falls, do the idle sheaves rotate smoothly? Do they fit the load chain correctly?
- Are there any loose or missing parts?

3.1.3. SWITCH SPRINGS

- Aren't those springs deformed or missing?

NOTE! OPERATION WITHOUT EITHER ONE OF THE SPRINGS IS DANGEROUS AND IS NOT PERMISSIBLE.

3.1.4. LOAD CHAIN

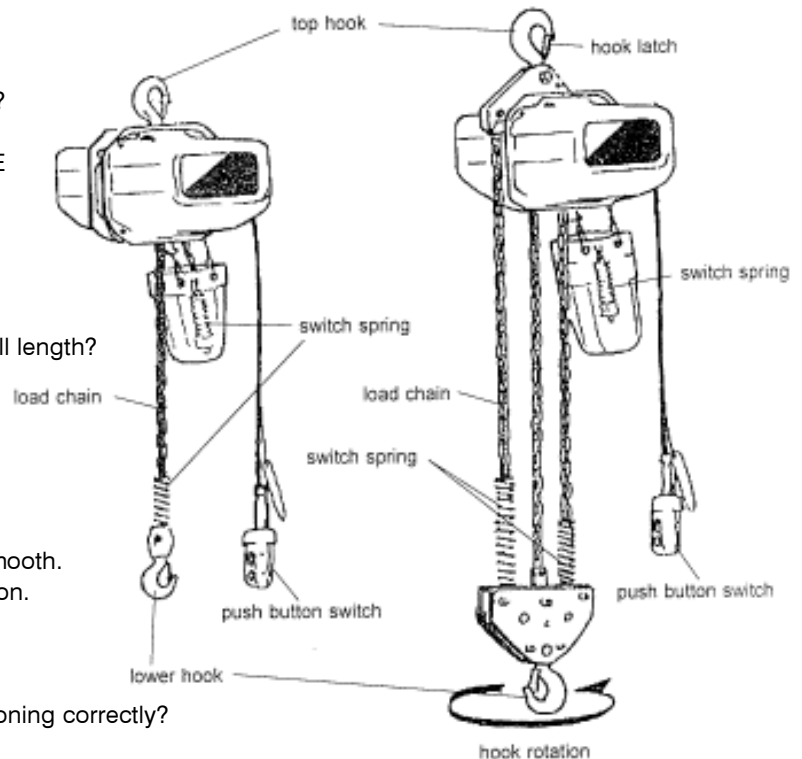
- Is the load chain well lubricated over its full length?
- Isn't there any wear, twist or distortion?

3.1.5. PUSH BUTTON SWITCH

- Check the case for cracks.
- Does the push button work smoothly? Return of the push button must also be smooth.
- There shall not be a lot of dirt contamination.

3.1.6. OVERALL OPERATION (Final check)

- Does the upper & lower limit switch functioning correctly?
- Does the brake functioning correctly?
- Isn't there any unusual noise caused during the up-down, traverse and travel movement of the hoist?



3.2. MONTHLY INSPECTION

NOTE! BEFORE THE BODY IS DISASSEMBLED PERFORM THE FOLLOWING, FIRST

- 1: Unload the hoist.
- 2: Lower the chain until about 10cm before the lower limit switch operates.
- 3: Disconnect the power supply.

3.2.1. MOTOR BRAKE

• **THICKNESS OF 531 LINING**

The thickness limit of 531 lining is 7.5mm. The brake disc must be replaced when thickness (Fig.26) is less than 7.5mm. (Initial thickness is 8mm)

• **How to measure**

1. Remove all the connectors connected to A and B in Fig.25.
2. Remove 361 electric component cover case
3. Pull and remove the insulated terminal shown (C) Fig.28.
(No problem even if wiring is interchanged when re-assembling) Brake coil of 575V model has 3 wires black, and 2 red. Loosen the screws and remove.
(No problem even if the wiring of 2 red lines are interchanged. But the black one should be connected to the same terminal)
4. Remove 543 rubber brake cover, 5442 and 5443 nuts to dismantle brake assy(Fig.25)

Then you can measure the lining thickness. Follow the reverse sequence to reassemble.

- NOTE!**
- Some models have only 1 lining with no 564b in use.
 - When assembling 564a and 564b, it must be same sequence when reassembly or problems will occur.
 - Where 2 linings are in use, the notch of one lining must be in the opposite direction to that of the other.

Fig.25

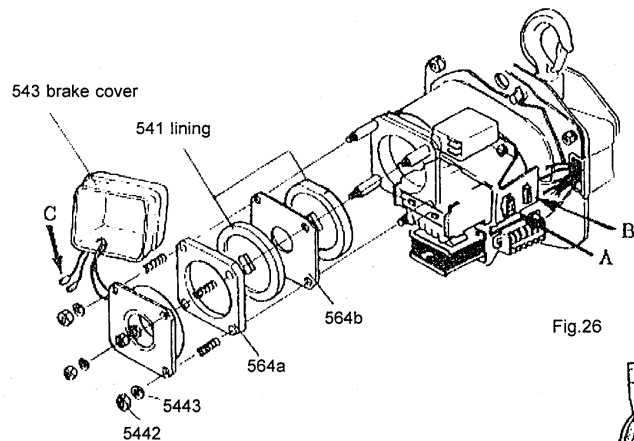
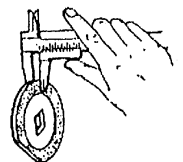


Fig.26



3.2.2. LOAD CHAIN

• **PITCH EXPANSION**

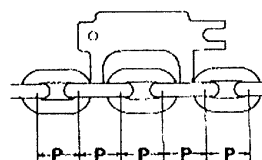
The load chain must be carefully checked over its full length. Insert a chain gauge at about every 50cm and check to see if the pitch has expanded.

If the pitch expansion is within the allowable limit the chain gauge will not go through, because its inserted part strikes the load chain as illustrated in Fig.27

if the pitch expansion has exceeded the allowable limit, the gauge will go through as illustrated in Fig.28.

Replace the chain if pitch expansion has occurred.

Fig.27



P : pitch

Fig.28

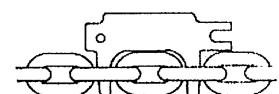
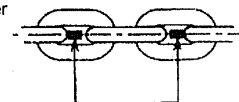


Fig.29 Correct chain gauge position illustrated. Insert the gauge along the center line with the chain straight.



- CHAIN DIAMETER THICKNESS

A load chain having a link with its diameter decreased due to corrosion, or any other reason must be replaced.

Inspect chain link thickness, where critical pitch expansion appears, using the gauge.

If the mouth of the gauge applied fits the link as illustrated in Fig.30, that means diameter is less than the allowable limit.

- OTHER VISUAL DEFECTS

If any FLAW or BEND is found, or if any person has welded the load chain, the load chain must be replaced.

Also any visually notable thermal effects, the load chain must be replaced.

NOTE! IF THE LOAD CHAIN IS IN A GOOD CONDITION EXCEPT ONLY ONE PART OR ONE LINK, THE CHAIN MUST BE REPLACED WITH A NEW ONE.

- WHEN REPLACING THE LOAD CHAIN

NOTE! The welded part of each vertical link must always face the outside in relation with the load sheave. In case 2 or more chains fall to the lower hook, the end link which is fixed by a chain stopper pin must be a vertical link, so that the chain can be installed without twisting.

3.2.3. HOOKS ASSEMBLIES

3.2.3.1. UPPER AND LOWER HOOKS

- HOOK MOUTH

If the hook has opened it must be replaced since it has lost the required strength and shock absorbing capability.

Replacement must be made when the dimension A shown in Fig.31 has exceeded the limit shown in the table below.

Do not use heat to repair the hook as the strength of the hook would be substantially reduced.

Rated Load

Capacity	Initial value A	Limit value A
0.5t	33±1 mm	36mm
1t	40±1 mm	43mm
2t	49±1 mm	53mm
3t	55±1 mm	59mm
5t	63±1 mm	68mm

Fig.30

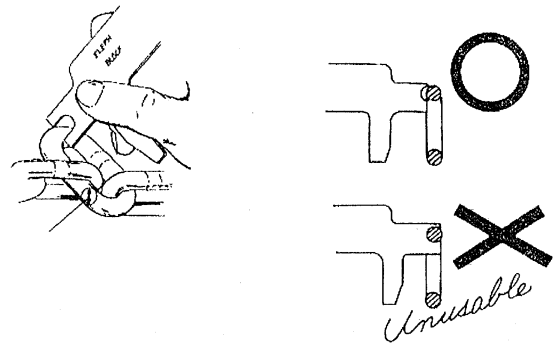
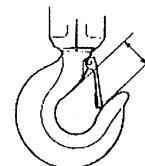


Fig.31



• **FLAWED, WORN OR BENT HOOKS**

Such hooks as are found in Fig.32-34 must also be replaced. Fig.32; A flaw is clearly seen. Fig.33, Wear exceeding the allowable limit. (specified below) Fig.34, A bend can be visually recognized.

Rated Load

Capacity	Initial value H	Limit value H
0.5t	1.9mm	17.1 mm
1 t	25mm	22.5mm
2t	35mm	31.5mm
3t	49mm	44.1 mm
5t	53mm	47.7mm

3.2.3.2. IDLE SHEAVE ROTATION & DEFORMATION (Not applicable to 0.5t model)

The idle sheave must be cleaned and checked if there is a lot of foreign matter on it. The following three points must be checked.

- Abnormalities on the sheave bearings or axis of rotation.
- Foreign matter collected on the idle sheave pocket
- Deformed idle sheave projections (Fig.35)

3.2.4. OTHER ITEMS TO BE CHECKED MONTHLY

3.2.4.1. CHECK FOR LOOSE BOLTS, SCREWS AND NUTS.

3.2.4.2. INSPECT FOR WORN, CORRODED, CRACKED OR DISTORTED PARTS SUCH AS PIN, BEARINGS, SHAFTS AND GEARS.

3.2.4.3. CHECK ELECTRICAL PARTS FOR SIGNS OF PITTING OR ANY DETERIORATION OF CONTROLS, LIMIT SWITCH AND PUSH BUTTON STATION.

3.2.4.4. FINALLY, DO THE DAILY INSPECTION BEFORE OPERATING THE HOIST.

3.3. ANNUAL INSPECTION

Check whole movement of hoist with rated load. Carefully check that even with rated load even with highest speed hoist perform safe and smooth movement.

Fig.32



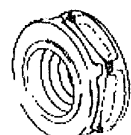
Fig.33



Fig.34



Fig.35



the area to be checked

normal



almost symmetrical

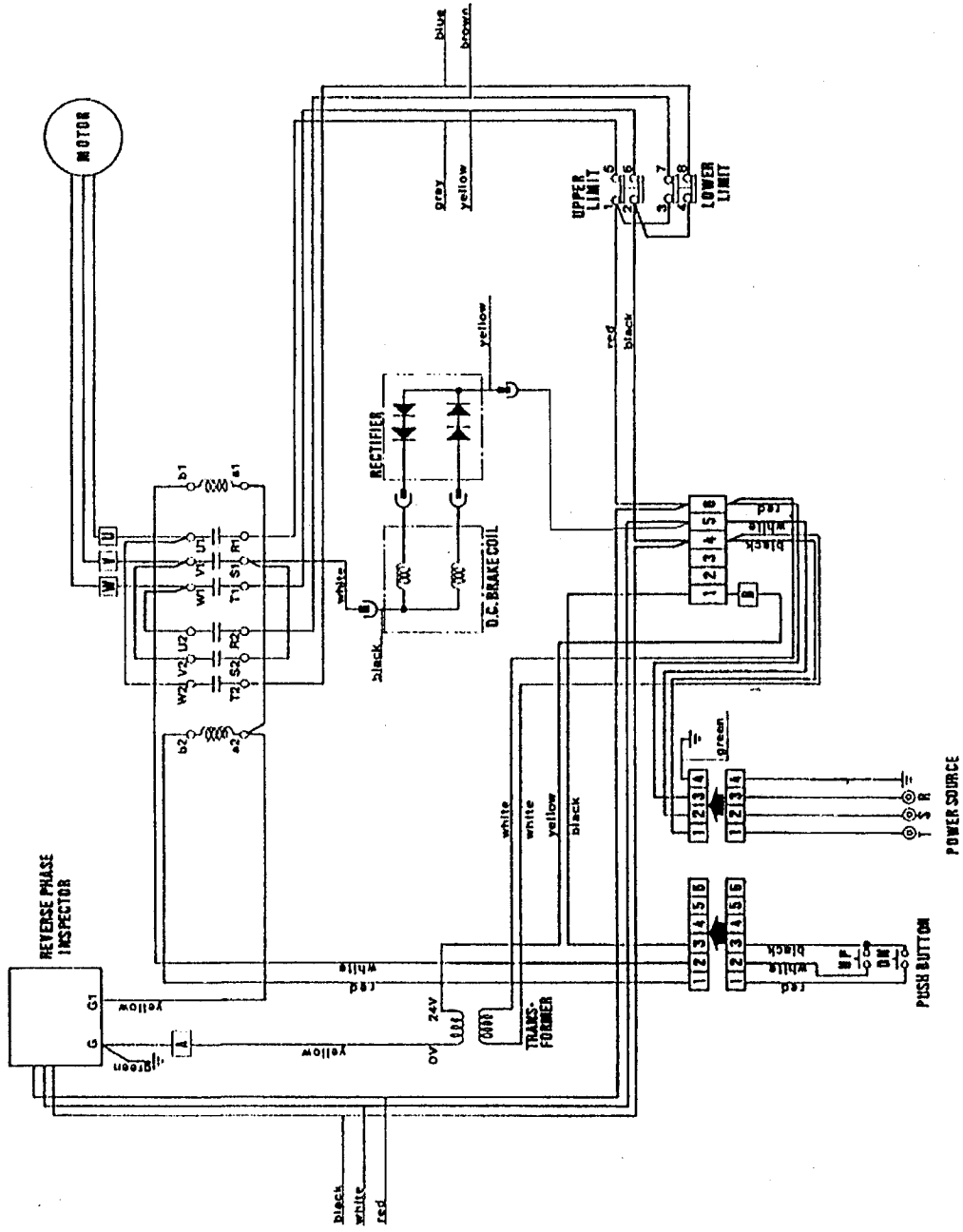
examples of deformation



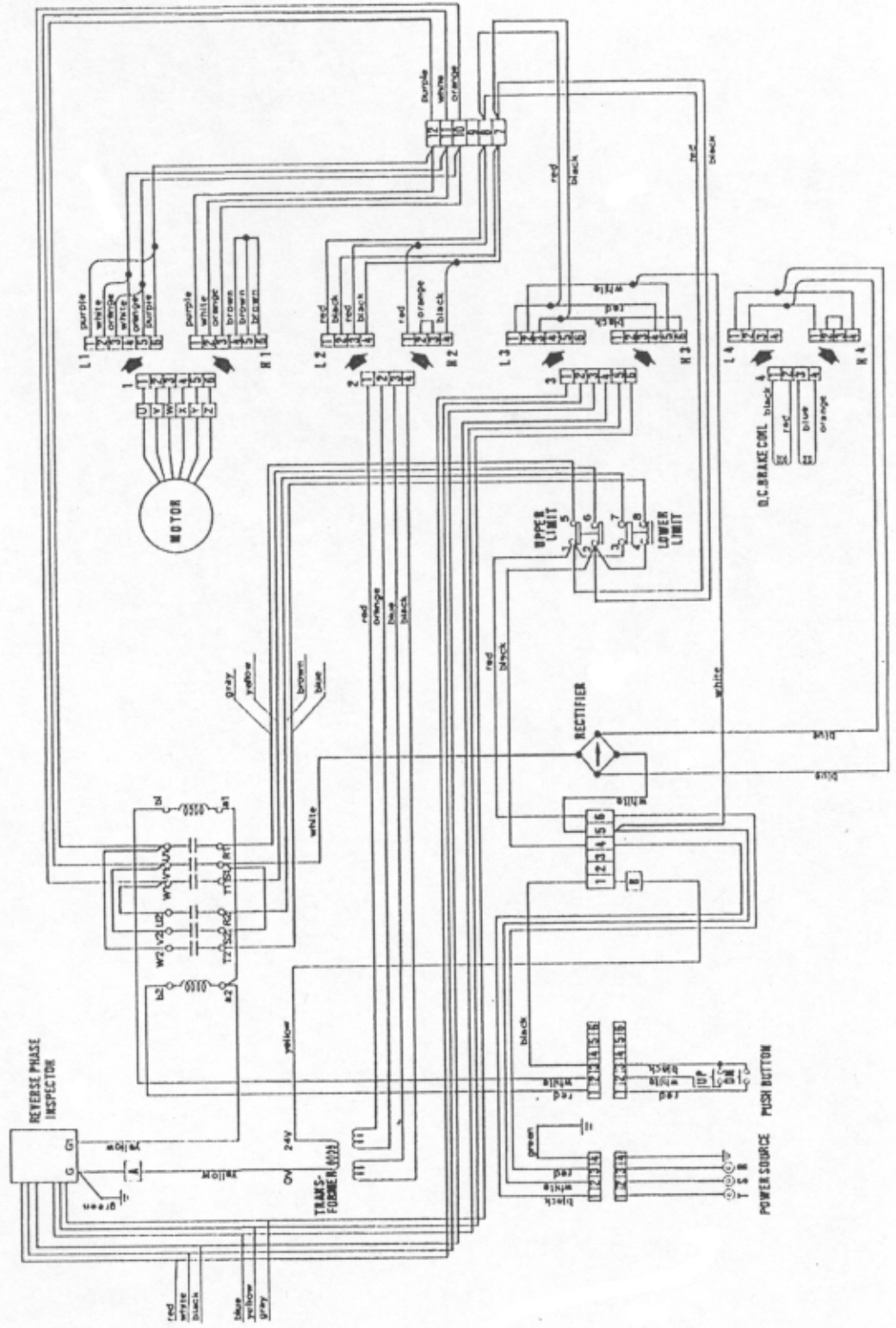
Deformation visually notable must not be accepted



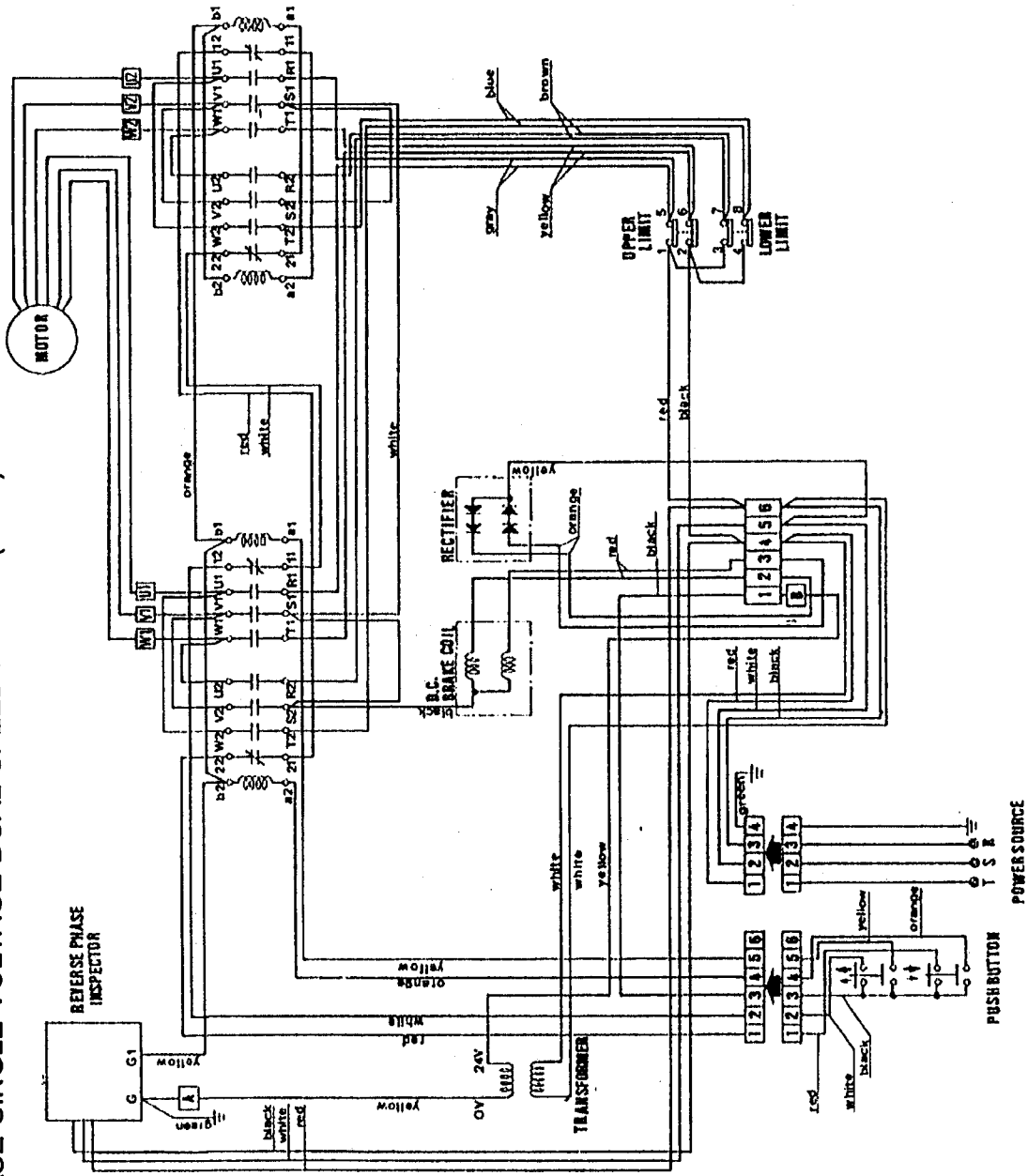
4. WIRING DIAGRAM
4.1. 3 PHASE SINGLE VOLTAGE SINGLE SPEED MODEL (575V)



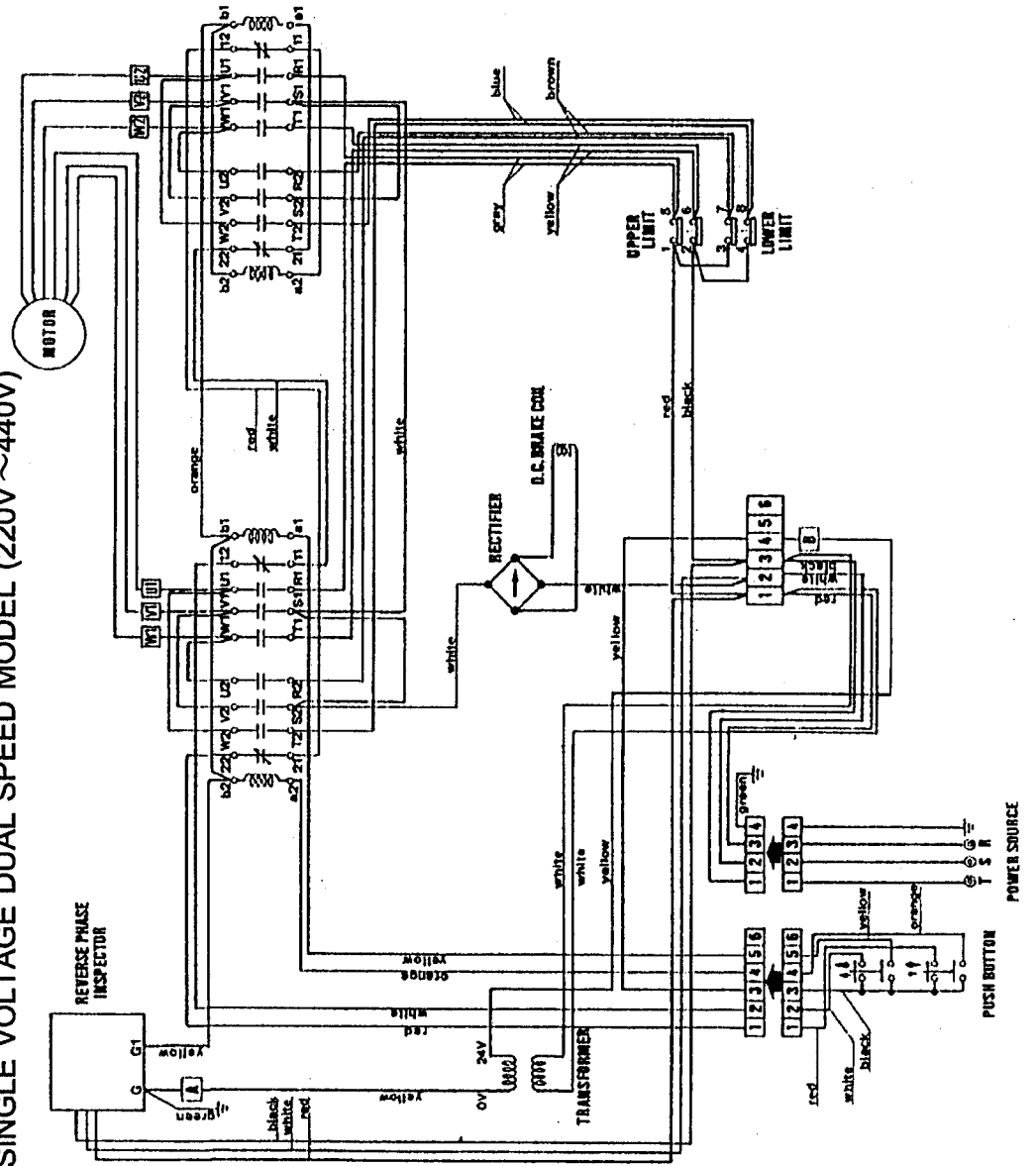
4. WIRING DIAGRAM
4.2. 3 PHASE DUAL VOLTAGE SINGLE SPEED MODEL



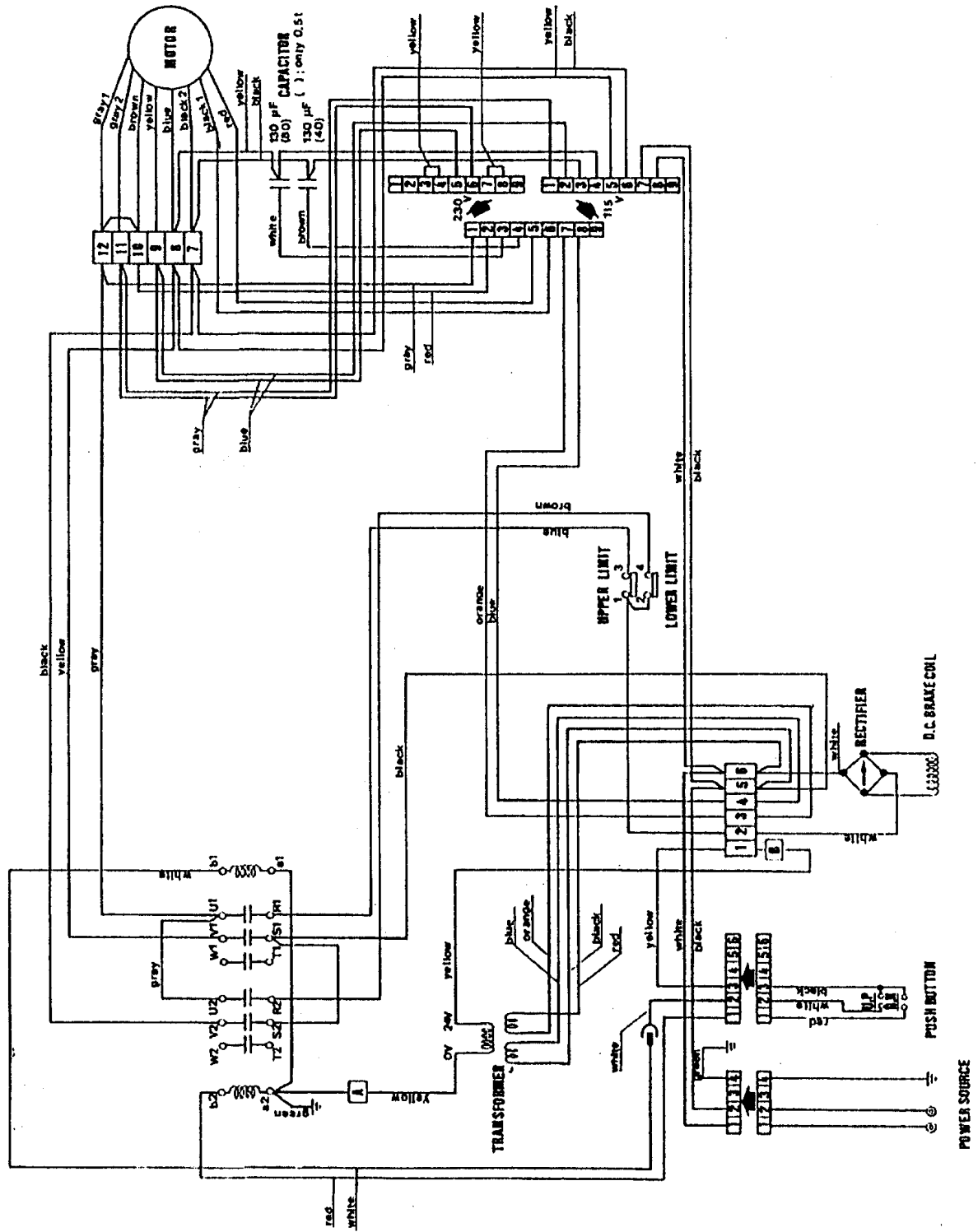
4. WIRING DIAGRAM
4.3. 3 PHASE SINGLE VOLTAGE DUAL SPEED MODEL (575V)



4. WIRING DIAGRAM
4.4. 3 PHASE SINGLE VOLTAGE DUAL SPEED MODEL (220V ~440V)



**4. WIRING DIAGRAM
4.5. 1 PHASE MODEL**



WARNING:- To Avoid Injury

1. DO read ANSIB30.16 safety standard for over head hoists and hoist manufacturer's Operating and Maintenance Instructions.
2. DO be familiar with hoist operating controls, procedures and warnings.
3. DO make sure hook travel is in the same direction as shown on controls.
4. DO make sure hoist limit switches function properly.
5. DO maintain firm footing when operating hoist.
6. DO make sure that load slings or other approved slinging attachments are properly sized and seated in the hook saddle.
7. DO make sure that the hook latch is closed and not supporting any part of load.
8. DO make sure that load is free to move and will clear all obstructions.
9. DO take up slack carefully, check load balance, lift a few inches and check load holding action before continuing.
10. DO avoid swinging of load or load hook.
11. DO make sure that all persons stay clear of the suspended load.
12. DO warn personnel of an approaching load.
13. DO protect load chain from weld spatter or other damaging contaminants.
14. DO promptly report any malfunction, unusual performance, or damage of the hoist.
15. DO inspect hoist regularly, replace damaged or worn parts, and keep appropriate records of maintenance.
16. DO use the hoist manufacturer's recommended parts when repairing a hoist.
17. DO use hook latches whenever possible. DONOT remove the hook latch.
18. DO apply lubricant to the load chain as recommended by the hoist manufacturer.
19. DO not lift more than rated load.
20. DO NOT use the hoist load limiting device to measure the load.
21. DO NOT use damaged hoist or hoist that is not working correctly.
22. DO NOT use the hoist with twisted, kinked, damaged or worn chain.
23. DO NOT lift a load unless chain is properly seated in chain wheel(s) or sprocket(s).
24. DO NOT use load chain as a sling or wrap chain around the load.
25. DO NOT lift a load if any binding prevents equal loading on all supporting ropes or chains.
26. DO NOT apply the load to the tip of the hook.
27. DO NOT operate unless load is centered under hoist.
28. DO NOT allow your attention to be diverted from operating the hoist.
29. DO NOT operate the hoist beyond limits of load chain travel.
30. DO NOT use limit switches as routine operating stops unless recommended. They are emergency devices only.
31. DO NOT use hoist to lift, support, or transport people.
32. DO NOT lift loads over people.
33. DO NOT leave a suspended load unattended unless specific precautions have been taken.
34. DO NOT allow sharp contact between two hoists or between hoist and obstructions.
35. DO NOT allow any part of hoist to be used as a ground for welding. When gas welding on, ensure that the load chain or hook is not subject to heat.
36. DO NOT allow any part of hoist to be touched by a live welding electrode.
37. DO NOT remove or obscure the warnings on the hoist.
38. DO NOT adjust or repair a hoist unless qualified to perform hoist maintenance.
39. DO NOT attempt to lengthen the load chain or repair damaged load chain.
40. DO NOT apply a sudden load to the chain such as pushing a load off a ledge and allowing the chain to 'catch' it.
41. DO be sure that the hoist is unloaded and power supply is disconnected before performing maintenance and repair procedures.