



# TOOL, EQUIPMENT & SAFETY NEW PRODUCT SUPPLEMENT 2017

*sellstrom*<sup>®</sup>

PPE Now Available in Canada 🇨🇦





We've been your proud  
**CANADIAN PARTNER**  
for over 100 years

Designed to be the **BEST TOOLS  
AND SAFETY EQUIPMENT**  
so you can work with confidence



**RIGOROUSLY  
TESTED** to meet all  
industry standards

Available from our warehouses and  
distribution partners across Canada,  
we are **EVERYWHERE  
YOU NEED US TO BE**

Engineered with the  
Canadian professional  
worker's **SAFETY**  
in mind



# TABLE OF CONTENTS



## Sellstrom 2

<b>Face Shields</b> .....	<b>4-10</b>	Premium Series.....	<b>18-19</b>
Premium Multi-Purpose.....	<b>5-6</b>	Advantage Plus Series.....	<b>20-21</b>
380 Series - Premium Dual Crown.....	<b>7</b>	Advantage Series.....	<b>22-23</b>
390 Series - Premium Single Crown.....	<b>8</b>	Bifocals.....	<b>24</b>
Premium Single Crown.....	<b>8-9</b>	<b>Germicidal Cabinet</b> .....	<b>25</b>
Advantage Series.....	<b>10</b>	<b>Sta-Clear™ Lens Cleaning Products</b> .....	<b>26</b>
<b>Goggles</b> .....	<b>11-15</b>	<b>Eyewash Station</b>	
Premium Specialty.....	<b>11</b>	- <b>Portable Emergency</b> .....	<b>27</b>
Premium.....	<b>12-13</b>	<b>Hearing Protection</b> .....	<b>28</b>
Advantage Plus Series.....	<b>14</b>	Ear Plugs - Premium Reusable.....	<b>29</b>
Advantage Series.....	<b>15</b>	Ear Muffs - Premium Dielectric.....	<b>30</b>
<b>Safety Glasses</b> .....	<b>16-21</b>	Ear Muffs - Premium Series.....	<b>31</b>
Premium Sealed.....	<b>16-17</b>	<b>Knee Pads - Premium Grade</b> .....	<b>32-33</b>
		<b>Welding Blankets</b> .....	<b>34</b>

## Pioneer & PeakWorks 35

<b>Hi-Viz Clothing</b> .....	<b>36-39</b>	<b>Respirators</b> .....	<b>42</b>
Accessories.....	<b>37</b>	<b>Headwear</b> .....	<b>42</b>
Safety Rainwear.....	<b>38</b>	<b>Traffic Safety</b> .....	<b>40, 43</b>
Heavyweight Rainwear.....	<b>39</b>	<b>Tool Tethering System</b> .....	<b>44-45</b>
<b>FR Headwear</b> .....	<b>41</b>		







## Tools & Equipment 46

<b>Shop Equipment</b> .....	<b>48-49</b>	<b>Strongarm</b> .....	<b>54</b>
Parts Washers.....	<b>48</b>	Tire Service Tools.....	<b>54</b>
Butane Torches.....	<b>49</b>	<b>STARTECH</b> .....	<b>55-57</b>
<b>Abrasives</b> .....	<b>50</b>	COB Lighting.....	<b>55</b>
Flap Discs (For Angle Grinders).....	<b>50</b>	Flashlights.....	<b>56</b>
<b>Air Tools</b> .....	<b>50-51</b>	Work Site Lights.....	<b>57</b>
Air Hoses.....	<b>50-51</b>	<b>ITC</b> .....	<b>58</b>
<b>Material Handling</b> .....	<b>52-53</b>	Angle Grinders.....	<b>58</b>
Beam Clamps.....	<b>52</b>	Impact Sockets.....	<b>58</b>
Manual Trolleys.....	<b>53</b>		

## Merchandisers & POP 59-61

Index.....	<b>62</b>
------------	-----------

## ICON LEGEND

- For Steel..... 
- For Stainless Steel..... 
- CSA..... 
- cUL..... 
- Flame Resistant..... 
- Arc Resistant..... 
- Waterproof..... 



A close-up, side-profile shot of a man with a beard wearing a black and red safety helmet. The background is a blurred workshop or construction site with wooden beams and metal structures.

***sellstrom***®

Product that works.

**PERSONAL PROTECTIVE EQUIPMENT**







## DP4 SERIES - PREMIUM MULTI-PURPOSE FACE SHIELDS

- Sellstrom's exclusive multi-purpose DP4 face shield system has been an industry leader for more than 15 years
- The DP4 offers an incredible range of face protection solutions
- All DP4 face shields can now be fitted with optional chin guard for added below-the-neck protection during cutting and grinding operations

### DP4 Face Shield Only:

- As a standard face shield, the DP4's specially designed molded polycarbonate window curves naturally to fit facial contours
- Offers exceptional panoramic views with virtually no distortion
- Window meets high impact standards and is chemical resistant
- Available in clear anti-fog full-sized window option

- Standard DP4 face shields feature a premium ratcheting headgear for maximum operator comfort and convenience

### DP4 Face Shield with Flip Up / Flip Down IR Windows:

- The DP4 face shield is also available featuring a unique spring-mounted flip-up/flip-down IR window (4.375" x 9.25" x 0.070")
- It's easy and safe – by keeping the full-size DP4 clear window in the down position at all times, the operator can flip the spring-mounted IR shaded window up or down, providing uninterrupted face protection during cutting and grinding operations

### Flip visor available in:

- Shade 5 IR for: oxy/acetylene cutting, brazing and plasma cutting
- Shade 8 IR for: oxy/acetylene welding and plasma cutting

### DP4 Safety Standards

- All DP4 models meet or exceed **ANSI Z87.1-2015 standards**
- All models are **cUL certified to CAN/CSA Z94.3 standards**
- **Model S32151** is also **CSA certified to CAN/CSA Z94.3-2015 standards**



S32010

### DP4 Series - Crown, Window & Ratcheting Headgear Only

- Face shields come with:
  - Stylish crown
  - Full 9" x 12.125" x 0.060" molded polycarbonate AF window
  - Premium ratcheting headgear suspension (S32011)

Prod. No.	Crown	Suspension	Window Tint	Coating	Chin Guard
S32010	Black	Ratcheting	Clear	Anti-Fog	No
S32210	Black	Ratcheting	Clear	Anti-Fog	Yes



S32210



# FACE SHIELDS - PREMIUM MULTI-PURPOSE



S32151



S32181



S32251

## DP4 Series - with Flip Up IR Window & Ratcheting Headgear

- Multi-purpose face shields come with:
  - Stylish crown
  - Full 9" x 12.125" x 0.060" molded polycarbonate AF window
- 4.375" x 9.25" x 0.070" flip-up/flip-down IR visor
- Premium ratcheting headgear suspension (S32011)

Prod. No.	Crown	Suspension	Window Tint	Coating	Chin Guard	Flip Visor
S32151	Black	Ratcheting	Clear	Anti-Fog	No	Shade 5 IR
S32181	Black	Ratcheting	Clear	Anti-Fog	No	Shade 8 IR
S32251	Black	Ratcheting	Clear	Anti-Fog	Yes	Shade 5 IR
S32281	Black	Ratcheting	Clear	Anti-Fog	Yes	Shade 8 IR



S32151

## FACE SHIELDS - PREMIUM MULTI-PURPOSE

### DP4 Series - Replacement Parts

Prod. No.	Description	Model Compatibility
S32000	Black Crown for DP4 Face Shields	Fits all standard face shields
S32001	Black Crown for DP4 Face Shield (Flip-Up IR Visor Models)	Fits all flip-up face shields
S32011	Replacement Ratcheting Headgear for DP4 Face Shield	S32010, S32151, S32181, S32210, S32251, S32281
S32100	9" x 12.125" x 0.060" Clear Anti-Fog Window for DP4 Face Shield	Fits all DP4 models
S32155	4.375" x 9.25" x 0.070" Shade 5 IR Visor for DP4 Face Shield	S32151, S32152, S32251
S32188	4.375" x 9.25" x 0.070" Shade 8 IR Visor for DP4 Face Shield	S32181, S32182, S32281



S32000



S32011



S32155





**AN  
AMERICAN  
LEGEND!**

# 380 SERIES - PREMIUM DUAL CROWN FACE SHIELDS



- Sellstrom's 380 Series dual crown face shields have been the industry standard for decades
- **Made in the U.S.**, these premium face shields are manufactured using superior, extra wide acetate windows
- Acetate windows are inherently chemical and scratch resistant, therefore eliminating the need to apply additional hard coat treatments
- Anti-fog models are treated using an exclusive Sta-Clear™ chemical solution that is superior to other anti-fog treatments

- These face shields are virtually 100% fog free
- The 380 Series "crown and chin" combination offers an exclusive extra-wide side window, as well as oversized crown and chin guard
- You can't buy better protection from splashes, flying particles and debris
- Complete units feature premium 6-1/2" x 19-1/2" x 0.040" clear, Sta-Clear™ Anti-Fog, Shade 5 IR windows
- Windows attach using exclusive Sellstrom patterned pin mount design

- Available with Sellstrom's exclusive ratcheting headgear suspension (S27051)

## 380 Series Safety Standards

- 390 Series face shields meet or exceed **ANSI Z87.1-2015 standards**
- All 380 Series face shields are **cUL certified to CAN/CSA Z94.7 standards.**

## 380 Series - Dual Crown, Window & Ratcheting Headgear

- Face shields come with:
  - Extra-large high impact blue crown and chin protector
  - Premium acetate extra-wide scratch resistant window
  - Premium ratcheting headgear suspension

Prod. No.	Crown	Chin	Suspension	Window Tint	Coating
<b>S38110</b>	Blue	Blue	Ratcheting	Clear	Uncoated
<b>S38140</b>	Blue	Blue	Ratcheting	Clear	Sta-Clear™ Anti-Fog
<b>S38150</b>	Blue	Blue	Ratcheting	Shade 5 IR	Uncoated



S38110

## 380 Series - Replacement Windows

- Sellstrom carries a wide range of replacement acetate windows
- Available in clear, Sta-Clear™ Anti-Fog and Shade 5 IR
- All windows fit the Sellstrom 380 Series dual crown platform
- Window attachment pattern exclusive to Sellstrom's 380 Series crown

Prod. No.	Window Dimensions	Window Tint	Coating
<b>S36000</b>	6-1/2" x 19-1/2" x 0.040"	Clear	Uncoated
<b>S36040</b>	6-1/2" x 19-1/2" x 0.040"	Clear	Sta-Clear™ Anti-Fog
<b>S36050</b>	6-1/2" x 19-1/2" x 0.060"	Shade 5 IR	Uncoated



S36000

## 390 FACE SHIELDS - PREMIUM SINGLE CROWN

- Sellstrom's 390 Series face shields have been the industry standard for decades
- **Made in the U.S.**, these premium face shields are manufactured using superior acetate windows
- Acetate windows are inherently chemical and scratch resistant, therefore eliminating the need to apply additional hard coat treatments
- Anti-fog models are treated using an exclusive Sta-Clear™ chemical solution that is superior to other anti-fog treatments
- These face shields are virtually 100% fog free
- The shield curves naturally to fit facial contours – excellent protection from splash, chemical splash, particles and flying debris
- Extra-large high impact crown provides excellent above-the-head coverage
- Complete units available with standard 8" x 12" x 0.40" clear windows
- Extra-large 8" x 16" x 0.40" windows are also available (optional)
- Windows attach using exclusive Sellstrom patterned pin mount design
- Headgear models available with Sellstrom's exclusive ratcheting headgear suspension

### 390 Series Safety Standards

- 390 Series face shields meet or exceed **ANSI Z87.1-2015 standards**
- All 390 Series face shields are **cUL certified to CAN/CSA Z94.3 standards**



Single crown style is lightweight and allows for increased air circulation.

Impact resistant acetate windows available in clear, anti-fog and Shade 5 IR.

Available with adjustable ratchet headgear suspension for a custom fit at the turn of the knob.

Patterned pin mount design allows for quick and simple window replacement - requires no tools.

Meets ANSI Z87.1+ High Impact standards and cUL certified to meet CAN/CSA Z94.3 standards.

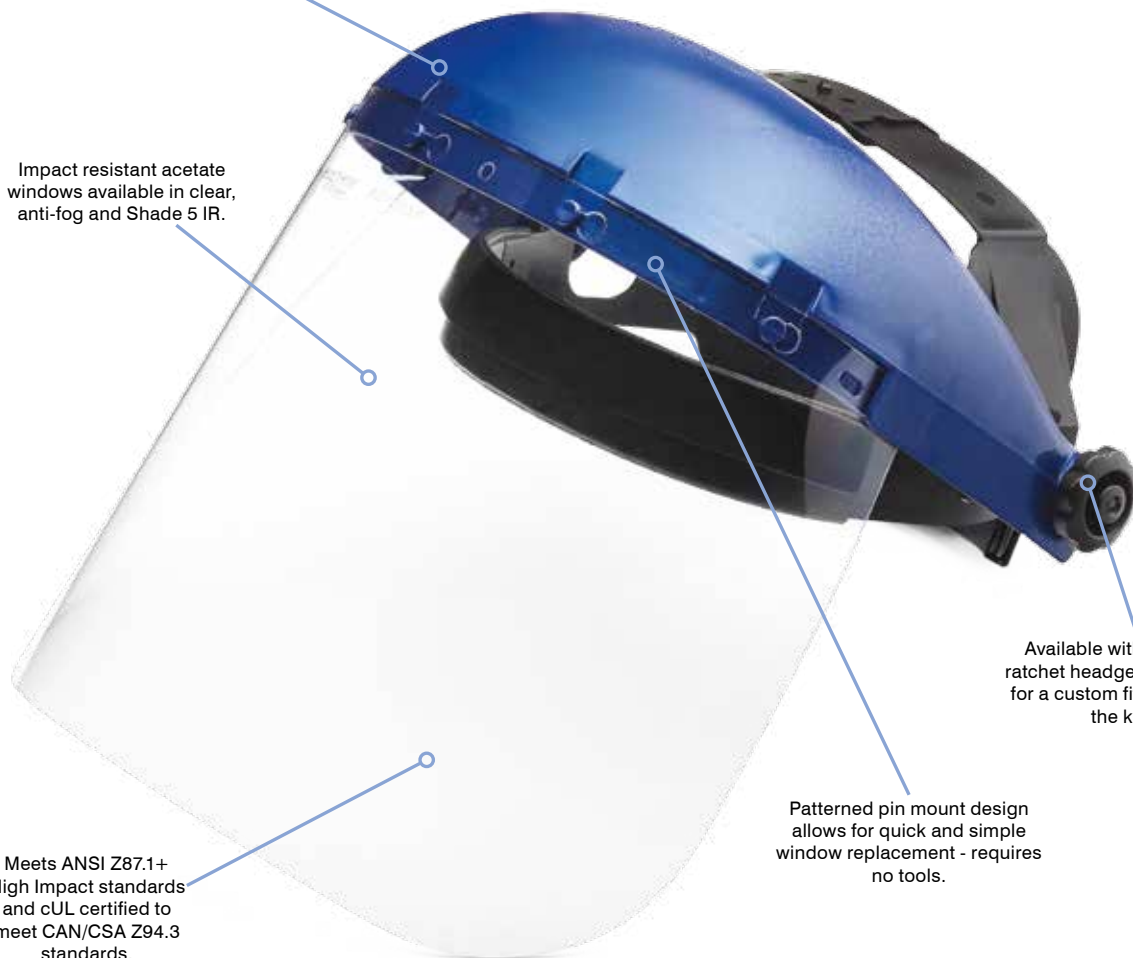



# FACE SHIELDS - PREMIUM SINGLE CROWN

## 390 Series - Single Crown, Window & Ratcheting Headgear

- Face shields come with:
  - Extra-large high impact blue crown
  - Premium acetate scratch resistant window (two sizes available)
  - Premium ratcheting headgear suspension

Prod. No.	Crown	Suspension	Window Dimensions	Window Tint	Coating
<b>S39110</b>	Blue	Ratcheting	8" x 12" x 0.040"	Clear	Uncoated
<b>S39140</b>	Blue	Ratcheting	8" x 12" x 0.040"	Clear	Sta-Clear™ Anti-Fog



S39110

## 390 Series - Crown Only

- Face shield comes with:
  - Extra-large high impact blue crown
  - Premium ratcheting headgear suspension
- Window ordered separately

Prod. No.	Crown	Suspension
<b>S39100</b>	Blue	Ratcheting



## 390 Series - Replacement Windows

- Sellstrom carries a wide range of replacement/optional premium acetate windows
- Available in clear uncoated and Sta-Clear™ Anti-Fog options
- All windows can be fitted to the Sellstrom 390 Series crown

Prod. No.	Window Dimensions	Window Tint	Coating
<b>S35000</b>	8" x 12" x 0.040"	Clear	Uncoated
<b>S35040</b>	8" x 12" x 0.040"	Clear	Sta-Clear™ Anti-Fog
<b>S35100</b>	8" x 16" x 0.040"	Clear	Uncoated



S35000

## Replacement Face Shield Windows - Universal

- Sellstrom offers a wide range of universal windows to meet your every needs
- Hole mounting patterns are designed to fit on Sellstrom's 301 Series crowns as well as many other common brands in the North American market
- All models meet ANSI Z87.1 + high impact standards

Prod. No.	Window Dimensions	Description
<b>S37040</b>	8" x 16" x 0.040"	Clear Molded Acetate Window - Anti-Fog
<b>S37600</b>	8" x 15-1/2" x 0.040"	Clear Aluminum Bound Window
<b>S37601</b>	8" x 15-1/2" x 0.040"	Clear Polycarbonate Window



S37040

See page 10 for 301 Series face shields and crowns

## FACE SHIELDS - ADVANTAGE SERIES

### 301/303 ADVANTAGE SERIES

- Sellstrom offers a complete range of basic, economically priced face shields and windows under the Advantage Series program
- ABS injection molded crowns feature universal bracket pin pattern for use with universal mount windows
- Complete units available in single crown (301 Series) and dual crown (303 Series) versions with ratcheting headgear suspension
  - Complete with standard or aluminum bound windows and ratcheting headgear, or
  - Purchase the crown and headgear only and choose from a wide range of universal mount windows

#### Advantage Series Safety Standards

- All models meet **ANSI Z87.1 + High-Impact standards** and are **cUL certified to CAN/CSA Z94.3 standards**

#### 301 Series - Single Crown Ratcheting Headgear Only

- Grey ABS crown and comfortable ratcheting headgear
- Crown can be used to mount all Sellstrom universal face shield windows as well as many other common brands found in the North American market
- Extremely versatile face shield mounting system



S30100

Prod. No.	Crown	Suspension
S30100	Grey	Ratcheting

#### 301 Series - Single Crown, Window & Ratcheting Headgear

- Grey ABS crown and comfortable ratcheting headgear suspension
- Crown can be used to mount all Sellstrom universal face shield windows as well as many other common brands found in the North American market
- Comes complete with standard or aluminum bound 8" x 15-1/2" x 0.040" clear polycarbonate window
- Extremely versatile face shield mounting system



S30110

Prod. No.	Crown	Suspension	Window	Window Tint	Coating
S30110	Grey	Ratcheting	Aluminum Bound	Clear	Uncoated
S30120	Grey	Ratcheting	Standard	Clear	Uncoated

See page 9 for a wide range of universal windows for 301 Series face shields.

#### 303 Series - Dual Crown, Window & Ratcheting Headgear

- New to Sellstrom, this face shield offers both a crown and a chin guard for added below-the-neck protection
- Comfortable ratcheting headgear suspension
- Window can be easily replaced (S37599)

Prod. No.	Crown	Chin	Suspension	Window Tint	Coating
S30310	Grey	Grey	Ratcheting	Clear	Uncoated



S30120

#### Replacement Window for S30310

Prod. No.	Window Tint	Coating	Fits
S37599	Clear	Uncoated	S30310



S30310

# GOGGLES - PREMIUM SPECIALTY

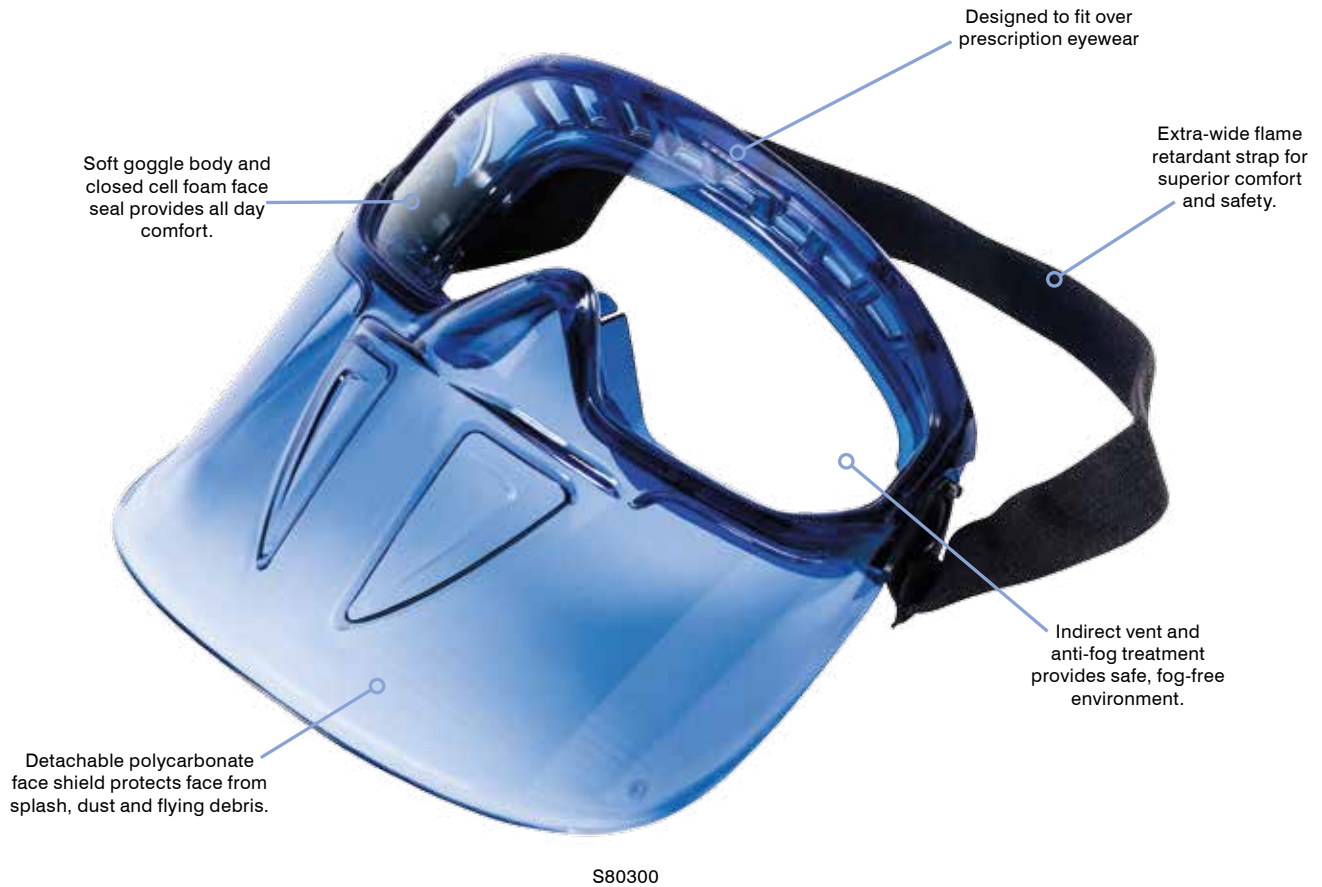

S80300

## GPS300 - Series Premium Safety Goggle with Detachable Face Shield

- Sellstrom introduces their new premium goggle with detachable face shield
- Stylish soft goggle body and closed cell foam face seal conforms to your face
- Comfortable, snug seal provides maximum protection against liquids and dust
- Optically correct polycarbonate lens provides exceptional panoramic views
- Specially designed to fit over prescription eyewear
- Indirect vents along with Anti-Fog lens coating provides superior ventilation and a safe, fog-free working environment
- Indirect vents provide superior protection against dust and chemical splashes
- The GPS300 features an added polycarbonate face shield designed to protect your face from splash, dust and flying debris
- Face shield is easily detachable
- Extra-wide flame retardant strap is swivel-mounted to goggle
- Provides 99.9% UV protection
- Ideal for industrial, mining, cutting, grinding, construction, woodworking, machine shop and pressure washing applications
- Meets **ANSI Z87.1-2015** and is **CSA certified to CAN/CSA Z94.3-2015 standards**



Prod. No.	Body Colour	Vent Type	Lens	Coating	Tint
S80300	Blue	Indirect	Single	Anti-Fog	Clear





## GOGGLES - PREMIUM

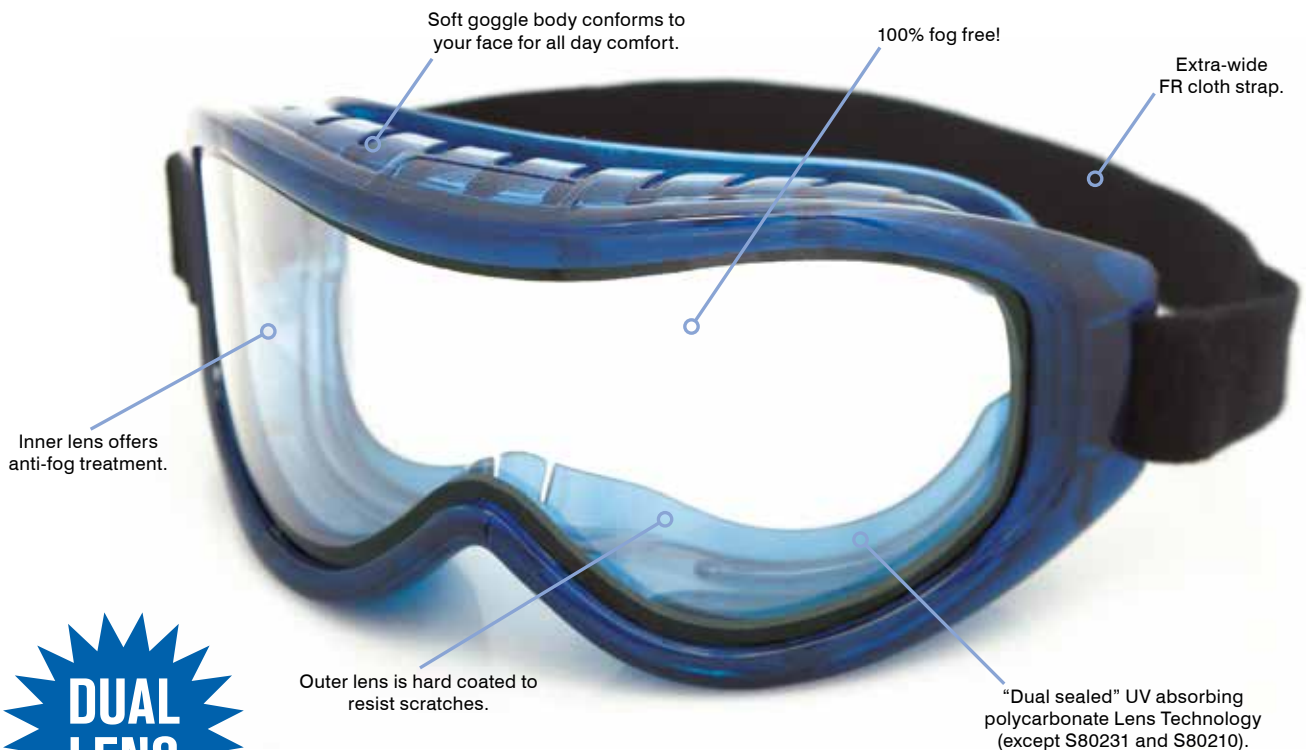

S80200

**DUAL  
LENS**

- The Odyssey II premium goggle series has been a market leader for 15+ years
- Unique "Dual Sealed" UV absorbing polycarbonate lens technology (except single lens Clean Room and Shade 5 cutting models)
- Dual lens models offer Anti-Fog treatment on inside lens – Anti-Scratch on outside lens
- Industrial, Chemical Splash and Shade 5 models feature top and bottom Indirect Vents providing superior ventilation and the safest operator conditions
- 100% fog free, even in the worst conditions
- Stylish soft goggle body conforms to your face, providing a comfortable yet snug seal and maximum protection against liquids and dust

- Exceptional panoramic views
- Specially designed to fit over prescription eyewear
- Simply the best goggle in the market
- All models feature replaceable lenses

### Odyssey II Safety Standards

- All models meet **ANSI Z87.1-2015** and are **cUL certified to CAN/CSA Z94.3 standards**
- **Model S80200** is also **CSA certified to CAN/USA Z94.3 2015 standards**

**OVER  
1,000,000  
GOGGLES SOLD  
IN THE USA**

## GOGGLES - PREMIUM

### Odyssey II Series Industrial Dual Lens Goggle

- Our most popular Odyssey II model
- Ideal for a wide variety of applications including construction sites, shop use and general industrial workplace protection
- Complete with extra-wide flame retardant cloth strap (S80246)

Prod. No.	Body Colour	Vent Type	Lens	Coating	Tint
S80200	Blue	Indirect	Dual	HC/AF	Clear



Our most popular Odyssey II model

### Odyssey II Series Chemical Splash Dual Lens Goggle

- Specifically designed for those applications where the risk of a chemical splash exists
- Complete with extra-wide grey, latex-free neoprene strap

Prod. No.	Body Colour	Vent Type	Lens	Coating	Tint
S80201	Blue	Indirect	Dual	HC/AF	Clear



### Odyssey II Series Clean Room Goggle

- Specifically designed for clean room applications
- Unlike traditional, single-use clean room goggles, these premium goggles are reusable and designed for multi-use clean room applications
- Can be autoclaved
- Top-vented body with clear uncoated lens
- CE certified
- Complete with extra-wide grey, latex free neoprene strap (S80251)

Prod. No.	Body Colour	Vent Type	Lens	Coating	Tint
S80231	Blue	Top-Vented	Single	Uncoated	Clear



### Odyssey II Series Shade 5 Cutting Goggle

- Features a durable Shade 5 IR (single) lens
- Specifically designed for grinding, chipping and brazing operations in fabrication and welding shop applications
- Complete with extra-wide flame retardant strap
- Packed in convenient poly bag

Prod. No.	Body Colour	Vent Type	Lens	Coating	Tint
S80210	Black (High Temp)	Indirect	Single	Uncoated	Shade 5 IR



## GOGGLES - ADVANTAGE PLUS SERIES

### GM500 Safety Goggle

- The GM500 goggle combines comfort, fit, safety and great looks in one product
- Stylish orange/black co-molded soft TPR body provides comfort and fit
- Molded curved polycarbonate lens provides outstanding panoramic views with virtually no distortion
- Top and bottom indirect vents along with Anti-Fog lens coating provides superior ventilation and a safe, fog-free working environment
- Indirect vents provide superior protection against dust and chemical splashes
- Swivel mounted extra-wide flame retardant strap
- Specially designed to fit over some prescription eyewear
- Provides 99.9% UV protection
- Meets **ANSI Z87.1-2015** and is **CSA certified to CAN/CSA Z94.3-2015 standards**



Prod. No.	Body Colour	Vent Type	Lens	Coating	Tint
S82500	Orange/Black	Indirect	Single	Anti-Fog	Clear



## GOGGLES - ADVANTAGE SERIES

- Green tinted flexible PVC body ensures proper fit
- Polycarbonate UV absorbing clear lenses
- Adjustable 18" green flame retardant head band (S22448)
- Available with Anti-Fog lens coating
- Meet **ANSI Z87.1-2015** and are **cUL certified to CAN/CSA Z94.3-2015 standards**
- **Made in the U.S.**

### 882 Series Indirect Vent Chemical Splash Safety Goggles

- Indirect vent chemical splash series
- Protects against liquid, dust, smoke and chemical splash environments

Prod. No.	Body Colour	Vent Type	Coating	Tint
S88200	Green	Indirect	Uncoated	Clear
S88210	Green	Indirect	Anti-Fog	Clear



S88200

## GOGGLES - ADVANTAGE SERIES

- Our most economically priced goggle series
- Clear flexible PVC body ensures proper fit
- Polycarbonate UV absorbing clear lenses
- Three vent options available to fit your every need
- Adjustable 18" black flame retardant head band (S22448)
- Available with Anti-Fog lens coating
- Meets **ANSI Z87.1-2015** and are **CSA certified to CAN/CSA Z94.3-2015 standards**

### 810 Series Direct Vent Safety Goggle

- Direct vent series
- Provides maximum air flow and protection against flying debris

Prod. No.	Body Colour	Vent Type	Coating	Tint
S81000	Clear	Direct	Uncoated	Clear





## GOGGLES - ADVANTAGE SERIES

### 812 Series Indirect Vent Chemical Splash Safety Goggles

- Indirect vent chemical splash series
- Protects against liquid, dust, smoke and chemical splash environments

Prod. No.	Body Colour	Vent Type	Coating	Tint
S81200	Clear	Indirect	Uncoated	Clear
S81210	Clear	Indirect	Anti-Fog	Clear



S81200

### 812 Series Non-Vented Safety Goggle

- Non-vented goggle
- Offers best protection from liquids and dust particles

Prod. No.	Body Colour	Vent Type	Coating	Tint
S81220	Clear	Non-Vented	Anti-Fog	Clear



## GOGGLES - WELDING

- Sellstrom carries one of the widest ranges of welding goggles in the industry
- All goggles feature soft, flexible green PVC bodies for excellent comfort and fit
- Top and bottom indirect vents provide superior ventilation and a safe, fog-free working environment (except S85150 eye cup goggle)
- Indirect vents provide superior protection against dust and chemical splashes
- Meet **ANSI Z87.1-2015** and are **CSA certified to CAN/CSA Z94.3-2015 standards**

### Eye Cup Goggle

- Our most basic welding type goggle
- Features 50 mm eye cup lenses and two individual cup bodies
- Ideal for confined space

Prod. No.	Body Colour	Vent Type	Coating	Tint
S85150	Green	Non-Vented	Uncoated	Shade 5 IR



### Lens Cover Goggle

- Features 50 mm eye-cup style fixed plate windows with soft PVC body

Prod. No.	Body Colour	Vent Type	Coating	Tint
S85250	Green	Indirect	Uncoated	Shade 5 IR



### Lift Front Plate Goggle

- Features standard size 2" x 4-1/4" lift front plate window
- It's easy and safe - by keeping the welding goggle on at all times, the operator can flip the shaded 5 IR window up or down, providing uninterrupted eye protection during cutting and grinding operations
- Clear lens provides eye protection when the Shade 5 IR flip plate is in the up position
- Window includes filter, cover and impact plates

Prod. No.	Body Colour	Vent Type	Coating	Tint
S85550	Green	Indirect	Uncoated	Shade 5 IR



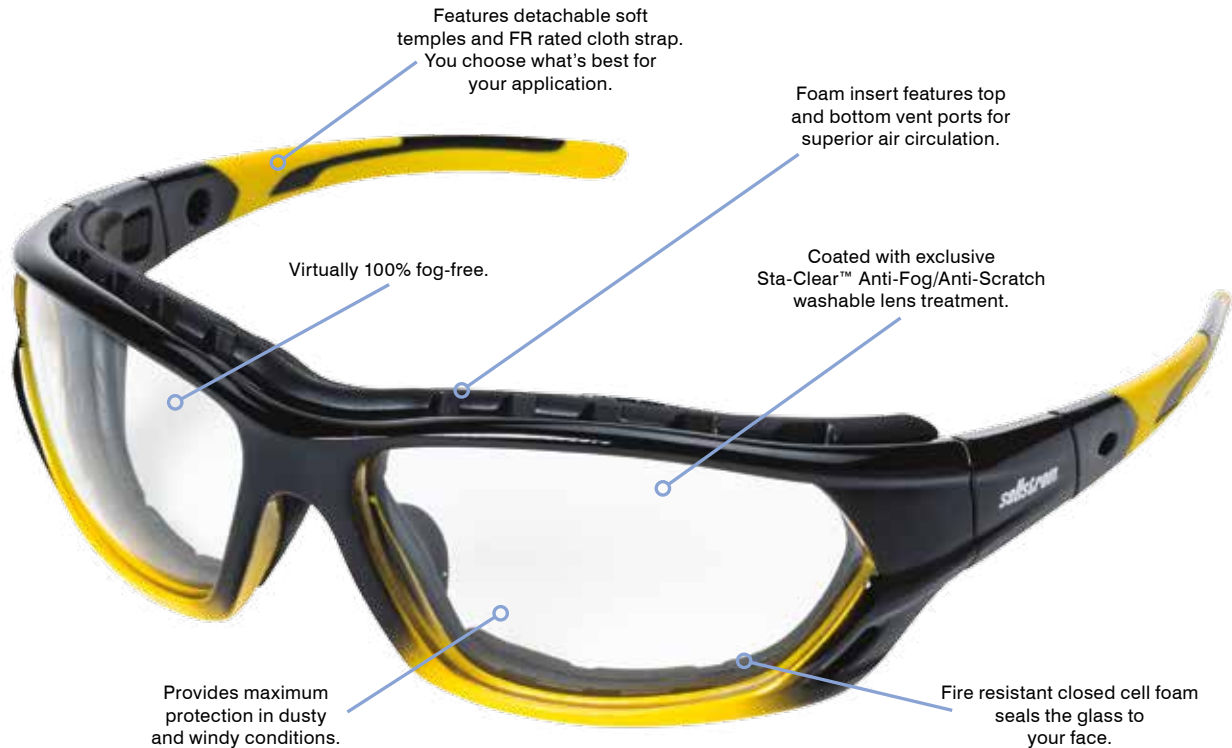

S70000

## SAFETY GLASSES - PREMIUM SEALED

- Sealed safety glasses offer the best of both worlds – the comfort and fit of a safety glass with goggle-like protection
- Features a fire-resistant closed cell foam insert that seals the glass to your face
- Provide maximum protection in dusty, windy conditions and wherever airborne particles are present
- Foam insert features top and bottom vent ports allowing superior air circulation
- Curved, custom molded high-impact polycarbonate lenses provide exceptional panoramic views
- Made with premium virgin polycarbonate high-impact lenses
- Lenses are specially coated with Sellstrom's premium Sta-Clear™ Anti-Fog/Anti-Scratch washable lens treatment for maximum performance, durability and life
- Virtually 100% fog free for optimum operator safety
- Provide 99.9% UV protection
- Meet **ANSI Z87.1-2015** and **CSA certified to CAN/CSA Z94.3-2015 standards; Model XPS502 is tested to the U.S. Military standard MIL-PRF-31013 safety requirement of 640 feet per second**



S71910

## SAFETY GLASSES - PREMIUM SEALED

### XPS502 Sealed Safety Glasses

- Features flexible, soft temples that are permanently attached to the frame using a heavy-duty ratcheting (up or down) temple adjustment hinge
- Allows the user to adjust temples for maximum comfort and protection
- Includes a fire resistant cloth strap that conveniently attaches to the temples
- Detachable strap can be easily removed/reattached as desired
- Ballistic rated – meets **U.S. Military standard MIL -PRF-31013 requirement**

Prod. No.	Colour	Tint	Coating	Temple	Strap
S71910	Black/Orange	Clear	Sta-Clear™ AF/HC	Soft	FR Cloth
S71911	Black/Orange	Smoke	Sta-Clear™ AF/HC	Soft	FR Cloth
S71912	Black/Orange	I/O	Hard Coated	Soft	FR Cloth



### XPS530 Sealed Safety Glasses

- The XPS530 comes standard with both detachable soft co-molded temples and a fire-resistant cloth strap which are easily interchangeable
- Outstanding style, fit, comfort and safety

Prod. No.	Colour	Tint	Coating	Temple	Strap
S70000	Yellow/Black	Clear	Sta-Clear™ AF/HC	Co-Molded	FR Cloth
S70001	Yellow/Black	Smoke	Sta-Clear™ AF/HC	Co-Molded	FR Cloth
S70002	Yellow/Black	I/O	Hard Coated	Co-Molded	FR Cloth



XPS530 safety glasses include both detachable temple arms and straps.



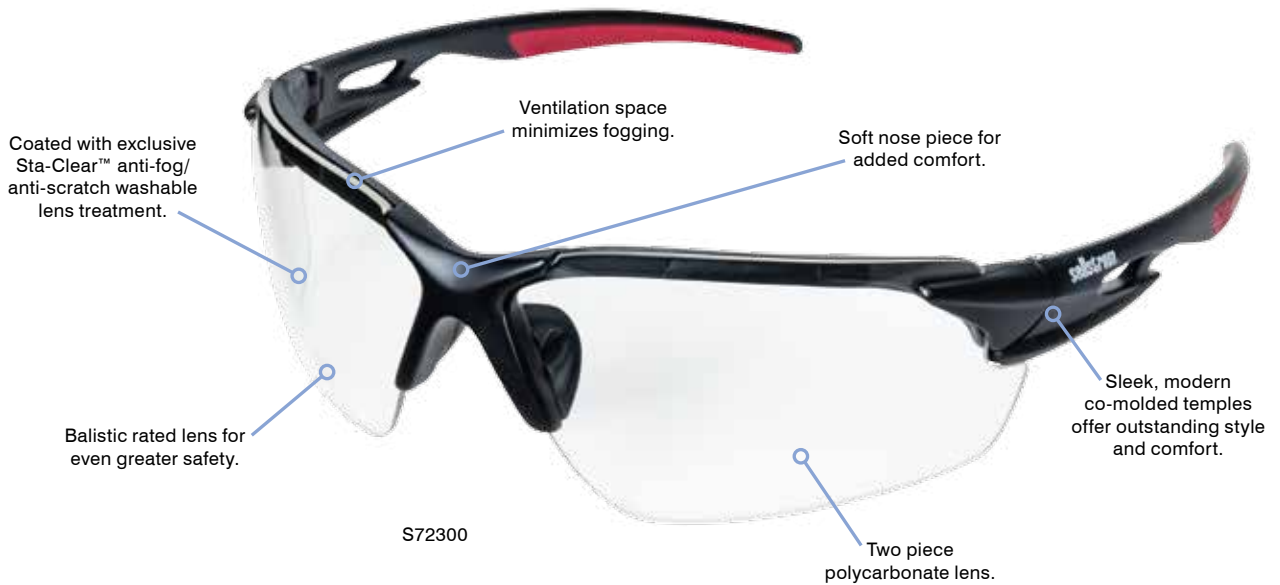

## SAFETY GLASSES - PREMIUM SERIES

- Sellstrom offers a wide range of super premium, high-quality safety glasses
- Rich in style, comfort, fit and safety
- Each model has been designed to exceed the needs of the most demanding user
- Made with premium virgin polycarbonate high-impact lenses
- Ballistic rated and tested to the U.S. Military standard MIL-PRF-31013 requirement of 640 feet per second for added safety and peace of mind

- Lenses are specially coated with Sellstrom's premium Sta-Clear™ Anti-Fog/Anti-Scratch washable lens treatment for maximum performance, durability and life
- Virtually 100% fog free for optimum operator safety
- Provide 99.9% UV protection
- Meets **ANSI Z87.1-2015, CSA certified to CAN/CSA Z94.3-2015 standards, and tested to the U.S. Military standard MIL-PRF-31013 safety requirement of 640 feet per second**



S72000



S72001

### XP410 Safety Glasses

- The XP410 offers feather light frames, great style, maximum comfort and fit
- So light, you won't even remember you have them on!
- High impact optically correct wrap style unitary polycarbonate lens offers superior coverage
- Stylish, ultra-thin black/green co-molded temples
- Temples are curved inwards to ensure comfortable, slip-resistant fit
- Temple tips are curved outwards for gentle placement and removal
- Soft, co-molded above-the-eye band provides superior eye coverage
- Soft, co-molded nose piece with flexible fingers ensures maximum comfort

Prod. No.	Colour	Tint	Coating	Pkg. Qty.
S72000	Black/Green	Clear	Sta-Clear™ AF/HC	12/box
S72001	Black/Green	Smoke	Sta-Clear™ AF/HC	12/box
S72002	Black/Green	I/O	Hard Coated	12/box

## SAFETY GLASSES - PREMIUM SERIES

### XP420 Safety Glasses

- The XP420 offers a sporty, stylish heavy-duty frame and temple design
- High-impact optically correct wrap style unitary polycarbonate lens offers superior coverage
- Soft, flexible temples with ribbed tips are curved inwards to ensure comfortable, slip-resistant fit
- Soft nose piece offers all-day comfort

Prod. No.	Colour	Tint	Coating	Pkg. Qty.
S72100	Black	Clear	Sta-Clear™ AF/HC	12/box
S72101	Black	Smoke	Sta-Clear™ AF/HC	12/box
S72102	Black	I/O	Hard Coated	12/box



S72100



S72101

### XP450 Safety Glasses

- The XP450 is our sportiest looking safety glass
- Edgy, sleek and modern co-molded temples offer outstanding style and comfort
- High-impact optically correct wrap style two-piece polycarbonate lenses offer superior coverage
- Lenses are mounted to the frame with a ventilation space, minimizing fogging
- Temples are curved inwards to ensure comfortable, slip-resistant fit
- Temple tips are curved outwards for gentle placement and removal
- Soft nose piece offers all-day comfort

Prod. No.	Colour	Tint	Coating	Pkg. Qty.
S72300	Black/Red	Clear	Sta-Clear™ AF/HC	12/box
S72301	Black/Red	Smoke	Sta-Clear™ AF/HC	12/box
S72302	Black/Red	I/O	Hard Coated	12/box



S72300



S72301

### XP460 Safety Glasses

- The XP460 offers a sporty, stylish heavy-duty frame and temple design
- Our only full frame premium safety glass
- High-impact optically correct two-piece polycarbonate lenses offer superior coverage
- Stylish black/green co-molded temples and soft nose piece offers all-day comfort
- Temples are curved inwards to ensure comfortable, slip-resistant fit
- Temple tips are curved outwards for gentle placement and removal

Prod. No.	Colour	Tint	Coating	Pkg. Qty.
S72400	Black/Green	Clear	Sta-Clear™ AF/HC	12/box
S72401	Black/Green	Smoke	Sta-Clear™ AF/HC	12/box
S72402	Black/Green	I/O	Uncoated	12/box



S72400



S72401

- Advantage Plus safety glasses offer additional features over our Advantage Series products, providing the user with increased comfort and fit
- All glasses are made using virgin polycarbonate lenses
- Provide 99.9% UV protection

### XM300 Safety Glasses

- The XM300 safety glass is lightweight, stylish, comfortable and affordable
- High-impact optically correct wrap style unitary polycarbonate lens offers superior coverage
- Stylish black/green co-molded temples and soft nose piece offers all-day comfort

Prod. No.	Colour	Tint	Coating	Pkg. Qty.
<b>S71100</b>	Black/Green	Clear	Hard Coated	12/box
<b>S71101</b>	Black/Green	Smoke	Hard Coated	12/box
<b>S71102</b>	Black/Green	I/O	Hard Coated	12/box

## SAFETY GLASSES - ADVANTAGE PLUS SERIES

- Lenses feature an anti-scratch hard coating
- Ideal for those applications where safety, comfort, fit and affordability are of primary importance
- Meets **ANSI Z87.1-2015** and **CSA certified to CAN/CSA Z94.3-2015 standards**



S71100



S71101

Up/down 3 position ratcheting temples



S71200

### XM310 Safety Glasses

- The XM310 safety glass is lightweight, stylish, comfortable and very affordable
  - High-impact optically correct wrap style unitary polycarbonate lens offers superior coverage
  - Molded above-the-eye band provides superior coverage
  - Stylish black/orange co-molded temples and soft nose piece offers all-day comfort
- Up/down 3-position ratcheting temples allows user to adjust for maximum fit
  - Temples are curved inwards to ensure comfortable, slip-resistant fit
  - Temple tips are curved outwards for gentle placement and removal
  - Ballistic rated – meets **U.S. Military standard MIL-PRF-31013 requirement**

Prod. No.	Colour	Tint	Coating	Pkg. Qty.
<b>S71200</b>	Black/Orange	Clear	Hard Coated	12/box
<b>S71201</b>	Black/Orange	Smoke	Hard Coated	12/box
<b>S71202</b>	Black/Orange	I/O	Hard Coated	12/box
<b>S71203</b>	Black/Orange	Amber	Hard Coated	12/box



S71201



S71203



## SAFETY GLASSES - ADVANTAGE PLUS SERIES

### XM320 Safety Glasses

- The XM320 offers a sporty, stylish heavy-duty frame and temple design
- High-impact optically correct unitary polycarbonate lens offers integrated side panel – incredible front and side eye coverage
- Stylish flat black and orange co-molded temples are soft and flexible
- Temples are curved inwards to ensure comfortable, slip-resistant fit
- Soft nose piece offers all-day comfort
- Ballistic rated – meets **U.S. Military standard MIL-PRF-31013 requirement**

Prod. No.	Colour	Tint	Coating	Pkg. Qty.
S71400	Black/Orange	Clear	Hard Coated	12/box
S71401	Black/Orange	Smoke	Hard Coated	12/box
S71402	Black/Orange	I/O	Hard Coated	12/box



S71400



S71401

### XM330 Safety Glasses

- The XM330 safety glass is lightweight, stylish, comfortable and very affordable
- Our most popular mid-range safety glass!
- High-impact optically correct wrap style unitary polycarbonate lens offers superior coverage
- Soft, flexible temple tips and soft nose piece offers all-day comfort
- Temples are curved inwards to ensure comfortable, slip-resistant fit
- Temple tips are curved outwards for gentle placement and removal
- Ballistic rated – meets **U.S. Military standard MIL-PRF-31013 requirement**

Prod. No.	Colour	Tint	Coating	Pkg. Qty.
S73601	Clear/Black	Clear	Hard Coated	12/box
S73611	Amber/Black	Amber	Hard Coated	12/box
S73621	Smoke/Black	Smoke	Hard Coated	12/box
S73631	Clear/Black	I/O	Hard Coated	12/box



S73601



S73611



S73621

### XM340 Safety Glasses

- The XM340 safety glass is lightweight, stylish and comfortable
- High-impact optically correct wrap style Dual polycarbonate lenses offer superior coverage
- Lenses are mounted to the frame with a ventilation space, minimizing fogging
- Soft rubberized temple tips and soft nose piece offers all-day comfort
- Temples are curved inwards to ensure comfortable, slip-resistant fit
- Temple tips are curved outwards for gentle placement and removal
- Ballistic rated – meets **U.S. Military standard MIL-PRF-31013 requirement**

Prod. No.	Colour	Tint	Coating	12/box
S74201	Smoke/Smoke	Clear	Hard Coated	12/box
S74241	Smoke/Smoke	I/O	Hard Coated	12/box
S74271	Smoke/Smoke	Smoke	Hard Coated	12/box



S74201



S74271

- Sellstrom offers a wide range of affordable safety glasses under the Advantage Series program
- All glasses are made using virgin, unitary polycarbonate lenses

### X300 Safety Glasses

- The X300 style is one of the most popular selling safety glasses in North America
- Lightweight, comfortable and very affordable
- Lens features an anti-scratch hard coating

Prod. No.	Colour	Tint	Coating	Pkg. Qty.
S70701	Clear	Clear	Hard Coated	12/box
S70711	Amber	Amber	Hard Coated	12/box
S70721	Smoke	Smoke	Hard Coated	12/box
S70731	Clear	I/O	Hard Coated	12/box

## EYE PROTECTION - ADVANTAGE SERIES

- Provide 99.9% UV protection
- Ideal for construction, shop and general eye protection applications



S70701



S70711



S70721

### X330 Safety Glasses

- The X330 style is one of the most popular selling safety glasses in North America
- Lightweight, comfortable and very affordable
- Lens features an anti-scratch hard coating

Prod. No.	Colour	Tint	Coating	Pkg. Qty.
S73401	Clear	Clear	Hard Coated	12/box
S73402	Clear	Clear	Anti-Fog	12/box
S73421	Amber	Amber	Hard Coated	12/box
S73471	Smoke	Smoke	Hard Coated	12/box
S73481	Smoke	Blue Mirror	Hard Coated	12/box

- Soft rubberized temple tips ensure superior comfort and fit
- Meets **ANSI Z87.1-2015** and **CSA certified to CAN/CSA Z94.3-2015 standards**



S73401



S73421



S73471

### X350 Safety Glasses

- Lightweight, comfortable and affordable
- Sleek, modern look offers front, side and above/below-the-eye protection
- Designed to fit over most medium-sized prescription eyewear (OTG)
- Comfortable nose bridge

- Ideal as a visitor's spec as well as for everyday eye protection
- Meets **ANSI Z87.1-2015** and **CSA certified to CAN/CSA Z94.3-2015 standards**
- Ballistic rated – meets **U.S. Military standard MIL-PRF-31013 requirement**

Prod. No.	Colour	Tint	Coating	Pkg. Qty.
S79100	Clear	Clear	Hard Coated	12/box



S79100

## SAFETY GLASSES - ADVANTAGE SERIES

### Sebring Safety Glasses

- Classic one-piece molded lens offers excellent front/side protection
- Lightweight, comfortable and very affordable
- Arms are extendable for maximum fit and comfort
- S73801 offers same features but with a smaller frame for narrow faces
- Meets **ANSI Z87.1-2015** standards and **cUL certified to CAN/CSA Z94.3-2015 standards**

Prod. No.	Colour	Tint	Coating	Pkg. Qty.
<b>S73801</b>	Black (Small Frame)	Clear	Hard Coated	12/box
<b>S76301</b>	Black	Clear	Hard Coated	12/box
<b>S76371</b>	Black	Smoke	Hard Coated	12/box



S73801 (Petite armature)

Extendable arms for maximum fit



S76301

### Maxview™ Safety Glasses

- Lightweight, comfortable and affordable
- Designed to fit over prescription eyewear (OTG)
- Ideal as a visitor's spec as well as for everyday eye protection
- Extra-wide ventilated temples for increased side protection
- Meets **ANSI Z87.1-2015** standards and **CSA certified to CAN/CSA Z94.3-2015 standards**

Prod. No.	Colour	Tint	Coating	Pkg. Qty.
<b>S79301</b>	Clear	Clear	Hard Coated	12/box
<b>S79302</b>	Clear	Clear	Uncoated	12/box



S79301

### Guest-Gard™ Safety Glasses

- Lightweight, comfortable and affordable
- Designed to fit over prescription eyewear (OTG)
- Ideal as a visitor's spec as well as for everyday eye protection
- Classic one-piece molded lens offers excellent front/side protection
- Comes in convenient dispenser box – 24/box
- Meets **ANSI Z87.1-2015** standards and **CSA certified to CAN/CSA Z94.3-2015 standards**



Prod. No.	Colour	Tint	Coating	Pkg. Qty.
<b>S79103</b>	Clear	Clear	Uncoated	24/dispenser box



- Sellstrom offers two popular styles of bifocal magnifying safety glasses
- Developed for workers requiring magnifiers when performing close-vision tasks
- Available in three magnifying powers: 1.5, 2.0 and 2.5

## SAFETY GLASSES - BIFOCALS

- All glasses are made using virgin, unitary polycarbonate lenses
- Provide 99.9% UV protection
- Meets **ANSI Z87.1-2015** standards and **CSA certified to CAN/CSA Z94.3-2015 standards**

### X300RX Safety Glasses

- The X300RX offers all of the same features as our popular X300 but with bifocal magnification technology
- Lightweight, comfortable and very affordable
- Lens features an anti-scratch hard coating

Prod. No.	Colour	Tint	Coating	Magnification	Pkg. Qty.
S70703	Clear	Clear	Hard Coated	1.5 x	12/box
S70704	Clear	Clear	Hard Coated	2.0 x	12/box
S70705	Clear	Clear	Hard Coated	2.5 x	12/box



S70703  
Bifocal magnifiers

### XM340RX Safety Glasses

- The XM340RX offers all of the same features as our popular XM340 but with bifocal magnification technology
- High-impact optically correct wrap style Dual polycarbonate lenses offer superior coverage
- Lenses are mounted to the frame with a ventilation space, minimizing fogging
- Soft rubberized temple tips and soft nose piece offers all-day comfort
- Temples are curved inwards to ensure comfortable, slip-resistant fit
- Temple tips are curved outwards for gentle placement and removal

Prod. No.	Colour	Tint	Coating	Magnification	Pkg. Qty.
S74202	Smoke/Black	Clear	Hard Coated	1.5 x	12/box
S74203	Smoke/Black	Clear	Hard Coated	2.0 x	12/box
S74204	Smoke/Black	Clear	Hard Coated	2.5 x	12/box



S74202  
Bifocal magnifiers

## SAFETY GLASSES - SHADE 5 IR

### B5 Safety Glasses

- Sellstrom B5 safety glasses are specifically for use in welding and fabrications shops
- Available in Shade 5 IR for soldering, brazing and cutting operations
- Made with anti-scratch polycarbonate lenses
- Provide 99.9% UV protection
- Features fold-out contouring side shields for maximum eye protection
- Arms are extendable for maximum fit and comfort
- Meets **ANSI Z87.1-2015** standards, **cUL certified to CAN/CSA Z94.3 standards and CE certified**

Prod. No.	Colour	Side Shield	Tint	Coating	Pkg. Qty.
S74751	Smoke/Black	Black	Shade 5 IR	Hard Coated	12/box



Fold-out contouring side shield



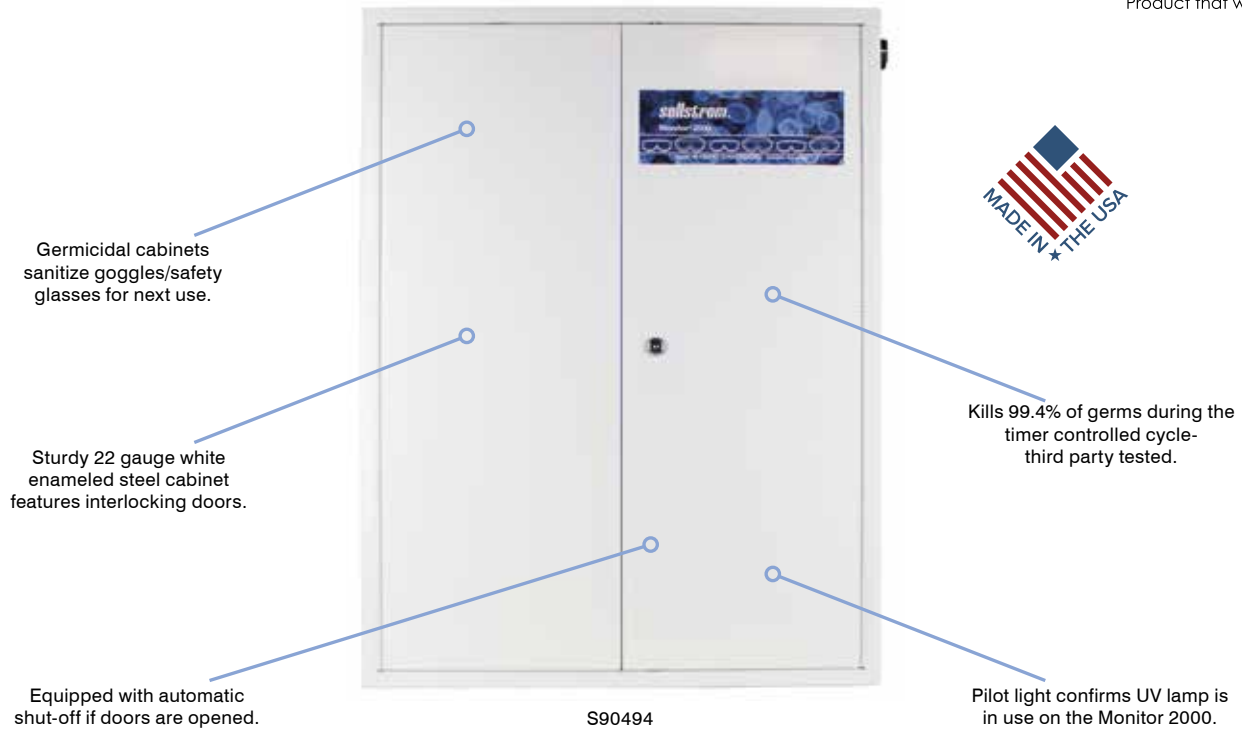

# GERMICIDAL CABINET

## Monitor 2000 Germicidal Cabinet

- Sellstrom's Monitor Series Germicidal Cabinet has been the industry leader for decades
- Germicidal cabinets sanitize goggles/safety glasses for next use
- Kills 99.4% of germs during the timer-controlled cycle – third-party tested
- Sanitizes eyewear surfaces from: germs; bacteria; mold; fungus contaminants
- Sturdy 22-gauge white enameled steel cabinet features interlocking doors
- Features tamper-resistant latches with two keys provided
- Multiple units are keyed alike
- Zero UV radiation escapes during use
- Equipped with automatic shut-off if doors are opened
- Pilot light confirms UV lamp is in use
- Wall or shelf mountable and includes 7' (2.13 m) grounded cord
- For indoor use only, temperature range of 32 to 104°F
- Specially designed for educational and medical industry applications
- Large 32" H x 24.5" W x 9.5" D format includes 8 shelves total
- Each shelf holds approximately 5 goggles or 6 safety glasses
- **Sanitizes goggles/safety glasses for next use in just 5 minutes, an industry best**
- Underwriters Laboratory listed and cUL Certified
- **Made in the U.S.**



Prod. No.	Use	Compatibility
S90494	Education/medical industries	Fits Monitor 2000

## Replacement Lamp

Prod. No.	Compatibility
S90482	Fits Monitor 2000

## STA-CLEAR™ LENS CLEANING PRODUCTS

- Cleans glass and polycarbonate safety glasses and goggle lenses
- Cleans without streaking or leaving static residue
- Anti-static, anti-fog cleaning solution impregnated in tissues
- **Not for fog-free (anti-fog coated) lenses**
- Scratch free – contains no silica

### Sta-Clear™ Pre-Moistened Lens Cleaning Tissue Packets

- Convenient pre-moistened single-use packets
- Towelette measures 5" x 8" (12.7 x 20.32 cm)
- Convenient dispenser box contains 110 packets
- Can be wall-mounted or placed on flat surface

Prod. No.	Pkg. Qty.
S23490	10/box



### Sta-Clear™ Lens Cleaning Tissues

- Tissues come dry and must be water activated
- Tissues measure 4-1/2" x 10-1/2" (11.43 x 27.31 cm)
- Box measures 5-1/4" x 4-1/2" x 4" (13.02 x 12.07 x 11.75 cm)
- Convenient dispenser box contains 1,000 tissues

S23480



### Sta-Clear™ Lens Cleaning Stations

- Stations come with water-activated tissues and 16 oz pump spray bottle
- Tissues come dry and must be water activated
- Tissue measures 4-1/2" x 10-1/2" (11.43 x 27.31 cm)
- Metal station can be locked (uses key #S23475)
- Opening allows for litter-free disposal of used tissues
- Can be wall-mounted or placed on flat surface

Prod. No.	Description	Pkg. Qty.	Size
S23469	Cardboard Station (1,000 tissues and spray bottle)	6/box	8-5/8 x 6-1/2 x 5-3/8"
S23470	Metal Station (1,000 tissues and spray bottle)	1/box	8-3/4 x 6-1/2 x 5-1/4"



S23469

## EQUIPMENT CLEANING PRODUCTS

### Sel-Kleen™ Pre-Moistened Equipment Cleaning Packets

- Anti-static, anti-fog cleaning solution impregnated in tissues
- Scratch free – contains no silica
- Alcohol-free pads use benzalkonium chloride as the active ingredient and will not harm even the most sensitive rubber or PVC material
- Convenient single-use packets
- Towelette measures 5" x 8" (12.7 x 20.32 cm)
- Convenient dispenser box contains 110 packets
- Can be wall-mounted or placed on flat surface

Prod. No.	Pkg. Qty.
S22185	10/box



# EYEWASH STATION - PORTABLE EMERGENCY

## 16-Gallon Gravit-Eye Portable Eyewash Station

S90320

- Water is fed through dual spray heads for maximum effectiveness
- Delivers over 14 gallons (53 litres) of water over a 15-minute period
- High-viz green body is easily located in case of emergency
- Heavy wall construction with reinforced ribs ensures strength and durability
- Water flow is activated by pulling up (on) or down (off) on bright yellow tray
- Integrated full flow nozzle delivers gentle spray of water
- Waste water is directed through drain opening in tank basin
- 3' drain hose directs waste water into floor drain or storage tank
- Furnished with steel wall mounting bracket
- Can also be placed on flat surfaces such as counter tops
- Comes with 8 oz bottle of bacteriostatic additive (S90322) which protects against growth of bacteria, fungus, algae and acanthamoeba
- Weight: 13 lb empty, 146 lb full
- Unit comes completely assembled
- Complies with **ANSI Z358.1** for portable eyewash stations



Water/flow is activated by pulling down yellow tray

Dual spray heads

S90320

## Eyewash Bacteriostatic Additive, 8 oz

S90322

- 8 oz bottle of bacteriostatic additive
- For use in all makes of portable eyewash stations
- Protects against growth of bacteria, fungus, algae and acanthamoeba



# HEARING PROTECTION

## What you should know about hearing protection:

- Exposure to continuous high noise levels causes irreversible hearing loss
- Developing an effective workplace hearing safety program is critical
- OSHA sets the permissible eight hour work day noise exposure level at 90 dBA and only two hours of exposure to 100 dBA
- Many companies place noise level limits even lower than the OSHA standard
- Here are guidelines that some companies apply for increased safety:
  - 8 hours exposure = 85 dBA
  - 4 hours exposure = 88 dBA
  - 2 hours exposure = 91 dBA
  - 1 hour exposure = 94 dBA

## About NRR ratings and their practical application in the field

- The NRR ratings found on many hearing protection products in the market, including Sellstrom, have been tested and certified in controlled laboratories. However, working environments are seldom controlled environments
- In the field hearing protection is not always fitted properly leading to noise creep and the potential for hearing damage
- As a precaution NIOSH recommends the following deratings during field use:
  - Ear Muffs – NIOSH recommends derating NRR ratings by 25%
  - Ear Plugs – NIOSH recommends derating NRR ratings by 50-75%
- In some applications, to achieve maximum protection the use of ear plugs and muffs together may be the safest solution. It is estimated that by combining the two, an extra 5 dBs can be added to the overall tested NRR rating

## EAR PLUGS - PREMIUM DISPOSABLE

### Disposable Ear Plugs - Bullet Shape

- Contoured bullet shape premium-quality polyurethane ear plugs
- Gently but quickly expand to fit ear canal – one size fits all!
- Soft, non-irritating PU foam for maximum comfort
- Available corded and uncorded
- Plugs are individually packed in pairs and sold:
  - Uncorded – 200 pairs in convenient dispenser box
  - Uncorded – 500 pairs in bulk bag (replacement plugs for dispenser)
  - Uncorded – 500 pairs in convenient see-through wall dispenser
  - Uncorded – 10 pairs in retail slide blister package
  - Corded – 100 pairs in convenient dispenser box
- Independently tested/certified to **NRR 32 (ANSI S3.19)**
- **CSA Class AL**

Prod. No.	Type	Shape	Colour	Pkg. Qty.
S23410	Uncorded	Bullet	Hi-Viz Green	200-pair dispenser box
S23411	Uncorded	Bullet	Hi-Viz Green	500-pair bulk pack
S23412	Corded	Bullet	Hi-Viz Green	100-pair dispenser box
S23413	Uncorded	Bullet	Hi-Viz Green	500-pair wall dispenser
S23414	Uncorded	Bullet	Hi-Viz Green	10-pair retail package



S23410



S23411



S23412



S23413



S23414



# EAR PLUGS - PREMIUM REUSABLE

## Reusable Ear Plugs - Tapered

- Newly developed 4-flange, tapered earplug ensures optimum ear canal coverage
- Firm push/pull post makes insertion and removal quick and easy
- One size fits all
- Reusable – can be washed and reused dozens of times
- Made with non-allergenic polymer materials
- Plugs are individually packed in pairs and sold:
  - Uncorded = 100 pairs/box
  - Corded = 100 pairs/box
  - Corded = 1 pair in see-through plastic storage case with belt clip
- Independently tested/certified to **NRR 27 (ANSI S3.19)**
- **CSA Class AL**



S23420

Prod. No.	Type	Shape	Colour	Pkg. Qty.
S23420	Uncorded	Tapered	Blue/Hi-Viz Green	100 pairs/box
S23421	Corded	Tapered	Blue/Hi-Viz Green	100 pairs/box
S23422	Corded	Tapered	Blue/Hi-Viz Green	1 pair w/ plastic case



S23422



S23421



S23421

## Ear Plugs - Premium Banded

- Banded ear plugs are designed to wear around the neck when not in use
- Ensures workers always have quality hearing protection when required
- Ideal for regular and intermittent applications – easily installed or removed
- Compliance enforcement is made easy due to the hi-viz green band
- Specially designed band shape is curved at the plug end – keeps the ear pods up and away from dirty and contaminated surfaces when not in use
- Comfortable blue ear plugs/pods are easily replaced when dirty (S23431)
- Used extensively on construction work sites, at airports and race tracks, in factory and shop applications and wherever reusable ear protection is required
- Independently tested/certified to **NRR 25 (ANSI S3.19)**
- **CSA Class AL**



S23430

Prod. No.	Type	Shape	Colour	Pkg. Qty.
S23430	Banded	Tapered	Hi-Viz Green	1/bag
S23431	Replacement plugs/pods (pair)		Blue	10 pairs/bag

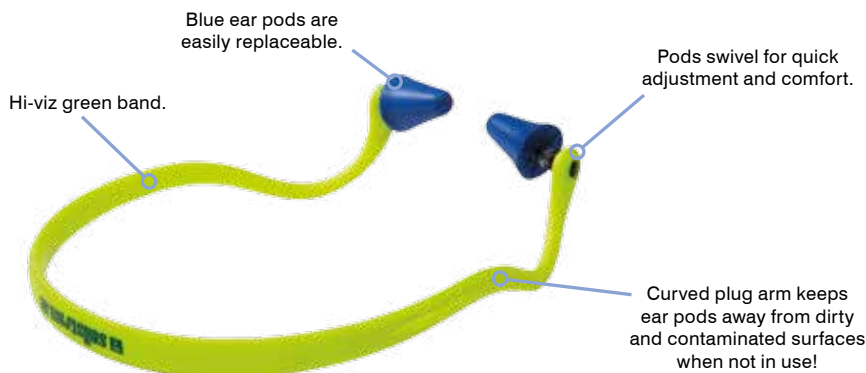

S23431

## EAR MUFFS - PREMIUM DIELECTRIC

### HPD425 Premium Dielectric Ear Muff

- HPD425 ear muffs offer premium features and protection
- Stylish, modern lightweight design
- Dielectric – protect you from electric shocks and shorts
- Hi-Viz green/black cups are highly visible even in low light conditions
- Cup pads are soft and comfortable – ideal for extended use
- Heavy duty non-conductive swivel fork arms ensure strength and durability
- Easily adjustable for quick and convenient positioning
- Features soft foam head band for maximum operator comfort and style
- Independently tested/certified to **NRR 25 (ANSI S3.19)**
- **CSA Class A**



S23407

Prod. No.	Head Band	NRR Rating	Colour	Pkg. Qty.
S23407	Soft EVA Foam	25 dB	Hi-Viz Green/Black	10/box

## EAR MUFFS - PREMIUM SERIES

- Sellstrom introduces a full range of ear muffs offering premium features
- Stylish, modern lightweight design
- Cup pads are soft and comfortable – ideal for extended use
- Strong stainless steel wire swivel fork arms ensure strength and durability
- Easily adjustable for quick and convenient positioning
- Feature soft EVA head bands for maximum operator comfort and style

### HP431 Premium Ear Muff

- The HP431 ear muff offers our highest NRR rating (31 dB)
- Ideal for work in very high noise environments
- Independently tested/certified to **NRR 31 (ANSI S3.19)**
- **CSA Class A**

Prod. No.	Head Band	NRR Rating	Colour	Pkg. Qty.
S23406	Soft EVA Foam	31 dB	Black/Red	10/box

Soft EVA foam head band



## EAR MUFFS - PREMIUM SERIES

### HP427 Premium Ear Muff

- Our most popular premium series ear muff
- Low profile "slim" design is ultra-lightweight and comfortable
- Folds into a very compact, easy-to-store size
- Independently tested/certified to **NRR 27 (ANSI S3.19)**
- **CSA Class AL**

Prod. No.	Head Band	NRR Rating	Colour	Pkg. Qty.
S23404	Soft EVA Foam	27 dB	Black/Orange	10/box

### HP424 Premium Ear Muff

- Low profile slim design is ultra-lightweight and comfortable
- Folds into a very compact, easy-to-store size
- Independently tested/certified to **NRR 24 (ANSI S3.19)**
- **CSA Class A**

Prod. No.	Head Band	NRR Rating	Colour	Pkg. Qty.
S23403	Soft EVA Foam	24 dB	Black	10/box

Soft EVA foam head band



### HPS428 Premium Cap Mounted Ear Muff

- Designed to mount on to most brands of slotted hard hats
- Cup pads are soft and comfortable – ideal for extended use
- Strong stainless steel wire swivel fork arms ensure strength and durability
- Easily adjustable for quick and convenient positioning
- One of the highest NRR ratings for a cap mounted muff (28 dB)
- Independently tested/certified to **NRR 28 (ANSI S3.19)**
- **CSA Class A**

Prod. No.	Head Band	NRR Rating	Colour	Pkg. Qty.
S23409	Soft EVA Foam	28 dB	Black/Red	10/box



## EAR MUFFS - ADVANTAGE SERIES

### H225 Ear Muff

- Comfortable, lightweight and economically priced
- Dielectric – protect you from electric shocks and shorts
- Cup pads are soft and comfortable – ideal for extended use
- Tough, long-lasting tension bands
- Easily adjustable for quick and convenient positioning
- Attractive blue cups
- Comes in convenient clamshell package for display purposes
- Independently tested/certified to **NRR 25 (ANSI S3.19)**
- **CSA Class A**

Prod. No.	Head Band	NRR Rating	Colour	Pkg. Qty.
S23401	Curved Plastic	25 dB	Blue	10/box





## KNEE PADS - PREMIUM GRADE

# KneePro



- Sellstrom's **KneePro Ultra Flex III** knee pads have been the industry standard for more than 30 years
- Simply the best knee pads made!
- The articulating hinged design ensures proper placement all day long – set them once and forget you are even wearing them
- Soft elastic, extra-wide woven straps with reinforced sewn ends are placed well above and below the knee – no Velcro®, which contaminates over time
- Straps stay aligned with your legs in any position – will not bind behind the knee
- Built with strong, flexible hard plastic outer shells that extend well above, below and to the inside/outside of the knee for added knee and leg protection
- Metal rivet hinge ensures long lasting protection while kneeling or walking
- On the outside, pads feature a perfectly placed curved non-marking Grip Strip
- Grip-Strip designed for use in all applications without gumming up
- Grip Strips are easily replaceable
- On the inside, pads offer a long lasting 5/8" closed cell foam pad for maximum comfort and protection
- Sweat does not penetrate closed cell foam – lasts longer and is odour less
- Our new **KneePro Hybrid Ultra Flex III** version offers even greater user comfort and protection through the use of a three layer, 3/4" thick closed cell foam pad with built-in gel packs – the ultimate in knee protection!
- Virtually indestructible – built for years of hard work and heavy use
- Specially designed Quick-Snap clips ensure quick and easy removal
- Comes in convenient, reusable mesh bag with one extra Quick-Snap clip
- Pads weigh only 9 oz. each
- Straps, Grip Strips and Quick-Snap clips are replaceable
- Excellent for welders, ship builders, roofers, construction workers, flooring installers and anywhere hard working knee pads are required

VELCRO® and VELCRO® design are registered trademarks of Velcro BVBA.



# KNEE PADS - PREMIUM GRADE

## KneePro Ultra Flex III Knee Pad

Prod. No.	Colour	Size
S96110	Grey with Orange Grip Strip	Fit-All

5/8" (16 mm) closed cell foam pad for maximum comfort and protection



S96110

## KneePro Hybrid Ultra Flex III Knee Pad

Prod. No.	Colour	Size
S96211	Black with Hi-Viz Orange Grip Strip	Fit-All

Hard Plastic outer sheels are extremely strong.

Quick Snap clips ensure quick and easy removal.

Non-Marking Grip-Strip for use on any surface.

Hinged with metal rivet for ease of movement while kneeling or walking.

Soft elastic woven straps are placed well above and below the knee – ensures proper pad placement all day long without any binding behind the knee!



S96211

Gel packs are securely placed inside a three layer 3/4" (19 mm) closed cell foam compartment and are guaranteed to stay leak free.

## WELDING BLANKET - IN VINYL BAG

### 100% Fibreglass High-Temp Blanket

- Designed for hot work operations
- Intended for use in horizontal applications with light to moderate exposures such as chipping, grinding, heat treating, sand blasting and light horizontal welding
- Strong, safe and chemical resistant
- Hemmed on all four sides with Kevlar® thread, brass grommets on corners and 36" centre
- Machine washable
- White fibreglass blanket has a 1,000°F continuous-service temperature rating
- Convenient blue vinyl pouch with carrying handles protects welding blanket from exposure to harsh UV rays, chemicals, moisture, dust, salt air, insects and temperature extremes

Prod. No.	Material	Size	Weight	Temperature	Storage
S97455	100% fibreglass	5' x 6'	18 oz	1,000°F/540°C	Blue vinyl pouch



## EMERGENCY FIRE BLANKETS - IN VINYL BAG

- Strong, safe and chemical resistant
- For use on small and contained fires
- Hemmed on all four sides with Kevlar® thread, brass grommets on corners and 36" centre
- Machine washable
- White fibreglass blanket has a 1,000°F continuous-service temperature rating
- S97450 comes in convenient red vinyl hanging pouch with carrying handles, protects welding blanket from exposure to harsh UV rays, chemicals, moisture, dust, salt air, insects and temperature extremes
- Two heavy-duty grommets on top of pouch for easy hanging
- S97452 comes in convenient vinyl duffel bag with handles for easy storage in limited space

Prod. No.	Material	Size	Weight	Temperature	Storage
S97450	100% fibreglass	5' x 6'	18 oz	1,000°F/540°C	Red vinyl hanging pouch with carrying handles
S97452	100% fibreglass	5' x 6'	18 oz	1,000°F/540°C	Vinyl duffel bag with handles



S97450

## EMERGENCY FIRE BLANKET - IN METAL STORAGE CABINET

### 100% Fibreglass High-Temp Blanket

- Strong, safe and chemical resistant
- For use on small and contained fires
- Hemmed on all four sides with Kevlar® thread, brass grommets on corners and 36" centre
- Machine washable
- White fibreglass blanket has a 1,000°F continuous-service temperature rating
- Comes in strong, red metal cabinet (16"H x 15"W x 5-1/2"D) which can be easily wall mounted or placed on a flat surface for quick and easy access
- Easy-to-identify bright red case with large white lettering

Prod. No.	Material	Size	Weight	Temperature	Storage
S97457	100% fibreglass	5' x 6'	18 oz	1,000°F/540°C	Red metal cabinet



Kevlar® is a registered trademark of E. I. du Pont de Nemours and Company



**SAFETY & FALL PROTECTION**





# HI-VIZ CLOTHING



## Mesh Back Zip Front Surveyor's Vest

- 300D hi-viz oxford front panel, durable and breathable
- 4 oz (120 GSM) polyester mesh back panel for high breathability
- CSA Z96-15 Class 2 Level 2
- ANSI/ISEA 107-15 Class 2 Type P and R
- Full-length, durable zipper
- Radiophone clip straps
- ID pocket with transparent window
- Chest pocket with pen slots
- D-ring access
- Lower pockets with flaps and grommets
- Full mesh back panel with double layer bottom pouch

Prod. No.	Mod. No.	Colour	Size
V1010250	6672	Hi-Viz Orange	S-4XL
V1010260	6673	Hi-Viz Yellow/Green	S-4XL



## Poly/Cotton Drop Needle Hi-Viz T-Shirt

- 5.3 oz (180 GSM) poly/cotton knit
- Drop stitched for ultimate breathability
- Cotton yarn inside for ultra cool comfort
- Hi-visibility polyester outside meets CSA Z96-15 Class 2 level 2 and ANSI/ISEA 107-15 Class 2 Type P and R
- 2" silver Startech™ reflective tape
- Rib crew neck with grey contrast stripes

Prod. No.	Mod. No.	Colour	Size
V1052350	6906	Hi-Viz Orange	S-4XL
V1052360	6907	Hi-Viz Yellow/Green	S-4XL



Reversed

## Reversible "Visibility Plus" Safety Vest

- Reversible "Visibility Plus" safety vest with mesh face side and full reflective material reversible side
- 100% polyester 5.6 oz (190 GSM) hi-viz mesh
- Durable and convenient reversible neck-high zipper
- Sporty look and cut, designed for work and play
- Mesh side features StarTech™ reflective tape in CSA Z96-15 Class 2 Level 2 (ANSI/ISEA 107-15 Class 2 Type P and R) format
- Reversible side features contrast hi-viz yellow piping and two pockets on each side

Prod. No.	Mod. No.	Colour	Size
V1180260	5661	Yellow/Green	S-4XL



## Softshell Mechanical Strength Safety Jacket

- Softshell mechanical strength stretch material with TPU water-resistant membrane
- CSA Z96-15 Class 2 Level 2
- ANSI/ISEA 107-15 Class 3 Type P and R
- StarTech™ reflective tape
- Waterproof front zipper with comfortable chin guard
- Hi-tech laser chest pocket
- 2 lower pockets with zip closures
- Hook and loop closure with PVC strap at cuffs
- Stylish black bottom conceals soiling

Prod. No.	Mod. No.	Colour	Size
V1100250	5679	Hi-Viz Orange	S-4XL
V1100260	5689	Hi-Viz Yellow/Green	S-4XL



# HI-VIZ ACCESSORIES



## Hi-Viz Mesh Gaiter with Reflective Stripes

- Hi-viz breathable polyester mesh
- Elastic top and bottom for easy on/off
- Adjustable hook and loop straps
- Double visibility StarTech™ reflective stripes
- CSA Z96-15 Class 3 Level 2 when worn with Class 2 Level
- 2 top featuring reflective arm bands
- ANSI/ISEA 107-15 Class E Supplemental Type
- Individual hangable bag
- 20" height
- 10 pairs per inner pack

Prod. No.	Mod. No.	Colour	Size
V1040760	294	Hi-Viz Yellow/Green	O/S fits most

## Hi-Viz 8" Traffic Cuff

- Hi-viz polyester mesh with solid binding
- 2" silver Startech™ double reflective tape
- Long hook and loop system for adjustment
- CSA Z96-15 (must be worn with other CSA approved Class 2 apparel)
- ANSI/ISEA 107-15 Class E Supplemental Type
- 8" length
- Sold individually

Prod. No.	Mod. No.	Colour	Size
V1040164	164	Yellow	O/S



## Hi-Viz Waterproof 300D Oxford PU Gaiter

- Hi-viz 100% waterproof oxford PU
- Elastic top and bottom with drawstring
- Double visibility StarTech™ reflective stripes
- CSA Z96-15 Class 3 Level 2 when worn with Class 2 Level
- 2 top featuring reflective arm bands
- ANSI/ISEA 107-15 Class E Supplemental Type
- Individual hanger bag
- 20" height
- 10 pairs per inner pack

Prod. No.	Mod. No.	Colour	Size
V1040870	295	Hi-Viz Yellow/Green	O/S fits most



## Hi-Viz Safety Sash

- Premium 1.5" elastic
- Adjustable elastic waist band and chest straps
- Startech™ reflective tape
- Quick-release waist buckle

Prod. No.	Mod. No.	Colour	Size
V1041050	5496	Hi-Viz Orange	Fit-All
V1041060	5497	Hi-Viz Yellow/Green	Fit-All



# HI-VIZ SAFETY RAINWEAR (300D)



## THE ROCK 100% Waterproof



### 300D Oxford Polyester Jacket with PU Coating

- 100% waterproof 300 Denier oxford polyester with PU coating
- CSA Z96-15 Class 2 Level 2 (becomes Class 3 when worn with hi-viz pant featuring reflective leg bands)
- ANSI/ISEA 107-15 Class 3 Type P and R
- StarTech™ reflective tape
- Taped and heat sealed seams
- Superior tear- and abrasion-resistant fabric
- Liberal fit and full back vent for working comfort
- 2 lower flap pockets
- Half mesh lined vent on back
- Full front zipper
- Hood folds into collar

Prod. No.	Mod. No.	Colour	Size
V1081350	5626	Hi-Viz Orange	S-5XL
V1081360	5628	Hi-Viz Yellow/Green	S-5XL

### 300D Oxford Polyester Bib Pant with PU Coating

- 100% waterproof 300D oxford polyester with PU coating
- CSA Z96-15 Class 3 Level 2 when worn with Class 2 Level 2 top featuring reflective arm bands
- ANSI/ISEA 107-15 Class E Supplemental Type
- StarTech™ reflective tape
- Taped and heat sealed seams
- Superior tear- and abrasion-resistant fabric
- Liberal fit for working comfort
- Elastic suspenders
- High-quality plastic buckles
- 2 snap adjustment on leg hems to fit snug to boots
- 2-sided waist adjustment for better fit around waist

Prod. No.	Mod. No.	Colour	Size
V1082350	5627	Hi-Viz Yellow/Green	S-5XL
V1082360	5629	Hi-Viz Yellow/Green	S-5XL

### Hi-Viz 100% Waterproof 6-in-1 Bomber

- 300 Denier PU coated oxford polyester
- Inner and outer jackets CSA Z96-15 Class 1 Level 2 and ANSI/SEA 107-15 Class 1 Type 0
- Double-stitched StarTech™ reflective tape
- 100% waterproof and windproof
- Taped and heat sealed seams

#### OUTER JACKET:

- Fully mesh lined
- Detachable snap hood
- Adjustable cuffs
- Full front zipper with snap storm placket
- 2 radiophone clip straps
- 2 large front cargo pockets
- 1 cell phone pocket
- 4 inside pockets

#### INNER JACKET:

- Quilted lining
- Detachable sleeves
- Comfort collar
- 2 large front cargo pockets
- 2 inner pockets
- Reversible to black



Prod. No.	Mod. No.	Colour	Size
V1120370	5026	Black	XS-5XL

# HI-VIZ HEAVYWEIGHT RAINWEAR



## Hi-Viz PVC Rain Jacket

- Hi-viz PVC/poly/PVC 0.35 mm durable waterproof material
- CSA Z96-15 Class 2 Level 2 (becomes Class 3 when worn with hi-viz pant featuring reflective leg bands)
- ANSI/SEA 107-15 Class 3 Type P and R
- Startech™ 2" reflective tape
- Detachable drawstring hood
- Double placket and snap closure
- Snaps on cuffs
- Corduroy collar

Prod. No.	Mod. No.	Colour	Size
V3032050	5106	Hi-Viz Orange	S-4XL



## Hi-Viz PVC Rain Bib Pant

- Hi-viz PVC/poly/PVC 0.35 mm durable waterproof material
- Startech™ 2" reflective tape
- CSA Z95-15 Class 3 Level 2 when worn with CSA Class 2 Level 2 top featuring reflective arm bands
- ANSI/SEA 107-2015 Class E Type Supplemental
- Snap fly access
- Adjustable elastic suspenders
- Snap adjustment at the back of the waist and at the leg opening

Prod. No.	Mod. No.	Colour	Size
V3032150	5108	Hi-Viz Orange	S-4XL

# HI-VIZ SAFETY APPAREL



## Flame Resistant Long-Sleeved Cotton Safety Shirt

- 100% FR treated preshrunk cotton, 7.5 oz (250 GSM)
- Material and all components meet CGSB 155.20, 2000
- Thermal Protective Performance (TPP) value with the spacer: 7.5 / contact test: 5.9
- CSA Z96-15 Class 1 Level 2 and Class 1 Level FR
- ANSI/SEA 107-15 Class 1 Type 0
- Meets ASTM F1506-10a, NFPA 70E and CSA Z462-15
- ATPV 9 cal/cm<sup>2</sup> (Arc Thermal Protective Value)
- ARC 2 Arc Rating Category
- StarTech™ FR reflective tape
- Sewn with inherently FR thread
- Self fabric crew neck
- Chest pocket with hook and loop closure

Prod. No.	Mod. No.	Colour	Size
V2580450	339SFA	Orange	S-5XL
V2580470	340SFA	Black	S-5XL



## Hi-Viz All-Purpose Vest

- Polyester mesh
- Yellow PVC reflective tape
- 5 point tear-away

Prod. No.	Mod. No.	Colour	Size
V1030450	592A	Hi-Viz Orange	Fit-All



## FR PVC RAINWEAR



### Flame Resistant PVC Rain Jacket

- .35 mm FR treated PVC/poly/PVC
- Meets CGSB 155.20, 2000 Type 3
- 100% waterproof
- Jacket with zip and snap front placket, detachable snap hood

Prod. No.	Mod. No.	Colour	Size
V3510660	578J	Yellow	S-6XL



### Flame Resistant PVC Rain Bib Pant

- .35 mm FR treated PVC/poly/PVC
- Meets CGSB 155.20, 2000 Type 3
- 100% waterproof
- Bib pant with self fabric suspenders

Prod. No.	Mod. No.	Colour	Size
V3510760	578P	Yellow	S-6XL

## TRAFFIC SAFETY

### Polyester flag with reflective tape on both side

V6300360 / 353

- Dowel sleeve
- 3 grommets on the side
- Colour: Hi-Viz Orange
- Size: 25.6" x 19.7"



### PE mesh flag

- Dowel sleeve



Prod. No.	Mod. No.	Colour	Size
V6300760	367	Red	16"
V6300860	368	Red	18"

### Polyester flag with waterproof coating

V6300960 / 369

- Dowel sleeve
- Two grommets on the side
- Colour: Orange
- Size: 16"



### Safety warning triangle

V6301050 / 372

- Easily unfolds from weighted tubular base
- Non-slip pads
- Air flow design helps reduce wind turbulence
- 4-point bracing for stability
- Foldable for storage in zipper carrying case





# FR DISPOSABLE WEAR

## FR SMS Coverall

- 100% FR treated SMS (Spunbound Melt-Blown) non-woven material
- Complies with Chemical Protective Coveralls Category III EN ISO 13982-1 Type 5 – Protection Against Hazardous Dry Particles
- Complies with Chemical Protective Coveralls Category III EN ISO 13034 Type 6 – Protection Against Light Splashes and Light Sprays of Liquid Chemicals
- Flame spread resistant tested to EN 14116 Index 1
- For FR applications only: must be worn over other CGSB approved flame resistant apparel
- Premium sewn and bonded seams for increased holdout of liquids and dry particles
- Ideal for protection from asbestos, paint spray, dust and noxious splashes
- Can be used in bacterial culture labs as well as in the pharmaceutical, wood/metal processing and construction industries
- Low lint
- Elastic cuff, ankle and face line
- Elastic waist at back
- Individually packed



Prod. No.	Mod. No.	Colour	Size
V7014540	2075	Blue	S-5XL

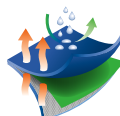

Asbestos fibres, such as chrysotile, are typically 3-5 microns in size. The SMS fabric used in the construction of our SMS coverall has been proven to filter 100% of particles larger than 3 microns.

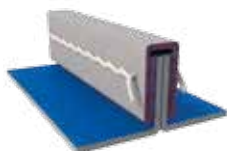

### Sewn & Bound Seams

A sewn and bound seam joins two pieces of material with an overlay of similar material and is chain-stitched through all of the layers for a clean, finished edge. This provides increased holdout of liquids and dry particulates.



2-way zipper front with resealable storm flap

## FR HEADWEAR

### Double Layer Toque

V4530170 / C300

- Inherently flame resistant and arc rated Flame-Gard™ blend
- ATPV 40 cal/cm<sup>2</sup> (Arc Thermal Protective Value)
- ARC 4 Arc Rating Category
- Super soft, warm and comfortable



### Double Layer One-Hole Balaclava

V4530270 / C304

- Inherently flame resistant and arc rated Flame-Gard™ blend
- ATPV 40 cal/cm<sup>2</sup> (Arc Thermal Protective Value)
- ARC 4 Arc Rating Category
- Super soft, warm and comfortable
- Safe long neck design
- Elastic face line
- Side slit



### Double Layer Neck Warmer

V4530370 / C307

- Inherently flame resistant and arc rated Flame-Gard™ blend
- ATPV 40 cal/cm<sup>2</sup> (Arc Thermal Protective Value)
- ARC 4 Arc Rating Category
- Super soft, warm and comfortable





# HEADWEAR

## Fleece-Lined Hard Hat Liner

V4040180 / 564N

- 5 oz (170 GSM) poly/cotton twill shell
- 300 g fleece lined
- Helmet straps with button closure
- Elastic chin strap
- Elastic back



## Ultra Cooling Bandana

V2051240 / 248

- 100% cotton blue triangle bandana
- Lined with 100% cooling PVA foam on top and forehead
- Activated by soaking into cool water and wringing out excess water gently
- Easy to tie on forehead, reusable
- Packed in hangable bag



## Fleece-Lined Hard Hat Liner

V4040280 / 565N

- 5 oz (170 GSM) poly/cotton twill shell
- 300 g fleece lined
- Helmet straps with button closure
- Warm long neck design with hook and loop closure
- Detachable mouthpiece



## Ultra Cooling Headband

V2051140 / 247

- 100% cotton blue strip head band
- Lined with 100% cooling PVA foam
- Activated by soaking into cool water and wringing out excess water gently
- Easy to tie on forehead, reusable
- Packed in hangable bag



## Fleece-Lined Hard Hat Liner

V4040380 / 566N

- 5 oz (170 GSM) poly/cotton twill shell
- 300 g fleece lined
- Helmet straps with button closure
- Warm long neck design with elastic chin strap
- Elastic back
- Detachable mouthpiece



## Ultra Cooling Towel

V2051040 / 246

- 100% PVA foam, ultra-absorbent helps dissipate hot moisture and body heat
- Activated by soaking into cool water and gently wringing out excess water
- Packed in hangable plastic tube to keep product cool, soft and reusable
- Can be tied around head or neck to keep you cool



# FACE MASKS



Distributors note:  
Peg hangable format

## Nuisance Dust Mask

V7031900 / 390P

- Premium cone-shaped mask
- Pliable aluminum nose clip
- Ultrasonic welded latex and staple-free head straps
- Retail pack of 5



## N95 Cone-Shaped Face Mask

V7031200 / 350P

- NIOSH approved
- Exceptional inner filter for increased breathability
- Adjustable aluminum nose clip
- Ultrasonic welded head straps for secure staple-free seal
- Retail pack of 3



## N95 Cone-Shaped Face Mask with Valve

V7031300 / 355P

- NIOSH approved
- Exceptional inner filter for increased breathability
- Adjustable aluminum nose clip
- Ultrasonic welded head straps for secure staple-free seal
- One-way valve for easy exhalation
- Retail pack of 2



# TRAFFIC SAFETY



## LED Traffic Baton

- Rugged design, shock and weather resistant
- Equipped with steel belt grip and nylon lanyard
- Six LED lights and a reflector holder for maximum visibility
- Switch between flash, steady on and off
- Baton diameter 4 cm, length 54 cm
- Ideal for directing traffic and people in dark conditions
- Uses 2 D cell batteries (not included)

Prod. No.	Mod. No.	Colour
V6020450	429	Orange
V6020460	430	Yellow



## “Caution” Tape

- Visual barricade tape to block off designated areas
- Can be used indoor or outdoor
- Width: 3" (51 mm)

Prod. No.	Mod. No.	Colour	Type	Length (ft.)
V6310140	386	Black on yellow background	“Caution” Tape	200
V6310160	388	Black on red background	“Caution” Tape	200
V6310240	387	Black on yellow background	“Danger” Tape	1,000
V6310260	389	Black on red background	“Danger” Tape	1,000
V6310360	384	Black on yellow background	“Danger” Tape	1,000



## Premium PVC Flexible Safety Cone

- Factory-attached 4" high-luminance Type 3 band for superior visibility
- Soft, high-quality, injection-moulded PVC
- Hi-viz colour with UV protection
- One-piece design for strength and durability
- Bounce back to shape when run over
- Superior strength and flexibility
- Durable heavy, black rubberized base
- Stable, wide-body design
- Stackable for easy storage
- 100% recyclable design

Prod. No.	Mod. No.	Weight (lb)	Height (in.)
V6200750	181N	3	18
V6200850	183N	7	28



Made in Canada 

## TOOL TETHERING SYSTEM

PeakWorks introduces a patented tool tethering system, designed to protect workers from tools dropped at height.

- Developed and manufactured in Canada
- The strongest, most secure tool anchor clamping system in the market
- Durable and long-lasting even in extreme hot or cold conditions
- Rigorously tested at the CSA test lab to ensure maximum safety and peace of mind



**DEADLY MISSILE IF DROPPED FROM 60' (18 M)**

### Clamps:

- Unique tool anchor clamps are specially designed to prevent tools from falling through commonly used 19-4 construction site grating – no other tool tethering system offers this added safety feature!
- Heavy-duty, reusable/repositionable HDPE clamps can be mounted onto a variety of flat, hex and round tools

- High-strength clamp fasteners are easily installed and removed using the hex key wrench provided
- Strong, moulded eye hole for quick attachment/detachment from lanyards with built-in carabiners
- Available in individual blister packs, 10-piece bulk packs, or 50-piece master packs (5 bulk packs of 10 pieces)

### Lanyards:

- Specially designed lanyards connect the tool anchor clamp to either the operator or to a suitable anchor point

- Both lanyards can also be used and mounted to a variety of tools that feature hanging hole openings (ie: adjustable wrenches and pipe wrenches)

### Standard Lanyard

- Extreme CSA Tested
- Double run cables and double carabiners for security and ease of tool swapping

Prod. No.	Mod. No.	Length (in.)	Package Qty.
V856220	TT-9901	32	1
V856221	TT-9901-BULK	32	10 or 50



### Wrist Lanyard

- Extreme CSA Tested
- Solid metal buckle for strength and durability
- Small carabiner

Prod. No.	Mod. No.	Length (in.)	Package Qty.
V856210	TT-9900	13	1
V856211	TT-9900-BULK	13	10 or 50





# TOOL TETHERING SYSTEM



## Round Clamps

- Extreme CSA Tested
- Strong and durable for round and hex shaped tool bodies
- HDPE plastic
- Includes hardware, hex key and instructions

Prod. No.	Mod. No.	Opening (in.)	Package Qty.
V8561101	TT-1000-1	1/2	1
V8561102	TT-1000-BULK	1/2	10 or 50
V8561201	TT-2000-1	5/8	1
V8561202	TT-2000-BULK	5/8	10 or 50
V8561301	TT-3000-1	3/4	1
V8561302	TT-3000-BULK	3/4	10 or 50
V8561401	TT-4000-1	7/8	1
V8561402	TT-4000-BULK	7/8	10 or 50



V8561102



V8561101

## Flat Clamps

- Extreme CSA Tested
- Best suited for wide and flat tool bodies
- HDPE plastic
- Includes hardware, hex key and instructions

Prod. No.	Mod. No.	Opening (in.)	Package Qty.
V8561501	TT-5000-1	15/16 to 5/16	1
V8561502	TT-5000-BULK	15/16 to 5/16	10 or 50
V8561601	TT-6000-1	1-5/16 to 9/16	1
V8561602	TT-6000-BULK	1-5/16 to 9/16	10 or 50



V8561502



V8561501

## Press Blocks

- Extreme CSA Tested
- Strong and durable for round and hex shaped tool bodies
- HDPE plastic
- Includes hardware, hex key and instructions

Prod. No.	Mod. No.	Opening (in.)	Package Qty.
V8561701	TT-7000-1	1/2 to 3/4	1
V8561702	TT-7000-BULK	1/2 to 3/4	10 or 50
V8561801	TT-8000-1	1-1/16 to 1-1/4	1
V8561802	TT-8000-BULK	1-1/16 to 1-1/4	10 or 50



V8561702



V8561701

\* Please note: All products are available individually, or in bulk 10-packs which are then master packed 5 packs (50 pieces) per carton. Save by purchasing in both 10 packs and master packs of 50.



# TOOLS & EQUIPMENT



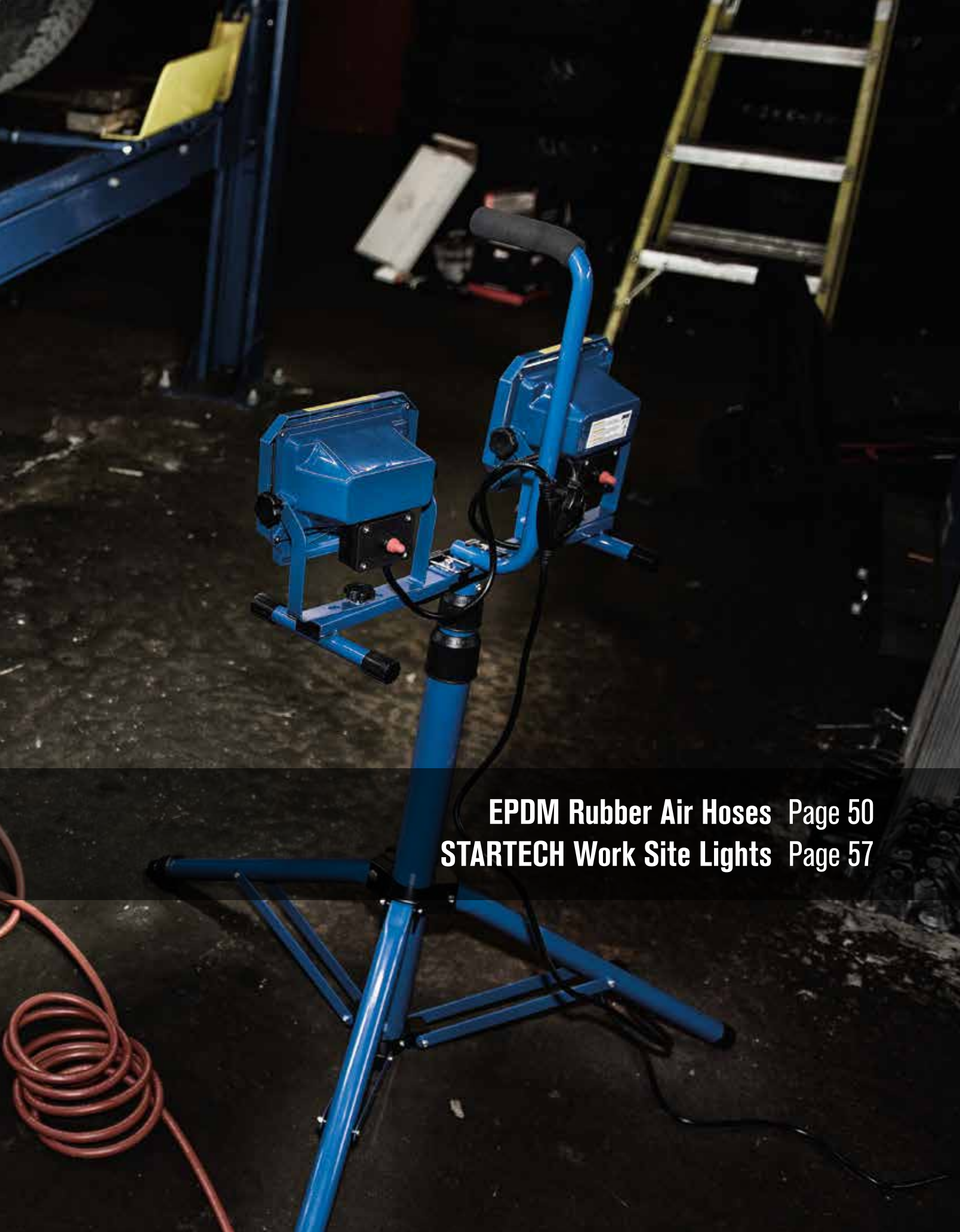

**EPDM Rubber Air Hoses Page 50**  
**STARTECH Work Site Lights Page 57**



## PARTS WASHERS

### 5 Gallon Parts Washer – Heavy Duty

- 13.3 litre working capacity
- Flexible delivery spout
- Screened inlet protects pump from foreign material
- CSA compliant pump
- For use with water based cleaning solutions with pH of 7-8 only

Prod. No.	Mod. No.	Motor	Tank Dimensions (in.)
355005	JPW-5	115 V / 60 Hz / 0.5 A	17 x 13 x 8-7/8



### 20 Gallon Parts Washer – Heavy Duty

- Fusible link melts and closes lid in the event of a fire, minimizing danger to workers and property
- 41.8 litre working capacity
- Flexible delivery spout
- Screened inlet protects pump from foreign material
- cETL certified to CAN/CSA C22.2 No. 68-92
- For use with water based cleaning solutions with pH of 7-8 only

Prod. No.	Mod. No.	Motor	Tank Dimensions (in.)
355007	JPW-7	115 V / 60 Hz / 0.5 A	29-7/8 x 20-3/4 x 10-5/8



### 40 Gallon Parts Washer - Heavy Duty

- Product no. 355008 supersedes 355003
- Fusible link melts and closes lid in the event of a fire, minimizing danger to workers and property
- Extra-large 83 litre working capacity
- Flexible delivery spout
- Screened inlet protects pump from foreign material
- CSA compliant pump
- For use with water based cleaning solutions with pH of 7-8 only

Prod. No.	Mod. No.	Motor	Tank Dimensions (in.)
355008	JPW-40	115 V / 60 Hz / 0.5 A	41-3/4 x 20-1/2 x 10-5/8



## HEAT GUN

### 1,500 Watt Professional Heat Gun

- Variable heat settings and two fan speeds provide maximum versatility for a variety of jobs
- Double insulated for user safety
- Flat back design permits user to stand gun on workbench for hands-free use
- Complete with 5 common accessories
- Convenient blow mould case protects tool and keeps accessories organized
- 1,500 W maximum power
- cUL approved

#### Perfect for:

- Paint, varnish, and lacquer removal
- Softening adhesives
- Label removal
- Thawing frozen components
- Forming and welding plastics
- Softening caulk and putty
- Heat shrinking plastics
- Soldering pipes

Prod. No.	Mod. No.	Power (W)	Fan Speeds (cfm)	Temperature Range (°C)
380001	JHGK-600	1,500	10 / 18	50-450, 90-600







## BUTANE TORCHES



- Industrial quality hand held torches for a variety of applications
- Meets Consumer Products Safety Commission child safety standards
- Every torch factory tested for performance and safety
- Specially designed to prevent liquid gas from entering nozzle, preventing flame outs and allowing use in any orientation
- Piezo ignition requires no batteries or flints
- Anodized aluminum barrel is tough and corrosion resistant
- Can be locked in on position for production work
- Includes stand for hands-free use
- Uses standard butane lighter fuel (not included)

### Perfect for:

- Electrical and mechanical repair
- Jewelry making and repair
- Paint removal
- Soldering
- Brazing
- Bending plastics
- Thawing pipes
- Starting campfires
- Culinary use
- A must-have for any tool box



### Mini Butane Torch

Prod. No.	Mod. No.	Flame Temperature	Fuel Capacity	Burn Time (min.) (High/Low)	Type
380021	JBT-1322	1,300°C	22 ml	60/90	Micro flame



### Turbo Butane Torch

Prod. No.	Mod. No.	Flame Temperature	Fuel Capacity	Burn Time (min.) (High/Low)	Type
380022	JBT-1330	1,300°C	30 ml	60/90	Turbo flame



# FLAP DISCS (FOR ANGLE GRINDERS)

## POWERBLEND® FLX - Zirconia Flexible Flap Discs - High Performance (for Angle Grinders)

- The unique “cushion style” pointed flap configuration overhanging the fibre back plate offers maximum flexibility, excellent for contoured surfaces, 90° corners, hard-to-reach areas and flat surfaces where a premium finish is critical
- Specially developed to perform applications that cannot be easily accomplished by conventional forms of coated abrasives and more

- rigid flap discs. Interrupted flap design resists glazing and material loading
- High performance ZA grain ensures fast, cool cutting action and extra long life on steel and stainless steel
- Mounted using regular depressed centre wheel adapters

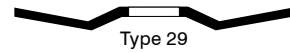

Prod. No.	Size (in.)	Grit	Max. RPM	Pkg. Qty.
503323	5 x 7/8	Z40	12,000	10
503325	5 x 7/8	Z60	12,000	10
503327	5 x 7/8	Z80	12,000	10
503329	5 x 7/8	Z120	12,000	10

## AIR HOSES

The flexible and cost effective choice

### EPDM\* Rubber Air Hoses

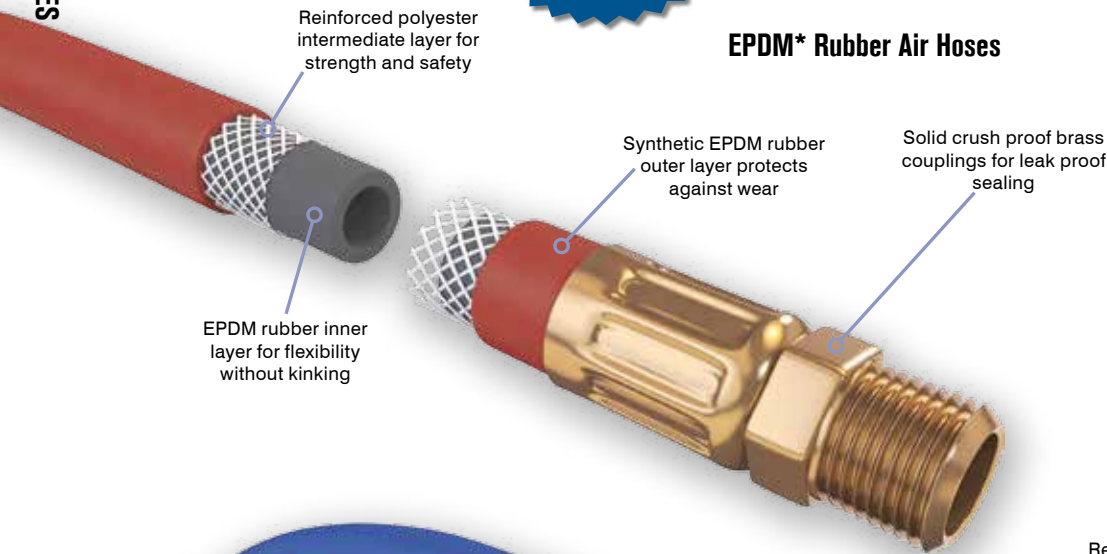

Reinforced polyester intermediate layer for strength and safety

EPDM rubber inner layer for flexibility without kinking

Synthetic EPDM rubber outer layer protects against wear

Solid crush proof brass couplings for leak proof sealing

No Compromise: Exceptional flexibility and long service life

### Hybrid Air Hoses - SHD



Reinforced polyester intermediate layer for strength and safety

Premium polymer inner layer for flexibility without kinking

Premium polymer secondary outer layer protects against wear

Reinforced bend restrictor prevents kinking and ensures uninterrupted air flow

Solid crush proof brass couplings for leak proof sealing

# AIR HOSES

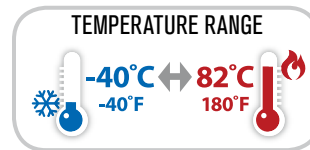
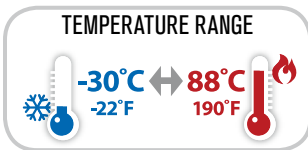

## EPDM\* Rubber Air Hoses

- EPDM rubber air hose provides best balance between flexibility, longevity, and cost effectiveness for both automotive and industrial shop application – whether for tools, jacks, or other compressed air applications
  - Exterior and interior hose layers: Synthetic Ethylene Propylene Diene Monomer (EPDM) rubber for ideal flexibility
  - Interlayer: Reinforced polyester for strength and longevity
  - Solid crush proof couplings for leak proof sealing: 1/4" fittings for 1/4" and 3/8" ID, and 1/2" fittings for 1/2" ID
  - Temperature range: -30°C (-22°F) to +88°C (190°F) – wide spectrum of indoor/outdoor applications
  - Abrasion resistant outer cover for service longevity
  - UV, ozone, and chemical resistance for safety and long service life
  - 300 psi maximum working pressure, 4:1 safety factor (1,200 psi burst pressure)
- \* Ethylene propylene diene monomer

Prod. No.	Mod. No.	ID Size (in.)	Hose Length (ft.)	Fitting Size (NPT) (in.)
408180	AH1425RB	1/4	25	1/4
408181	AH1450RB	1/4	25	1/4
408182	AH3825RB	3/8	25	1/4
408183	AH3850RB	3/8	50	1/4
408184	AH38100RB	3/8	100	1/4
408185	AH1225RB	1/2	25	1/2
408186	AH1250RB	1/2	50	1/2
408187	AH12100RB	1/2	100	1/2
408188	AH1250RB38	1/2	50	3/8

## Hybrid Air Hoses - SHD

- Hybrid air hose provides the no-compromise solution that allows both exceptional flexibility and superior abrasion and general wear resistance
- For demanding heavy duty truck and industrial applications, hybrid is the air hose solution of choice
- Exterior and interior hose layers: premium polymer for excellent flexibility
- Interlayer: reinforced polyester for strength and longevity.
- Solid crush proof couplings for leak proof sealing: 1/4" fittings for 1/4" and 3/8" ID, and 1/2" fittings for 1/2" ID
- Temperature range: -40°C (-40°F) to +82°C (180°F) – wide spectrum of indoor/outdoor applications - ideal for extreme cold weather environments
- Abrasion resistant outer cover for service longevity
- UV, ozone, and chemical resistance for safety and long service life
- 300 psi maximum working pressure, 4:1 safety factor (1,200 psi burst pressure)

Prod. No.	Mod. No.	ID Size (in.)	Hose Length (ft.)	Fitting Size (NPT) (in.)
408193	AH3825HY	3/8	25	1/4
408194	AH3850HY	3/8	50	1/4
408195	AH1225HY	1/2	25	1/2
408196	AH1250HY	1/2	50	1/2



# BEAM CLAMPS

## VBC Series - Beam Clamps

- Robust, all steel construction
- Can be adjusted to fit securely on a wide range of flange and beam widths
- Meet ANSI B30.11 specifications (certificate included)
- Tested to 125% of rated capacity
- Built in suspension bar provides ultra-low headroom

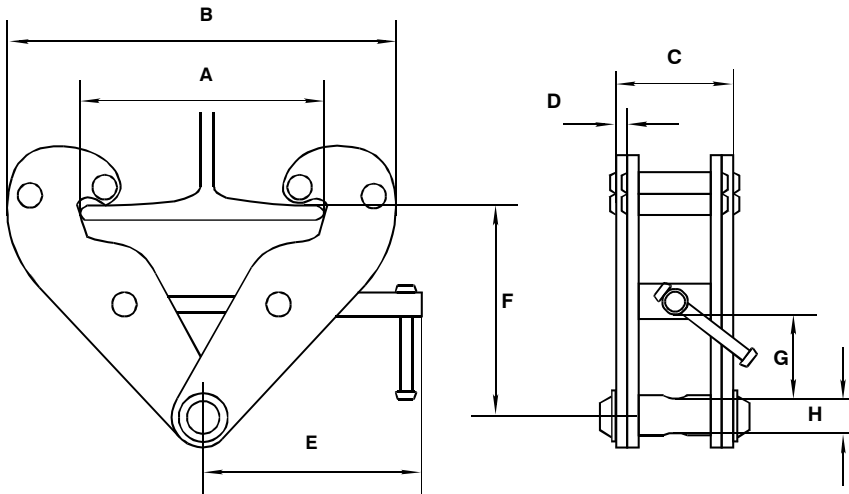

Prod. No.	Mod. No.	Capacity (t)	Rated Capacity (lb)	Rated Flange Width (in.)	Maximum A (in.)	Minimum B (in.)	Maximum B (in.)	C (in.)	D (in.)	E (in.)	Maximum F (in.)	Minimum F (in.)	G (in.)	H (in.)
120613	VBC-1	1	2,200	2-61/64 to 8-21/32	10-1/4	7-3/32	14-11/64	2-33/64	13/64	8-15/32	4-1/64	6-3/32	63/64	7/8
120615	VBC-2	2	4,400	2-61/64 to 8-21/32	10-1/4	7-3/32	14-11/64	2-29/32	1/2	8-15/32	4-1/64	6-3/32	63/64	7/8
120616	VBC-3	3	6,600	3-5/32 to 12-39/64	13-15/16	9-1/4	19-19/64	4-1/16	5/16	10-1/4	5-1/2	8-55/64	1-49/64	61/64
120617	VBC-5	5	11,000	3-5/32 to 12-39/64	13-15/16	9-1/4	19-19/64	4-21/32	25/64	10-1/4	5-1/2	8-55/64	1-49/64	1-7/64



# MANUAL TROLLEYS

## VBC Series - Manual Trolleys

- Adjustable to fit securely on a wide range of flanges and beam widths
- Specially designed integrated drop stops/bumpers take the load in the event of wheel failure and prevent the wheels from contacting other trolleys on the track
- Can be installed or removed at any point along the track
- Use on straight or curved H and I beams

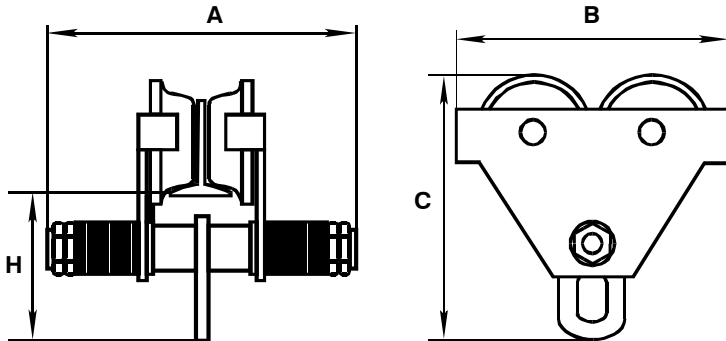

Prod. No.	Mod. No.	Capacity (t)	Rated Capacity (lb)	I-Beam Flange Width (H) (in.)	Minimum Radius Curve (in.)	A (in.)	B (in.)	C (in.)	H (in.)
120111	VPT-05	1/2	1,100	2-1/2 to 5-1/2	36	9-1/16	8-11/32	7-13/16	4-29/64
120112	VPT-1	1	2,200	2-1/2 to 5-1/2	40	10	10-3/64	9-7/64	5-3/64
120114	VPT-2	2	4,400	3 to 6-1/2	48	11-9/16	11-29/32	10-15/16	5-63/64
120115	VPT-3	3	6,600	3 to 8	56	13-35/64	13-35/64	13-5/16	7-21/64
120116	VPT-5	5	11,000	3-15/32 to 8	79	14-11/64	14-7/8	15-15/32	8-5/8

## 1/2 Ton Extension Kits For VBC Series Manual Trolleys

- Convert trolleys for use on a wide range of sizes of beam flanges
- Include suspension shaft and washers
- For use with VPT series trolleys only

Prod. No.	Mod. No.	Rated Capacity (t)
124212	VES-05	1/2
124213	VES-1	1
124215	VES-2	2
124216	VES-3	3
124217	VES-5	5





### Heavy Duty Combi Tire Bead Breaker

- Safely and easily breaks large heavy duty tires beads
- Ideal for large truck, bus, military, or agricultural tire service applications
- Works on common single, two-piece, and three-piece truck rims \*
- Weighs only 31 lb, for fast, easy positioning on tires
- Beads broken quickly in seconds under 10,000 psi of hydraulic pressure
- 3/8" NPT coupler, for ease of adapting to existing SHD hose, pump and accessories products
- Can use either SHD hydraulic hand pump or SHD air/hydraulic foot pump
- \* Not for use with 5-piece giant earth mover rims (use 030491 Giant Bead Breaker for earth mover tire applications)

Prod. No.	Mod. No.	Stroke (in.)	Stroke (mm)
030490	BBRKC	4	102

#### Suggested Accessories:



3/8" x 6' SHD Hose (033137)



SHD Hand Pump (033101)



### Heavy Duty Giant Tire Bead Breaker

- Safely and easily breaks large earth mover tires beads
- Ideal for mining and large earth mover truck tire service applications
- Only for 5-piece 25" and 29" rims tires \*
- Weighs only 22 lb, for fast, easy positioning on tires
- Beads broken quickly in seconds under 10,000 psi of hydraulic pressure
- 3/8" NPT coupler, for ease of adapting to existing SHD hose, pump and accessories products
- Can use either SHD hydraulic hand pump or SHD air/hydraulic foot pump
- \* For single, two-piece, and three-piece rims, use 030490 Combination Bead Breaker

Prod. No.	Mod. No.	Stroke (in.)	Stroke (mm)
030491	BBRKG	2	51

#### Suggested Accessories:



3/8" x 10' SHD Hose (033138)



SHD Foot Pump (033125)





## COB Penlight

- Combination flashlight and worklight in a handy, compact size
- COB (Chip On Board) technology provides long life, robust construction, and a more diffused, natural light
- Magnetic pocket clip allows light to be mounted to metal surfaces for hands-free operation
- 5 function switch cycles from 100% - 50% - flashing worklight – flashlight – off
- Soft touch grip is resistant to shop chemicals
- Includes 3 x AAA batteries
- Distributors: Sold in 12 piece display only see page 60

**Available for a limited time only!**



Prod. No.	Mod. No.	Lumens (High/Low/Flash)	Runtime @ 100% (hr.)	Length (in.)
849808	CPL-110	110/55/18	4.5	6-1/2

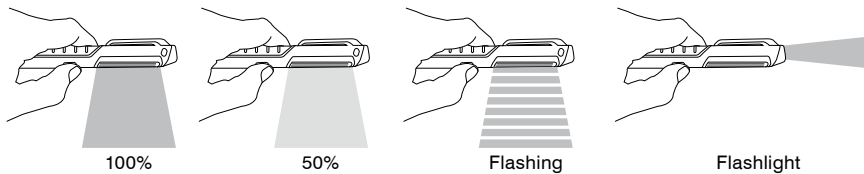

## Pivot Base COB Worklight

- Combination flashlight and worklight in one
- COB (Chip On Board) technology provides long life, robust construction, and a more diffused, natural light
- Pivoting magnetic base directs light where you need it
- Magnet on back and hidden swivel hook allow for multiple mounting options for hands free use
- 4 function switch cycles from 100% - 50% worklight – flashlight – off
- Soft touch grip is resistant to shop chemicals
- Includes 3 x AA batteries
- Distributors: Sold in 9 piece display only see page 60



Prod. No.	Mod. No.	Lumens (High/Low/Flash)	Runtime @ 100% (hr.)	Runtime @ 50% (hr.)	Length (in.)
849858	CPWL-260	260/130/23	8	20	8-3/4

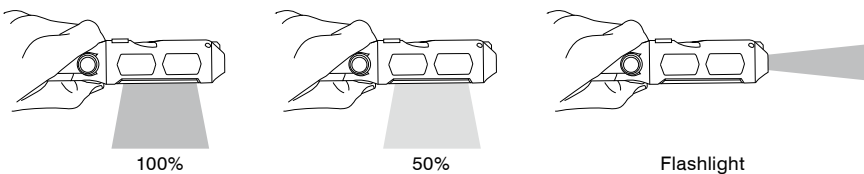





849702



849703

**Intrinsically Safe Flashlights**

- Intrinsically safe flashlights for use where flammable gasses, vapours, and liquids or combustible dusts and ignitable fibres are present
- Certified to cULus Class I Division I, Class II Division I, and Class III Division I – the highest standards in the world
- Totally sealed to prevent micro sparks from exiting flashlight
- IP67 waterproof to 1 m
- Specially designed valve permits hydrogen gas produced by batteries to exit flashlight, preventing accumulations that could be ignited by internal sparks
- Security screw is designed to prevent casual replacement of batteries while working in volatile environments
- Cree® XP-E SMD element produces extremely bright light while providing excellent run time
- High and low output modes
- Drop tested to 1 m
- Complete with belt clip
- Can be mounted to hard hat with optional clip set (see below)



Prod. No.	Mod. No.	Lumens @ High Power	Lumens @ Low Power	Run Time @ High Power (hr.)	Run Time @ Low Power (hr.)	Beam Distance (m)	Overall Length (in.)	Batteries Included
849702	ISFL-120	120	31	6	69	172	6-3/4	4 x AA
849703	ISFL-124	124	55	42.5	80	185	9	3 x C

**Accessories**

**Belt Clip for IS Flashlights**

- Replacement belt clip for Intrinsically Safe flashlights
- Fits models 849702 (ISFL-120) and 849703 (ISFL-124)



849708 / FBC-1

**Helmet Mounting Clip Set**

- Allows mounting on brim or in accessory slot of most safety helmets
- Fits 6-3/4" model (849702 / ISFL-120) only



849709 / HMC-120



# WORK SITE LIGHTS

- Highly efficient Surface Mounted Diode (SMD) technology provides brilliant white light with minimal power consumption
- Stays cool to the touch even after all day use
- 6,500K colour temperature ideally mimics daylight for true colour reproduction
- 30,000 hour life expectancy and low power consumption means low cost of ownership over the life of the lamp
- Robust cast aluminum housings protect inner components from impact damage
- Powder coated for maximum corrosion resistance
- Impact resistant safety glass lenses
- IP44 rated and cETL certified for use indoors or outdoors
- Lock knobs for tilt and pivot functions
- Twin lights feature dual switches for independent use
- All models designed for use with 849991 (QWLS-60) heavy duty tripod



	Prod. No.	Mod. No.	Description	Watts	Lumens	Amperes	Tripod Included
1	849903	SWL-20	20 Watt SMD Work Site Light	20	2,000	0.2	No
2	849904	SWL-20S	20 Watt SMD Work Site Light with Heavy Duty Tripod	20	2,000	0.2	Yes
3	849914	SWL-40TS	40 Watt SMD Twin Head Work Site Light with Heavy Duty Tripod	40 (2 x 20)	4,000	0.4	Yes
4	849915	SWL-50	50 Watt SMD Work Site Light	50	4,700		No
5	849917	SWL-100T	100 Watt COB Twin Head Work Site Light	100 (2 x 50)	9,400		No

## Heavy Duty Tripod for Work Site Lights

- Features quick release buckle system for quick set up and easy disassembly for transport
- Allows user to quickly switch between different light sets for maximum versatility
- Massive tube steel centre poles and legs for maximum stability and long life
- Cast aluminum yokes are more robust and longer lasting than plastic
- Large easy to use twist collars hold the heaviest STARTECH light sets with ease
- Extends from 30" – 65" (not including light set)
- 6" extension on one leg assists in stabilizing tripod on uneven surfaces
- For use with all STARTECH work lights and many competing models with H style bases

Prod. No.	Mod. No.	Min. Height (in.)	Max. Height (in.)	Base Width (in.)	Fits
849991	QWLS-65	30	65	19 centre to leg	All STARTECH models





## ANGLE GRINDERS

### 4-1/2" Angle Grinder

- 5 A 120 V motor
- Double insulated for safety
- 5/8"-11 arbor
- 12,000 rpm no load speed
- Trigger lock reduces fatigue
- Convenient push button spindle lock for easy wheel changes

011705 / IPT-450

- Side handle fits left or right
- Adjustable wheel guard
- Includes inner and outer flange nut and wheel wrench
- Grinding wheel not included



### 5" Angle Grinder

- 9 A 120 V motor
- Double insulated for safety
- 5/8"-11 arbor
- 10,500 rpm no load speed
- Safety trigger prevents accidental starts
- Convenient push button spindle lock for easy wheel changes

011707 / IPT-500

- Side handle fits left, top, or right
- Adjustable wheel guard
- Includes inner and outer flange nut and wheel wrench
- Grinding wheel not included



### 7" Variable Speed Polisher

- 10 A 120 V motor
- Double insulated for safety
- 5/8"-11 arbor
- 1,000 - 3,000 rpm no load speed with thumbwheel selector
- Convenient push button spindle lock for easy pad changes

011713 / IPT-700V

- Polishing head can be rotated 90° left or right for comfortable use in all positions
- D shaped handle allows a variety of hand positions
- Includes hook and loop backing pad and polishing bonnet



## IMPACT SOCKETS

- Heat treated Chrome Molybdenum sockets for professional applications
- Torque-Drive® sockets apply torque to flats of fasteners to prevent corner rounding and increase torque
- Black phosphate finish resists corrosion and will not peel
- Large easy to read size markings for quick identification



1/2" Drive SAE (in.)	Regular 6 PT.	Deep 6 PT.	1/2" Drive Metric (mm)	Regular 6 PT.	Deep 6 PT.
7/16	026214	026264	10	026310	026360
1/2	026216	026266	11	026311	026361
9/16	026218	026268	12	026312	026362
5/8	026220	026270	13	026313	026363
11/16	026222	026272	14	026314	026364
3/4	026224	026274	15	026315	026365
13/16	026226	026276	16	026316	026366
7/8	026228	026278	17	026317	026367
15/16	026230	026280	18	026318	026368
1	026232	026282	19	026319	026369
1-1/16	026234	026284	21	026321	026371
1-1/8	026236	026286	22	026322	026372
1-1/4	026240	026290	24	026324	026374

# MERCHANDISERS



SUREWERX

MERCHANDISERS



**Holesaw Display**

890251



**SAE Combination Wrench Display**

890204



**Pliers Display**

890207



**Metric Combination Wrench Display**

890205



**Adjustable Wrench Display**

890208



**Screwdriver Display**

890206





### MERCHANDISERS



1/4" Drive Socket Display

890201



3/8" Drive Socket Display

890202

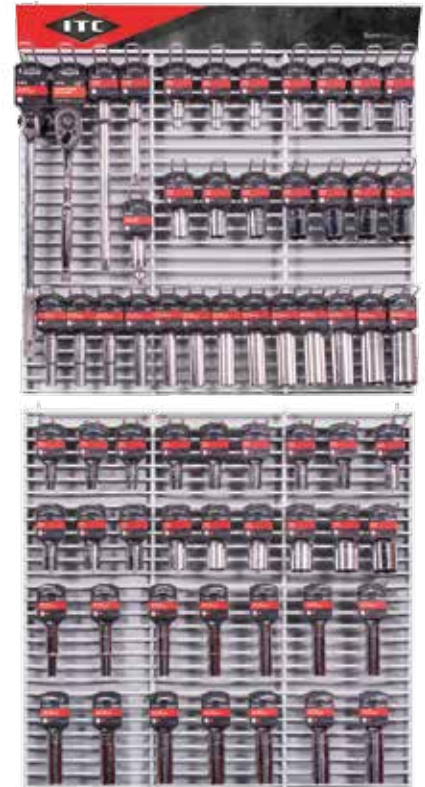

1/2" Drive Socket Display

890203



47" x 11-1/2" ITC Sign

899998

### POP DISPLAYS



COB Penlight POP

849808



Pivot Base COB Worklight POP

849858



# MERCHANDISERS



**Tool Tethering Display**

890252



**Ultra Premium  
PU Safety Boot Display**

V6040502

*sellstrom.* **KneePro**



**Kneepro Ultra Flex III & Hybrid  
Knee Pad Display**

S96500

*sellstrom.*



**Safety Centre - Industrial**

S96556



**Safety Centre - Automotive**

S96555

## INDEX

011705.....	<b>58</b>	849915.....	<b>57</b>	S32281.....	<b>5</b>	S72402.....	<b>19</b>	V856211.....	<b>44</b>	V7031200.....	<b>42</b>
011707.....	<b>58</b>	849917.....	<b>57</b>	S35000.....	<b>9</b>	S73401.....	<b>22</b>	V856220.....	<b>44</b>	V7031300.....	<b>42</b>
011713.....	<b>58</b>	849991.....	<b>57</b>	S35040.....	<b>9</b>	S73402.....	<b>22</b>	V856221.....	<b>44</b>	V7031900.....	<b>42</b>
030490.....	<b>54</b>	890201.....	<b>60</b>	S35100.....	<b>9</b>	S73421.....	<b>22</b>	V1010250.....	<b>36</b>	V8561101.....	<b>45</b>
030491.....	<b>54</b>	890202.....	<b>60</b>	S36000.....	<b>7</b>	S73471.....	<b>22</b>	V1010260.....	<b>36</b>	V8561102.....	<b>45</b>
120111.....	<b>53</b>	890203.....	<b>60</b>	S36040.....	<b>7</b>	S73481.....	<b>22</b>	V1030450.....	<b>39</b>	V8561201.....	<b>45</b>
120112.....	<b>53</b>	890204.....	<b>59</b>	S36050.....	<b>7</b>	S73601.....	<b>21</b>	V1040164.....	<b>37</b>	V8561202.....	<b>45</b>
120114.....	<b>53</b>	890205.....	<b>59</b>	S37040.....	<b>9</b>	S73611.....	<b>21</b>	V1040760.....	<b>37</b>	V8561301.....	<b>45</b>
120115.....	<b>53</b>	890206.....	<b>59</b>	S37599.....	<b>10</b>	S73621.....	<b>21</b>	V1040870.....	<b>37</b>	V8561302.....	<b>45</b>
120116.....	<b>53</b>	890207.....	<b>59</b>	S37600.....	<b>9</b>	S73631.....	<b>21</b>	V1041050.....	<b>37</b>	V8561401.....	<b>45</b>
120613.....	<b>52</b>	890208.....	<b>59</b>	S37601.....	<b>9</b>	S73801.....	<b>23</b>	V1041060.....	<b>37</b>	V8561402.....	<b>45</b>
120615.....	<b>52</b>	890251.....	<b>59</b>	S38110.....	<b>7</b>	S74201.....	<b>21</b>	V1052350.....	<b>36</b>	V8561501.....	<b>45</b>
120616.....	<b>52</b>	890252.....	<b>61</b>	S38140.....	<b>7</b>	S74202.....	<b>24</b>	V1052360.....	<b>36</b>	V8561502.....	<b>45</b>
120617.....	<b>52</b>	890670.....	<b>59</b>	S38150.....	<b>7</b>	S74203.....	<b>24</b>	V1081350.....	<b>38</b>	V8561601.....	<b>45</b>
124212.....	<b>53</b>	899998.....	<b>60</b>	S39100.....	<b>9</b>	S74204.....	<b>24</b>	V1081360.....	<b>38</b>	V8561602.....	<b>45</b>
124213.....	<b>53</b>	S22185.....	<b>26</b>	S39110.....	<b>9</b>	S74241.....	<b>21</b>	V1082350.....	<b>38</b>	V8561701.....	<b>45</b>
124215.....	<b>53</b>	S23401.....	<b>31</b>	S39140.....	<b>9</b>	S74271.....	<b>21</b>	V1082360.....	<b>38</b>	V8561702.....	<b>45</b>
124216.....	<b>53</b>	S23403.....	<b>31</b>	S70000.....	<b>17</b>	S74751.....	<b>24</b>	V1100250.....	<b>36</b>	V8561801.....	<b>45</b>
124217.....	<b>53</b>	S23404.....	<b>31</b>	S70001.....	<b>17</b>	S76301.....	<b>23</b>	V1100260.....	<b>36</b>	V8561802.....	<b>45</b>
355005.....	<b>48</b>	S23406.....	<b>30</b>	S70002.....	<b>17</b>	S76371.....	<b>23</b>	V1120370.....	<b>38</b>		
355007.....	<b>48</b>	S23407.....	<b>30</b>	S70701.....	<b>22</b>	S79103.....	<b>23</b>	V1180260.....	<b>36</b>		
355008.....	<b>48</b>	S23409.....	<b>31</b>	S70703.....	<b>24</b>	S79301.....	<b>23</b>	V2051040.....	<b>42</b>		
380001.....	<b>48</b>	S23410.....	<b>28</b>	S70704.....	<b>24</b>	S79302.....	<b>23</b>	V2051140.....	<b>42</b>		
380021.....	<b>49</b>	S23411.....	<b>28</b>	S70705.....	<b>24</b>	S80200.....	<b>13</b>	V2051240.....	<b>42</b>		
380022.....	<b>49</b>	S23412.....	<b>28</b>	S70711.....	<b>22</b>	S80201.....	<b>13</b>	V2580450.....	<b>39</b>		
408180.....	<b>51</b>	S23413.....	<b>28</b>	S70721.....	<b>22</b>	S80210.....	<b>13</b>	V2580470.....	<b>39</b>		
408181.....	<b>51</b>	S23414.....	<b>28</b>	S70731.....	<b>22</b>	S80231.....	<b>13</b>	V3032050.....	<b>39</b>		
408182.....	<b>51</b>	S23420.....	<b>29</b>	S71100.....	<b>20</b>	S80300.....	<b>11</b>	V3510660.....	<b>40</b>		
408183.....	<b>51</b>	S23421.....	<b>29</b>	S71101.....	<b>20</b>	S81000.....	<b>14</b>	V3510760.....	<b>40</b>		
408184.....	<b>51</b>	S23422.....	<b>29</b>	S71102.....	<b>20</b>	S81200.....	<b>15</b>	V4040180.....	<b>42</b>		
408185.....	<b>51</b>	S23430.....	<b>29</b>	S71200.....	<b>20</b>	S81210.....	<b>15</b>	V4040280.....	<b>42</b>		
408186.....	<b>51</b>	S23431.....	<b>29</b>	S71201.....	<b>20</b>	S81220.....	<b>15</b>	V4040380.....	<b>42</b>		
408187.....	<b>51</b>	S23469.....	<b>26</b>	S71202.....	<b>20</b>	S82500.....	<b>14</b>	V4530170.....	<b>41</b>		
408188.....	<b>51</b>	S23470.....	<b>26</b>	S71203.....	<b>20</b>	S85150.....	<b>15</b>	V4530270.....	<b>41</b>		
408193.....	<b>51</b>	S23480.....	<b>26</b>	S71400.....	<b>21</b>	S85250.....	<b>15</b>	V4530370.....	<b>41</b>		
408194.....	<b>51</b>	S23490.....	<b>26</b>	S71401.....	<b>21</b>	S85550.....	<b>15</b>	V6020450.....	<b>43</b>		
408195.....	<b>51</b>	S30100.....	<b>10</b>	S71402.....	<b>21</b>	S88200.....	<b>14</b>	V6020460.....	<b>43</b>		
408196.....	<b>51</b>	S30110.....	<b>10</b>	S71910.....	<b>17</b>	S88210.....	<b>14</b>	V6040502.....	<b>61</b>		
503323.....	<b>50</b>	S30120.....	<b>10</b>	S71911.....	<b>17</b>	S90322.....	<b>27</b>	V6200750.....	<b>43</b>		
503325.....	<b>50</b>	S30310.....	<b>10</b>	S71912.....	<b>17</b>	S90482.....	<b>25</b>	V6200850.....	<b>43</b>		
503327.....	<b>50</b>	S32000.....	<b>6</b>	S72000.....	<b>18</b>	S90494.....	<b>25</b>	V6300360.....	<b>40</b>		
503329.....	<b>50</b>	S32001.....	<b>6</b>	S72001.....	<b>18</b>	S96110.....	<b>33</b>	V6300760.....	<b>40</b>		
849702.....	<b>56</b>	S32010.....	<b>4</b>	S72002.....	<b>18</b>	S96211.....	<b>33</b>	V6300860.....	<b>40</b>		
849703.....	<b>56</b>	S32011.....	<b>6</b>	S72100.....	<b>19</b>	S96500.....	<b>61</b>	V6300960.....	<b>40</b>		
849708.....	<b>56</b>	S32100.....	<b>6</b>	S72101.....	<b>19</b>	S96555.....	<b>61</b>	V6301050.....	<b>40</b>		
849709.....	<b>56</b>	S32151.....	<b>5</b>	S72102.....	<b>19</b>	S96556.....	<b>61</b>	V6310140.....	<b>43</b>		
849808.....	<b>55, 60</b>	S32155.....	<b>6</b>	S72300.....	<b>19</b>	S97450.....	<b>34</b>	V6310160.....	<b>43</b>		
849858.....	<b>55, 60</b>	S32181.....	<b>5</b>	S72301.....	<b>19</b>	S97452.....	<b>34</b>	V6310240.....	<b>43</b>		
849903.....	<b>57</b>	S32188.....	<b>6</b>	S72302.....	<b>19</b>	S97455.....	<b>34</b>	V6310260.....	<b>43</b>		
849904.....	<b>57</b>	S32210.....	<b>4</b>	S72400.....	<b>19</b>	S97457.....	<b>34</b>	V6310360.....	<b>43</b>		
849914.....	<b>57</b>	S32251.....	<b>5</b>	S72401.....	<b>19</b>	V856210.....	<b>44</b>	V7014540.....	<b>41</b>		



ultra

# NEW & IMPROVED RANPRO ULTRA PU BOOT

## RANPRO ULTRA -50°C COMPOSITE TOE/PLATE PU BOOT

Product No. V4240140 / Model No. B105FUL.GR



Customizable boot height



Mineral, organic and chemical resistant



Composite toe and non-metallic midsole plate



Innovative heel tab for easy removal



Water-channelling, tire tread-inspired soles



This product is covered by SureWerx against defects in materials and workmanship when the product is used for the purpose for which it was designed. Please refer to [surewerx.com](http://surewerx.com) for more warranty information.

A SureWerx Brand

Be Smart. Be Safe. Be Sure.

[surewerx.com](http://surewerx.com)





# PROclub

## BECOME A MEMBER

PROclub is an exclusive club built for professional workers like you. Members are first to hear about tools, equipment, and safety gear for the entire range of SureWerx brands. Activate your membership by visiting [yourproclub.com](http://yourproclub.com) and join Canada's premiere tool and safety community!

### WHY JOIN?

- Take advantage of exclusive promotions
- Receive flyer deals
- New product sneak peeks
- Play interactive games
- Receive monthly newsletters
- Watch product videos and tutorials
- Enter contests to win prizes

JOIN PROCLUB TODAY AT [YOURPROCLUB.COM](http://YOURPROCLUB.COM)







Our products are available from a broad distribution network throughout Canada. We support this network with our own system of warehouses in Vancouver, Edmonton, Winnipeg, Toronto, Montreal and Halifax. This distribution network ensures fast deliveries and superior service to our customers.

Date of publication January, 2017



**Western Canada & Territories**  
(Vancouver Customer Service Centre)

**Toll Free Tel.:** 1-800-472-7685  
**Toll Free Fax:** 1-800-663-7742  
**Sales Tel.:** 604-523-7600  
**Sales Fax:** 604-523-7693

**Head Office (Vancouver)**

**Tel.:** 604-523-TOOL (8665)  
**Fax:** 604-526-JET1 (5381)

**Ontario & Quebec**  
(Toronto Customer Service Centre)

**Toll Free Tel.:** 1-800-387-3879  
**Toll Free Fax:** 1-800-363-2885 (French)  
**Toll Free Fax:** 1-800-267-3310  
**Sales Tel.:** 905-565-8661  
**Sales Fax:** 905-565-7266

**Atlantic Canada**

**Toll Free Tel.:** 1-800-472-7686  
**Toll Free Fax:** 1-877-468-3461  
**Sales Tel.:** 902-468-8324  
**Sales Fax:** 902-468-3461





# OUR FAMILY OF TOOL, EQUIPMENT & SAFETY BRANDS



[surewerx.com](http://surewerx.com)

\$1.99

899923

