

THE NEW VALUE FRONTIER



# 2017 | SOLID ROUND TOOLS CATALOG



## SOLID ROUND CUTTING TOOLS

*MICRO DIAMETER | SOLID CARBIDE | PRECISION ROTARY*

DRILLS

A

END MILLS

B

ROUTERS

C

THREAD MILLS  
& TAPS

D

ENGRAVERS

E

BORING BARS

F

REAMERS

G

SAWS

H

TECHNICAL

I

INDEX

J

ADVANCING PRODUCTIVITY

# KYOCERA

## ROTARY PRECISION TOOLS

Since 1987, Kyocera has designed and manufactured tight tolerance carbide cutting tools and miniature parts for a broad range of markets including the electronics, industrial, medical, automotive, and aerospace industries. We offer high-volume CNC grinding consistency in diameters from 0.0015" (38µm) to 0.500" (12.7mm), tolerances as tight as 0.000039" (.001 mm), superior surface finishes, and high performance coatings. Our history is rooted in precision micro tools. Since our inception, we continually provided the best micro tools and high performance, standard-sized rotary tools to manufacturing companies around the globe. Through our worldwide Kyocera network, we provide precision and high performance cutting tools to factories both large and small.



Our state-of-the-art manufacturing facilities in Costa Mesa, CA include over 65 Swiss-made Rollomatic, Saacke CNC grinding centers, and extensive automated optical inspection (AOI) to ensure quality and consistency. Every tool we build is CAD/CAM designed and has SPC lot traceability as our ISO 9001:2008 and 14001:2004 certifications require.

Partnering with Kyocera's solid rotary and micro tools will help with the strategic development of the entire machining process. Our business was founded on providing specially designed tooling solutions for our customers; and as we grow we continue to provide this value. We offer our customers technical support and recommendations regarding efficient tool applications, proper speeds and feeds, cutting oils, equipment selection, and overall machining process optimization. Upon implementation, we continue to work closely with our customers to further improve their machining capabilities.

# C O N T E N T S

KYOCERA PRECISION TOOLS OVERVIEW	ii - iv
HOW TO ORDER	v
HOW TO READ THIS CATALOG	vi - vii
TOOL SELECTION & APPLICATION GUIDE	viii - xvi
<b>DRILLS</b>	<b>A1 - A50</b>
SPOTTING DRILLS	A2 - A3
MICRO DRILLS	A4 - A40
COOLANT FED DRILLS	A41 - A49
DRILLS FOR BRASS	A50
<b>END MILLS</b>	<b>B1 - B89</b>
SQUARE END MILLS	B3 - B34
BALL NOSE END MILLS	B35 - B64
CORNER RADIUS END MILLS	B65 - B86
COMPRESSION END MILLS (FOR ROUTING OF COMPOSITES)	B87
CHAMFER MILLS	B88 - B89
<b>ROUTERS</b>	<b>C1 - C6</b>
<b>THREAD MILLS &amp; TAPS</b>	<b>D1 - D47</b>
<b>ENGRAVERS</b>	<b>E1 - E4</b>
<b>BORING BARS</b>	<b>F1 - F5</b>
<b>REAMERS</b>	<b>G1 - G15</b>
<b>SAWS</b>	<b>H1 - H20</b>
<b>TECHNICAL INFORMATION &amp; CUSTOM TOOL FORMS</b>	<b>I1 - I53</b>
<b>INDEX</b>	<b>J1 - J3</b>

A

B

C

D

E

F

G

H

I

J

# KYOCERA CUTTING TOOLS

## GLOBAL FACILITIES NETWORK

### NORTH AMERICA

Manufacturing Facilities



North Carolina Facility (USA)



Ohio Facility (USA)



California Facility (USA)

### GLOBAL

Manufacturing Facilities



Okaya Facility (JAPAN)



Yokaichi Facility (JAPAN)



Sendai Facility (JAPAN)



Silong Facility (CHINA)



Incheon Facility (KOREA)



# KYOCERA CUTTING TOOLS

## GLOBAL TECHNICAL CENTERS



North American Technical Center (NC)



Sales & Technical Center (Germany)



Technical Center (BRAZIL)



Technical Center (SINGAPORE)



Technical Center (JAPAN)



Technical Center (CHINA)



Technical Center (JAPAN)



Technical Center (KOREA)



Technical Center (JAPAN)

# KPTI Company Overview

Established in April 2014, KPTI unifies two of the world's leading cutting tool manufacturers, Kyocera Tycom Corporation (KTC) and the Cutting Tool Division of Kyocera Industrial Ceramics Corporation (KICC-CT).

The new company creates a combined enterprise that optimizes the strengths of both organizations and facilitates expansion of Kyocera's overall cutting tool-related business in North America. The new combined entity will unify cutting tool resources to create greater efficiencies while positioning the new organization for continued success.

Customers will benefit from a unified sales and support team offering improved customer service and an expanded portfolio of cutting tool products and solutions for the automotive, aerospace, general machining, medical, power generation, printed circuit board and steel markets.

## KPTI North American Operations



Costa Mesa, CA

Wapakoneta, OH

Hendersonville, NC



### Administration & Manufacturing

- Administration & Accounting Center
- Micro Tools & Round Tools Manufacturing
- Printed Circuit Board Drill Manufacturing
- Micro Tools & PCB Sales & Customer Service Center

### Steel Tool Holder Manufacturing

- Indexable Drills
- Milling End Mills & Face Mills
- Boring Bars
- Turning and Grooving Holders
- API Ring Groovers

### Sales, Tech Center & Marketing

- North American Tech Center
- North American Sales, Marketing & Customer Service Center

## KPTI Markets Served



Automotive



Aerospace



Medical



Printed Circuit Board



Power Generation

## KPTI Manufactured Products



Steel Toolholders for Milling, Turning, Grooving, Threading and Drilling Metal

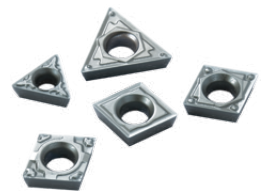

Indexable metal cutting inserts made of carbide, ceramic, cermet, Cubic Boron Nitride, and Polycrystalline diamond



Solid carbide cutting tools for tight tolerance and micro-diameter metal cutting applications

# How to Order

Kyocera Precision Tools' products are sold exclusively through our North American line of authorized distributors.



Locate a Distributor

Use our *Locate a Distributor* map at:  
[www.KyoceraPrecisionTools.com/locate](http://www.KyoceraPrecisionTools.com/locate)

OR

CUSTOMER SERVICE  
 (U.S.) **1.888.848.8449**  
 (International) **001.714.428.3636**

**Monday - Friday**  
 5:00AM - 4:30PM (PST)  
 8:00AM - 7:30PM (EST)

## Using the Kyocera Product Catalogs

All standard Kyocera Precision Tools Products are located in one of these four General Catalogs.

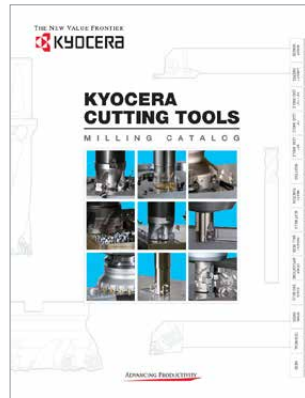

## Stock Status Symbols

- Indicates that an item is **Stock Standard** and available at our Micro Tools plant in Costa Mesa, California. Stock Standard items will ship the same day if ordered by 3:30pm (PST).
- Indicates that an item is **Standard** but **NOT Stocked**. Call us for delivery.
- ◆ Indicates that an item will usually ship in **24-48 hours** depending on size, quantity, or coating requested.
- ▲ Indicates that an item is **Coming Soon** and not yet available. Call for release date information.

## Authorized Distributor Ordering Guide



TO PLACE ORDERS ONLINE VISIT - <http://mykpti.kyocera.com>

In addition to placing orders, the MyKPTI distributor website allows you to view real-time product availability, check pricing, view and download product and promotional literature, watch product training videos, and more.



CUSTOMER SERVICE  
 (U.S.) **1.888.848.8449**  
 (International) **001.714.428.3636**

**Monday - Friday**  
 5:00AM - 4:30PM (PST)  
 8:00AM - 7:30PM (EST)

TECHNICAL SUPPORT  
**1.800.823.7284**  
**OPTION 2**

**Monday - Friday**  
 4:00AM - 2:00PM (PST)  
 7:00AM - 5:00PM (EST)



GENERAL INQUIRIES  
[cuttingtools@kyocera.com](mailto:cuttingtools@kyocera.com)

CUSTOMER SERVICE  
[MIT.CS@kyocera.com](mailto:MIT.CS@kyocera.com)

TECHNICAL CENTER  
[cttechs@kyocera.com](mailto:cttechs@kyocera.com)



# How to Read This Catalog

Use the guide below to better understand how to read the contents of each page. Pages will vary throughout but will remain close to this guide overall.

Tooling Category

Dimensions Diagram

Tool Series

MICRO DRILLS

SERIES 105

1/8" SHANK

MICRO DRILLS

0.0040" - 0.0200" DIAMETER

Mirror Surface Finishes  
Single Edge Construction  
Sub Micron Grain Carbide

STANDARD Flute Length

Drill Size	Dimensions (in)					Uncoated		A1TiN Coated	
	D <sup>0.0005</sup>	d	ℓ	L	Point Angle	Part Number	Stock	Part Number	Stock
.10mm	0.0040	1/8	0.0400	1 1/2	118°	105-0040.040	●	105-0040L040	●
.13mm	0.0050	1/8	0.0400	1 1/2	118°	105-0050.040	●	105-0050L040	●
#97	0.0059	1/8	0.0800	1 1/2	118°	105-0059.080	●	105-0059L080	●
#96	0.0083	1/8	0.0800	1 1/2	118°	105-0083.080	●	105-0083L080	●
#95	0.0087	1/8	0.0800	1 1/2	118°	105-0087.080	●	105-0087L080	●
#94	0.0071	1/8	0.1000	1 1/2	118°	105-0071.100	●	105-0071L100	●
#93	0.0075	1/8	0.1000	1 1/2	118°	105-0075.100	●	105-0075L100	●
#92	0.0079	1/8	0.1000	1 1/2	118°	105-0079.100	●	105-0079L100	●
#91	0.0083	1/8	0.1000	1 1/2	118°	105-0083.100	●	105-0083L100	●
#90	0.0087	1/8	0.1000	1 1/2	118°	105-0087.100	●	105-0087L100	●
#89	0.0091	1/8	0.1500	1 1/2	118°	105-0091.150	●	105-0091L150	●
#88	0.0095	1/8	0.1500	1 1/2	118°	105-0095.150	●	105-0095L150	●
.25mm	0.0096	1/8	0.1500	1 1/2	118°	105-0096.150	●	105-0096L150	●
#87	0.0100	1/8	0.1500	1 1/2	118°	105-0100.150	●	105-0100L150	●
#86	0.0105	1/8	0.1500	1 1/2	118°	105-0105.150	●	105-0105L150	●
#85	0.0110	1/8	0.1500	1 1/2	118°	105-0110.150	●	105-0110L150	●
#84	0.0115	1/8	0.1500	1 1/2	118°	105-0115.150	●	105-0115L150	●
.30mm	0.0118	1/8	0.2250	1 1/2	118°	105-0118.225	●	105-0118L225	●
#83	0.0120	1/8	0.2250	1 1/2	118°	105-0120.225	●	105-0120L225	●
#82	0.0125	1/8	0.2250	1 1/2	118°	105-0125.225	●	105-0125L225	●
#81	0.0130	1/8	0.2250	1 1/2	118°	105-0130.225	●	105-0130L225	●
#80	0.0135	1/8	0.2250	1 1/2	130°	105-0135.225	●	105-0135L225	●
.35mm	0.0138	1/8	0.2250	1 1/2	130°	105-0138.225	●	105-0138L225	●
#79	0.0145	1/8	0.2250	1 1/2	130°	105-0145.225	●	105-0145L225	●
1/64"	0.0156	1/8	0.2500	1 1/2	130°	105-0156.250	●	105-0156L250	●
.40mm	0.0157	1/8	0.2500	1 1/2	130°	105-0157.250	●	105-0157L250	●
#78	0.0160	1/8	0.2500	1 1/2	130°	105-0160.250	●	105-0160L250	●
.45mm	0.0177	1/8	0.2500	1 1/2	130°	105-0177.250	●	105-0177L250	●
#77	0.0180	1/8	0.2500	1 1/2	130°	105-0180.250	●	105-0180L250	●
.50mm	0.0197	1/8	0.2600	1 1/2	130°	105-0197.260	●	105-0197L260	●
#76	0.0200	1/8	0.2600	1 1/2	130°	105-0200.260	●	105-0200L260	●

MICRO GRAIN

118° POINT

130° POINT

R

2

SERIES 105 WORKPIECE MATERIAL

A1TiN	P	P	H	H	M	K	N	N	N	N	N	N	N	N	S	S
	Steel	Steel	Stainless	Stainless	Stainless	Copper Alloy	Aluminum	Graphite	Copper Alloy	CFRP	Plastic	Thermoplastic	High Temp. Plastic	High Temp. Plastic	Nickel/Cobalt	Titanium Alloy
Uncoated	N	N	N	N	N	N	N	N	N	N	N	N	N	N	N	N
	Aluminum	Graphite	Copper Alloy	CFRP	Plastic	Thermoplastic	High Temp. Plastic	Titanium Alloy								

20 **KYOCERA** 1.888.848.8449 Pricing & Availability at [KyoceraPrecisionTools.com](http://KyoceraPrecisionTools.com)

U.S. Stock Standard : ●  
NOT STOCKED - Call for Delivery : ■  
Coming Soon : ▲

Tool Description

Stub, Standard, or Extended Reach

Section Navigation Tabs

DRILLS

END MILLS

ROUTERS

THREAD MILLS & TAPS

ENGRAVING

BORING BITS

REAMERS

SAWS

TECHNICAL

INDEX

Cutting Diameter Range & Attributes

Attribute Icons See Page 7 for Glossary

Dimensions

D : Cutting Diameter & Tolerance  
d : Shank Diameter  
ℓ : Length of Cut (LOC)  
L : Overall Length (OAL)  
L<sub>r</sub> : Reach  
r : Corner or Ball Nose Radius  
A : Included Point Angle  
A<sub>2</sub> : Side Angle

Available Stock Status

● : U.S. Stock Standard Items  
■ : Non-Stock Standard Items  
◆ : Ships in 24-48 Hours  
▲ : Coming Soon

Applicable Workpiece Materials & Priority

# Material Icon Glossary

This glossary will provide you with the material icons shown throughout the catalog. Each product will have applicable materials listed for coated and uncoated tools along with a black star to indicate the material priority.

P	H	M	K	N	S
Carbon Steel & Alloy Steel	Hardened Steel & Chilled Cast Iron	Stainless Steel & Cast Steel	Gray Cast Iron & Nodular Cast Iron	Non-Ferrous Metals & Non-Metals	Heat-Resistant Alloys





















  

# Tool Attributes Icon Glossary

Below is a list of icons used to describe specific tool characterizations throughout the catalog for a quick understanding of the tool's attributes or advantages. Icons will vary based on the tool that is represented. Below are examples.

Sub Micron Grain Carbide	Number of Flutes (2)	8 Times Tool Diameter	Right-Hand Tool	Left-Hand Tool
30° Helix Angle	45° Tip Chamfer Angle	130° Included Point Angle	Corner Radius Tool	Ball Nose Radius Tool
Variable Helix Angle				

# TOOL SELECTION & APPLICATION GUIDE

TOOL TYPE	REF. PAGE	SERIES	FEATURES	SHAPE (Not Actual Tool Size)	NO. OF FLUTES	CUTTING DIAMETER RANGE
DRILLS	A2 A3	080 / 081	1/8" & 3.00mm Shank Micro Spotting Drill		2	0.0050" - 0.1250" 0.15mm - 3.00mm
	A4	105	1/8" Shank Micro Drill		2	0.0040" - 0.1250"
	A10	155	1/8" Shank Inverse Diameter Micro Drill		2	0.1260" - 0.2638"
	A14 A15	160 / 165	Inch & Metric Shank ORION Drills (Match with Series 860 / 865)		2	0.1250" - 0.5000" 3.00mm - 12.00mm
	A19	226	3.00mm Shank Micro Drill		2	0.04mm - 3.00mm
	A32	226L	3.00mm Shank Left Hand Micro Drill		2	0.04mm - 3.00mm
	A39	390	1/8" Shank Ultra Precision Micro Drill Macor® / Vespel® Drilling		2	0.0015" - 0.0040"
	A40	392	1.00mm Shank Ultra Precision Micro Drill Fuel Injector Nozzle Drill		2	0.12mm - 0.60mm
	A41	813	3.00mm - 4.0mm Shank Coolant Fed Micro Drill Deep Hole Drilling Priority		2	1.50mm - 4.00mm
	A45 A46	860 / 865	Inch & Metric Shank HYDROS Coolant Fed Deep Drill (Match with Series 160 / 165)		2	0.1250" - 0.5000" 3.00mm - 12.00mm
	A50	885	3.00mm Shank Micro Drill for Brass		1	0.30mm - 2.00mm
SQUARE END MILLS	B3	1610	Standard Length 2 Flute for General Purpose Machining		2	0.0040" - 0.3750" 0.10mm - 6.00mm
	B7	1620	Stub Length 2 Flute for General Purpose Machining		2	0.0040" - 0.2500" 0.10mm - 6.00mm
	B11	1640	Extended Reach 2 Flute for Deep Reach Milling		2	0.0100" - 0.1250" 0.40mm - 6.00mm
	B14	TITAN-AX TITAN-AXM	Reinforced Shank Square End for Tough Machining Applications		3	0.0312" - 0.2500" 1.00mm - 8.00mm
	B16	1710	Standard Length 3 Flute for General Purpose Machining		3	0.0100" - 0.1250"
	B18	1740	Extended Reach 3 Flute for Deep Reach Milling		3	0.0100" - 0.2500"
	B20	1742	Extended Reach Stub Length for Deep Reach Milling		3	0.0100" - 0.2500"
	B25	1810	Standard Length 4 Flute for General Purpose Machining		4	0.0050" - 0.2500" 0.10mm - 6.00mm
	B29	1820	Stub Length 4 Flute for General Purpose Machining		4	0.0050" - 0.2500" 0.10mm - 6.00mm
	B32	1840	Extended Reach 4 Flute for Deep Reach Milling		4	0.0100" - 0.1250" 0.40mm - 6.00mm





















# TOOL SELECTION & APPLICATION GUIDE

REF. PAGE	SERIES	COATING	WORKPIECE MATERIAL PRIORITY														
			Steel		Hardened Steel		Stainless Steel	Cast Iron	Non-Ferrous Metals & Non-Metals						Heat-Resistant Alloys		
<u>A2</u>	080 / 081	AITIN	★	★	★	★	★	☆		☆	☆	☆	☆	☆	☆	☆	☆
<u>A3</u>		Uncoated							☆	☆	☆	☆	☆	☆	☆	☆	☆
<u>A4</u>	105	AITIN	★	★	★	★	★	☆		☆	☆	☆	☆	☆	☆	☆	☆
		Uncoated							☆	☆	★	☆	★	★	★		☆
<u>A10</u>	155	Uncoated							☆	☆	★	☆	★	★	★		☆
<u>A14</u>	160 / 165	AITIN	★	★	★	★	★	☆		☆	☆		☆	☆	☆	★	★
<u>A15</u>		Nano	★	★	★	★	★	☆		☆	☆		☆	☆	☆	★	★
<u>A19</u>	226	AITIN	★	★	★	★	★	☆		☆	☆	☆	☆	☆	☆	☆	☆
		Uncoated							☆	☆	★	☆	★	★	★		☆
<u>A32</u>	226L	AITIN	★	★	★	★	★	☆		☆	☆	☆	☆	☆	☆	☆	☆
		Uncoated							☆	☆	★	☆	★	★	★		☆
<u>A39</u>	390	Uncoated							☆	☆	★	☆	★	★	★		☆
<u>A40</u>	392	AITIN	★	★	★	★	★	☆		☆	☆	☆	☆	☆	☆	☆	☆
		Uncoated							☆	☆	★	☆	★	★	★		☆
<u>A41</u>	813	AITIN	★	★	★	★	★	☆		☆	☆	☆	☆	☆	☆	★	★
		Uncoated	☆	☆	☆	☆	☆	☆	★	☆	☆	☆	☆	☆	☆	☆	☆
<u>A45</u>	860 / 865	AITIN	★	★	★	★	★	☆		☆	☆		☆	☆	☆	★	★
<u>A46</u>		Nano	★	★	★	★	★	☆		☆	☆		☆	☆	☆	★	★
<u>A50</u>	885	TiCN	☆	☆	☆	☆	☆	☆	☆		★					☆	☆
		Uncoated	☆	☆	☆	☆	★	★	☆	☆	★		☆	☆	☆	★	★
<u>B3</u>	1610	AITIN	★	★	★	☆	☆	☆		☆	★	☆	★	★		☆	☆
		DLC							☆	★	☆	★	★	★			
	Uncoated							☆	☆	★	☆	★	★	☆		☆	☆
<u>B7</u>	1620	AITIN	★	★	★	☆	☆	☆		☆	★	☆	★	★		☆	☆
		DLC							☆	★	☆	★	★	★			
	Uncoated							☆	☆	★	☆	★	★	☆			☆
<u>B11</u>	1640	AITIN	★	★	★	☆	☆	☆								☆	☆
		Uncoated							☆	☆	★	☆	★	★	☆		
<u>B14</u>	TITAN-AX TITAN-AXM	AX	☆	☆	★	★	☆	☆								★	★
<u>B16</u>	1710	AITIN	★	★	★	☆	☆	☆								☆	☆
		DLC							☆	★	☆	★	★	★			
	Uncoated							☆	☆	☆	☆	☆	☆	☆	☆		☆
<u>B18</u>	1740	AITIN	★	★	★	☆	☆	☆		☆	★	☆	★	★		☆	☆
		DLC							☆	★	☆	★	★	★			
	Uncoated							☆	☆	☆	☆	☆	☆	☆	☆		☆
<u>B20</u>	1742	AITIN	★	★	★	☆	☆	☆								☆	☆
		DLC							☆	★	☆	★	★	★			
	Uncoated							☆	☆	☆	☆	☆	☆	☆	☆		☆
<u>B25</u>	1810	AITIN	★	★	★	☆	☆	☆		☆	★	☆	★	★		☆	☆
		DLC							☆	★	☆	★	★	★			
	Uncoated							☆	☆	☆	☆	☆	☆	☆	☆		☆
<u>B29</u>	1820	AITIN	★	★	★	☆	☆	☆		☆	★	☆	★	★		☆	☆
		DLC							☆	★	☆	★	★	★			
	Uncoated							☆	☆	☆	☆	☆	☆	☆	☆		☆
<u>B32</u>	1840	AITIN	★	★	★	☆	☆	☆								☆	☆
		Uncoated							☆	☆	☆	☆	☆	☆	☆		















★ : Priority Materials ☆ : Applicable Materials

# TOOL SELECTION & APPLICATION GUIDE

TOOL TYPE	REF. PAGE	SERIES	FEATURES	SHAPE (Not Actual Tool Size)	NO. OF FLUTES	CUTTING DIAMETER RANGE
BALL NOSE END MILLS	B35	1625	Standard Length 2 Flute Ball Nose End Mill		2	0.0050" - 0.2500" 0.10mm - 6.00mm
	B39	1635	Stub Length 2 Flute Ball Nose End Mill		2	0.0050" - 0.2500" 0.10mm - 6.00mm
	B42	1645	Extended Reach 2 Flute Ball Nose End Mill		2	0.0100" - 0.1250" 0.40mm - 6.00mm
	<b>NEW</b> B45	1685	Reverse Shank 2 Flute Ball Nose End Mill		2	0.1563" - 0.7500"
	B46	16 HMS*	Ball Nose End Mill for Hard Metal Milling		2	0.20mm - 3.00mm
	B47	16 HMR*	Extended Reach Ball Nose for Hard Metal Milling		2	0.20mm - 3.00mm
	B48	16 RB*	Extended Reach Ball Nose for Rib Processing		2	0.50mm - 1.50mm
	B49	1725	Standard Length 3 Flute Ball Nose End Mill		3	0.0100" - 0.1000"
	B50	1745	Extended Reach 3 Flute Ball Nose End Mill		3	0.0100" - 0.1000"
	B51	1755	Extended Reach Stub Length Ball Nose End Mill		3	0.0100" - 0.2500"
	B55	1825	Standard Length 4 Flute Ball Nose End Mill		4	0.0100" - 0.2500" 0.40mm - 6.00mm
	B59	1835	Stub Length 4 Flute Ball Nose End Mill		4	0.0100" - 0.2500" 0.40mm - 6.00mm
	B62	1845	Extended Reach 4 Flute Ball Nose End Mill		4	0.0100" - 0.2500" 0.40mm - 6.00mm
CORNER RADIUS END MILLS	<b>NEW</b> B65	1611	Standard Length 2 Flute X-Small Corner Radius End Mill		2	0.0500" - 0.1000"
	B66	1612	Standard Length 2 Flute Small Corner Radius End Mill		2	0.0150" - 0.2500"
	B67	1613	Standard Length 2 Flute Standard Corner Radius End Mill		2	0.0156" - 0.2500"
	<b>NEW</b> B68	1614	Standard Length 2 Flute Large Corner Radius End Mill		2	0.0450" - 0.5000"
	<b>NEW</b> B68	1616	Standard Length 2 Flute X-Large Corner Radius End Mill		2	0.0450" - 0.5000"
	<b>NEW</b> B69	1617	Standard Length 2 Flute XX-Large Corner Radius End Mill		2	0.0938" - 0.5000"

\* High Performance End Mills.  
See product page for high performance features.

# TOOL SELECTION & APPLICATION GUIDE

REF. PAGE	SERIES	COATING	WORKPIECE MATERIAL PRIORITY															
			Steel		Hardened Steel		Stainless Steel	Cast Iron	Non-Ferrous Metals & Non-Metals						Heat-Resistant Alloys			
																		
B35	1625	AITIN	★	★	★	☆	☆	☆									☆	☆
		DLC							☆	★	☆	★	★	★				
		Uncoated							☆	☆	★	☆	★	★				☆
B39	1635	AITIN	★	★	★	☆	☆	☆									☆	☆
		DLC							☆	★	☆	★	★	★				
		Uncoated							☆	☆	★	☆	★	★	☆			☆
B42	1645	AITIN	★	★	★	☆	☆	☆									☆	☆
		DLC							☆	★	☆	★	★	★				
		Uncoated							☆	☆	★	☆	★	★				☆
B45	1685	AITIN	★	★	★	☆	☆	☆									☆	☆
		Uncoated							☆	☆	★	☆	★	★	☆			☆
B46	16 HMS*	AX	☆	☆	★	★	☆	☆									☆	☆
B47	16 HMR*	AX	☆	☆	★	★	☆	☆									☆	☆
B48	16 RB*	AX	☆	☆	★	★	☆	☆									☆	☆
B49	1725	AITIN	★	★	★	☆	☆	☆									☆	☆
		DLC							☆	★	☆	★	★	★				
		Uncoated							☆	☆	☆	☆	☆	☆	☆			☆
B50	1745	AITIN	★	★	★	☆	☆	☆									☆	☆
		DLC							☆	★	☆	★	★	★				
		Uncoated							☆	☆	☆	☆	☆	☆	☆			☆
B51	1755	AITIN	★	★	★	☆	☆	☆									☆	☆
		DLC							☆	★	☆	★	★	★				
		Uncoated							☆	☆	☆	☆	☆	☆	☆			☆
B55	1825	AITIN	★	★	★	☆	☆	☆									☆	☆
		DLC							☆	★	☆	★	★	★				
		Uncoated							☆	☆	☆	☆	☆	☆	☆			☆
B59	1835	AITIN	★	★	★	☆	☆	☆									☆	☆
		DLC							☆	★	☆	★	★	★				
		Uncoated							☆	☆	☆	☆	☆	☆	☆			☆
B62	1845	AITIN	★	★	★	☆	☆	☆									☆	☆
		DLC							☆	★	☆	★	★	★				
		Uncoated							☆	☆	☆	☆	☆	☆	☆			☆
B65	1611	AITIN	★	★	★	☆	☆	☆									☆	☆
		DLC							☆	★	☆	★	★	★				
		Uncoated							☆	☆	★	☆	★	★	☆			☆
B66	1612	AITIN	★	★	★	☆	☆	☆									☆	☆
		DLC							☆	★	☆	★	★	★				
		Uncoated							☆	☆	★	☆	★	★	☆			☆
B67	1613	AITIN	★	★	★	☆	☆	☆									☆	☆
		DLC							☆	★	☆	★	★	★				
		Uncoated							☆	☆	★	☆	★	★	☆			☆
B68	1614	AITIN	★	★	★	☆	☆	☆									☆	☆
		DLC							☆	★	☆	★	★	★				
		Uncoated							☆	☆	★	☆	★	★	☆			☆
B68	1616	AITIN	★	★	★	☆	☆	☆									☆	☆
		DLC							☆	★	☆	★	★	★				
		Uncoated							☆	☆	★	☆	★	★	☆			☆
B69	1617	AITIN	★	★	★	☆	☆	☆									☆	☆
		DLC							☆	★	☆	★	★	★				
		Uncoated							☆	☆	★	☆	★	★	☆			☆

\* High Performance End Mills.

See product page for high performance features.

















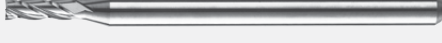

★ : Priority Materials ☆ : Applicable Materials

(U.S.) 1.888.848.8449

(International) 001.714.428.3636

Pricing & Availability at [KyoceraPrecisionTools.com](http://KyoceraPrecisionTools.com)

# TOOL SELECTION & APPLICATION GUIDE

TOOL TYPE	REF. PAGE	SERIES	FEATURES	SHAPE (Not Actual Tool Size)	NO. OF FLUTES	CUTTING DIAMETER RANGE	
CORNER RADIUS END MILLS	<b>B69</b>	<b>NEW</b> 1618	Standard Length 2 Flute XXX-Large Corner Radius End Mill		2	0.0938" - 0.5000"	
	<b>B70</b>	1703*	Standard Length 3 Flute High Helix Corner Radius End Mill		3	1.00mm - 6.00mm	
	<b>B71</b>	TITAN-AX* TITAN-AXM*	Reinforced Shank Corner Radius for Tough Machining Applications		3	0.0312" - 0.2500" 1.00mm - 8.00mm	
	<b>B74</b>	<b>NEW</b> 1743	Extended Reach 3 Flute Small Corner Radius End Mills		3	0.0156" - 0.2500"	
	<b>B75</b>	<b>NEW</b> 1744	Extended Reach 3 Flute Standard Corner Radius End Mill		3	0.0312" - 0.2500"	
	<b>B76</b>	<b>NEW</b> 1746	Extended Reach 3 Flute Large Corner Radius End Mill		3	0.0625" - 0.1250"	
	<b>B77</b>	1804*	Standard Length 4 Flute High Helix Corner Radius End Mill		4	1.00mm - 6.00mm"	
	<b>B78</b>	1812	Standard Length 4 Flute Small Corner Radius End Mill		4	0.0150" - 0.2500"	
	<b>B79</b>	1813	Standard Length 4 Flute Standard Corner Radius End Mill		4	0.0156" - 0.2500"	
	<b>B80</b>	<b>NEW</b> 1814	Standard Length 4 Flute Large Corner Radius End Mill		4	0.0450" - 0.2500"	
	<b>B80</b>	<b>NEW</b> 1816	Standard Length 4 Flute X-Large Corner Radius End Mill		4	0.0450" - 0.2500"	
	<b>B81</b>	1817	Standard Length 4 Flute XX-Large Corner Radius End Mill		4	0.0938" - 0.2500"	
	<b>B81</b>	1818	Standard Length 4 Flute XXX-Large Corner Radius End Mill		4	0.0938" - 0.2500"	
	<b>B82</b>	AP4* AP4M*	Variable Helix APOLLO End Mill for Alloy Steel, Nickel Inconel Alloys, Stainless Steel, and Carbon Steel		4	0.1250" - 1.0000" 3.00mm - 25.00mm	
	COMPRESSION END MILLS	<b>B84</b>	1905*	Standard Length 5 Flute High Helix Corner Radius End Mill		5	1.00mm - 6.00mm
		<b>B85</b>	AP5* AP5M*	Variable Helix APOLLO End Mill for Alloy Steel, Nickel Inconel Alloys, Stainless Steel, and Carbon Steel		5	0.2500" - 1.0000" 3.00mm - 25.00mm
<b>B87</b>		<b>NEW</b> 1890	VULCAN Compression End Mill for Routing Composites		4, 6, 8	0.2500" - 0.5000" 6.00mm - 12.00mm	
CHAMFER MILLS	<b>B88</b>	CM	1/8" Shank Chamfer Mills		2	Point Angle 30° - 120°	
	<b>B89</b>	CMM	Metric Shank Chamfer Mills		2, 4	Point Angle 60°, 90°, 120°	















\* High Performance End Mills.  
See product page for high performance features.

# TOOL SELECTION & APPLICATION GUIDE

REF. PAGE	SERIES	COATING	WORKPIECE MATERIAL PRIORITY																
			Steel		Hardened Steel		Stainless Steel	Cast Iron	Non-Ferrous Metals & Non-Metals						Heat-Resistant Alloys				
B69	1618	AiTIN	★	★	★	☆	☆	☆									☆	☆	
		DLC								☆	★	☆	★	★	★				
		Uncoated								☆	☆	★	☆	★	★	☆			☆
B70	1703*	AiTIN	★	★	★	☆	☆	☆									☆	☆	
		Uncoated								☆	☆	☆	☆	☆	☆	☆			☆
B71	TITAN-AX* TITAN-AXM*	AX	☆	☆	★	★	☆	☆									★	★	
B74	1743	AiTIN	★	★	★	☆	☆	☆									☆	☆	
		DLC								☆	★	☆	★	★	★				
		Uncoated								☆	☆	★	☆	★	★	☆			☆
B75	1744	AiTIN	★	★	★	☆	☆	☆									☆	☆	
		DLC								☆	★	☆	★	★	★				
		Uncoated								☆	☆	★	☆	★	★	☆			☆
B76	1746	AiTIN	★	★	★	☆	☆	☆									☆	☆	
		DLC								☆	★	☆	★	★	★				
		Uncoated								☆	☆	★	☆	★	★	☆			☆
B77	1804*	AiTIN	★	★	★	☆	☆	☆									☆	☆	
		Uncoated								☆	☆	☆	☆	☆	☆	☆			☆
B78	1812	AiTIN	★	★	★	☆	☆	☆									☆	☆	
		DLC								☆	★	☆	★	★	★				
		Uncoated								☆	☆	☆	☆	☆	☆	☆			☆
B79	1813	AiTIN	★	★	★	☆	☆	☆									☆	☆	
		DLC								☆	★	☆	★	★	★				
		Uncoated								☆	☆	☆	☆	☆	☆	☆			☆
B80	1814	AiTIN	★	★	★	☆	☆	☆									☆	☆	
		DLC								☆	★	☆	★	★	★				
		Uncoated								☆	☆	☆	☆	☆	☆	☆			☆
B80	1816	AiTIN	★	★	★	☆	☆	☆									☆	☆	
		DLC								☆	★	☆	★	★	★				
		Uncoated								☆	☆	☆	☆	☆	☆	☆			☆
B81	1817	AiTIN	★	★	★	☆	☆	☆									☆	☆	
		DLC								☆	★	☆	★	★	★				
		Uncoated								☆	☆	☆	☆	☆	☆	☆			☆
B81	1818	AiTIN	★	★	★	☆	☆	☆									☆	☆	
		DLC								☆	★	☆	★	★	★				
		Uncoated								☆	☆	☆	☆	☆	☆	☆			☆
B82	AP4* AP4M*	AlCrN	☆	☆	★	★	★	☆									★	★	
B84	1905	AiTIN	★	★	★	☆	☆	☆									☆	☆	
		Uncoated								☆	☆	☆	☆	☆	☆	☆			☆
B85	AP5* AP5M*	AlCrN	☆	☆	★	★	★	☆									☆	☆	
B85	1890	CVD Diamond																	
			★	★	★	★	★	★	★	★	★	★	★	★	★				
B88	CM	AiTIN	★	★	★	☆	☆	☆									☆	☆	
		Uncoated	☆	☆	☆	☆	☆	☆	★		★					☆			☆
B89	CMM	AiTIN	★	★	★	☆	☆	☆									☆	☆	
		Uncoated	☆	☆	☆	☆	☆	☆	★		★					☆			☆

\* High Performance End Mills.  
See product page for high performance features.

# TOOL SELECTION & APPLICATION GUIDE

TOOL TYPE	REF. PAGE	SERIES	FEATURES	SHAPE (Not Actual Tool Size)	NO. OF FLUTES	CUTTING DIAMETER RANGE
ROUTERS	<b>C2</b>	2120	Up Cut Diamond Pattern Router Bits for CFRP, Fiberglass, and Composite Materials		-	0.0312" - 0.2500" 0.80mm - 8.00mm
	<b>C4</b>	2121	Down Cut Diamond Pattern Router Bits for CFRP, Fiberglass, and Composite Materials		-	0.0312" - 0.2500" 0.80mm - 8.00mm
	<b>C6</b>	2320	Up Cut & Down Cut Chipbreaker Pattern Router Bits for CFRP, Fiberglass, and Composite Materials		-	0.0312" - 0.2500" 0.80mm - 8.00mm
THREAD MILLS	<b>D2</b>	98M	Single Point Micro Thread Mill		-	Thread Size M0.5 - M8
ENGRAVERS	<b>E2</b>	EGR	2 Flute Micro Engraving Tool for General Purpose Machining		2	Point Angle 30° - 90°
	<b>E3</b>	HR	Half Round Micro Engraving Tool for General Purpose Machining		-	Line Width 0.0050" - 0.0315" 0.25mm - 0.80mm
	<b>E4</b>	SPD	Spade Micro Engraving Tool for Spotting or Chamfering		-	Point Angle 30° - 118°
BORING BARS	<b>F2</b>	MBS	Standard Length Internal Diameter Profile Boring		-	0.0150" - 0.2400" 0.40mm - 6.00mm
	<b>F4</b>	MBE	Extended Reach Internal Diameter Profile Boring		-	0.0150" - 0.2400" 0.40mm - 6.00mm
REAMERS	<b>G2</b>	MR34	3.00mm Shank 4 Flute Micro Reamer Left-Hand Spiral / Right-Hand Cutting		4	0.20mm - 2.40mm
	<b>G10</b>	MR46	4.00mm Shank 6 Flute Micro Reamer Left-Hand Spiral / Right-Hand Cutting		6	2.41mm - 3.90mm
	<b>G13</b>	MR66	6.00mm Shank 6 Flute Micro Reamer Left-Hand Spiral / Right-Hand Cutting		6	3.97mm - 5.90mm
	<b>G14</b>	MR86	8.00mm Shank 6 Flute Micro Reamer Left-Hand Spiral / Right-Hand Cutting		6	5.97mm - 7.90mm
	<b>G15</b>	MR106	10.00mm Shank 6 Flute Micro Reamer Left-Hand Spiral / Right-Hand Cutting		6	7.97mm - 8.03mm



## SPECIAL TAPS NEW

Inch Sizes  
Page [D6 - D15](#)

Metric Sizes  
Page [D16 - D21](#)



## SOLID CARBIDE SAWS NEW

3/4" - 4" Diameters  
Page [H6 - H11](#)

20mm - 100mm Diameters  
Page [H12 - H20](#)



# TOOL SELECTION & APPLICATION GUIDE

REF. PAGE	SERIES	COATING	WORKPIECE MATERIAL PRIORITY														
			Steel		Hardened Steel		Stainless Steel	Cast Iron	Non-Ferrous Metals & Non-Metals							Heat-Resistant Alloys	
			<b>P</b> Steel ~30HRC	<b>P</b> Steel 30~40HRC	<b>H</b> Hardened Steel ~55HRC	<b>H</b> Hardened Steel ~68HRC	<b>M</b> Stainless Steel	<b>K</b> Cast Iron	<b>N</b> Aluminum	<b>N</b> Graphite	<b>N</b> Copper Alloy	<b>N</b> CFRP	<b>N</b> Plastic	<b>N</b> Thermoset Plastic	<b>N</b> High Density Plastic	<b>S</b> Nickel / Cobalt	<b>S</b> Titanium Alloy
C2	2120	Diamond							☆	★		★					
		DLC							☆	☆		☆					
		Uncoated							☆		★	★	☆	☆	☆		
C4	2121	Diamond							☆	★		★					
		DLC							☆	☆		☆					
		Uncoated							☆		★	★	☆	☆	☆		
C6	2320	Diamond							☆	★		★					
		DLC							☆	☆		☆					
		Uncoated							☆		★	★	☆	☆	☆		
D2	98M	AITIN	★	★	★	☆	☆	☆			☆						
		Uncoated							☆		★	★	☆	☆	☆		★
E2	EGR	Uncoated	★	★	☆	☆	☆		☆	☆	☆	☆				☆	☆
E3	HR	Uncoated	★	★	☆	☆	☆		☆	☆	☆	☆				☆	☆
E4	SPD	Uncoated	★	★	☆	☆	☆		☆	☆	☆	☆				☆	☆
F2	MBS	AITIN	★	★	★	☆	☆	☆			☆					☆	☆
		Uncoated	★	★	★	☆	☆		☆		☆				☆		
F4	MBE	AITIN	★	★	★	☆	☆	☆			☆					☆	☆
		Uncoated	★	★	★	☆	☆		☆		☆				☆		
G2	MR34	Uncoated	★	★	★	★	★	☆	☆	☆	☆	☆	☆	☆	☆	★	★
G10	MR46	AITIN	★	★	★	★	★	☆								☆	☆
		Uncoated	☆	☆	☆	☆	☆	☆	☆	☆	☆	☆	☆	☆	☆	☆	☆
G13	MR66	AITIN	★	★	★	★	★	☆								☆	☆
		Uncoated	☆	☆	☆	☆	☆	☆	☆	☆	☆	☆	☆	☆	☆	☆	☆
G14	MR86	AITIN	★	★	★	★	★	☆								☆	☆
		Uncoated	☆	☆	☆	☆	☆	☆	☆	☆	☆	☆	☆	☆	☆	☆	☆
G15	MR106	AITIN	★	★	★	★	★	☆								☆	☆
		Uncoated	☆	☆	☆	☆	☆	☆	☆	☆	☆	☆	☆	☆	☆	☆	☆

★ : Priority Materials ☆ : Applicable Materials



# A

# DRILLS

## A1 - A50

### MICRO SPOTTING DRILLS A2 - A3

SERIES 080	0.0050" - 0.1250" Dia.	1/8" Shank	Micro Spotting Drills	A2
SERIES 081	0.15mm - 3.00mm Dia.	3mm Shank	Micro Spotting Drills	A3

### MICRO DRILLS A4 - A40

SERIES 105	0.0040" - 0.1250" Dia.	1/8" Shank	Micro Drills	A4 - A9
SERIES 155	0.1260" - 0.2638" Dia.	1/8" Shank	Inverse Dia. Micro Drills	A10 - A13
SERIES 160	0.1250" - 0.5000" Dia.	Inch Shank	ORION Pilot Drills	A14
SERIES 165	3.00mm - 12.00mm Dia.	Metric Shank	ORION Pilot Drills	A15 - A18
SERIES 226	0.04mm - 3.00mm Dia.	3mm Shank	Micro-Drills	A19 - A31
SERIES 226L	0.04mm - 3.00mm Dia.	3mm Shank	Left-Hand Micro Drills	A32 - A38
SERIES 390	0.0015" - 0.0040" Dia.	1/8" Shank	Ultra Precision Micro Drills	A39
SERIES 392	0.12mm - 0.60mm Dia.	1mm Shank	Ultra Precision Micro Drills	A40

### COOLANT FED DRILLS A41 - A49

SERIES 813	1.50mm - 4.00mm Dia.	3mm - 4mm Shank	Coolant Fed Drills	A41 - A44
HYDROS SERIES 860	0.1250" - 0.5000" Dia.	Inch Shank	HYDROS Coolant Fed Drills	A45
HYDROS SERIES 865	3.00mm - 12.00mm Dia.	Metric Shank	HYDROS Coolant Fed Drills	A46 - A49

### DRILLS FOR BRASS A50

SERIES 885	0.30mm - 2.00mm Dia.	3mm Shank	Micro Drills for Brass	A50
------------	----------------------	-----------	------------------------	-----

# 1/8" SHANK

MICRO SPOTTING DRILLS

0.0050" - 0.1250" DIAMETER

Mirror Surface Finishes  
Sub Micron Grain Carbide

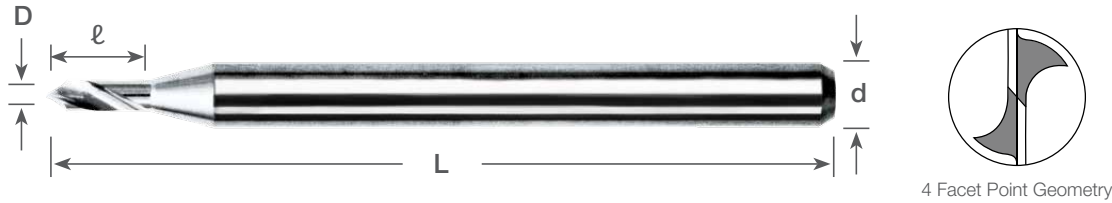

90° Included Point Angle

Dimensions (in)				Uncoated		AlTiN Coating	
D <sup>+0.0000</sup> / <sub>-0.0003</sub>	d	ℓ	L	Part Number	Stock	Part Number	Stock
0.0050	1/8	0.0250	1 1/2	080-0050.90	●	080-0050L90	●
0.0100	1/8	0.0350	1 1/2	080-0100.90	●	080-0100L90	●
0.0150	1/8	0.0450	1 1/2	080-0150.90	●	080-0150L90	●
0.0200	1/8	0.0500	1 1/2	080-0200.90	●	080-0200L90	●
0.0312	1/8	0.0900	1 1/2	080-0312.90	●	080-0312L90	●
0.0625	1/8	0.2000	1 1/2	080-0625.90	●	080-0625L90	●
0.0938	1/8	0.2000	1 1/2	080-0938.90	●	080-0938L90	●
0.1250	1/8	0.2000	1 1/2	080-1250.90	●	080-1250L90	●



130° Included Point Angle

Dimensions (in)				Uncoated		AlTiN Coating	
D <sup>+0.0000</sup> / <sub>-0.0003</sub>	d	ℓ	L	Part Number	Stock	Part Number	Stock
0.0050	1/8	0.0250	1 1/2	080-0050.130	●	080-0050L130	●
0.0100	1/8	0.0350	1 1/2	080-0100.130	●	080-0100L130	●
0.0150	1/8	0.0450	1 1/2	080-0150.130	●	080-0150L130	●
0.0200	1/8	0.0500	1 1/2	080-0200.130	●	080-0200L130	●
0.0312	1/8	0.0900	1 1/2	080-0312.130	●	080-0312L130	●
0.0625	1/8	0.2000	1 1/2	080-0625.130	●	080-0625L130	●
0.0938	1/8	0.2000	1 1/2	080-0938.130	●	080-0938L130	●
0.1250	1/8	0.2000	1 1/2	080-1250.130	●	080-1250L130	●

SERIES 080 WORKPIECE MATERIAL															
Coating	P Steel ~30HRC	P Steel 30-40HRC	H Hardened Steel ~55HRC	H Hardened Steel ~68HRC	M Stainless Steel	K Cast Iron	N Aluminum	N Graphite	N Copper Alloy	N CFRP	N Plastic	N Thermoset Plastic	N High Density Plastic	S Nickel / Cobalt	S Titanium Alloy
AlTiN	★	★	★	★	★	☆	☆	☆	☆	☆	☆	☆	☆	☆	☆
Uncoated							☆	☆	☆	☆	☆	☆	☆		☆

★ : Priority ☆ : Applicable Materials

Symbol Descriptions Page vii

# 3.00mm SHANK

MICRO SPOTTING DRILLS

0.15mm - 3.00mm DIAMETER

Mirror Surface Finishes  
Sub Micron Grain Carbide

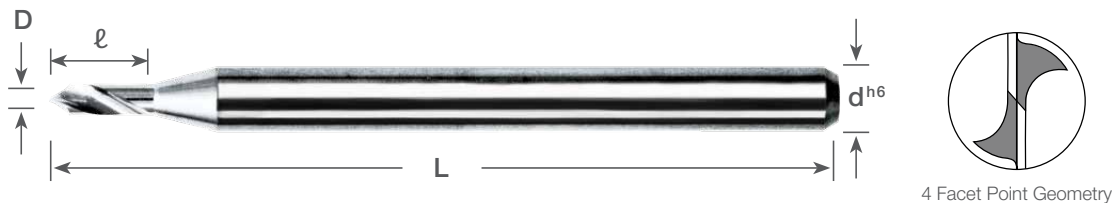

4 Facet Point Geometry

## 90° Included Point Angle



Dimensions (mm)				Uncoated		AlTiN Coating	
D	d <sup>h6</sup>	ℓ	L	Part Number	Stock	Part Number	Stock
0.15	3	0.65	38	081-0059.90	●	081-0059L90	●
0.25	3	0.90	38	081-0098.90	●	081-0098L90	●
0.40	3	1.15	38	081-0157.90	●	081-0157L90	●
0.50	3	1.30	38	081-0197.90	●	081-0197L90	●
1.00	3	2.30	38	081-0394.90	●	081-0394L90	●
1.50	3	5.00	38	081-0591.90	●	081-0591L90	●
2.00	3	5.00	38	081-0787.90	●	081-0787L90	●
3.00	3	5.00	38	081-1181.90	●	081-1181L90	●

## 130° Included Point Angle



Dimensions (mm)				Uncoated		AlTiN Coating	
D	d <sup>h6</sup>	ℓ	L	Part Number	Stock	Part Number	Stock
0.15	3	0.65	38	081-0059.130	●	081-0059L130	●
0.25	3	0.90	38	081-0098.130	●	081-0098L130	●
0.40	3	1.15	38	081-0157.130	●	081-0157L130	●
0.50	3	1.30	38	081-0197.130	●	081-0197L130	●
1.00	3	2.30	38	081-0394.130	●	081-0394L130	●
1.50	3	5.00	38	081-0591.130	●	081-0591L130	●
2.00	3	5.00	38	081-0787.130	●	081-0787L130	●
3.00	3	5.00	38	081-1181.130	●	081-1181L130	●

SERIES 081 WORKPIECE MATERIAL															
Coating	P	P	H	H	M	K	N	N	N	N	N	N	S	S	
	Steel -30HRC	Steel 30-40HRC	Hardened Steel -55HRC	Hardened Steel -68HRC	Stainless Steel	Cast Iron	Aluminum	Graphite	Copper Alloy	CFRP	Plastic	Thermoset Plastic	High Density Plastic	Nickel / Cobalt	Titanium Alloy
AlTiN	★	★	★	★	★	☆	☆	☆	☆	☆	☆	☆	☆	☆	☆
Uncoated							☆	☆	☆	☆	☆	☆			☆

★ : Priority ☆ : Applicable Materials

Symbol Descriptions Page vii

● : U.S. Stock Standard  
■ : NOT STOCKED - Call for Delivery

(U.S.) 1.888.848.8449  
(International) 001.714.428.3636  
Pricing & Availability at [KyoceraPrecisionTools.com](http://KyoceraPrecisionTools.com)

DRILLS A  
END MILLS B  
ROUTERS C  
THREAD MILLS & TAPS D  
ENGRAVERS E  
BORING BARS F  
REAMERS G  
SAWS H  
TECHNICAL I  
INDEX J

# 1/8" SHANK

0.0040" - 0.0200" DIAMETER

Mirror Surface Finishes

Sub Micron Grain Carbide

MICRO DRILLS

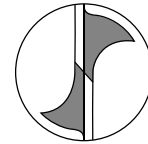
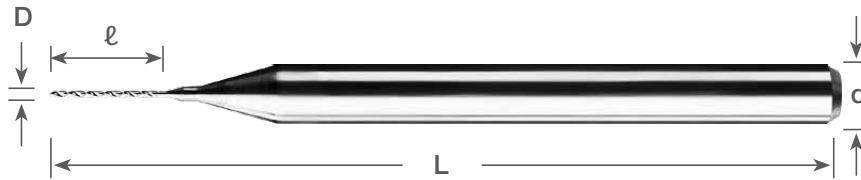

4 Facet Point Geometry



## STANDARD Flute Length

Drill Size	Dimensions (in)				Point Angle	Uncoated		AlTiN Coating	
	D <sup>+0.0000</sup> <sub>-0.0003</sub>	d	ℓ	L		Part Number	Stock	Part Number	Stock
.10mm	0.0040	1/8	0.0400	1 1/2	118°	105-0040.040	●	105-0040L040	●
.13mm	0.0050	1/8	0.0400	1 1/2	118°	105-0050.040	●	105-0050L040	●
#97	0.0059	1/8	0.0800	1 1/2	118°	105-0059.080	●	105-0059L080	●
#96	0.0063	1/8	0.0800	1 1/2	118°	105-0063.080	●	105-0063L080	●
#95	0.0067	1/8	0.0800	1 1/2	118°	105-0067.080	●	105-0067L080	●
#94	0.0071	1/8	0.1000	1 1/2	118°	105-0071.100	●	105-0071L100	●
#93	0.0075	1/8	0.1000	1 1/2	118°	105-0075.100	●	105-0075L100	●
#92	0.0079	1/8	0.1000	1 1/2	118°	105-0079.100	●	105-0079L100	●
#91	0.0083	1/8	0.1000	1 1/2	118°	105-0083.100	●	105-0083L100	●
#90	0.0087	1/8	0.1000	1 1/2	118°	105-0087.100	●	105-0087L100	●
#89	0.0091	1/8	0.1500	1 1/2	118°	105-0091.150	●	105-0091L150	●
#88	0.0095	1/8	0.1500	1 1/2	118°	105-0095.150	●	105-0095L150	●
.25mm	0.0098	1/8	0.1500	1 1/2	118°	105-0098.150	●	105-0098L150	●
#87	0.0100	1/8	0.1500	1 1/2	118°	105-0100.150	●	105-0100L150	●
#86	0.0105	1/8	0.1500	1 1/2	118°	105-0105.150	●	105-0105L150	●
#85	0.0110	1/8	0.1500	1 1/2	118°	105-0110.150	●	105-0110L150	●
#84	0.0115	1/8	0.1500	1 1/2	118°	105-0115.150	●	105-0115L150	●
.30mm	0.0118	1/8	0.2250	1 1/2	118°	105-0118.225	●	105-0118L225	●
#83	0.0120	1/8	0.2250	1 1/2	118°	105-0120.225	●	105-0120L225	●
#82	0.0125	1/8	0.2250	1 1/2	118°	105-0125.225	●	105-0125L225	●
#81	0.0130	1/8	0.2250	1 1/2	118°	105-0130.225	●	105-0130L225	●
#80	0.0135	1/8	0.2250	1 1/2	130°	105-0135.225	●	105-0135L225	●
.35mm	0.0138	1/8	0.2250	1 1/2	130°	105-0138.225	●	105-0138L225	●
#79	0.0145	1/8	0.2250	1 1/2	130°	105-0145.225	●	105-0145L225	●
1/64"	0.0156	1/8	0.2500	1 1/2	130°	105-0156.250	●	105-0156L250	●
.40mm	0.0157	1/8	0.2500	1 1/2	130°	105-0157.250	●	105-0157L250	●
#78	0.0160	1/8	0.2500	1 1/2	130°	105-0160.250	●	105-0160L250	●
.45mm	0.0177	1/8	0.2500	1 1/2	130°	105-0177.250	●	105-0177L250	●
#77	0.0180	1/8	0.2500	1 1/2	130°	105-0180.250	●	105-0180L250	●
.50mm	0.0197	1/8	0.2600	1 1/2	130°	105-0197.260	●	105-0197L260	●
#76	0.0200	1/8	0.2600	1 1/2	130°	105-0200.260	●	105-0200L260	●

### SERIES 105 WORKPIECE MATERIAL

Coating	P Steel -30HRC	P Steel 30-40HRC	H Hardened Steel ~55HRC	H Hardened Steel ~68HRC	M Stainless Steel	K Cast Iron	N Aluminum	N Graphite	N Copper Alloy	N CFRP	N Plastic	N Thermoset Plastic	N High Density Plastic	S Nickel / Cobalt	S Titanium Alloy
AlTiN	★	★	★	★	★	☆	☆	☆	☆	☆	☆	☆	☆	☆	☆
Uncoated							☆	☆	★	☆	★	★			☆

★ : Priority ☆ : Applicable Materials

Symbol Descriptions [Page vii](#)



# 1/8" SHANK

MICRO DRILLS

0.0210" - 0.0430" DIAMETER

Mirror Surface Finishes  
Sub Micron Grain Carbide

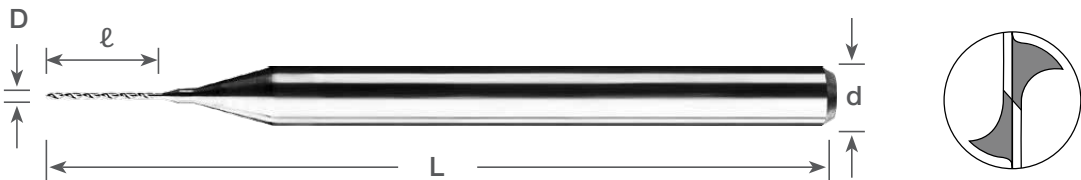

4 Facet Point Geometry



## STANDARD Flute Length

Drill Size	Dimensions (in)				Point Angle	Uncoated		AlTiN Coating	
	D <sup>+0.0000</sup> <sub>-0.0003</sub>	d	ℓ	L		Part Number	Stock	Part Number	Stock
#75	0.0210	1/8	0.3100	1 1/2	130°	105-0210.310	●	105-0210L310	●
.55mm	0.0217	1/8	0.3400	1 1/2	130°	105-0217.340	●	105-0217L340	●
#74	0.0225	1/8	0.3400	1 1/2	130°	105-0225.340	●	105-0225L340	●
.60mm	0.0236	1/8	0.3400	1 1/2	130°	105-0236.340	●	105-0236L340	●
#73	0.0240	1/8	0.3400	1 1/2	130°	105-0240.340	●	105-0240L340	●
#72	0.0250	1/8	0.3400	1 1/2	130°	105-0250.340	●	105-0250L340	●
.65mm	0.0256	1/8	0.3400	1 1/2	130°	105-0256.340	●	105-0256L340	●
#71	0.0260	1/8	0.3400	1 1/2	130°	105-0260.340	●	105-0260L340	●
.70mm	0.0276	1/8	0.4000	1 1/2	130°	105-0276.400	●	105-0276L400	●
#70	0.0280	1/8	0.4000	1 1/2	130°	105-0280.400	●	105-0280L400	●
#69	0.0292	1/8	0.4000	1 1/2	130°	105-0292.400	●	105-0292L400	●
.75mm	0.0295	1/8	0.4000	1 1/2	130°	105-0295.400	●	105-0295L400	●
#68	0.0310	1/8	0.4000	1 1/2	130°	105-0310.400	●	105-0310L400	●
1/32"	0.0312	1/8	0.4000	1 1/2	130°	105-0312.400	●	105-0312L400	●
.80mm	0.0315	1/8	0.4000	1 1/2	130°	105-0315.400	●	105-0315L400	●
#67	0.0320	1/8	0.4000	1 1/2	130°	105-0320.400	●	105-0320L400	●
#66	0.0330	1/8	0.4000	1 1/2	130°	105-0330.400	●	105-0330L400	●
.85mm	0.0335	1/8	0.4000	1 1/2	130°	105-0335.400	●	105-0335L400	●
#65	0.0350	1/8	0.4000	1 1/2	130°	105-0350.400	●	105-0350L400	●
.90mm	0.0354	1/8	0.4000	1 1/2	130°	105-0354.400	●	105-0354L400	●
#64	0.0360	1/8	0.4000	1 1/2	130°	105-0360.400	●	105-0360L400	●
#63	0.0370	1/8	0.4000	1 1/2	130°	105-0370.400	●	105-0370L400	●
.95mm	0.0374	1/8	0.4000	1 1/2	130°	105-0374.400	●	105-0374L400	●
#62	0.0380	1/8	0.4000	1 1/2	130°	105-0380.400	●	105-0380L400	●
#61	0.0390	1/8	0.4000	1 1/2	130°	105-0390.400	●	105-0390L400	●
1.00mm	0.0394	1/8	0.4000	1 1/2	130°	105-0394.400	●	105-0394L400	●
#60	0.0400	1/8	0.4000	1 1/2	130°	105-0400.400	●	105-0400L400	●
#59	0.0410	1/8	0.4000	1 1/2	130°	105-0410.400	●	105-0410L400	●
1.05mm	0.0413	1/8	0.4000	1 1/2	130°	105-0413.400	●	105-0413L400	●
#58	0.0420	1/8	0.4000	1 1/2	130°	105-0420.400	●	105-0420L400	●
#57	0.0430	1/8	0.4000	1 1/2	130°	105-0430.400	●	105-0430L400	●

SERIES 105 WORKPIECE MATERIAL															
Coating	P	P	H	H	M	K	N	N	N	N	N	N	N	S	S
	Steel -30HRC	Steel 30-40HRC	Hardened Steel -55HRC	Hardened Steel -68HRC	Stainless Steel	Cast Iron	Aluminum	Graphite	Copper Alloy	CFRP	Plastic	Thermoset Plastic	High Density Plastic	Nickel / Cobalt	Titanium Alloy
AlTiN	★	★	★	★	★	☆	☆	☆	☆	☆	☆	☆	☆	☆	☆
Uncoated							☆	☆	★	☆	★	★			☆

★ : Priority ☆ : Applicable Materials

Symbol Descriptions Page vii

● : U.S. Stock Standard  
■ : NOT STOCKED - Call for Delivery

(U.S.) 1.888.848.8449  
(International) 001.714.428.3636  
Pricing & Availability at [KyoceraPrecisionTools.com](http://KyoceraPrecisionTools.com)

DRILLS A  
END MILLS B  
ROUTERS C  
THREAD MILLS & TAPS D  
ENGRAVINGERS E  
BORING BARS F  
REAMERS G  
SAWS H  
TECHNICAL I  
INDEX J

# 1/8" SHANK

0.0433" - 0.0768" DIAMETER

Mirror Surface Finishes

Sub Micron Grain Carbide

MICRO DRILLS

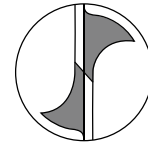
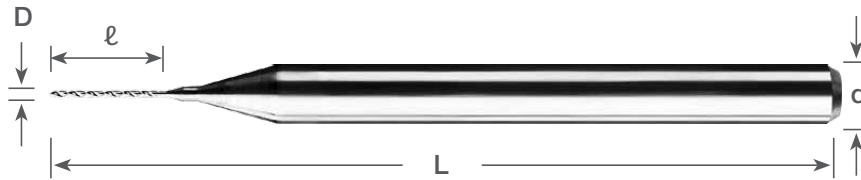

4 Facet Point Geometry



## STANDARD Flute Length

Drill Size	Dimensions (in)				Point Angle	Uncoated		AlTiN Coating	
	D <sup>+0.0000</sup> <sub>-0.0003</sub>	d	ℓ	L		Part Number	Stock	Part Number	Stock
1.10mm	0.0433	1/8	0.4000	1 1/2	130°	105-0433.400	●	105-0433L400	●
1.12mm	0.0440	1/8	0.4000	1 1/2	130°	105-0440.400	●	105-0440L400	●
1.15mm	0.0453	1/8	0.4000	1 1/2	130°	105-0453.400	●	105-0453L400	●
#56	0.0465	1/8	0.4000	1 1/2	130°	105-0465.400	●	105-0465L400	●
3/64"	0.0469	1/8	0.4000	1 1/2	130°	105-0469.400	●	105-0469L400	●
1.20mm	0.0472	1/8	0.4000	1 1/2	130°	105-0472.400	●	105-0472L400	●
1.25mm	0.0492	1/8	0.4000	1 1/2	130°	105-0492.400	●	105-0492L400	●
1.30mm	0.0512	1/8	0.4000	1 1/2	130°	105-0512.400	●	105-0512L400	●
#55	0.0520	1/8	0.4000	1 1/2	130°	105-0520.400	●	105-0520L400	●
1.35mm	0.0531	1/8	0.4000	1 1/2	130°	105-0531.400	●	105-0531L400	●
#54	0.0550	1/8	0.4000	1 1/2	130°	105-0550.400	●	105-0550L400	●
1.40mm	0.0551	1/8	0.4000	1 1/2	130°	105-0551.400	●	105-0551L400	●
1.45mm	0.0571	1/8	0.4000	1 1/2	130°	105-0571.400	●	105-0571L400	●
1.50mm	0.0591	1/8	0.4000	1 1/2	130°	105-0591.400	●	105-0591L400	●
#53	0.0595	1/8	0.4000	1 1/2	130°	105-0595.400	●	105-0595L400	●
1.55mm	0.0610	1/8	0.4000	1 1/2	130°	105-0610.400	●	105-0610L400	●
1/16"	0.0625	1/8	0.4000	1 1/2	130°	105-0625.400	●	105-0625L400	●
1.60mm	0.0630	1/8	0.4000	1 1/2	130°	105-0630.400	●	105-0630L400	●
#52	0.0635	1/8	0.4000	1 1/2	130°	105-0635.400	●	105-0635L400	●
1.65mm	0.0650	1/8	0.4000	1 1/2	130°	105-0650.400	●	105-0650L400	●
1.70mm	0.0669	1/8	0.4000	1 1/2	130°	105-0669.400	●	105-0669L400	●
#51	0.0670	1/8	0.4000	1 1/2	130°	105-0670.400	●	105-0670L400	●
1.75mm	0.0689	1/8	0.4000	1 1/2	130°	105-0689.400	●	105-0689L400	●
#50	0.0700	1/8	0.4000	1 1/2	130°	105-0700.400	●	105-0700L400	●
1.80mm	0.0709	1/8	0.4000	1 1/2	130°	105-0709.400	●	105-0709L400	●
1.85mm	0.0728	1/8	0.4000	1 1/2	130°	105-0728.400	●	105-0728L400	●
#49	0.0730	1/8	0.4000	1 1/2	130°	105-0730.400	●	105-0730L400	●
1.90mm	0.0748	1/8	0.4000	1 1/2	130°	105-0748.400	●	105-0748L400	●
#48	0.0760	1/8	0.4000	1 1/2	130°	105-0760.400	●	105-0760L400	●
1.95mm	0.0768	1/8	0.4000	1 1/2	130°	105-0768.400	●	105-0768L400	●

### SERIES 105 WORKPIECE MATERIAL

Coating	P Steel ~30HRC	P Steel 30-40HRC	H Hardened Steel ~55HRC	H Hardened Steel ~68HRC	M Stainless Steel	K Cast Iron	N Aluminum	N Graphite	N Copper Alloy	N CFRP	N Plastic	N Thermoset Plastic	N High Density Plastic	S Nickel / Cobalt	S Titanium Alloy
AlTiN	★	★	★	★	★	☆	☆	☆	☆	☆	☆	☆	☆	☆	☆
Uncoated							☆	☆	★	☆	★	★			☆

★ : Priority ☆ : Applicable Materials

Symbol Descriptions Page vii

# 1/8" SHANK

MICRO DRILLS

0.0781" - 0.1083" DIAMETER

Mirror Surface Finishes  
Sub Micron Grain Carbide

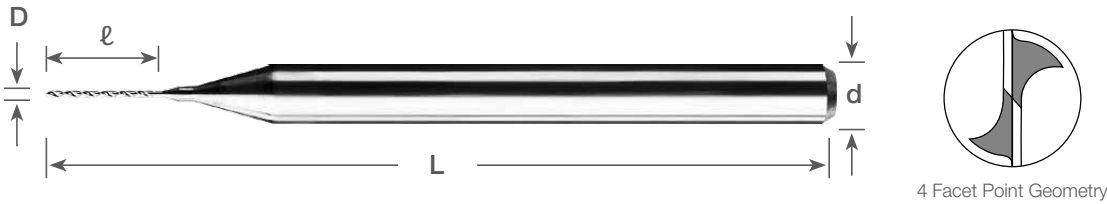

4 Facet Point Geometry



## STANDARD Flute Length

Drill Size	Dimensions (in)				Point Angle	Uncoated		AlTiN Coating	
	D <sup>+0.0000</sup> <sub>-0.0003</sub>	d	ℓ	L		Part Number	Stock	Part Number	Stock
5/64"	0.0781	1/8	0.4000	1 1/2	130°	105-0781.400	●	105-0781L400	●
#47	0.0785	1/8	0.4000	1 1/2	130°	105-0785.400	●	105-0785L400	●
2.00mm	0.0787	1/8	0.4000	1 1/2	130°	105-0787.400	●	105-0787L400	●
2.05mm	0.0807	1/8	0.4000	1 1/2	130°	105-0807.400	●	105-0807L400	●
#46	0.0810	1/8	0.4000	1 1/2	130°	105-0810.400	●	105-0810L400	●
#45	0.0820	1/8	0.4000	1 1/2	130°	105-0820.400	●	105-0820L400	●
2.10mm	0.0827	1/8	0.4000	1 1/2	130°	105-0827.400	●	105-0827L400	●
2.15mm	0.0846	1/8	0.4000	1 1/2	130°	105-0846.400	●	105-0846L400	●
#44	0.0860	1/8	0.4000	1 1/2	130°	105-0860.400	●	105-0860L400	●
2.20mm	0.0866	1/8	0.4000	1 1/2	130°	105-0866.400	●	105-0866L400	●
2.25mm	0.0886	1/8	0.4000	1 1/2	130°	105-0886.400	●	105-0886L400	●
#43	0.0890	1/8	0.4000	1 1/2	130°	105-0890.400	●	105-0890L400	●
2.30mm	0.0906	1/8	0.4000	1 1/2	130°	105-0906.400	●	105-0906L400	●
2.35mm	0.0925	1/8	0.4000	1 1/2	130°	105-0925.400	●	105-0925L400	●
#42	0.0935	1/8	0.4000	1 1/2	130°	105-0935.400	●	105-0935L400	●
3/32"	0.0938	1/8	0.4000	1 1/2	130°	105-0938.400	●	105-0938L400	●
2.40mm	0.0945	1/8	0.4000	1 1/2	130°	105-0945.400	●	105-0945L400	●
#41	0.0960	1/8	0.4000	1 1/2	130°	105-0960.400	●	105-0960L400	●
2.45mm	0.0965	1/8	0.4000	1 1/2	130°	105-0965.400	●	105-0965L400	●
#40	0.0980	1/8	0.4000	1 1/2	130°	105-0980.400	●	105-0980L400	●
2.50mm	0.0984	1/8	0.4000	1 1/2	130°	105-0984.400	●	105-0984L400	●
#39	0.0995	1/8	0.4000	1 1/2	130°	105-0995.400	●	105-0995L400	●
2.55mm	0.1004	1/8	0.4000	1 1/2	130°	105-1004.400	●	105-1004L400	●
#38	0.1015	1/8	0.4000	1 1/2	130°	105-1015.400	●	105-1015L400	●
2.60mm	0.1024	1/8	0.4000	1 1/2	130°	105-1024.400	●	105-1024L400	●
#37	0.1040	1/8	0.4000	1 1/2	130°	105-1040.400	●	105-1040L400	●
2.65mm	0.1043	1/8	0.4000	1 1/2	130°	105-1043.400	●	105-1043L400	●
2.70mm	0.1063	1/8	0.4000	1 1/2	130°	105-1063.400	●	105-1063L400	●
#36	0.1065	1/8	0.4000	1 1/2	130°	105-1065.400	●	105-1065L400	●
2.75mm	0.1083	1/8	0.4000	1 1/2	130°	105-1083.400	●	105-1083L400	●

SERIES 105 WORKPIECE MATERIAL															
Coating	P	P	H	H	M	K	N	N	N	N	N	N	N	S	S
	Steel ~30HRC	Steel 30~40HRC	Hardened Steel ~55HRC	Hardened Steel ~68HRC	Stainless Steel	Cast Iron	Aluminum	Graphite	Copper Alloy	CFRP	Plastic	Thermoset Plastic	High Density Plastic	Nickel / Cobalt	Titanium Alloy
AlTiN	★	★	★	★	★	☆	☆	☆	☆	☆	☆	☆	☆	☆	☆
Uncoated							☆	☆	★	☆	★	★			☆

★ : Priority ☆ : Applicable Materials

Symbol Descriptions Page vii

● : U.S. Stock Standard  
■ : NOT STOCKED - Call for Delivery

(U.S.) 1.888.848.8449  
(International) 001.714.428.3636  
Pricing & Availability at [KyoceraPrecisionTools.com](http://KyoceraPrecisionTools.com)

DRILLS A

END MILLS B

ROUTERS C

THREAD MILLS & TAPS D

ENGRAVERS E

BORING BARS F

REAMERS G

SAWS H

TECHNICAL I

INDEX J

# 1/8" SHANK

0.1094" - 0.1250" DIAMETER

Mirror Surface Finishes

Sub Micron Grain Carbide

MICRO DRILLS

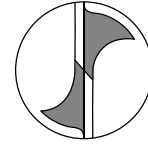
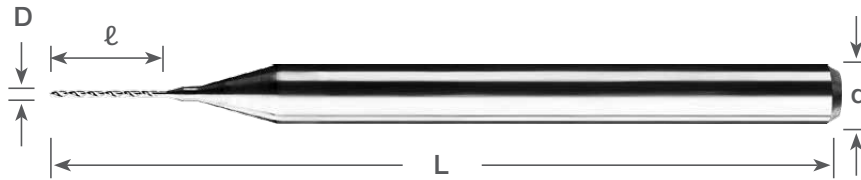

4 Facet Point Geometry



## STANDARD Flute Length

Drill Size	Dimensions (in)				Point Angle	Uncoated		AlTiN Coating	
	D <sup>+0.0000</sup> <sub>-0.0003</sub>	d	ℓ	L		Part Number	Stock	Part Number	Stock
7/64"	0.1094	1/8	0.4000	1 1/2	130°	105-1094.400	●	105-1094L400	●
#35	0.1100	1/8	0.4000	1 1/2	130°	105-1100.400	●	105-1100L400	●
2.80mm	0.1102	1/8	0.4000	1 1/2	130°	105-1102.400	●	105-1102L400	●
#34	0.1110	1/8	0.4000	1 1/2	130°	105-1110.400	●	105-1110L400	●
2.85mm	0.1122	1/8	0.4000	1 1/2	130°	105-1122.400	●	105-1122L400	●
#33	0.1130	1/8	0.4000	1 1/2	130°	105-1130.400	●	105-1130L400	●
2.90mm	0.1142	1/8	0.4000	1 1/2	130°	105-1142.400	●	105-1142L400	●
#32	0.1160	1/8	0.4000	1 1/2	130°	105-1160.400	●	105-1160L400	●
2.95mm	0.1161	1/8	0.4000	1 1/2	130°	105-1161.400	●	105-1161L400	●
3.00mm	0.1181	1/8	0.4000	1 1/2	130°	105-1181.400	●	105-1181L400	●
#31	0.1200	1/8	0.4000	1 1/2	130°	105-1200.400	●	105-1200L400	●
3.05mm	0.1201	1/8	0.4000	1 1/2	130°	105-1201.400	●	105-1201L400	●
3.10mm	0.1220	1/8	0.4000	1 1/2	130°	105-1220.400	●	105-1220L400	●
3.15mm	0.1240	1/8	0.4000	1 1/2	130°	105-1240.400	●	105-1240L400	●
1/8"	0.1250	1/8	0.4000	1 1/2	130°	105-1250.400	●	105-1250L400	●

SERIES 105 WORKPIECE MATERIAL															
Coating	P Steel ~30HRC	P Steel 30-40HRC	H Hardened Steel ~55HRC	H Hardened Steel ~68HRC	M Stainless Steel	K Cast Iron	N Aluminum	N Graphite	N Copper Alloy	N CFRP	N Plastic	N Thermoset Plastic	N High Density Plastic	S Nickel / Cobalt	S Titanium Alloy
AlTiN	★	★	★	★	★	☆	☆	☆	☆	☆	☆	☆	☆	☆	☆
Uncoated							☆	☆	★	☆	★	★			☆

★ : Priority ☆ : Applicable Materials

Symbol Descriptions Page vii

# 1/8" SHANK

MICRO DRILLS

0.0040" - 0.0200" DIAMETER

Mirror Surface Finishes  
Sub Micron Grain Carbide

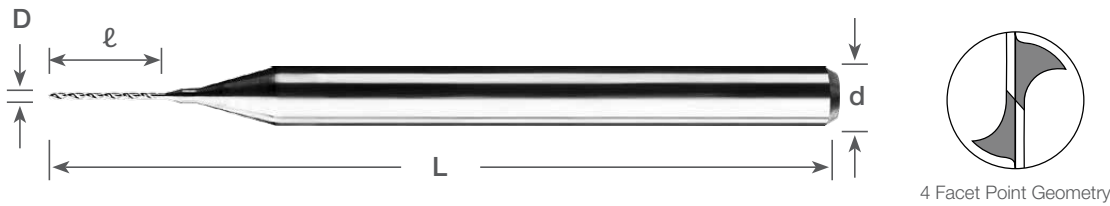

4 Facet Point Geometry



## EXTENDED Flute Length

Drill Size	Dimensions (in)				Point Angle	Uncoated		AlTiN Coating	
	D <sup>+0.0000</sup> <sub>-0.0003</sub>	d	ℓ	L		Part Number	Stock	Part Number	Stock
.10mm	0.0040	1/8	0.0700	1 1/2	118°	105-0040.070	●	105-0040L070	●
.13mm	0.0050	1/8	0.0700	1 1/2	118°	105-0050.070	●	105-0050L070	●
#97	0.0059	1/8	0.1200	1 1/2	118°	105-0059.120	●	105-0059L120	●
#96	0.0063	1/8	0.1200	1 1/2	118°	105-0063.120	●	105-0063L120	●
#95	0.0067	1/8	0.1200	1 1/2	118°	105-0067.120	●	105-0067L120	●
#94	0.0071	1/8	0.1500	1 1/2	118°	105-0071.150	●	105-0071L150	●
#93	0.0075	1/8	0.1500	1 1/2	118°	105-0075.150	●	105-0075L150	●
#92	0.0079	1/8	0.1500	1 1/2	118°	105-0079.150	●	105-0079L150	●
#91	0.0083	1/8	0.1500	1 1/2	118°	105-0083.150	●	105-0083L150	●
#90	0.0087	1/8	0.1500	1 1/2	118°	105-0087.150	●	105-0087L150	●
#89	0.0091	1/8	0.2200	1 1/2	118°	105-0091.220	●	105-0091L220	●
#88	0.0095	1/8	0.2200	1 1/2	118°	105-0095.220	●	105-0095L220	●
.25mm	0.0098	1/8	0.2200	1 1/2	118°	105-0098.220	●	105-0098L220	●
#87	0.0100	1/8	0.2200	1 1/2	118°	105-0100.220	●	105-0100L220	●
#86	0.0105	1/8	0.2200	1 1/2	118°	105-0105.220	●	105-0105L220	●
#85	0.0110	1/8	0.2200	1 1/2	118°	105-0110.220	●	105-0110L220	●
#84	0.0115	1/8	0.2200	1 1/2	118°	105-0115.220	●	105-0115L220	●
.30mm	0.0118	1/8	0.2800	1 1/2	118°	105-0118.280	●	105-0118L280	●
#83	0.0120	1/8	0.2800	1 1/2	118°	105-0120.280	●	105-0120L280	●
#82	0.0125	1/8	0.2800	1 1/2	118°	105-0125.280	●	105-0125L280	●
#81	0.0130	1/8	0.2800	1 1/2	118°	105-0130.280	●	105-0130L280	●
#80	0.0135	1/8	0.2800	1 1/2	130°	105-0135.280	●	105-0135L280	●
.35mm	0.0138	1/8	0.2800	1 1/2	130°	105-0138.280	●	105-0138L280	●
#79	0.0145	1/8	0.2800	1 1/2	130°	105-0145.280	●	105-0145L280	●
1/64"	0.0156	1/8	0.2950	1 1/2	130°	105-0156.295	●	105-0156L295	●
.40mm	0.0157	1/8	0.2950	1 1/2	130°	105-0157.295	●	105-0157L295	●
#78	0.0160	1/8	0.2950	1 1/2	130°	105-0160.295	●	105-0160L295	●
.45mm	0.0177	1/8	0.2950	1 1/2	130°	105-0177.295	●	105-0177L295	●
#77	0.0180	1/8	0.2950	1 1/2	130°	105-0180.295	●	105-0180L295	●
.50mm	0.0197	1/8	0.3100	1 1/2	130°	105-0197.310	●	105-0197L310	●
#76	0.0200	1/8	0.3100	1 1/2	130°	105-0200.310	●	105-0200L310	●

### SERIES 105 WORKPIECE MATERIAL

Coating	P Steel -30HRC	P Steel 30-40HRC	H Hardened Steel -55HRC	H Hardened Steel -68HRC	M Stainless Steel	K Cast Iron	N Aluminum	N Graphite	N Copper Alloy	N CFRP	N Plastic	N Thermoset Plastic	N High Density Plastic	S Nickel / Cobalt	S Titanium Alloy
AlTiN	★	★	★	★	★	☆	☆	☆	☆	☆	☆	☆	☆	☆	☆
Uncoated							☆	☆	★	☆	★	★			☆

★ : Priority ☆ : Applicable Materials

Symbol Descriptions Page vii

● : U.S. Stock Standard  
■ : NOT STOCKED - Call for Delivery

DRILLS A  
END MILLS B  
ROUTERS C  
THREAD MILLS & TAPS D  
ENGRAVERS E  
BORING BARS F  
REAMERS G  
SAWS H  
TECHNICAL I  
INDEX J

# 1/8" SHANK

0.1260" - 0.1594" DIAMETER

Mirror Surface Finishes  
Sub Micron Grain Carbide

INVERSE DIAMETER MICRO DRILLS



## STANDARD Flute Length

Drill Size	Dimensions (in)				Point Angle	Uncoated	
	D <sup>+0.0000</sup> <sub>-0.0003</sub>	d	ℓ	L		Part Number	Stock
3.20mm	0.1260	1/8	0.5000	1 1/2	130°	155-1260.500	●
3.25mm	0.1280	1/8	0.5000	1 1/2	130°	155-1280.500	●
#30	0.1285	1/8	0.5000	1 1/2	130°	155-1285.500	●
3.30mm	0.1299	1/8	0.5000	1 1/2	130°	155-1299.500	●
3.35mm	0.1319	1/8	0.5000	1 1/2	130°	155-1319.500	●
3.40mm	0.1339	1/8	0.5000	1 1/2	130°	155-1339.500	●
3.45mm	0.1358	1/8	0.5000	1 1/2	130°	155-1358.500	●
#29	0.1360	1/8	0.5000	1 1/2	130°	155-1360.500	●
3.50mm	0.1378	1/8	0.5000	1 1/2	130°	155-1378.500	●
3.55mm	0.1398	1/8	0.5000	1 1/2	130°	155-1398.500	●
#28	0.1405	1/8	0.5000	1 1/2	130°	155-1405.500	●
9/64"	0.1406	1/8	0.5000	1 1/2	130°	155-1406.500	●
3.60mm	0.1417	1/8	0.5000	1 1/2	130°	155-1417.500	●
3.65mm	0.1437	1/8	0.5000	1 1/2	130°	155-1437.500	●
#27	0.1440	1/8	0.5000	1 1/2	130°	155-1440.500	●
3.70mm	0.1457	1/8	0.5000	1 1/2	130°	155-1457.500	●
#26	0.1470	1/8	0.5000	1 1/2	130°	155-1470.500	●
3.75mm	0.1476	1/8	0.5000	1 1/2	130°	155-1476.500	●
#25	0.1495	1/8	0.5000	1 1/2	130°	155-1495.500	●
3.80mm	0.1496	1/8	0.5000	1 1/2	130°	155-1496.500	●
3.85mm	0.1516	1/8	0.5000	1 1/2	130°	155-1516.500	●
#24	0.1520	1/8	0.5000	1 1/2	130°	155-1520.500	●
3.90mm	0.1535	1/8	0.5000	1 1/2	130°	155-1535.500	●
#23	0.1540	1/8	0.5000	1 1/2	130°	155-1540.500	●
3.95mm	0.1555	1/8	0.5000	1 1/2	130°	155-1555.500	●
5/32"	0.1562	1/8	0.5000	1 1/2	130°	155-1562.500	●
#22	0.1570	1/8	0.5000	1 1/2	130°	155-1570.500	●
4.00mm	0.1575	1/8	0.5000	1 1/2	130°	155-1575.500	●
#21	0.1590	1/8	0.5000	1 1/2	130°	155-1590.500	●
4.05mm	0.1594	1/8	0.5000	1 1/2	130°	155-1594.500	●

SERIES 155 WORKPIECE MATERIAL															
Coating	P	P	H	H	M	K	N	N	N	N	N	S	S		
	Steel ~30HRC	Steel 30~40HRC	Hardened Steel ~55HRC	Hardened Steel ~68HRC	Stainless Steel	Cast Iron	Aluminum	Graphite	Copper Alloy	CFRP	Plastic	Thermoset Plastic	High Density Plastic	Nickel / Cobalt	Titanium Alloy
Uncoated							☆	☆	★	☆	★	★	★		☆

★ : Priority ☆ : Applicable Materials

Symbol Descriptions Page vii



# 1/8" SHANK

INVERSE DIAMETER MICRO DRILLS

0.1610" - 0.1949" DIAMETER

Mirror Surface Finishes  
Sub Micron Grain Carbide



## STANDARD Flute Length

Drill Size	Dimensions (in)				Point Angle	Uncoated	
	D <sup>+0.0000</sup> <sub>-0.0003</sub>	d	ℓ	L		Part Number	Stock
#20	0.1610	1/8	0.5000	1 1/2	130°	155-1610.500	●
4.10mm	0.1614	1/8	0.5000	1 1/2	130°	155-1614.500	●
4.15mm	0.1634	1/8	0.5000	1 1/2	130°	155-1634.500	●
4.20mm	0.1654	1/8	0.5000	1 1/2	130°	155-1654.500	●
#19	0.1660	1/8	0.5000	1 1/2	130°	155-1660.500	●
4.25mm	0.1673	1/8	0.5000	1 1/2	130°	155-1673.500	●
4.30mm	0.1693	1/8	0.5000	1 1/2	130°	155-1693.500	●
#18	0.1695	1/8	0.5000	1 1/2	130°	155-1695.500	●
4.35mm	0.1713	1/8	0.5000	1 1/2	130°	155-1713.500	●
11/64"	0.1719	1/8	0.5000	1 1/2	130°	155-1719.500	●
#17	0.1730	1/8	0.5000	1 1/2	130°	155-1730.500	●
4.40mm	0.1732	1/8	0.5000	1 1/2	130°	155-1732.500	●
4.45mm	0.1752	1/8	0.5000	1 1/2	130°	155-1752.500	●
#16	0.1770	1/8	0.5000	1 1/2	130°	155-1770.500	●
4.50mm	0.1772	1/8	0.5000	1 1/2	130°	155-1772.500	●
4.55mm	0.1791	1/8	0.5000	1 1/2	130°	155-1791.500	●
#15	0.1800	1/8	0.5000	1 1/2	130°	155-1800.500	●
4.60mm	0.1811	1/8	0.5000	1 1/2	130°	155-1811.500	●
#14	0.1820	1/8	0.5000	1 1/2	130°	155-1820.500	●
4.65mm	0.1831	1/8	0.5000	1 1/2	130°	155-1831.500	●
#13	0.1850	1/8	0.5000	1 1/2	130°	155-1850.500	●
4.70mm	0.1850	1/8	0.5000	1 1/2	130°	155-1850.500	●
4.75mm	0.1870	1/8	0.5000	1 1/2	130°	155-1870.500	●
3/16"	0.1875	1/8	0.5000	1 1/2	130°	155-1875.500	●
#12	0.1890	1/8	0.5000	1 1/2	130°	155-1890.500	●
4.80mm	0.1890	1/8	0.5000	1 1/2	130°	155-1890.500	●
4.85mm	0.1909	1/8	0.5000	1 1/2	130°	155-1909.500	●
#11	0.1910	1/8	0.5000	1 1/2	130°	155-1910.500	●
4.90mm	0.1929	1/8	0.5000	1 1/2	130°	155-1929.500	●
#10	0.1935	1/8	0.5000	1 1/2	130°	155-1935.500	●
4.95mm	0.1949	1/8	0.5000	1 1/2	130°	155-1949.500	●

SERIES 155 WORKPIECE MATERIAL															
Coating	P	P	H	H	M	K	N	N	N	N	N	S	S		
	Steel ~30HRC	Steel 30~40HRC	Hardened Steel ~55HRC	Hardened Steel ~68HRC	Stainless Steel	Cast Iron	Aluminum	Graphite	Copper Alloy	CFRP	Plastic	Thermoset Plastic	High Density Plastic	Nickel / Cobalt	Titanium Alloy
Uncoated							☆	☆	★	☆	★	★	★		☆

★ : Priority ☆ : Applicable Materials

Symbol Descriptions Page vii

● : U.S. Stock Standard  
■ : NOT STOCKED - Call for Delivery

(U.S.) 1.888.848.8449  
(International) 001.714.428.3636  
Pricing & Availability at [KyoceraPrecisionTools.com](http://KyoceraPrecisionTools.com)

DRILLS A  
END MILLS B  
ROUTERS C  
THREAD MILLS & TAPS D  
ENGRAVERS E  
BORING BARS F  
REAMERS G  
SAWS H  
TECHNICAL I  
INDEX J

# 1/8" SHANK

0.1960" - 0.2323" DIAMETER

Mirror Surface Finishes

Sub Micron Grain Carbide

INVERSE DIAMETER MICRO DRILLS



## STANDARD Flute Length

Drill Size	Dimensions (in)				Point Angle	Uncoated	
	D <sup>+0.0000</sup> <sub>-0.0003</sub>	d	ℓ	L		Part Number	Stock
#9	0.1960	1/8	0.5000	1 1/2	130°	155-1960.500	●
5.00mm	0.1968	1/8	0.5000	1 1/2	130°	155-1968.500	●
5.05mm	0.1988	1/8	0.5000	1 1/2	130°	155-1988.500	●
#8	0.1990	1/8	0.5000	1 1/2	130°	155-1990.500	●
5.10mm	0.2008	1/8	0.5000	1 1/2	130°	155-2008.500	●
#7	0.2010	1/8	0.5000	1 1/2	130°	155-2010.500	●
5.15mm	0.2028	1/8	0.5000	1 1/2	130°	155-2028.500	●
13/64"	0.2031	1/8	0.5000	1 1/2	130°	155-2031.500	●
#6	0.2040	1/8	0.5000	1 1/2	130°	155-2040.500	●
5.20mm	0.2047	1/8	0.5000	1 1/2	130°	155-2047.500	●
#5	0.2055	1/8	0.5000	1 1/2	130°	155-2055.500	●
5.25mm	0.2067	1/8	0.5000	1 1/2	130°	155-2067.500	●
5.30mm	0.2087	1/8	0.5000	1 1/2	130°	155-2087.500	●
#4	0.2090	1/8	0.5000	1 1/2	130°	155-2090.500	●
5.35mm	0.2106	1/8	0.5000	1 1/2	130°	155-2106.500	●
5.40mm	0.2126	1/8	0.5000	1 1/2	130°	155-2126.500	●
#3	0.2130	1/8	0.5000	1 1/2	130°	155-2130.500	●
5.45mm	0.2146	1/8	0.5000	1 1/2	130°	155-2146.500	●
5.50mm	0.2165	1/8	0.5000	1 1/2	130°	155-2165.500	●
5.50mm	0.2185	1/8	0.5000	1 1/2	130°	155-2185.500	●
7/32"	0.2188	1/8	0.5000	1 1/2	130°	155-2188.500	●
5.60mm	0.2205	1/8	0.5000	1 1/2	130°	155-2205.500	●
#2	0.2210	1/8	0.5000	1 1/2	130°	155-2210.500	●
5.65mm	0.2224	1/8	0.5000	1 1/2	130°	155-2224.500	●
5.70mm	0.2244	1/8	0.5000	1 1/2	130°	155-2244.500	●
5.75mm	0.2264	1/8	0.5000	1 1/2	130°	155-2264.500	●
#1	0.2280	1/8	0.5000	1 1/2	130°	155-2280.500	●
5.80mm	0.2283	1/8	0.5000	1 1/2	130°	155-2283.500	●
5.85mm	0.2302	1/8	0.5000	1 1/2	130°	155-2302.500	●
5.90mm	0.2323	1/8	0.5000	1 1/2	130°	155-2323.500	●

SERIES 155 WORKPIECE MATERIAL															
Coating	P	P	H	H	M	K	N	N	N	N	N	S	S		
	Steel ~30HRC	Steel 30-40HRC	Hardened Steel ~55HRC	Hardened Steel ~68HRC	Stainless Steel	Cast Iron	Aluminum	Graphite	Copper Alloy	CFRP	Plastic	Thermoset Plastic	High Density Plastic	Nickel / Cobalt	Titanium Alloy
Uncoated							☆	☆	★	☆	★	★	★		☆

★ : Priority ☆ : Applicable Materials

Symbol Descriptions Page vii

# 1/8" SHANK

INVERSE DIAMETER MICRO DRILLS

0.2340" - 0.2638" DIAMETER

Mirror Surface Finishes  
Sub Micron Grain Carbide



## STANDARD Flute Length

Drill Size	Dimensions (in)				Point Angle	Uncoated	
	$D^{+0.0000}_{-0.0003}$	$d$	$l$	$L$		Part Number	Stock
A	0.2340	1/8	0.5000	1 1/2	130°	155-2340.500	●
5.95mm	0.2343	1/8	0.5000	1 1/2	130°	155-2343.500	●
15/64"	0.2344	1/8	0.5000	1 1/2	130°	155-2344.500	●
6.00mm	0.2362	1/8	0.5000	1 1/2	130°	155-2362.500	●
B	0.2380	1/8	0.5000	1 1/2	130°	155-2380.500	●
6.05mm	0.2382	1/8	0.5000	1 1/2	130°	155-2382.500	●
6.10mm	0.2402	1/8	0.5000	1 1/2	130°	155-2402.500	●
C	0.2420	1/8	0.5000	1 1/2	130°	155-2420.500	●
6.15mm	0.2421	1/8	0.5000	1 1/2	130°	155-2421.500	●
6.20mm	0.2441	1/8	0.5000	1 1/2	130°	155-2441.500	●
D	0.2460	1/8	0.5000	1 1/2	130°	155-2460.500	●
6.25mm	0.2461	1/8	0.5000	1 1/2	130°	155-2461.500	●
6.30mm	0.2480	1/8	0.5000	1 1/2	130°	155-2480.500	●
1/4"	0.2500	1/8	0.5000	1 1/2	130°	155-2500.500	●
6.35mm	0.2500	1/8	0.5000	1 1/2	130°	155-2500.500	●
E	0.2500	1/8	0.5000	1 1/2	130°	155-2500.500	●
6.40mm	0.2520	1/8	0.5000	1 1/2	130°	155-2520.500	●
6.50mm	0.2559	1/8	0.5000	1 1/2	130°	155-2559.500	●
F	0.2570	1/8	0.5000	1 1/2	130°	155-2570.500	●
6.60mm	0.2598	1/8	0.5000	1 1/2	130°	155-2598.500	●
G	0.2610	1/8	0.5000	1 1/2	130°	155-2610.500	●
6.70mm	0.2638	1/8	0.5000	1 1/2	130°	155-2638.500	●

DRILLS A  
END MILLS B  
ROUTERS C  
THREAD MILLS & TAPS D  
ENGRAVERS E  
BORING BARS F  
REAMERS G  
SAWS H  
TECHNICAL I  
INDEX J

SERIES 155 WORKPIECE MATERIAL															
Coating	P	P	H	H	M	K	N	N	N	N	N	N	S	S	
	Steel ~30HRC	Steel 30-40HRC	Hardened Steel ~55HRC	Hardened Steel ~68HRC	Stainless Steel	Cast Iron	Aluminum	Graphite	Copper Alloy	CFRP	Plastic	Thermoset Plastic	High Density Plastic	Nickel / Cobalt	Titanium Alloy
Uncoated							☆	☆	★	☆	★	★	★		☆

★ : Priority ☆ : Applicable Materials

Symbol Descriptions Page vii

● : U.S. Stock Standard  
■ : NOT STOCKED - Call for Delivery

(U.S.) 1.888.848.8449  
(International) 001.714.428.3636  
Pricing & Availability at [KyoceraPrecisionTools.com](http://KyoceraPrecisionTools.com)

**0.1250" - 0.5000" DIAMETER**

Match with HYDROS Coolant Fed Deep Drills Product Line  
 Increased Positional Accuracy  
 Less Heat Build Up  
 Excellent Pilot Hole Drill  
 External Coolant

# ORION INCH SHANK

HIGH PERFORMANCE DRILLS

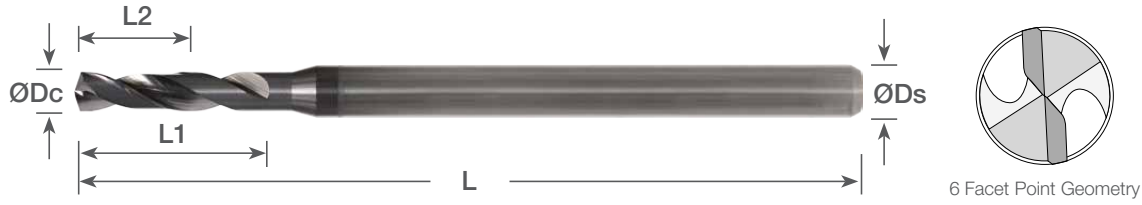

## STANDARD Flute Length



	Dimensions (in)					Point Angle	AlTiN Nano	
	ØDc	ØDs	L	L1	*L2		Part Number	Stock
	0.1250 (1/8)	0.1875	2.5	0.625	0.375	142°	160-1250AG625	●
	0.1406 (9/64)	0.1875	2.5	0.703	0.422	142°	160-1406AG703	●
	0.1563 (5/32)	0.1875	2.5	0.781	0.468	142°	160-1563AG781	●
	0.1719 (11/64)	0.1875	2.5	0.859	0.515	142°	160-1719AG859	●
	0.1875 (3/16)	0.2500	2.5	0.938	0.563	142°	160-1875AG938	●
	0.2031 (13/64)	0.2500	2.5	1.016	0.610	142°	160-2031AG1016	●
	0.2188 (7/32)	0.2500	2.5	1.094	0.656	142°	160-2188AG1094	●
	0.2344 (15/64)	0.2500	2.5	1.172	0.703	142°	160-2344AG1172	●
	0.2500 (1/4)	0.3125	3.0	1.250	0.750	142°	160-2500AG1250	●
	0.2570 (F)	0.3125	3.0	1.285	0.771	142°	160-2570AG1285	●
	0.2656 (17/64)	0.3125	3.0	1.328	0.797	142°	160-2656AG1328	●
	0.2813 (9/32)	0.3125	3.0	1.406	0.843	142°	160-2813AG1406	●
	0.3125 (5/16)	0.3750	4.0	1.563	0.938	142°	160-3125AG1563	●
	0.3320 (Q)	0.3750	4.0	1.660	0.996	142°	160-3320AG1660	●
	0.3438 (11/32)	0.3750	4.0	1.719	1.031	142°	160-3438AG1719	●
	0.3750 (3/8)	0.4375	4.5	1.875	1.125	142°	160-3750AG1875	●
	0.4219 (27/64)	0.4375	4.5	2.109	1.265	142°	160-4219AG2109	●
	0.4375 (7/16)	0.5000	5.0	2.188	1.313	142°	160-4375AG2188	●
	0.4531 (29/64)	0.5000	5.0	2.266	1.360	142°	160-4531AG2266	●
	0.5000 (1/2)	0.6250	5.0	2.500	1.500	142°	160-5000AG2500	●

\*L2 dimensions refers to the Max. length of cut (3 x ØDc).  
 There is a 2 x ØDc length at the top of the flute for chip exhaust.

Match with HYDROS Deep Hole Coolant Drills Series 860 [Page A45](#)

### Diameter Tolerance

Cutting Dia. (ØDc)	0.1250" - 0.2344"	0.2500" - 0.3750"	0.4219" - 0.5000"
Tolerance + / +	+0.00016"/+0.00063"	+0.00024"/+0.00083"	+0.00028"/+0.00098"

### Shank Tolerance

Shank Dia. (ØDs)	0.1250" - 0.2344"	0.2500" - 0.3750"	0.4219" - 0.5000"
Tolerance + / -	+0.00000"/-0.00032"	+0.00000"/-0.00035"	+0.00000"/-0.00043"

SERIES 160 WORKPIECE MATERIAL															
Coating	P	P	H	H	M	K	N	N	N	N	N	S	S		
	Steel -30HRC	Steel 30-40HRC	Hardened Steel -55HRC	Hardened Steel -68HRC	Stainless Steel	Cast Iron	Aluminum	Graphite	Copper Alloy	CFRP	Plastic	Thermoset Plastic	High Density Plastic	Nickel / Cobalt	Titanium Alloy
AlTiN Nano	★	★	★	★	★	☆	☆	☆	☆	☆	☆	☆	☆	★	★

★ : Priority ☆ : Applicable Materials

Symbol Descriptions [Page vii](#)

# ORION METRIC SHANK

HIGH PERFORMANCE DRILLS

**3.00mm - 4.10mm DIAMETER**

Match with HYDROS Coolant Fed Deep Drills Product Line

Increased Positional Accuracy

Less Heat Build Up

Excellent Pilot Hole Drill

External Coolant

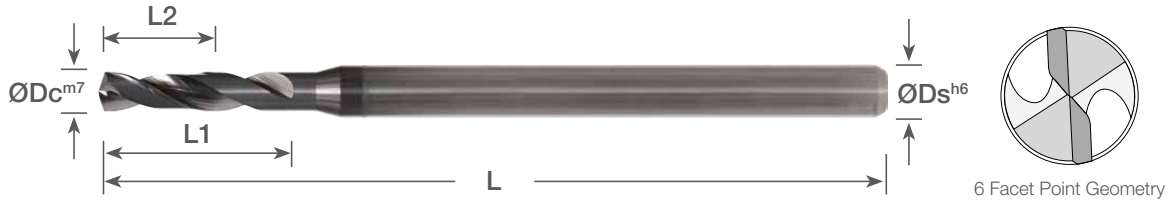

## STANDARD Flute Length

Dimensions (mm)					Point Angle	AlTiN Nano	
ØDc <sup>m7</sup>	ØDs <sup>h6</sup>	L	L1	*L2		Part Number	Stock
3.00	4	60	15.0	6.00	142°	165-1181AG591	●
3.10	4	60	15.5	6.20	142°	165-1220AG610	●
3.20	4	60	16.0	6.40	142°	165-1260AG630	●
3.30	4	60	16.5	6.60	142°	165-1299AG650	●
3.40	4	60	17.0	6.80	142°	165-1339AG669	●
3.50	4	60	17.5	7.00	142°	165-1378AG689	●
3.60	4	60	18.0	7.20	142°	165-1417AG709	●
3.70	4	60	18.5	7.40	142°	165-1457AG728	●
3.80	4	60	19.0	7.60	142°	165-1496AG748	●
3.90	4	60	19.5	7.80	142°	165-1535AG768	●
4.00	6	70	20.0	8.00	142°	165-1575AG787	●
4.10	6	70	20.5	8.20	142°	165-1614AG807	●

\*L2 dimensions refers to the Max. length of cut (3 x ØDc).  
There is a 2 x ØDc length at the top of the flute for chip exhaust.

Match with HYDROS Deep Hole Coolant Drills **Series 865** Page A46

DRILLS **A**

END MILLS **B**

ROUTERS **C**

THREAD MILLS & TAPS **D**

ENGRAVERS **E**

BORING BARS **F**

REAMERS **G**

SAWS **H**

TECHNICAL **I**

INDEX **J**

SERIES 165 WORKPIECE MATERIAL															
Coating	P	P	H	H	M	K	N	N	N	N	N	N	S	S	
	Steel ~30HRC	Steel 30-40HRC	Hardened Steel ~55HRC	Hardened Steel ~68HRC	Stainless Steel	Cast Iron	Aluminum	Graphite	Copper Alloy	CFRP	Plastic	Thermoset Plastic	High Density Plastic	Nickel / Cobalt	Titanium Alloy
AlTiN Nano	★	★	★	★	★	☆		☆	☆		☆	☆	☆	★	★

★ : Priority ☆ : Applicable Materials

Symbol Descriptions Page vii

● : U.S. Stock Standard  
■ : NOT STOCKED - Call for Delivery

(U.S.) 1.888.848.8449  
(International) 001.714.428.3636  
Pricing & Availability at [KyoceraPrecisionTools.com](http://KyoceraPrecisionTools.com)

**4.20mm - 6.80mm DIAMETER**

Match with HYDROS Coolant Fed Deep Drills Product Line  
 Increased Positional Accuracy  
 Less Heat Build Up  
 Excellent Pilot Hole Drill  
 External Coolant

# ORION METRIC SHANK

HIGH PERFORMANCE DRILLS

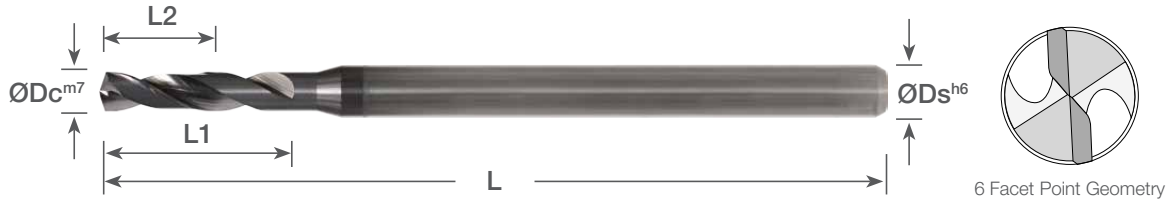

## STANDARD Flute Length



Dimensions (mm)					Point Angle	AlTiN Nano	
ØDc <sup>m7</sup>	ØDs <sup>h6</sup>	L	L1	*L2		Part Number	Stock
4.20	6	70	21.0	8.40	142°	165-1654AG827	●
4.30	6	70	21.5	8.60	142°	165-1693AG846	●
4.40	6	70	22.0	8.80	142°	165-1732AG866	●
4.50	6	70	22.5	9.00	142°	165-1772AG886	●
4.60	6	70	23.0	9.20	142°	165-1811AG906	●
4.70	6	70	23.5	9.40	142°	165-1850AG925	●
4.80	6	70	24.0	9.60	142°	165-1890AG945	●
4.90	6	70	24.5	9.80	142°	165-1929AG965	●
5.00	6	70	25.0	10.00	142°	165-1969AG984	●
5.10	6	70	25.5	10.20	142°	165-2008AG1004	●
5.20	6	70	26.0	10.40	142°	165-2047AG1024	●
5.30	6	70	26.5	10.60	142°	165-2087AG1043	●
5.40	6	70	27.0	10.80	142°	165-2126AG1063	●
5.50	6	70	27.5	11.00	142°	165-2165AG1083	●
5.60	6	70	28.0	11.20	142°	165-2205AG1102	●
5.70	6	70	28.5	11.40	142°	165-2244AG1122	●
5.80	6	70	29.0	11.60	142°	165-2283AG1142	●
5.90	6	70	29.5	11.80	142°	165-2323AG1161	●
6.00	8	80	30.0	12.00	142°	165-2362AG1181	●
6.10	8	80	30.5	12.20	142°	165-2402AG1201	●
6.20	8	80	31.0	12.40	142°	165-2441AG1220	●
6.30	8	80	31.5	12.60	142°	165-2480AG1240	●
6.40	8	80	32.0	12.80	142°	165-2520AG1260	●
6.50	8	80	32.5	13.00	142°	165-2559AG1280	●
6.60	8	80	33.0	13.20	142°	165-2598AG1299	●
6.70	8	80	33.5	13.40	142°	165-2638AG1319	●
6.80	8	80	34.0	13.60	142°	165-2677AG1339	●

\*L2 dimensions refers to the Max. length of cut (3 x ØDc).  
 There is a 2 x ØDc length at the top of the flute for chip exhaust.

Match with HYDROS Deep Hole Coolant Drills Series 865 [Page A47](#)

SERIES 165 WORKPIECE MATERIAL															
Coating	P	P	H	H	M	K	N	N	N	N	N	S	S		
	Steel ~30HRC	Steel 30-40HRC	Hardened Steel ~55HRC	Hardened Steel ~68HRC	Stainless Steel	Cast Iron	Aluminum	Graphite	Copper Alloy	CFRP	Plastic	Thermoset Plastic	High Density Plastic	Nickel / Cobalt	Titanium Alloy
AlTiN Nano	★	★	★	★	★	☆		☆	☆		☆	☆	☆	★	★

★ : Priority ☆ : Applicable Materials

Symbol Descriptions [Page vii](#)

# ORION METRIC SHANK

HIGH PERFORMANCE DRILLS

6.90mm - 9.50mm DIAMETER

Match with HYDROS Coolant Fed Deep Drills Product Line

Increased Positional Accuracy

Less Heat Build Up

Excellent Pilot Hole Drill

External Coolant

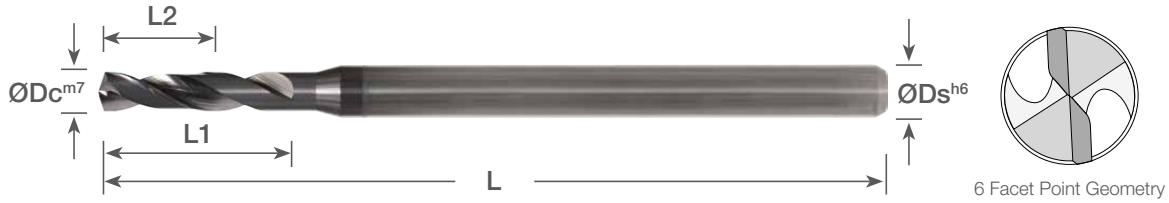

## STANDARD Flute Length



Dimensions (mm)					Point Angle	AlTiN Nano	
ØDc <sup>m7</sup>	ØDs <sup>h6</sup>	L	L1	*L2		Part Number	Stock
6.90	8	80	34.5	13.80	142°	165-2717AG1358	●
7.00	8	80	35.0	14.00	142°	165-2756AG1378	●
7.10	8	80	35.5	14.20	142°	165-2795AG1398	●
7.20	8	80	36.0	14.40	142°	165-2835AG1417	●
7.30	8	80	36.5	14.60	142°	165-2874AG1437	●
7.40	8	80	37.0	14.80	142°	165-2913AG1457	●
7.50	8	80	37.5	15.00	142°	165-2953AG1476	●
7.60	8	80	38.0	15.20	142°	165-2992AG1496	●
7.70	8	80	38.5	15.40	142°	165-3031AG1516	●
7.80	8	80	39.0	15.60	142°	165-3071AG1535	●
7.90	8	80	39.5	15.80	142°	165-3110AG1555	●
8.00	10	100	40.0	16.00	142°	165-3150AG1575	●
8.10	10	100	40.5	16.20	142°	165-3189AG1594	●
8.20	10	100	41.0	16.40	142°	165-3228AG1614	●
8.30	10	100	41.5	16.60	142°	165-3268AG1634	●
8.40	10	100	42.0	16.80	142°	165-3307AG1654	●
8.50	10	100	42.5	17.00	142°	165-3346AG1673	●
8.60	10	100	43.0	17.20	142°	165-3386AG1693	●
8.70	10	100	43.5	17.40	142°	165-3425AG1713	●
8.80	10	100	44.0	17.60	142°	165-3465AG1732	●
8.90	10	100	44.5	17.80	142°	165-3504AG1752	●
9.00	10	100	45.0	18.00	142°	165-3543AG1772	●
9.10	10	100	45.5	18.20	142°	165-3583AG1791	●
9.20	10	100	46.0	18.40	142°	165-3622AG1811	●
9.30	10	100	46.5	18.60	142°	165-3661AG1831	●
9.40	10	100	47.0	18.80	142°	165-3701AG1850	●
9.50	10	100	47.5	19.00	142°	165-3740AG1870	●

\*L2 dimensions refers to the Max. length of cut (3 x ØDc).  
There is a 2 x ØDc length at the top of the flute for chip exhaust.

Match with HYDROS Deep Hole Coolant Drills Series 865 ➔ Page A48

SERIES 165 WORKPIECE MATERIAL															
Coating	P	P	H	H	M	K	N	N	N	N	N	S	S		
	Steel ~30HRC	Steel 30-40HRC	Hardened Steel ~55HRC	Hardened Steel ~68HRC	Stainless Steel	Cast Iron	Aluminum	Graphite	Copper Alloy	CFRP	Plastic	Thermoset Plastic	High Density Plastic	Nickel / Cobalt	Titanium Alloy
AlTiN Nano	★	★	★	★	★	☆		☆	☆		☆	☆	☆	★	★

★ : Priority ☆ : Applicable Materials

Symbol Descriptions ➔ Page vii

● : U.S. Stock Standard  
■ : NOT STOCKED - Call for Delivery

(U.S.) 1.888.848.8449  
(International) 001.714.428.3636  
Pricing & Availability at [KyoceraPrecisionTools.com](http://KyoceraPrecisionTools.com)



9.60mm - 12.00mm DIAMETER

Match with HYDROS Coolant Fed Deep Drills Product Line

Increased Positional Accuracy

Less Heat Build Up

Excellent Pilot Hole Drill

External Coolant

# ORION METRIC SHANK

HIGH PERFORMANCE DRILLS

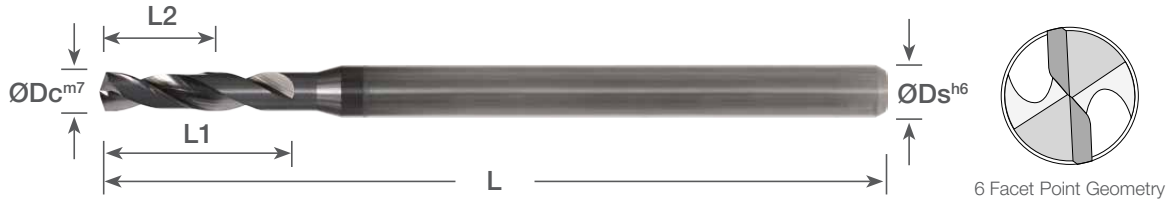

## STANDARD Flute Length



Dimensions (mm)					Point Angle	AlTiN Nano	
ØDc <sup>m7</sup>	ØDs <sup>h6</sup>	L	L1	*L2		Part Number	Stock
9.60	10	100	48.0	19.20	142°	165-3780AG1890	●
9.70	10	100	48.5	19.40	142°	165-3819AG1909	●
9.80	10	100	49.0	19.60	142°	165-3858AG1929	●
9.90	10	100	49.5	19.80	142°	165-3898AG1949	●
10.00	12	110	50.0	20.00	142°	165-3937AG1969	●
10.10	12	110	50.5	20.20	142°	165-3976AG1988	●
10.20	12	110	51.0	20.40	142°	165-4016AG2008	●
10.30	12	110	51.5	20.60	142°	165-4055AG2028	●
10.40	12	110	52.0	20.80	142°	165-4094AG2047	●
10.50	12	110	52.5	21.00	142°	165-4134AG2067	●
10.60	12	110	53.0	21.20	142°	165-4173AG2087	●
10.70	12	110	53.5	21.40	142°	165-4213AG2106	●
10.80	12	110	54.0	21.60	142°	165-4252AG2126	●
10.90	12	110	54.5	21.80	142°	165-4291AG2146	●
11.00	12	110	55.0	22.00	142°	165-4331AG2165	●
11.10	12	110	55.5	22.20	142°	165-4370AG2185	●
11.20	12	110	56.0	22.40	142°	165-4409AG2205	●
11.30	12	110	56.5	22.60	142°	165-4449AG2224	●
11.40	12	110	57.0	22.80	142°	165-4488AG2244	●
11.50	12	110	57.5	23.00	142°	165-4528AG2264	●
11.60	12	110	58.0	23.20	142°	165-4567AG2283	●
11.70	12	110	58.5	23.40	142°	165-4606AG2303	●
11.80	12	110	59.0	23.60	142°	165-4646AG2323	●
11.90	12	110	59.5	23.80	142°	165-4685AG2343	●
12.00	14	110	60.0	24.00	142°	165-4724AG2362	●

\*L2 dimensions refers to the Max. length of cut (3 x ØDc).  
There is a 2 x ØDc length at the top of the flute for chip exhaust.

Match with HYDROS Deep Hole Coolant Drills Series 865 [Page A49](#)

SERIES 165 WORKPIECE MATERIAL															
Coating	P	P	H	H	M	K	N	N	N	N	N	S	S		
	Steel ~30HRC	Steel 30-40HRC	Hardened Steel ~55HRC	Hardened Steel ~68HRC	Stainless Steel	Cast Iron	Aluminum	Graphite	Copper Alloy	CFRP	Plastic	Thermoset Plastic	High Density Plastic	Nickel / Cobalt	Titanium Alloy
AlTiN Nano	★	★	★	★	★	☆		☆	☆		☆	☆	☆	★	★

★ : Priority ☆ : Applicable Materials

Symbol Descriptions [Page vii](#)



# 3.00mm SHANK

MICRO DRILLS

0.04mm - 0.34mm DIAMETER

Mirror Surface Finishes  
Sub Micron Grain Carbide

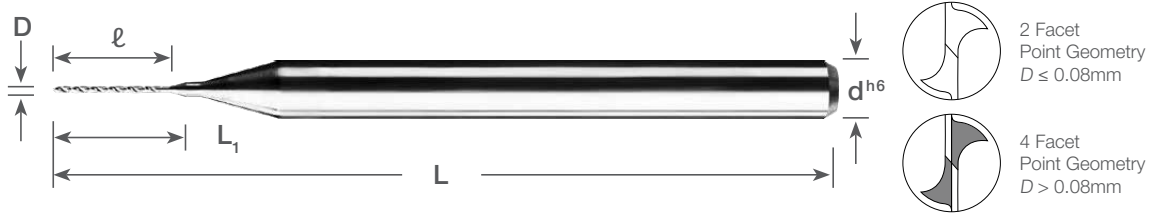

## STANDARD Flute Length

Dimensions (mm)					Uncoated		AlTiN Coating	
$D^{+0.000mm/-0.008mm}$	$d^{h6}$	$l$	$L$	$L_1$	Part Number	Stock	Part Number	Stock
0.04	3	0.50	38	0.50	226-0016.020	●	-	-
0.05	3	0.80	38	0.80	226-0020.030	●	-	-
0.06	3	0.80	38	0.80	226-0024.030	●	-	-
0.07	3	1.30	38	1.30	226-0028.050	●	-	-
0.08	3	1.30	38	1.30	226-0031.050	●	-	-
0.09	3	1.30	38	1.30	226-0035.050	●	-	-
0.10	3	1.00	38	1.20	226-0039.040	●	-	-
0.11	3	1.00	38	1.20	226-0043.040	●	-	-
0.12	3	1.00	38	1.20	226-0047.040	●	-	-
0.13	3	1.00	38	1.20	226-0051.040	●	-	-
0.14	3	1.00	38	1.20	226-0055.040	●	-	-
0.15	3	2.00	38	2.20	226-0059.080	●	-	-
0.16	3	2.00	38	2.20	226-0063.080	●	-	-
0.17	3	2.00	38	2.20	226-0067.080	●	-	-
0.18	3	2.50	38	2.70	226-0071.100	●	-	-
0.19	3	2.50	38	2.70	226-0075.100	●	-	-
0.20	3	2.50	38	2.70	226-0079.100	●	-	-
0.21	3	2.50	38	2.70	226-0083.100	●	-	-
0.22	3	2.50	38	2.70	226-0087.100	●	-	-
0.23	3	3.80	38	4.00	226-0091.150	●	-	-
0.24	3	3.80	38	4.00	226-0094.150	●	-	-
0.25	3	3.80	38	4.00	226-0098.150	●	-	-
0.26	3	3.80	38	4.00	226-0102.150	●	-	-
0.27	3	3.80	38	4.00	226-0106.150	●	-	-
0.28	3	3.80	38	4.00	226-0110.150	●	-	-
0.29	3	3.80	38	4.00	226-0114.150	●	-	-
0.30	3	5.70	38	5.90	226-0118.225	●	226-0118L225	●
0.31	3	5.70	38	5.90	226-0122.225	●	226-0122L225	●
0.32	3	5.70	38	5.90	226-0126.225	●	226-0126L225	●
0.33	3	5.70	38	5.90	226-0130.225	●	226-0130L225	●
0.34	3	5.70	38	5.90	226-0134.225	●	226-0134L225	●

SERIES 226 WORKPIECE MATERIAL															
Coating	P Steel ~30HRC	P Steel 30~40HRC	H Hardened Steel ~55HRC	H Hardened Steel ~68HRC	M Stainless Steel	K Cast Iron	N Aluminum	N Graphite	N Copper Alloy	N CFRP	N Plastic	N Thermoset Plastic	N High Density Plastic	S Nickel / Cobalt	S Titanium Alloy
AlTiN	★	★	★	★	★	☆	☆	☆	☆	☆	☆	☆	☆	☆	☆
Uncoated							☆	☆	★	☆	★	★	★		☆

★ : Priority ☆ : Applicable Materials

Symbol Descriptions Page vii

● : U.S. Stock Standard  
■ : NOT STOCKED - Call for Delivery

(U.S.) 1.888.848.8449  
(International) 001.714.428.3636  
Pricing & Availability at [KyoceraPrecisionTools.com](http://KyoceraPrecisionTools.com)

DRILLS A  
END MILLS B  
ROUTERS C  
THREAD MILLS & TAPS D  
ENGRAVERS E  
BORING BARS F  
REAMERS G  
SAWS H  
TECHNICAL I  
INDEX J

# 3.00mm SHANK

0.35mm - 0.54mm DIAMETER

Mirror Surface Finishes  
Sub Micron Grain Carbide

MICRO DRILLS

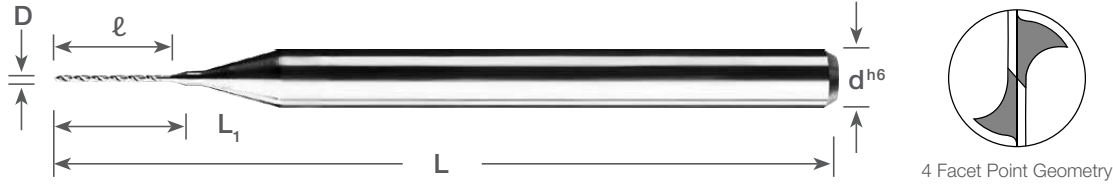

## STANDARD Flute Length

D	Dimensions (mm)					Uncoated		AlTiN Coating	
	D <sup>+0.000mm -0.008mm</sup>	d <sup>h6</sup>	ℓ	L	L <sub>1</sub>	Part Number	Stock	Part Number	Stock
E	0.35	3	5.70	38	5.90	226-0138.225	●	226-0138L225	●
E	0.36	3	5.70	38	5.90	226-0142.225	●	226-0142L225	●
E	0.37	3	5.70	38	5.90	226-0146.225	●	226-0146L225	●
E	0.38	3	6.40	38	6.60	226-0150.250	●	226-0150L250	●
E	0.39	3	6.40	38	6.60	226-0154.250	●	226-0154L250	●
F	0.40	3	6.40	38	6.60	226-0157.250	●	226-0157L250	●
F	0.41	3	6.40	38	6.60	226-0161.250	●	226-0161L250	●
F	0.42	3	6.40	38	6.60	226-0165.250	●	226-0165L250	●
F	0.43	3	6.40	38	6.60	226-0169.250	●	226-0169L250	●
F	0.44	3	6.40	38	6.60	226-0173.250	●	226-0173L250	●
F	0.45	3	6.40	38	6.60	226-0177.250	●	226-0177L250	●
G	0.46	3	6.40	38	6.60	226-0181.250	●	226-0181L250	●
G	0.47	3	6.40	38	6.60	226-0185.250	●	226-0185L250	●
G	0.48	3	6.60	38	6.80	226-0189.260	●	226-0189L260	●
G	0.49	3	6.60	38	6.80	226-0193.260	●	226-0193L260	●
H	0.50	3	6.60	38	6.80	226-0197.260	●	226-0197L260	●
H	0.51	3	6.60	38	6.80	226-0201.260	●	226-0201L260	●
H	0.52	3	6.60	38	6.80	226-0205.260	●	226-0205L260	●
H	0.53	3	6.60	38	6.80	226-0209.260	●	226-0209L260	●
H	0.54	3	6.60	38	6.80	226-0213.260	●	226-0213L260	●

SERIES 226 WORKPIECE MATERIAL															
Coating	P Steel ~30HRC	P Steel 30-40HRC	H Hardened Steel ~55HRC	H Hardened Steel ~68HRC	M Stainless Steel	K Cast Iron	N Aluminum	N Graphite	N Copper Alloy	N CFRP	N Plastic	N Thermoset Plastic	N High Density Plastic	S Nickel / Cobalt	S Titanium Alloy
AlTiN	★	★	★	★	★	☆	☆	☆	☆	☆	☆	☆	☆	☆	☆
Uncoated							☆	☆	★	☆	★	★	★		☆

★ : Priority ☆ : Applicable Materials

Symbol Descriptions Page vii

# 3.00mm SHANK

MICRO DRILLS

0.55mm - 0.84mm DIAMETER

Mirror Surface Finishes  
Sub Micron Grain Carbide

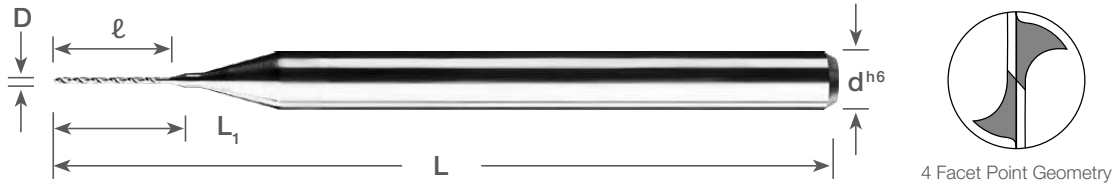

## STANDARD Flute Length

Dimensions (mm)					Uncoated		AlTiN Coating	
D <sup>+0.000mm -0.008mm</sup>	d <sup>h6</sup>	ℓ	L	L <sub>1</sub>	Part Number	Stock	Part Number	Stock
0.55	3	8.60	38	8.80	226-0217.340	●	226-0217L340	●
0.56	3	8.60	38	8.80	226-0220.340	●	226-0220L340	●
0.57	3	8.60	38	8.80	226-0224.340	●	226-0224L340	●
0.58	3	8.60	38	8.80	226-0228.340	●	226-0228L340	●
0.59	3	8.60	38	8.80	226-0232.340	●	226-0232L340	●
0.60	3	8.60	38	8.80	226-0236.340	●	226-0236L340	●
0.61	3	8.60	38	8.80	226-0240.340	●	226-0240L340	●
0.62	3	8.60	38	8.80	226-0244.340	●	226-0244L340	●
0.63	3	8.60	38	8.80	226-0248.340	●	226-0248L340	●
0.64	3	8.60	38	8.80	226-0252.340	●	226-0252L340	●
0.65	3	8.60	38	8.80	226-0256.340	●	226-0256L340	●
0.66	3	8.60	38	8.80	226-0260.340	●	226-0260L340	●
0.67	3	8.60	38	8.80	226-0264.340	●	226-0264L340	●
0.68	3	8.60	38	8.80	226-0268.340	●	226-0268L340	●
0.69	3	8.60	38	8.80	226-0272.340	●	226-0272L340	●
0.70	3	10.20	38	10.40	226-0276.400	●	226-0276L400	●
0.71	3	10.20	38	10.40	226-0280.400	●	226-0280L400	●
0.72	3	10.20	38	10.40	226-0283.400	●	226-0283L400	●
0.73	3	10.20	38	10.40	226-0287.400	●	226-0287L400	●
0.74	3	10.20	38	10.40	226-0291.400	●	226-0291L400	●
0.75	3	10.20	38	10.40	226-0295.400	●	226-0295L400	●
0.76	3	10.20	38	10.40	226-0299.400	●	226-0299L400	●
0.77	3	10.20	38	10.40	226-0303.400	●	226-0303L400	●
0.78	3	10.20	38	10.40	226-0307.400	●	226-0307L400	●
0.79	3	10.20	38	10.40	226-0311.400	●	226-0311L400	●
0.80	3	10.20	38	10.40	226-0315.400	●	226-0315L400	●
0.81	3	10.20	38	10.40	226-0319.400	●	226-0319L400	●
0.82	3	10.20	38	10.40	226-0323.400	●	226-0323L400	●
0.83	3	10.20	38	10.40	226-0327.400	●	226-0327L400	●
0.84	3	10.20	38	10.40	226-0331.400	●	226-0331L400	●

SERIES 226 WORKPIECE MATERIAL															
Coating	P Steel ~30HRC	P Steel 30~40HRC	H Hardened Steel ~55HRC	H Hardened Steel ~68HRC	M Stainless Steel	K Cast Iron	N Aluminum	N Graphite	N Copper Alloy	N CFRP	N Plastic	N Thermoset Plastic	N High Density Plastic	S Nickel / Cobalt	S Titanium Alloy
AlTiN	★	★	★	★	★	☆	☆	☆	☆	☆	☆	☆	☆	☆	☆
Uncoated							☆	☆	★	☆	★	★	★		☆

★ : Priority ☆ : Applicable Materials

Symbol Descriptions Page vii

● : U.S. Stock Standard  
■ : NOT STOCKED - Call for Delivery

(U.S.) 1.888.848.8449  
(International) 001.714.428.3636  
Pricing & Availability at [KyoceraPrecisionTools.com](http://KyoceraPrecisionTools.com)

DRILLS A  
END MILLS B  
ROUTERS C  
THREAD MILLS & TAPS D  
ENGRAVERS E  
BORING BARS F  
REAMERS G  
SAWS H  
TECHNICAL I  
INDEX J

# 3.00mm SHANK

MICRO DRILLS

0.85mm - 1.14mm DIAMETER

Mirror Surface Finishes  
Sub Micron Grain Carbide

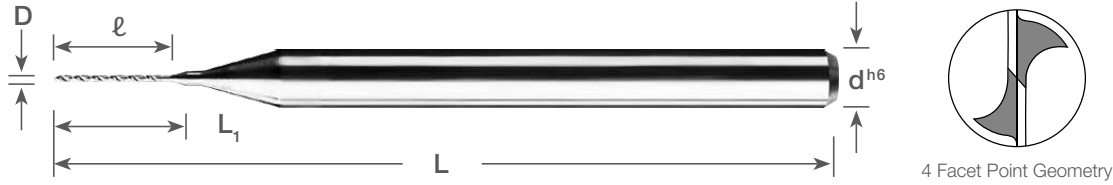

## STANDARD Flute Length

Dimensions (mm)					Uncoated		AlTiN Coating	
D <sup>+0.000mm -0.008mm</sup>	d <sup>h6</sup>	ℓ	L	L <sub>1</sub>	Part Number	Stock	Part Number	Stock
0.85	3	10.20	38	10.40	226-0335.400	●	226-0335L400	●
0.86	3	10.20	38	10.40	226-0339.400	●	226-0339L400	●
0.87	3	10.20	38	10.40	226-0343.400	●	226-0343L400	●
0.88	3	10.20	38	10.40	226-0346.400	●	226-0346L400	●
0.89	3	10.20	38	10.40	226-0350.400	●	226-0350L400	●
0.90	3	10.20	38	10.40	226-0354.400	●	226-0354L400	●
0.91	3	10.20	38	10.40	226-0358.400	●	226-0358L400	●
0.92	3	10.20	38	10.40	226-0362.400	●	226-0362L400	●
0.93	3	10.20	38	10.40	226-0366.400	●	226-0366L400	●
0.94	3	10.20	38	10.40	226-0370.400	●	226-0370L400	●
0.95	3	10.20	38	10.40	226-0374.400	●	226-0374L400	●
0.96	3	10.20	38	10.40	226-0378.400	●	226-0378L400	●
0.97	3	10.20	38	10.40	226-0382.400	●	226-0382L400	●
0.98	3	10.20	38	10.40	226-0386.400	●	226-0386L400	●
0.99	3	10.20	38	10.40	226-0390.400	●	226-0390L400	●
1.00	3	10.20	38	10.40	226-0394.400	●	226-0394L400	●
1.01	3	10.20	38	10.40	226-0398.400	●	226-0398L400	●
1.02	3	10.20	38	10.40	226-0402.400	●	226-0402L400	●
1.03	3	10.20	38	10.40	226-0406.400	●	226-0406L400	●
1.04	3	10.20	38	10.40	226-0409.400	●	226-0409L400	●
1.05	3	10.20	38	10.40	226-0413.400	●	226-0413L400	●
1.06	3	10.20	38	10.40	226-0417.400	●	226-0417L400	●
1.07	3	10.20	38	10.40	226-0421.400	●	226-0421L400	●
1.08	3	10.20	38	10.40	226-0425.400	●	226-0425L400	●
1.09	3	10.20	38	10.40	226-0429.400	●	226-0429L400	●
1.10	3	10.20	38	10.40	226-0433.400	●	226-0433L400	●
1.11	3	10.20	38	10.40	226-0437.400	●	226-0437L400	●
1.12	3	10.20	38	10.40	226-0441.400	●	226-0441L400	●
1.13	3	10.20	38	10.40	226-0445.400	●	226-0445L400	●
1.14	3	10.20	38	10.40	226-0449.400	●	226-0449L400	●

SERIES 226 WORKPIECE MATERIAL															
Coating	P Steel ~30HRC	P Steel 30-40HRC	H Hardened Steel ~55HRC	H Hardened Steel ~68HRC	M Stainless Steel	K Cast Iron	N Aluminum	N Graphite	N Copper Alloy	N CFRP	N Plastic	N Thermoset Plastic	N High Density Plastic	S Nickel / Cobalt	S Titanium Alloy
AlTiN	★	★	★	★	★	☆	☆	☆	☆	☆	☆	☆	☆	☆	☆
Uncoated							☆	☆	★	☆	★	★	★		☆

★ : Priority ☆ : Applicable Materials

Symbol Descriptions Page vii

# 3.00mm SHANK

MICRO DRILLS

1.15mm - 1.44mm DIAMETER

Mirror Surface Finishes

Sub Micron Grain Carbide

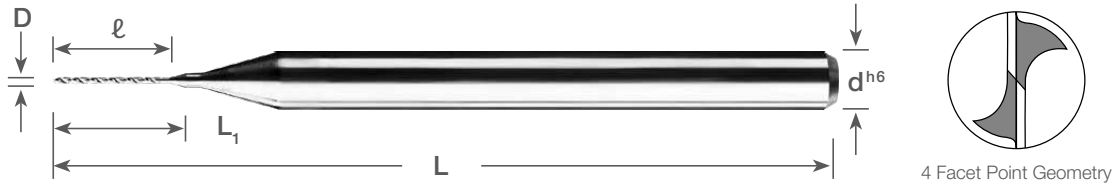

## STANDARD Flute Length



Dimensions (mm)					Uncoated		AlTiN Coating	
D <sup>+0.000mm -0.008mm</sup>	d <sup>h6</sup>	ℓ	L	L <sub>1</sub>	Part Number	Stock	Part Number	Stock
1.15	3	10.20	38	10.40	226-0453.400	●	226-0453L400	●
1.16	3	10.20	38	10.40	226-0457.400	●	226-0457L400	●
1.17	3	10.20	38	10.40	226-0461.400	●	226-0461L400	●
1.18	3	10.20	38	10.40	226-0465.400	●	226-0465L400	●
1.19	3	10.20	38	10.40	226-0469.400	●	226-0469L400	●
1.20	3	10.20	38	10.40	226-0472.400	●	226-0472L400	●
1.21	3	10.20	38	10.40	226-0476.400	●	226-0476L400	●
1.22	3	10.20	38	10.40	226-0480.400	●	226-0480L400	●
1.23	3	10.20	38	10.40	226-0484.400	●	226-0484L400	●
1.24	3	10.20	38	10.40	226-0488.400	●	226-0488L400	●
1.25	3	10.20	38	10.40	226-0492.400	●	226-0492L400	●
1.26	3	10.20	38	10.40	226-0496.400	●	226-0496L400	●
1.27	3	10.20	38	10.40	226-0500.400	●	226-0500L400	●
1.28	3	10.20	38	10.40	226-0504.400	●	226-0504L400	●
1.29	3	10.20	38	10.40	226-0508.400	●	226-0508L400	●
1.30	3	10.20	38	10.40	226-0512.400	●	226-0512L400	●
1.31	3	10.20	38	10.40	226-0516.400	●	226-0516L400	●
1.32	3	10.20	38	10.40	226-0520.400	●	226-0520L400	●
1.33	3	10.20	38	10.40	226-0524.400	●	226-0524L400	●
1.34	3	10.20	38	10.40	226-0528.400	●	226-0528L400	●
1.35	3	10.20	38	10.40	226-0531.400	●	226-0531L400	●
1.36	3	10.20	38	10.40	226-0535.400	●	226-0535L400	●
1.37	3	10.20	38	10.40	226-0539.400	●	226-0539L400	●
1.38	3	10.20	38	10.40	226-0543.400	●	226-0543L400	●
1.39	3	10.20	38	10.40	226-0547.400	●	226-0547L400	●
1.40	3	10.20	38	10.40	226-0551.400	●	226-0551L400	●
1.41	3	10.20	38	10.40	226-0555.400	●	226-0555L400	●
1.42	3	10.20	38	10.40	226-0559.400	●	226-0559L400	●
1.43	3	10.20	38	10.40	226-0563.400	●	226-0563L400	●
1.44	3	10.20	38	10.40	226-0567.400	●	226-0567L400	●

SERIES 226 WORKPIECE MATERIAL															
Coating	P Steel ~30HRC	P Steel 30~40HRC	H Hardened Steel ~55HRC	H Hardened Steel ~68HRC	M Stainless Steel	K Cast Iron	N Aluminum	N Graphite	N Copper Alloy	N CFRP	N Plastic	N Thermoset Plastic	N High Density Plastic	S Nickel / Cobalt	S Titanium Alloy
AlTiN	★	★	★	★	★	☆	☆	☆	☆	☆	☆	☆	☆	☆	☆
Uncoated							☆	☆	★	☆	★	★			☆

★ : Priority ☆ : Applicable Materials

Symbol Descriptions Page vii

● : U.S. Stock Standard  
■ : NOT STOCKED - Call for Delivery

(U.S.) 1.888.848.8449  
(International) 001.714.428.3636  
Pricing & Availability at [KyoceraPrecisionTools.com](http://KyoceraPrecisionTools.com)

# 3.00mm SHANK

MICRO DRILLS

1.45mm - 1.74mm DIAMETER

Mirror Surface Finishes  
Sub Micron Grain Carbide

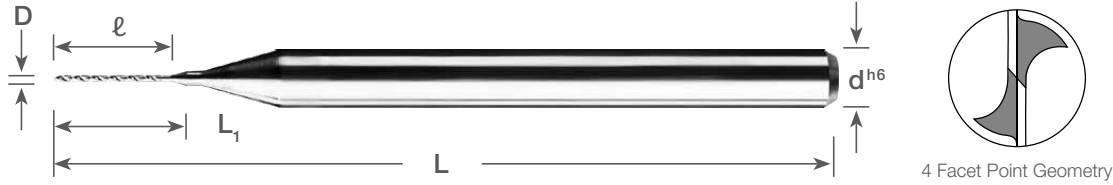

## STANDARD Flute Length

Dimensions (mm)					Uncoated		AlTiN Coating	
D <sup>+0.000mm -0.008mm</sup>	d <sup>h6</sup>	ℓ	L	L <sub>1</sub>	Part Number	Stock	Part Number	Stock
1.45	3	10.20	38	10.40	226-0571.400	●	226-0571L400	●
1.46	3	10.20	38	10.40	226-0575.400	●	226-0575L400	●
1.47	3	10.20	38	10.40	226-0579.400	●	226-0579L400	●
1.48	3	10.20	38	10.40	226-0583.400	●	226-0583L400	●
1.49	3	10.20	38	10.40	226-0587.400	●	226-0587L400	●
1.50	3	10.20	38	10.40	226-0591.400	●	226-0591L400	●
1.51	3	10.20	38	10.40	226-0594.400	●	226-0594L400	●
1.52	3	10.20	38	10.40	226-0598.400	●	226-0598L400	●
1.53	3	10.20	38	10.40	226-0602.400	●	226-0602L400	●
1.54	3	10.20	38	10.40	226-0606.400	●	226-0606L400	●
1.55	3	10.20	38	10.40	226-0610.400	●	226-0610L400	●
1.56	3	10.20	38	10.40	226-0614.400	●	226-0614L400	●
1.57	3	10.20	38	10.40	226-0618.400	●	226-0618L400	●
1.58	3	10.20	38	10.40	226-0622.400	●	226-0622L400	●
1.59	3	10.20	38	10.40	226-0626.400	●	226-0626L400	●
1.60	3	10.20	38	10.40	226-0630.400	●	226-0630L400	●
1.61	3	10.20	38	10.40	226-0634.400	●	226-0634L400	●
1.62	3	10.20	38	10.40	226-0638.400	●	226-0638L400	●
1.63	3	10.20	38	10.40	226-0642.400	●	226-0642L400	●
1.64	3	10.20	38	10.40	226-0646.400	●	226-0646L400	●
1.65	3	10.20	38	10.40	226-0650.400	●	226-0650L400	●
1.66	3	10.20	38	10.40	226-0654.400	●	226-0654L400	●
1.67	3	10.20	38	10.40	226-0657.400	●	226-0657L400	●
1.68	3	10.20	38	10.40	226-0661.400	●	226-0661L400	●
1.69	3	10.20	38	10.40	226-0665.400	●	226-0665L400	●
1.70	3	10.20	38	10.40	226-0669.400	●	226-0669L400	●
1.71	3	10.20	38	10.40	226-0673.400	●	226-0673L400	●
1.72	3	10.20	38	10.40	226-0677.400	●	226-0677L400	●
1.73	3	10.20	38	10.40	226-0681.400	●	226-0681L400	●
1.74	3	10.20	38	10.40	226-0685.400	●	226-0685L400	●

SERIES 226 WORKPIECE MATERIAL															
Coating	P Steel ~30HRC	P Steel 30-40HRC	H Hardened Steel ~55HRC	H Hardened Steel ~68HRC	M Stainless Steel	K Cast Iron	N Aluminum	N Graphite	N Copper Alloy	N CFRP	N Plastic	N Thermoset Plastic	N High Density Plastic	S Nickel / Cobalt	S Titanium Alloy
AlTiN	★	★	★	★	★	☆	☆	☆	☆	☆	☆	☆	☆	☆	☆
Uncoated							☆	☆	★	☆	★	★	★		☆

★ : Priority ☆ : Applicable Materials

Symbol Descriptions [Page vii](#)

# 3.00mm SHANK

MICRO DRILLS

1.75mm - 2.02mm DIAMETER

Mirror Surface Finishes  
Sub Micron Grain Carbide

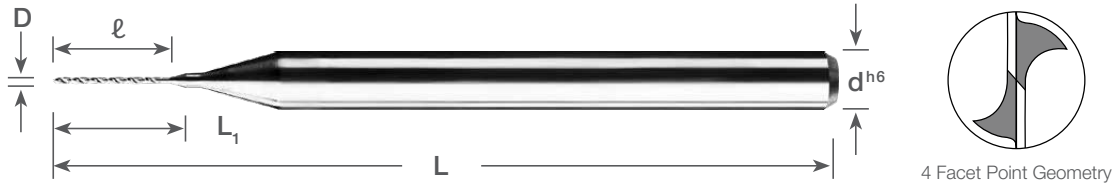

## STANDARD Flute Length

Dimensions (mm)					Uncoated		AlTiN Coating	
$D^{+0.000mm/-0.008mm}$	$d^{h6}$	$l$	$L$	$L_1$	Part Number	Stock	Part Number	Stock
1.75	3	10.20	38	10.40	226-0689.400	●	226-0689L400	●
1.76	3	10.20	38	10.40	226-0693.400	●	226-0693L400	●
1.77	3	10.20	38	10.40	226-0697.400	●	226-0697L400	●
1.78	3	10.20	38	10.40	226-0701.400	●	226-0701L400	●
1.79	3	10.20	38	10.40	226-0705.400	●	226-0705L400	●
1.80	3	10.20	38	10.40	226-0709.400	●	226-0709L400	●
1.81	3	10.20	38	10.40	226-0713.400	●	226-0713L400	●
1.82	3	10.20	38	10.40	226-0717.400	●	226-0717L400	●
1.83	3	10.20	38	10.40	226-0720.400	●	226-0720L400	●
1.84	3	10.20	38	10.40	226-0724.400	●	226-0724L400	●
1.85	3	10.20	38	10.40	226-0728.400	●	226-0728L400	●
1.86	3	10.20	38	10.40	226-0732.400	●	226-0732L400	●
1.87	3	10.20	38	10.40	226-0736.400	●	226-0736L400	●
1.88	3	10.20	38	10.40	226-0740.400	●	226-0740L400	●
1.89	3	10.20	38	10.40	226-0744.400	●	226-0744L400	●
1.90	3	10.20	38	10.40	226-0748.400	●	226-0748L400	●
1.91	3	10.20	38	10.40	226-0752.400	●	226-0752L400	●
1.92	3	10.20	38	10.40	226-0756.400	●	226-0756L400	●
1.93	3	10.20	38	10.40	226-0760.400	●	226-0760L400	●
1.94	3	10.20	38	10.40	226-0764.400	●	226-0764L400	●
1.95	3	10.20	38	10.40	226-0768.400	●	226-0768L400	●
1.96	3	10.20	38	10.40	226-0772.400	●	226-0772L400	●
1.97	3	10.20	38	10.40	226-0776.400	●	226-0776L400	●
1.98	3	10.20	38	10.40	226-0780.400	●	226-0780L400	●
1.99	3	10.20	38	10.40	226-0783.400	●	226-0783L400	●
2.00	3	10.20	38	10.40	226-0787.400	●	226-0787L400	●
2.01	3	10.20	38	10.40	226-0791.400	●	226-0791L400	●
2.02	3	10.20	38	10.40	226-0795.400	●	226-0795L400	●

SERIES 226 WORKPIECE MATERIAL															
Coating	P	P	H	H	M	K	N	N	N	N	N	N	S	S	
	Steel -30HRC	Steel 30-40HRC	Hardened Steel -55HRC	Hardened Steel -68HRC	Stainless Steel	Cast Iron	Aluminum	Graphite	Copper Alloy	CFRP	Plastic	Thermoset Plastic	High Density Plastic	Nickel / Cobalt	Titanium Alloy
AlTiN	★	★	★	★	★	☆	☆	☆	☆	☆	☆	☆	☆	☆	☆
Uncoated							☆	☆	★	☆	★	★			☆

★ : Priority ☆ : Applicable Materials

Symbol Descriptions Page vii

● : U.S. Stock Standard  
■ : NOT STOCKED - Call for Delivery

(U.S.) 1.888.848.8449  
(International) 001.714.428.3636  
Pricing & Availability at [KyoceraPrecisionTools.com](http://KyoceraPrecisionTools.com)

DRILLS A  
END MILLS B  
ROUTERS C  
THREAD MILLS & TAPS D  
ENGRAVERS E  
BORING BARS F  
REAMERS G  
SAWS H  
TECHNICAL I  
INDEX J

# 3.00mm SHANK

MICRO DRILLS

2.03mm - 2.30mm DIAMETER

Mirror Surface Finishes  
Sub Micron Grain Carbide

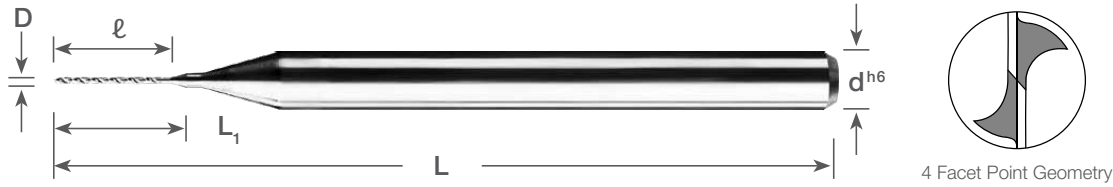

## STANDARD Flute Length

D	Dimensions (mm)					Uncoated		AlTiN Coating	
	$D^{+0.000mm/-0.008mm}$	$d^{h6}$	$l$	$L$	$L_1$	Part Number	Stock	Part Number	Stock
	2.03	3	10.20	38	10.40	226-0799.400	●	226-0799L400	●
	2.04	3	10.20	38	10.40	226-0803.400	●	226-0803L400	●
	2.05	3	10.20	38	10.40	226-0807.400	●	226-0807L400	●
	2.06	3	10.20	38	10.40	226-0811.400	●	226-0811L400	●
	2.07	3	10.20	38	10.40	226-0815.400	●	226-0815L400	●
	2.08	3	10.20	38	10.40	226-0819.400	●	226-0819L400	●
	2.09	3	10.20	38	10.40	226-0823.400	●	226-0823L400	●
	2.10	3	10.20	38	10.40	226-0827.400	●	226-0827L400	●
	2.11	3	10.20	38	10.40	226-0831.400	●	226-0831L400	●
	2.12	3	10.20	38	10.40	226-0835.400	●	226-0835L400	●
	2.13	3	10.20	38	10.40	226-0839.400	●	226-0839L400	●
	2.14	3	10.20	38	10.40	226-0843.400	●	226-0843L400	●
	2.15	3	10.20	38	10.40	226-0846.400	●	226-0846L400	●
	2.16	3	10.20	38	10.40	226-0850.400	●	226-0850L400	●
	2.17	3	10.20	38	10.40	226-0854.400	●	226-0854L400	●
	2.18	3	10.20	38	10.40	226-0858.400	●	226-0858L400	●
	2.19	3	10.20	38	10.40	226-0862.400	●	226-0862L400	●
	2.20	3	10.20	38	10.40	226-0866.400	●	226-0866L400	●
	2.21	3	10.20	38	10.40	226-0870.400	●	226-0870L400	●
	2.22	3	10.20	38	10.40	226-0874.400	●	226-0874L400	●
	2.23	3	10.20	38	10.40	226-0878.400	●	226-0878L400	●
	2.24	3	10.20	38	10.40	226-0882.400	●	226-0882L400	●
	2.25	3	10.20	38	10.40	226-0886.400	●	226-0886L400	●
	2.26	3	10.20	38	10.40	226-0890.400	●	226-0890L400	●
	2.27	3	10.20	38	10.40	226-0894.400	●	226-0894L400	●
	2.28	3	10.20	38	10.40	226-0898.400	●	226-0898L400	●
	2.29	3	10.20	38	10.40	226-0902.400	●	226-0902L400	●
	2.30	3	10.20	38	10.40	226-0906.400	●	226-0906L400	●

SERIES 226 WORKPIECE MATERIAL															
Coating	P	P	H	H	M	K	N	N	N	N	N	N	S	S	
	Steel ~30HRC	Steel 30-40HRC	Hardened Steel ~55HRC	Hardened Steel ~68HRC	Stainless Steel	Cast Iron	Aluminum	Graphite	Copper Alloy	CFRP	Plastic	Thermoset Plastic	High Density Plastic	Nickel / Cobalt	Titanium Alloy
AlTiN	★	★	★	★	★	☆	☆	☆	☆	☆	☆	☆	☆	☆	☆
Uncoated							☆	☆	★	☆	★	★			☆

★ : Priority ☆ : Applicable Materials

Symbol Descriptions Page vii



# 3.00mm SHANK

MICRO DRILLS

2.31mm - 2.60mm DIAMETER

Mirror Surface Finishes  
Sub Micron Grain Carbide

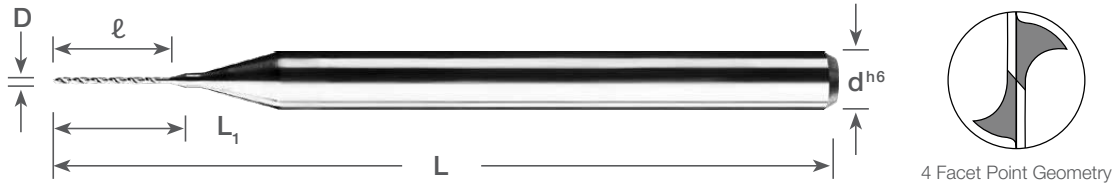

## STANDARD Flute Length

Dimensions (mm)					Uncoated		AlTiN Coating	
D <sup>+0.000mm -0.008mm</sup>	d <sup>h6</sup>	ℓ	L	L <sub>1</sub>	Part Number	Stock	Part Number	Stock
2.31	3	10.20	38	10.40	226-0909.400	●	226-0909L400	●
2.32	3	10.20	38	10.40	226-0913.400	●	226-0913L400	●
2.33	3	10.20	38	10.40	226-0917.400	●	226-0917L400	●
2.34	3	10.20	38	10.40	226-0921.400	●	226-0921L400	●
2.35	3	10.20	38	10.40	226-0925.400	●	226-0925L400	●
2.36	3	10.20	38	10.40	226-0929.400	●	226-0929L400	●
2.37	3	10.20	38	10.40	226-0933.400	●	226-0933L400	●
2.38	3	10.20	38	10.40	226-0937.400	●	226-0937L400	●
2.39	3	10.20	38	10.40	226-0941.400	●	226-0941L400	●
2.40	3	10.20	38	10.40	226-0945.400	●	226-0945L400	●
2.41	3	10.20	38	10.40	226-0949.400	●	226-0949L400	●
2.42	3	10.20	38	10.40	226-0953.400	●	226-0953L400	●
2.43	3	10.20	38	10.40	226-0957.400	●	226-0957L400	●
2.44	3	10.20	38	10.40	226-0961.400	●	226-0961L400	●
2.45	3	10.20	38	10.40	226-0965.400	●	226-0965L400	●
2.46	3	10.20	38	10.40	226-0969.400	●	226-0969L400	●
2.47	3	10.20	38	10.40	226-0972.400	●	226-0972L400	●
2.48	3	10.20	38	10.40	226-0976.400	●	226-0976L400	●
2.49	3	10.20	38	10.40	226-0980.400	●	226-0980L400	●
2.50	3	10.20	38	10.40	226-0984.400	●	226-0984L400	●
2.51	3	10.20	38	10.40	226-0988.400	●	226-0988L400	●
2.52	3	10.20	38	10.40	226-0992.400	●	226-0992L400	●
2.53	3	10.20	38	10.40	226-0996.400	●	226-0996L400	●
2.54	3	10.20	38	10.40	226-1000.400	●	226-1000L400	●
2.55	3	10.20	38	10.40	226-1004.400	●	226-1004L400	●
2.56	3	10.20	38	10.40	226-1008.400	●	226-1008L400	●
2.57	3	10.20	38	10.40	226-1012.400	●	226-1012L400	●
2.58	3	10.20	38	10.40	226-1016.400	●	226-1016L400	●
2.59	3	10.20	38	10.40	226-1020.400	●	226-1020L400	●
2.60	3	10.20	38	10.40	226-1024.400	●	226-1024L400	●

SERIES 226 WORKPIECE MATERIAL															
Coating	P	P	H	H	M	K	N	N	N	N	N	N	N	S	S
	Steel ~30HRC	Steel 30~40HRC	Hardened Steel ~55HRC	Hardened Steel ~68HRC	Stainless Steel	Cast Iron	Aluminum	Graphite	Copper Alloy	CFRP	Plastic	Thermoset Plastic	High Density Plastic	Nickel / Cobalt	Titanium Alloy
AlTiN	★	★	★	★	★	☆	☆	☆	☆	☆	☆	☆	☆	☆	☆
Uncoated							☆	☆	★	☆	★	★			☆

★ : Priority ☆ : Applicable Materials

Symbol Descriptions Page vii

● : U.S. Stock Standard  
■ : NOT STOCKED - Call for Delivery

(U.S.) 1.888.848.8449  
(International) 001.714.428.3636  
Pricing & Availability at [KyoceraPrecisionTools.com](http://KyoceraPrecisionTools.com)

DRILLS A  
END MILLS B  
ROUTERS C  
THREAD MILLS & TAPS D  
ENGRAVERS E  
BORING BARS F  
REAMERS G  
SAWS H  
TECHNICAL I  
INDEX J

# 3.00mm SHANK

MICRO DRILLS

2.61mm - 2.90mm DIAMETER

Mirror Surface Finishes  
Sub Micron Grain Carbide

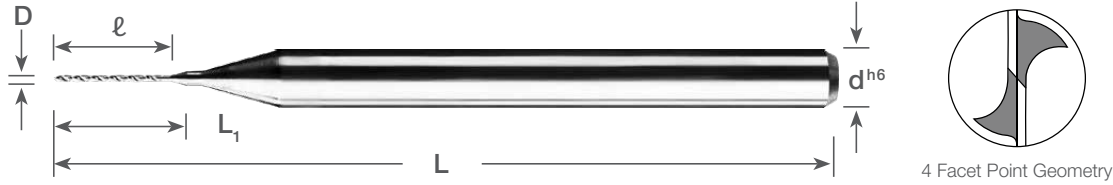

## STANDARD Flute Length

Dimensions (mm)					Uncoated		AlTiN Coating	
D <sup>+0.000mm -0.008mm</sup>	d <sup>h6</sup>	ℓ	L	L <sub>1</sub>	Part Number	Stock	Part Number	Stock
2.61	3	10.20	38	10.40	226-1028.400	●	226-1028L400	●
2.62	3	10.20	38	10.40	226-1031.400	●	226-1031L400	●
2.63	3	10.20	38	10.40	226-1035.400	●	226-1035L400	●
2.64	3	10.20	38	10.40	226-1039.400	●	226-1039L400	●
2.65	3	10.20	38	10.40	226-1043.400	●	226-1043L400	●
2.66	3	10.20	38	10.40	226-1047.400	●	226-1047L400	●
2.67	3	10.20	38	10.40	226-1051.400	●	226-1051L400	●
2.68	3	10.20	38	10.40	226-1055.400	●	226-1055L400	●
2.69	3	10.20	38	10.40	226-1059.400	●	226-1059L400	●
2.70	3	10.20	38	10.40	226-1063.400	●	226-1063L400	●
2.71	3	10.20	38	10.40	226-1067.400	●	226-1067L400	●
2.72	3	10.20	38	10.40	226-1071.400	●	226-1071L400	●
2.73	3	10.20	38	10.40	226-1075.400	●	226-1075L400	●
2.74	3	10.20	38	10.40	226-1079.400	●	226-1079L400	●
2.75	3	10.20	38	10.40	226-1083.400	●	226-1083L400	●
2.76	3	10.20	38	10.40	226-1087.400	●	226-1087L400	●
2.77	3	10.20	38	10.40	226-1091.400	●	226-1091L400	●
2.78	3	10.20	38	10.40	226-1094.400	●	226-1094L400	●
2.79	3	10.20	38	10.40	226-1098.400	●	226-1098L400	●
2.80	3	10.20	38	10.40	226-1102.400	●	226-1102L400	●
2.81	3	10.20	38	10.40	226-1106.400	●	226-1106L400	●
2.82	3	10.20	38	10.40	226-1110.400	●	226-1110L400	●
2.83	3	10.20	38	10.40	226-1114.400	●	226-1114L400	●
2.84	3	10.20	38	10.40	226-1118.400	●	226-1118L400	●
2.85	3	10.20	38	10.40	226-1122.400	●	226-1122L400	●
2.86	3	10.20	38	10.40	226-1126.400	●	226-1126L400	●
2.87	3	10.20	38	10.40	226-1130.400	●	226-1130L400	●
2.88	3	10.20	38	10.40	226-1134.400	●	226-1134L400	●
2.89	3	10.20	38	10.40	226-1138.400	●	226-1138L400	●
2.90	3	10.20	38	10.40	226-1142.400	●	226-1142L400	●

SERIES 226 WORKPIECE MATERIAL															
Coating	P Steel ~30HRC	P Steel 30-40HRC	H Hardened Steel ~55HRC	H Hardened Steel ~68HRC	M Stainless Steel	K Cast Iron	N Aluminum	N Graphite	N Copper Alloy	N CFRP	N Plastic	N Thermoset Plastic	N High Density Plastic	S Nickel / Cobalt	S Titanium Alloy
AlTiN	★	★	★	★	★	☆	☆	☆	☆	☆	☆	☆	☆	☆	☆
Uncoated							☆	☆	★	☆	★	★	★		☆

★ : Priority ☆ : Applicable Materials

Symbol Descriptions [Page vii](#)

# 3.00mm SHANK

MICRO DRILLS

2.91mm - 3.00mm DIAMETER

Mirror Surface Finishes  
Sub Micron Grain Carbide

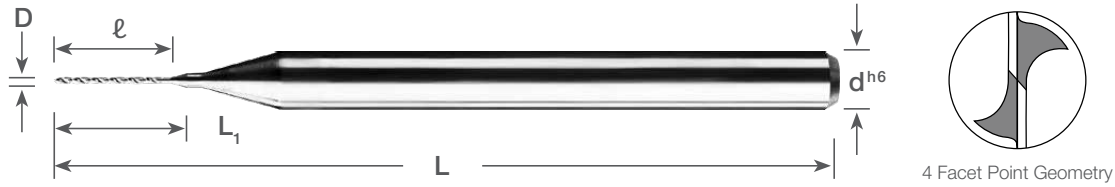

## STANDARD Flute Length

Dimensions (mm)					Uncoated		AlTiN Coating	
D <sup>+0.000mm -0.008mm</sup>	d <sup>h6</sup>	l	L	L <sub>1</sub>	Part Number	Stock	Part Number	Stock
2.91	3	10.20	38	10.40	226-1146.400	●	226-1146L400	●
2.92	3	10.20	38	10.40	226-1150.400	●	226-1150L400	●
2.93	3	10.20	38	10.40	226-1154.400	●	226-1154L400	●
2.94	3	10.20	38	10.40	226-1157.400	●	226-1157L400	●
2.95	3	10.20	38	10.40	226-1161.400	●	226-1161L400	●
2.96	3	10.20	38	10.40	226-1165.400	●	226-1165L400	●
2.97	3	10.20	38	10.40	226-1169.400	●	226-1169L400	●
2.98	3	10.20	38	10.40	226-1173.400	●	226-1173L400	●
2.99	3	10.20	38	10.40	226-1177.400	●	226-1177L400	●
3.00	3	10.20	38	10.40	226-1181.400	●	226-1181L400	●

SERIES 226 WORKPIECE MATERIAL															
Coating	P Steel ~30HRC	P Steel 30-40HRC	H Hardened Steel ~55HRC	H Hardened Steel ~68HRC	M Stainless Steel	K Cast Iron	N Aluminum	N Graphite	N Copper Alloy	N CFRP	N Plastic	N Thermoset Plastic	N High Density Plastic	S Nickel / Cobalt	S Titanium Alloy
AlTiN	★	★	★	★	★	☆	☆	☆	☆	☆	☆	☆	☆	☆	☆
Uncoated							☆	☆	★	☆	★	★	★		☆

★ : Priority ☆ : Applicable Materials

Symbol Descriptions [Page vii](#)

● : U.S. Stock Standard  
■ : NOT STOCKED - Call for Delivery

(U.S.) 1.888.848.8449  
(International) 001.714.428.3636  
Pricing & Availability at [KyoceraPrecisionTools.com](http://KyoceraPrecisionTools.com)

DRILLS A  
END MILLS B  
ROUTERS C  
THREAD MILLS & TAPS D  
ENGRAVERS E  
BORING BARS F  
REAMERS G  
SAWS H  
TECHNICAL I  
INDEX J

# 3.00mm SHANK

MICRO DRILLS

0.75mm - 1.85mm DIAMETER

Mirror Surface Finishes  
Sub Micron Grain Carbide

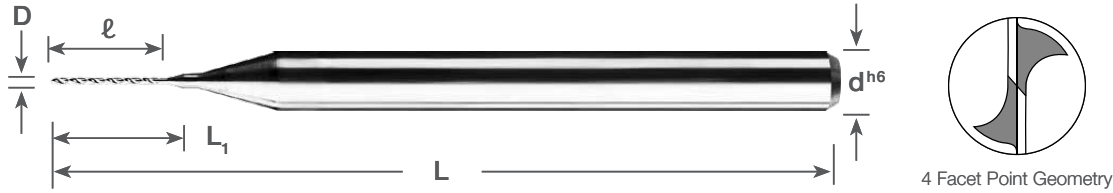

## EXTENDED Flute Length

Dimensions (mm)					Uncoated		AlTiN Coating	
$D^{+0.000mm/-0.008mm}$	$d^{h6}$	$l$	$L$	$L_1$	Part Number	Stock	Part Number	Stock
0.75	3	11.00	50	11.20	226-0295.433	●	226-0295L433	●
0.80	3	11.00	50	11.20	226-0315.433	●	226-0315L433	●
0.85	3	13.00	50	13.20	226-0335.512	●	226-0335L512	●
0.90	3	13.00	50	13.20	226-0354.512	●	226-0354L512	●
0.95	3	15.00	50	15.20	226-0374.591	●	226-0374L591	●
1.00	3	15.00	50	15.20	226-0394.591	●	226-0394L591	●
1.05	3	17.00	50	17.20	226-0413.670	●	226-0413L670	●
1.10	3	17.00	50	17.20	226-0433.670	●	226-0433L670	●
1.15	3	17.00	50	17.20	226-0453.670	●	226-0453L670	●
1.20	3	17.00	50	17.20	226-0472.670	●	226-0472L670	●
1.25	3	19.00	50	19.20	226-0492.749	●	226-0492L749	●
1.30	3	19.00	50	19.20	226-0512.749	●	226-0512L749	●
1.35	3	19.00	50	19.20	226-0531.749	●	226-0531L749	●
1.40	3	19.00	50	19.20	226-0551.749	●	226-0551L749	●
1.45	3	20.00	50	20.20	226-0571.788	●	226-0571L788	●
1.50	3	20.00	50	20.20	226-0591.788	●	226-0591L788	●
1.55	3	20.00	50	20.20	226-0610.788	●	226-0610L788	●
1.60	3	20.00	50	20.20	226-0630.788	●	226-0630L788	●
1.65	3	20.00	50	20.20	226-0650.788	●	226-0650L788	●
1.70	3	20.00	50	20.20	226-0669.788	●	226-0669L788	●
1.75	3	20.00	50	20.20	226-0689.788	●	226-0689L788	●
1.80	3	20.00	50	20.20	226-0709.788	●	226-0709L788	●
1.85	3	22.80	50	23.00	226-0728.898	●	226-0728L898	●

SERIES 226 WORKPIECE MATERIAL															
Coating	P Steel ~30HRC	P Steel 30-40HRC	H Hardened Steel ~55HRC	H Hardened Steel ~68HRC	M Stainless Steel	K Cast Iron	N Aluminum	N Graphite	N Copper Alloy	N CFRP	N Plastic	N Thermoset Plastic	N High Density Plastic	S Nickel / Cobalt	S Titanium Alloy
AlTiN	★	★	★	★	★	☆	☆	☆	☆	☆	☆	☆	☆	☆	☆
Uncoated							☆	☆	★	☆	★	★	★		☆

★ : Priority ☆ : Applicable Materials

Symbol Descriptions Page vii

# 3.00mm SHANK

MICRO DRILLS

1.90mm - 3.00mm DIAMETER

Mirror Surface Finishes  
Sub Micron Grain Carbide

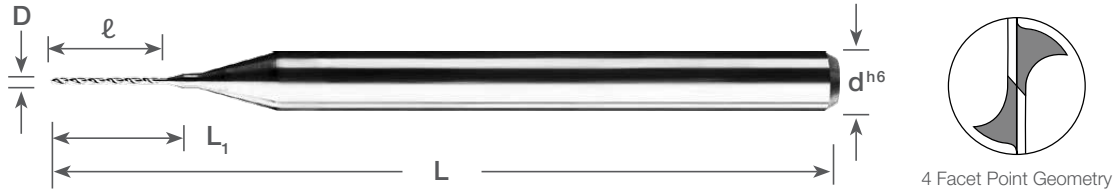

## EXTENDED Flute Length

Dimensions (mm)					Uncoated		AlTiN Coating	
D <sup>+0.000mm -0.008mm</sup>	d <sup>h6</sup>	ℓ	L	L <sub>1</sub>	Part Number	Stock	Part Number	Stock
1.90	3	22.80	60	23.00	226-0748.898	●	226-0748L898	●
1.95	3	23.40	60	23.60	226-0768.945	●	226-0768L945	●
2.00	3	24.00	60	24.20	226-0787.945	●	226-0787L945	●
2.05	3	24.60	60	24.80	226-0807.992	●	226-0807L992	●
2.10	3	25.20	60	25.40	226-0827.992	●	226-0827L992	●
2.15	3	25.80	60	26.00	226-0846.1039	●	226-0846L1039	●
2.20	3	26.40	60	26.60	226-0866.1039	●	226-0866L1039	●
2.25	3	27.00	60	27.20	226-0886.1087	●	226-0886L1087	●
2.30	3	27.60	60	27.80	226-0906.1087	●	226-0906L1087	●
2.35	3	28.20	60	28.40	226-0925.1134	●	226-0925L1134	●
2.40	3	28.80	60	29.00	226-0945.1134	●	226-0945L1134	●
2.45	3	29.40	60	29.60	226-0965.1181	●	226-0965L1181	●
2.50	3	30.00	60	30.20	226-0984.1181	●	226-0984L1181	●
2.55	3	30.60	60	30.80	226-1004.1228	●	226-1004L1228	●
2.60	3	31.20	60	31.40	226-1024.1228	●	226-1024L1228	●
2.65	3	31.80	60	32.00	226-1043.1276	●	226-1043L1276	●
2.70	3	32.40	60	32.60	226-1063.1276	●	226-1063L1276	●
2.75	3	33.00	60	33.20	226-1083.1323	●	226-1083L1323	●
2.80	3	33.60	60	33.80	226-1102.1323	●	226-1102L1323	●
2.85	3	34.20	60	34.40	226-1122.1370	●	226-1122L1370	●
2.90	3	34.80	60	35.00	226-1142.1370	●	226-1142L1370	●
2.95	3	35.40	60	35.60	226-1161.1417	●	226-1161L1417	●
3.00	3	36.00	60	36.20	226-1181.1417	●	226-1181L1417	●

SERIES 226 WORKPIECE MATERIAL															
Coating	P Steel ~30HRC	P Steel 30-40HRC	H Hardened Steel ~55HRC	H Hardened Steel ~68HRC	M Stainless Steel	K Cast Iron	N Aluminum	N Graphite	N Copper Alloy	N CFRP	N Plastic	N Thermoset Plastic	N High Density Plastic	S Nickel / Cobalt	S Titanium Alloy
AlTiN	★	★	★	★	★	☆	☆	☆	☆	☆	☆	☆	☆	☆	☆
Uncoated							☆	☆	★	☆	★	★	★		☆

★ : Priority ☆ : Applicable Materials

Symbol Descriptions Page vii

● : U.S. Stock Standard  
■ : NOT STOCKED - Call for Delivery

(U.S.) 1.888.848.8449  
(International) 001.714.428.3636  
Pricing & Availability at [KyoceraPrecisionTools.com](http://KyoceraPrecisionTools.com)

DRILLS A  
END MILLS B  
ROUTERS C  
THREAD MILLS & TAPS D  
ENGRAVERS E  
BORING BARS F  
REAMERS G  
SAWS H  
TECHNICAL I  
INDEX J

# 3.00mm SHANK

LEFT HAND MICRO DRILLS

0.04mm - 0.34mm DIAMETER

Mirror Surface Finishes  
Sub Micron Grain Carbide

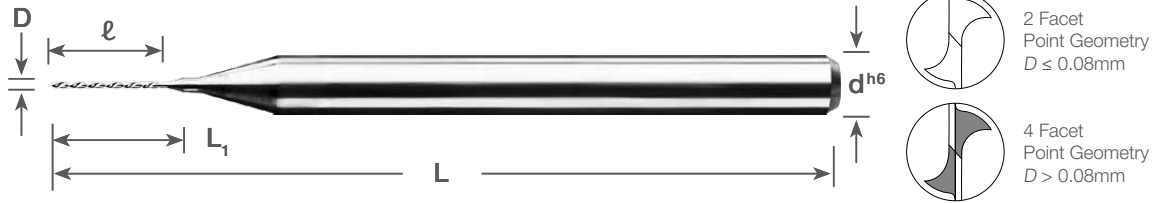

## STANDARD Flute Length

Dimensions (mm)					Uncoated		AlTiN Coating	
D <sup>+0.000mm -0.008mm</sup>	d <sup>h6</sup>	ℓ	L	L <sub>1</sub>	Part Number	Stock	Part Number	Stock
0.04	3	0.50	38	0.50	226L-0016.020	■	-	-
0.05	3	0.80	38	0.80	226L-0020.030	■	-	-
0.06	3	0.80	38	0.80	226L-0024.030	■	-	-
0.07	3	1.30	38	1.30	226L-0028.050	■	-	-
0.08	3	1.30	38	1.30	226L-0031.050	■	-	-
0.09	3	1.30	38	1.30	226L-0035.050	■	-	-
0.10	3	1.00	38	1.20	226L-0039.040	■	-	-
0.11	3	1.00	38	1.20	226L-0043.040	■	-	-
0.12	3	1.00	38	1.20	226L-0047.040	■	-	-
0.13	3	1.00	38	1.20	226L-0051.040	■	-	-
0.14	3	2.00	38	2.20	226L-0055.080	■	-	-
0.15	3	2.00	38	2.20	226L-0059.080	■	-	-
0.16	3	2.00	38	2.20	226L-0063.080	■	-	-
0.17	3	2.00	38	2.20	226L-0067.080	■	-	-
0.18	3	2.50	38	2.70	226L-0071.100	■	-	-
0.19	3	2.50	38	2.70	226L-0075.100	■	-	-
0.20	3	2.50	38	2.70	226L-0079.100	■	-	-
0.21	3	2.50	38	2.70	226L-0083.100	■	-	-
0.22	3	2.50	38	2.70	226L-0087.100	■	-	-
0.23	3	3.80	38	4.00	226L-0091.150	■	-	-
0.24	3	3.80	38	4.00	226L-0094.150	■	-	-
0.25	3	3.80	38	4.00	226L-0098.150	■	-	-
0.26	3	3.80	38	4.00	226L-0102.150	■	-	-
0.27	3	3.80	38	4.00	226L-0106.150	■	-	-
0.28	3	3.80	38	4.00	226L-0110.150	■	-	-
0.29	3	3.80	38	4.00	226L-0114.150	■	-	-
0.30	3	5.70	38	5.90	226L-0118.225	■	226L-0118L225	■
0.31	3	5.70	38	5.90	226L-0122.225	■	226L-0122L225	■
0.32	3	5.70	38	5.90	226L-0126.225	■	226L-0126L225	■
0.33	3	5.70	38	5.90	226L-0130.225	■	226L-0130L225	■
0.34	3	5.70	38	5.90	226L-0134.225	■	226L-0134L225	■

SERIES 226L WORKPIECE MATERIAL															
Coating	P Steel ~30HRC	P Steel 30-40HRC	H Hardened Steel ~55HRC	H Hardened Steel ~68HRC	M Stainless Steel	K Cast Iron	N Aluminum	N Graphite	N Copper Alloy	N CFRP	N Plastic	N Thermoset Plastic	N High Density Plastic	S Nickel / Cobalt	S Titanium Alloy
AlTiN	★	★	★	★	★	☆	☆	☆	☆	☆	☆	☆	☆	☆	☆
Uncoated							☆	☆	★	☆	★	★	★		☆

★ : Priority ☆ : Applicable Materials

Symbol Descriptions [Page vii](#)

# 3.00mm SHANK

LEFT HAND MICRO DRILLS

0.35mm - 0.54mm DIAMETER

Mirror Surface Finishes  
Sub Micron Grain Carbide

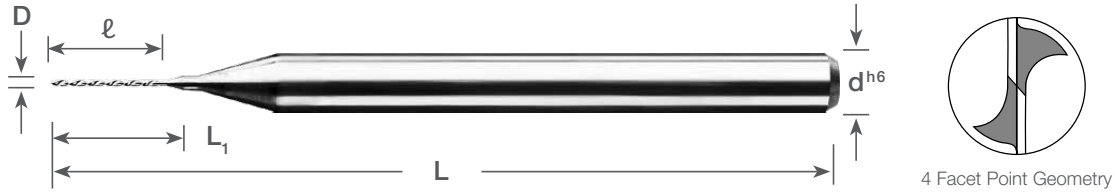

## STANDARD Flute Length

Dimensions (mm)					Uncoated		AlTiN Coating	
D <sup>+0.000mm -0.008mm</sup>	d <sup>h6</sup>	ℓ	L	L <sub>1</sub>	Part Number	Stock	Part Number	Stock
0.35	3	5.70	38	5.90	226L-0138.225	■	226L-0138L225	■
0.36	3	5.70	38	5.90	226L-0142.225	■	226L-0142L225	■
0.37	3	5.70	38	5.90	226L-0146.225	■	226L-0146L225	■
0.38	3	6.40	38	6.60	226L-0150.250	■	226L-0150L250	■
0.39	3	6.40	38	6.60	226L-0154.250	■	226L-0154L250	■
0.40	3	6.40	38	6.60	226L-0157.250	■	226L-0157L250	■
0.41	3	6.40	38	6.60	226L-0161.250	■	226L-0161L250	■
0.42	3	6.40	38	6.60	226L-0165.250	■	226L-0165L250	■
0.43	3	6.40	38	6.60	226L-0169.250	■	226L-0169L250	■
0.44	3	6.40	38	6.60	226L-0173.250	■	226L-0173L250	■
0.45	3	6.40	38	6.60	226L-0177.250	■	226L-0177L250	■
0.46	3	6.40	38	6.60	226L-0181.250	■	226L-0181L250	■
0.47	3	6.40	38	6.60	226L-0185.250	■	226L-0185L250	■
0.48	3	6.60	38	6.80	226L-0189.260	■	226L-0189L260	■
0.49	3	6.60	38	6.80	226L-0193.260	■	226L-0193L260	■
0.50	3	6.60	38	6.80	226L-0197.260	■	226L-0197L260	■
0.51	3	6.60	38	6.80	226L-0201.260	■	226L-0201L260	■
0.52	3	6.60	38	6.80	226L-0205.260	■	226L-0205L260	■
0.53	3	6.60	38	6.80	226L-0209.260	■	226L-0209L260	■
0.54	3	6.60	38	6.80	226L-0213.260	■	226L-0213L260	■

SERIES 226L WORKPIECE MATERIAL															
Coating	P Steel ~30HRC	P Steel 30~40HRC	H Hardened Steel ~55HRC	H Hardened Steel ~68HRC	M Stainless Steel	K Cast Iron	N Aluminum	N Graphite	N Copper Alloy	N CFRP	N Plastic	N Thermoset Plastic	N High Density Plastic	S Nickel / Cobalt	S Titanium Alloy
AlTiN	★	★	★	★	★	☆	☆	☆	☆	☆	☆	☆	☆	☆	☆
Uncoated							☆	☆	★	☆	★	★	★		☆

★ : Priority ☆ : Applicable Materials

Symbol Descriptions Page vii

● : U.S. Stock Standard  
■ : NOT STOCKED - Call for Delivery

(U.S.) 1.888.848.8449  
(International) 001.714.428.3636  
Pricing & Availability at [KyoceraPrecisionTools.com](http://KyoceraPrecisionTools.com)

DRILLS **A**

END MILLS **B**

ROUTERS **C**

THREAD MILLS & TAPS **D**

ENGRAVERS **E**

BORING BARS **F**

REAMERS **G**

SAWS **H**

TECHNICAL **I**

INDEX **J**

# 3.00mm SHANK

LEFT HAND MICRO DRILLS

0.55mm - 0.84mm DIAMETER

Mirror Surface Finishes  
Sub Micron Grain Carbide

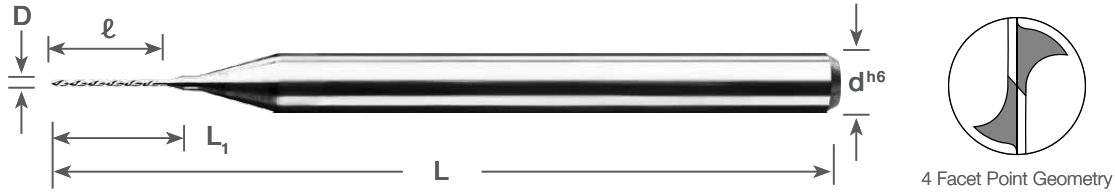

## STANDARD Flute Length

Dimensions (mm)					Uncoated		AlTiN Coating	
D <sup>+0.000mm -0.008mm</sup>	d <sup>h6</sup>	ℓ	L	L <sub>1</sub>	Part Number	Stock	Part Number	Stock
0.55	3	8.60	38	8.80	226L-0217.340	■	226L-0217L340	■
0.56	3	8.60	38	8.80	226L-0220.340	■	226L-0220L340	■
0.57	3	8.60	38	8.80	226L-0224.340	■	226L-0224L340	■
0.58	3	8.60	38	8.80	226L-0228.340	■	226L-0228L340	■
0.59	3	8.60	38	8.80	226L-0232.340	■	226L-0232L340	■
0.60	3	8.60	38	8.80	226L-0236.340	■	226L-0236L340	■
0.61	3	8.60	38	8.80	226L-0240.340	■	226L-0240L340	■
0.62	3	8.60	38	8.80	226L-0244.340	■	226L-0244L340	■
0.63	3	8.60	38	8.80	226L-0248.340	■	226L-0248L340	■
0.64	3	8.60	38	8.80	226L-0252.340	■	226L-0252L340	■
0.65	3	8.60	38	8.80	226L-0256.340	■	226L-0256L340	■
0.66	3	8.60	38	8.80	226L-0260.340	■	226L-0260L340	■
0.67	3	8.60	38	8.80	226L-0264.340	■	226L-0264L340	■
0.68	3	8.60	38	8.80	226L-0268.340	■	226L-0268L340	■
0.69	3	8.60	38	8.80	226L-0272.340	■	226L-0272L340	■
0.70	3	10.20	38	10.40	226L-0276.400	■	226L-0276L400	■
0.71	3	10.20	38	10.40	226L-0280.400	■	226L-0280L400	■
0.72	3	10.20	38	10.40	226L-0283.400	■	226L-0283L400	■
0.73	3	10.20	38	10.40	226L-0287.400	■	226L-0287L400	■
0.74	3	10.20	38	10.40	226L-0291.400	■	226L-0291L400	■
0.75	3	10.20	38	10.40	226L-0295.400	■	226L-0295L400	■
0.76	3	10.20	38	10.40	226L-0299.400	■	226L-0299L400	■
0.77	3	10.20	38	10.40	226L-0303.400	■	226L-0303L400	■
0.78	3	10.20	38	10.40	226L-0307.400	■	226L-0307L400	■
0.79	3	10.20	38	10.40	226L-0311.400	■	226L-0311L400	■
0.80	3	10.20	38	10.40	226L-0315.400	■	226L-0315L400	■
0.81	3	10.20	38	10.40	226L-0319.400	■	226L-0319L400	■
0.82	3	10.20	38	10.40	226L-0323.400	■	226L-0323L400	■
0.83	3	10.20	38	10.40	226L-0327.400	■	226L-0327L400	■
0.84	3	10.20	38	10.40	226L-0331.400	■	226L-0331L400	■

SERIES 226L WORKPIECE MATERIAL															
Coating	P Steel ~30HRC	P Steel 30-40HRC	H Hardened Steel ~55HRC	H Hardened Steel ~68HRC	M Stainless Steel	K Cast Iron	N Aluminum	N Graphite	N Copper Alloy	N CFRP	N Plastic	N Thermoset Plastic	N High Density Plastic	S Nickel / Cobalt	S Titanium Alloy
AlTiN	★	★	★	★	★	☆	☆	☆	☆	☆	☆	☆	☆	☆	☆
Uncoated							☆	☆	★	☆	★	★	★		☆

★ : Priority ☆ : Applicable Materials

Symbol Descriptions Page vii



# 3.00mm SHANK

LEFT HAND MICRO DRILLS

0.85mm - 1.70mm DIAMETER

Mirror Surface Finishes  
Sub Micron Grain Carbide

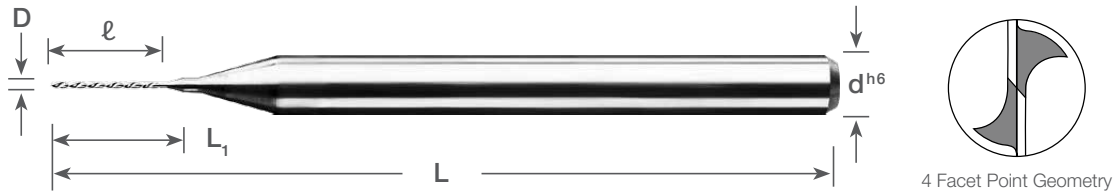

## STANDARD Flute Length

Dimensions (mm)					Uncoated		AlTiN Coating	
D <sup>+0.000mm</sup> -0.008mm	d <sup>h6</sup>	ℓ	L	L <sub>1</sub>	Part Number	Stock	Part Number	Stock
0.85	3	10.20	38	10.40	226L-0335.400	■	226L-0335L400	■
0.86	3	10.20	38	10.40	226L-0339.400	■	226L-0339L400	■
0.87	3	10.20	38	10.40	226L-0343.400	■	226L-0343L400	■
0.88	3	10.20	38	10.40	226L-0346.400	■	226L-0346L400	■
0.89	3	10.20	38	10.40	226L-0350.400	■	226L-0350L400	■
0.90	3	10.20	38	10.40	226L-0354.400	■	226L-0354L400	■
0.91	3	10.20	38	10.40	226L-0358.400	■	226L-0358L400	■
0.92	3	10.20	38	10.40	226L-0362.400	■	226L-0362L400	■
0.93	3	10.20	38	10.40	226L-0366.400	■	226L-0366L400	■
0.94	3	10.20	38	10.40	226L-0370.400	■	226L-0370L400	■
0.95	3	10.20	38	10.40	226L-0374.400	■	226L-0374L400	■
0.96	3	10.20	38	10.40	226L-0378.400	■	226L-0378L400	■
0.97	3	10.20	38	10.40	226L-0382.400	■	226L-0382L400	■
0.98	3	10.20	38	10.40	226L-0386.400	■	226L-0386L400	■
0.99	3	10.20	38	10.40	226L-0390.400	■	226L-0390L400	■
1.00	3	10.20	38	10.40	226L-0394.400	■	226L-0394L400	■
1.05	3	10.20	38	10.40	226L-0413.400	■	226L-0413L400	■
1.10	3	10.20	38	10.40	226L-0433.400	■	226L-0433L400	■
1.15	3	10.20	38	10.40	226L-0453.400	■	226L-0453L400	■
1.20	3	10.20	38	10.40	226L-0472.400	■	226L-0472L400	■
1.25	3	10.20	38	10.40	226L-0492.400	■	226L-0492L400	■
1.30	3	10.20	38	10.40	226L-0512.400	■	226L-0512L400	■
1.35	3	10.20	38	10.40	226L-0531.400	■	226L-0531L400	■
1.40	3	10.20	38	10.40	226L-0551.400	■	226L-0551L400	■
1.45	3	10.20	38	10.40	226L-0571.400	■	226L-0571L400	■
1.50	3	10.20	38	10.40	226L-0591.400	■	226L-0591L400	■
1.55	3	10.20	38	10.40	226L-0610.400	■	226L-0610L400	■
1.60	3	10.20	38	10.40	226L-0630.400	■	226L-0630L400	■
1.65	3	10.20	38	10.40	226L-0650.400	■	226L-0650L400	■
1.70	3	10.20	38	10.40	226L-0669.400	■	226L-0669L400	■

SERIES 226L WORKPIECE MATERIAL															
Coating	P	P	H	H	M	K	N	N	N	N	N	N	N	S	S
	Steel -30HRC	Steel 30-40HRC	Hardened Steel -55HRC	Hardened Steel -68HRC	Stainless Steel	Cast Iron	Aluminum	Graphite	Copper Alloy	CFRP	Plastic	Thermoset Plastic	High Density Plastic	Nickel / Cobalt	Titanium Alloy
AlTiN	★	★	★	★	★	☆	☆	☆	☆	☆	☆	☆	☆	☆	☆
Uncoated							☆	☆	★	☆	★	★			☆

★ : Priority ☆ : Applicable Materials

Symbol Descriptions Page vii

● : U.S. Stock Standard  
■ : NOT STOCKED - Call for Delivery

(U.S.) 1.888.848.8449  
(International) 001.714.428.3636  
Pricing & Availability at [KyoceraPrecisionTools.com](http://KyoceraPrecisionTools.com)

DRILLS A  
END MILLS B  
ROUTERS C  
THREAD MILLS & TAPS D  
ENGRAVERS E  
BORING BARS F  
REAMERS G  
SAWS H  
TECHNICAL I  
INDEX J

# 3.00mm SHANK

LEFT HAND MICRO DRILLS

1.75mm - 3.00mm DIAMETER

Mirror Surface Finishes  
Sub Micron Grain Carbide

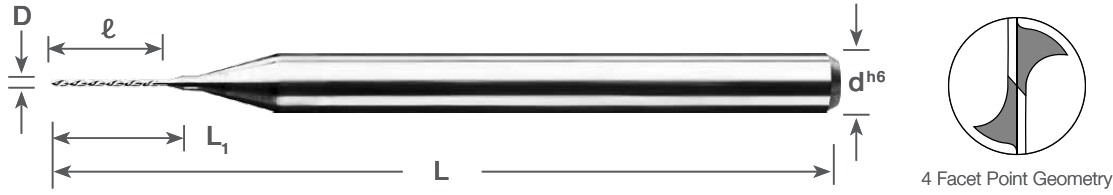

## STANDARD Flute Length

D	Dimensions (mm)					Uncoated		AlTiN Coating	
	D <sup>+0.000mm -0.008mm</sup>	d <sup>h6</sup>	l	L	L <sub>1</sub>	Part Number	Stock	Part Number	Stock
E	1.75	3	10.20	38	10.40	226L-0689.400	■	226L-0689L400	■
	1.80	3	10.20	38	10.40	226L-0709.400	■	226L-0709L400	■
	1.85	3	10.20	38	10.40	226L-0728.400	■	226L-0728L400	■
	1.90	3	10.20	38	10.40	226L-0748.400	■	226L-0748L400	■
	1.95	3	10.20	38	10.40	226L-0768.400	■	226L-0768L400	■
F	2.00	3	10.20	38	10.40	226L-0787.400	■	226L-0787L400	■
	2.05	3	10.20	38	10.40	226L-0807.400	■	226L-0807L400	■
	2.10	3	10.20	38	10.40	226L-0827.400	■	226L-0827L400	■
	2.15	3	10.20	38	10.40	226L-0846.400	■	226L-0846L400	■
	2.20	3	10.20	38	10.40	226L-0866.400	■	226L-0866L400	■
G	2.25	3	10.20	38	10.40	226L-0886.400	■	226L-0886L400	■
	2.30	3	10.20	38	10.40	226L-0906.400	■	226L-0906L400	■
	2.35	3	10.20	38	10.40	226L-0925.400	■	226L-0925L400	■
	2.40	3	10.20	38	10.40	226L-0945.400	■	226L-0945L400	■
	2.45	3	10.20	38	10.40	226L-0965.400	■	226L-0965L400	■
H	2.50	3	10.20	38	10.40	226L-0984.400	■	226L-0984L400	■
	2.55	3	10.20	38	10.40	226L-1004.400	■	226L-1004L400	■
	2.60	3	10.20	38	10.40	226L-1024.400	■	226L-1024L400	■
	2.65	3	10.20	38	10.40	226L-1043.400	■	226L-1043L400	■
	2.70	3	10.20	38	10.40	226L-1063.400	■	226L-1063L400	■
I	2.75	3	10.20	38	10.40	226L-1083.400	■	226L-1083L400	■
	2.80	3	10.20	38	10.40	226L-1102.400	■	226L-1102L400	■
	2.85	3	10.20	38	10.40	226L-1122.400	■	226L-1122L400	■
	2.90	3	10.20	38	10.40	226L-1142.400	■	226L-1142L400	■
	2.95	3	10.20	38	10.40	226L-1161.400	■	226L-1161L400	■
J	3.00	3	10.20	38	10.40	226L-1181.400	■	226L-1181L400	■

SERIES 226L WORKPIECE MATERIAL															
Coating	P	P	H	H	M	K	N	N	N	N	N	N	S	S	
	Steel ~30HRC	Steel 30-40HRC	Hardened Steel ~55HRC	Hardened Steel ~68HRC	Stainless Steel	Cast Iron	Aluminum	Graphite	Copper Alloy	CFRP	Plastic	Thermoset Plastic	High Density Plastic	Nickel / Cobalt	Titanium Alloy
AlTiN	★	★	★	★	★	☆	☆	☆	☆	☆	☆	☆	☆	☆	☆
Uncoated							☆	☆	★	☆	★	★			☆

★ : Priority ☆ : Applicable Materials

Symbol Descriptions Page vii

# 3.00mm SHANK

LEFT HAND MICRO DRILLS

0.75mm - 1.85mm DIAMETER

Mirror Surface Finishes  
Sub Micron Grain Carbide

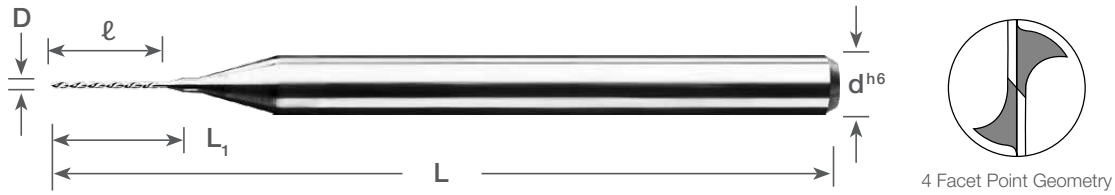

## EXTENDED Flute Length

Dimensions (mm)					Uncoated		AlTiN Coating	
D <sup>+0.000mm -0.008mm</sup>	d <sup>h6</sup>	ℓ	L	L <sub>1</sub>	Part Number	Stock	Part Number	Stock
0.75	3	11.00	50	11.20	226L-0295.433	■	226L-0295L433	■
0.80	3	11.00	50	11.20	226L-0315.433	■	226L-0315L433	■
0.85	3	13.00	50	13.20	226L-0335.512	■	226L-0335L512	■
0.90	3	13.00	50	13.20	226L-0354.512	■	226L-0354L512	■
0.95	3	15.00	50	15.20	226L-0374.591	■	226L-0374L591	■
1.00	3	15.00	50	15.20	226L-0394.591	■	226L-0394L591	■
1.05	3	17.00	50	17.20	226L-0413.670	■	226L-0413L670	■
1.10	3	17.00	50	17.20	226L-0433.670	■	226L-0433L670	■
1.15	3	17.00	50	17.20	226L-0453.670	■	226L-0453L670	■
1.20	3	17.00	50	17.20	226L-0472.670	■	226L-0472L670	■
1.25	3	19.00	50	19.20	226L-0492.749	■	226L-0492L749	■
1.30	3	19.00	50	19.20	226L-0512.749	■	226L-0512L749	■
1.35	3	19.00	50	19.20	226L-0531.749	■	226L-0531L749	■
1.40	3	19.00	50	19.20	226L-0551.749	■	226L-0551L749	■
1.45	3	20.00	50	20.20	226L-0571.788	■	226L-0571L788	■
1.50	3	20.00	50	20.20	226L-0591.788	■	226L-0591L788	■
1.55	3	20.00	50	20.20	226L-0610.788	■	226L-0610L788	■
1.60	3	20.00	50	20.20	226L-0630.788	■	226L-0630L788	■
1.65	3	20.00	50	20.20	226L-0650.788	■	226L-0650L788	■
1.70	3	20.00	50	20.20	226L-0669.788	■	226L-0669L788	■
1.75	3	20.00	50	20.20	226L-0689.788	■	226L-0689L788	■
1.80	3	20.00	50	20.20	226L-0709.788	■	226L-0709L788	■
1.85	3	22.80	50	23.00	226L-0728.898	■	226L-0728L898	■

SERIES 226L WORKPIECE MATERIAL															
Coating	P	P	H	H	M	K	N	N	N	N	N	N	N	S	S
	Steel ~30HRC	Steel 30-40HRC	Hardened Steel ~55HRC	Hardened Steel ~68HRC	Stainless Steel	Cast Iron	Aluminum	Graphite	Copper Alloy	CFRP	Plastic	Thermoset Plastic	High Density Plastic	Nickel / Cobalt	Titanium Alloy
AlTiN	★	★	★	★	★	☆	☆	☆	☆	☆	☆	☆	☆	☆	☆
Uncoated							☆	☆	★	☆	★	★			☆

★ : Priority ☆ : Applicable Materials

Symbol Descriptions Page vii

● : U.S. Stock Standard  
■ : NOT STOCKED - Call for Delivery

(U.S.) 1.888.848.8449  
(International) 001.714.428.3636  
Pricing & Availability at [KyoceraPrecisionTools.com](http://KyoceraPrecisionTools.com)

DRILLS A  
END MILLS B  
ROUTERS C  
THREAD MILLS & TAPS D  
ENGRAVERS E  
BORING BARS F  
REAMERS G  
SAWS H  
TECHNICAL I  
INDEX J

# 3.00mm SHANK

LEFT HAND MICRO DRILLS

1.90mm - 3.00mm DIAMETER

Mirror Surface Finishes  
Sub Micron Grain Carbide

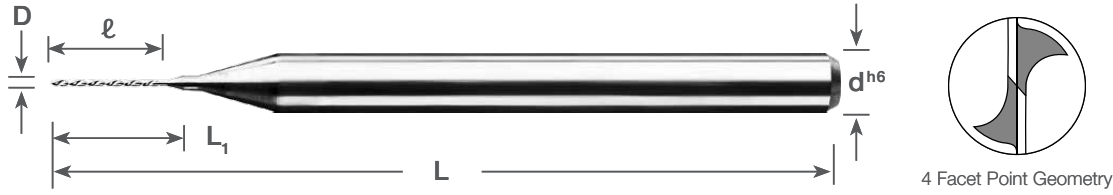

## EXTENDED Flute Length

Dimensions (mm)					Uncoated		AlTiN Coating	
D <sup>+0.000mm</sup> -0.008mm	d <sup>h6</sup>	ℓ	L	L <sub>1</sub>	Part Number	Stock	Part Number	Stock
1.90	3	22.80	60	23.00	226L-0748.898	■	226L-0748L898	■
1.95	3	23.40	60	23.60	226L-0768.945	■	226L-0768L945	■
2.00	3	24.00	60	24.20	226L-0787.945	■	226L-0787L945	■
2.05	3	24.60	60	24.80	226L-0807.992	■	226L-0807L992	■
2.10	3	25.20	60	25.40	226L-0827.992	■	226L-0827L992	■
2.15	3	25.80	60	26.00	226L-0846.1039	■	226L-0846L1039	■
2.20	3	26.40	60	26.60	226L-0866.1039	■	226L-0866L1039	■
2.25	3	27.00	60	27.20	226L-0886.1087	■	226L-0886L1087	■
2.30	3	27.60	60	27.80	226L-0906.1087	■	226L-0906L1087	■
2.35	3	28.20	60	28.40	226L-0925.1134	■	226L-0925L1134	■
2.40	3	28.80	60	29.00	226L-0945.1134	■	226L-0945L1134	■
2.45	3	29.40	60	29.60	226L-0965.1181	■	226L-0965L1181	■
2.50	3	30.00	60	30.20	226L-0984.1181	■	226L-0984L1181	■
2.55	3	30.60	60	30.80	226L-1004.1228	■	226L-1004L1228	■
2.60	3	31.20	60	31.40	226L-1024.1228	■	226L-1024L1228	■
2.65	3	31.80	60	32.00	226L-1043.1276	■	226L-1043L1276	■
2.70	3	32.40	60	32.60	226L-1063.1276	■	226L-1063L1276	■
2.75	3	33.00	60	33.20	226L-1083.1323	■	226L-1083L1323	■
2.80	3	33.60	60	33.80	226L-1102.1323	■	226L-1102L1323	■
2.85	3	34.20	60	34.40	226L-1122.1370	■	226L-1122L1370	■
2.90	3	34.80	60	35.00	226L-1142.1370	■	226L-1142L1370	■
2.95	3	35.40	60	35.60	226L-1161.1417	■	226L-1161L1417	■
3.00	3	36.00	60	36.20	226L-1181.1417	■	226L-1181L1417	■

SERIES 226L WORKPIECE MATERIAL															
Coating	P Steel ~30HRC	P Steel 30-40HRC	H Hardened Steel ~55HRC	H Hardened Steel ~68HRC	M Stainless Steel	K Cast Iron	N Aluminum	N Graphite	N Copper Alloy	N CFRP	N Plastic	N Thermoset Plastic	N High Density Plastic	S Nickel / Cobalt	S Titanium Alloy
AlTiN	★	★	★	★	★	☆	☆	☆	☆	☆	☆	☆	☆	☆	☆
Uncoated							☆	☆	★	☆	★	★	★		☆

★ : Priority ☆ : Applicable Materials

Symbol Descriptions Page vii

# 1/8" SHANK

ULTRA PRECISION MICRO DRILLS  
MACOR® / VESPEL® DRILLING

0.0015" - 0.0040" DIAMETER

Mirror Surface Finishes  
Sub Micron Grain Carbide

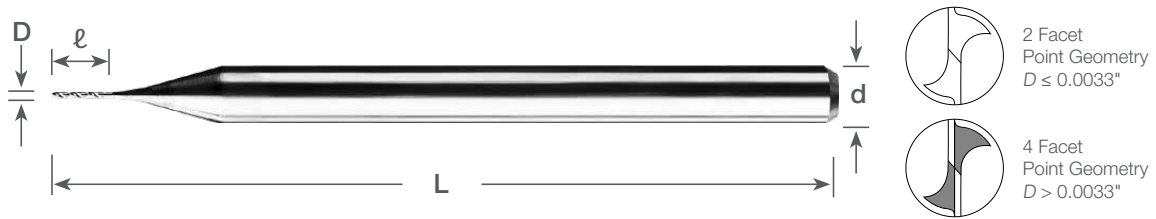

## STANDARD Flute Length

Drill Size	Dimensions (in)				Point Angle	Uncoated	
	D <sup>+0.000000</sup> <sub>-0.000050</sub>	d	ℓ	L		Part Number	Stock
0.05mm	0.0015	1/8	0.0200	1 1/2	90°	390-0015.020	●
	0.0018	1/8	0.0250	1 1/2	90°	390-0018.025	●
	0.0020	1/8	0.0300	1 1/2	90°	390-0020.030	●
	0.0021	1/8	0.0300	1 1/2	90°	390-0021.030	●
	0.0022	1/8	0.0300	1 1/2	90°	390-0022.030	●
0.06mm	0.0023	1/8	0.0300	1 1/2	90°	390-0023.030	●
	0.0024	1/8	0.0300	1 1/2	90°	390-0024.030	●
	0.0025	1/8	0.0400	1 1/2	90°	390-0025.040	●
	0.0026	1/8	0.0400	1 1/2	90°	390-0026.040	●
	0.0027	1/8	0.0500	1 1/2	90°	390-0027.050	●
0.07mm	0.0028	1/8	0.0500	1 1/2	90°	390-0028.050	●
	0.0029	1/8	0.0500	1 1/2	90°	390-0029.050	●
	0.0030	1/8	0.0500	1 1/2	90°	390-0030.050	●
.08mm	0.0031	1/8	0.0500	1 1/2	90°	390-0031.050	●
	0.0032	1/8	0.0500	1 1/2	90°	390-0032.050	●
	0.0033	1/8	0.0500	1 1/2	90°	390-0033.050	●
	0.0034	1/8	0.0500	1 1/2	90°	390-0034.050	●
0.09mm	0.0035	1/8	0.0500	1 1/2	90°	390-0035.050	●
	0.0036	1/8	0.0500	1 1/2	90°	390-0036.050	●
	0.0037	1/8	0.0500	1 1/2	90°	390-0037.050	●
	0.0038	1/8	0.0500	1 1/2	90°	390-0038.050	●
0.10mm	0.0039	1/8	0.0500	1 1/2	90°	390-0039.050	●
	0.0040	1/8	0.0150	1 1/2	90°	390-0040.015	●
0.10mm	0.0040	1/8	0.0250	1 1/2	90°	390-0040.025	●
0.10mm	0.0040	1/8	0.0500	1 1/2	90°	390-0040.050	●
0.10mm	0.0040	1/8	0.0600	1 1/2	130°	390-0040.060	●

SERIES 390 WORKPIECE MATERIAL															
Coating	P	P	H	H	M	K	N	N	N	N	N	N	S	S	
	Steel ~30HRC	Steel 30~40HRC	Hardened Steel ~55HRC	Hardened Steel ~68HRC	Stainless Steel	Cast Iron	Aluminum	Graphite	Copper Alloy	CFRP	Plastic	Thermoset Plastic	High Density Plastic	Nickel / Cobalt	Titanium Alloy
Uncoated							☆	☆	★	☆	★	★	★		☆

★ : Priority ☆ : Applicable Materials

Symbol Descriptions Page vii

● : U.S. Stock Standard  
■ : NOT STOCKED - Call for Delivery

(U.S.) 1.888.848.8449  
(International) 001.714.428.3636  
Pricing & Availability at [KyoceraPrecisionTools.com](http://KyoceraPrecisionTools.com)

DRILLS A  
END MILLS B  
ROUTERS C  
THREAD MILLS & TAPS D  
ENGRAVERS E  
BORING BARS F  
REAMERS G  
SAWS H  
TECHNICAL I  
INDEX J

# 1.00mm SHANK

0.12mm - 0.60mm DIAMETER

Mirror Surface Finishes

Sub Micron Grain Carbide

ULTRA PRECISION MICRO DRILLS  
FUEL INJECTOR / NOZZLE DRILLS



4 Facet Point Geometry



## STANDARD Flute Length

D	Dimensions (mm)				Uncoated		AlTiN Coating	
	$D^{+0.000mm/-0.008mm}$	$d^{h6}$	$l$	$L$	Part Number	Stock	Part Number	Stock
	0.12	1	1.45	25	392-0046.057	●	-	-
	0.14	1	1.45	25	392-0054.057	●	-	-
	0.16	1	1.45	25	392-0063.057	●	-	-
	0.18	1	1.45	25	392-0071.057	●	-	-
	0.20	1	1.45	25	392-0079.057	●	-	-
	0.25	1	1.75	25	392-0098.069	●	392-0098L069	●
	0.27	1	1.75	25	392-0106.069	●	392-0106L069	●
	0.29	1	3.65	25	392-0114.144	●	392-0114L144	●
	0.30	1	3.65	25	392-0118.144	●	392-0118L144	●
	0.31	1	3.65	25	392-0122.144	●	392-0122L144	●
	0.32	1	3.65	25	392-0126.144	●	392-0126L144	●
	0.34	1	3.65	25	392-0134.144	●	392-0134L144	●
	0.36	1	3.65	25	392-0142.144	●	392-0142L144	●
	0.38	1	3.65	25	392-0150.144	●	392-0150L144	●
	0.40	1	3.65	25	392-0157.144	●	392-0157L144	●
	0.42	1	3.65	25	392-0165.144	●	392-0165L144	●
	0.44	1	3.65	25	392-0173.144	●	392-0173L144	●
	0.46	1	3.65	25	392-0181.144	●	392-0181L144	●
	0.48	1	3.65	25	392-0189.144	●	392-0189L144	●
	0.50	1	3.65	25	392-0197.144	●	392-0197L144	●
	0.52	1	3.65	25	392-0205.144	●	392-0205L144	●
	0.54	1	3.65	25	392-0213.144	●	392-0213L144	●
	0.56	1	3.65	25	392-0220.144	●	392-0220L144	●
	0.58	1	3.65	25	392-0228.144	●	392-0228L144	●
	0.60	1	3.65	25	392-0236.144	●	392-0236L144	●

SERIES 392 WORKPIECE MATERIAL															
Coating	P Steel ~30HRC	P Steel 30-40HRC	H Hardened Steel ~55HRC	H Hardened Steel ~68HRC	M Stainless Steel	K Cast Iron	N Aluminum	N Graphite	N Copper Alloy	N CFRP	N Plastic	N Thermoset Plastic	N High Density Plastic	S Nickel / Cobalt	S Titanium Alloy
AlTiN	★	★	★	★	★	☆	☆	☆	☆	☆	☆	☆	☆	☆	☆
Uncoated							☆	☆	★	☆	★	★	★		☆

★ : Priority ☆ : Applicable Materials

Symbol Descriptions Page vii



# 3.00mm SHANK

COOLANT FED MICRO DRILLS  
DEEP HOLE DRILLING PRIORITY



1.50mm - 3.00mm DIAMETER  
Mirror Surface Finishes  
Sub Micron Grain Carbide

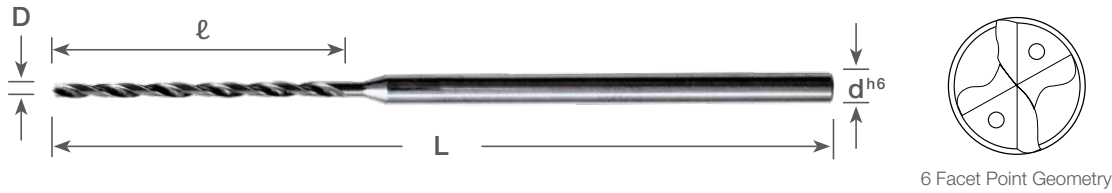

6 Facet Point Geometry



## STANDARD Flute Length

Dimensions (mm)				Uncoated		AlTiN Coating	
D <sup>+0.001mm -0.003mm</sup>	d <sup>h6</sup>	l	L	Part Number	Stock	Part Number	Stock
1.50	3	15.00	60	813-0591.591	●	813-0591L591	●
1.55	3	15.50	60	813-0610.611	●	813-0610L611	●
1.60	3	16.00	60	813-0630.630	●	813-0630L630	●
1.65	3	16.50	60	813-0650.650	●	813-0650L650	●
1.70	3	17.00	60	813-0669.670	●	813-0669L670	●
1.75	3	17.50	60	813-0689.690	●	813-0689L690	●
1.80	3	18.00	60	813-0709.709	●	813-0709L709	●
1.85	3	18.50	60	813-0728.729	●	813-0728L729	●
1.90	3	19.00	60	813-0748.749	●	813-0748L749	●
1.95	3	19.50	60	813-0768.768	●	813-0768L768	●
2.00	3	20.00	60	813-0787.788	●	813-0787L788	●
2.05	3	20.50	60	813-0807.808	●	813-0807L808	●
2.10	3	21.00	62	813-0827.827	●	813-0827L827	●
2.15	3	21.50	62	813-0846.847	●	813-0846L847	●
2.20	3	22.00	62	813-0866.867	●	813-0866L867	●
2.25	3	22.50	62	813-0886.887	●	813-0886L887	●
2.30	3	23.00	62	813-0906.906	●	813-0906L906	●
2.35	3	23.50	62	813-0925.926	●	813-0925L926	●
2.40	3	24.00	64	813-0945.946	●	813-0945L946	●
2.45	3	24.50	64	813-0965.965	●	813-0965L965	●
2.50	3	25.00	64	813-0984.985	●	813-0984L985	●
2.55	3	25.50	64	813-1004.1005	●	813-1004L1005	●
2.60	3	26.00	64	813-1024.1024	●	813-1024L1024	●
2.65	3	26.50	64	813-1043.1044	●	813-1043L1044	●
2.70	3	27.00	66	813-1063.1064	●	813-1063L1064	●
2.75	3	27.50	66	813-1083.1084	●	813-1083L1084	●
2.80	3	28.00	66	813-1102.1103	●	813-1102L1103	●
2.85	3	28.50	66	813-1122.1123	●	813-1122L1123	●
2.90	3	29.00	66	813-1142.1143	●	813-1142L1143	●
2.95	3	29.50	66	813-1161.1162	●	813-1161L1162	●
3.00	3	30.00	66	813-1181.1182	●	813-1181L1182	●

SERIES 813 WORKPIECE MATERIAL															
Coating	P Steel ~30HRC	P Steel 30~40HRC	H Hardened Steel ~55HRC	H Hardened Steel ~68HRC	M Stainless Steel	K Cast Iron	N Aluminum	N Graphite	N Copper Alloy	N CFRP	N Plastic	N Thermoset Plastic	N High Density Plastic	S Nickel / Cobalt	S Titanium Alloy
AlTiN	★	★	★	★	★	☆	☆	☆	☆	☆	☆	☆	☆	★	★
Uncoated	☆	☆	☆	☆	☆	☆	★	☆	☆	☆	☆	☆	☆	☆	☆

★ : Priority ☆ : Applicable Materials

Symbol Descriptions Page vii

● : U.S. Stock Standard  
■ : NOT STOCKED - Call for Delivery

(U.S.) 1.888.848.8449  
(International) 001.714.428.3636  
Pricing & Availability at [KyoceraPrecisionTools.com](http://KyoceraPrecisionTools.com)

DRILLS **A**

END MILLS **B**

ROUTERS **C**

THREAD MILLS & TAPS **D**

ENGRAVERS **E**

BORING BARS **F**

REAMERS **G**

SAWS **H**

TECHNICAL **I**

INDEX **J**

## 3.00mm SHANK



**1.50mm - 3.00mm DIAMETER**

Mirror Surface Finishes

Sub Micron Grain Carbide

**COOLANT FED MICRO DRILLS  
DEEP HOLE DRILLING PRIORITY**



6 Facet Point Geometry

### EXTENDED Flute Length



D	Dimensions (mm)				Uncoated		AlTiN Coating	
	$D^{+0.001mm/-0.003mm}$	$d^{h6}$	$l$	$L$	Part Number	Stock	Part Number	Stock
1.50		3	27.00	77	813-0591.1064	●	813-0591L1064	●
1.55		3	27.90	77	813-0610.1099	●	813-0610L1099	●
1.60		3	28.80	77	813-0630.1135	●	813-0630L1135	●
1.65		3	29.70	77	813-0650.1170	●	813-0650L1170	●
1.70		3	30.60	77	813-0669.1206	●	813-0669L1206	●
1.75		3	31.50	77	813-0689.1241	●	813-0689L1241	●
1.80		3	32.40	84	813-0709.1277	●	813-0709L1277	●
1.85		3	33.30	84	813-0728.1312	●	813-0728L1312	●
1.90		3	34.20	84	813-0748.1347	●	813-0748L1347	●
1.95		3	35.10	84	813-0768.1383	●	813-0768L1383	●
2.00		3	36.00	84	813-0787.1418	●	813-0787L1418	●
2.05		3	36.90	84	813-0807.1454	●	813-0807L1454	●
2.10		3	37.80	91	813-0827.1489	●	813-0827L1489	●
2.15		3	38.70	91	813-0846.1525	●	813-0846L1525	●
2.20		3	39.60	91	813-0866.1560	●	813-0866L1560	●
2.25		3	40.50	91	813-0886.1596	●	813-0886L1596	●
2.30		3	41.40	91	813-0906.1631	●	813-0906L1631	●
2.35		3	42.30	91	813-0925.1667	●	813-0925L1667	●
2.40		3	43.20	91	813-0945.1702	●	813-0945L1702	●
2.45		3	44.10	91	813-0965.1738	●	813-0965L1738	●
2.50		3	45.00	91	813-0984.1773	●	813-0984L1773	●
2.55		3	45.90	91	813-1004.1808	●	813-1004L1808	●
2.60		3	46.80	91	813-1024.1844	●	813-1024L1844	●
2.65		3	47.70	91	813-1043.1879	●	813-1043L1879	●
2.70		3	48.60	104	813-1063.1915	●	813-1063L1915	●
2.75		3	49.50	104	813-1083.1950	●	813-1083L1950	●
2.80		3	50.40	104	813-1102.1986	●	813-1102L1986	●
2.85		3	51.30	104	813-1122.2021	●	813-1122L2021	●
2.90		3	52.20	104	813-1142.2057	●	813-1142L2057	●
2.95		3	53.10	104	813-1161.2092	●	813-1161L2092	●
3.00		3	54.00	104	813-1181.2128	●	813-1181L2128	●

SERIES 813 WORKPIECE MATERIAL															
Coating	P Steel ~30HRC	P Steel 30-40HRC	H Hardened Steel ~55HRC	H Hardened Steel ~68HRC	M Stainless Steel	K Cast Iron	N Aluminum	N Graphite	N Copper Alloy	N CFRP	N Plastic	N Thermoset Plastic	N High Density Plastic	S Nickel / Cobalt	S Titanium Alloy
AlTiN	★	★	★	★	★	☆	☆	☆	☆	☆	☆	☆	☆	★	★
Uncoated	☆	☆	☆	☆	☆	☆	★	☆	☆	☆	☆	☆	☆	☆	☆

★ : Priority ☆ : Applicable Materials

Symbol Descriptions [Page vii](#)

# 4.00mm SHANK

COOLANT FED MICRO DRILLS  
DEEP HOLE DRILLING PRIORITY



**3.05mm - 4.00mm DIAMETER**  
Mirror Surface Finishes  
Sub Micron Grain Carbide

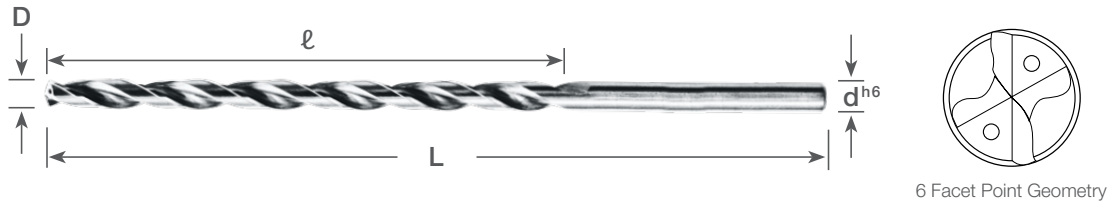

6 Facet Point Geometry



## STANDARD Flute Length

Dimensions (mm)				Uncoated		AlTiN Coating	
$D^{+0.001mm/-0.003mm}$	$d^{h6}$	$l$	$L$	Part Number	Stock	Part Number	Stock
3.05	4	30.50	70	813-1201.1202	●	813-1201L1202	●
3.10	4	31.00	70	813-1220.1221	●	813-1220L1221	●
3.15	4	31.50	70	813-1240.1241	●	813-1240L1241	●
3.20	4	32.00	70	813-1260.1261	●	813-1260L1261	●
3.25	4	32.50	70	813-1280.1281	●	813-1280L1281	●
3.30	4	33.00	70	813-1299.1300	●	813-1299L1300	●
3.35	4	33.50	70	813-1319.1320	●	813-1319L1320	●
3.40	4	34.00	70	813-1339.1340	●	813-1339L1340	●
3.45	4	34.50	70	813-1358.1359	●	813-1358L1359	●
3.50	4	35.00	70	813-1378.1379	●	813-1378L1379	●
3.55	4	35.50	70	813-1398.1399	●	813-1398L1399	●
3.60	4	36.00	70	813-1417.1418	●	813-1417L1418	●
3.65	4	36.50	76	813-1437.1438	●	813-1437L1438	●
3.70	4	37.00	76	813-1457.1458	●	813-1457L1458	●
3.75	4	37.50	76	813-1476.1478	●	813-1476L1478	●
3.80	4	38.00	76	813-1496.1497	●	813-1496L1497	●
3.85	4	38.50	76	813-1516.1517	●	813-1516L1517	●
3.90	4	39.00	76	813-1535.1537	●	813-1535L1537	●
3.95	4	39.50	76	813-1555.1556	●	813-1555L1556	●
4.00	4	40.00	76	813-1575.1576	●	813-1575L1576	●

SERIES 813 WORKPIECE MATERIAL															
Coating	P Steel ~30HRC	P Steel 30-40HRC	H Hardened Steel ~55HRC	H Hardened Steel ~68HRC	M Stainless Steel	K Cast Iron	N Aluminum	N Graphite	N Copper Alloy	N CFRP	N Plastic	N Thermoset Plastic	N High Density Plastic	S Nickel / Cobalt	S Titanium Alloy
AlTiN	★	★	★	★	★	☆	☆	☆	☆	☆	☆	☆	☆	★	★
Uncoated	☆	☆	☆	☆	☆	☆	★	☆	☆	☆	☆	☆	☆	☆	☆

★ : Priority ☆ : Applicable Materials

Symbol Descriptions Page vii

● : U.S. Stock Standard  
■ : NOT STOCKED - Call for Delivery

(U.S.) 1.888.848.8449  
(International) 001.714.428.3636  
Pricing & Availability at [KyoceraPrecisionTools.com](http://KyoceraPrecisionTools.com)

DRILLS **A**

END MILLS **B**

ROUTERS **C**

THREAD MILLS & TAPS **D**

ENGRAVERS **E**

BORING BARS **F**

REAMERS **G**

SAWS **H**

TECHNICAL **I**

INDEX **J**

# 4.00mm SHANK



3.05mm - 4.00mm DIAMETER

Mirror Surface Finishes  
Sub Micron Grain Carbide

COOLANT FED MICRO DRILLS  
DEEP HOLE DRILLING PRIORITY

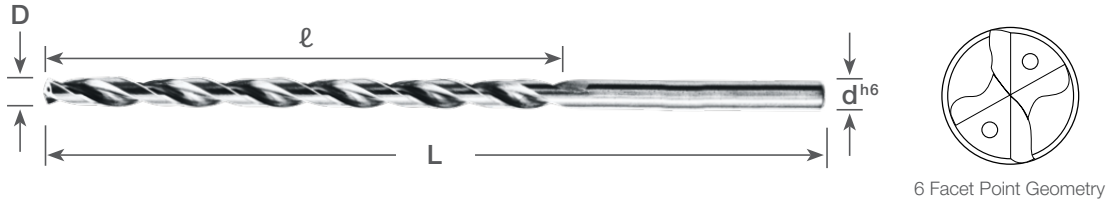

## EXTENDED Flute Length

Dimensions (mm)				Uncoated		AlTiN Coating	
D <sup>+0.001mm -0.003mm</sup>	d <sup>h6</sup>	ℓ	L	Part Number	Stock	Part Number	Stock
3.05	4	54.90	104	813-1201.2163	●	813-1201L2163	●
3.10	4	55.80	104	813-1220.2199	●	813-1220L2199	●
3.15	4	56.70	104	813-1240.2234	■	813-1240L2234	■
3.20	4	57.60	104	813-1260.2269	●	813-1260L2269	●
3.25	4	58.50	104	813-1280.2305	■	813-1280L2305	■
3.30	4	59.40	104	813-1299.2340	●	813-1299L2340	●
3.35	4	60.30	104	813-1319.2376	■	813-1319L2376	■
3.40	4	61.20	104	813-1339.2411	●	813-1339L2411	●
3.45	4	62.10	104	813-1358.2447	■	813-1358L2447	■
3.50	4	63.00	104	813-1378.2482	●	813-1378L2482	●
3.55	4	63.90	104	813-1398.2518	■	813-1398L2518	■
3.60	4	64.80	104	813-1417.2553	●	813-1417L2553	●
3.65	4	65.70	104	813-1437.2589	■	813-1437L2589	■
3.70	4	66.60	104	813-1457.2624	●	813-1457L2624	●
3.75	4	67.50	104	813-1476.2660	■	813-1476L2660	■
3.80	4	68.40	104	813-1496.2695	●	813-1496L2695	●
3.85	4	69.30	104	813-1516.2730	■	813-1516L2730	■
3.90	4	70.20	104	813-1535.2766	●	813-1535L2766	●
3.95	4	71.10	104	813-1555.2801	■	813-1555L2801	■
4.00	4	72.00	104	813-1575.2837	●	813-1575L2837	●

SERIES 813 WORKPIECE MATERIAL															
Coating	P Steel ~30HRC	P Steel 30-40HRC	H Hardened Steel ~55HRC	H Hardened Steel ~68HRC	M Stainless Steel	K Cast Iron	N Aluminum	N Graphite	N Copper Alloy	N CFRP	N Plastic	N Thermoset Plastic	N High Density Plastic	S Nickel / Cobalt	S Titanium Alloy
AlTiN	★	★	★	★	★	☆	☆	☆	☆	☆	☆	☆	☆	★	★
Uncoated	☆	☆	☆	☆	☆	☆	★	☆	☆	☆	☆	☆	☆	☆	☆

★ : Priority ☆ : Applicable Materials

Symbol Descriptions Page vii

# HYDROS INCH SHANK

COOLANT FED DEEP DRILLS  
DEEP HOLE DRILLING PRIORITY  
Excellent for Difficult-to-Cut Materials



**0.1250" - 0.5000" DIAMETER**  
Sub Micron Grain Carbide  
Superior Hole Wall Surface Finishes  
Double Margin Design  
Straight Through Drilling Without Pecking  
Matching Pilot Drills

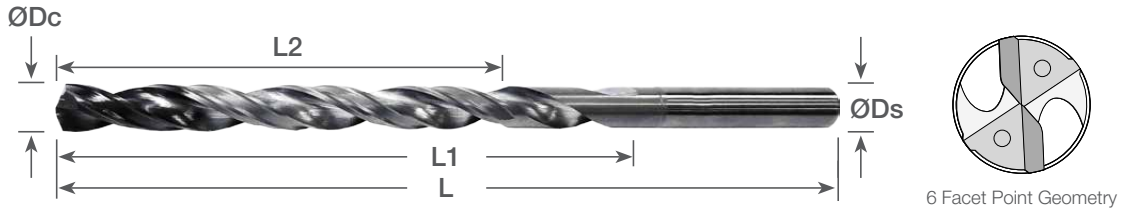

## HYDROS Coolant Fed Deep Drill



Dimensions (in)					Point Angle	AlTiN Nano	
ØDc	ØDs	L	L1	*L2		Part Number	Stock
0.1250 (1/8)	0.1250	3 1/2	1.6250	1.2500	135°	860-1250AG1625	●
0.1406 (9/64)	0.1875	4	1.8280	1.4060	135°	860-1406AG1828	●
0.1563 (5/32)	0.1875	4	2.0310	1.5630	135°	860-1563AG2031	●
0.1719 (11/64)	0.1875	4	2.2340	1.7190	135°	860-1719AG2234	●
0.1875 (3/16)	0.1875	4 1/2	2.4380	1.8750	135°	860-1875AG2438	●
0.2031 (13/64)	0.2500	4 1/2	2.6410	2.0310	135°	860-2031AG2641	●
0.2188 (7/32)	0.2500	5	2.8440	2.1880	135°	860-2188AG2844	●
0.2344 (15/64)	0.2500	5	3.0470	2.3440	135°	860-2344AG3047	●
0.2500 (1/4)	0.2500	5	3.2500	2.5000	135°	860-2500AG3250	●
0.2570 (F)	0.3125	5 1/2	3.3410	2.5700	135°	860-2570AG3341	●
0.2656 (17/64)	0.3125	5 1/2	3.4530	2.6560	135°	860-2656AG3453	●
0.2813 (9/32)	0.3125	5 1/2	3.6560	2.8130	135°	860-2813AG3656	●
0.3125 (5/16)	0.3125	6	4.0630	3.1250	135°	860-3125AG4063	●
0.3320 (Q)	0.3750	6 1/2	4.3160	3.3200	135°	860-3320AG4316	●
0.3438 (11/32)	0.3750	6 1/2	4.4690	3.4380	135°	860-3438AG4469	●
0.3750 (3/8)	0.3750	7	4.8750	3.7500	135°	860-3750AG4875	●
0.4219 (27/64)	0.4375	7 1/2	5.4840	4.2190	135°	860-4219AG5484	●
0.4375 (7/16)	0.4375	7 1/2	5.6880	4.3750	135°	860-4375AG5688	●
0.4531 (29/64)	0.5000	8	5.8910	4.5310	135°	860-4531AG5891	●
0.5000 (1/2)	0.5000	8 1/2	6.5000	5.0000	135°	860-5000AG6500	●

\*L2 dimensions refers to the Max. length of cut (10 x ØDc).

Match with ORION Pilot Drills Series 160 [Page A14](#)

### Cutting Diameter Tolerance

Cutting Dia. (ØDc)	0.1250" - 0.2344"	0.2500" - 0.3750"	0.4219" - 0.5000"
Tolerance + / -	+0.00000"/-0.00032"	+0.00000"/-0.00035"	+0.00000"/-0.00043"

### Shank Tolerance

Shank Dia. (ØDs)	0.1250" - 0.2500"	0.3125" - 0.3750"	0.4375" - 0.5000"
Tolerance + / -	+0.00000"/-0.00032"	+0.00000"/-0.00035"	+0.00000"/-0.00043"

### SERIES 860 WORKPIECE MATERIAL

Coating	P	P	H	H	M	K	N	N	N	N	N	N	S	S	
	Steel ~30HRC	Steel 30~40HRC	Hardened Steel ~55HRC	Hardened Steel ~68HRC	Stainless Steel	Cast Iron	Aluminum	Graphite	Copper Alloy	CFRP	Plastic	Thermoset Plastic	High Density Plastic	Nickel / Cobalt	Titanium Alloy
AlTiN Nano	★	★	★	★	★	☆		☆	☆		☆	☆	☆	★	★

★ : Priority ☆ : Applicable Materials

Symbol Descriptions [Page vii](#)

● : U.S. Stock Standard  
■ : NOT STOCKED - Call for Delivery

(U.S.) 1.888.848.8449  
(International) 001.714.428.3636  
Pricing & Availability at [KyoceraPrecisionTools.com](http://KyoceraPrecisionTools.com)

DRILLS A  
END MILLS B  
ROUTERS C  
THREAD MILLS & TAPS D  
ENGRAVERS E  
BORING BARS F  
REAMERS G  
SAWS H  
TECHNICAL I  
INDEX J

## HYDROS METRIC SHANK

**COOLANT FED DEEP DRILLS**  
**DEEP HOLE DRILLING PRIORITY**  
 Excellent for Difficult-to-Cut Materials



**3.00mm - 4.10mm DIAMETER**  
 Sub Micron Grain Carbide  
 Superior Hole Wall Surface Finishes  
 Double Margin Design  
 Straight Through Drilling Without Pecking  
 Matching Pilot Drills

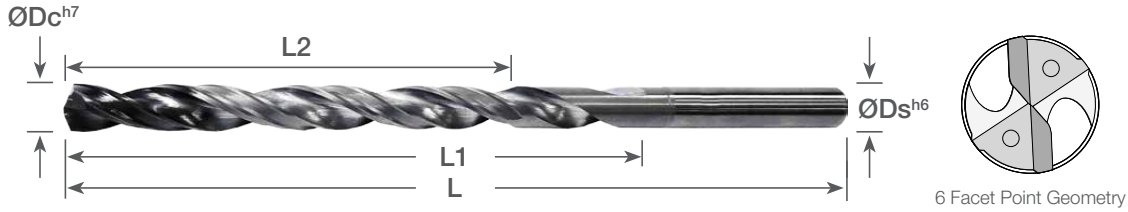

6 Facet Point Geometry



### HYDROS Coolant Fed Deep Drill

Dimensions (mm)					Point Angle	AlTiN Nano	
$D^{h7}$	$d^{h6}$	L	L1	*L2		Part Number	Stock
3.00	3	90	39.0	30	135°	865-1181AG1535	●
3.10	4	90	40.3	31	135°	865-1220AG1587	●
3.20	4	90	41.6	32	135°	865-1260AG1638	●
3.30	4	90	42.9	33	135°	865-1299AG1689	●
3.40	4	90	44.2	34	135°	865-1339AG1740	●
3.50	4	90	45.5	35	135°	865-1378AG1791	●
3.60	4	90	46.8	36	135°	865-1417AG1843	●
3.70	4	100	48.1	37	135°	865-1457AG1894	●
3.80	4	100	49.4	38	135°	865-1496AG1945	●
3.90	4	100	50.7	39	135°	865-1535AG1996	●
4.00	4	100	52.0	40	135°	865-1575AG2047	●
4.10	6	100	53.3	41	135°	865-1614AG2098	●

\*L2 dimensions refers to the Max. length of cut (10 x ØDc).

Match with ORION Pilot Drills **Series 165** [Page A15](#)

SERIES 865 WORKPIECE MATERIAL															
Coating	P	P	H	H	M	K	N	N	N	N	N	S	S		
	Steel ~30HRC	Steel 30-40HRC	Hardened Steel ~55HRC	Hardened Steel ~68HRC	Stainless Steel	Cast Iron	Aluminum	Graphite	Copper Alloy	CFRP	Plastic	Thermoset Plastic	High Density Plastic	Nickel / Cobalt	Titanium Alloy
AlTiN Nano	★	★	★	★	★	☆		☆	☆		☆	☆	☆	★	★

★ : Priority ☆ : Applicable Materials

Symbol Descriptions [Page vii](#)

## HYDROS METRIC SHANK

**COOLANT FED DEEP DRILLS**  
**DEEP HOLE DRILLING PRIORITY**  
 Excellent for Difficult-to-Cut Materials



**4.20mm - 6.80mm DIAMETER**  
 Sub Micron Grain Carbide  
 Superior Hole Wall Surface Finishes  
 Double Margin Design  
 Straight Through Drilling Without Pecking  
 Matching Pilot Drills

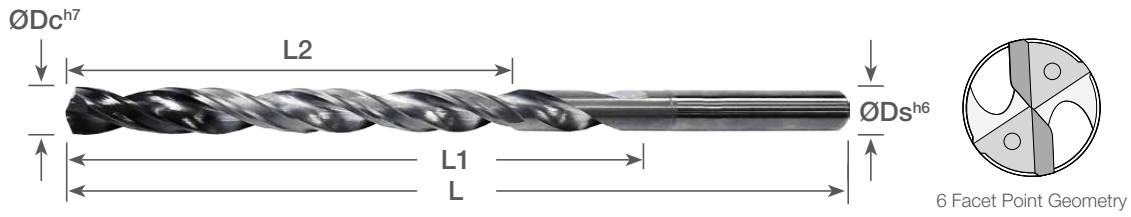

### HYDROS Coolant Fed Deep Drill



Dimensions (mm)					Point Angle	AlTiN Nano	
ØDc <sup>h7</sup>	ØDs <sup>h6</sup>	L	L1	*L2		Part Number	Stock
4.20	6	110	54.6	42	135°	865-1654AG2150	●
4.30	6	110	55.9	43	135°	865-1693AG2201	●
4.40	6	110	57.2	44	135°	865-1732AG2252	●
4.50	6	110	58.5	45	135°	865-1772AG2303	●
4.60	6	110	59.8	46	135°	865-1811AG2354	●
4.70	6	110	61.1	47	135°	865-1850AG2406	●
4.80	6	110	62.4	48	135°	865-1890AG2457	●
4.90	6	110	63.7	49	135°	865-1929AG2508	●
5.00	6	110	65.0	50	135°	865-1969AG2559	●
5.10	6	120	66.3	51	135°	865-2008AG2610	●
5.20	6	120	67.6	52	135°	865-2047AG2661	●
5.30	6	120	68.9	53	135°	865-2087AG2713	●
5.40	6	120	70.2	54	135°	865-2126AG2764	●
5.50	6	120	71.5	55	135°	865-2165AG2815	●
5.60	6	120	72.8	56	135°	865-2205AG2866	●
5.70	6	120	74.1	57	135°	865-2244AG2917	●
5.80	6	120	75.4	58	135°	865-2283AG2969	●
5.90	6	120	76.7	59	135°	865-2323AG3020	●
6.00	6	130	78.0	60	135°	865-2362AG3071	●
6.10	8	130	79.3	61	135°	865-2402AG3122	●
6.20	8	130	80.6	62	135°	865-2441AG3173	●
6.30	8	130	81.9	63	135°	865-2480AG3224	●
6.40	8	130	83.2	64	135°	865-2520AG3276	●
6.50	8	140	84.5	65	135°	865-2559AG3327	●
6.60	8	140	85.8	66	135°	865-2598AG3378	●
6.70	8	140	87.1	67	135°	865-2638AG3429	●
6.80	8	140	88.4	68	135°	865-2677AG3480	●

\*L2 dimensions refers to the Max. length of cut (10 x ØDc).

Match with ORION Pilot Drills **Series 165** [Page A16](#)

SERIES 865 WORKPIECE MATERIAL															
Coating	P	P	H	H	M	K	N	N	N	N	N	N	S	S	
	Steel ~30HRC	Steel 30-40HRC	Hardened Steel ~55HRC	Hardened Steel ~68HRC	Stainless Steel	Cast Iron	Aluminum	Graphite	Copper Alloy	CFRP	Plastic	Thermoset Plastic	High Density Plastic	Nickel / Cobalt	Titanium Alloy
AlTiN Nano	★	★	★	★	★	☆		☆	☆		☆	☆	☆	★	★

★ : Priority ☆ : Applicable Materials

Symbol Descriptions [Page vii](#)

● : U.S. Stock Standard  
 ■ : NOT STOCKED - Call for Delivery

(U.S.) 1.888.848.8449  
 (International) 001.714.428.3636  
 Pricing & Availability at [KyoceraPrecisionTools.com](http://KyoceraPrecisionTools.com)

DRILLS **A**  
 END MILLS **B**  
 ROUTERS **C**  
 THREAD MILLS & TAPS **D**  
 ENGRAVERS **E**  
 BORING BARS **F**  
 REAMERS **G**  
 SAWS **H**  
 TECHNICAL **I**  
 INDEX **J**



## HYDROS METRIC SHANK

**COOLANT FED DEEP DRILLS**  
**DEEP HOLE DRILLING PRIORITY**  
 Excellent for Difficult-to-Cut Materials



**6.90mm - 9.50mm DIAMETER**  
 Sub Micron Grain Carbide  
 Superior Hole Wall Surface Finishes  
 Double Margin Design  
 Straight Through Drilling Without Pecking  
 Matching Pilot Drills

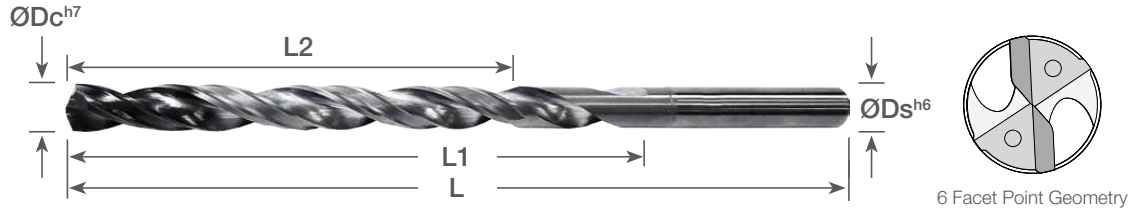

6 Facet Point Geometry

### HYDROS Coolant Fed Deep Drill



Dimensions (mm)					Point Angle	AlTiN Nano	
$D^{h7}$	$d^{h6}$	L	L1	*L2		Part Number	Stock
6.90	8	140	89.7	69	135°	865-2717AG3531	●
7.00	8	140	91.0	70	135°	865-2756AG3583	●
7.10	8	140	92.3	71	135°	865-2795AG3634	●
7.20	8	140	93.6	72	135°	865-2835AG3685	●
7.30	8	140	94.9	73	135°	865-2874AG3736	●
7.40	8	150	96.2	74	135°	865-2913AG3787	●
7.50	8	150	97.5	75	135°	865-2953AG3839	●
7.60	8	150	98.8	76	135°	865-2992AG3890	●
7.70	8	150	100.1	77	135°	865-3031AG3941	●
7.80	8	150	101.4	78	135°	865-3071AG3992	●
7.90	8	150	102.7	79	135°	865-3110AG4043	●
8.00	8	150	104.0	80	135°	865-3150AG4094	●
8.10	10	160	105.3	81	135°	865-3189AG4146	●
8.20	10	160	106.6	82	135°	865-3228AG4197	●
8.30	10	160	107.9	83	135°	865-3268AG4248	●
8.40	10	160	109.2	84	135°	865-3307AG4299	●
8.50	10	160	110.5	85	135°	865-3346AG4350	●
8.60	10	160	111.8	86	135°	865-3386AG4402	●
8.70	10	160	113.1	87	135°	865-3425AG4453	●
8.80	10	170	114.4	88	135°	865-3465AG4504	●
8.90	10	170	115.7	89	135°	865-3504AG4555	●
9.00	10	170	117.0	90	135°	865-3543AG4606	●
9.10	10	170	118.3	91	135°	865-3583AG4657	●
9.20	10	170	119.6	92	135°	865-3622AG4709	●
9.30	10	170	120.9	93	135°	865-3661AG4760	●
9.40	10	170	122.2	94	135°	865-3701AG4811	●
9.50	10	170	123.5	95	135°	865-3740AG4862	●

\*L2 dimensions refers to the Max. length of cut (10 x ØDc).

Match with ORION Pilot Drills **Series 165** [Page A17](#)

#### SERIES 865 WORKPIECE MATERIAL

Coating	P Steel ~30HRC	P Steel 30~40HRC	H Hardened Steel ~55HRC	H Hardened Steel ~68HRC	M Stainless Steel	K Cast Iron	N Aluminum	N Graphite	N Copper Alloy	N CFRP	N Plastic	N Thermoset Plastic	N High Density Plastic	S Nickel / Cobalt	S Titanium Alloy
AlTiN Nano	★	★	★	★	★	☆	☆	☆	☆	☆	☆	☆	☆	★	★

★ : Priority ☆ : Applicable Materials

Symbol Descriptions [Page vii](#)

## HYDROS METRIC SHANK

**COOLANT FED DEEP DRILLS**  
**DEEP HOLE DRILLING PRIORITY**  
 Excellent for Difficult-to-Cut Materials



**9.60mm - 12.00mm DIAMETER**  
 Sub Micron Grain Carbide  
 Superior Hole Wall Surface Finishes  
 Double Margin Design  
 Straight Through Drilling Without Pecking  
 Matching Pilot Drills

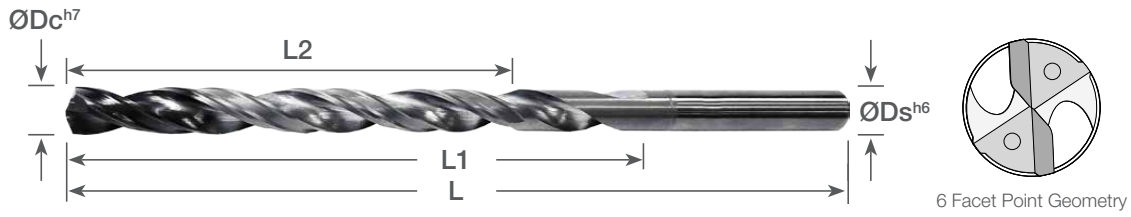

### HYDROS Coolant Fed Deep Drill



Dimensions (mm)					Point Angle	AlTiN Nano	
D <sup>h7</sup>	d <sup>h6</sup>	L	L1	*L2		Part Number	Stock
9.60	10	180	124.8	96	135°	865-3780AG4913	●
9.70	10	180	126.1	97	135°	865-3819AG4965	●
9.80	10	180	127.4	98	135°	865-3858AG5016	●
9.90	10	180	128.7	99	135°	865-3898AG5067	●
10.00	10	180	130.0	100	135°	865-3937AG5118	●
10.10	12	180	131.3	101	135°	865-3976AG5169	●
10.20	12	190	132.6	102	135°	865-4016AG5220	●
10.30	12	190	133.9	103	135°	865-4055AG5272	●
10.40	12	190	135.2	104	135°	865-4094AG5323	●
10.50	12	190	136.5	105	135°	865-4134AG5374	●
10.60	12	190	137.8	106	135°	865-4173AG5425	●
10.70	12	190	139.1	107	135°	865-4213AG5476	●
10.80	12	190	140.4	108	135°	865-4252AG5528	●
10.90	12	190	141.7	109	135°	865-4291AG5579	●
11.00	12	200	143.0	110	135°	865-4331AG5630	●
11.10	12	200	144.3	111	135°	865-4370AG5681	●
11.20	12	200	145.6	112	135°	865-4409AG5732	●
11.30	12	200	146.9	113	135°	865-4449AG5783	●
11.40	12	200	148.2	114	135°	865-4488AG5835	●
11.50	12	200	149.5	115	135°	865-4528AG5886	●
11.60	12	200	150.8	116	135°	865-4567AG5937	●
11.70	12	200	152.1	117	135°	865-4606AG5988	●
11.80	12	200	153.4	118	135°	865-4646AG6039	●
11.90	12	210	154.7	119	135°	865-4685AG6091	●
12.00	12	210	156.0	120	135°	865-4724AG6142	●

\*L2 dimensions refers to the Max. length of cut (10 x ØDc).

Match with ORION Pilot Drills **Series 165** [Page A18](#)

SERIES 865 WORKPIECE MATERIAL															
Coating	P	P	H	H	M	K	N	N	N	N	N	S	S		
	Steel ~30HRC	Steel 30-40HRC	Hardened Steel ~55HRC	Hardened Steel ~68HRC	Stainless Steel	Cast Iron	Aluminum	Graphite	Copper Alloy	CFRP	Plastic	Thermoset Plastic	High Density Plastic	Nickel / Cobalt	Titanium Alloy
AlTiN Nano	★	★	★	★	★	☆		☆	☆		☆	☆	☆	★	★

★ : Priority ☆ : Applicable Materials

Symbol Descriptions [Page vii](#)

● : U.S. Stock Standard  
 ■ : NOT STOCKED - Call for Delivery

(U.S.) 1.888.848.8449  
 (International) 001.714.428.3636  
 Pricing & Availability at [KyoceraPrecisionTools.com](http://KyoceraPrecisionTools.com)

# 3.00mm SHANK

MICRO DRILLS FOR BRASS

0.30mm - 2.00mm DIAMETER

Mirror Surface Finishes  
Sub Micron Grain Carbide  
Single Flute

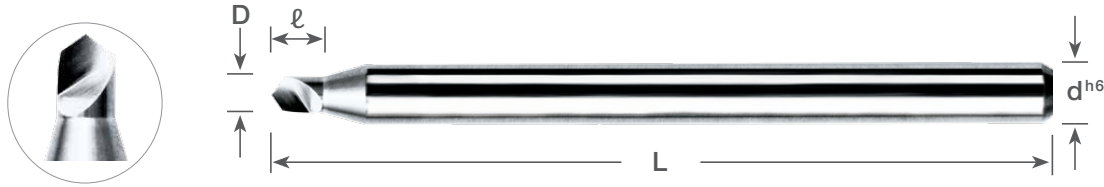

## STANDARD Length

D	Dimensions (mm)				Uncoated		TiCN Coating	
	$D^{+0.000mm/-0.008mm}$	$d^{h6}$	$\ell$	L	Part Number	Stock	Part Number	Stock
	0.30	3	1.65	38	885-0118.065	●	885-0118C065	●
	0.35	3	1.65	38	885-0138.065	●	885-0138C065	●
	0.40	3	1.65	38	885-0157.065	●	885-0157C065	●
	0.45	3	1.65	38	885-0177.065	●	885-0177C065	●
	0.50	3	2.15	38	885-0197.085	●	885-0197C085	●
	0.55	3	2.15	38	885-0217.085	●	885-0217C085	●
	0.60	3	2.15	38	885-0236.085	●	885-0236C085	●
	0.65	3	2.15	38	885-0256.085	●	885-0256C085	●
	0.70	3	2.15	38	885-0276.085	●	885-0276C085	●
	0.75	3	2.15	38	885-0295.085	●	885-0295C085	●
	0.80	3	2.15	38	885-0315.085	●	885-0315C085	●
	0.85	3	2.15	38	885-0335.085	●	885-0335C085	●
	0.90	3	2.15	38	885-0354.085	●	885-0354C085	●
	0.95	3	2.15	38	885-0374.085	●	885-0374C085	●
	1.00	3	2.15	38	885-0394.085	●	885-0394C085	●
	1.10	3	2.85	38	885-0433.112	●	885-0433C112	●
	1.20	3	2.85	38	885-0472.112	●	885-0472C112	●
	1.30	3	2.85	38	885-0512.112	●	885-0512C112	●
	1.40	3	2.85	38	885-0551.112	●	885-0551C112	●
	1.50	3	2.85	38	885-0591.112	●	885-0591C112	●
	1.60	3	2.85	38	885-0630.112	●	885-0630C112	●
	1.70	3	2.85	38	885-0669.112	●	885-0669C112	●
	1.80	3	2.85	38	885-0709.112	●	885-0709C112	●
	1.90	3	2.85	38	885-0748.112	●	885-0748C112	●
	2.00	3	2.85	38	885-0787.112	●	885-0787C112	●

SERIES 885 WORKPIECE MATERIAL															
Coating	P Steel ~30HRC	P Steel 30-40HRC	H Hardened Steel ~55HRC	H Hardened Steel ~68HRC	M Stainless Steel	K Cast Iron	N Aluminum	N Graphite	N Copper Alloy	N CFRP	N Plastic	N Thermoset Plastic	N High Density Plastic	S Nickel / Cobalt	S Titanium Alloy
TiCN	☆	☆	☆	☆	☆	☆	☆	☆	★					☆	☆
Uncoated	☆	☆	☆	☆	★	★	☆	☆	★		☆	☆	☆	★	★

★ : Priority ☆ : Applicable Materials

Symbol Descriptions [Page vii](#)

SQUARE END MILLS				B3 - B34
SERIES 1610	2 Flute	Standard Length	Dia. 0.0040"-0.3750" / 0.10mm-6.00mm	B3 - B6
SERIES 1620	2 Flute	Stub Length	Dia. 0.0040"-0.2500" / 0.10mm-6.00mm	B7 - B10
SERIES 1640	2 Flute	Extended Reach	Dia. 0.0100"-0.1250" / 0.40mm-6.00mm	B11 - B13
*TITAN-AX	3 Flute	Reinforced Shank	Dia. 0.0312"-0.2500" / 1.00mm-8.00mm	B14 - B15
SERIES 1710	3 Flute	Standard Length	Dia. 0.0100"-0.1250"	B16 - B17
SERIES 1740	3 Flute	Extended Length	Dia. 0.0100"-0.2500"	B18 - B19
SERIES 1742	3 Flute	Extended Reach Stub Length	Dia. 0.0100"-0.2500"	B20 - B24
SERIES 1810	4 Flute	Standard Length	Dia. 0.0050"-0.2500" / 0.10mm-6.00mm	B25 - B28
SERIES 1820	4 Flute	Stub Length	Dia. 0.0050"-0.2500" / 0.10mm-6.00mm	B29 - B31
SERIES 1840	4 Flute	Extended Reach	Dia. 0.0100"-0.1250" / 0.40mm-6.00mm	B32 - B34

BALL NOSE END MILLS				B35 - B64
SERIES 1625	2 Flute	Standard Length	Dia. 0.0050"-0.2500" / 0.10mm-6.00mm	B35 - B38
SERIES 1635	2 Flute	Stub Length	Dia. 0.0050"-0.2500" / 0.10mm-6.00mm	B39 - B41
SERIES 1645	2 Flute	Extended Reach	Dia. 0.0100"-0.1250" / 0.40mm-6.00mm	B42 - B44
SERIES 1685	2 Flute	Reverse Shank	Dia. 0.1563"-0.7500"	B45
*16 HMS	2 Flute	Hard Metal Milling Stub Length	Dia. 0.20mm-3.00mm	B46
*16 HMR	2 Flute	Hard Metal Milling Extended Reach	Dia. 0.20mm-3.00mm	B47
*16 RB	2 Flute	Rib Processing Extended Reach	Radius 0.50mm-1.50mm	B48
SERIES 1725	3 Flute	Standard Length	Dia. 0.0100"-0.1000"	B49
SERIES 1745	3 Flute	Extended Reach	Dia. 0.0100"-0.1000"	B50
SERIES 1755	3 Flute	Extended Reach Stub Length	Dia. 0.0100"-0.2500"	B51 - B54
SERIES 1825	4 Flute	Standard Length	Dia. 0.0100"-0.2500" / 0.40mm-6.00mm	B55 - B58
SERIES 1835	4 Flute	Stub Length	Dia. 0.0100"-0.2500" / 0.40mm-6.00mm	B59 - B61
SERIES 1845	4 Flute	Extended Reach	Dia. 0.0100"-0.1250" / 0.40mm-6.00mm	B62 - B64

CORNER RADIUS END MILLS				B65 - B86
SERIES 1611	2 Flute	Standard Length X-Small Corner Radius	Dia. 0.0500"-0.1000"	B65
SERIES 1612	2 Flute	Standard Length Small Corner Radius	Dia. 0.0150"-0.2500"	B66
SERIES 1613	2 Flute	Standard Length Standard Corner Radius	Dia. 0.0156"-0.2500"	B67
SERIES 1614	2 Flute	Standard Length Large Corner Radius	Dia. 0.0450"-0.2500"	B68
SERIES 1616	2 Flute	Standard Length X-Large Corner Radius	Dia. 0.0625"-0.5000"	B68
SERIES 1617	2 Flute	Standard Length XX-Large Corner Radius	Dia. 0.0938"-0.2500"	B69
SERIES 1618	2 Flute	Standard Length XXX-Large Corner Radius	Dia. 0.1875"-0.5000"	B69
*SERIES 1703	3 Flute	Standard Length High Helix Corner Radius	Dia. 1.00mm-6.00mm	B70
*TITAN-AX	3 Flute	Reinforced Shank	Dia. 0.0312"-0.2500" / 1.00mm-8.00mm	B71 - B73

\* High Performance End Mills.  
See product page for high performance features.

(Continued on Next Page)

# END MILLS (CONTINUED)

## B1 - B89

CORNER RADIUS END MILLS (CONTINUED)				B65 - B86
SERIES 1743	3 Flute	Extended Reach Small Corner Radius	Dia. 0.0156"-0.2500"	B74
SERIES 1744	3 Flute	Extended Reach Standard Corner Radius	Dia. 0.0312"-0.2500"	B75
SERIES 1746	3 Flute	Extended Reach Large Corner Radius	Dia. 0.0625"-0.1250"	B76
*SERIES 1804	4 Flute	High Helix Corner Radius Standard Length	Dia. 1.00mm-6.00mm	B77
SERIES 1812	4 Flute	Standard Length Small Corner Radius	Dia. 0.0150"-0.2500"	B78
SERIES 1813	4 Flute	Standard Length Standard Corner Radius	Dia. 0.0156"-0.2500"	B79
SERIES 1814	4 Flute	Standard Length Large Corner Radius	Dia. 0.0450"-0.2500"	B80
SERIES 1816	4 Flute	Standard Length X-Large Corner Radius	Dia. 0.0625"-0.2500"	B80
SERIES 1817	4 Flute	Standard Length XX-Large Corner Radius	Dia. 0.0938"-0.2500"	B81
SERIES 1818	4 Flute	Standard Length XXX-Large Corner Radius	Dia. 0.1875"-0.2500"	B81
*APOLLO AP4	4 Flute	Variable Helix End Mills	Dia. 0.1250"-1.0000" / 3mm-25mm	B82 - B83
*SERIES 1905	5 Flute	High Helix Corner Radius Standard Length	Dia. 1.00mm-6.00mm	B84
*APOLLO AP5	5 Flute	Variable Helix End Mills	Dia. 0.2500"-1.0000" / 4mm-25mm	B85 - B86

COMPRESSION END MILLS <span style="color: red; font-weight: bold;">NEW</span>			B87
SERIES 1890	VULCAN Compression End Mills	Dia. 0.2500"-0.500" / 6mm-12mm	B87

CHAMFER MILLS			B88 - B89
SERIES CM	1/8" Shank	Chamfer Mills	B88
SERIES CMM	Metric	Chamfer Mills	B89

\* High Performance End Mills.  
See product page for high performance features.

## 2 FLUTE

STANDARD LENGTH SQUARE END MILLS  
GENERAL PURPOSE MACHINING

0.0040" - 0.0310" DIAMETER

Mirror Surface Finishes

Sub Micron Grain Carbide

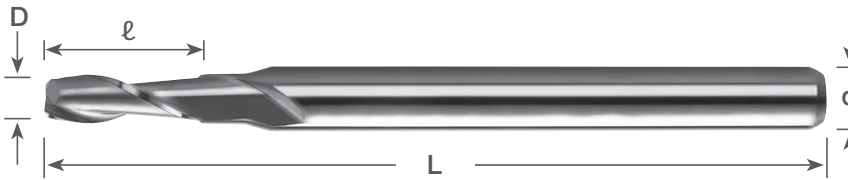

### STANDARD Length (Inch Sizes)

Dimensions (in)				Uncoated		AlTiN Coating		NEW DLC* Coating	
D <sup>+0.000</sup> / <sub>-0.001</sub>	d	l	L	Part Number	Stock	Part Number	Stock	Part Number	Stock
NEW 0.0040	1/8	0.012	1 1/2	1610-0040.012	●	1610-0040L012	●	-	-
0.0050	1/8	0.015	1 1/2	1610-0050.015	●	1610-0050L015	●	-	-
0.0060	1/8	0.018	1 1/2	1610-0060.018	●	1610-0060L018	●	-	-
0.0070	1/8	0.021	1 1/2	1610-0070.021	●	1610-0070L021	●	-	-
0.0080	1/8	0.024	1 1/2	1610-0080.024	●	1610-0080L024	●	-	-
0.0090	1/8	0.027	1 1/2	1610-0090.027	●	1610-0090L027	●	-	-
0.0100	1/8	0.030	1 1/2	1610-0100.030	●	1610-0100L030	●	1610-0100D030	■
0.0110	1/8	0.033	1 1/2	1610-0110.033	●	1610-0110L033	●	-	-
0.0120	1/8	0.036	1 1/2	1610-0120.036	●	1610-0120L036	●	-	-
0.0130	1/8	0.039	1 1/2	1610-0130.039	●	1610-0130L039	●	-	-
0.0140	1/8	0.042	1 1/2	1610-0140.042	●	1610-0140L042	●	-	-
0.0150	1/8	0.045	1 1/2	1610-0150.045	●	1610-0150L045	●	1610-0150D045	■
0.0156 (1/64)	1/8	0.047	1 1/2	1610-0156.047	●	1610-0156L047	●	1610-0156D047	■
0.0160	1/8	0.048	1 1/2	1610-0160.048	●	1610-0160L048	●	-	-
0.0170	1/8	0.051	1 1/2	1610-0170.051	●	1610-0170L051	●	-	-
0.0180	1/8	0.054	1 1/2	1610-0180.054	●	1610-0180L054	●	-	-
0.0190	1/8	0.057	1 1/2	1610-0190.057	●	1610-0190L057	●	-	-
0.0200	1/8	0.060	1 1/2	1610-0200.060	●	1610-0200L060	●	1610-0200D060	■
0.0210	1/8	0.063	1 1/2	1610-0210.063	●	1610-0210L063	●	-	-
0.0220	1/8	0.066	1 1/2	1610-0220.066	●	1610-0220L066	●	-	-
0.0230	1/8	0.069	1 1/2	1610-0230.069	●	1610-0230L069	●	-	-
0.0240	1/8	0.072	1 1/2	1610-0240.072	●	1610-0240L072	●	-	-
0.0250	1/8	0.075	1 1/2	1610-0250.075	●	1610-0250L075	●	-	-
0.0260	1/8	0.078	1 1/2	1610-0260.078	●	1610-0260L078	●	-	-
0.0270	1/8	0.081	1 1/2	1610-0270.081	●	1610-0270L081	●	-	-
0.0280	1/8	0.084	1 1/2	1610-0280.084	●	1610-0280L084	●	-	-
0.0290	1/8	0.087	1 1/2	1610-0290.087	●	1610-0290L087	●	-	-
0.0300	1/8	0.090	1 1/2	1610-0300.090	●	1610-0300L090	●	1610-0300D090	■
0.0310	1/8	0.093	1 1/2	1610-0310.093	●	1610-0310L093	●	-	-

\*DLC is Amorphous Diamond

SERIES 1610 WORKPIECE MATERIAL															
Coating	P Steel ~30HRC	P Steel 30-40HRC	H Hardened Steel ~55HRC	H Hardened Steel ~68HRC	M Stainless Steel	K Cast Iron	N Aluminum	N Graphite	N Copper Alloy	N CFRP	N Plastic	N Thermoset Plastic	N High Density Plastic	S Nickel / Cobalt	S Titanium Alloy
AlTiN	★	★	★	☆	☆	☆								☆	☆
DLC							☆	★	☆	★	★	★			
Uncoated							☆	☆	★	☆	★	★	☆		☆

★ : Priority ☆ : Applicable Materials

Symbol Descriptions Page vii

- : U.S. Stock Standard
- : NOT STOCKED - Call for Delivery
- ▲ : Coming Soon

(U.S.) 1.888.848.8449  
(International) 001.714.428.3636  
Pricing & Availability at [KyoceraPrecisionTools.com](http://KyoceraPrecisionTools.com)

# 2 FLUTE

0.0312" - 0.0600" DIAMETER

Mirror Surface Finishes

Sub Micron Grain Carbide

STANDARD LENGTH SQUARE END MILLS  
GENERAL PURPOSE MACHINING

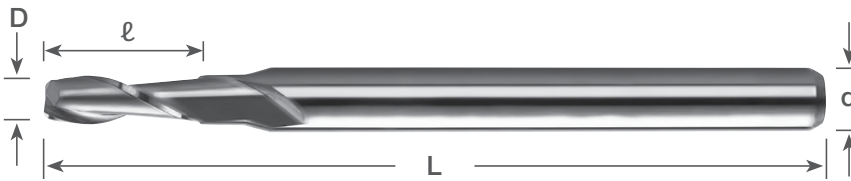

## STANDARD Length (Inch Sizes)

	Dimensions (in)				Uncoated		AlTiN Coating		NEW DLC* Coating	
	D <sup>+0.000</sup> / <sub>-0.001</sub>	d	ℓ	L	Part Number	Stock	Part Number	Stock	Part Number	Stock
	0.0312 (1/32)	1/8	0.094	1 1/2	1610-0312.094	●	1610-0312L094	●	1610-0312D094	■
	0.0320	1/8	0.096	1 1/2	1610-0320.096	●	1610-0320L096	●	-	-
	0.0330	1/8	0.099	1 1/2	1610-0330.099	●	1610-0330L099	●	-	-
	0.0340	1/8	0.102	1 1/2	1610-0340.102	●	1610-0340L102	●	-	-
	0.0350	1/8	0.105	1 1/2	1610-0350.105	●	1610-0350L105	●	1610-0350D105	■
NEW	0.0360	1/8	0.108	1 1/2	1610-0360.108	●	1610-0360L108	●	-	-
NEW	0.0370	1/8	0.111	1 1/2	1610-0370.111	●	1610-0370L111	●	-	-
NEW	0.0380	1/8	0.114	1 1/2	1610-0380.114	●	1610-0380L114	●	-	-
NEW	0.0394	1/8	0.117	1 1/2	1610-0394.117	●	1610-0394L117	●	1610-0394D117	■
	0.0400	1/8	0.120	1 1/2	1610-0400.120	●	1610-0400L120	●	1610-0400D120	■
NEW	0.0410	1/8	0.123	1 1/2	1610-0410.123	●	1610-0410L123	●	-	-
NEW	0.0420	1/8	0.126	1 1/2	1610-0420.126	●	1610-0420L126	●	-	-
NEW	0.0430	1/8	0.129	1 1/2	1610-0430.129	●	1610-0430L129	●	-	-
NEW	0.0440	1/8	0.132	1 1/2	1610-0440.132	●	1610-0440L132	●	-	-
	0.0450	1/8	0.135	1 1/2	1610-0450.135	●	1610-0450L135	●	1610-0450D135	■
NEW	0.0460	1/8	0.138	1 1/2	1610-0460.138	●	1610-0460L138	●	-	-
	0.0469 (3/64)	1/8	0.141	1 1/2	1610-0469.141	●	1610-0469L141	●	1610-0469D141	■
NEW	0.0480	1/8	0.144	1 1/2	1610-0480.144	●	1610-0480L144	●	-	-
NEW	0.0490	1/8	0.147	1 1/2	1610-0490.147	●	1610-0490L147	●	-	-
	0.0500	1/8	0.150	1 1/2	1610-0500.150	●	1610-0500L150	●	1610-0500D150	■
NEW	0.0510	1/8	0.153	1 1/2	1610-0510.153	●	1610-0510L153	●	-	-
NEW	0.0520	1/8	0.156	1 1/2	1610-0520.156	●	1610-0520L156	●	-	-
NEW	0.0530	1/8	0.159	1 1/2	1610-0530.159	●	1610-0530L159	●	-	-
NEW	0.0540	1/8	0.162	1 1/2	1610-0540.162	●	1610-0540L162	●	-	-
	0.0550	1/8	0.165	1 1/2	1610-0550.165	●	1610-0550L165	●	1610-0550D165	■
NEW	0.0560	1/8	0.168	1 1/2	1610-0560.168	●	1610-0560L168	●	-	-
NEW	0.0570	1/8	0.171	1 1/2	1610-0570.171	●	1610-0570L171	●	-	-
NEW	0.0580	1/8	0.174	1 1/2	1610-0580.174	●	1610-0580L174	●	-	-
NEW	0.0590	1/8	0.177	1 1/2	1610-0590.177	●	1610-0590L177	●	-	-
	0.0600	1/8	0.180	1 1/2	1610-0600.180	●	1610-0600L180	●	1610-0600D180	■

\*DLC is Amorphous Diamond

SERIES 1610 WORKPIECE MATERIAL															
Coating	P	P	H	H	M	K	N	N	N	N	N	N	S	S	
	Steel ~30HRC	Steel 30-40HRC	Hardened Steel ~55HRC	Hardened Steel ~68HRC	Stainless Steel	Cast Iron	Aluminum	Graphite	Copper Alloy	CFRP	Plastic	Thermoset Plastic	High Density Plastic	Nickel / Cobalt	Titanium Alloy
AlTiN	★	★	★	☆	☆	☆								☆	☆
DLC							☆	★	☆	★	★	★			
Uncoated							☆	☆	★	☆	★	★	☆		☆

★ : Priority ☆ : Applicable Materials

Symbol Descriptions Page vii



## 2 FLUTE

STANDARD LENGTH SQUARE END MILLS  
GENERAL PURPOSE MACHINING

**0.0625" - 0.3750" DIAMETER**

Mirror Surface Finishes

Sub Micron Grain Carbide

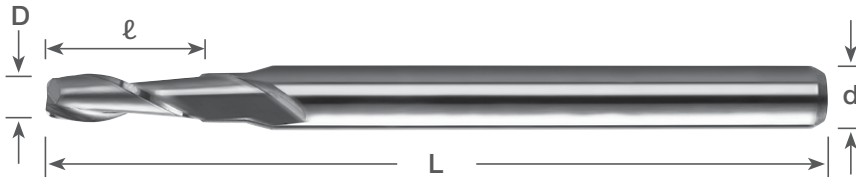

### STANDARD Length (Inch Sizes)

Dimensions (in)				Uncoated		AlTiN Coating		NEW DLC* Coating	
D <sup>+0.000</sup> / <sub>-0.001</sub>	d	ℓ	L	Part Number	Stock	Part Number	Stock	Part Number	Stock
0.0625 (1/16)	1/8	0.188	1 1/2	1610-0625.188	●	1610-0625L188	●	1610-0625D188	■
0.0650	1/8	0.195	1 1/2	1610-0650.195	●	1610-0650L195	●	1610-0650D195	■
0.0700	1/8	0.210	1 1/2	1610-0700.210	●	1610-0700L210	●	1610-0700D210	■
0.0750	1/8	0.225	1 1/2	1610-0750.225	●	1610-0750L225	●	1610-0750D225	■
0.0781 (5/64)	1/8	0.234	1 1/2	1610-0781.234	●	1610-0781L234	●	1610-0781D234	■
0.0800	1/8	0.240	1 1/2	1610-0800.240	●	1610-0800L240	●	1610-0800D240	■
0.0850	1/8	0.255	1 1/2	1610-0850.255	●	1610-0850L255	●	1610-0850D255	■
0.0900	1/8	0.270	1 1/2	1610-0900.270	●	1610-0900L270	●	1610-0900D270	■
0.0938 (3/32)	1/8	0.281	1 1/2	1610-0938.281	●	1610-0938L281	●	1610-0938D281	■
0.0950	1/8	0.285	1 1/2	1610-0950.285	●	1610-0950L285	●	1610-0950D285	■
0.1000	1/8	0.300	1 1/2	1610-1000.300	●	1610-1000L300	●	1610-1000D300	■
NEW 0.1050	1/8	0.315	1 1/2	1610-1050.315	●	1610-1050L315	●	1610-1050D315	■
0.1094 (7/64)	1/8	0.328	1 1/2	1610-1094.328	●	1610-1094L328	●	1610-1094D328	■
NEW 0.1100	1/8	0.330	1 1/2	1610-1100.330	●	1610-1100L330	●	1610-1100D330	■
NEW 0.1150	1/8	0.345	1 1/2	1610-1150.345	●	1610-1150L345	●	1610-1150D345	■
NEW 0.1181	1/8	0.355	1 1/2	1610-1181.355	●	1610-1181L355	●	1610-1181D355	■
NEW 0.1200	1/8	0.360	1 1/2	1610-1200.360	●	1610-1200L360	●	1610-1200D360	■
0.1250 (1/8)	1/8	0.375	1 1/2	1610-1250.375	●	1610-1250L375	●	1610-1250D375	■
0.1406 (9/64)	3/16	0.500	2	1610-1406.500	●	1610-1406L500	●	1610-1406D500	■
NEW 0.1406 (9/64)	3/16	0.562	2	1610-1406.562	●	1610-1406L562	●	1610-1406D562	■
NEW 0.1562 (5/32)	3/16	0.562	2	1610-1562.562	●	1610-1562L562	●	1610-1562D562	■
0.1562 (5/32)	3/16	0.500	2	1610-1563.500	●	1610-1563L500	●	1610-1563D500	■
0.1719 (11/64)	3/16	0.563	2	1610-1719.563	●	1610-1719L563	●	1610-1719D563	■
0.1875 (3/16)	3/16	0.563	2	1610-1875.563	●	1610-1875L563	●	1610-1875D563	■
NEW 0.1875 (3/16)	3/16	0.625	2	1610-1875.625	●	1610-1875L625	●	1610-1875D625	■
0.2031 (13/64)	1/4	0.625	2 1/2	1610-2031.625	●	1610-2031L625	●	1610-2031D625	■
0.2188 (7/32)	1/4	0.625	2 1/2	1610-2188.625	●	1610-2188L625	●	1610-2188D625	■
0.2344 (15/64)	1/4	0.750	2 1/2	1610-2344.750	●	1610-2344L750	●	1610-2344D750	■
0.2500 (1/4)	1/4	0.750	2 1/2	1610-2500.750	●	1610-2500L750	●	1610-2500D750	■
NEW 0.3125 (5/16)	5/16	0.812	2 1/2	1610-3125.812	●	1610-3125L812	●	1610-3125D812	■
NEW 0.3750 (3/8)	3/8	1.000	2 1/2	1610-3750.1000	●	1610-3750L1000	●	1610-3750D1000	■

\*DLC is Amorphous Diamond

SERIES 1610 WORKPIECE MATERIAL															
Coating	P Steel ~30HRC	P Steel 30~40HRC	H Hardened Steel ~55HRC	H Hardened Steel ~68HRC	M Stainless Steel	K Cast Iron	N Aluminum	N Graphite	N Copper Alloy	N CFRP	N Plastic	N Thermoset Plastic	N High Density Plastic	S Nickel / Cobalt	S Titanium Alloy
AlTiN	★	★	★	☆	☆	☆								☆	☆
DLC							☆	★	☆	★	★	★			
Uncoated							☆	☆	★	☆	★	★	☆		☆

★ : Priority ☆ : Applicable Materials

Symbol Descriptions Page vii

● : U.S. Stock Standard  
■ : NOT STOCKED - Call for Delivery  
▲ : Coming Soon

(U.S.) 1.888.848.8449  
(International) 001.714.428.3636  
Pricing & Availability at [KyoceraPrecisionTools.com](http://KyoceraPrecisionTools.com)

## 2 FLUTE

**0.10mm - 6.00mm DIAMETER**

Mirror Surface Finishes

Sub Micron Grain Carbide

STANDARD LENGTH SQUARE END MILLS  
GENERAL PURPOSE MACHINING

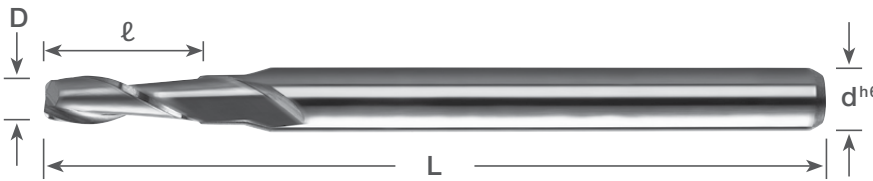

### STANDARD Length (Metric Sizes)

D	Dimensions (mm)			Uncoated		AlTiN Coating	
	D +0.00mm -0.02mm	d <sup>h6</sup>	ℓ	L	Part Number	Stock	Part Number
0.10	3	0.30	38	1610-0039.012	●	1610-0039L012	■
0.15	3	0.45	38	1610-0059.018	●	1610-0059L018	■
0.20	3	0.60	38	1610-0079.024	●	1610-0079L024	■
0.25	3	0.75	38	1610-0098.029	●	1610-0098L029	■
0.30	3	0.90	38	1610-0118.035	●	1610-0118L035	■
0.35	3	1.05	38	1610-0138.041	●	1610-0138L041	■
0.40	3	1.20	38	1610-0157.047	●	1610-0157L047	■
0.45	3	1.35	38	1610-0177.053	●	1610-0177L053	■
0.50	3	1.50	38	1610-0197.059	●	1610-0197L059	■
0.60	3	1.80	38	1610-0236.071	●	1610-0236L071	■
0.70	3	2.10	38	1610-0276.083	●	1610-0276L083	■
0.80	3	2.40	38	1610-0315.095	●	1610-0315L095	■
0.90	3	2.70	38	1610-0354.106	●	1610-0354L106	■
1.00	3	3.00	38	1610-0394.118	●	1610-0394L118	■
1.10	3	3.30	38	1610-0433.130	●	1610-0433L130	■
1.20	3	3.60	38	1610-0472.142	●	1610-0472L142	■
1.30	3	3.90	38	1610-0512.154	●	1610-0512L154	■
1.40	3	4.20	38	1610-0551.165	●	1610-0551L165	■
1.50	3	4.50	38	1610-0591.177	●	1610-0591L177	■
1.60	3	4.80	38	1610-0630.189	●	1610-0630L189	■
1.70	3	5.10	38	1610-0669.201	●	1610-0669L201	■
1.80	3	5.40	38	1610-0709.213	●	1610-0709L213	■
1.90	3	5.70	38	1610-0748.224	●	1610-0748L224	■
2.00	3	6.00	38	1610-0787.236	●	1610-0787L236	■
2.50	3	7.50	38	1610-0984.295	●	1610-0984L295	■
2.80	3	9.00	38	1610-1102.354	●	1610-1102L354	■
3.00	3	9.00	38	1610-1181.354	●	1610-1181L354	■
3.50	4	10.50	50	1610-1378.413	●	1610-1378L413	■
3.80	5	12.00	50	1610-1496.473	●	1610-1496L473	■
4.00	5	12.00	50	1610-1575.473	●	1610-1575L473	■
4.50	5	13.50	50	1610-1772.532	●	1610-1772L532	■
4.80	5	15.00	50	1610-1890.590	●	1610-1890L590	■
5.00	5	15.00	50	1610-1968.590	●	1610-1968L590	■
5.50	6	16.50	50	1610-2165.650	●	1610-2165L650	■
5.80	6	18.00	50	1610-2283.709	●	1610-2283L709	■
6.00	6	18.00	50	1610-2362.709	●	1610-2362L709	■

### SERIES 1610 WORKPIECE MATERIAL

Coating	P Steel ~30HRC	P Steel 30-40HRC	H Hardened Steel ~55HRC	H Hardened Steel ~68HRC	M Stainless Steel	K Cast Iron	N Aluminum	N Graphite	N Copper Alloy	N CFRP	N Plastic	N Thermoset Plastic	N High Density Plastic	S Nickel / Cobalt	S Titanium Alloy
AlTiN	★	★	★	☆	☆	☆	☆	☆	★	☆	★	★	☆	☆	☆
Uncoated							☆	☆	★	☆	★	★	☆		☆

★ : Priority ☆ : Applicable Materials

Symbol Descriptions [Page vii](#)

## 2 FLUTE

STUB LENGTH SQUARE END MILLS  
GENERAL PURPOSE MACHINING

0.0040" - 0.0270" DIAMETER

Mirror Surface Finishes

Sub Micron Grain Carbide

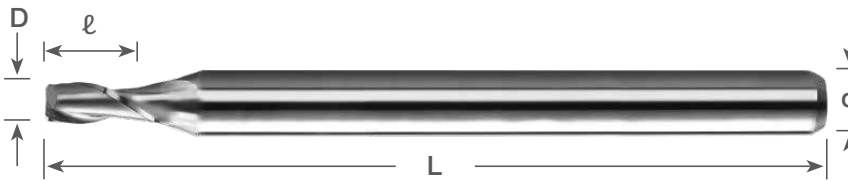

### STUB Length (Inch Sizes)

NEW	Dimensions (in)				Uncoated		AlTiN Coating		NEW DLC* Coating	
	D <sup>+0.000</sup> / <sub>-0.001</sub>	d	ℓ	L	Part Number	Stock	Part Number	Stock	Part Number	Stock
0.0040	1/8	0.006	1 1/2	1620-0040.006	●	1620-0040L006	●	-	-	
0.0050	1/8	0.008	1 1/2	1620-0050.008	●	1620-0050L008	●	-	-	
0.0060	1/8	0.009	1 1/2	1620-0060.009	●	1620-0060L009	●	-	-	
0.0070	1/8	0.011	1 1/2	1620-0070.011	●	1620-0070L011	●	-	-	
0.0080	1/8	0.012	1 1/2	1620-0080.012	●	1620-0080L012	●	-	-	
0.0090	1/8	0.014	1 1/2	1620-0090.014	●	1620-0090L014	●	-	-	
0.0100	1/8	0.015	1 1/2	1620-0100.015	●	1620-0100L015	●	1620-0100D015	■	
0.0110	1/8	0.017	1 1/2	1620-0110.017	●	1620-0110L017	●	-	-	
0.0120	1/8	0.018	1 1/2	1620-0120.018	●	1620-0120L018	●	-	-	
0.0130	1/8	0.020	1 1/2	1620-0130.020	●	1620-0130L020	●	-	-	
0.0140	1/8	0.021	1 1/2	1620-0140.021	●	1620-0140L021	●	-	-	
0.0150	1/8	0.023	1 1/2	1620-0150.023	●	1620-0150L023	●	1620-0150D023	■	
0.0156 (1/64)	1/8	0.023	1 1/2	1620-0156.023	●	1620-0156L023	●	1620-0156D023	■	
0.0160	1/8	0.024	1 1/2	1620-0160.024	●	1620-0160L024	●	-	-	
0.0170	1/8	0.026	1 1/2	1620-0170.026	●	1620-0170L026	●	-	-	
0.0180	1/8	0.027	1 1/2	1620-0180.027	●	1620-0180L027	●	-	-	
0.0190	1/8	0.029	1 1/2	1620-0190.029	●	1620-0190L029	●	-	-	
0.0200	1/8	0.030	1 1/2	1620-0200.030	●	1620-0200L030	●	1620-0200D030	■	
0.0210	1/8	0.032	1 1/2	1620-0210.032	●	1620-0210L032	●	-	-	
0.0220	1/8	0.033	1 1/2	1620-0220.033	●	1620-0220L033	●	-	-	
0.0230	1/8	0.035	1 1/2	1620-0230.035	●	1620-0230L035	●	-	-	
0.0240	1/8	0.036	1 1/2	1620-0240.036	●	1620-0240L036	●	-	-	
0.0250	1/8	0.038	1 1/2	1620-0250.038	●	1620-0250L038	●	1620-0250D038	■	
0.0260	1/8	0.039	1 1/2	1620-0260.039	●	1620-0260L039	●	-	-	
0.0270	1/8	0.041	1 1/2	1620-0270.041	●	1620-0270L041	●	-	-	

\*DLC is Amorphous Diamond

SERIES 1620 WORKPIECE MATERIAL															
Coating	P Steel ~30HRC	P Steel 30~40HRC	H Hardened Steel ~55HRC	H Hardened Steel ~68HRC	M Stainless Steel	K Cast Iron	N Aluminum	N Graphite	N Copper Alloy	N CFRP	N Plastic	N Thermoset Plastic	N High Density Plastic	S Nickel / Cobalt	S Titanium Alloy
AlTiN	★	★	★	☆	☆	☆								☆	☆
DLC							☆	★	☆	★	★	★			
Uncoated							☆	☆	★	☆	★	★	☆		☆

★ : Priority ☆ : Applicable Materials

Symbol Descriptions Page vii

● : U.S. Stock Standard  
■ : NOT STOCKED - Call for Delivery  
▲ : Coming Soon

(U.S.) 1.888.848.8449  
(International) 001.714.428.3636  
Pricing & Availability at [KyoceraPrecisionTools.com](http://KyoceraPrecisionTools.com)

## 2 FLUTE

**0.0280" - 0.0750" DIAMETER**

Mirror Surface Finishes

Sub Micron Grain Carbide

**STUB LENGTH SQUARE END MILLS**  
GENERAL PURPOSE MACHINING

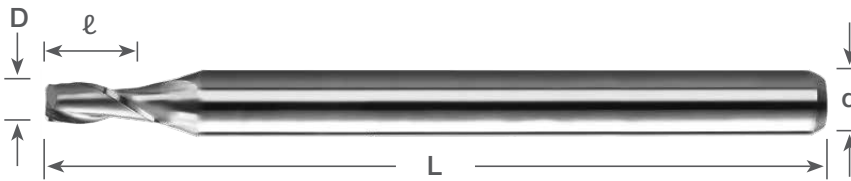

### STUB Length (Inch Sizes)

	Dimensions (in)				Uncoated		AlTiN Coating		NEW DLC* Coating	
	D <sup>+0.000</sup> / <sub>-0.001</sub>	d	ℓ	L	Part Number	Stock	Part Number	Stock	Part Number	Stock
	0.0280	1/8	0.042	1 1/2	1620-0280.042	●	1620-0280L042	●	-	-
	0.0290	1/8	0.044	1 1/2	1620-0290.044	●	1620-0290L044	●	-	-
	0.0300	1/8	0.045	1 1/2	1620-0300.045	●	1620-0300L045	●	1620-0300D045	■
	0.0310	1/8	0.047	1 1/2	1620-0310.047	●	1620-0310L047	●	-	-
	0.0312 (1/32)	1/8	0.047	1 1/2	1620-0312.047	●	1620-0312L047	●	-	-
	0.0320	1/8	0.048	1 1/2	1620-0320.048	●	1620-0320L048	●	-	-
	0.0330	1/8	0.050	1 1/2	1620-0330.050	●	1620-0330L050	●	-	-
	0.0340	1/8	0.051	1 1/2	1620-0340.051	●	1620-0340L051	●	-	-
	0.0350	1/8	0.053	1 1/2	1620-0350.053	●	1620-0350L053	●	1620-0350D053	■
NEW	0.0360	1/8	0.054	1 1/2	1620-0360.054	●	1620-0360L054	●	-	-
NEW	0.0370	1/8	0.055	1 1/2	1620-0370.055	●	1620-0370L055	●	-	-
NEW	0.0380	1/8	0.057	1 1/2	1620-0380.057	●	1620-0380L057	●	-	-
NEW	0.0394	1/8	0.058	1 1/2	1620-0394.058	●	1620-0394L058	●	1620-0394D058	■
	0.0400	1/8	0.060	1 1/2	1620-0400.060	●	1620-0400L060	●	1620-0400D060	■
	0.0450	1/8	0.068	1 1/2	1620-0450.068	●	1620-0450L068	●	1620-0450D068	■
	0.0469 (3/64)	1/8	0.071	1 1/2	1620-0469.071	●	1620-0469L071	●	1620-0469D071	■
	0.0470	1/8	0.071	1 1/2	1620-0470.071	●	1620-0470L071	●	-	-
	0.0500	1/8	0.075	1 1/2	1620-0500.075	●	1620-0500L075	●	1620-0500D075	■
NEW	0.0550	1/8	0.083	1 1/2	1620-0550.083	●	1620-0550L083	●	-	-
	0.0550	1/8	0.129	1 1/2	1620-0550.129	●	1620-0550L129	●	1620-0550D129	■
	0.0600	1/8	0.090	1 1/2	1620-0600.090	●	1620-0600L090	●	1620-0600D090	■
	0.0625 (1/16)	1/8	0.094	1 1/2	1620-0625.094	●	1620-0625L094	●	1620-0625D094	■
	0.0650	1/8	0.098	1 1/2	1620-0650.098	●	1620-0650L098	●	-	-
	0.0700	1/8	0.105	1 1/2	1620-0700.105	●	1620-0700L105	●	1620-0700D105	■
	0.0750	1/8	0.113	1 1/2	1620-0750.113	●	1620-0750L113	●	1620-0750D113	■

\*DLC is Amorphous Diamond

### SERIES 1620 WORKPIECE MATERIAL

Coating	P	P	H	H	M	K	N	N	N	N	N	N	S	S	
	Steel ~30HRC	Steel 30-40HRC	Hardened Steel ~55HRC	Hardened Steel ~68HRC	Stainless Steel	Cast Iron	Aluminum	Graphite	Copper Alloy	CFRP	Plastic	Thermoset Plastic	High Density Plastic	Nickel / Cobalt	Titanium Alloy
AlTiN	★	★	★	☆	☆	☆								☆	☆
DLC							☆	★	☆	★	★	★			
Uncoated							☆	☆	★	☆	★	★	☆		☆

★ : Priority ☆ : Applicable Materials

Symbol Descriptions [Page vii](#)

## 2 FLUTE

STUB LENGTH SQUARE END MILLS  
GENERAL PURPOSE MACHINING

**0.0781" - 0.2500" DIAMETER**

Mirror Surface Finishes

Sub Micron Grain Carbide

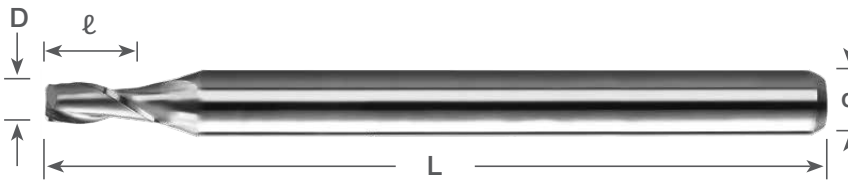

### STUB Length (Inch Sizes)

Dimensions (in)				Uncoated		AlTiN Coating		NEW DLC* Coating	
D <sup>+0.000</sup> / <sub>-0.001</sub>	d	l	L	Part Number	Stock	Part Number	Stock	Part Number	Stock
0.0781 (5/64)	1/8	0.117	1 1/2	1620-0781.117	●	1620-0781L117	●	1620-0781D117	■
0.0800	1/8	0.120	1 1/2	1620-0800.120	●	1620-0800L120	●	1620-0800D120	■
0.0850	1/8	0.128	1 1/2	1620-0850.128	●	1620-0850L128	●	1620-0850D128	■
0.0900	1/8	0.135	1 1/2	1620-0900.135	●	1620-0900L135	●	1620-0900D135	■
0.0938 (3/32)	1/8	0.141	1 1/2	1620-0938.141	●	1620-0938L141	●	1620-0938D141	■
0.0950	1/8	0.143	1 1/2	1620-0950.143	●	1620-0950L143	●	1620-0950D143	■
0.1000	1/8	0.150	1 1/2	1620-1000.150	●	1620-1000L150	●	1620-1000D150	■
NEW 0.1050	1/8	0.158	1 1/2	1620-1050.158	●	1620-1050L158	●	1620-1050D158	■
0.1094 (7/64)	1/8	0.164	1 1/2	1620-1094.164	●	1620-1094L164	●	1620-1094D164	■
NEW 0.1100	1/8	0.165	1 1/2	1620-1100.165	●	1620-1100L165	●	1620-1100D165	■
NEW 0.1150	1/8	0.173	1 1/2	1620-1150.173	●	1620-1150L173	●	1620-1150D173	■
NEW 0.1181	1/8	0.355	1 1/2	1620-1181.178	●	1620-1181L178	●	1620-1181D178	■
NEW 0.1200	1/8	0.180	1 1/2	1620-1200.180	●	1620-1200L180	●	1620-1200D180	■
0.1250 (1/8)	1/8	0.188	1 1/2	1620-1250.188	●	1620-1250L188	●	1620-1250D188	■
0.1406 (9/64)	3/16	0.313	2	1620-1406.313	●	1620-1406L313	●	1620-1406D313	■
0.1563 (5/32)	3/16	0.313	2	1620-1563.313	●	1620-1563L313	●	1620-1563D313	■
0.1719 (11/64)	3/16	0.375	2	1620-1719.375	●	1620-1719L375	●	1620-1719D375	■
NEW 0.1875 (3/16)	3/16	0.312	2	1620-1875.312	●	1620-1875L312	●	1620-1875D312	■
0.1875 (3/16)	3/16	0.375	2	1620-1875.375	●	1620-1875L375	●	1620-1875D375	■
0.2031 (13/64)	1/4	0.438	2 1/2	1620-2031.438	●	1620-2031L438	●	1620-2031D438	■
0.2188 (7/32)	1/4	0.438	2 1/2	1620-2188.438	●	1620-2188L438	●	1620-2188D438	■
0.2344 (15/64)	1/4	0.500	2 1/2	1620-2344.500	●	1620-2344L500	●	1620-2344D500	■
NEW 0.2500 (1/4)	1/4	0.375	2 1/2	1620-2500.375	●	1620-2500L375	●	1620-2500D375	■
0.2500 (1/4)	1/4	0.500	2 1/2	1620-2500.500	●	1620-2500L500	●	1620-2500D500	■

\*DLC is Amorphous Diamond

SERIES 1620 WORKPIECE MATERIAL															
Coating	P	P	H	H	M	K	N	N	N	N	N	N	S	S	
	Steel ~30HRC	Steel 30~40HRC	Hardened Steel ~55HRC	Hardened Steel ~68HRC	Stainless Steel	Cast Iron	Aluminum	Graphite	Copper Alloy	CFRP	Plastic	Thermoset Plastic	High Density Plastic	Nickel / Cobalt	Titanium Alloy
AlTiN	★	★	★	☆	☆	☆								☆	☆
DLC							☆	★	☆	★	★	★			
Uncoated							☆	☆	★	☆	★	★	☆		☆

★ : Priority ☆ : Applicable Materials

Symbol Descriptions Page vii

● : U.S. Stock Standard  
■ : NOT STOCKED - Call for Delivery  
▲ : Coming Soon

(U.S.) 1.888.848.8449  
(International) 001.714.428.3636  
Pricing & Availability at [KyoceraPrecisionTools.com](http://KyoceraPrecisionTools.com)

DRILLS A  
END MILLS B  
ROUTERS C  
THREAD MILLS & TAPS D  
ENGRavers E  
BORING BARS F  
REAMERS G  
SAWS H  
TECHNICAL I  
INDEX J

# 2 FLUTE

STUB LENGTH SQUARE END MILLS  
GENERAL PURPOSE MACHINING

0.10mm - 6.00mm DIAMETER

Mirror Surface Finishes

Sub Micron Grain Carbide

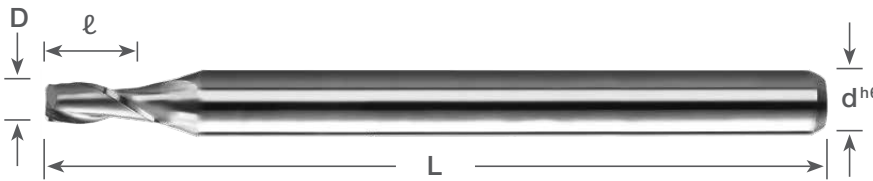

## STUB Length (Metric Sizes)

D	Dimensions (mm)			Uncoated		AlTiN Coating	
	D <sup>+0.00mm</sup> / <sub>-0.02mm</sub>	d <sup>h6</sup>	ℓ	L	Part Number	Stock	Part Number
0.10	3	0.15	38	1620-0039.006	●	1620-0039L006	●
0.15	3	0.23	38	1620-0059.009	●	1620-0059L009	●
0.20	3	0.30	38	1620-0079.012	●	1620-0079L012	●
0.25	3	0.38	38	1620-0098.015	●	1620-0098L015	●
0.30	3	0.45	38	1620-0118.018	●	1620-0118L018	●
0.35	3	0.53	38	1620-0138.021	●	1620-0138L021	●
0.40	3	0.60	38	1620-0157.024	●	1620-0157L024	●
0.45	3	0.68	38	1620-0177.027	●	1620-0177L027	●
0.50	3	0.75	38	1620-0197.030	●	1620-0197L030	●
0.60	3	0.90	38	1620-0236.035	●	1620-0236L035	●
0.70	3	1.05	38	1620-0276.041	●	1620-0276L041	●
0.80	3	1.20	38	1620-0315.047	●	1620-0315L047	●
0.90	3	1.35	38	1620-0354.053	●	1620-0354L053	●
1.00	3	1.50	38	1620-0394.059	●	1620-0394L059	●
1.10	3	1.65	38	1620-0433.065	●	1620-0433L065	●
1.20	3	1.80	38	1620-0472.071	●	1620-0472L071	●
1.30	3	2.60	38	1620-0512.102	●	1620-0512L102	●
1.40	3	2.80	38	1620-0551.110	●	1620-0551L110	●
1.50	3	2.25	38	1620-0591.089	●	1620-0591L089	●
1.60	3	3.20	38	1620-0630.126	●	1620-0630L126	●
1.70	3	3.70	38	1620-0669.146	●	1620-0669L146	●
1.80	3	3.60	38	1620-0709.142	●	1620-0709L142	●
1.90	3	3.80	38	1620-0748.150	●	1620-0748L150	●
2.00	3	3.00	38	1620-0787.118	●	1620-0787L118	●
2.50	3	3.75	38	1620-0984.148	●	1620-0984L148	●
2.80	3	4.50	38	1620-1102.177	●	1620-1102L177	●
3.00	3	4.50	38	1620-1181.177	●	1620-1181L177	●
3.50	4	5.25	50	1620-1378.207	●	1620-1378L207	●
3.80	5	6.00	50	1620-1496.236	●	1620-1496L236	●
4.00	5	6.00	50	1620-1575.236	●	1620-1575L236	●
4.50	5	6.75	50	1620-1772.266	●	1620-1772L266	●
4.80	5	7.50	50	1620-1890.295	●	1620-1890L295	●
5.00	5	7.50	50	1620-1968.295	●	1620-1968L295	●
5.50	6	8.25	50	1620-2165.325	●	1620-2165L325	●
5.80	6	9.00	50	1620-2283.354	●	1620-2283L354	●
6.00	6	9.00	50	1620-2362.354	●	1620-2362L354	●

### SERIES 1620 WORKPIECE MATERIAL

Coating	P	P	H	H	M	K	N	N	N	N	N	N	N	S	S
	Steel ~30HRC	Steel 30-40HRC	Hardened Steel ~55HRC	Hardened Steel ~68HRC	Stainless Steel	Cast Iron	Aluminum	Graphite	Copper Alloy	CFRP	Plastic	Thermoset Plastic	High Density Plastic	Nickel/ Cobalt	Titanium Alloy
AlTiN	★	★	★	☆	☆	☆	☆	☆	★	☆	★	★	☆	☆	☆
Uncoated							☆	☆	★	☆	★	★	☆		☆

★ : Priority ☆ : Applicable Materials

Symbol Descriptions [Page vii](#)

# 2 FLUTE

EXTENDED REACH SQUARE END MILLS  
DEEP REACH MILLING

0.0100" - 0.0625" DIAMETER

Mirror Surface Finishes

Sub Micron Grain Carbide

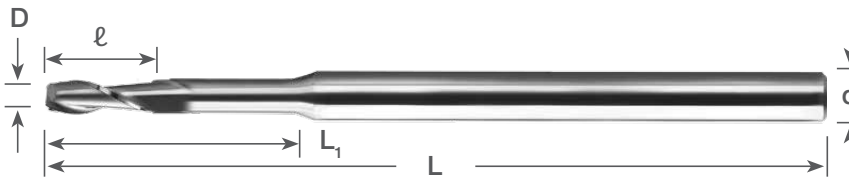

## EXTENDED Reach (Inch Sizes)

Dimensions (in)					Uncoated		AlTiN Coating	
D <sup>+0.000</sup> / <sub>-0.001</sub>	d	ℓ	L	L <sub>1</sub>	Part Number	Stock	Part Number	Stock
0.0100	1/8	0.030	1 1/2	0.100	1640-0100.100	●	1640-0100L100	●
0.0150	1/8	0.045	1 1/2	0.150	1640-0150.128	●	1640-0150L128	●
0.0150	1/8	0.045	1 1/2	0.128	1640-0150.150	●	1640-0150L150	●
0.0156 (1/64)	1/8	0.047	1 1/2	0.120	1640-0156.120	●	1640-0156L120	●
0.0200	1/8	0.060	1 1/2	0.200	1640-0200.170	●	1640-0200L170	●
0.0200	1/8	0.060	1 1/2	0.170	1640-0200.200	●	1640-0200L200	●
0.0250	1/8	0.075	1 1/2	0.250	1640-0250.213	●	1640-0250L213	●
0.0250	1/8	0.075	1 1/2	0.213	1640-0250.250	●	1640-0250L250	●
0.0300	1/8	0.090	1 1/2	0.300	1640-0300.270	●	1640-0300L270	●
0.0300	1/8	0.090	1 1/2	0.270	1640-0300.300	●	1640-0300L300	●
0.0312 (1/32)	1/8	0.094	1 1/2	0.315	1640-0312.315	●	1640-0312L315	●
0.0350	1/8	0.105	1 1/2	0.315	1640-0350.315	●	1640-0350L315	●
0.0350	1/8	0.105	1 1/2	0.350	1640-0350.350	●	1640-0350L350	●
0.0400	1/8	0.120	1 1/2	0.360	1640-0400.360	●	1640-0400L360	●
0.0400	1/8	0.120	1 1/2	0.400	1640-0400.400	●	1640-0400L400	●
0.0450	1/8	0.135	1 1/2	0.405	1640-0450.405	●	1640-0450L405	●
0.0450	1/8	0.135	1 1/2	0.450	1640-0450.450	●	1640-0450L450	●
0.0469 (3/64)	1/8	0.141	1 1/2	0.390	1640-0469.390	●	1640-0469L390	●
<b>NEW</b> 0.0469 (3/64)	1/8	0.141	1 1/2	0.423	1640-0469.423	●	1640-0469L423	●
0.0500	1/8	0.150	1 1/2	0.500	1640-0500.500	●	1640-0500L500	●
0.0550	1/8	0.165	1 1/2	0.500	1640-0550.500	●	1640-0550L500	●
0.0600	1/8	0.180	1 1/2	0.500	1640-0600.500	●	1640-0600L500	●
0.0600	1/8	0.180	2	0.600	1640-0600.600	●	1640-0600L600	●
0.0625 (1/16)	1/8	0.188	2	0.590	1640-0625.590	●	1640-0625L590	●
<b>NEW</b> 0.0625 (1/16)	1/8	0.186	1 1/2	0.590	1640-0625.590A	●	1640-0625L590A	●

DRILLS A  
END MILLS B  
ROUTERS C  
THREAD MILLS & TAPS D  
ENGRAVERS E  
BORING BARS F  
REAMERS G  
SAWS H  
TECHNICAL I  
INDEX J

SERIES 1640 WORKPIECE MATERIAL															
Coating	P Steel ~30HRC	P Steel 30-40HRC	H Hardened Steel ~55HRC	H Hardened Steel ~68HRC	M Stainless Steel	K Cast Iron	N Aluminum	N Graphite	N Copper Alloy	N CFRP	N Plastic	N Thermoset Plastic	N High Density Plastic	S Nickel / Cobalt	S Titanium Alloy
AlTiN	★	★	★	☆	☆	☆	☆	☆	☆	☆	★	☆	★	☆	☆
Uncoated							☆	☆	★	☆	★	★	☆		☆

★ : Priority ☆ : Applicable Materials

Symbol Descriptions Page vii

● : U.S. Stock Standard  
■ : NOT STOCKED - Call for Delivery  
▲ : Coming Soon

(U.S.) 1.888.848.8449  
(International) 001.714.428.3636  
Pricing & Availability at [KyoceraPrecisionTools.com](http://KyoceraPrecisionTools.com)



## 2 FLUTE

**0.0650" - 0.1250" DIAMETER**

Mirror Surface Finishes  
Sub Micron Grain Carbide

**EXTENDED REACH SQUARE END MILLS  
DEEP REACH MILLING**

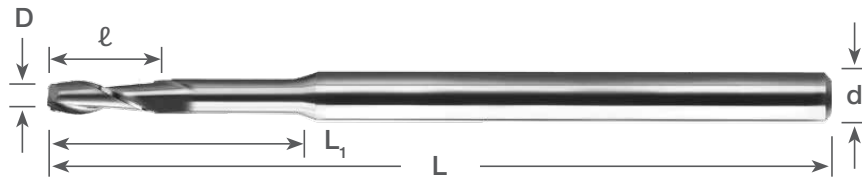

### EXTENDED Reach (Inch Sizes)

Dimensions (in)					Uncoated		AlTiN Coating	
D <sup>+0.000</sup> / <sub>-0.001</sub>	d	ℓ	L	L <sub>1</sub>	Part Number	Stock	Part Number	Stock
0.0650	1/8	0.195	1 1/2	0.500	1640-0650.500	●	1640-0650L500	●
0.0650	1/8	0.195	2	0.600	1640-0650.600	●	1640-0650L600	●
0.0700	1/8	0.210	1 1/2	0.500	1640-0700.500	●	1640-0700L500	●
0.0700	1/8	0.210	2	0.700	1640-0700.700	●	1640-0700L700	●
0.0750	1/8	0.225	1 1/2	0.500	1640-0750.500	●	1640-0750L500	●
0.0750	1/8	0.225	2	0.700	1640-0750.700	●	1640-0750L700	●
0.0781 (5/64)	1/8	0.234	2	0.590	1640-0781.590	●	1640-0781L590	●
<b>NEW</b> 0.0781 (5/64)	1/8	0.234	1 1/2	0.590	1640-0781.590A	●	1640-0781L590A	●
0.0800	1/8	0.240	1 1/2	0.500	1640-0800.500	●	1640-0800L500	●
0.0800	1/8	0.240	2	0.750	1640-0800.750	●	1640-0800L750	●
0.0850	1/8	0.255	1 1/2	0.500	1640-0850.500	●	1640-0850L500	●
0.0850	1/8	0.255	2	0.750	1640-0850.750	●	1640-0850L750	●
0.0900	1/8	0.270	1 1/2	0.625	1640-0900.625	●	1640-0900L625	●
0.0900	1/8	0.270	2	0.750	1640-0900.750	●	1640-0900L750	●
0.0938 (3/32)	1/8	0.281	2	0.590	1640-0938.590	●	1640-0938L590	●
<b>NEW</b> 0.0938 (3/32)	1/8	0.279	1 1/2	0.625	1640-0938.625	●	1640-0938L625	●
0.0950	1/8	0.285	1 1/2	0.625	1640-0950.625	●	1640-0950L625	●
0.0950	1/8	0.285	2	0.750	1640-0950.750	●	1640-0950L750	●
0.1000	1/8	0.300	1 1/2	0.625	1640-1000.625	●	1640-1000L625	●
0.1000	1/8	0.300	2	0.750	1640-1000.750	●	1640-1000L750	●
0.1094 (7/64)	1/8	0.328	2	0.590	1640-1094.590	●	1640-1094L590	●
0.1100	1/8	0.330	2	0.750	1640-1100.750	●	1640-1100L750	●
0.1250 (1/8)	1/8	0.375	2	0.590	1640-1250.590	●	1640-1250L590	●

### SERIES 1640 WORKPIECE MATERIAL

Coating	P Steel ~30HRC	P Steel 30-40HRC	H Hardened Steel ~55HRC	H Hardened Steel ~68HRC	M Stainless Steel	K Cast Iron	N Aluminum	N Graphite	N Copper Alloy	N CFRP	N Plastic	N Thermoset Plastic	N High Density Plastic	S Nickel/ Cobalt	S Titanium Alloy
AlTiN	★	★	★	☆	☆	☆	☆	☆	★	☆	★	★	☆	☆	☆
Uncoated							☆	☆	★	☆	★	★	☆		☆

★ : Priority ☆ : Applicable Materials

Symbol Descriptions [Page vii](#)

# 2 FLUTE

EXTENDED REACH SQUARE END MILLS  
DEEP REACH MILLING

0.40mm - 6.00mm DIAMETER

Mirror Surface Finishes

Sub Micron Grain Carbide

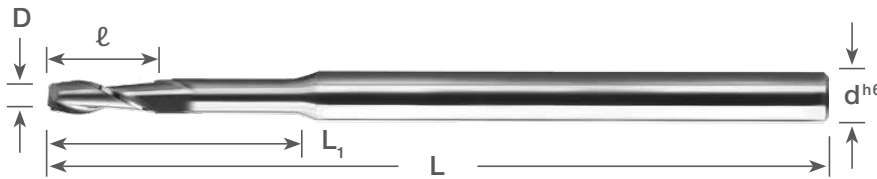

## EXTENDED Reach (Metric Sizes)

D +0.00mm -0.02mm	Dimensions (mm)				Uncoated		AlTiN Coating	
	dh6	ℓ	L	L1	Part Number	Stock	Part Number	Stock
0.40	3	1.20	38	3	1640-0157.118	●	1640-0157L118	●
0.50	3	1.50	38	4	1640-0197.157	●	1640-0197L157	●
0.60	3	1.80	38	5	1640-0236.197	●	1640-0236L197	●
0.65	3	1.95	38	6	1640-0256.236	●	1640-0256L236	●
0.70	3	2.10	38	7	1640-0276.276	●	1640-0276L276	●
0.75	3	2.25	38	8	1640-0295.315	●	1640-0295L315	●
0.80	3	2.40	50	9	1640-0315.354	●	1640-0315L354	●
0.90	3	2.70	50	10	1640-0354.394	●	1640-0354L394	●
1.00	3	3.00	50	10	1640-0394.394	●	1640-0394L394	●
1.50	3	4.50	50	15	1640-0591.591	●	1640-0591L591	●
2.00	3	6.00	50	20	1640-0787.787	●	1640-0787L787	●
2.50	3	7.50	50	23	1640-0984.906	●	1640-0984L906	●
3.00	3	9.00	50	23	1640-1181.906	●	1640-1181L906	●
3.50	6	10.50	75	25	1640-1378.984	●	1640-1378L984	●
4.00	6	12.00	75	25	1640-1575.984	●	1640-1575L984	●
4.50	6	13.50	75	30	1640-1772.1181	●	1640-1772L1181	●
5.00	6	15.00	75	30	1640-1968.1181	●	1640-1968L1181	●
5.50	6	16.50	75	30	1640-2165.1181	●	1640-2165L1181	●
6.00	6	18.00	75	30	1640-2362.1181	●	1640-2362L1181	●

SERIES 1640 WORKPIECE MATERIAL															
Coating	P Steel ~30HRC	P Steel 30-40HRC	H Hardened Steel ~55HRC	H Hardened Steel ~68HRC	M Stainless Steel	K Cast Iron	N Aluminum	N Graphite	N Copper Alloy	N CFRP	N Plastic	N Thermoset Plastic	N High Density Plastic	S Nickel / Cobalt	S Titanium Alloy
AlTiN	★	★	★	☆	☆	☆	☆	☆	☆	☆	★	★	☆	☆	☆
Uncoated							☆	☆	★	☆	★	★	☆		☆

★ : Priority ☆ : Applicable Materials

Symbol Descriptions Page vii

● : U.S. Stock Standard  
■ : NOT STOCKED - Call for Delivery  
▲ : Coming Soon

(U.S.) 1.888.848.8449  
(International) 001.714.428.3636  
Pricing & Availability at [KyoceraPrecisionTools.com](http://KyoceraPrecisionTools.com)

DRILLS A  
END MILLS B  
ROUTERS C  
THREAD MILLS & TAPS D  
ENGRAVERS E  
BORING BARS F  
REAMERS G  
SAWS H  
TECHNICAL I  
INDEX J

## TITAN-AX™

0.0312" - 0.2500" DIAMETER  
1.00mm - 8.00mm DIAMETER

Variable Helix

AX High Performance Coating

Increased Shank Diameter for Maximum Rigidity

Sub Micron Grain Carbide

REINFORCED SHANK  
TOUGH MACHINING APPLICATIONS

Also Available in Corner Radius Styles [Page B71-B73](#)

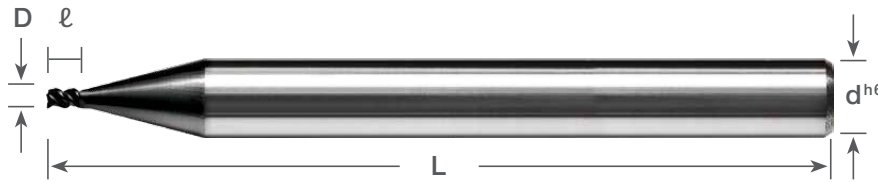

### STUB Length

TITAN-AX (Inch Sizes)

Dimensions (in)				AX Coating	
D	d	ℓ	L	Part Number	Stock
0.0312 (1/32)	1/4	0.063	2 1/2	T0312O063	●
0.0469 (3/64)	1/4	0.094	2 1/2	T0469O094	●
0.0625 (1/16)	1/4	0.140	2 1/2	T0625O140	●
0.0781 (5/64)	1/4	0.140	2 1/2	T0781O140	●
0.0938 (3/32)	1/4	0.188	2 1/2	T0938O188	●
0.1094 (7/64)	1/4	0.188	2 1/2	T1094O188	●
0.1250 (1/8)	1/4	0.250	2 1/2	T1250O250	●
0.1562 (5/32)	1/4	0.375	2 1/2	T1562O375	●
0.1875 (3/16)	1/4	0.375	2 1/2	T1875O375	●
0.2188 (7/32)	1/4	0.375	2 1/2	T2188O375	●
0.2500 (1/4)	1/4	0.500	2 1/2	T2500O500	●

TITAN-AXM (Metric Sizes)

Dimensions (mm)				AX Coating	
D	d	ℓ	L	Part Number	Stock
1.00	6	1.5	63.5	T0394O059	●
1.50	6	2.5	63.5	T0591O098	●
2.00	6	3.0	63.5	T0787O118	●
2.50	6	4.0	63.5	T0984O157	●
3.00	6	5.0	63.5	T1181O197	●
4.00	6	6.0	63.5	T1575O236	●
5.00	6	8.0	63.5	T1969O315	●
6.00	6	9.0	63.5	T2362O354	●
8.00	8	12.0	63.5	T3150O472	●

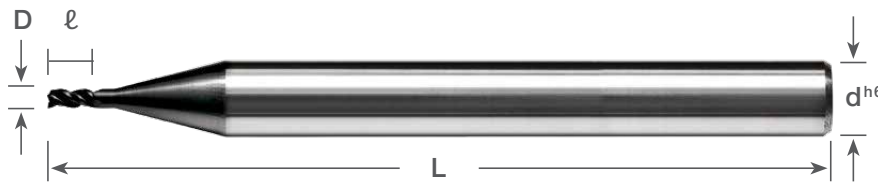

### STANDARD Length

TITAN-AX (Inch Sizes)

Dimensions (in)				AX Coating	
D	d	ℓ	L	Part Number	Stock
0.0312 (1/32)	1/4	0.094	2 1/2	T0312O094	●
0.0469 (3/64)	1/4	0.141	2 1/2	T0469O141	●
0.0625 (1/16)	1/4	0.188	2 1/2	T0625O188	●
0.0781 (5/64)	1/4	0.234	2 1/2	T0781O234	●
0.0938 (3/32)	1/4	0.375	2 1/2	T0938O375	●
0.1094 (7/64)	1/4	0.438	2 1/2	T1094O438	●
0.1250 (1/8)	1/4	0.500	2 1/2	T1250O500	●
0.1562 (5/32)	1/4	0.563	2 1/2	T1562O563	●
0.1875 (3/16)	1/4	0.625	2 1/2	T1875O625	●
0.2188 (7/32)	1/4	0.625	2 1/2	T2188O625	●
0.2500 (1/4)	1/4	0.750	2 1/2	T2500O750	●

TITAN-AXM (Metric Sizes)

Dimensions (mm)				AX Coating	
D	d	ℓ	L	Part Number	Stock
1.00	6	3.0	63.5	T0394O118	●
1.50	6	4.5	63.5	T0591O177	●
2.00	6	6.0	63.5	T0787O236	●
2.50	6	7.5	63.5	T0984O295	●
3.00	6	9.0	63.5	T1181O354	●
4.00	6	12.0	63.5	T1575O472	●
5.00	6	15.0	63.5	T1969O591	●
6.00	6	18.0	63.5	T2362O709	●
8.00	8	24.0	63.5	T3150O945	●

### TITAN-AX / TITAN-AXM WORKPIECE MATERIAL

Coating	P	P	H	H	M	K	N	N	N	N	N	N	S	S	
	Steel ~30HRC	Steel 30-40HRC	Hardened Steel ~55HRC	Hardened Steel ~68HRC	Stainless Steel	Cast Iron	Aluminum	Graphite	Copper Alloy	CFRP	Plastic	Thermoset Plastic	High Density Plastic	Nickel / Cobalt	Titanium Alloy
AX	☆	☆	★	★	☆	☆								★	★

★ : Priority ☆ : Applicable Materials

Symbol Descriptions [Page vii](#)

## TITAN-AX™

REINFORCED SHANK  
LONG REACH REDUCED NECK  
TOUGH MACHINING APPLICATIONS

Also Available in Corner Radius Styles [Page B71-B73](#)

**0.0312" - 0.2500" DIAMETER**  
**1.00mm - 8.00mm DIAMETER**

Variable Helix

AX High Performance Coating

Increased Shank Diameter for Maximum Rigidity

Sub Micron Grain Carbide



### Extended Reach

TITAN-AX (Inch Sizes)

Dimensions (in)					AX Coating	
D <sup>+0.000 -0.001</sup>	d	ℓ	L	L <sub>1</sub>	Part Number	Stock
0.0312 (1/32)	1/4	0.063	2 1/2	0.155	T0312O063ER	●
0.0469 (3/64)	1/4	0.094	2 1/2	0.230	T0469O094ER	●
0.0625 (1/16)	1/4	0.140	2 1/2	0.312	T0625O140ER	●
0.0781 (5/64)	1/4	0.140	2 1/2	0.390	T0781O140ER	●
0.0938 (3/32)	1/4	0.188	2 1/2	0.465	T0938O188ER	●
0.1094 (7/64)	1/4	0.188	2 1/2	0.545	T1094O188ER	●
0.1250 (1/8)	1/4	0.250	2 1/2	0.625	T1250O250ER	●
0.1562 (5/32)	1/4	0.375	2 1/2	0.781	T1562O375ER	●
0.1875 (3/16)	1/4	0.375	2 1/2	0.938	T1875O375ER	●
0.2188 (7/32)	1/4	0.375	2 1/2	1.093	T2188O375ER	●
0.2500 (1/4)	1/4	0.500	2 1/2	1.250	T2500O500ER	●

TITAN-AXM (Metric Sizes)

Dimensions (mm)					AX Coating	
D <sup>+0.00mm -0.02mm</sup>	d <sup>h6</sup>	ℓ	L	L <sub>1</sub>	Part Number	Stock
1.00	6	3.0	75	10	T0394O118ER	●
1.50	6	4.5	75	15	T0591O177ER	●
2.00	6	6.0	75	20	T0787O236ER	●
2.50	6	7.5	75	25	T0984O295ER	●
3.00	6	9.0	75	30	T1181O354ER	●
4.00	6	12.0	75	30	T1575O472ER	●
5.00	6	15.0	75	40	T1969O591ER	●
6.00	6	18.0	75	45	T2362O709ER	●
8.00	8	24.0	100	50	T3150O945ER	●

DRILLS **A**  
END MILLS **B**  
ROUTERS **C**  
THREAD MILLS & TAPS **D**  
ENGRAVERS **E**  
BORING BARS **F**  
REAMERS **G**  
SAWS **H**  
TECHNICAL **I**  
INDEX **J**

TITAN-AX / TITAN-AXM WORKPIECE MATERIAL															
Coating	P	P	H	H	M	K	N	N	N	N	N	N	S	S	
	Steel ~30HRC	Steel 30-40HRC	Hardened Steel ~55HRC	Hardened Steel ~68HRC	Stainless Steel	Cast Iron	Aluminum	Graphite	Copper Alloy	CFRP	Plastic	Thermoset Plastic	High Density Plastic	Nickel / Cobalt	Titanium Alloy
AX	☆	☆	★	★	☆	☆								★	★

★ : Priority ☆ : Applicable Materials

Symbol Descriptions [Page vii](#)

● : U.S. Stock Standard  
■ : NOT STOCKED - Call for Delivery  
▲ : Coming Soon

(U.S.) 1.888.848.8449  
(International) 001.714.428.3636  
Pricing & Availability at [KyoceraPrecisionTools.com](http://KyoceraPrecisionTools.com)

# 3 FLUTE

0.0100" - 0.0500" DIAMETER

Mirror Surface Finishes

Sub Micron Grain Carbide

STANDARD LENGTH SQUARE END MILLS  
GENERAL PURPOSE MACHINING

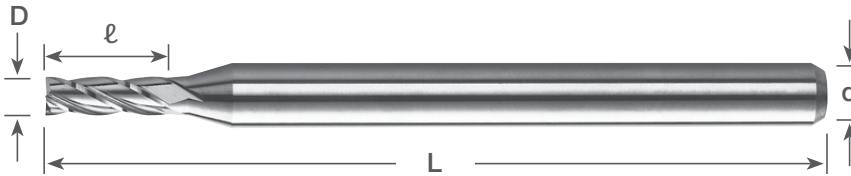

## STANDARD Length (Inch Sizes)

	Dimensions (in)				Uncoated		AlTiN Coating		NEW DLC* Coating	
	D <sup>+0.000</sup> / <sub>-0.001</sub>	d	ℓ	L	Part Number	Stock	Part Number	Stock	Part Number	Stock
NEW	0.0100	1/8	0.050	2 1/2	1710-0100.050	●	1710-0100L050	●	1710-0100D050	■
NEW	0.0100	1/8	0.080	2 1/2	1710-0100.080	●	1710-0100L080	●	1710-0100D080	■
	0.0150	1/8	0.075	2 1/2	1710-0150.075	●	1710-0150L075	●	1710-0150D075	■
NEW	0.0156 (1/64)	1/8	0.078	2 1/2	1710-0156.078	●	1710-0156L078	●	1710-0156D078	■
NEW	0.0156 (1/64)	1/8	0.125	2 1/2	1710-0156.125	●	1710-0156L125	●	1710-0156D125	■
NEW	0.0156 (1/64)	1/8	0.187	2 1/2	1710-0156.187	●	1710-0156L187	●	1710-0156D187	■
	0.0200	1/8	0.100	2 1/2	1710-0200.100	●	1710-0200L100	●	1710-0200D100	■
NEW	0.0200	1/8	0.160	2 1/2	1710-0200.160	●	1710-0200L160	●	1710-0200D160	■
NEW	0.0200	1/8	0.250	2 1/2	1710-0200.250	●	1710-0200L250	●	1710-0200D250	■
	0.0250	1/8	0.125	2 1/2	1710-0250.125	●	1710-0250L125	●	1710-0250D125	■
NEW	0.0250	1/8	0.203	2 1/2	1710-0250.203	●	1710-0250L203	●	1710-0250D203	■
	0.0300	1/8	0.150	2 1/2	1710-0300.150	●	1710-0300L150	●	1710-0300D150	■
NEW	0.0300	1/8	0.250	2 1/2	1710-0300.250	●	1710-0300L250	●	1710-0300D250	■
NEW	0.0300	1/8	0.375	2 1/2	1710-0300.375	●	1710-0300L375	●	1710-0300D375	■
NEW	0.0312 (1/32)	1/8	0.156	2 1/2	1710-0312.156	●	1710-0312L156	●	1710-0312D156	■
NEW	0.0312 (1/32)	1/8	0.250	2 1/2	1710-0312.250	●	1710-0312L250	●	1710-0312D250	■
NEW	0.0312 (1/32)	1/8	0.375	2 1/2	1710-0312.375	●	1710-0312L375	●	1710-0312D375	■
NEW	0.0312 (1/32)	1/8	0.470	2 1/2	1710-0312.470	●	1710-0312L470	●	1710-0312D470	■
	0.0350	1/8	0.175	2 1/2	1710-0350.175	●	1710-0350L175	●	1710-0350D175	■
NEW	0.0350	1/8	0.280	2 1/2	1710-0350.280	●	1710-0350L280	●	1710-0350D280	■
	0.0400	1/8	0.200	2 1/2	1710-0400.200	●	1710-0400L200	●	1710-0400D200	■
NEW	0.0400	1/8	0.325	2 1/2	1710-0400.325	●	1710-0400L325	●	1710-0400D325	■
NEW	0.0400	1/8	0.480	2 1/2	1710-0400.480	●	1710-0400L480	●	1710-0400D480	■
	0.0450	1/8	0.225	2 1/2	1710-0450.225	●	1710-0450L225	●	1710-0450D225	■
NEW	0.0450	1/8	0.375	2 1/2	1710-0450.375	●	1710-0450L375	●	1710-0450D375	■
NEW	0.0469 (3/64)	1/8	0.250	2 1/2	1710-0469.250	●	1710-0469L250	●	1710-0469D250	■
NEW	0.0469 (3/64)	1/8	0.375	2 1/2	1710-0469.375	●	1710-0469L375	●	1710-0469D375	■
NEW	0.0469 (3/64)	1/8	0.570	2 1/2	1710-0469.570	●	1710-0469L570	●	1710-0469D570	■
NEW	0.0469 (3/64)	1/8	0.710	2 1/2	1710-0469.710	●	1710-0469L710	●	1710-0469D710	■
	0.0500	1/8	0.300	2 1/2	1710-0500.300	●	1710-0500L300	●	1710-0500D300	■
NEW	0.0500	1/8	0.400	2 1/2	1710-0500.400	●	1710-0500L400	●	1710-0500D400	■
NEW	0.0500	1/8	0.600	2 1/2	1710-0500.600	●	1710-0500L600	●	1710-0500D600	■

\*DLC is Amorphous Diamond

SERIES 1710 WORKPIECE MATERIAL															
Coating	P Steel -30HRC	P Steel 30-40HRC	H Hardened Steel -55HRC	H Hardened Steel -68HRC	M Stainless Steel	K Cast Iron	N Aluminum	N Graphite	N Copper Alloy	N CFRP	N Plastic	N Thermoset Plastic	N High Density Plastic	S Nickel / Cobalt	S Titanium Alloy
AlTiN	★	★	★	☆	☆	☆								☆	☆
DLC							☆	★	☆	★	★	★			
Uncoated							☆	☆	☆	☆	☆	☆	☆		☆

★ : Priority ☆ : Applicable Materials

Symbol Descriptions Page vii

## 3 FLUTE

STANDARD LENGTH SQUARE END MILLS  
GENERAL PURPOSE MACHINING

**0.0550" - 0.1250" DIAMETER**

Mirror Surface Finishes

Sub Micron Grain Carbide

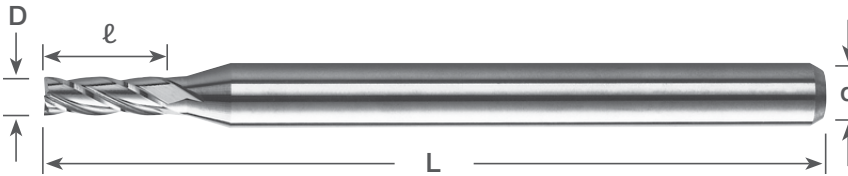

### STANDARD Length (Inch Sizes)

Dimensions (in)				Uncoated		AlTiN Coating		NEW DLC* Coating	
D <sup>+0.000</sup> / <sub>-0.001</sub>	d	ℓ	L	Part Number	Stock	Part Number	Stock	Part Number	Stock
NEW 0.0550	1/8	0.275	2 1/2	1710-0550.275	●	1710-0550L275	●	1710-0550D275	■
0.0550	1/8	0.385	2 1/2	1710-0550.385	●	1710-0550L385	●	1710-0550D385	■
NEW 0.0600	1/8	0.312	2 1/2	1710-0600.312	●	1710-0600L312	●	1710-0600D312	■
0.0600	1/8	0.500	2 1/2	1710-0600.500	●	1710-0600L500	●	1710-0600D500	■
NEW 0.0625 (1/16)	1/8	0.312	2 1/2	1710-0625.312	●	1710-0625L312	●	1710-0625D312	■
NEW 0.0625 (1/16)	1/8	0.500	2 1/2	1710-0625.500	●	1710-0625L500	●	1710-0625D500	■
NEW 0.0625 (1/16)	1/8	0.750	2 1/2	1710-0625.750	●	1710-0625L750	●	1710-0625D750	■
NEW 0.0625 (1/16)	1/8	0.950	2 1/2	1710-0625.950	●	1710-0625L950	●	1710-0625D950	■
0.0650	1/8	0.500	2 1/2	1710-0650.500	●	1710-0650L500	●	1710-0650D500	■
NEW 0.0700	1/8	0.375	2 1/2	1710-0700.375	●	1710-0700L375	●	1710-0700D375	■
0.0700	1/8	0.500	2 1/2	1710-0700.500	●	1710-0700L500	●	1710-0700D500	■
NEW 0.0750	1/8	0.375	2 1/2	1710-0750.375	●	1710-0750L375	●	1710-0750D375	■
0.0750	1/8	0.500	2 1/2	1710-0750.500	●	1710-0750L500	●	1710-0750D500	■
NEW 0.0781 (5/64)	1/8	0.406	2 1/2	1710-0781.406	●	1710-0781L406	●	1710-0781D406	■
NEW 0.0781 (5/64)	1/8	0.625	2 1/2	1710-0781.625	●	1710-0781L625	●	1710-0781D625	■
NEW 0.0781 (5/64)	1/8	0.940	2 1/2	1710-0781.940	●	1710-0781L940	●	1710-0781D940	■
NEW 0.0781 (5/64)	1/8	1.187	2 1/2	1710-0781.1187	●	1710-0781L1187	●	1710-0781D1187	■
NEW 0.0800	1/8	0.406	2 1/2	1710-0800.406	●	1710-0800L406	●	1710-0800D406	■
0.0800	1/8	0.750	2 1/2	1710-0800.750	●	1710-0800L750	●	1710-0800D750	■
NEW 0.0850	1/8	0.425	2 1/2	1710-0850.425	●	1710-0850L425	●	1710-0850D425	■
0.0850	1/8	0.750	2 1/2	1710-0850.750	●	1710-0850L750	●	1710-0850D750	■
NEW 0.0900	1/8	0.450	2 1/2	1710-0900.450	●	1710-0900L450	●	1710-0900D450	■
0.0900	1/8	0.750	2 1/2	1710-0900.750	●	1710-0900L750	●	1710-0900D750	■
NEW 0.0938 (3/32)	1/8	0.500	2 1/2	1710-0938.500	●	1710-0938L500	●	1710-0938D500	■
NEW 0.0938 (3/32)	1/8	0.750	2 1/2	1710-0938.750	●	1710-0938L750	●	1710-0938D750	■
NEW 0.0938 (3/32)	1/8	1.125	2 1/2	1710-0938.1125	●	1710-0938L1125	●	1710-0938D1125	■
NEW 0.0938 (3/32)	1/8	1.400	3	1710-0938.1400	●	1710-0938L1400	●	1710-0938D1400	■
0.0950	1/8	0.750	2 1/2	1710-0950.750	●	1710-0950L750	●	1710-0950D750	■
NEW 0.1000	1/8	0.500	2 1/2	1710-1000.500	●	1710-1000L500	●	1710-1000D500	■
0.1000	1/8	0.750	2 1/2	1710-1000.750	●	1710-1000L750	●	1710-1000D750	■
NEW 0.1250 (1/8)	1/8	0.625	2 1/2	1710-1250.625	●	1710-1250L625	●	1710-1250D625	■
NEW 0.1250 (1/8)	1/8	1.000	2 1/2	1710-1250.1000	●	1710-1250L1000	●	1710-1250D1000	■
NEW 0.1250 (1/8)	1/8	1.500	3	1710-1250.1500	●	1710-1250L1500	●	1710-1250D1500	■
NEW 0.1250 (1/8)	1/8	1.875	3	1710-1250.1875	●	1710-1250L1875	●	1710-1250D1875	■

\*DLC is Amorphous Diamond

SERIES 1710 WORKPIECE MATERIAL															
Coating	P Steel ~30HRC	P Steel 30~40HRC	H Hardened Steel ~55HRC	H Hardened Steel ~68HRC	M Stainless Steel	K Cast Iron	N Aluminum	N Graphite	N Copper Alloy	N CFRP	N Plastic	N Thermoset Plastic	N High Density Plastic	S Nickel / Cobalt	S Titanium Alloy
AlTiN	★	★	★	☆	☆	☆								☆	☆
DLC							☆	★	☆	★	★	★			
Uncoated							☆	☆	☆	☆	☆	☆	☆		☆

★ : Priority ☆ : Applicable Materials

Symbol Descriptions Page vii

● : U.S. Stock Standard  
■ : NOT STOCKED - Call for Delivery  
▲ : Coming Soon

(U.S.) 1.888.848.8449  
(International) 001.714.428.3636  
Pricing & Availability at [KyoceraPrecisionTools.com](http://KyoceraPrecisionTools.com)

# 3 FLUTE

0.0100" - 0.0550" DIAMETER

EXTENDED REACH SQUARE END MILLS  
DEEP REACH MILLING

Mirror Surface Finishes  
Sub Micron Grain Carbide

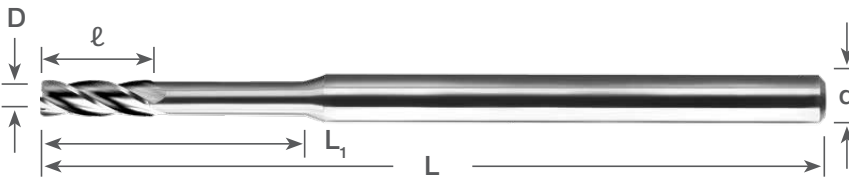

## EXTENDED Reach (Inch Sizes)

	Dimensions (in)					Uncoated		AlTiN Coating		NEW DLC* Coating	
	D <sup>+0.000</sup> / <sub>-0.001</sub>	d	ℓ	L	L <sub>1</sub>	Part Number	Stock	Part Number	Stock	Part Number	Stock
<b>NEW</b>	0.0100	1/8	0.050	2-1/2	0.100	1740-0100.100	●	1740-0100L100	●	1740-0100D100	■
	0.0150	1/8	0.022	2 1/2	0.078	1740-0150.078	●	1740-0150L078	●	1740-0150D078	■
	0.0150	1/8	0.022	2 1/2	0.125	1740-0150.125	●	1740-0150L125	●	1740-0150D125	■
	0.0150	1/8	0.075	2 1/2	0.150	1740-0150.150	●	1740-0150L150	●	1740-0150D150	■
<b>NEW</b>	0.0156 (1/64)	1/8	0.075	2 1/2	0.150	1740-0156.150	●	1740-0156L150	●	1740-0156D150	■
	0.0200	1/8	0.030	2 1/2	0.100	1740-0200.100	●	1740-0200L100	●	1740-0200D100	■
	0.0200	1/8	0.030	2 1/2	0.160	1740-0200.160	●	1740-0200L160	●	1740-0200D160	■
	0.0200	1/8	0.100	2 1/2	0.200	1740-0200.200	●	1740-0200L200	●	1740-0200D200	■
	0.0250	1/8	0.037	2 1/2	0.125	1740-0250.125	●	1740-0250L125	●	1740-0250D125	■
	0.0250	1/8	0.037	2 1/2	0.200	1740-0250.200	●	1740-0250L200	●	1740-0250D200	■
	0.0250	1/8	0.125	2 1/2	0.250	1740-0250.250	●	1740-0250L250	●	1740-0250D250	■
	0.0300	1/8	0.045	2 1/2	0.156	1740-0300.156	●	1740-0300L156	●	1740-0300D156	■
	0.0300	1/8	0.045	2 1/2	0.250	1740-0300.250	●	1740-0300L250	●	1740-0300D250	■
	0.0300	1/8	0.150	2 1/2	0.300	1740-0300.300	●	1740-0300L300	●	1740-0300D300	■
<b>NEW</b>	0.0312 (1/32)	1/8	0.155	2 1/2	0.310	1740-0312.310	●	1740-0312L310	●	1740-0312D310	■
	0.0350	1/8	0.052	2 1/2	0.187	1740-0350.187	●	1740-0350L187	●	1740-0350D187	■
	0.0350	1/8	0.052	2 1/2	0.280	1740-0350.280	●	1740-0350L280	●	1740-0350D280	■
	0.0350	1/8	0.175	2 1/2	0.350	1740-0350.350	●	1740-0350L350	●	1740-0350D350	■
	0.0400	1/8	0.060	2 1/2	0.200	1740-0400.200	●	1740-0400L200	●	1740-0400D200	■
	0.0400	1/8	0.060	2 1/2	0.325	1740-0400.325	●	1740-0400L325	●	1740-0400D325	■
	0.0400	1/8	0.200	2 1/2	0.400	1740-0400.400	●	1740-0400L400	●	1740-0400D400	■
	0.0450	1/8	0.067	2 1/2	0.225	1740-0450.225	●	1740-0450L225	●	1740-0450D225	■
	0.0450	1/8	0.067	2 1/2	0.375	1740-0450.375	●	1740-0450L375	●	1740-0450D375	■
	0.0450	1/8	0.225	2 1/2	0.450	1740-0450.450	●	1740-0450L450	●	1740-0450D450	■
<b>NEW</b>	0.0469 (3/64)	1/8	0.250	2 1/2	0.500	1740-0469.500	●	1740-0469L500	●	1740-0469D500	■
	0.0500	1/8	0.075	2 1/2	0.250	1740-0500.250	●	1740-0500L250	●	1740-0500D250	■
	0.0500	1/8	0.075	2 1/2	0.400	1740-0500.400	●	1740-0500L400	●	1740-0500D400	■
	0.0500	1/8	0.300	2 1/2	0.600	1740-0500.600	●	1740-0500L600	●	1740-0500D600	■
	0.0550	1/8	0.082	2 1/2	0.275	1740-0550.275	●	1740-0550L275	●	1740-0550D275	■
	0.0550	1/8	0.082	2 1/2	0.450	1740-0550.450	●	1740-0550L450	●	1740-0550D450	■
	0.0550	1/8	0.385	2 1/2	0.770	1740-0550.770	●	1740-0550L770	●	1740-0550D770	■

\*DLC is Amorphous Diamond

SERIES 1740 WORKPIECE MATERIAL															
Coating	P Steel -30HRC	P Steel 30-40HRC	H Hardened Steel -55HRC	H Hardened Steel -68HRC	M Stainless Steel	K Cast Iron	N Aluminum	N Graphite	N Copper Alloy	N CFRP	N Plastic	N Thermocast Plastic	N High Density Plastic	S Nickel / Cobalt	S Titanium Alloy
AlTiN	★	★	★	☆	☆	☆								☆	☆
DLC							☆	★	☆	★	★	★			
Uncoated							☆	☆	☆	☆	☆	☆	☆		☆

★ : Priority ☆ : Applicable Materials

Symbol Descriptions [Page vii](#)



## 3 FLUTE

EXTENDED REACH SQUARE END MILLS  
DEEP REACH MILLING

**0.0600" - 0.2500" DIAMETER**

Mirror Surface Finishes

Sub Micron Grain Carbide

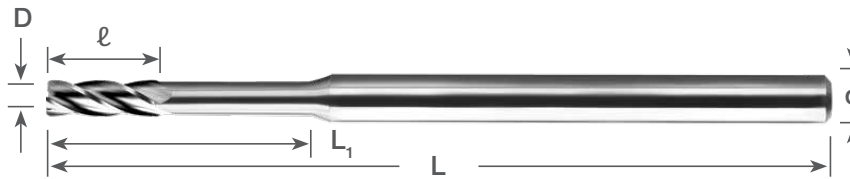

### EXTENDED Reach (Inch Sizes)

Dimensions (in)					Uncoated		AlTiN Coating		NEW DLC* Coating	
D <sup>+0.000</sup> / <sub>-0.001</sub>	d	l	L	L <sub>1</sub>	Part Number	Stock	Part Number	Stock	Part Number	Stock
0.0600	1/8	0.090	2 1/2	0.300	1740-0600.300	●	1740-0600L300	●	1740-0600D300	■
0.0600	1/8	0.090	2 1/2	0.500	1740-0600.500	●	1740-0600L500	●	1740-0600D500	■
0.0600	1/8	0.500	2 1/2	1.000	1740-0600.1000	●	1740-0600L1000	●	1740-0600D1000	■
NEW 0.0625 (1/16)	1/8	0.500	2 1/2	1.000	1740-0625.1000	●	1740-0625L1000	●	1740-0625D1000	■
0.0650	1/8	0.097	2 1/2	0.325	1740-0650.325	●	1740-0650L325	●	1740-0650D325	■
0.0650	1/8	0.097	2 1/2	0.530	1740-0650.530	●	1740-0650L530	●	1740-0650D530	■
0.0650	1/8	0.500	2 1/2	1.000	1740-0650.1000	●	1740-0650L1000	●	1740-0650D1000	■
0.0700	1/8	0.105	2 1/2	0.375	1740-0700.375	●	1740-0700L375	●	1740-0700D375	■
0.0700	1/8	0.105	2 1/2	0.570	1740-0700.570	●	1740-0700L570	●	1740-0700D570	■
0.0700	1/8	0.500	2 1/2	1.000	1740-0700.1000	●	1740-0700L1000	●	1740-0700D1000	■
0.0750	1/8	0.112	2 1/2	0.375	1740-0750.375	●	1740-0750L375	●	1740-0750D375	■
0.0750	1/8	0.112	2 1/2	0.625	1740-0750.625	●	1740-0750L625	●	1740-0750D625	■
0.0750	1/8	0.500	2 1/2	1.000	1740-0750.1000	●	1740-0750L1000	●	1740-0750D1000	■
NEW 0.0781 (5/64)	1/8	0.500	2 1/2	1.000	1740-0781.1000	●	1740-0781L1000	●	1740-0781D1000	■
0.0800	1/8	0.120	2 1/2	0.400	1740-0800.400	●	1740-0800L400	●	1740-0800D400	■
0.0800	1/8	0.120	2 1/2	0.650	1740-0800.650	●	1740-0800L650	●	1740-0800D650	■
0.0800	1/8	0.750	2 1/2	1.250	1740-0800.1250	●	1740-0800L1250	●	1740-0800D1250	■
0.0850	1/8	0.127	2 1/2	0.425	1740-0850.425	●	1740-0850L425	●	1740-0850D425	■
0.0850	1/8	0.127	2 1/2	0.700	1740-0850.700	●	1740-0850L700	●	1740-0850D700	■
0.0850	1/8	0.750	2 1/2	1.250	1740-0850.1250	●	1740-0850L1250	●	1740-0850D1250	■
0.0900	1/8	0.135	2 1/2	0.450	1740-0900.450	●	1740-0900L450	●	1740-0900D450	■
0.0900	1/8	0.135	2 1/2	0.750	1740-0900.750	●	1740-0900L750	●	1740-0900D750	■
0.0900	1/8	0.750	2 1/2	1.250	1740-0900.1250	●	1740-0900L1250	●	1740-0900D1250	■
NEW 0.0938 (3/32)	1/8	0.750	2 1/2	1.250	1740-0938.1250	●	1740-0938L1250	●	1740-0938D1250	■
0.0950	1/8	0.142	2 1/2	0.500	1740-0950.500	●	1740-0950L500	●	1740-0950D500	■
0.0950	1/8	0.142	2 1/2	0.750	1740-0950.750	●	1740-0950L750	●	1740-0950D750	■
0.0950	1/8	0.750	2 1/2	1.250	1740-0950.1250	●	1740-0950L1250	●	1740-0950D1250	■
0.1000	1/8	0.150	2 1/2	0.500	1740-1000.500	●	1740-1000L500	●	1740-1000D500	■
0.1000	1/8	0.150	2 1/2	0.800	1740-1000.800	●	1740-1000L800	●	1740-1000D800	■
0.1000	1/8	0.750	2 1/2	1.250	1740-1000.1250	●	1740-1000L1250	●	1740-1000D1250	■
NEW 0.1250 (1/8)	1/8	1.000	2 1/2	1.500	1740-1250.1500	●	1740-1250L1500	●	1740-1250D1500	■
NEW 0.1875 (3/16)	3/16	1.125	3	1.625	1740-1875.1625	●	1740-1875L1625	●	1740-1875D1625	■
NEW 0.2500 (1/4)	1/4	1.500	4	2.000	1740-2500.2000	●	1740-2500L2000	●	1740-2500D2000	■

\*DLC is Amorphous Diamond

SERIES 1740 WORKPIECE MATERIAL															
Coating	P Steel ~30HRC	P Steel 30~40HRC	H Hardened Steel ~55HRC	H Hardened Steel ~68HRC	M Stainless Steel	K Cast Iron	N Aluminum	N Graphite	N Copper Alloy	N CFRP	N Plastic	N Thermoset Plastic	N High Density Plastic	S Nickel / Cobalt	S Titanium Alloy
AlTiN	★	★	★	☆	☆	☆								☆	☆
DLC							☆	★	☆	★	★	★			
Uncoated							☆	☆	☆	☆	☆	☆	☆		☆

★ : Priority ☆ : Applicable Materials

Symbol Descriptions Page vii

- : U.S. Stock Standard
- : NOT STOCKED - Call for Delivery
- ▲ : Coming Soon

(U.S.) 1.888.848.8449  
(International) 001.714.428.3636  
Pricing & Availability at [KyoceraPrecisionTools.com](http://KyoceraPrecisionTools.com)

## 3 FLUTE NEW

0.0100" - 0.0300" DIAMETER

Mirror Surface Finishes

Sub Micron Grain Carbide

EXTENDED REACH STUB LENGTH SQUARE END MILLS  
DEEP REACH MILLING

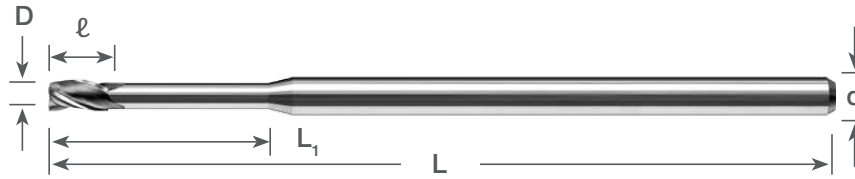

### EXTENDED Reach **STUB** Length (Inch Sizes)

Dimensions (in)					Uncoated		AlTiN Coating		<span style="color:red">NEW</span> DLC* Coating	
D <sup>+0.000</sup> / <sub>-0.001</sub>	d	ℓ	L	L <sub>1</sub>	Part Number	Stock	Part Number	Stock	Part Number	Stock
0.0100	1/8	0.015	2 1/2	0.030	1742-0100.030	●	1742-0100L030	●	1742-0100D030	■
0.0100	1/8	0.015	2 1/2	0.050	1742-0100.050	●	1742-0100L050	●	1742-0100D050	■
0.0100	1/8	0.015	2 1/2	0.080	1742-0100.080	●	1742-0100L080	●	1742-0100D080	■
0.0100	1/8	0.015	2 1/2	0.125	1742-0100.125	●	1742-0100L125	●	1742-0100D125	■
0.0100	1/8	0.015	2 1/2	0.150	1742-0100.150	●	1742-0100L150	●	1742-0100D150	■
0.0156 (1/64)	1/8	0.022	2 1/2	0.045	1742-0156.045	●	1742-0156L045	●	1742-0156D045	■
0.0156 (1/64)	1/8	0.022	2 1/2	0.078	1742-0156.078	●	1742-0156L078	●	1742-0156D078	■
0.0156 (1/64)	1/8	0.022	2 1/2	0.125	1742-0156.125	●	1742-0156L125	●	1742-0156D125	■
0.0156 (1/64)	1/8	0.022	2 1/2	0.156	1742-0156.156	●	1742-0156L156	●	1742-0156D156	■
0.0156 (1/64)	1/8	0.022	2 1/2	0.187	1742-0156.187	●	1742-0156L187	●	1742-0156D187	■
0.0156 (1/64)	1/8	0.022	2 1/2	0.225	1742-0156.225	●	1742-0156L225	●	1742-0156D225	■
0.0156 (1/64)	1/8	0.022	2 1/2	0.300	1742-0156.300	●	1742-0156L300	●	1742-0156D300	■
0.0200	1/8	0.030	2 1/2	0.060	1742-0200.060	●	1742-0200L060	●	1742-0200D060	■
0.0200	1/8	0.030	2 1/2	0.100	1742-0200.100	●	1742-0200L100	●	1742-0200D100	■
0.0200	1/8	0.030	2 1/2	0.160	1742-0200.160	●	1742-0200L160	●	1742-0200D160	■
0.0200	1/8	0.030	2 1/2	0.250	1742-0200.250	●	1742-0200L250	●	1742-0200D250	■
0.0200	1/8	0.030	2 1/2	0.300	1742-0200.300	●	1742-0200L300	●	1742-0200D300	■
0.0200	1/8	0.030	2 1/2	0.400	1742-0200.400	●	1742-0200L400	●	1742-0200D400	■
0.0250	1/8	0.037	2 1/2	0.075	1742-0250.075	●	1742-0250L075	●	1742-0250D075	■
0.0250	1/8	0.037	2 1/2	0.125	1742-0250.125	●	1742-0250L125	●	1742-0250D125	■
0.0250	1/8	0.037	2 1/2	0.203	1742-0250.203	●	1742-0250L203	●	1742-0250D203	■
0.0250	1/8	0.037	2 1/2	0.312	1742-0250.312	●	1742-0250L312	●	1742-0250D312	■
0.0250	1/8	0.037	2 1/2	0.375	1742-0250.375	●	1742-0250L375	●	1742-0250D375	■
0.0250	1/8	0.037	2 1/2	0.500	1742-0250.500	●	1742-0250L500	●	1742-0250D500	■
0.0300	1/8	0.045	2 1/2	0.090	1742-0300.090	●	1742-0300L090	●	1742-0300D090	■
0.0300	1/8	0.045	2 1/2	0.156	1742-0300.156	●	1742-0300L156	●	1742-0300D156	■
0.0300	1/8	0.045	2 1/2	0.250	1742-0300.250	●	1742-0300L250	●	1742-0300D250	■
0.0300	1/8	0.045	2 1/2	0.375	1742-0300.375	●	1742-0300L375	●	1742-0300D375	■
0.0300	1/8	0.045	2 1/2	0.450	1742-0300.450	●	1742-0300L450	●	1742-0300D450	■

\*DLC is Amorphous Diamond

SERIES 1742 WORKPIECE MATERIAL															
Coating	P Steel -30HRC	P Steel 30-40HRC	H Hardened Steel -55HRC	H Hardened Steel -68HRC	M Stainless Steel	K Cast Iron	N Aluminum	N Graphite	N Copper Alloy	N CFRP	N Plastic	N Thermoset Plastic	N High Density Plastic	S Nickel / Cobalt	S Titanium Alloy
AlTiN	★	★	★	☆	☆	☆								☆	☆
DLC							☆	★	☆	★	★	★			
Uncoated							☆	☆	☆	☆	☆	☆	☆		☆

★ : Priority ☆ : Applicable Materials

Symbol Descriptions [Page vii](#)

## 3 FLUTE NEW

**0.0312" - 0.0450" DIAMETER**

Mirror Surface Finishes

Sub Micron Grain Carbide

**EXTENDED REACH STUB LENGTH SQUARE END MILLS**  
**DEEP REACH MILLING**



### EXTENDED Reach **STUB** Length (Inch Sizes)

Dimensions (in)					Uncoated		AlTiN Coating		<span style="color:red">NEW</span> DLC* Coating	
D <sup>+0.000</sup> / <sub>-0.001</sub>	d	ℓ	L	L <sub>1</sub>	Part Number	Stock	Part Number	Stock	Part Number	Stock
0.0312 (1/32)	1/8	0.046	2 1/2	0.093	1742-0312.093	●	1742-0312L093	●	1742-0312D093	■
0.0312 (1/32)	1/8	0.046	2 1/2	0.156	1742-0312.156	●	1742-0312L156	●	1742-0312D156	■
0.0312 (1/32)	1/8	0.046	2 1/2	0.250	1742-0312.250	●	1742-0312L250	●	1742-0312D250	■
0.0312 (1/32)	1/8	0.046	2 1/2	0.312	1742-0312.312	●	1742-0312L312	●	1742-0312D312	■
0.0312 (1/32)	1/8	0.046	2 1/2	0.375	1742-0312.375	●	1742-0312L375	●	1742-0312D375	■
0.0312 (1/32)	1/8	0.046	2 1/2	0.470	1742-0312.470	●	1742-0312L470	●	1742-0312D470	■
0.0312 (1/32)	1/8	0.046	2 1/2	0.565	1742-0312.565	●	1742-0312L565	●	1742-0312D565	■
0.0312 (1/32)	1/8	0.046	2 1/2	0.625	1742-0312.625	●	1742-0312L625	●	1742-0312D625	■
0.0312 (1/32)	1/8	0.046	2 1/2	0.775	1742-0312.775	●	1742-0312L775	●	1742-0312D775	■
0.0350	1/8	0.052	2 1/2	0.105	1742-0350.105	●	1742-0350L105	●	1742-0350D105	■
0.0350	1/8	0.052	2 1/2	0.187	1742-0350.187	●	1742-0350L187	●	1742-0350D187	■
0.0350	1/8	0.052	2 1/2	0.281	1742-0350.281	●	1742-0350L281	●	1742-0350D281	■
0.0350	1/8	0.052	2 1/2	0.425	1742-0350.425	●	1742-0350L425	●	1742-0350D425	■
0.0350	1/8	0.052	2 1/2	0.525	1742-0350.525	●	1742-0350L525	●	1742-0350D525	■
0.0350	1/8	0.052	2 1/2	0.700	1742-0350.700	●	1742-0350L700	●	1742-0350D700	■
0.0394	1/8	0.059	2 1/2	0.117	1742-0394.117	●	1742-0394L117	●	1742-0394D117	■
0.0394	1/8	0.059	2 1/2	0.203	1742-0394.203	●	1742-0394L203	●	1742-0394D203	■
0.0394	1/8	0.059	2 1/2	0.325	1742-0394.325	●	1742-0394L325	●	1742-0394D325	■
0.0394	1/8	0.059	2 1/2	0.480	1742-0394.480	●	1742-0394L480	●	1742-0394D480	■
0.0400	1/8	0.060	2 1/2	0.120	1742-0400.120	●	1742-0400L120	●	1742-0400D120	■
0.0400	1/8	0.060	2 1/2	0.203	1742-0400.203	●	1742-0400L203	●	1742-0400D203	■
0.0400	1/8	0.060	2 1/2	0.325	1742-0400.325	●	1742-0400L325	●	1742-0400D325	■
0.0400	1/8	0.060	2 1/2	0.480	1742-0400.480	●	1742-0400L480	●	1742-0400D480	■
0.0400	1/8	0.060	2 1/2	0.600	1742-0400.600	●	1742-0400L600	●	1742-0400D600	■
0.0400	1/8	0.060	2 1/2	0.800	1742-0400.800	●	1742-0400L800	●	1742-0400D800	■
0.0450	1/8	0.067	2 1/2	0.135	1742-0450.135	●	1742-0450L135	●	1742-0450D135	■
0.0450	1/8	0.067	2 1/2	0.225	1742-0450.225	●	1742-0450L225	●	1742-0450D225	■
0.0450	1/8	0.067	2 1/2	0.375	1742-0450.375	●	1742-0450L375	●	1742-0450D375	■
0.0450	1/8	0.067	2 1/2	0.550	1742-0450.550	●	1742-0450L550	●	1742-0450D550	■
0.0450	1/8	0.067	2 1/2	0.680	1742-0450.680	●	1742-0450L680	●	1742-0450D680	■
0.0450	1/8	0.067	2 1/2	0.900	1742-0450.900	●	1742-0450L900	●	1742-0450D900	■

\*DLC is Amorphous Diamond

SERIES 1742 WORKPIECE MATERIAL															
Coating	P Steel ~30HRC	P Steel 30-40HRC	H Hardened Steel ~55HRC	H Hardened Steel ~68HRC	M Stainless Steel	K Cast Iron	N Aluminum	N Graphite	N Copper Alloy	N CFRP	N Plastic	N Thermoset Plastic	N High Density Plastic	S Nickel / Cobalt	S Titanium Alloy
AlTiN	★	★	★	☆	☆	☆								☆	☆
DLC							☆	★	☆	★	★	★			
Uncoated							☆	☆	☆	☆	☆	☆	☆		☆

★ : Priority ☆ : Applicable Materials

Symbol Descriptions [Page vii](#)

- : U.S. Stock Standard
- : NOT STOCKED - Call for Delivery
- ▲ : Coming Soon

(U.S.) 1.888.848.8449  
(International) 001.714.428.3636  
Pricing & Availability at [KyoceraPrecisionTools.com](http://KyoceraPrecisionTools.com)

## 3 FLUTE NEW

**0.0469" - 0.0625" DIAMETER**

Mirror Surface Finishes

Sub Micron Grain Carbide

**EXTENDED REACH STUB LENGTH SQUARE END MILLS  
DEEP REACH MILLING**



### EXTENDED Reach **STUB** Length (Inch Sizes)

Dimensions (in)		Uncoated		AlTiN Coating		NEW DLC* Coating				
D	d	ℓ	L	L <sub>1</sub>	Part Number	Stock	Part Number	Stock	Part Number	Stock
0.0469 (3/64)	1/8	0.070	2 1/2	0.141	1742-0469.141	●	1742-0469L141	●	1742-0469D141	■
0.0469 (3/64)	1/8	0.070	2 1/2	0.250	1742-0469.250	●	1742-0469L250	●	1742-0469D250	■
0.0469 (3/64)	1/8	0.070	2 1/2	0.375	1742-0469.375	●	1742-0469L375	●	1742-0469D375	■
0.0469 (3/64)	1/8	0.070	2 1/2	0.480	1742-0469.480	●	1742-0469L480	●	1742-0469D480	■
0.0469 (3/64)	1/8	0.070	2 1/2	0.570	1742-0469.570	●	1742-0469L570	●	1742-0469D570	■
0.0469 (3/64)	1/8	0.070	2 1/2	0.710	1742-0469.710	●	1742-0469L710	●	1742-0469D710	■
0.0469 (3/64)	1/8	0.070	2 1/2	0.950	1742-0469.950	●	1742-0469L950	●	1742-0469D950	■
0.0469 (3/64)	1/8	0.070	2 1/2	1.187	1742-0469.1187	●	1742-0469L1187	●	1742-0469D1187	■
0.0500	1/8	0.075	2 1/2	0.150	1742-0500.150	●	1742-0500L150	●	1742-0500D150	■
0.0500	1/8	0.075	2 1/2	0.250	1742-0500.250	●	1742-0500L250	●	1742-0500D250	■
0.0500	1/8	0.075	2 1/2	0.400	1742-0500.400	●	1742-0500L400	●	1742-0500D400	■
0.0500	1/8	0.075	2 1/2	0.600	1742-0500.600	●	1742-0500L600	●	1742-0500D600	■
0.0500	1/8	0.075	2 1/2	0.750	1742-0500.750	●	1742-0500L750	●	1742-0500D750	■
0.0550	1/8	0.082	2 1/2	0.165	1742-0550.165	●	1742-0550L165	●	1742-0550D165	■
0.0550	1/8	0.082	2 1/2	0.275	1742-0550.275	●	1742-0550L275	●	1742-0550D275	■
0.0550	1/8	0.082	2 1/2	0.450	1742-0550.450	●	1742-0550L450	●	1742-0550D450	■
0.0550	1/8	0.082	2 1/2	0.660	1742-0550.660	●	1742-0550L660	●	1742-0550D660	■
0.0550	1/8	0.082	2 1/2	0.825	1742-0550.825	●	1742-0550L825	●	1742-0550D825	■
0.0600	1/8	0.090	2 1/2	0.180	1742-0600.180	●	1742-0600L180	●	1742-0600D180	■
0.0600	1/8	0.090	2 1/2	0.312	1742-0600.312	●	1742-0600L312	●	1742-0600D312	■
0.0600	1/8	0.090	2 1/2	0.500	1742-0600.500	●	1742-0600L500	●	1742-0600D500	■
0.0600	1/8	0.090	2 1/2	0.720	1742-0600.720	●	1742-0600L720	●	1742-0600D720	■
0.0600	1/8	0.090	2 1/2	0.900	1742-0600.900	●	1742-0600L900	●	1742-0600D900	■
0.0625 (1/16)	1/8	0.093	2 1/2	0.186	1742-0625.186	●	1742-0625L186	●	1742-0625D186	■
0.0625 (1/16)	1/8	0.093	2 1/2	0.312	1742-0625.312	●	1742-0625L312	●	1742-0625D312	■
0.0625 (1/16)	1/8	0.093	2 1/2	0.500	1742-0625.500	●	1742-0625L500	●	1742-0625D500	■
0.0625 (1/16)	1/8	0.093	2 1/2	0.625	1742-0625.625	●	1742-0625L625	●	1742-0625D625	■
0.0625 (1/16)	1/8	0.093	2 1/2	0.750	1742-0625.750	●	1742-0625L750	●	1742-0625D750	■
0.0625 (1/16)	1/8	0.093	2 1/2	0.950	1742-0625.950	●	1742-0625L950	●	1742-0625D950	■
0.0625 (1/16)	1/8	0.093	2 1/2	1.125	1742-0625.1125	●	1742-0625L1125	●	1742-0625D1125	■
0.0625 (1/16)	1/8	0.093	2 1/2	1.250	1742-0625.1250	●	1742-0625L1250	●	1742-0625D1250	■
0.0625 (1/16)	1/8	0.093	3	1.550	1742-0625.1550	●	1742-0625L1550	●	1742-0625D1550	■

\*DLC is Amorphous Diamond

SERIES 1742 WORKPIECE MATERIAL															
Coating	P	P	H	H	M	K	N	N	N	N	N	N	S	S	
	Steel -30HRC	Steel 30-40HRC	Hardened Steel -55HRC	Hardened Steel -68HRC	Stainless Steel	Cast Iron	Aluminum	Graphite	Copper Alloy	CFRP	Plastic	Thermoset Plastic	High Density Plastic	Nickel / Cobalt	Titanium Alloy
AlTiN	★	★	★	☆	☆	☆								☆	☆
DLC							☆	★	☆	★	★	★			
Uncoated							☆	☆	☆	☆	☆	☆	☆		☆

★ : Priority ☆ : Applicable Materials

Symbol Descriptions [Page vii](#)

## 3 FLUTE NEW

**0.0650" - 0.0938" DIAMETER**

Mirror Surface Finishes

Sub Micron Grain Carbide

**EXTENDED REACH STUB LENGTH SQUARE END MILLS**  
**DEEP REACH MILLING**



### EXTENDED Reach **STUB** Length (Inch Sizes)

Dimensions (in)					Uncoated		AlTiN Coating		<span style="color:red">NEW</span> DLC* Coating	
D <sup>+0.000</sup> / <sub>-0.001</sub>	d	ℓ	L	L <sub>1</sub>	Part Number	Stock	Part Number	Stock	Part Number	Stock
0.0650	1/8	0.097	2 1/2	0.325	1742-0650.325	●	1742-0650L325	●	1742-0650D325	■
0.0650	1/8	0.097	2 1/2	0.530	1742-0650.530	●	1742-0650L530	●	1742-0650D530	■
0.0650	1/8	0.097	2 1/2	0.800	1742-0650.800	●	1742-0650L800	●	1742-0650D800	■
0.0700	1/8	0.105	2 1/2	0.375	1742-0700.375	●	1742-0700L375	●	1742-0700D375	■
0.0700	1/8	0.105	2 1/2	0.570	1742-0700.570	●	1742-0700L570	●	1742-0700D570	■
0.0700	1/8	0.105	2 1/2	0.850	1742-0700.850	●	1742-0700L850	●	1742-0700D850	■
0.0750	1/8	0.112	2 1/2	0.375	1742-0750.375	●	1742-0750L375	●	1742-0750D375	■
0.0750	1/8	0.112	2 1/2	0.625	1742-0750.625	●	1742-0750L625	●	1742-0750D625	■
0.0750	1/8	0.112	2 1/2	0.900	1742-0750.900	●	1742-0750L900	●	1742-0750D900	■
0.0781 (5/64)	1/8	0.117	2 1/2	0.234	1742-0781.234	●	1742-0781L234	●	1742-0781D234	■
0.0781 (5/64)	1/8	0.117	2 1/2	0.406	1742-0781.406	●	1742-0781L406	●	1742-0781D406	■
0.0781 (5/64)	1/8	0.117	2 1/2	0.625	1742-0781.625	●	1742-0781L625	●	1742-0781D625	■
0.0781 (5/64)	1/8	0.117	2 1/2	0.800	1742-0781.800	●	1742-0781L800	●	1742-0781D800	■
0.0781 (5/64)	1/8	0.117	2 1/2	0.940	1742-0781.940	●	1742-0781L940	●	1742-0781D940	■
0.0781 (5/64)	1/8	0.117	2 1/2	1.187	1742-0781.1187	●	1742-0781L1187	●	1742-0781D1187	■
0.0781 (5/64)	1/8	0.117	3	1.562	1742-0781.1562	●	1742-0781L1562	●	1742-0781D1562	■
0.0781 (5/64)	1/8	0.117	3	1.950	1742-0781.1950	●	1742-0781L1950	●	1742-0781D1950	■
0.0800	1/8	0.120	2 1/2	0.406	1742-0800.406	●	1742-0800L406	●	1742-0800D406	■
0.0800	1/8	0.120	2 1/2	0.650	1742-0800.650	●	1742-0800L650	●	1742-0800D650	■
0.0800	1/8	0.120	2 1/2	0.960	1742-0800.960	●	1742-0800L960	●	1742-0800D960	■
0.0850	1/8	0.127	2 1/2	0.425	1742-0850.425	●	1742-0850L425	●	1742-0850D425	■
0.0850	1/8	0.127	2 1/2	0.700	1742-0850.700	●	1742-0850L700	●	1742-0850D700	■
0.0850	1/8	0.127	2 1/2	1.020	1742-0850.1020	●	1742-0850L1020	●	1742-0850D1020	■
0.0900	1/8	0.135	2 1/2	0.450	1742-0900.450	●	1742-0900L450	●	1742-0900D450	■
0.0900	1/8	0.135	2 1/2	0.750	1742-0900.750	●	1742-0900L750	●	1742-0900D750	■
0.0900	1/8	0.135	2 1/2	1.080	1742-0900.1080	●	1742-0900L1080	●	1742-0900D1080	■
0.0938 (3/32)	1/8	0.139	2 1/2	0.279	1742-0938.279	●	1742-0938L279	●	1742-0938D279	■
0.0938 (3/32)	1/8	0.139	2 1/2	0.500	1742-0938.500	●	1742-0938L500	●	1742-0938D500	■
0.0938 (3/32)	1/8	0.139	2 1/2	0.750	1742-0938.750	●	1742-0938L750	●	1742-0938D750	■
0.0938 (3/32)	1/8	0.139	2 1/2	0.950	1742-0938.950	●	1742-0938L950	●	1742-0938D950	■
0.0938 (3/32)	1/8	0.139	2 1/2	1.125	1742-0938.1125	●	1742-0938L1125	●	1742-0938D1125	■
0.0938 (3/32)	1/8	0.139	3	1.400	1742-0938.1400	●	1742-0938L1400	●	1742-0938D1400	■
0.0938 (3/32)	1/8	0.139	3	1.675	1742-0938.1675	●	1742-0938L1675	●	1742-0938D1675	■
0.0938 (3/32)	1/8	0.139	4	1.875	1742-0938.1875	●	1742-0938L1875	●	1742-0938D1875	■
0.0938 (3/32)	1/8	0.139	4	2.312	1742-0938.2312	●	1742-0938L2312	●	1742-0938D2312	■

\*DLC is Amorphous Diamond

SERIES 1742 WORKPIECE MATERIAL															
Coating	P	P	H	H	M	K	N	N	N	N	N	N	S	S	
	Steel ~30HRC	Steel 30-40HRC	Hardened Steel ~55HRC	Hardened Steel ~68HRC	Stainless Steel	Cast Iron	Aluminum	Graphite	Copper Alloy	CFRP	Plastic	Thermoset Plastic	High Density Plastic	Nickel / Cobalt	Titanium Alloy
AlTiN	★	★	★	☆	☆	☆								☆	☆
DLC							☆	★	☆	★	★	★			
Uncoated							☆	☆	☆	☆	☆	☆	☆		☆

★ : Priority ☆ : Applicable Materials

Symbol Descriptions [Page vii](#)

● : U.S. Stock Standard  
■ : NOT STOCKED - Call for Delivery  
▲ : Coming Soon

(U.S.) 1.888.848.8449  
(International) 001.714.428.3636  
Pricing & Availability at [KyoceraPrecisionTools.com](http://KyoceraPrecisionTools.com)

DRILLS **A**  
END MILLS **B**  
ROUTERS **C**  
THREAD MILLS & TAPS **D**  
ENGRAVERS **E**  
BORING BARS **F**  
REAMERS **G**  
SAWS **H**  
TECHNICAL **I**  
INDEX **J**

## 3 FLUTE NEW

**0.0950" - 0.2500" DIAMETER**

Mirror Surface Finishes

Sub Micron Grain Carbide

**EXTENDED REACH STUB LENGTH SQUARE END MILLS  
DEEP REACH MILLING**

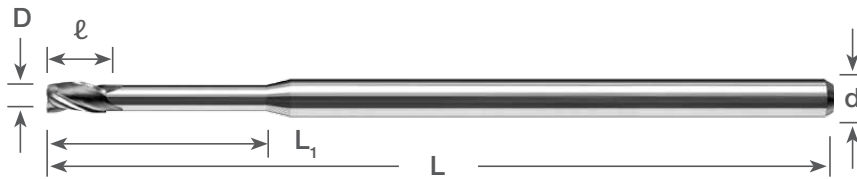

### EXTENDED Reach **STUB** Length (Inch Sizes)

Dimensions (in)					Uncoated		AlTiN Coating		<span style="color:red">NEW</span> DLC* Coating	
D	d	ℓ	L	L <sub>1</sub>	Part Number	Stock	Part Number	Stock	Part Number	Stock
0.0950	1/8	0.142	2 1/2	0.500	1742-0950.500	●	1742-0950L500	●	1742-0950D500	■
0.0950	1/8	0.142	2 1/2	0.750	1742-0950.750	●	1742-0950L750	●	1742-0950D750	■
0.0950	1/8	0.142	2 1/2	1.150	1742-0950.1150	●	1742-0950L1150	●	1742-0950D1150	■
0.1000	1/8	0.150	2 1/2	0.500	1742-1000.500	●	1742-1000L500	●	1742-1000D500	■
0.1000	1/8	0.150	2 1/2	0.800	1742-1000.800	●	1742-1000L800	●	1742-1000D800	■
0.1000	1/8	0.150	2 1/2	1.200	1742-1000.1200	●	1742-1000L1200	●	1742-1000D1200	■
0.1250 (1/8)	1/8	0.187	2 1/2	0.625	1742-1250.625	●	1742-1250L625	●	1742-1250D625	■
0.1250 (1/8)	1/8	0.187	2 1/2	1.000	1742-1250.1000	●	1742-1250L1000	●	1742-1250D1000	■
0.1250 (1/8)	1/8	0.187	2 1/2	1.250	1742-1250.1250	●	1742-1250L1250	●	1742-1250D1250	■
0.1250 (1/8)	1/8	0.187	3	1.500	1742-1250.1500	●	1742-1250L1500	●	1742-1250D1500	■
0.1250 (1/8)	1/8	0.187	3	1.875	1742-1250.1875	●	1742-1250L1875	●	1742-1250D1875	■
0.1250 (1/8)	1/8	0.187	4	2.250	1742-1250.2250	●	1742-1250L2250	●	1742-1250D2250	■
0.1250 (1/8)	1/8	0.187	4	2.500	1742-1250.2500	●	1742-1250L2500	●	1742-1250D2500	■
0.1250 (1/8)	1/8	0.187	4	3.125	1742-1250.3125	●	1742-1250L3125	●	1742-1250D3125	■
0.1562 (5/32)	3/16	0.234	3	0.750	1742-1562.750	●	1742-1562L750	●	1742-1562D750	■
0.1562 (5/32)	3/16	0.234	3	1.250	1742-1562.1250	●	1742-1562L1250	●	1742-1562D1250	■
0.1562 (5/32)	3/16	0.234	4	1.875	1742-1562.1875	●	1742-1562L1875	●	1742-1562D1875	■
0.1875 (3/16)	3/16	0.281	3	1.000	1742-1875.1000	●	1742-1875L1000	●	1742-1875D1000	■
0.1875 (3/16)	3/16	0.281	3	1.500	1742-1875.1500	●	1742-1875L1500	●	1742-1875D1500	■
0.1875 (3/16)	3/16	0.281	4	1.875	1742-1875.1875	●	1742-1875L1875	●	1742-1875D1875	■
0.1875 (3/16)	3/16	0.281	4	2.250	1742-1875.2250	●	1742-1875L2250	●	1742-1875D2250	■
0.1875 (3/16)	3/16	0.281	4	2.812	1742-1875.2812	●	1742-1875L2812	●	1742-1875D2812	■
0.2500 (1/4)	1/4	0.375	4	1.250	1742-2500.1250	●	1742-2500L1250	●	1742-2500D1250	■
0.2500 (1/4)	1/4	0.375	4	2.000	1742-2500.2000	●	1742-2500L2000	●	1742-2500D2000	■
0.2500 (1/4)	1/4	0.375	4	2.500	1742-2500.2500	●	1742-2500L2500	●	1742-2500D2500	■
0.2500 (1/4)	1/4	0.375	6	3.000	1742-2500.3000	●	1742-2500L3000	●	1742-2500D3000	■
0.2500 (1/4)	1/4	0.375	6	3.750	1742-2500.3750	●	1742-2500L3750	●	1742-2500D3750	■

\*DLC is Amorphous Diamond

### SERIES 1742 WORKPIECE MATERIAL

Coating	P Steel -30HRC	P Steel 30-40HRC	H Hardened Steel -55HRC	H Hardened Steel -68HRC	M Stainless Steel	K Cast Iron	N Aluminum	N Graphite	N Copper Alloy	N CFRP	N Plastic	N Thermoset Plastic	N High Density Plastic	S Nickel / Cobalt	S Titanium Alloy
AlTiN	★	★	★	☆	☆	☆								☆	☆
DLC							☆	★	☆	★	★	★			
Uncoated							☆	☆	☆	☆	☆	☆	☆		☆

★ : Priority ☆ : Applicable Materials

Symbol Descriptions [Page vii](#)

## 4 FLUTE

STANDARD LENGTH SQUARE END MILLS  
GENERAL PURPOSE MACHINING

0.0050" - 0.0340" DIAMETER

Mirror Surface Finishes

Sub Micron Grain Carbide

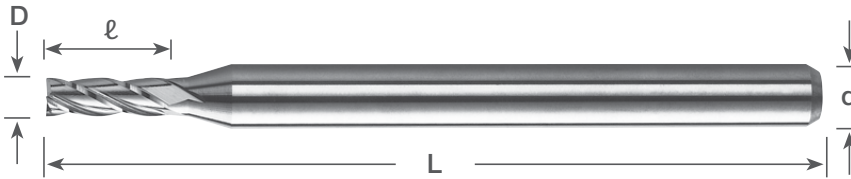

### STANDARD Length (Inch Sizes)

Dimensions (in)				Uncoated		AlTiN Coating		NEW DLC* Coating	
D <sup>+0.000</sup> <sub>-0.001</sub>	d	ℓ	L	Part Number	Stock	Part Number	Stock	Part Number	Stock
0.0050	1/8	0.015	1 1/2	1810-0050.015	●	1810-0050L015	●	-	-
NEW 0.0060	1/8	0.018	1 1/2	1810-0060.018	●	1810-0060L018	●	-	-
NEW 0.0070	1/8	0.021	1 1/2	1810-0070.021	●	1810-0070L021	●	-	-
NEW 0.0080	1/8	0.024	1 1/2	1810-0080.024	●	1810-0080L024	●	-	-
NEW 0.0090	1/8	0.027	1 1/2	1810-0090.027	●	1810-0090L027	●	-	-
0.0100	1/8	0.030	1 1/2	1810-0100.030	●	1810-0100L030	●	1810-0100D030	■
NEW 0.0110	1/8	0.033	1 1/2	1810-0110.033	●	1810-0110L033	●	-	-
NEW 0.0120	1/8	0.036	1 1/2	1810-0120.036	●	1810-0120L036	●	-	-
NEW 0.0130	1/8	0.039	1 1/2	1810-0130.039	●	1810-0130L039	●	-	-
NEW 0.0140	1/8	0.042	1 1/2	1810-0140.042	●	1810-0140L042	●	-	-
0.0150	1/8	0.045	1 1/2	1810-0150.045	●	1810-0150L045	●	1810-0150D045	■
0.0156 (1/64)	1/8	0.047	1 1/2	1810-0156.047	●	1810-0156L047	●	1810-0156D047	■
NEW 0.0160	1/8	0.048	1 1/2	1810-0160.048	●	1810-0160L048	●	-	-
NEW 0.0170	1/8	0.051	1 1/2	1810-0170.051	●	1810-0170L051	●	-	-
NEW 0.0180	1/8	0.054	1 1/2	1810-0180.054	●	1810-0180L054	●	-	-
NEW 0.0190	1/8	0.057	1 1/2	1810-0190.057	●	1810-0190L057	●	-	-
0.0200	1/8	0.060	1 1/2	1810-0200.060	●	1810-0200L060	●	1810-0200D060	■
NEW 0.0210	1/8	0.063	1 1/2	1810-0210.063	●	1810-0210L063	●	-	-
NEW 0.0220	1/8	0.066	1 1/2	1810-0220.066	●	1810-0220L066	●	-	-
NEW 0.0230	1/8	0.069	1 1/2	1810-0230.069	●	1810-0230L069	●	-	-
NEW 0.0240	1/8	0.072	1 1/2	1810-0240.072	●	1810-0240L072	●	-	-
0.0250	1/8	0.075	1 1/2	1810-0250.075	●	1810-0250L075	●	1810-0250D075	■
NEW 0.0260	1/8	0.078	1 1/2	1810-0260.078	●	1810-0260L078	●	-	-
NEW 0.0270	1/8	0.081	1 1/2	1810-0270.081	●	1810-0270L081	●	-	-
NEW 0.0280	1/8	0.084	1 1/2	1810-0280.084	●	1810-0280L084	●	-	-
NEW 0.0290	1/8	0.087	1 1/2	1810-0290.087	●	1810-0290L087	●	-	-
0.0300	1/8	0.090	1 1/2	1810-0300.090	●	1810-0300L090	●	1810-0300D090	■
0.0312 (1/32)	1/8	0.094	1 1/2	1810-0312.094	●	1810-0312L094	●	1810-0312D094	■
NEW 0.0320	1/8	0.096	1 1/2	1810-0320.096	●	1810-0320L096	●	-	-
NEW 0.0330	1/8	0.099	1 1/2	1810-0330.099	●	1810-0330L099	●	-	-
NEW 0.0340	1/8	0.102	1 1/2	1810-0340.102	●	1810-0340L102	●	-	-

\*DLC is Amorphous Diamond

SERIES 1810 WORKPIECE MATERIAL															
Coating	P Steel ~30HRC	P Steel 30~40HRC	H Hardened Steel ~55HRC	H Hardened Steel ~68HRC	M Stainless Steel	K Cast Iron	N Aluminum	N Graphite	N Copper Alloy	N CFRP	N Plastic	N Thermoset Plastic	N High Density Plastic	S Nickel / Cobalt	S Titanium Alloy
AlTiN	★	★	★	☆	☆	☆								☆	☆
DLC							☆	★	☆	★	★	★			
Uncoated							☆	☆	☆	☆	☆	☆	☆		☆

★ : Priority ☆ : Applicable Materials

Symbol Descriptions Page vii

- : U.S. Stock Standard
- : NOT STOCKED - Call for Delivery
- ▲ : Coming Soon

(U.S.) 1.888.848.8449  
(International) 001.714.428.3636  
Pricing & Availability at [KyoceraPrecisionTools.com](http://KyoceraPrecisionTools.com)



# 4 FLUTE

0.0350" - 0.0781" DIAMETER

Mirror Surface Finishes

Sub Micron Grain Carbide

STANDARD LENGTH SQUARE END MILLS  
GENERAL PURPOSE MACHINING

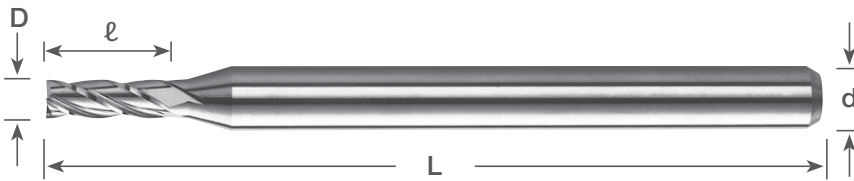

## STANDARD Length (Inch Sizes)

	Dimensions (in)				Uncoated		AlTiN Coating		NEW DLC* Coating	
	D <sup>+0.000</sup> / <sub>-0.001</sub>	d	ℓ	L	Part Number	Stock	Part Number	Stock	Part Number	Stock
	0.0350	1/8	0.105	1 1/2	1810-0350.105	●	1810-0350L105	●	1810-0350D105	■
NEW	0.0360	1/8	0.108	1 1/2	1810-0360.108	●	1810-0360L108	●	-	-
NEW	0.0370	1/8	0.111	1 1/2	1810-0370.111	●	1810-0370L111	●	-	-
NEW	0.0380	1/8	0.114	1 1/2	1810-0380.114	●	1810-0380L114	●	-	-
NEW	0.0394	1/8	0.117	1 1/2	1810-0394.117	●	1810-0394L117	●	1810-0394D117	■
	0.0400	1/8	0.120	1 1/2	1810-0400.120	●	1810-0400L120	●	1810-0400D120	■
NEW	0.0410	1/8	0.123	1 1/2	1810-0410.123	●	1810-0410L123	●	-	-
NEW	0.0420	1/8	0.126	1 1/2	1810-0420.126	●	1810-0420L126	●	-	-
NEW	0.0430	1/8	0.129	1 1/2	1810-0430.129	●	1810-0430L129	●	-	-
NEW	0.0440	1/8	0.132	1 1/2	1810-0440.132	●	1810-0440L132	●	-	-
	0.0450	1/8	0.135	1 1/2	1810-0450.135	●	1810-0450L135	●	1810-0450D135	■
NEW	0.0460	1/8	0.138	1 1/2	1810-0460.138	●	1810-0460L138	●	-	-
	0.0469 (3/64)	1/8	0.141	1 1/2	1810-0469.141	●	1810-0469L141	●	1810-0469D141	■
NEW	0.0480	1/8	0.144	1 1/2	1810-0480.144	●	1810-0480L144	●	-	-
NEW	0.0490	1/8	0.147	1 1/2	1810-0490.147	●	1810-0490L147	●	-	-
	0.0500	1/8	0.150	1 1/2	1810-0500.150	●	1810-0500L150	●	1810-0500D150	■
NEW	0.0510	1/8	0.153	1 1/2	1810-0510.153	●	1810-0510L153	●	-	-
NEW	0.0520	1/8	0.156	1 1/2	1810-0520.156	●	1810-0520L156	●	-	-
NEW	0.0530	1/8	0.159	1 1/2	1810-0530.159	●	1810-0530L159	●	-	-
NEW	0.0540	1/8	0.162	1 1/2	1810-0540.162	●	1810-0540L162	●	-	-
	0.0550	1/8	0.165	1 1/2	1810-0550.165	●	1810-0550L165	●	1810-0550D165	■
NEW	0.0560	1/8	0.168	1 1/2	1810-0560.168	●	1810-0560L168	●	-	-
NEW	0.0570	1/8	0.171	1 1/2	1810-0570.171	●	1810-0570L171	●	-	-
NEW	0.0580	1/8	0.174	1 1/2	1810-0580.174	●	1810-0580L174	●	-	-
NEW	0.0590	1/8	0.177	1 1/2	1810-0590.177	●	1810-0590L177	●	-	-
	0.0600	1/8	0.180	1 1/2	1810-0600.180	●	1810-0600L180	●	1810-0600D180	■
	0.0625 (1/16)	1/8	0.188	1 1/2	1810-0625.188	●	1810-0625L188	●	1810-0625D188	■
	0.0650	1/8	0.195	1 1/2	1810-0650.195	●	1810-0650L195	●	1810-0650D195	■
	0.0700	1/8	0.210	1 1/2	1810-0700.210	●	1810-0700L210	●	1810-0700D210	■
	0.0750	1/8	0.225	1 1/2	1810-0750.225	●	1810-0750L225	●	1810-0750D225	■
	0.0781 (5/64)	1/8	0.234	1 1/2	1810-0781.234	●	1810-0781L234	●	1810-0781D234	■

\*DLC is Amorphous Diamond

### SERIES 1810 WORKPIECE MATERIAL

Coating	P Steel -30HRC	P Steel 30-40HRC	H Hardened Steel -55HRC	H Hardened Steel -68HRC	M Stainless Steel	K Cast Iron	N Aluminum	N Graphite	N Copper Alloy	N CFRP	N Plastic	N Thermoset Plastic	N High Density Plastic	S Nickel / Cobalt	S Titanium Alloy
AlTiN	★	★	★	☆	☆	☆								☆	☆
DLC							☆	★	☆	★	★	★			
Uncoated							☆	☆	☆	☆	☆	☆	☆		☆

★ : Priority ☆ : Applicable Materials

Symbol Descriptions Page vii

## 4 FLUTE

STANDARD LENGTH SQUARE END MILLS  
GENERAL PURPOSE MACHINING

**0.0800" - 0.2500" DIAMETER**

Mirror Surface Finishes

Sub Micron Grain Carbide

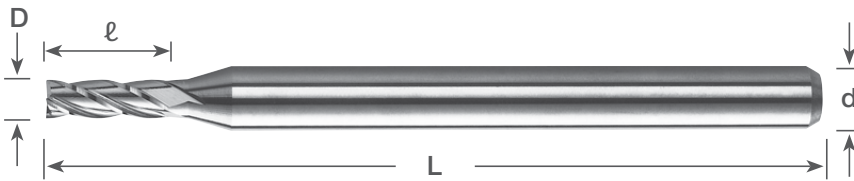

### STANDARD Length (Inch Sizes)

Dimensions (in)				Uncoated		AlTiN Coating		NEW DLC* Coating	
D <sup>+0.000</sup> <sub>-0.001</sub>	d	ℓ	L	Part Number	Stock	Part Number	Stock	Part Number	Stock
0.0800	1/8	0.240	1 1/2	1810-0800.240	●	1810-0800L240	●	1810-0800D240	■
0.0850	1/8	0.255	1 1/2	1810-0850.255	●	1810-0850L255	●	1810-0850D255	■
0.0900	1/8	0.270	1 1/2	1810-0900.270	●	1810-0900L270	●	1810-0900D270	■
0.0938 (3/32)	1/8	0.281	1 1/2	1810-0938.281	●	1810-0938L281	●	1810-0938D281	■
0.0950	1/8	0.285	1 1/2	1810-0950.285	●	1810-0950L285	●	1810-0950D285	■
0.1000	1/8	0.300	1 1/2	1810-1000.300	●	1810-1000L300	●	1810-1000D300	■
NEW 0.1050	1/8	0.315	1 1/2	1810-1050.315	●	1810-1050L315	●	1810-1050D315	■
0.1094 (7/64)	1/8	0.328	1 1/2	1810-1094.328	●	1810-1094L328	●	1810-1094D328	■
NEW 0.1100	1/8	0.330	1 1/2	1810-1100.330	●	1810-1100L330	●	1810-1100D330	■
NEW 0.1150	1/8	0.345	1 1/2	1810-1150.345	●	1810-1150L345	●	1810-1150D345	■
NEW 0.1181	1/8	0.355	1 1/2	1810-1181.355	●	1810-1181L355	●	1810-1181D355	■
NEW 0.1200	1/8	0.360	1 1/2	1810-1200.360	●	1810-1200L360	●	1810-1200D360	■
0.1250 (1/8)	1/8	0.375	1 1/2	1810-1250.375	●	1810-1250L375	●	1810-1250D375	■
0.1406 (9/64)	3/16	0.500	2	1810-1406.500	●	1810-1406L500	●	1810-1406D500	■
NEW 0.1406 (9/64)	3/16	0.562	2	1810-1406.562	●	1810-1406L562	●	1810-1406D562	■
NEW 0.1562 (5/32)	3/16	0.562	2	1810-1562.562	●	1810-1562L562	●	1810-1562D562	■
NEW 0.1562 (5/32)	3/16	1.000	3	1810-1562.1000	●	1810-1562L1000	●	1810-1562D1000	■
NEW 0.1562 (5/32)	3/16	1.875	4	1810-1562.1875	●	1810-1562L1875	●	1810-1562D1875	■
0.1563 (5/32)	3/16	0.500	2	1810-1563.500	●	1810-1563L500	●	1810-1563D500	■
0.1719 (11/64)	3/16	0.563	2	1810-1719.563	●	1810-1719L563	●	1810-1719D563	■
0.1875 (3/16)	3/16	0.563	2	1810-1875.563	●	1810-1875L563	●	1810-1875D563	■
NEW 0.1875 (3/16)	3/16	0.625	2	1810-1875.625	●	1810-1875L625	●	1810-1875D625	■
NEW 0.1875 (3/16)	3/16	1.120	3	1810-1875.1125	●	1810-1875L1125	●	1810-1875D1125	■
NEW 0.1875 (3/16)	3/16	2.250	4	1810-1875.2250	●	1810-1875L2250	●	1810-1875D2250	■
0.2031 (13/64)	1/4	0.625	2 1/2	1810-2031.625	●	1810-2031L625	●	1810-2031D625	■
0.2188 (7/32)	1/4	0.625	2 1/2	1810-2188.625	●	1810-2188L625	●	1810-2188D625	■
0.2344 (15/64)	1/4	0.750	2 1/2	1810-2344.750	●	1810-2344L750	●	1810-2344D750	■
0.2500 (1/4)	1/4	0.750	2 1/2	1810-2500.750	●	1810-2500L750	●	1810-2500D750	■
NEW 0.2500 (1/4)	1/4	1.500	4	1810-2500.1500	●	1810-2500L1500	●	1810-2500D1500	■
NEW 0.2500 (1/4)	1/4	3.000	6	1810-2500.3000	●	1810-2500L3000	●	1810-2500D3000	■

\*DLC is Amorphous Diamond

SERIES 1810 WORKPIECE MATERIAL															
Coating	P Steel ~30HRC	P Steel 30~40HRC	H Hardened Steel ~55HRC	H Hardened Steel ~68HRC	M Stainless Steel	K Cast Iron	N Aluminum	N Graphite	N Copper Alloy	N CFRP	N Plastic	N Thermoset Plastic	N High Density Plastic	S Nickel / Cobalt	S Titanium Alloy
AlTiN	★	★	★	☆	☆	☆								☆	☆
DLC							☆	★	☆	★	★	★			
Uncoated							☆	☆	☆	☆	☆	☆	☆		☆

★ : Priority ☆ : Applicable Materials

Symbol Descriptions Page vii

- : U.S. Stock Standard
- : NOT STOCKED - Call for Delivery
- ▲ : Coming Soon

(U.S.) 1.888.848.8449  
(International) 001.714.428.3636  
Pricing & Availability at [KyoceraPrecisionTools.com](http://KyoceraPrecisionTools.com)

DRILLS A  
END MILLS B  
ROUTERS C  
THREAD MILLS & TAPS D  
ENGRAVERS E  
BORING BARS F  
REAMERS G  
SAWS H  
TECHNICAL I  
INDEX J

## 4 FLUTE

**0.10mm - 6.00mm DIAMETER**

Mirror Surface Finishes

Sub Micron Grain Carbide

STANDARD LENGTH SQUARE END MILLS  
GENERAL PURPOSE MACHINING

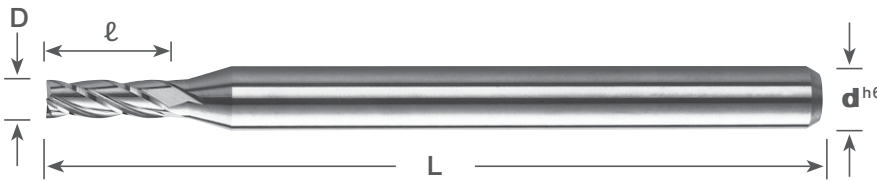

### STANDARD Length (Metric Sizes)

D	Dimensions (mm)			Uncoated		AlTiN Coating	
	$D^{+0.00mm/-0.02mm}$	$d^{h6}$	$l$	L	Part Number	Stock	Part Number
0.10	3	0.30	38	1810-0039.012	●	1810-0039L012	●
0.15	3	0.45	38	1810-0059.018	●	1810-0059L018	●
0.20	3	0.60	38	1810-0079.024	●	1810-0079L024	●
0.25	3	0.75	38	1810-0098.029	●	1810-0098L029	●
0.30	3	0.90	38	1810-0118.035	●	1810-0118L035	●
0.35	3	1.05	38	1810-0138.041	●	1810-0138L041	●
0.40	3	1.20	38	1810-0157.047	●	1810-0157L047	●
0.45	3	1.35	38	1810-0177.053	●	1810-0177L053	●
0.50	3	1.50	38	1810-0197.059	●	1810-0197L059	●
0.60	3	1.80	38	1810-0236.071	●	1810-0236L071	●
0.70	3	2.10	38	1810-0276.083	●	1810-0276L083	●
0.80	3	2.40	38	1810-0315.095	●	1810-0315L095	●
0.90	3	2.70	38	1810-0354.106	●	1810-0354L106	●
1.00	3	3.00	38	1810-0394.118	●	1810-0394L118	●
1.10	3	3.30	38	1810-0433.130	●	1810-0433L130	●
1.20	3	3.60	38	1810-0472.142	●	1810-0472L142	●
1.30	3	3.90	38	1810-0512.154	●	1810-0512L154	●
1.40	3	4.20	38	1810-0551.165	●	1810-0551L165	●
1.50	3	4.50	38	1810-0591.177	●	1810-0591L177	●
1.60	3	4.80	38	1810-0630.189	●	1810-0630L189	●
1.70	3	5.10	38	1810-0669.200	●	1810-0669L200	●
1.80	3	5.40	38	1810-0709.213	●	1810-0709L213	●
1.90	3	5.70	38	1810-0748.224	●	1810-0748L224	●
2.00	3	6.00	38	1810-0787.236	●	1810-0787L236	●
2.50	3	7.50	38	1810-0984.295	●	1810-0984L295	●
2.80	3	9.00	38	1810-1102.354	●	1810-1102L354	●
3.00	3	9.00	38	1810-1181.354	●	1810-1181L354	●
3.50	4	10.50	50	1810-1378.413	●	1810-1378L413	●
3.80	5	12.00	50	1810-1496.473	●	1810-1496L473	●
4.00	5	12.00	50	1810-1575.473	●	1810-1575L473	●
4.50	5	13.50	50	1810-1772.532	●	1810-1772L532	●
4.80	5	15.00	50	1810-1890.590	●	1810-1890L590	●
5.00	5	15.00	50	1810-1968.590	●	1810-1968L590	●
5.50	6	16.50	50	1810-2165.650	●	1810-2165L650	●
5.80	6	18.00	50	1810-2283.709	●	1810-2283L709	●
6.00	6	18.00	50	1810-2362.709	●	1810-2362L709	●

### SERIES 1810 WORKPIECE MATERIAL

Coating	P	P	H	H	M	K	N	N	N	N	N	N	N	S	S
	Steel -30HRC	Steel 30-40HRC	Hardened Steel -55HRC	Hardened Steel -68HRC	Stainless Steel	Cast Iron	Aluminum	Graphite	Copper Alloy	CFRP	Plastic	Thermoset Plastic	High Density Plastic	Nickel / Cobalt	Titanium Alloy
AlTiN	★	★	★	☆	☆	☆								☆	☆
DLC							☆	★	☆	★	★	★			
Uncoated							☆	☆	☆	☆	☆	☆	☆		☆

★ : Priority ☆ : Applicable Materials

Symbol Descriptions [Page vii](#)

## 4 FLUTE

STUB LENGTH SQUARE END MILLS  
GENERAL PURPOSE MACHINING

0.0050" - 0.0394" DIAMETER

Mirror Surface Finishes

Sub Micron Grain Carbide

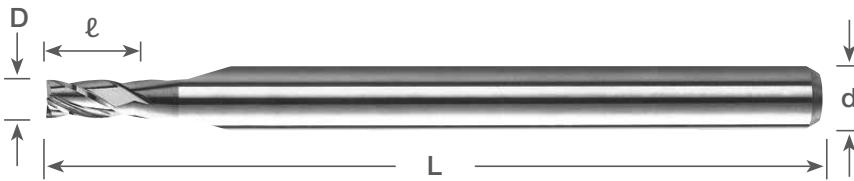

### STUB Length (Inch Sizes)

	Dimensions (in)				Uncoated		AlTiN Coating		NEW DLC* Coating	
	D <sup>+0.000</sup> / <sub>-0.001</sub>	d	ℓ	L	Part Number	Stock	Part Number	Stock	Part Number	Stock
NEW	0.0050	1/8	0.007	1 1/2	1820-0050.007	●	1820-0050L007	●	-	-
NEW	0.0060	1/8	0.009	1 1/2	1820-0060.009	●	1820-0060L009	●	-	-
NEW	0.0070	1/8	0.010	1 1/2	1820-0070.010	●	1820-0070L010	●	-	-
NEW	0.0080	1/8	0.012	1 1/2	1820-0080.012	●	1820-0080L012	●	-	-
NEW	0.0090	1/8	0.013	1 1/2	1820-0090.013	●	1820-0090L013	●	-	-
NEW	0.0100	1/8	0.015	1 1/2	1820-0100.015	●	1820-0100L015	●	1820-0100D015	■
NEW	0.0110	1/8	0.016	1 1/2	1820-0110.016	●	1820-0110L016	●	-	-
NEW	0.0120	1/8	0.018	1 1/2	1820-0120.018	●	1820-0120L018	●	-	-
NEW	0.0130	1/8	0.019	1 1/2	1820-0130.019	●	1820-0130L019	●	-	-
NEW	0.0140	1/8	0.021	1 1/2	1820-0140.021	●	1820-0140L021	●	-	-
NEW	0.0156 (1/64)	1/8	0.022	1 1/2	1820-0156.022	●	1820-0156L022	●	1820-0156D022	■
NEW	0.0160	1/8	0.024	1 1/2	1820-0160.024	●	1820-0160L024	●	-	-
NEW	0.0170	1/8	0.026	1 1/2	1820-0170.026	●	1820-0170L026	●	-	-
NEW	0.0180	1/8	0.027	1 1/2	1820-0180.027	●	1820-0180L027	●	-	-
NEW	0.0190	1/8	0.029	1 1/2	1820-0190.029	●	1820-0190L029	●	-	-
NEW	0.0200	1/8	0.030	1 1/2	1820-0200.030	●	1820-0200L030	●	1820-0200D030	■
NEW	0.0210	1/8	0.031	1 1/2	1820-0210.031	●	1820-0210L031	●	-	-
NEW	0.0220	1/8	0.033	1 1/2	1820-0220.033	●	1820-0220L033	●	-	-
NEW	0.0230	1/8	0.035	1 1/2	1820-0230.035	●	1820-0230L035	●	-	-
NEW	0.0240	1/8	0.036	1 1/2	1820-0240.036	●	1820-0240L036	●	-	-
NEW	0.0250	1/8	0.037	1 1/2	1820-0250.037	●	1820-0250L037	●	1820-0250D037	■
NEW	0.0260	1/8	0.039	1 1/2	1820-0260.039	●	1820-0260L039	●	-	-
NEW	0.0270	1/8	0.041	1 1/2	1820-0270.041	●	1820-0270L041	●	-	-
NEW	0.0280	1/8	0.042	1 1/2	1820-0280.042	●	1820-0280L042	●	-	-
NEW	0.0290	1/8	0.043	1 1/2	1820-0290.043	●	1820-0290L043	●	-	-
NEW	0.0300	1/8	0.045	1 1/2	1820-0300.045	●	1820-0300L045	●	1820-0300D045	■
	0.0312 (1/32)	1/8	0.047	1 1/2	1820-0312.047	●	1820-0312L047	●	-	-
NEW	0.0320	1/8	0.048	1 1/2	1820-0320.048	●	1820-0320L048	●	-	-
NEW	0.0330	1/8	0.049	1 1/2	1820-0330.049	●	1820-0330L049	●	-	-
NEW	0.0340	1/8	0.051	1 1/2	1820-0340.051	●	1820-0340L051	●	-	-
NEW	0.0350	1/8	0.052	1 1/2	1820-0350.052	●	1820-0350L052	●	1820-0350D052	■
NEW	0.0360	1/8	0.054	1 1/2	1820-0360.054	●	1820-0360L054	●	-	-
NEW	0.0370	1/8	0.055	1 1/2	1820-0370.055	●	1820-0370L055	●	-	-
NEW	0.0380	1/8	0.057	1 1/2	1820-0380.057	●	1820-0380L057	●	-	-
NEW	0.0394	1/8	0.058	1 1/2	1820-0394.058	●	1820-0394L058	●	1820-0394D058	■

\*DLC is Amorphous Diamond

SERIES 1820 WORKPIECE MATERIAL															
Coating	P	P	H	H	M	K	N	N	N	N	N	N	S	S	
	Steel ~30HRC	Steel 30~40HRC	Hardened Steel ~55HRC	Hardened Steel ~68HRC	Stainless Steel	Cast Iron	Aluminum	Graphite	Copper Alloy	CFRP	Plastic	Thermoset Plastic	High Density Plastic	Nickel / Cobalt	Titanium Alloy
AlTiN	★	★	★	☆	☆	☆								☆	☆
DLC							☆	★	☆	★	★	★			
Uncoated							☆	☆	☆	☆	☆	☆	☆		☆

★ : Priority ☆ : Applicable Materials

Symbol Descriptions Page vii

● : U.S. Stock Standard  
■ : NOT STOCKED - Call for Delivery  
▲ : Coming Soon

(U.S.) 1.888.848.8449  
(International) 001.714.428.3636  
Pricing & Availability at [KyoceraPrecisionTools.com](http://KyoceraPrecisionTools.com)

## 4 FLUTE

**0.0400" - 0.2500" DIAMETER**

Mirror Surface Finishes

Sub Micron Grain Carbide

**STUB LENGTH SQUARE END MILLS  
GENERAL PURPOSE MACHINING**

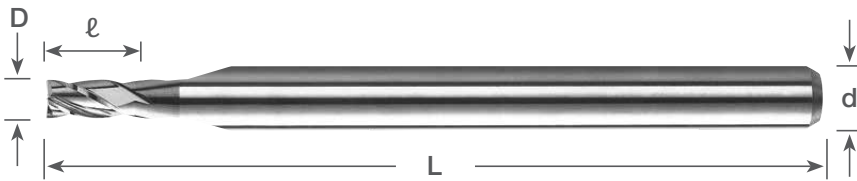

**STUB Length (Inch Sizes)**

	Dimensions (in)				Uncoated		AlTiN Coating		NEW DLC* Coating	
	D <sup>+0.000</sup> / <sub>-0.001</sub>	d	ℓ	L	Part Number	Stock	Part Number	Stock	Part Number	Stock
NEW	0.0400	1/8	0.060	1 1/2	1820-0400.060	●	1820-0400L060	●	1820-0400D060	■
NEW	0.0450	1/8	0.067	1 1/2	1820-0450.067	●	1820-0450L067	●	1820-0450D067	■
	0.0469 (3/64)	1/8	0.070	1 1/2	1820-0469.070	●	1820-0469L070	●	1820-0469D070	■
NEW	0.0500	1/8	0.075	1 1/2	1820-0500.075	●	1820-0500L075	●	1820-0500D075	■
NEW	0.0550	1/8	0.082	1 1/2	1820-0550.082	●	1820-0550L082	●	1820-0550D082	■
NEW	0.0600	1/8	0.090	1 1/2	1820-0600.090	●	1820-0600L090	●	1820-0600D090	■
	0.0625 (1/16)	1/8	0.094	1 1/2	1820-0625.094	●	1820-0625L094	●	1820-0625D094	■
NEW	0.0650	1/8	0.097	1 1/2	1820-0650.097	●	1820-0650L097	●	1820-0650D097	■
NEW	0.0700	1/8	0.105	1 1/2	1820-0700.105	●	1820-0700L105	●	1820-0700D105	■
NEW	0.0750	1/8	0.112	1 1/2	1820-0750.112	●	1820-0750L112	●	1820-0750D112	■
NEW	0.0781 (5/64)	1/8	0.117	1 1/2	1820-0781.117	●	1820-0781L117	●	1820-0781D117	■
	0.0781 (5/64)	1/8	0.125	1 1/2	1820-0781.125	●	1820-0781L125	●	1820-0781D125	■
NEW	0.0800	1/8	0.120	1 1/2	1820-0800.120	●	1820-0800L120	●	1820-0800D120	■
NEW	0.0850	1/8	0.127	1 1/2	1820-0850.127	●	1820-0850L127	●	1820-0850D127	■
NEW	0.0900	1/8	0.135	1 1/2	1820-0900.135	●	1820-0900L135	●	1820-0900D135	■
	0.0938 (3/32)	1/8	0.141	1 1/2	1820-0938.141	●	1820-0938L141	●	1820-0938D141	■
NEW	0.0950	1/8	0.142	1 1/2	1820-0950.142	●	1820-0950L142	●	1820-0950D142	■
NEW	0.1000	1/8	0.150	1 1/2	1820-1000.150	●	1820-1000L150	●	1820-1000D150	■
NEW	0.1050	1/8	0.158	1 1/2	1820-1050.158	●	1820-1050L158	●	1820-1050D158	■
	0.1094 (7/64)	1/8	0.172	1 1/2	1820-1094.172	●	1820-1094L172	●	1820-1094D172	■
NEW	0.1100	1/8	0.165	1 1/2	1820-1100.165	●	1820-1100L165	●	1820-1100D165	■
NEW	0.1150	1/8	0.173	1 1/2	1820-1150.173	●	1820-1150L173	●	1820-1150D173	■
NEW	0.1181	1/8	0.178	1 1/2	1820-1181.178	●	1820-1181L178	●	1820-1181D178	■
NEW	0.1200	1/8	0.180	1 1/2	1820-1200.180	●	1820-1200L180	●	1820-1200D180	■
	0.1250 (1/8)	1/8	0.188	1 1/2	1820-1250.188	●	1820-1250L188	●	1820-1250D188	■
	0.1406 (9/64)	3/16	0.313	2	1820-1406.313	●	1820-1406L313	●	1820-1406D313	■
	0.1563 (5/32)	3/16	0.234	2	1820-1563.234	●	1820-1563L234	●	1820-1563D234	■
	0.1719 (11/64)	3/16	0.375	2	1820-1719.375	●	1820-1719L375	●	1820-1719D375	■
NEW	0.1875 (3/16)	3/16	0.312	2	1820-1875.312	●	1820-1875L312	●	1820-1875D312	■
	0.1875 (3/16)	3/16	0.375	2	1820-1875.375	●	1820-1875L375	●	1820-1875D375	■
	0.2031 (13/64)	1/4	0.438	2 1/2	1820-2031.438	●	1820-2031L438	●	1820-2031D438	■
	0.2188 (7/32)	1/4	0.438	2 1/2	1820-2188.438	●	1820-2188L438	●	1820-2188D438	■
	0.2344 (15/64)	1/4	0.500	2 1/2	1820-2344.500	●	1820-2344L500	●	1820-2344D500	■
NEW	0.2500 (1/4)	1/4	0.375	2 1/2	1820-2500.375	●	1820-2500L375	●	1820-2500D375	■
	0.2500 (1/4)	1/4	0.500	2 1/2	1820-2500.500	●	1820-2500L500	●	1820-2500D500	■

\*DLC is Amorphous Diamond

### SERIES 1820 WORKPIECE MATERIAL

Coating	P Steel -30HRC	P Steel 30-40HRC	H Hardened Steel -55HRC	H Hardened Steel -68HRC	M Stainless Steel	K Cast Iron	N Aluminum	N Graphite	N Copper Alloy	N CFRP	N Plastic	N Thermoset Plastic	N High Density Plastic	S Nickel / Cobalt	S Titanium Alloy
AlTiN	★	★	★	☆	☆	☆								☆	☆
DLC							☆	★	☆	★	★	★			
Uncoated							☆	☆	☆	☆	☆	☆	☆		☆

★ : Priority ☆ : Applicable Materials

Symbol Descriptions [Page vii](#)

## 4 FLUTE

STUB LENGTH SQUARE END MILLS  
GENERAL PURPOSE MACHINING

**0.10mm - 6.00mm DIAMETER**

Mirror Surface Finishes

Sub Micron Grain Carbide

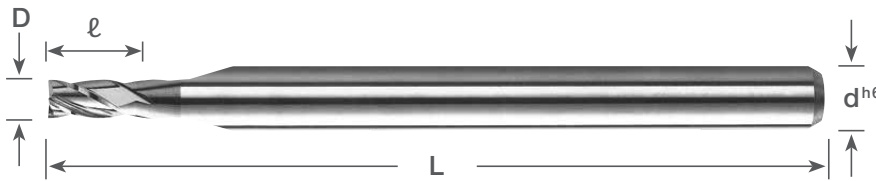

### STUB Length (Metric Sizes)

Dimensions (mm)				Uncoated		AlTiN Coating	
D <sup>+0.00mm</sup> <sub>-0.02mm</sub>	d <sup>h6</sup>	ℓ	L	Part Number	Stock	Part Number	Stock
0.10	3	0.15	38	1820-0039.006	●	1820-0039L006	●
0.15	3	0.23	38	1820-0059.009	●	1820-0059L009	●
0.20	3	0.30	38	1820-0079.012	●	1820-0079L012	●
0.25	3	0.38	38	1820-0098.015	●	1820-0098L015	●
0.30	3	0.45	38	1820-0118.018	●	1820-0118L018	●
0.35	3	0.53	38	1820-0138.021	●	1820-0138L021	●
0.40	3	0.60	38	1820-0157.024	●	1820-0157L024	●
0.45	3	0.68	38	1820-0177.027	●	1820-0177L027	●
0.50	3	0.75	38	1820-0197.030	●	1820-0197L030	●
0.60	3	0.90	38	1820-0236.035	●	1820-0236L035	●
0.70	3	1.05	38	1820-0276.041	●	1820-0276L041	●
0.80	3	1.20	38	1820-0315.047	●	1820-0315L047	●
0.90	3	1.35	38	1820-0354.053	●	1820-0354L053	●
1.00	3	1.50	38	1820-0394.059	●	1820-0394L059	●
1.10	3	1.50	38	1820-0433.059	●	1820-0433L059	●
1.20	3	1.50	38	1820-0472.059	●	1820-0472L059	●
1.30	3	2.25	38	1820-0512.089	●	1820-0512L089	●
1.40	3	2.25	38	1820-0551.089	●	1820-0551L089	●
1.50	3	2.25	38	1820-0591.089	●	1820-0591L089	●
1.60	3	2.25	38	1820-0630.089	●	1820-0630L089	●
1.70	3	2.25	38	1820-0669.089	●	1820-0669L089	●
1.80	3	3.00	38	1820-0709.118	●	1820-0709L118	●
1.90	3	3.00	38	1820-0748.118	●	1820-0748L118	●
2.00	3	3.00	38	1820-0787.118	●	1820-0787L118	●
2.50	3	3.75	38	1820-0984.148	●	1820-0984L148	●
2.80	3	4.50	38	1820-1102.177	●	1820-1102L177	●
3.00	3	4.50	38	1820-1181.177	●	1820-1181L177	●
3.50	4	5.25	50	1820-1378.207	●	1820-1378L207	●
3.80	5	6.00	50	1820-1496.236	●	1820-1496L236	●
4.00	5	6.00	50	1820-1575.236	●	1820-1575L236	●
4.50	5	6.75	50	1820-1772.266	●	1820-1772L266	●
4.80	5	7.50	50	1820-1890.295	●	1820-1890L295	●
5.00	5	7.50	50	1820-1968.295	●	1820-1968L295	●
5.50	6	8.25	50	1820-2165.325	●	1820-2165L325	●
5.80	6	9.00	50	1820-2283.354	●	1820-2283L354	●
6.00	6	9.00	50	1820-2362.354	●	1820-2362L354	●

SERIES 1820 WORKPIECE MATERIAL															
Coating	P	P	H	H	M	K	N	N	N	N	N	N	N	S	S
	Steel ~30HRC	Steel 30-40HRC	Hardened Steel ~55HRC	Hardened Steel ~68HRC	Stainless Steel	Cast Iron	Aluminum	Graphite	Copper Alloy	CFRP	Plastic	Thermoset Plastic	High Density Plastic	Nickel / Cobalt	Titanium Alloy
AlTiN	★	★	★	☆	☆	☆	☆	☆	☆	☆	☆	☆	☆	☆	☆
Uncoated							☆	☆	☆	☆	☆	☆	☆	☆	☆

★ : Priority ☆ : Applicable Materials

Symbol Descriptions [Page vii](#)

● : U.S. Stock Standard  
■ : NOT STOCKED - Call for Delivery  
▲ : Coming Soon

(U.S.) 1.888.848.8449  
(International) 001.714.428.3636  
Pricing & Availability at [KyoceraPrecisionTools.com](http://KyoceraPrecisionTools.com)

DRILLS **A**  
END MILLS **B**  
ROUTERS **C**  
THREAD MILLS & TAPS **D**  
ENGRAVERS **E**  
BORING BARS **F**  
REAMERS **G**  
SAWS **H**  
TECHNICAL **I**  
INDEX **J**

## 4 FLUTE

0.0100" - 0.0625" DIAMETER

Mirror Surface Finishes

Sub Micron Grain Carbide

EXTENDED REACH SQUARE END MILLS  
DEEP REACH MILLING

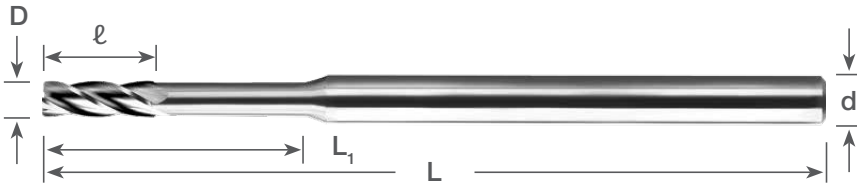

### EXTENDED Reach (Inch Sizes)

Dimensions (in)					Uncoated		AlTiN Coating	
D <sup>+0.000</sup> <sub>-0.001</sub>	d	ℓ	L	L <sub>1</sub>	Part Number	Stock	Part Number	Stock
0.0100	1/8	0.030	1 1/2	0.100	1840-0100.100	●	1840-0100L100	●
0.0150	1/8	0.045	1 1/2	0.128	1840-0150.128	●	1840-0150L128	●
0.0150	1/8	0.045	1 1/2	0.150	1840-0150.150	●	1840-0150L150	●
0.0156 (1/64)	1/8	0.047	1 1/2	0.120	1840-0156.120	●	1840-0156L120	●
0.0200	1/8	0.060	1 1/2	0.170	1840-0200.170	●	1840-0200L170	●
0.0200	1/8	0.060	1 1/2	0.200	1840-0200.200	●	1840-0200L200	●
0.0250	1/8	0.075	1 1/2	0.213	1840-0250.213	●	1840-0250L213	●
0.0250	1/8	0.075	1 1/2	0.250	1840-0250.250	●	1840-0250L250	●
0.0300	1/8	0.090	1 1/2	0.270	1840-0300.270	●	1840-0300L270	●
0.0300	1/8	0.090	1 1/2	0.300	1840-0300.300	●	1840-0300L300	●
<b>NEW</b> 0.0312 (1/32)	1/8	0.093	1 1/2	0.279	1840-0312.279	●	1840-0312L279	●
0.0312 (1/32)	1/8	0.094	1 1/2	0.315	1840-0312.315	●	1840-0312L315	●
0.0350	1/8	0.105	1 1/2	0.315	1840-0350.315	●	1840-0350L315	●
0.0350	1/8	0.105	1 1/2	0.350	1840-0350.350	●	1840-0350L350	●
0.0400	1/8	0.120	1 1/2	0.360	1840-0400.360	●	1840-0400L360	●
0.0400	1/8	0.120	1 1/2	0.400	1840-0400.400	●	1840-0400L400	●
0.0450	1/8	0.135	1 1/2	0.405	1840-0450.405	●	1840-0450L405	●
0.0450	1/8	0.135	1 1/2	0.450	1840-0450.450	●	1840-0450L450	●
0.0469 (3/64)	1/8	0.141	1 1/2	0.390	1840-0469.390	●	1840-0469L390	●
<b>NEW</b> 0.0469 (3/64)	1/8	0.141	1 1/2	0.423	1840-0469.423	●	1840-0469L423	●
0.0500	1/8	0.150	1 1/2	0.500	1840-0500.500	●	1840-0500L500	●
0.0550	1/8	0.165	1 1/2	0.500	1840-0550.500	●	1840-0550L500	●
0.0600	1/8	0.180	1 1/2	0.500	1840-0600.500	●	1840-0600L500	●
0.0600	1/8	0.180	2	0.600	1840-0600.600	●	1840-0600L600	●
<b>NEW</b> 0.0625 (1/16)	1/8	0.186	1 1/2	0.590	1840-0625.590A	●	1840-0625L590A	●
0.0625 (1/16)	1/8	0.188	2	0.590	1840-0625.590	●	1840-0625L590	●

### SERIES 1840 WORKPIECE MATERIAL

Coating	P Steel ~30HRC	P Steel 30-40HRC	H Hardened Steel ~55HRC	H Hardened Steel ~68HRC	M Stainless Steel	K Cast Iron	N Aluminum	N Graphite	N Copper Alloy	N CFRP	N Plastic	N Thermoset Plastic	N High Density Plastic	S Nickel / Cobalt	S Titanium Alloy
AlTiN	★	★	★	☆	☆	☆	☆	☆	☆	☆	☆	☆	☆	☆	☆
Uncoated							☆	☆	☆	☆	☆	☆	☆		

★ : Priority ☆ : Applicable Materials

Symbol Descriptions [Page vii](#)



## 4 FLUTE

EXTENDED REACH SQUARE END MILLS  
DEEP REACH MILLING

**0.0650" - 0.1250" DIAMETER**

Mirror Surface Finishes

Sub Micron Grain Carbide

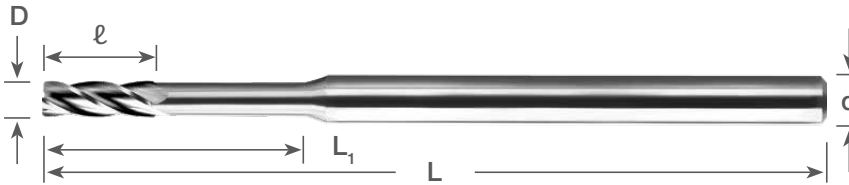

### EXTENDED Reach (Inch Sizes)

Dimensions (in)					Uncoated		AlTiN Coating	
D <sup>+0.000</sup> / <sub>-0.001</sub>	d	ℓ	L	L <sub>1</sub>	Part Number	Stock	Part Number	Stock
0.0650	1/8	0.195	1 1/2	0.500	1840-0650.500	●	1840-0650L500	●
0.0650	1/8	0.195	2	0.600	1840-0650.600	●	1840-0650L600	●
0.0700	1/8	0.210	1 1/2	0.500	1840-0700.500	●	1840-0700L500	●
0.0700	1/8	0.210	2	0.700	1840-0700.700	●	1840-0700L700	●
0.0750	1/8	0.225	1 1/2	0.500	1840-0750.500	●	1840-0750L500	●
0.0750	1/8	0.225	2	0.700	1840-0750.700	●	1840-0750L700	●
<b>NEW</b> 0.0781 (5/64)	1/8	0.234	1 1/2	0.590	1840-0781.590A	●	1840-0781L590A	●
0.0781 (5/64)	1/8	0.234	2	0.590	1840-0781.590	●	1840-0781L590	●
0.0800	1/8	0.240	1 1/2	0.500	1840-0800.500	●	1840-0800L500	●
0.0800	1/8	0.240	2	0.750	1840-0800.750	●	1840-0800L750	●
0.0850	1/8	0.255	1 1/2	0.500	1840-0850.500	●	1840-0850L500	●
0.0850	1/8	0.255	2	0.750	1840-0850.750	●	1840-0850L750	●
0.0900	1/8	0.270	1 1/2	0.625	1840-0900.625	●	1840-0900L625	●
0.0900	1/8	0.270	2	0.750	1840-0900.750	●	1840-0900L750	●
0.0938 (3/32)	1/8	0.281	2	0.590	1840-0938.590	●	1840-0938L590	●
<b>NEW</b> 0.0938 (3/32)	1/8	0.279	1 1/2	0.625	1840-0938.625	●	1840-0938L625	●
0.0950	1/8	0.285	1 1/2	0.625	1840-0950.625	●	1840-0950L625	●
0.0950	1/8	0.285	2	0.750	1840-0950.750	●	1840-0950L750	●
0.1000	1/8	0.300	1 1/2	0.625	1840-1000.625	●	1840-1000L625	●
0.1000	1/8	0.300	2	0.750	1840-1000.750	●	1840-1000L750	●
0.1094 (7/64)	1/8	0.328	2	0.590	1840-1094.590	●	1840-1094L590	●
0.1100	1/8	0.330	2	0.750	1840-1100.750	●	1840-1100L750	●
0.1250 (1/8)	1/8	0.375	2	0.590	1840-1250.590	●	1840-1250L590	●

DRILLS **A**  
END MILLS **B**  
ROUTERS **C**  
THREAD MILLS & TAPS **D**  
ENGRAVERS **E**  
BORING BARS **F**  
REAMERS **G**  
SAWS **H**  
TECHNICAL **I**  
INDEX **J**

SERIES 1840 WORKPIECE MATERIAL															
Coating	P	P	H	H	M	K	N	N	N	N	N	N	N	S	S
	Steel ~30HRC	Steel 30-40HRC	Hardened Steel ~55HRC	Hardened Steel ~68HRC	Stainless Steel	Cast Iron	Aluminum	Graphite	Copper Alloy	CFRP	Plastic	Thermoset Plastic	High Density Plastic	Nickel / Cobalt	Titanium Alloy
AlTiN	★	★	★	☆	☆	☆	☆	☆	☆	☆	☆	☆	☆	☆	☆
Uncoated							☆	☆	☆	☆	☆	☆	☆		☆

★ : Priority ☆ : Applicable Materials

Symbol Descriptions [Page vii](#)

● : U.S. Stock Standard  
■ : NOT STOCKED - Call for Delivery  
▲ : Coming Soon

(U.S.) 1.888.848.8449  
(International) 001.714.428.3636  
Pricing & Availability at [KyoceraPrecisionTools.com](http://KyoceraPrecisionTools.com)

# 4 FLUTE

0.40mm - 6.00mm DIAMETER

Mirror Surface Finishes

Sub Micron Grain Carbide

EXTENDED REACH SQUARE END MILLS  
DEEP REACH MILLING

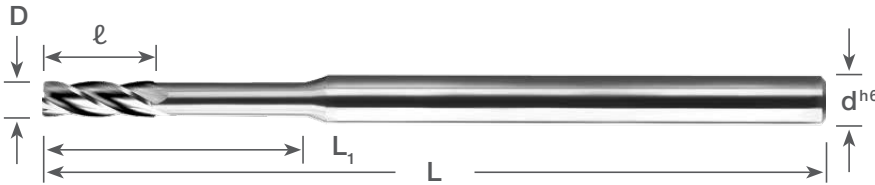

## EXTENDED Reach (Metric Sizes)

Dimensions (mm)					Uncoated		AlTiN Coating	
D	d <sup>h6</sup>	ℓ	L	L <sub>1</sub>	Part Number	Stock	Part Number	Stock
0.40	3	1.20	38	3	1840-0157.118	●	1840-0157L118	●
0.50	3	1.50	38	4	1840-0197.157	●	1840-0197L157	●
0.60	3	1.80	38	5	1840-0236.197	●	1840-0236L197	●
0.65	3	1.95	38	6	1840-0256.236	●	1840-0256L236	●
0.70	3	2.10	38	7	1840-0276.276	●	1840-0276L276	●
0.75	3	2.25	38	8	1840-0295.315	●	1840-0295L315	●
0.80	3	2.40	50	9	1840-0315.354	●	1840-0315L354	●
0.90	3	2.70	50	10	1840-0354.394	●	1840-0354L394	●
1.00	3	3.00	50	10	1840-0394.394	●	1840-0394L394	●
1.50	3	4.50	50	15	1840-0591.591	●	1840-0591L591	●
2.00	3	6.00	50	20	1840-0787.787	●	1840-0787L787	●
2.50	3	7.50	50	23	1840-0984.906	●	1840-0984L906	●
3.00	3	9.00	50	23	1840-1181.906	●	1840-1181L906	●
3.50	6	10.50	75	25	1840-1378.984	●	1840-1378L984	●
4.00	6	12.00	75	25	1840-1575.984	●	1840-1575L984	●
4.50	6	13.50	75	30	1840-1772.1181	●	1840-1772L1181	●
5.00	6	15.00	75	30	1840-1968.1181	●	1840-1968L1181	●
5.50	6	16.50	75	30	1840-2165.1181	●	1840-2165L1181	●
6.00	6	18.00	75	30	1840-2362.1181	●	1840-2362L1181	●

SERIES 1840 WORKPIECE MATERIAL															
Coating	P	P	H	H	M	K	N	N	N	N	N	N	S	S	
	Steel ~30HRC	Steel 30-40HRC	Hardened Steel ~55HRC	Hardened Steel ~68HRC	Stainless Steel	Cast Iron	Aluminum	Graphite	Copper Alloy	CFRP	Plastic	Thermoset Plastic	High Density Plastic	Nickel / Cobalt	Titanium Alloy
AlTiN	★	★	★	☆	☆	☆	☆	☆	☆	☆	☆	☆	☆	☆	☆
Uncoated							☆	☆	☆	☆	☆	☆	☆		☆

★ : Priority ☆ : Applicable Materials

Symbol Descriptions Page vii

## 2 FLUTE

0.0050" - 0.0312" DIAMETER

Mirror Surface Finishes

Sub Micron Grain Carbide

STANDARD LENGTH BALL NOSE END MILLS

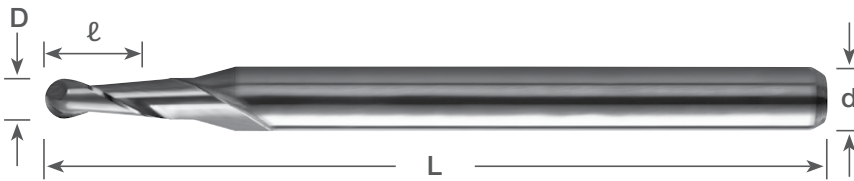

### STANDARD Length (Inch Sizes)

NEW	Dimensions (in)				Uncoated		AlTiN Coating		NEW DLC* Coating	
	D <sup>+0.000</sup> / <sub>-0.001</sub>	d	ℓ	L	Part Number	Stock	Part Number	Stock	Part Number	Stock
NEW	0.0050	1/8	0.015	1 1/2	1625-0050.015	●	1625-0050L015	●	-	-
NEW	0.0060	1/8	0.018	1 1/2	1625-0060.018	●	1625-0060L018	●	-	-
NEW	0.0070	1/8	0.021	1 1/2	1625-0070.021	●	1625-0070L021	●	-	-
NEW	0.0080	1/8	0.024	1 1/2	1625-0080.024	●	1625-0080L024	●	-	-
NEW	0.0090	1/8	0.027	1 1/2	1625-0090.027	●	1625-0090L027	●	-	-
	0.0100	1/8	0.030	1 1/2	1625-0100.030	●	1625-0100L030	●	1625-0100D030	■
	0.0110	1/8	0.033	1 1/2	1625-0110.033	●	1625-0110L033	●	-	-
	0.0120	1/8	0.036	1 1/2	1625-0120.036	●	1625-0120L036	●	-	-
	0.0130	1/8	0.039	1 1/2	1625-0130.039	●	1625-0130L039	●	-	-
	0.0140	1/8	0.042	1 1/2	1625-0140.042	●	1625-0140L042	●	-	-
	0.0150	1/8	0.045	1 1/2	1625-0150.045	●	1625-0150L045	●	1625-0150D045	■
	0.0156 (1/64)	1/8	0.047	1 1/2	1625-0156.047	●	1625-0156L047	●	1625-0156D047	■
	0.0160	1/8	0.048	1 1/2	1625-0160.048	●	1625-0160L048	●	-	-
	0.0170	1/8	0.051	1 1/2	1625-0170.051	●	1625-0170L051	●	-	-
	0.0180	1/8	0.054	1 1/2	1625-0180.054	●	1625-0180L054	●	-	-
	0.0190	1/8	0.057	1 1/2	1625-0190.057	●	1625-0190L057	●	-	-
	0.0200	1/8	0.060	1 1/2	1625-0200.060	●	1625-0200L060	●	1625-0200D060	■
	0.0210	1/8	0.063	1 1/2	1625-0210.063	●	1625-0210L063	●	-	-
	0.0220	1/8	0.066	1 1/2	1625-0220.066	●	1625-0220L066	●	-	-
	0.0230	1/8	0.069	1 1/2	1625-0230.069	●	1625-0230L069	●	-	-
	0.0240	1/8	0.072	1 1/2	1625-0240.072	●	1625-0240L072	●	-	-
	0.0250	1/8	0.075	1 1/2	1625-0250.075	●	1625-0250L075	●	1625-0250D075	■
	0.0260	1/8	0.078	1 1/2	1625-0260.078	●	1625-0260L078	●	-	-
	0.0270	1/8	0.081	1 1/2	1625-0270.081	●	1625-0270L081	●	-	-
	0.0280	1/8	0.084	1 1/2	1625-0280.084	●	1625-0280L084	●	-	-
	0.0290	1/8	0.087	1 1/2	1625-0290.087	●	1625-0290L087	●	-	-
	0.0300	1/8	0.090	1 1/2	1625-0300.090	●	1625-0300L090	●	1625-0300D090	■
	0.0310	1/8	0.093	1 1/2	1625-0310.093	●	1625-0310L093	●	-	-
	0.0312 (1/32)	1/8	0.094	1 1/2	1625-0312.094	●	1625-0312L094	●	1625-0312D094	■

\*DLC is Amorphous Diamond

SERIES 1625 WORKPIECE MATERIAL															
Coating	P Steel ~30HRC	P Steel 30~40HRC	H Hardened Steel ~55HRC	H Hardened Steel ~68HRC	M Stainless Steel	K Cast Iron	N Aluminum	N Graphite	N Copper Alloy	N CFRP	N Plastic	N Thermoset Plastic	N High Density Plastic	S Nickel / Cobalt	S Titanium Alloy
AlTiN	★	★	★	☆	☆	☆								☆	☆
DLC							☆	★	☆	★	★	★			
Uncoated							☆	☆	★	☆	★	★			☆

★ : Priority ☆ : Applicable Materials

Symbol Descriptions Page vii

● : U.S. Stock Standard  
 ■ : NOT STOCKED - Call for Delivery  
 ▲ : Coming Soon

(U.S.) 1.888.848.8449  
 (International) 001.714.428.3636  
 Pricing & Availability at [KyoceraPrecisionTools.com](http://KyoceraPrecisionTools.com)

DRILLS A  
 END MILLS B  
 ROUTERS C  
 THREAD MILLS & TAPS D  
 ENGRAVERS E  
 BORING BARS F  
 REAMERS G  
 SAWS H  
 TECHNICAL I  
 INDEX J

## 2 FLUTE

**0.0320" - 0.0600" DIAMETER**

Mirror Surface Finishes

Sub Micron Grain Carbide

### STANDARD LENGTH BALL NOSE END MILLS

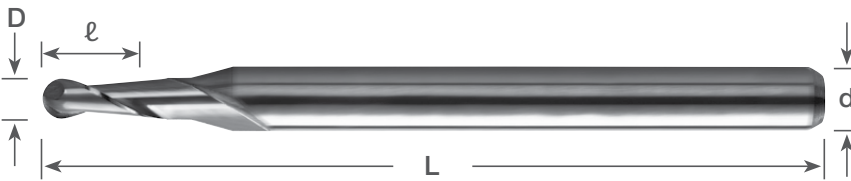

### STANDARD Length (Inch Sizes)

	Dimensions (in)				Uncoated		AlTiN Coating		NEW DLC* Coating	
	D <sup>+0.000</sup> / <sub>-0.001</sub>	d	ℓ	L	Part Number	Stock	Part Number	Stock	Part Number	Stock
	0.0320	1/8	0.096	1 1/2	1625-0320.096	●	1625-0320L096	●	-	-
	0.0330	1/8	0.099	1 1/2	1625-0330.099	●	1625-0330L099	●	-	-
	0.0340	1/8	0.102	1 1/2	1625-0340.102	●	1625-0340L102	●	-	-
	0.0350	1/8	0.105	1 1/2	1625-0350.105	●	1625-0350L105	●	1625-0350D105	■
NEW	0.0360	1/8	0.108	1 1/2	1625-0360.108	●	1625-0360L108	●	-	-
NEW	0.0370	1/8	0.111	1 1/2	1625-0370.111	●	1625-0370L111	●	-	-
NEW	0.0380	1/8	0.114	1 1/2	1625-0380.114	●	1625-0380L114	●	-	-
NEW	0.0394	1/8	0.117	1 1/2	1625-0394.117	●	1625-0394L117	●	1625-0394D117	■
	0.0400	1/8	0.120	1 1/2	1625-0400.120	●	1625-0400L120	●	1625-0400D120	■
NEW	0.0410	1/8	0.123	1 1/2	1625-0410.123	●	1625-0410L123	●	-	-
NEW	0.0420	1/8	0.126	1 1/2	1625-0420.126	●	1625-0420L126	●	-	-
NEW	0.0430	1/8	0.129	1 1/2	1625-0430.129	●	1625-0430L129	●	-	-
NEW	0.0440	1/8	0.132	1 1/2	1625-0440.132	●	1625-0440L132	●	-	-
	0.0450	1/8	0.135	1 1/2	1625-0450.135	●	1625-0450L135	●	1625-0450D135	■
NEW	0.0460	1/8	0.138	1 1/2	1625-0460.138	●	1625-0460L138	●	-	-
	0.0469 (3/64)	1/8	0.141	1 1/2	1625-0469.141	●	1625-0469L141	●	1625-0469D141	■
NEW	0.0480	1/8	0.144	1 1/2	1625-0480.144	●	1625-0480L144	●	-	-
NEW	0.0490	1/8	0.147	1 1/2	1625-0490.147	●	1625-0490L147	●	-	-
	0.0500	1/8	0.150	1 1/2	1625-0500.150	●	1625-0500L150	●	1625-0500D150	■
NEW	0.0510	1/8	0.153	1 1/2	1625-0510.153	●	1625-0510L153	●	-	-
NEW	0.0520	1/8	0.156	1 1/2	1625-0520.156	●	1625-0520L156	●	-	-
NEW	0.0530	1/8	0.159	1 1/2	1625-0530.159	●	1625-0530L159	●	-	-
NEW	0.0540	1/8	0.162	1 1/2	1625-0540.162	●	1625-0540L162	●	-	-
	0.0550	1/8	0.165	1 1/2	1625-0550.165	●	1625-0550L165	●	1625-0550D165	■
NEW	0.0560	1/8	0.168	1 1/2	1625-0560.168	●	1625-0560L168	●	-	-
NEW	0.0570	1/8	0.171	1 1/2	1625-0570.171	●	1625-0570L171	●	-	-
NEW	0.0580	1/8	0.174	1 1/2	1625-0580.174	●	1625-0580L174	●	-	-
NEW	0.0590	1/8	0.177	1 1/2	1625-0590.177	●	1625-0590L177	●	-	-
	0.0600	1/8	0.180	1 1/2	1625-0600.180	●	1625-0600L180	●	1625-0600D180	■

\*DLC is Amorphous Diamond

### SERIES 1625 WORKPIECE MATERIAL

Coating	P Steel -30HRC	P Steel 30-40HRC	H Hardened Steel -55HRC	H Hardened Steel -68HRC	M Stainless Steel	K Cast Iron	N Aluminum	N Graphite	N Copper Alloy	N CFRP	N Plastic	N Thermoset Plastic	N High Density Plastic	S Nickel / Cobalt	S Titanium Alloy
AlTiN	★	★	★	☆	☆	☆								☆	☆
DLC							☆	★	☆	★	★	★			
Uncoated							☆	☆	★	☆	★	★			☆

★ : Priority ☆ : Applicable Materials

Symbol Descriptions [Page vii](#)

## 2 FLUTE

STANDARD LENGTH BALL NOSE END MILLS

**0.0625" - 0.2500" DIAMETER**

Mirror Surface Finishes

Sub Micron Grain Carbide

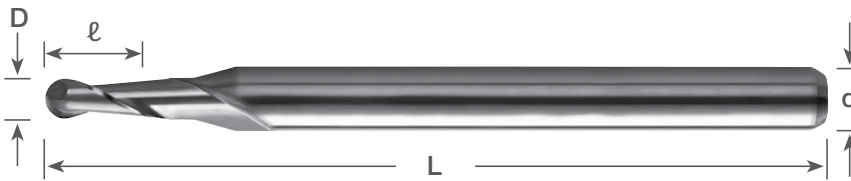

### STANDARD Length (Inch Sizes)

Dimensions (in)				Uncoated		AlTiN Coating		NEW DLC* Coating	
D <sup>+0.000</sup> <sub>-0.001</sub>	d	ℓ	L	Part Number	Stock	Part Number	Stock	Part Number	Stock
0.0625 (1/16)	1/8	0.188	1 1/2	1625-0625.188	●	1625-0625L188	●	1625-0625D188	■
0.0650	1/8	0.195	1 1/2	1625-0650.195	●	1625-0650L195	●	1625-0650D195	■
0.0700	1/8	0.210	1 1/2	1625-0700.210	●	1625-0700L210	●	1625-0700D210	■
0.0750	1/8	0.225	1 1/2	1625-0750.225	●	1625-0750L225	●	1625-0750D225	■
0.0781 (5/64)	1/8	0.234	1 1/2	1625-0781.234	●	1625-0781L234	●	1625-0781D234	■
0.0800	1/8	0.240	1 1/2	1625-0800.240	●	1625-0800L240	●	1625-0800D240	■
0.0850	1/8	0.255	1 1/2	1625-0850.255	●	1625-0850L255	●	1625-0850D255	■
0.0900	1/8	0.270	1 1/2	1625-0900.270	●	1625-0900L270	●	1625-0900D270	■
0.0938 (3/32)	1/8	0.281	1 1/2	1625-0938.281	●	1625-0938L281	●	1625-0938D281	■
0.0950	1/8	0.285	1 1/2	1625-0950.285	●	1625-0950L285	●	1625-0950D285	■
0.1000	1/8	0.300	1 1/2	1625-1000.300	●	1625-1000L300	●	1625-1000D300	■
NEW 0.1050	1/8	0.315	1 1/2	1625-1050.315	●	1625-1050L315	●	1625-1050D315	■
0.1094 (7/64)	1/8	0.328	1 1/2	1625-1094.328	●	1625-1094L328	●	1625-1094D328	■
NEW 0.1100	1/8	0.330	1 1/2	1625-1100.330	●	1625-1100L330	●	1625-1100D330	■
NEW 0.1150	1/8	0.345	1 1/2	1625-1150.345	●	1625-1150L345	●	1625-1150D345	■
NEW 0.1181	1/8	0.355	1 1/2	1625-1181.355	●	1625-1181L355	●	1625-1181D355	■
NEW 0.1200	1/8	0.360	1 1/2	1625-1200.360	●	1625-1200L360	●	1625-1200D360	■
0.1250 (1/8)	1/8	0.375	1 1/2	1625-1250.375	●	1625-1250L375	●	1625-1250D375	■
0.1406 (9/64)	3/16	0.500	2	1625-1406.500	●	1625-1406L500	●	1625-1406D500	■
NEW 0.1562 (5/32)	3/16	0.562	2	1625-1562.562	●	1625-1562L562	●	1625-1562D562	■
0.1563 (5/32)	3/16	0.500	2	1625-1563.500	●	1625-1563L500	●	1625-1563D500	■
0.1719 (11/64)	3/16	0.563	2	1625-1719.563	●	1625-1719L563	●	1625-1719D563	■
0.1875 (3/16)	3/16	0.563	2	1625-1875.563	●	1625-1875L563	●	1625-1875D563	■
NEW 0.1875 (3/16)	3/16	0.625	2	1625-1875.625	●	1625-1875L625	●	1625-1875D625	■
0.2031 (13/64)	1/4	0.625	2 1/2	1625-2031.625	●	1625-2031L625	●	1625-2031D625	■
0.2188 (7/32)	1/4	0.625	2 1/2	1625-2188.625	●	1625-2188L625	●	1625-2188D625	■
0.2344 (15/64)	1/4	0.750	2 1/2	1625-2344.750	●	1625-2344L750	●	1625-2344D750	■
0.2500 (1/4)	1/4	0.750	2 1/2	1625-2500.750	●	1625-2500L750	●	1625-2500D750	■

\*DLC is Amorphous Diamond

SERIES 1625 WORKPIECE MATERIAL															
Coating	P	P	H	H	M	K	N	N	N	N	N	N	S	S	
	Steel ~30HRC	Steel 30~40HRC	Hardened Steel ~55HRC	Hardened Steel ~68HRC	Stainless Steel	Cast Iron	Aluminum	Graphite	Copper Alloy	CFRP	Plastic	Thermoset Plastic	High Density Plastic	Nickel / Cobalt	Titanium Alloy
AlTiN	★	★	★	☆	☆	☆								☆	☆
DLC							☆	★	☆	★	★	★			
Uncoated							☆	☆	★	☆	★	★			☆

★ : Priority ☆ : Applicable Materials

Symbol Descriptions Page vii

● : U.S. Stock Standard  
 ■ : NOT STOCKED - Call for Delivery  
 ▲ : Coming Soon

(U.S.) 1.888.848.8449  
 (International) 001.714.428.3636  
 Pricing & Availability at [KyoceraPrecisionTools.com](http://KyoceraPrecisionTools.com)

DRILLS A  
 END MILLS B  
 ROUTERS C  
 THREAD MILLS & TAPS D  
 ENGRAVERS E  
 BORING BARS F  
 REAMERS G  
 SAWS H  
 TECHNICAL I  
 INDEX J

## 2 FLUTE

**0.10mm - 6.00mm DIAMETER**

Mirror Surface Finishes

Sub Micron Grain Carbide

STANDARD LENGTH BALL NOSE END MILLS

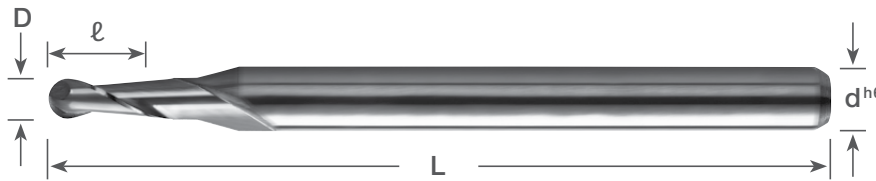

### STANDARD Length (Metric Sizes)

	Dimensions (mm)				Uncoated		AlTiN Coating	
	D +0.00mm -0.02mm	d <sup>h6</sup>	ℓ	L	Part Number	Stock	Part Number	Stock
	0.10	3	0.30	38	1625-0039.012	●	1625-0039L012	●
	0.15	3	0.45	38	1625-0059.018	●	1625-0059L018	●
	0.20	3	0.60	38	1625-0079.024	●	1625-0079L024	●
	0.25	3	0.75	38	1625-0098.029	●	1625-0098L029	●
	0.30	3	0.90	38	1625-0118.035	●	1625-0118L035	●
	0.35	3	1.05	38	1625-0138.041	●	1625-0138L041	●
	0.40	3	1.20	38	1625-0157.047	●	1625-0157L047	●
	0.45	3	1.35	38	1625-0177.053	●	1625-0177L053	●
	0.50	3	1.50	38	1625-0197.059	●	1625-0197L059	●
	0.60	3	1.80	38	1625-0236.071	●	1625-0236L071	●
	0.70	3	2.10	38	1625-0276.083	●	1625-0276L083	●
	0.80	3	2.40	38	1625-0315.095	●	1625-0315L095	●
	0.90	3	2.70	38	1625-0354.106	●	1625-0354L106	●
	1.00	3	3.00	38	1625-0394.118	●	1625-0394L118	●
	1.10	3	3.30	38	1625-0433.130	●	1625-0433L130	●
	1.20	3	3.60	38	1625-0472.142	●	1625-0472L142	●
	1.30	3	3.90	38	1625-0512.154	●	1625-0512L154	●
	1.40	3	4.20	38	1625-0551.165	●	1625-0551L165	●
	1.50	3	4.50	38	1625-0591.177	●	1625-0591L177	●
	1.60	3	4.80	38	1625-0630.189	●	1625-0630L189	●
	1.70	3	5.10	38	1625-0669.201	●	1625-0669L201	●
	1.80	3	5.40	38	1625-0709.213	●	1625-0709L213	●
	1.90	3	5.70	38	1625-0748.224	●	1625-0748L224	●
	2.00	3	6.00	38	1625-0787.236	●	1625-0787L236	●
	2.50	3	7.50	38	1625-0984.295	●	1625-0984L295	●
	3.00	3	9.00	38	1625-1181.354	●	1625-1181L354	●
	3.50	4	10.50	50	1625-1378.413	●	1625-1378L413	●
	4.00	5	12.00	50	1625-1575.473	●	1625-1575L473	●
	4.50	5	13.50	50	1625-1772.532	●	1625-1772L532	●
	5.00	5	15.00	50	1625-1968.590	●	1625-1968L590	●
	5.50	6	16.50	50	1625-2165.650	●	1625-2165L650	●
	6.00	6	18.00	50	1625-2362.709	●	1625-2362L709	●

### SERIES 1625 WORKPIECE MATERIAL

Coating	P Steel ~30HRC	P Steel 30-40HRC	H Hardened Steel ~55HRC	H Hardened Steel ~68HRC	M Stainless Steel	K Cast Iron	N Aluminum	N Graphite	N Copper Alloy	N CFRP	N Plastic	N Thermoset Plastic	N High Density Plastic	S Nickel / Cobalt	S Titanium Alloy
AlTiN	★	★	★	☆	☆	☆	☆	☆	★	☆	★	★	★	☆	☆
Uncoated							☆	☆	★	☆	★	★	★	☆	☆

★ : Priority ☆ : Applicable Materials

Symbol Descriptions [Page vii](#)

## 2 FLUTE

0.0050" - 0.0350" DIAMETER

Mirror Surface Finishes

Sub Micron Grain Carbide

STUB LENGTH BALL NOSE END MILLS

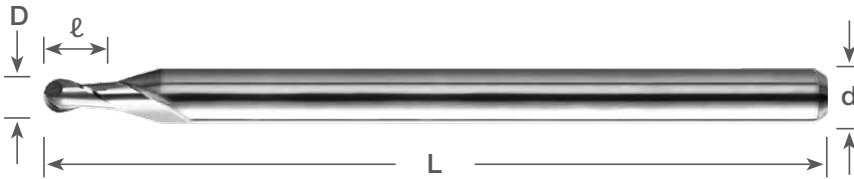

### STUB Length (Inch Sizes)

Dimensions (in)				Uncoated		AlTiN Coating		NEW DLC* Coating	
D <sup>+0.000</sup> <sub>-0.001</sub>	d	ℓ	L	Part Number	Stock	Part Number	Stock	Part Number	Stock
NEW 0.0050	1/8	0.007	1 1/2	1635-0050.007	●	1635-0050L007	●	-	-
NEW 0.0060	1/8	0.009	1 1/2	1635-0060.009	●	1635-0060L009	●	-	-
NEW 0.0070	1/8	0.010	1 1/2	1635-0070.010	●	1635-0070L010	●	-	-
NEW 0.0080	1/8	0.012	1 1/2	1635-0080.012	●	1635-0080L012	●	-	-
NEW 0.0090	1/8	0.013	1 1/2	1635-0090.013	●	1635-0090L013	●	-	-
0.0100	1/8	0.015	1 1/2	1635-0100.015	●	1635-0100L015	●	1635-0100D015	■
0.0110	1/8	0.016	1 1/2	1635-0110.016	●	1635-0110L016	●	-	-
0.0120	1/8	0.018	1 1/2	1635-0120.018	●	1635-0120L018	●	-	-
0.0130	1/8	0.019	1 1/2	1635-0130.019	●	1635-0130L019	●	-	-
0.0140	1/8	0.021	1 1/2	1635-0140.021	●	1635-0140L021	●	-	-
0.0150	1/8	0.023	1 1/2	1635-0150.023	●	1635-0150L023	●	1635-0150D023	■
0.0156 (1/64)	1/8	0.023	1 1/2	1635-0156.023	●	1635-0156L023	●	-	-
0.0160	1/8	0.024	1 1/2	1635-0160.024	●	1635-0160L024	●	-	-
0.0170	1/8	0.025	1 1/2	1635-0170.025	●	1635-0170L025	●	-	-
0.0180	1/8	0.027	1 1/2	1635-0180.027	●	1635-0180L027	●	-	-
0.0190	1/8	0.028	1 1/2	1635-0190.028	●	1635-0190L028	●	-	-
0.0200	1/8	0.030	1 1/2	1635-0200.030	●	1635-0200L030	●	1635-0200D030	■
0.0210	1/8	0.031	1 1/2	1635-0210.031	●	1635-0210L031	●	-	-
0.0220	1/8	0.033	1 1/2	1635-0220.033	●	1635-0220L033	●	-	-
0.0230	1/8	0.034	1 1/2	1635-0230.034	●	1635-0230L034	●	-	-
0.0240	1/8	0.036	1 1/2	1635-0240.036	●	1635-0240L036	●	-	-
0.0250	1/8	0.038	1 1/2	1635-0250.038	●	1635-0250L038	●	1635-0250D038	■
0.0260	1/8	0.039	1 1/2	1635-0260.039	●	1635-0260L039	●	-	-
0.0270	1/8	0.040	1 1/2	1635-0270.040	●	1635-0270L040	●	-	-
0.0280	1/8	0.042	1 1/2	1635-0280.042	●	1635-0280L042	●	-	-
0.0290	1/8	0.043	1 1/2	1635-0290.043	●	1635-0290L043	●	-	-
0.0300	1/8	0.045	1 1/2	1635-0300.045	●	1635-0300L045	●	1635-0300D045	■
0.0310	1/8	0.047	1 1/2	1635-0310.047	●	1635-0310L047	●	-	-
0.0312 (1/32)	1/8	0.047	1 1/2	1635-0312.047	●	1635-0312L047	●	-	-
0.0320	1/8	0.048	1 1/2	1635-0320.048	●	1635-0320L048	●	-	-
0.0330	1/8	0.050	1 1/2	1635-0330.050	●	1635-0330L050	●	-	-
0.0340	1/8	0.051	1 1/2	1635-0340.051	●	1635-0340L051	●	-	-
0.0350	1/8	0.053	1 1/2	1635-0350.053	●	1635-0350L053	●	1635-0350D053	■

\*DLC is Amorphous Diamond

SERIES 1635 WORKPIECE MATERIAL															
Coating	P Steel ~30HRC	P Steel 30-40HRC	H Hardened Steel ~55HRC	H Hardened Steel ~68HRC	M Stainless Steel	K Cast Iron	N Aluminum	N Graphite	N Copper Alloy	N CFRP	N Plastic	N Thermoset Plastic	N High Density Plastic	S Nickel / Cobalt	S Titanium Alloy
AlTiN	★	★	★	☆	☆	☆								☆	☆
DLC							☆	★	☆	★	★	★			
Uncoated							☆	☆	★	☆	★	★	☆		☆

★ : Priority ☆ : Applicable Materials

Symbol Descriptions Page vii

● : U.S. Stock Standard  
 ■ : NOT STOCKED - Call for Delivery  
 ▲ : Coming Soon

(U.S.) 1.888.848.8449  
 (International) 001.714.428.3636  
 Pricing & Availability at [KyoceraPrecisionTools.com](http://KyoceraPrecisionTools.com)



## 2 FLUTE

**0.0360" - 0.2500" DIAMETER**

Mirror Surface Finishes

Sub Micron Grain Carbide

### STUB LENGTH BALL NOSE END MILLS

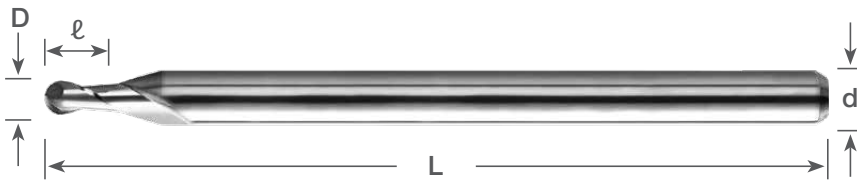

### STUB Length (Inch Sizes)

	Dimensions (in)				Uncoated		AlTiN Coating		NEW DLC* Coating	
	D <sup>+0.000</sup> / <sub>-0.001</sub>	d	ℓ	L	Part Number	Stock	Part Number	Stock	Part Number	Stock
NEW	0.0360	1/8	0.054	1 1/2	1635-0360.054	●	1635-0360L054	●	1635-0360D054	■
NEW	0.0370	1/8	0.055	1 1/2	1635-0370.055	●	1635-0370L055	●	1635-0370D055	■
NEW	0.0380	1/8	0.057	1 1/2	1635-0380.057	●	1635-0380L057	●	1635-0380D057	■
NEW	0.0394	1/8	0.058	1 1/2	1635-0394.058	●	1635-0394L058	●	1635-0394D058	■
	0.0400	1/8	0.060	1 1/2	1635-0400.060	●	1635-0400L060	●	1635-0400D060	■
	0.0450	1/8	0.068	1 1/2	1635-0450.068	●	1635-0450L068	●	1635-0450D068	■
	0.0469 (3/64)	1/8	0.070	1 1/2	1635-0469.070	●	1635-0469L070	●	1635-0469D070	■
	0.0500	1/8	0.075	1 1/2	1635-0500.075	●	1635-0500L075	●	1635-0500D075	■
	0.0550	1/8	0.083	1 1/2	1635-0550.083	●	1635-0550L083	●	1635-0550D083	■
	0.0600	1/8	0.090	1 1/2	1635-0600.090	●	1635-0600L090	●	1635-0600D090	■
	0.0625 (1/16)	1/8	0.094	1 1/2	1635-0625.094	●	1635-0625L094	●	1635-0625D094	■
	0.0650	1/8	0.098	1 1/2	1635-0650.098	●	1635-0650L098	●	1635-0650D098	■
	0.0700	1/8	0.105	1 1/2	1635-0700.105	●	1635-0700L105	●	1635-0700D105	■
	0.0750	1/8	0.113	1 1/2	1635-0750.113	●	1635-0750L113	●	1635-0750D113	■
	0.0781 (5/64)	1/8	0.117	1 1/2	1635-0781.117	●	1635-0781L117	●	1635-0781D117	■
	0.0800	1/8	0.120	1 1/2	1635-0800.120	●	1635-0800L120	●	1635-0800D120	■
	0.0850	1/8	0.128	1 1/2	1635-0850.128	●	1635-0850L128	●	1635-0850D128	■
	0.0900	1/8	0.135	1 1/2	1635-0900.135	●	1635-0900L135	●	1635-0900D135	■
	0.0938 (3/32)	1/8	0.141	1 1/2	1635-0938.141	●	1635-0938L141	●	1635-0938D141	■
	0.0950	1/8	0.143	1 1/2	1635-0950.143	●	1635-0950L143	●	1635-0950D143	■
	0.1000	1/8	0.150	1 1/2	1635-1000.150	●	1635-1000L150	●	1635-1000D150	■
	0.1094 (7/64)	1/8	0.164	1 1/2	1635-1094.164	●	1635-1094L164	●	1635-1094D164	■
NEW	0.1181	1/8	0.178	1 1/2	1635-1181.178	●	1635-1181L178	●	1635-1181D178	■
	0.1250 (1/8)	1/8	0.188	1 1/2	1635-1250.188	●	1635-1250L188	●	1635-1250D188	■
	0.1406 (9/64)	3/16	0.313	2	1635-1406.313	●	1635-1406L313	●	1635-1406D313	■
	0.1563 (5/32)	3/16	0.313	2	1635-1563.313	●	1635-1563L313	●	1635-1563D313	■
	0.1719 (11/64)	3/16	0.375	2	1635-1719.375	●	1635-1719L375	●	1635-1719D375	■
	0.1875 (3/16)	3/16	0.375	2	1635-1875.375	●	1635-1875L375	●	1635-1875D375	■
	0.2031 (13/64)	1/4	0.438	2 1/2	1635-2031.438	●	1635-2031L438	●	1635-2031D438	■
	0.2188 (7/32)	1/4	0.438	2 1/2	1635-2188.438	●	1635-2188L438	●	1635-2188D438	■
	0.2344 (15/64)	1/4	0.500	2 1/2	1635-2344.500	●	1635-2344L500	●	1635-2344D500	■
	0.2500 (1/4)	1/4	0.500	2 1/2	1635-2500.500	●	1635-2500L500	●	1635-2500D500	■

\*DLC is Amorphous Diamond

SERIES 1635 WORKPIECE MATERIAL															
Coating	P Steel -30HRC	P Steel 30-40HRC	H Hardened Steel -55HRC	H Hardened Steel -68HRC	M Stainless Steel	K Cast Iron	N Aluminum	N Graphite	N Copper Alloy	N CFRP	N Plastic	N Thermoset Plastic	N High Density Plastic	S Nickel / Cobalt	S Titanium Alloy
AlTiN	★	★	★	☆	☆	☆								☆	☆
DLC							☆	★	☆	★	★	★			
Uncoated							☆	☆	★	☆	★	★	☆		☆

★ : Priority ☆ : Applicable Materials

Symbol Descriptions Page vii

## 2 FLUTE

STUB LENGTH SQUARE END MILLS

**0.10mm - 6.00mm DIAMETER**

Mirror Surface Finishes

Sub Micron Grain Carbide

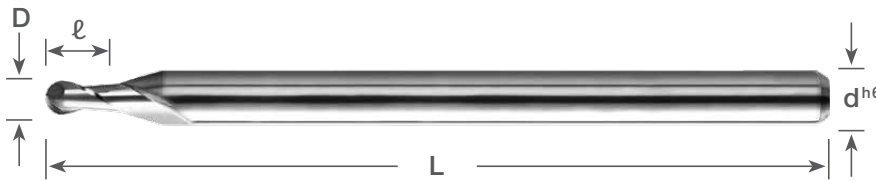

### STUB Length (Metric Sizes)

Dimensions (mm)				Uncoated		AlTiN Coating	
D <sup>+0.00mm</sup> <sub>-0.02mm</sub>	d <sup>h6</sup>	ℓ	L	Part Number	Stock	Part Number	Stock
0.10	3	0.15	38	1635-0039.006	●	1635-0039L006	●
0.15	3	0.23	38	1635-0059.009	●	1635-0059L009	●
0.20	3	0.30	38	1635-0079.012	●	1635-0079L012	●
0.25	3	0.38	38	1635-0098.015	●	1635-0098L015	●
0.30	3	0.45	38	1635-0118.018	●	1635-0118L018	●
0.35	3	0.53	38	1635-0138.021	●	1635-0138L021	●
0.40	3	0.60	38	1635-0157.024	●	1635-0157L024	●
0.45	3	0.68	38	1635-0177.027	●	1635-0177L027	●
0.50	3	0.75	38	1635-0197.030	●	1635-0197L030	●
0.60	3	0.90	38	1635-0236.035	●	1635-0236L035	●
0.70	3	1.05	38	1635-0276.041	●	1635-0276L041	●
0.80	3	1.20	38	1635-0315.047	●	1635-0315L047	●
0.90	3	1.35	38	1635-0354.053	●	1635-0354L053	●
1.00	3	1.50	38	1635-0394.059	●	1635-0394L059	●
1.10	3	1.65	38	1635-0433.065	●	1635-0433L065	●
1.20	3	1.80	38	1635-0472.071	●	1635-0472L071	●
1.30	3	1.95	38	1635-0512.077	●	1635-0512L077	●
1.40	3	2.10	38	1635-0551.083	●	1635-0551L083	●
1.50	3	2.25	38	1635-0591.089	●	1635-0591L089	●
1.60	3	2.40	38	1635-0630.095	●	1635-0630L095	●
1.70	3	2.50	38	1635-0669.098	●	1635-0669L098	●
1.80	3	2.70	38	1635-0709.106	●	1635-0709L106	●
1.90	3	2.85	38	1635-0748.112	●	1635-0748L112	●
2.00	3	3.00	38	1635-0787.118	●	1635-0787L118	●
2.50	3	3.75	38	1635-0984.148	●	1635-0984L148	●
3.00	3	4.50	38	1635-1181.177	●	1635-1181L177	●
3.50	4	5.25	50	1635-1378.207	●	1635-1378L207	●
4.00	5	6.00	50	1635-1575.236	●	1635-1575L236	●
4.50	5	6.75	50	1635-1772.266	●	1635-1772L266	●
5.00	5	7.50	50	1635-1968.295	●	1635-1968L295	●
5.50	6	8.25	50	1635-2165.325	●	1635-2165L325	●
6.00	6	9.00	50	1635-2362.354	●	1635-2362L354	●

SERIES 1635 WORKPIECE MATERIAL															
Coating	P	P	H	H	M	K	N	N	N	N	N	N	N	S	S
	Steel ~30HRC	Steel 30~40HRC	Hardened Steel ~55HRC	Hardened Steel ~68HRC	Stainless Steel	Cast Iron	Aluminum	Graphite	Copper Alloy	CFRP	Plastic	Thermoset Plastic	High Density Plastic	Nickel / Cobalt	Titanium Alloy
AlTiN	★	★	★	☆	☆	☆	☆	☆	☆	☆	☆	☆	☆	☆	☆
Uncoated							☆	☆	★	☆	★	★	☆		☆

★ : Priority ☆ : Applicable Materials

Symbol Descriptions [Page vii](#)

● : U.S. Stock Standard  
 ■ : NOT STOCKED - Call for Delivery  
 ▲ : Coming Soon

(U.S.) 1.888.848.8449  
 (International) 001.714.428.3636  
 Pricing & Availability at [KyoceraPrecisionTools.com](http://KyoceraPrecisionTools.com)

DRILLS **A**  
 END MILLS **B**  
 ROUTERS **C**  
 THREAD MILLS & TAPS **D**  
 ENGRAVERS **E**  
 BORING BARS **F**  
 REAMERS **G**  
 SAWS **H**  
 TECHNICAL **I**  
 INDEX **J**

## 2 FLUTE

0.0100" - 0.0625" DIAMETER

Mirror Surface Finishes

Sub Micron Grain Carbide

### EXTENDED REACH BALL NOSE END MILLS

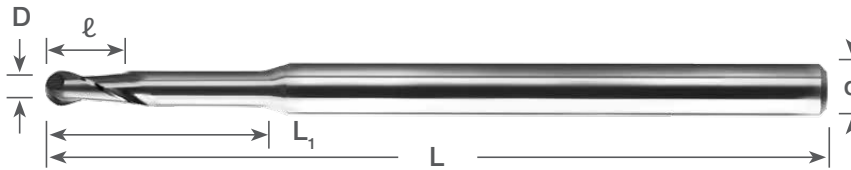

### EXTENDED Reach (Inch Sizes)

Dimensions (in)					Uncoated		AlTiN Coating		NEW DLC* Coating	
D <sup>+0.000</sup> <sub>-0.001</sub>	d	ℓ	L	L <sub>1</sub>	Part Number	Stock	Part Number	Stock	Part Number	Stock
0.0100	1/8	0.030	1 1/2	0.100	1645-0100.100	●	1645-0100L100	●	1645-0100D100	■
0.0150	1/8	0.045	1 1/2	0.128	1645-0150.128	●	1645-0150L128	●	1645-0150D128	■
0.0150	1/8	0.045	1 1/2	0.150	1645-0150.150	●	1645-0150L150	●	1645-0150D150	■
0.0156 (1/64)	1/8	0.047	1 1/2	0.120	1645-0156.120	●	1645-0156L120	●	1645-0156D120	■
0.0200	1/8	0.060	1 1/2	0.170	1645-0200.170	●	1645-0200L170	●	1645-0200D170	■
0.0200	1/8	0.060	1 1/2	0.200	1645-0200.200	●	1645-0200L200	●	1645-0200D200	■
0.0250	1/8	0.075	1 1/2	0.213	1645-0250.213	●	1645-0250L213	●	1645-0250D213	■
0.0250	1/8	0.075	1 1/2	0.250	1645-0250.250	●	1645-0250L250	●	1645-0250D250	■
0.0300	1/8	0.090	1 1/2	0.270	1645-0300.270	●	1645-0300L270	●	1645-0300D270	■
0.0300	1/8	0.090	1 1/2	0.300	1645-0300.300	●	1645-0300L300	●	1645-0300D300	■
0.0312 (1/32)	1/8	0.094	1 1/2	0.315	1645-0312.315	●	1645-0312L315	●	1645-0312D315	■
0.0350	1/8	0.105	1 1/2	0.315	1645-0350.315	●	1645-0350L315	●	1645-0350D315	■
0.0350	1/8	0.105	1 1/2	0.350	1645-0350.350	●	1645-0350L350	●	1645-0350D350	■
0.0400	1/8	0.120	1 1/2	0.360	1645-0400.360	●	1645-0400L360	●	1645-0400D360	■
0.0400	1/8	0.120	1 1/2	0.400	1645-0400.400	●	1645-0400L400	●	1645-0400D400	■
0.0450	1/8	0.135	1 1/2	0.405	1645-0450.405	●	1645-0450L405	●	1645-0450D405	■
0.0450	1/8	0.135	1 1/2	0.450	1645-0450.450	●	1645-0450L450	●	1645-0450D450	■
0.0469 (3/64)	1/8	0.141	1 1/2	0.390	1645-0469.390	●	1645-0469L390	●	1645-0469D390	■
NEW 0.0469 (3/64)	1/8	0.141	1 1/2	0.423	1645-0469.423	●	1645-0469L423	●	1645-0469D423	■
0.0500	1/8	0.150	1 1/2	0.500	1645-0500.500	●	1645-0500L500	●	1645-0500D500	■
0.0550	1/8	0.165	1 1/2	0.500	1645-0550.500	●	1645-0550L500	●	1645-0550D500	■
0.0600	1/8	0.180	1 1/2	0.500	1645-0600.500	●	1645-0600L500	●	1645-0600D500	■
0.0600	1/8	0.180	2	0.600	1645-0600.600	●	1645-0600L600	●	1645-0600D600	■
NEW 0.0625 (1/16)	1/8	0.186	1 1/2	0.590	1645-0625.590A	●	1645-0625L590A	●	1645-0625D590A	■
0.0625 (1/16)	1/8	0.188	2	0.590	1645-0625.590	●	1645-0625L590	●	1645-0625D590	■

\*DLC is Amorphous Diamond

### SERIES 1645 WORKPIECE MATERIAL

Coating	P Steel ~30HRC	P Steel 30-40HRC	H Hardened Steel ~55HRC	H Hardened Steel ~68HRC	M Stainless Steel	K Cast Iron	N Aluminum	N Graphite	N Copper Alloy	N CFRP	N Plastic	N Thermoset Plastic	N High Density Plastic	S Nickel / Cobalt	S Titanium Alloy
AlTiN	★	★	★	☆	☆	☆								☆	☆
DLC							☆	★	☆	★	★	★			
Uncoated							☆	☆	★	☆	★	★			☆

★ : Priority ☆ : Applicable Materials

Symbol Descriptions [Page vii](#)

## 2 FLUTE

EXTENDED REACH BALL NOSE END MILLS

**0.0650" - 0.1250" DIAMETER**

Mirror Surface Finishes

Sub Micron Grain Carbide

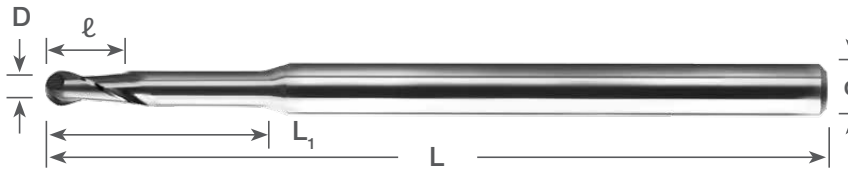

### EXTENDED Reach (Inch Sizes)

Dimensions (in)					Uncoated		AlTiN Coating		NEW DLC* Coating	
D <sup>+0.000</sup> / <sub>-0.001</sub>	d	ℓ	L	L <sub>1</sub>	Part Number	Stock	Part Number	Stock	Part Number	Stock
0.0650	1/8	0.195	1 1/2	0.500	1645-0650.500	●	1645-0650L500	●	1645-0650D500	■
0.0650	1/8	0.195	2	0.600	1645-0650.600	●	1645-0650L600	●	1645-0650D600	■
0.0700	1/8	0.210	1 1/2	0.500	1645-0700.500	●	1645-0700L500	●	1645-0700D500	■
0.0700	1/8	0.210	2	0.700	1645-0700.700	●	1645-0700L700	●	1645-0700D700	■
0.0750	1/8	0.225	1 1/2	0.500	1645-0750.500	●	1645-0750L500	●	1645-0750D500	■
0.0750	1/8	0.225	2	0.700	1645-0750.700	●	1645-0750L700	●	1645-0750D700	■
NEW 0.0781 (5/64)	1/8	0.234	1 1/2	0.590	1645-0781.590A	●	1645-0781L590A	●	1645-0781D590A	■
0.0781 (5/64)	1/8	0.234	2	0.590	1645-0781.590	●	1645-0781L590	●	1645-0781D590	■
0.0800	1/8	0.240	1 1/2	0.500	1645-0800.500	●	1645-0800L500	●	1645-0800D500	■
0.0800	1/8	0.240	2	0.750	1645-0800.750	●	1645-0800L750	●	1645-0800D750	■
0.0850	1/8	0.255	1 1/2	0.500	1645-0850.500	●	1645-0850L500	●	1645-0850D500	■
0.0850	1/8	0.255	2	0.750	1645-0850.750	●	1645-0850L750	●	1645-0850D750	■
0.0900	1/8	0.270	1 1/2	0.625	1645-0900.625	●	1645-0900L625	●	1645-0900D625	■
0.0900	1/8	0.270	2	0.750	1645-0900.750	●	1645-0900L750	●	1645-0900D750	■
0.0938 (3/32)	1/8	0.281	2	0.590	1645-0938.590	●	1645-0938L590	●	1645-0938D590	■
NEW 0.0938 (3/32)	1/8	0.279	1 1/2	0.625	1645-0938.625	●	1645-0938L625	●	1645-0938D625	■
0.0950	1/8	0.285	1 1/2	0.625	1645-0950.625	●	1645-0950L625	●	1645-0950D625	■
0.0950	1/8	0.285	2	0.750	1645-0950.750	●	1645-0950L750	●	1645-0950D750	■
0.1000	1/8	0.300	1 1/2	0.625	1645-1000.625	●	1645-1000L625	●	1645-1000D625	■
0.1000	1/8	0.300	2	0.750	1645-1000.750	●	1645-1000L750	●	1645-1000D750	■
0.1094 (7/64)	1/8	0.328	2	0.590	1645-1094.590	●	1645-1094L590	●	1645-1094D590	■
0.1100	1/8	0.330	2	0.750	1645-1100.750	●	1645-1100L750	●	1645-1100D750	■
0.1250 (1/8)	1/8	0.375	2	0.590	1645-1250.590	●	1645-1250L590	●	1645-1250D590	■

\*DLC is Amorphous Diamond

SERIES 1645 WORKPIECE MATERIAL															
Coating	P	P	H	H	M	K	N	N	N	N	N	N	S	S	
	Steel ~30HRC	Steel 30-40HRC	Hardened Steel ~55HRC	Hardened Steel ~68HRC	Stainless Steel	Cast Iron	Aluminum	Graphite	Copper Alloy	CFRP	Plastic	Thermoset Plastic	High Density Plastic	Nickel / Cobalt	Titanium Alloy
AlTiN	★	★	★	☆	☆	☆								☆	☆
DLC							☆	★	☆	★	★	★			
Uncoated							☆	☆	★	☆	★	★			☆

★ : Priority ☆ : Applicable Materials

Symbol Descriptions Page vii

● : U.S. Stock Standard  
 ■ : NOT STOCKED - Call for Delivery  
 ▲ : Coming Soon

(U.S.) 1.888.848.8449  
 (International) 001.714.428.3636  
 Pricing & Availability at [KyoceraPrecisionTools.com](http://KyoceraPrecisionTools.com)

DRILLS A  
 END MILLS B  
 ROUTERS C  
 THREAD MILLS & TAPS D  
 ENGRAVERS E  
 BORING BARS F  
 REAMERS G  
 SAWS H  
 TECHNICAL I  
 INDEX J

## 2 FLUTE

**0.40mm - 6.00mm DIAMETER**

Mirror Surface Finishes

Sub Micron Grain Carbide

EXTENDED REACH BALL NOSE END MILLS

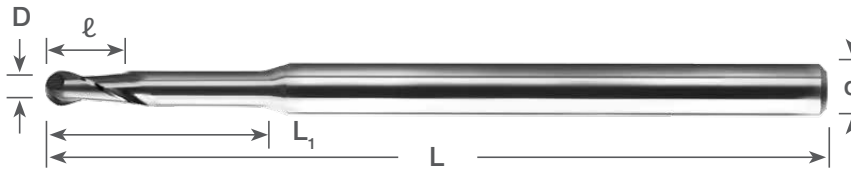

### EXTENDED Reach (Metric Sizes)

Dimensions (mm)					Uncoated		AlTiN Coating	
D	d <sup>h6</sup>	ℓ	L	L <sub>1</sub>	Part Number	Stock	Part Number	Stock
0.40	3	1.20	38	3	1645-0157.118	●	1645-0157L118	●
0.50	3	1.50	38	4	1645-0197.157	●	1645-0197L157	●
0.60	3	1.80	38	5	1645-0236.197	●	1645-0236L197	●
0.65	3	1.95	38	6	1645-0256.236	●	1645-0256L236	●
0.70	3	2.10	38	7	1645-0276.276	●	1645-0276L276	●
0.75	3	2.25	38	8	1645-0295.315	●	1645-0295L315	●
0.80	3	2.40	50	9	1645-0315.354	●	1645-0315L354	●
0.90	3	2.70	50	10	1645-0354.394	●	1645-0354L394	●
1.00	3	3.00	50	10	1645-0394.394	●	1645-0394L394	●
1.50	3	4.50	50	15	1645-0591.591	●	1645-0591L591	●
2.00	3	6.00	50	20	1645-0787.787	●	1645-0787L787	●
2.50	3	7.50	50	23	1645-0984.906	●	1645-0984L906	●
3.00	3	9.00	50	23	1645-1181.906	●	1645-1181L906	●
3.50	6	10.50	75	25	1645-1378.984	●	1645-1378L984	●
4.00	6	12.00	75	25	1645-1575.984	●	1645-1575L984	●
4.50	6	13.50	75	30	1645-1772.1181	●	1645-1772L1181	●
5.00	6	15.00	75	30	1645-1968.1181	●	1645-1968L1181	●
5.50	6	16.50	75	30	1645-2165.1181	●	1645-2165L1181	●
6.00	6	18.00	75	30	1645-2362.1181	●	1645-2362L1181	●

SERIES 1645 WORKPIECE MATERIAL															
Coating	P	P	H	H	M	K	N	N	N	N	N	N	S	S	
	Steel ~30HRC	Steel 30-40HRC	Hardened Steel ~55HRC	Hardened Steel ~68HRC	Stainless Steel	Cast Iron	Aluminum	Graphite	Copper Alloy	CFRP	Plastic	Thermoset Plastic	High Density Plastic	Nickel / Cobalt	Titanium Alloy
AlTiN	★	★	★	☆	☆	☆	☆	☆	★	☆	★	★		☆	☆
Uncoated							☆	☆	★	☆	★	★			☆

★ : Priority ☆ : Applicable Materials

Symbol Descriptions [Page vii](#)

## 2 FLUTE NEW

REVERSE SHANK BALL NOSE END MILLS

0.1563" - 0.7500" DIAMETER

Mirror Surface Finishes

Sub Micron Grain Carbide

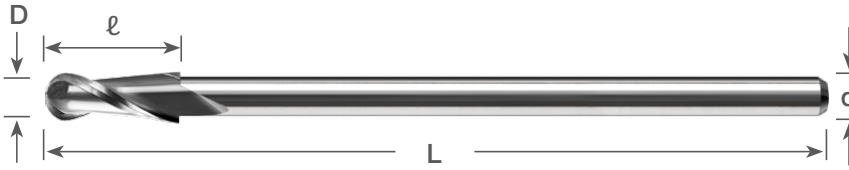

### REVERSE Shank (Inch Sizes)

Dimensions (in)				Uncoated		AlTiN Coating	
D <sup>+0.000</sup> / <sub>-0.001</sub>	d	ℓ	L	Part Number	Stock	Part Number	Stock
0.1563 (5/32)	1/8	0.234	2 1/2	1685-1563.234A	●	1685-1563L234A	●
0.1875 (3/16)	1/8	0.281	2 1/2	1685-1875.281A	●	1685-1875L281A	●
0.1875 (3/16)	5/32	0.281	2 1/2	1685-1875.281B	●	1685-1875L281B	●
0.2500 (1/4)	3/16	0.375	3	1685-2500.375A	●	1685-2500L375A	●
0.3125 (5/16)	1/4	0.469	4	1685-3125.469A	●	1685-3125L469A	●
0.3750 (3/8)	5/16	0.563	4	1685-3750.563A	●	1685-3750L563A	●
0.4375 (7/16)	3/8	0.656	6	1685-4375.656A	●	1685-4375L656A	●
0.5000 (1/2)	7/16	0.750	6	1685-5000.750A	●	1685-5000L750A	●
0.6250 (5/8)	1/2	0.944	6	1685-6250.944A	●	1685-6250L944A	●
0.7500 (3/4)	5/8	1.125	6	1685-7500.1125A	●	1685-7500L1125A	●

- DRILLS **A**
- END MILLS **B**
- ROUTERS **C**
- THREAD MILLS & TAPS **D**
- ENGRAVERS **E**
- BORING BARS **F**
- REAMERS **G**
- SAWS **H**
- TECHNICAL **I**
- INDEX **J**

SERIES 1685 WORKPIECE MATERIAL																
Coating	<b>P</b> Steel ~30HRC	<b>P</b> Steel 30-40HRC	<b>H</b> Hardened Steel ~55HRC	<b>H</b> Hardened Steel ~68HRC	<b>M</b> Stainless Steel	<b>K</b> Cast Iron	<b>N</b> Aluminum	<b>N</b> Graphite	<b>N</b> Copper Alloy	<b>N</b> CFRP	<b>N</b> Plastic	<b>N</b> Thermoset Plastic	<b>N</b> High Density Plastic	<b>S</b> Nickel / Cobalt	<b>S</b> Titanium Alloy	
AlTiN	★	★	★	☆	☆	☆									☆	☆
Uncoated							☆	☆	★	☆	★	★	☆			☆

★ : Priority ☆ : Applicable Materials

Symbol Descriptions [Page vii](#)

● : U.S. Stock Standard  
 ■ : NOT STOCKED - Call for Delivery  
 ▲ : Coming Soon

## 2 FLUTE

0.20mm - 3.00mm DIAMETER

Sub Micron Grain Carbide

6mm Shank

BALL NOSE END MILLS FOR HARD METAL MILLING

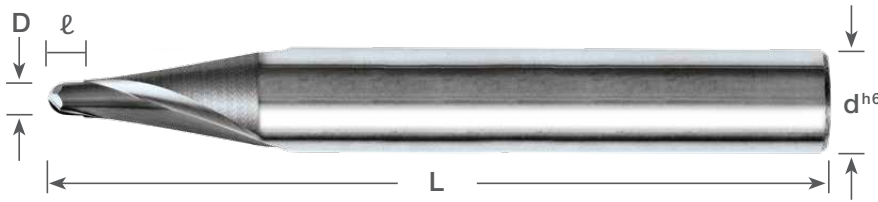

### METRIC RADIUS (r)

Dimensions (mm)						KTX-I Coating	
D <sup>+0.000mm</sup> / <sub>-0.005mm</sub>	r	d <sup>h6</sup>	ℓ	L	Part Number	Stock	
0.20	0.10	6	0.20	45	1625-0079J008S	●	
0.30	0.15	6	0.30	45	1625-0118J012S	●	
0.40	0.20	6	0.40	45	1625-0157J016S	●	
0.50	0.25	6	0.50	45	1625-0197J020S	●	
0.60	0.30	6	0.60	45	1625-0236J024S	●	
0.80	0.40	6	0.80	45	1625-0315J032S	●	
1.00	0.50	6	1.00	45	1625-0394J040S	●	
1.20	0.60	6	1.20	45	1625-0472J048S	●	
1.40	0.70	6	1.40	45	1625-0551J055S	●	
1.50	0.75	6	1.50	45	1625-0591J060S	●	
1.60	0.80	6	1.60	45	1625-0630J063S	●	
1.80	0.90	6	1.80	45	1625-0709J071S	●	
2.00	1.00	6	2.00	45	1625-0787J078S	●	
2.50	1.25	6	2.50	45	1625-0984J098S	●	
3.00	1.50	6	3.00	45	1625-1181J118S	●	

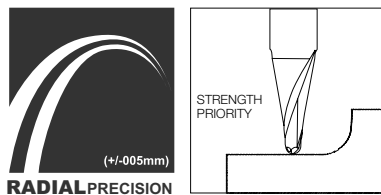

SERIES 16 HMS WORKPIECE MATERIAL															
Coating	P	P	H	H	M	K	N	N	N	N	N	S	S		
	Steel ~30HRC	Steel 30-40HRC	Hardened Steel ~55HRC	Hardened Steel ~68HRC	Stainless Steel	Cast Iron	Aluminum	Graphite	Copper Alloy	CFRP	Plastic	Thermoset Plastic	High Density Plastic	Nickel / Cobalt	Titanium Alloy
KTX-I	☆	☆	★	★	☆	☆								☆	☆

★ : Priority ☆ : Applicable Materials

Symbol Descriptions [Page vii](#)



## 2 FLUTE

BALL NOSE END MILLS FOR HARD METAL MILLING

0.20mm - 3.00mm DIAMETER

Sub Micron Grain Carbide  
1 X Diameter Length of Cut  
Designed for 10:1 Depth to  
Diameter Aspect Ratio

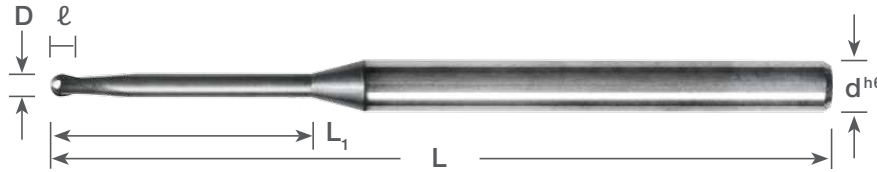

### METRIC RADIUS (r) - EXTENDED Reach

Dimensions (mm)								KTX-I Coating	
D <sup>+0.000mm</sup> <sub>-0.005mm</sub>	r	d <sup>h6</sup>	ℓ	L	L <sub>1</sub>	L <sub>10</sub>	Part Number	Stock	
0.20	0.10	4	0.20	50	2	0.17	1625-0079J008R	●	
0.30	0.15	4	0.30	50	3	0.26	1625-0118J012R	●	
0.40	0.20	4	0.40	50	4	0.36	1625-0157J016R	●	
0.50	0.25	4	0.50	50	5	0.45	1625-0197J020R	●	
0.60	0.30	4	0.60	50	6	0.57	1625-0236J024R	●	
0.80	0.40	4	0.80	50	8	0.76	1625-0315J032R	●	
1.00	0.50	4	1.00	50	10	0.95	1625-0394J040R	●	
1.20	0.60	4	1.20	50	12	1.14	1625-0472J048R	●	
1.40	0.70	4	1.40	50	14	1.33	1625-0551J055R	●	
1.50	0.75	4	1.50	50	15	1.43	1625-0591J060R	●	
1.60	0.80	4	1.60	50	16	1.52	1625-0630J063R	●	
1.80	0.90	4	1.80	50	18	1.71	1625-0709J071R	●	
2.00	1.00	4	2.00	60	20	1.90	1625-0787J078R	●	
2.50	1.25	4	2.50	60	25	2.43	1625-0984J098R	●	
3.00	1.50	6	3.00	70	30	2.91	1625-1181J118R	●	

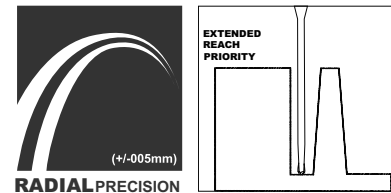

SERIES 16 HMR WORKPIECE MATERIAL															
Coating	P	P	H	H	M	K	N	N	N	N	N	N	S	S	
	Steel ~30HRC	Steel 30-40HRC	Hardened Steel ~55HRC	Hardened Steel ~68HRC	Stainless Steel	Cast Iron	Aluminum	Graphite	Copper Alloy	CFRP	Plastic	Thermoset Plastic	High Density Plastic	Nickel / Cobalt	Titanium Alloy
KTX-I	☆	☆	★	★	☆	☆								☆	☆

★ : Priority ☆ : Applicable Materials

Symbol Descriptions Page vii

● : U.S. Stock Standard  
■ : NOT STOCKED - Call for Delivery  
▲ : Coming Soon

(U.S.) 1.888.848.8449  
(International) 001.714.428.3636  
Pricing & Availability at [KyoceraPrecisionTools.com](http://KyoceraPrecisionTools.com)

DRILLS A  
END MILLS B  
ROUTERS C  
THREAD MILLS & TAPS D  
ENGRAVERS E  
BORING BARS F  
REAMERS G  
SAWS H  
TECHNICAL I  
INDEX J

## 2 FLUTE

BALL NOSE END MILLS FOR RIB PROCESSING  
H13, P20, A-2, D-2, S-7, M-2 upto Rc 62

**0.50mm, 1.50mm Radius**

Sub Micron Grain Carbide

1 X Diameter Length of Cut

Multiple Length to Diameter Aspect Ratios

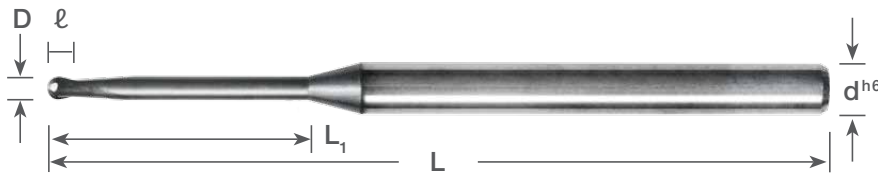

### METRIC RADIUS (r)

Dimensions (mm)							KTX-I Coating	
D	r	d <sup>h6</sup>	l	L	L <sub>1</sub>	Part Number	Stock	
1.00	0.50	4	1.00	50	2	16RB0394U-2	●	
1.00	0.50	4	1.00	50	4	16RB0394U-4	●	
1.00	0.50	4	1.00	50	6	16RB0394U-6	●	
1.00	0.50	4	1.00	50	8	16RB0394U-8	●	
1.00	0.50	4	1.00	50	10	16RB0394U-10	●	
1.00	0.50	4	1.00	50	12	16RB0394U-12	●	
1.50	0.75	4	1.50	50	2	16RB0591U-2	●	
1.50	0.75	4	1.50	50	4	16RB0591U-4	●	
1.50	0.75	4	1.50	50	6	16RB0591U-6	●	
1.50	0.75	4	1.50	50	8	16RB0591U-8	●	
1.50	0.75	4	1.50	50	10	16RB0591U-10	●	
1.50	0.75	4	1.50	50	12	16RB0591U-12	●	
2.00	1.00	4	2.00	50	-	16RB0787U-2	●	
2.00	1.00	4	2.00	50	4	16RB0787U-4	●	
2.00	1.00	4	2.00	50	6	16RB0787U-6	●	
2.00	1.00	4	2.00	50	8	16RB0787U-8	●	
2.00	1.00	4	2.00	50	10	16RB0787U-10	●	
2.00	1.00	4	2.00	50	12	16RB0787U-12	●	
3.00	1.50	6	3.00	60	-	16RB1181U-2	●	
3.00	1.50	6	3.00	60	4	16RB1181U-4	●	
3.00	1.50	6	3.00	60	6	16RB1181U-6	●	
3.00	1.50	6	3.00	60	8	16RB1181U-8	●	
3.00	1.50	6	3.00	60	10	16RB1181U-10	●	
3.00	1.50	6	3.00	60	12	16RB1181U-12	●	

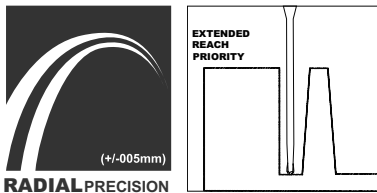

### SERIES 16RB WORKPIECE MATERIAL

Coating	P	P	H	H	M	K	N	N	N	N	N	N	S	S	
	Steel ~30HRC	Steel 30-40HRC	Hardened Steel ~55HRC	Hardened Steel ~68HRC	Stainless Steel	Cast Iron	Aluminum	Graphite	Copper Alloy	CFRP	Plastic	Thermoset Plastic	High Density Plastic	Nickel / Cobalt	Titanium Alloy
KTX-I	☆	☆	★	★	☆	☆								☆	☆

★ : Priority ☆ : Applicable Materials

Symbol Descriptions [Page vii](#)

## 3 FLUTE

STANDARD LENGTH BALL NOSE END MILLS

0.0100" - 0.1000" DIAMETER

Mirror Surface Finishes

Sub Micron Grain Carbide

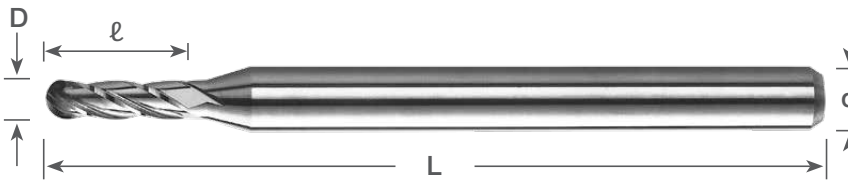

### STANDARD Length (Inch Sizes)

	Dimensions (in)				Uncoated		AlTiN Coating		NEW DLC* Coating	
	D <sup>+0.000</sup> / <sub>-0.001</sub>	d	ℓ	L	Part Number	Stock	Part Number	Stock	Part Number	Stock
NEW	0.0100	1/8	0.050	2 1/2	1725-0100.050	●	1725-0100L050	●	1725-0100D050	■
	0.0150	1/8	0.075	2 1/2	1725-0150.075	●	1725-0150L075	●	1725-0150D075	■
NEW	0.0156 (1/64)	1/8	0.078	2-1/2	1725-0156.078	●	1725-0156L078	●	1725-0156D078	■
NEW	0.0156 (1/64)	1/8	0.125	2-1/2	1725-0156.125	●	1725-0156L125	●	1725-0156D125	■
	0.0200	1/8	0.100	2 1/2	1725-0200.100	●	1725-0200L100	●	1725-0200D100	■
NEW	0.0200	1/8	0.160	2 1/2	1725-0200.160	●	1725-0200L160	●	1725-0200D160	■
	0.0250	1/8	0.125	2 1/2	1725-0250.125	●	1725-0250L125	●	1725-0250D125	■
NEW	0.0250	1/8	0.203	2 1/2	1725-0250.203	●	1725-0250L203	●	1725-0250D203	■
	0.0300	1/8	0.150	2 1/2	1725-0300.150	●	1725-0300L150	●	1725-0300D150	■
NEW	0.0312 (1/32)	1/8	0.156	2-1/2	1725-0312.156	●	1725-0312L156	●	1725-0312D156	■
NEW	0.0312 (1/32)	1/8	0.250	2-1/2	1725-0312.250	●	1725-0312L250	●	1725-0312D250	■
NEW	0.0312 (1/32)	1/8	0.375	2-1/2	1725-0312.375	●	1725-0312L375	●	1725-0312D375	■
	0.0350	1/8	0.175	2 1/2	1725-0350.175	●	1725-0350L175	●	1725-0350D175	■
	0.0400	1/8	0.200	2 1/2	1725-0400.200	●	1725-0400L200	●	1725-0400D200	■
NEW	0.0400	1/8	0.325	2 1/2	1725-0400.325	●	1725-0400L325	●	1725-0400D325	■
	0.0450	1/8	0.225	2 1/2	1725-0450.225	●	1725-0450L225	●	1725-0450D225	■
NEW	0.0469 (3/64)	1/8	0.250	2-1/2	1725-0469.250	●	1725-0469L250	●	1725-0469D250	■
NEW	0.0469 (3/64)	1/8	0.375	2-1/2	1725-0469.375	●	1725-0469L375	●	1725-0469D375	■
NEW	0.0469 (3/64)	1/8	0.570	2-1/2	1725-0469.570	●	1725-0469L570	●	1725-0469D570	■
	0.0500	1/8	0.300	2 1/2	1725-0500.300	●	1725-0500L300	●	1725-0500D300	■
NEW	0.0500	1/8	0.400	2 1/2	1725-0500.400	●	1725-0500L400	●	1725-0500D400	■
	0.0550	1/8	0.385	2 1/2	1725-0550.385	●	1725-0550L385	●	1725-0550D385	■
NEW	0.0600	1/8	0.312	2 1/2	1725-0600.312	●	1725-0600L312	●	1725-0600D312	■
	0.0600	1/8	0.500	2 1/2	1725-0600.500	●	1725-0600L500	●	1725-0600D500	■
NEW	0.0625 (1/16)	1/8	0.312	2-1/2	1725-0625.312	●	1725-0625L312	●	1725-0625D312	■
NEW	0.0625 (1/16)	1/8	0.500	2-1/2	1725-0625.500	●	1725-0625L500	●	1725-0625D500	■
	0.0650	1/8	0.500	2 1/2	1725-0650.500	●	1725-0650L500	●	1725-0650D500	■
	0.0700	1/8	0.500	2 1/2	1725-0700.500	●	1725-0700L500	●	1725-0700D500	■
	0.0750	1/8	0.500	2 1/2	1725-0750.500	●	1725-0750L500	●	1725-0750D500	■
	0.0800	1/8	0.750	2 1/2	1725-0800.750	●	1725-0800L750	●	1725-0800D750	■
	0.0850	1/8	0.750	2 1/2	1725-0850.750	●	1725-0850L750	●	1725-0850D750	■
	0.0900	1/8	0.750	2 1/2	1725-0900.750	●	1725-0900L750	●	1725-0900D750	■
	0.0950	1/8	0.750	2 1/2	1725-0950.750	●	1725-0950L750	●	1725-0950D750	■
	0.1000	1/8	0.750	2 1/2	1725-1000.750	●	1725-1000L750	●	1725-1000D750	■

\*DLC is Amorphous Diamond

SERIES 1725 WORKPIECE MATERIAL															
Coating	P	P	H	H	M	K	N	N	N	N	N	N	S	S	
	Steel ~30HRC	Steel 30~40HRC	Hardened Steel ~55HRC	Hardened Steel ~68HRC	Stainless Steel	Cast Iron	Aluminum	Graphite	Copper Alloy	CFRP	Plastic	Thermoset Plastic	High Density Plastic	Nickel / Cobalt	Titanium Alloy
AlTiN	★	★	★	☆	☆	☆								☆	☆
DLC							☆	★	☆	★	★	★			
Uncoated							☆	☆	☆	☆	☆	☆	☆		☆

★ : Priority ☆ : Applicable Materials

Symbol Descriptions Page vii

● : U.S. Stock Standard  
 ■ : NOT STOCKED - Call for Delivery  
 ▲ : Coming Soon

(U.S.) 1.888.848.8449  
 (International) 001.714.428.3636  
 Pricing & Availability at [KyoceraPrecisionTools.com](http://KyoceraPrecisionTools.com)

## 3 FLUTE

0.0100" - 0.1000" DIAMETER

Mirror Surface Finishes

Sub Micron Grain Carbide

### EXTENDED REACH BALL NOSE END MILLS

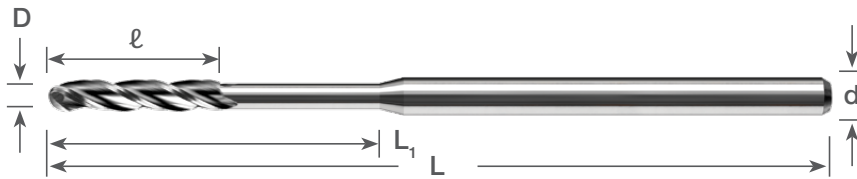

### EXTENDED Reach (Inch Sizes)

	Dimensions (in)					Uncoated		AlTiN Coating		NEW DLC* Coating	
	D <sup>+0.000</sup> <sub>-0.001</sub>	d	ℓ	L	L <sub>1</sub>	Part Number	Stock	Part Number	Stock	Part Number	Stock
<b>NEW</b>	0.0100	1/8	0.050	2 1/2	0.100	1745-0100.100	●	1745-0100L100	●	1745-0100D100	■
	0.0150	1/8	0.075	2 1/2	0.150	1745-0150.150	●	1745-0150L150	●	1745-0150D150	■
<b>NEW</b>	0.0156 (1/64)	1/8	0.075	2 1/2	0.150	1745-0156.150	●	1745-0156L150	●	1745-0156D150	■
	0.0200	1/8	0.100	2 1/2	0.200	1745-0200.200	●	1745-0200L200	●	1745-0200D200	■
	0.0250	1/8	0.125	2 1/2	0.250	1745-0250.250	●	1745-0250L250	●	1745-0250D250	■
	0.0300	1/8	0.150	2 1/2	0.300	1745-0300.300	●	1745-0300L300	●	1745-0300D300	■
<b>NEW</b>	0.0312 (1/32)	1/8	0.155	2 1/2	0.310	1745-0312.310	●	1745-0312L310	●	1745-0312D310	■
	0.0350	1/8	0.175	2 1/2	0.350	1745-0350.350	●	1745-0350L350	●	1745-0350D350	■
	0.0400	1/8	0.200	2 1/2	0.400	1745-0400.400	●	1745-0400L400	●	1745-0400D400	■
	0.0450	1/8	0.225	2 1/2	0.450	1745-0450.450	●	1745-0450L450	●	1745-0450D450	■
<b>NEW</b>	0.0469 (3/64)	1/8	0.250	2 1/2	0.500	1745-0469.500	●	1745-0469L500	●	1745-0469D500	■
	0.0500	1/8	0.300	2 1/2	0.600	1745-0500.600	●	1745-0500L600	●	1745-0500D600	■
	0.0550	1/8	0.385	2 1/2	0.770	1745-0550.770	●	1745-0550L770	●	1745-0550D770	■
	0.0600	1/8	0.500	2 1/2	1.000	1745-0600.1000	●	1745-0600L1000	●	1745-0600D1000	■
<b>NEW</b>	0.0625 (1/16)	1/8	0.500	2 1/2	1.000	1745-0625.1000	●	1745-0625L1000	●	1745-0625D1000	■
	0.0650	1/8	0.500	2 1/2	1.000	1745-0650.1000	●	1745-0650L1000	●	1745-0650D1000	■
	0.0700	1/8	0.500	2 1/2	1.000	1745-0700.1000	●	1745-0700L1000	●	1745-0700D1000	■
	0.0750	1/8	0.500	2 1/2	1.000	1745-0750.1000	●	1745-0750L1000	●	1745-0750D1000	■
<b>NEW</b>	0.0781 (5/64)	1/8	0.500	2 1/2	1.000	1745-0781.1000	●	1745-0781L1000	●	1745-0781D1000	■
	0.0800	1/8	0.750	2 1/2	1.250	1745-0800.1250	●	1745-0800L1250	●	1745-0800D1250	■
	0.0850	1/8	0.750	2 1/2	1.250	1745-0850.1250	●	1745-0850L1250	●	1745-0850D1250	■
	0.0900	1/8	0.750	2 1/2	1.250	1745-0900.1250	●	1745-0900L1250	●	1745-0900D1250	■
<b>NEW</b>	0.0938 (3/32)	1/8	0.750	2 1/2	1.250	1745-0938.1250	●	1745-0938L1250	●	1745-0938D1250	■
	0.0950	1/8	0.750	2 1/2	1.250	1745-0950.1250	●	1745-0950L1250	●	1745-0950D1250	■
	0.1000	1/8	0.750	2 1/2	1.250	1745-1000.1250	●	1745-1000L1250	●	1745-1000D1250	■

\*DLC is Amorphous Diamond

### SERIES 1745 WORKPIECE MATERIAL

Coating	P	P	H	H	M	K	N	N	N	N	N	N	S	S	
	Steel ~30HRC	Steel 30-40HRC	Hardened Steel ~55HRC	Hardened Steel ~68HRC	Stainless Steel	Cast Iron	Aluminum	Graphite	Copper Alloy	CFRP	Plastic	Thermoset Plastic	High Density Plastic	Nickel / Cobalt	Titanium Alloy
AlTiN	★	★	★	☆	☆	☆								☆	☆
DLC							☆	★	☆	★	★	★			
Uncoated							☆	☆	☆	☆	☆	☆	☆		☆

★ : Priority ☆ : Applicable Materials

Symbol Descriptions [Page vii](#)

## 3 FLUTE NEW

0.0100" - 0.0312" DIAMETER

Mirror Surface Finishes

Sub Micron Grain Carbide

EXTENDED REACH STUB LENGTH BALL NOSE END MILLS



### EXTENDED Reach **STUB** Length (Inch Sizes)

Dimensions (in)					Uncoated		AlTiN Coating		<span style="color:red">NEW</span> DLC* Coating	
D <sup>+0.000</sup> / <sub>-0.001</sub>	d	l	L	L <sub>1</sub>	Part Number	Stock	Part Number	Stock	Part Number	Stock
0.0100	1/8	0.015	2 1/2	0.050	1755-0100.050	●	1755-0100L050	●	1755-0100D050	■
0.0100	1/8	0.015	2 1/2	0.080	1755-0100.080	●	1755-0100L080	●	1755-0100D080	■
0.0100	1/8	0.015	2 1/2	0.125	1755-0100.125	●	1755-0100L125	●	1755-0100D125	■
0.0100	1/8	0.015	2 1/2	0.150	1755-0100.150	●	1755-0100L150	●	1755-0100D150	■
0.0156 (1/64)	1/8	0.022	2 1/2	0.045	1755-0156.045	●	1755-0156L045	●	1755-0156D045	■
0.0156 (1/64)	1/8	0.022	2 1/2	0.078	1755-0156.078	●	1755-0156L078	●	1755-0156D078	■
0.0156 (1/64)	1/8	0.022	2 1/2	0.125	1755-0156.125	●	1755-0156L125	●	1755-0156D125	■
0.0156 (1/64)	1/8	0.022	2 1/2	0.156	1755-0156.156	●	1755-0156L156	●	1755-0156D156	■
0.0156 (1/64)	1/8	0.022	2 1/2	0.187	1755-0156.187	●	1755-0156L187	●	1755-0156D187	■
0.0156 (1/64)	1/8	0.022	2 1/2	0.225	1755-0156.225	●	1755-0156L225	●	1755-0156D225	■
0.0156 (1/64)	1/8	0.022	2 1/2	0.300	1755-0156.300	●	1755-0156L300	●	1755-0156D300	■
0.0200	1/8	0.030	2 1/2	0.100	1755-0200.100	●	1755-0200L100	●	1755-0200D100	■
0.0200	1/8	0.030	2 1/2	0.160	1755-0200.160	●	1755-0200L160	●	1755-0200D160	■
0.0200	1/8	0.030	2 1/2	0.250	1755-0200.250	●	1755-0200L250	●	1755-0200D250	■
0.0200	1/8	0.030	2 1/2	0.300	1755-0200.300	●	1755-0200L300	●	1755-0200D300	■
0.0200	1/8	0.030	2 1/2	0.400	1755-0200.400	●	1755-0200L400	●	1755-0200D400	■
0.0250	1/8	0.037	2 1/2	0.125	1755-0250.125	●	1755-0250L125	●	1755-0250D125	■
0.0250	1/8	0.037	2 1/2	0.203	1755-0250.203	●	1755-0250L203	●	1755-0250D203	■
0.0250	1/8	0.037	2 1/2	0.312	1755-0250.312	●	1755-0250L312	●	1755-0250D312	■
0.0250	1/8	0.037	2 1/2	0.375	1755-0250.375	●	1755-0250L375	●	1755-0250D375	■
0.0300	1/8	0.045	2 1/2	0.156	1755-0300.156	●	1755-0300L156	●	1755-0300D156	■
0.0300	1/8	0.045	2 1/2	0.250	1755-0300.250	●	1755-0300L250	●	1755-0300D250	■
0.0300	1/8	0.045	2 1/2	0.375	1755-0300.375	●	1755-0300L375	●	1755-0300D375	■
0.0300	1/8	0.045	2 1/2	0.450	1755-0300.450	●	1755-0300L450	●	1755-0300D450	■
0.0312 (1/32)	1/8	0.046	2 1/2	0.093	1755-0312.093	●	1755-0312L093	●	1755-0312D093	■
0.0312 (1/32)	1/8	0.046	2 1/2	0.156	1755-0312.156	●	1755-0312L156	●	1755-0312D156	■
0.0312 (1/32)	1/8	0.046	2 1/2	0.250	1755-0312.250	●	1755-0312L250	●	1755-0312D250	■
0.0312 (1/32)	1/8	0.046	2 1/2	0.312	1755-0312.312	●	1755-0312L312	●	1755-0312D312	■
0.0312 (1/32)	1/8	0.046	2 1/2	0.375	1755-0312.375	●	1755-0312L375	●	1755-0312D375	■
0.0312 (1/32)	1/8	0.046	2 1/2	0.470	1755-0312.470	●	1755-0312L470	●	1755-0312D470	■
0.0312 (1/32)	1/8	0.046	2 1/2	0.565	1755-0312.565	●	1755-0312L565	●	1755-0312D565	■
0.0312 (1/32)	1/8	0.046	2 1/2	0.625	1755-0312.625	●	1755-0312L625	●	1755-0312D625	■
0.0312 (1/32)	1/8	0.046	2 1/2	0.775	1755-0312.775	●	1755-0312L775	●	1755-0312D775	■

\*DLC is Amorphous Diamond

SERIES 1755 WORKPIECE MATERIAL															
Coating	P	P	H	H	M	K	N	N	N	N	N	N	S	S	
	Steel ~30HRC	Steel 30-40HRC	Hardened Steel ~55HRC	Hardened Steel ~68HRC	Stainless Steel	Cast Iron	Aluminum	Graphite	Copper Alloy	CFRP	Plastic	Thermoset Plastic	High Density Plastic	Nickel / Cobalt	Titanium Alloy
AlTiN	★	★	★	☆	☆	☆								☆	☆
DLC							☆	★	☆	★	★	★			
Uncoated							☆	☆	☆	☆	☆	☆	☆		☆

★ : Priority ☆ : Applicable Materials

Symbol Descriptions [Page vii](#)

● : U.S. Stock Standard  
 ■ : NOT STOCKED - Call for Delivery  
 ▲ : Coming Soon

## 3 FLUTE NEW

**0.0350" - 0.0600" DIAMETER**

Mirror Surface Finishes

Sub Micron Grain Carbide

### EXTENDED REACH STUB LENGTH BALL NOSE END MILLS



### EXTENDED Reach **STUB** Length (Inch Sizes)

Dimensions (in)					Uncoated		AlTiN Coating		<span style="color:red">NEW</span> DLC* Coating	
D	d	l	L	L <sub>1</sub>	Part Number	Stock	Part Number	Stock	Part Number	Stock
0.0350	1/8	0.052	2 1/2	0.187	1755-0350.187	●	1755-0350L187	●	1755-0350D187	■
0.0350	1/8	0.052	2 1/2	0.281	1755-0350.281	●	1755-0350L281	●	1755-0350D281	■
0.0350	1/8	0.052	2 1/2	0.425	1755-0350.425	●	1755-0350L425	●	1755-0350D425	■
0.0350	1/8	0.052	2 1/2	0.525	1755-0350.525	●	1755-0350L525	●	1755-0350D525	■
0.0400	1/8	0.060	2 1/2	0.203	1755-0400.203	●	1755-0400L203	●	1755-0400D203	■
0.0400	1/8	0.060	2 1/2	0.325	1755-0400.325	●	1755-0400L325	●	1755-0400D325	■
0.0400	1/8	0.060	2 1/2	0.480	1755-0400.480	●	1755-0400L480	●	1755-0400D480	■
0.0400	1/8	0.060	2 1/2	0.600	1755-0400.600	●	1755-0400L600	●	1755-0400D600	■
0.0400	1/8	0.060	2 1/2	0.800	1755-0400.800	●	1755-0400L800	●	1755-0400D800	■
0.0450	1/8	0.067	2 1/2	0.225	1755-0450.225	●	1755-0450L225	●	1755-0450D225	■
0.0450	1/8	0.067	2 1/2	0.375	1755-0450.375	●	1755-0450L375	●	1755-0450D375	■
0.0450	1/8	0.067	2 1/2	0.550	1755-0450.550	●	1755-0450L550	●	1755-0450D550	■
0.0450	1/8	0.067	2 1/2	0.680	1755-0450.680	●	1755-0450L680	●	1755-0450D680	■
0.0469 (3/64)	1/8	0.070	2 1/2	0.141	1755-0469.141	●	1755-0469L141	●	1755-0469D141	■
0.0469 (3/64)	1/8	0.070	2 1/2	0.250	1755-0469.250	●	1755-0469L250	●	1755-0469D250	■
0.0469 (3/64)	1/8	0.070	2 1/2	0.375	1755-0469.375	●	1755-0469L375	●	1755-0469D375	■
0.0469 (3/64)	1/8	0.070	2 1/2	0.480	1755-0469.480	●	1755-0469L480	●	1755-0469D480	■
0.0469 (3/64)	1/8	0.070	2 1/2	0.570	1755-0469.570	●	1755-0469L570	●	1755-0469D570	■
0.0469 (3/64)	1/8	0.070	2 1/2	0.710	1755-0469.710	●	1755-0469L710	●	1755-0469D710	■
0.0469 (3/64)	1/8	0.070	2 1/2	0.950	1755-0469.950	●	1755-0469L950	●	1755-0469D950	■
0.0469 (3/64)	1/8	0.070	2 1/2	1.187	1755-0469.1187	●	1755-0469L1187	●	1755-0469D1187	■
0.0500	1/8	0.075	2 1/2	0.250	1755-0500.250	●	1755-0500L250	●	1755-0500D250	■
0.0500	1/8	0.075	2 1/2	0.400	1755-0500.400	●	1755-0500L400	●	1755-0500D400	■
0.0500	1/8	0.075	2 1/2	0.600	1755-0500.600	●	1755-0500L600	●	1755-0500D600	■
0.0550	1/8	0.082	2 1/2	0.275	1755-0550.275	●	1755-0550L275	●	1755-0550D275	■
0.0550	1/8	0.082	2 1/2	0.450	1755-0550.450	●	1755-0550L450	●	1755-0550D450	■
0.0550	1/8	0.082	2 1/2	0.660	1755-0550.660	●	1755-0550L660	●	1755-0550D660	■
0.0600	1/8	0.090	2 1/2	0.312	1755-0600.312	●	1755-0600L312	●	1755-0600D312	■
0.0600	1/8	0.090	2 1/2	0.500	1755-0600.500	●	1755-0600L500	●	1755-0600D500	■
0.0600	1/8	0.090	2 1/2	0.720	1755-0600.720	●	1755-0600L720	●	1755-0600D720	■
0.0600	1/8	0.090	2 1/2	0.900	1755-0600.900	●	1755-0600L900	●	1755-0600D900	■
0.0600	1/8	0.090	2 1/2	1.080	1755-0600.1080	●	1755-0600L1080	●	1755-0600D1080	■
0.0600	1/8	0.090	2 1/2	1.260	1755-0600.1260	●	1755-0600L1260	●	1755-0600D1260	■

\*DLC is Amorphous Diamond

SERIES 1755 WORKPIECE MATERIAL															
Coating	P	P	H	H	M	K	N	N	N	N	N	N	S	S	
	Steel -30HRC	Steel 30-40HRC	Hardened Steel -55HRC	Hardened Steel -68HRC	Stainless Steel	Cast Iron	Aluminum	Graphite	Copper Alloy	CFRP	Plastic	Thermoset Plastic	High Density Plastic	Nickel / Cobalt	Titanium Alloy
AlTiN	★	★	★	☆	☆	☆								☆	☆
DLC							☆	★	☆	★	★	★			
Uncoated							☆	☆	☆	☆	☆	☆	☆		☆

★ : Priority ☆ : Applicable Materials

Symbol Descriptions [Page vii](#)

## 3 FLUTE NEW

**0.0625" - 0.0900" DIAMETER**

Mirror Surface Finishes

Sub Micron Grain Carbide

EXTENDED REACH STUB LENGTH BALL NOSE END MILLS



### EXTENDED Reach **STUB** Length (Inch Sizes)

Dimensions (in)					Uncoated		AlTiN Coating		<span style="color:red">NEW</span> DLC* Coating	
D <sup>+0.000</sup> / <sub>-0.001</sub>	d	ℓ	L	L <sub>1</sub>	Part Number	Stock	Part Number	Stock	Part Number	Stock
0.0625 (1/16)	1/8	0.093	2 1/2	0.186	1755-0625.186	●	1755-0625L186	●	1755-0625D186	■
0.0625 (1/16)	1/8	0.093	2 1/2	0.312	1755-0625.312	●	1755-0625L312	●	1755-0625D312	■
0.0625 (1/16)	1/8	0.093	2 1/2	0.500	1755-0625.500	●	1755-0625L500	●	1755-0625D500	■
0.0625 (1/16)	1/8	0.093	2 1/2	0.625	1755-0625.625	●	1755-0625L625	●	1755-0625D625	■
0.0625 (1/16)	1/8	0.093	2 1/2	0.750	1755-0625.750	●	1755-0625L750	●	1755-0625D750	■
0.0625 (1/16)	1/8	0.093	2 1/2	0.950	1755-0625.950	●	1755-0625L950	●	1755-0625D950	■
0.0625 (1/16)	1/8	0.093	2 1/2	1.125	1755-0625.1125	●	1755-0625L1125	●	1755-0625D1125	■
0.0625 (1/16)	1/8	0.093	2 1/2	1.250	1755-0625.1250	●	1755-0625L1250	●	1755-0625D1250	■
0.0625 (1/16)	1/8	0.093	3	1.550	1755-0625.1550	●	1755-0625L1550	●	1755-0625D1550	■
0.0650	1/8	0.097	2 1/2	0.325	1755-0650.325	●	1755-0650L325	●	1755-0650D325	■
0.0650	1/8	0.097	2 1/2	0.530	1755-0650.530	●	1755-0650L530	●	1755-0650D530	■
0.0700	1/8	0.105	2 1/2	0.375	1755-0700.375	●	1755-0700L375	●	1755-0700D375	■
0.0700	1/8	0.105	2 1/2	0.570	1755-0700.570	●	1755-0700L570	●	1755-0700D570	■
0.0750	1/8	0.112	2 1/2	0.375	1755-0750.375	●	1755-0750L375	●	1755-0750D375	■
0.0750	1/8	0.112	2 1/2	0.625	1755-0750.625	●	1755-0750L625	●	1755-0750D625	■
0.0781 (5/64)	1/8	0.117	2 1/2	0.234	1755-0781.234	●	1755-0781L234	●	1755-0781D234	■
0.0781 (5/64)	1/8	0.117	2 1/2	0.406	1755-0781.406	●	1755-0781L406	●	1755-0781D406	■
0.0781 (5/64)	1/8	0.117	2 1/2	0.625	1755-0781.625	●	1755-0781L625	●	1755-0781D625	■
0.0781 (5/64)	1/8	0.117	2 1/2	0.800	1755-0781.800	●	1755-0781L800	●	1755-0781D800	■
0.0781 (5/64)	1/8	0.117	2 1/2	0.940	1755-0781.940	●	1755-0781L940	●	1755-0781D940	■
0.0781 (5/64)	1/8	0.117	2 1/2	1.187	1755-0781.1187	●	1755-0781L1187	●	1755-0781D1187	■
0.0781 (5/64)	1/8	0.117	3	1.562	1755-0781.1562	●	1755-0781L1562	●	1755-0781D1562	■
0.0781 (5/64)	1/8	0.117	3	1.950	1755-0781.1950	●	1755-0781L1950	●	1755-0781D1950	■
0.0800	1/8	0.120	2 1/2	0.406	1755-0800.406	●	1755-0800L406	●	1755-0800D406	■
0.0800	1/8	0.120	2 1/2	0.650	1755-0800.650	●	1755-0800L650	●	1755-0800D650	■
0.0850	1/8	0.127	2 1/2	0.425	1755-0850.425	●	1755-0850L425	●	1755-0850D425	■
0.0850	1/8	0.127	2 1/2	0.700	1755-0850.700	●	1755-0850L700	●	1755-0850D700	■
0.0900	1/8	0.120	2 1/2	0.450	1755-0900.450	●	1755-0900L450	●	1755-0900D450	■
0.0900	1/8	0.120	2 1/2	0.750	1755-0900.750	●	1755-0900L750	●	1755-0900D750	■

\*DLC is Amorphous Diamond

SERIES 1755 WORKPIECE MATERIAL															
Coating	P Steel ~30HRC	P Steel 30~40HRC	H Hardened Steel ~55HRC	H Hardened Steel ~68HRC	M Stainless Steel	K Cast Iron	N Aluminum	N Graphite	N Copper Alloy	N CFRP	N Plastic	N Thermoset Plastic	N High Density Plastic	S Nickel / Cobalt	S Titanium Alloy
AlTiN	★	★	★	☆	☆	☆								☆	☆
DLC							☆	★	☆	★	★	★			
Uncoated							☆	☆	☆	☆	☆	☆	☆		☆

★ : Priority ☆ : Applicable Materials

Symbol Descriptions [Page vii](#)

- : U.S. Stock Standard
- : NOT STOCKED - Call for Delivery
- ▲ : Coming Soon

(U.S.) 1.888.848.8449  
 (International) 001.714.428.3636  
 Pricing & Availability at [KyoceraPrecisionTools.com](http://KyoceraPrecisionTools.com)

DRILLS **A**  
 END MILLS **B**  
 ROUTERS **C**  
 THREAD MILLS & TAPS **D**  
 ENGRAVERS **E**  
 BORING BARS **F**  
 REAMERS **G**  
 SAWS **H**  
 TECHNICAL **I**  
 INDEX **J**



## 3 FLUTE NEW

**0.0938" - 0.2500" DIAMETER**

Mirror Surface Finishes

Sub Micron Grain Carbide

### EXTENDED REACH STUB LENGTH BALL NOSE END MILLS



### EXTENDED Reach **STUB** Length (Inch Sizes)

Dimensions (in)					Uncoated		AlTiN Coating		<span style="color:red">NEW</span> DLC* Coating	
D	d	ℓ	L	L <sub>1</sub>	Part Number	Stock	Part Number	Stock	Part Number	Stock
0.0938 (3/32)	1/8	0.139	2 1/2	0.279	1755-0938.279	●	1755-0938L279	●	1755-0938D279	■
0.0938 (3/32)	1/8	0.139	2 1/2	0.500	1755-0938.500	●	1755-0938L500	●	1755-0938D500	■
0.0938 (3/32)	1/8	0.139	2 1/2	0.750	1755-0938.750	●	1755-0938L750	●	1755-0938D750	■
0.0938 (3/32)	1/8	0.139	2 1/2	0.950	1755-0938.950	●	1755-0938L950	●	1755-0938D950	■
0.0938 (3/32)	1/8	0.139	2 1/2	1.125	1755-0938.1125	●	1755-0938L1125	●	1755-0938D1125	■
0.0938 (3/32)	1/8	0.139	3	1.400	1755-0938.1400	●	1755-0938L1400	●	1755-0938D1400	■
0.0938 (3/32)	1/8	0.139	3	1.675	1755-0938.1675	●	1755-0938L1675	●	1755-0938D1675	■
0.0938 (3/32)	1/8	0.139	4	1.875	1755-0938.1875	●	1755-0938L1875	●	1755-0938D1875	■
0.0938 (3/32)	1/8	0.139	4	2.312	1755-0938.2312	●	1755-0938L2312	●	1755-0938D2312	■
0.0950	1/8	0.142	2 1/2	0.500	1755-0950.500	●	1755-0950L500	●	1755-0950D500	■
0.0950	1/8	0.142	2 1/2	0.750	1755-0950.750	●	1755-0950L750	●	1755-0950D750	■
0.1000	1/8	0.150	2 1/2	0.500	1755-1000.500	●	1755-1000L500	●	1755-1000D500	■
0.1000	1/8	0.150	2 1/2	0.800	1755-1000.800	●	1755-1000L800	●	1755-1000D800	■
0.1250 (1/8)	1/8	0.187	2 1/2	0.625	1755-1250.625	●	1755-1250L625	●	1755-1250D625	■
0.1250 (1/8)	1/8	0.187	2 1/2	1.000	1755-1250.1000	●	1755-1250L1000	●	1755-1250D1000	■
0.1250 (1/8)	1/8	0.187	2 1/2	1.250	1755-1250.1250	●	1755-1250L1250	●	1755-1250D1250	■
0.1250 (1/8)	1/8	0.187	3	1.500	1755-1250.1500	●	1755-1250L1500	●	1755-1250D1500	■
0.1250 (1/8)	1/8	0.187	3	1.875	1755-1250.1875	●	1755-1250L1875	●	1755-1250D1875	■
0.1250 (1/8)	1/8	0.187	4	2.250	1755-1250.2250	●	1755-1250L2250	●	1755-1250D2250	■
0.1250 (1/8)	1/8	0.187	4	2.500	1755-1250.2500	●	1755-1250L2500	●	1755-1250D2500	■
0.1250 (1/8)	1/8	0.187	4	3.125	1755-1250.3125	●	1755-1250L3125	●	1755-1250D3125	■
0.1562 (5/32)	3/16	0.234	3	0.750	1755-1562.750	●	1755-1562L750	●	1755-1562D750	■
0.1562 (5/32)	3/16	0.234	3	1.250	1755-1562.1250	●	1755-1562L1250	●	1755-1562D1250	■
0.1875 (3/16)	3/16	0.281	3	1.000	1755-1875.1000	●	1755-1875L1000	●	1755-1875D1000	■
0.1875 (3/16)	3/16	0.281	3	1.500	1755-1875.1500	●	1755-1875L1500	●	1755-1875D1500	■
0.1875 (3/16)	3/16	0.281	4	1.875	1755-1875.1875	●	1755-1875L1875	●	1755-1875D1875	■
0.1875 (3/16)	3/16	0.281	4	2.250	1755-1875.2250	●	1755-1875L2250	●	1755-1875D2250	■
0.1875 (3/16)	3/16	0.281	4	2.812	1755-1875.2812	●	1755-1875L2812	●	1755-1875D2812	■
0.2500 (1/4)	1/4	0.375	4	1.250	1755-2500.1250	●	1755-2500L1250	●	1755-2500D1250	■
0.2500 (1/4)	1/4	0.375	4	2.000	1755-2500.2000	●	1755-2500L2000	●	1755-2500D2000	■
0.2500 (1/4)	1/4	0.375	4	2.500	1755-2500.2500	●	1755-2500L2500	●	1755-2500D2500	■
0.2500 (1/4)	1/4	0.375	6	3.000	1755-2500.3000	●	1755-2500L3000	●	1755-2500D3000	■
0.2500 (1/4)	1/4	0.375	6	3.750	1755-2500.3750	●	1755-2500L3750	●	1755-2500D3750	■

\*DLC is Amorphous Diamond

### SERIES 1755 WORKPIECE MATERIAL

Coating	P	P	H	H	M	K	N	N	N	N	N	N	S	S	
	Steel -30HRC	Steel 30-40HRC	Hardened Steel -55HRC	Hardened Steel -68HRC	Stainless Steel	Cast Iron	Aluminum	Graphite	Copper Alloy	CFRP	Plastic	Thermoset Plastic	High Density Plastic	Nickel / Cobalt	Titanium Alloy
AlTiN	★	★	★	☆	☆	☆								☆	☆
DLC							☆	★	☆	★	★	★			
Uncoated							☆	☆	☆	☆	☆	☆	☆		☆

★ : Priority ☆ : Applicable Materials

Symbol Descriptions [Page vii](#)

## 4 FLUTE

STANDARD LENGTH BALL NOSE END MILLS

0.0100" - 0.0360" DIAMETER

Mirror Surface Finishes

Sub Micron Grain Carbide

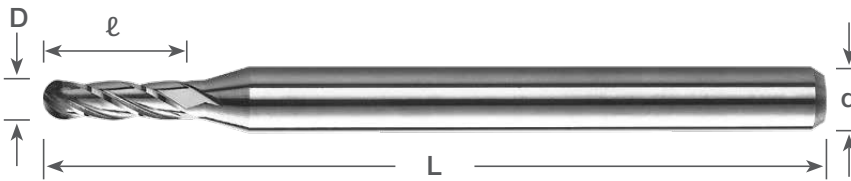

### STANDARD Length (Inch Sizes)

	Dimensions (in)				Uncoated		AlTiN Coating		NEW DLC* Coating	
	D <sup>+0.000</sup> / <sub>-0.001</sub>	d	ℓ	L	Part Number	Stock	Part Number	Stock	Part Number	Stock
NEW	0.0100	1/8	0.030	1 1/2	1825-0100.030	●	1825-0100L030	●	1825-0100D030	■
NEW	0.0110	1/8	0.033	1 1/2	1825-0110.033	●	1825-0110L033	●	-	-
NEW	0.0120	1/8	0.036	1 1/2	1825-0120.036	●	1825-0120L036	●	-	-
NEW	0.0130	1/8	0.039	1 1/2	1825-0130.039	●	1825-0130L039	●	-	-
NEW	0.0140	1/8	0.042	1 1/2	1825-0140.042	●	1825-0140L042	●	-	-
	0.0156 (1/64)	1/8	0.047	1 1/2	1825-0156.047	●	1825-0156L047	●	1825-0156D047	■
NEW	0.0160	1/8	0.048	1 1/2	1825-0160.048	●	1825-0160L048	●	-	-
NEW	0.0170	1/8	0.051	1 1/2	1825-0170.051	●	1825-0170L051	●	-	-
NEW	0.0180	1/8	0.054	1 1/2	1825-0180.054	●	1825-0180L054	●	-	-
NEW	0.0190	1/8	0.057	1 1/2	1825-0190.057	●	1825-0190L057	●	-	-
NEW	0.0200	1/8	0.060	1 1/2	1825-0200.060	●	1825-0200L060	●	1825-0200D060	■
NEW	0.0210	1/8	0.063	1 1/2	1825-0210.063	●	1825-0210L063	●	-	-
NEW	0.0220	1/8	0.066	1 1/2	1825-0220.066	●	1825-0220L066	●	-	-
NEW	0.0230	1/8	0.069	1 1/2	1825-0230.069	●	1825-0230L069	●	-	-
NEW	0.0240	1/8	0.072	1 1/2	1825-0240.072	●	1825-0240L072	●	-	-
NEW	0.0250	1/8	0.075	1 1/2	1825-0250.075	●	1825-0250L075	●	1825-0250D075	■
NEW	0.0260	1/8	0.078	1 1/2	1825-0260.078	●	1825-0260L078	●	-	-
NEW	0.0270	1/8	0.081	1 1/2	1825-0270.081	●	1825-0270L081	●	-	-
NEW	0.0280	1/8	0.084	1 1/2	1825-0280.084	●	1825-0280L084	●	-	-
NEW	0.0290	1/8	0.087	1 1/2	1825-0290.087	●	1825-0290L087	●	-	-
NEW	0.0300	1/8	0.090	1 1/2	1825-0300.090	●	1825-0300L090	●	1825-0300D090	■
	0.0312 (1/32)	1/8	0.094	1 1/2	1825-0312.094	●	1825-0312L094	●	1825-0312D094	■
NEW	0.0320	1/8	0.096	1 1/2	1825-0320.096	●	1825-0320L096	●	-	-
NEW	0.0330	1/8	0.099	1 1/2	1825-0330.099	●	1825-0330L099	●	-	-
NEW	0.0340	1/8	0.102	1 1/2	1825-0340.102	●	1825-0340L102	●	-	-
NEW	0.0350	1/8	0.105	1 1/2	1825-0350.105	●	1825-0350L105	●	1825-0350D105	■
NEW	0.0360	1/8	0.108	1 1/2	1825-0360.108	●	1825-0360L108	●	-	-

\*DLC is Amorphous Diamond

SERIES 1825 WORKPIECE MATERIAL															
Coating	P	P	H	H	M	K	N	N	N	N	N	N	S	S	
	Steel ~30HRC	Steel 30~40HRC	Hardened Steel ~55HRC	Hardened Steel ~68HRC	Stainless Steel	Cast Iron	Aluminum	Graphite	Copper Alloy	CFRP	Plastic	Thermoset Plastic	High Density Plastic	Nickel / Cobalt	Titanium Alloy
AlTiN	★	★	★	☆	☆	☆								☆	☆
DLC							☆	★	☆	★	★	★			
Uncoated							☆	☆	☆	☆	☆	☆	☆		☆

★ : Priority ☆ : Applicable Materials

Symbol Descriptions Page vii

● : U.S. Stock Standard  
 ■ : NOT STOCKED - Call for Delivery  
 ▲ : Coming Soon

(U.S.) 1.888.848.8449  
 (International) 001.714.428.3636  
 Pricing & Availability at [KyoceraPrecisionTools.com](http://KyoceraPrecisionTools.com)

DRILLS A  
 END MILLS B  
 ROUTERS C  
 THREAD MILLS & TAPS D  
 ENGRAVERS E  
 BORING BARS F  
 REAMERS G  
 SAWS H  
 TECHNICAL I  
 INDEX J

## 4 FLUTE

**0.0370" - 0.0650" DIAMETER**

Mirror Surface Finishes

Sub Micron Grain Carbide

STANDARD LENGTH BALL NOSE END MILLS

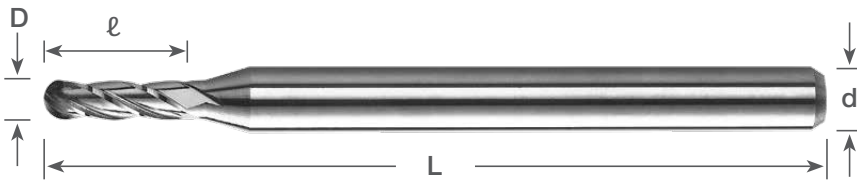

### STANDARD Length (Inch Sizes)

	Dimensions (in)				Uncoated		AlTiN Coating		NEW DLC* Coating	
	D <sup>+0.000</sup> <sub>-0.001</sub>	d	ℓ	L	Part Number	Stock	Part Number	Stock	Part Number	Stock
NEW	0.0370	1/8	0.111	1 1/2	1825-0370.111	●	1825-0370L111	●	-	-
NEW	0.0380	1/8	0.114	1 1/2	1825-0380.114	●	1825-0380L114	●	-	-
NEW	0.0394	1/8	0.117	1 1/2	1825-0394.117	●	1825-0394L117	●	1825-0394D117	■
NEW	0.0400	1/8	0.120	1 1/2	1825-0400.120	●	1825-0400L120	●	1825-0400D120	■
NEW	0.0410	1/8	0.123	1 1/2	1825-0410.123	●	1825-0410L123	●	-	-
NEW	0.0420	1/8	0.126	1 1/2	1825-0420.126	●	1825-0420L126	●	-	-
NEW	0.0430	1/8	0.129	1 1/2	1825-0430.129	●	1825-0430L129	●	-	-
NEW	0.0440	1/8	0.132	1 1/2	1825-0440.132	●	1825-0440L132	●	-	-
NEW	0.0450	1/8	0.135	1 1/2	1825-0450.135	●	1825-0450L135	●	1825-0450D135	■
NEW	0.0460	1/8	0.138	1 1/2	1825-0460.138	●	1825-0460L138	●	-	-
	0.0469 (3/64)	1/8	0.141	1 1/2	1825-0469.141	●	1825-0469L141	●	1825-0469D141	■
NEW	0.0480	1/8	0.144	1 1/2	1825-0480.144	●	1825-0480L144	●	-	-
NEW	0.0490	1/8	0.147	1 1/2	1825-0490.147	●	1825-0490L147	●	-	-
NEW	0.0500	1/8	0.150	1 1/2	1825-0500.150	●	1825-0500L150	●	1825-0500D150	■
NEW	0.0510	1/8	0.153	1 1/2	1825-0510.153	●	1825-0510L153	●	-	-
NEW	0.0520	1/8	0.156	1 1/2	1825-0520.156	●	1825-0520L156	●	-	-
NEW	0.0530	1/8	0.159	1 1/2	1825-0530.159	●	1825-0530L159	●	-	-
NEW	0.0540	1/8	0.162	1 1/2	1825-0540.162	●	1825-0540L162	●	-	-
NEW	0.0550	1/8	0.165	1 1/2	1825-0550.165	●	1825-0550L165	●	1825-0550D165	■
NEW	0.0560	1/8	0.168	1 1/2	1825-0560.168	●	1825-0560L168	●	-	-
NEW	0.0570	1/8	0.171	1 1/2	1825-0570.171	●	1825-0570L171	●	-	-
NEW	0.0580	1/8	0.174	1 1/2	1825-0580.174	●	1825-0580L174	●	-	-
NEW	0.0590	1/8	0.177	1 1/2	1825-0590.177	●	1825-0590L177	●	-	-
NEW	0.0600	1/8	0.180	1 1/2	1825-0600.180	●	1825-0600L180	●	1825-0600D180	■
	0.0625 (1/16)	1/8	0.188	1 1/2	1825-0625.188	●	1825-0625L188	●	1825-0625D188	■
NEW	0.0650	1/8	0.195	1 1/2	1825-0650.195	●	1825-0650L195	●	-	-

\*DLC is Amorphous Diamond

### SERIES 1825 WORKPIECE MATERIAL

Coating	P Steel ~30HRC	P Steel 30-40HRC	H Hardened Steel ~55HRC	H Hardened Steel ~68HRC	M Stainless Steel	K Cast Iron	N Aluminum	N Graphite	N Copper Alloy	N CFRP	N Plastic	N Thermoset Plastic	N High Density Plastic	S Nickel / Cobalt	S Titanium Alloy
AlTiN	★	★	★	☆	☆	☆								☆	☆
DLC							☆	★	☆	★	★	★			
Uncoated							☆	☆	☆	☆	☆	☆	☆		☆

★ : Priority ☆ : Applicable Materials

Symbol Descriptions [Page vii](#)

## 4 FLUTE

STANDARD LENGTH BALL NOSE END MILLS

**0.0700" - 0.2500" DIAMETER**

Mirror Surface Finishes

Sub Micron Grain Carbide

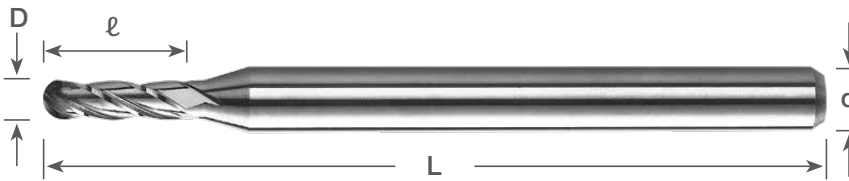

### STANDARD Length (Inch Sizes)

Dimensions (in)				Uncoated		AlTiN Coating		NEW DLC* Coating	
D <sup>+0.000</sup> <sub>-0.001</sub>	d	ℓ	L	Part Number	Stock	Part Number	Stock	Part Number	Stock
NEW 0.0700	1/8	0.210	1 1/2	1825-0700.210	●	1825-0700L210	●	1825-0700D210	■
NEW 0.0750	1/8	0.225	1 1/2	1825-0750.225	●	1825-0750L225	●	1825-0750D225	■
0.0781 (5/64)	1/8	0.234	1 1/2	1825-0781.234	●	1825-0781L234	●	1825-0781D234	■
NEW 0.0800	1/8	0.240	1 1/2	1825-0800.240	●	1825-0800L240	●	1825-0800D240	■
NEW 0.0850	1/8	0.255	1 1/2	1825-0850.255	●	1825-0850L255	●	1825-0850D255	■
NEW 0.0900	1/8	0.270	1 1/2	1825-0900.270	●	1825-0900L270	●	1825-0900D270	■
0.0938 (3/32)	1/8	0.281	1 1/2	1825-0938.281	●	1825-0938L281	●	1825-0938D281	■
NEW 0.0950	1/8	0.285	1 1/2	1825-0950.285	●	1825-0950L285	●	1825-0950D285	■
NEW 0.1000	1/8	0.300	1 1/2	1825-1000.300	●	1825-1000L300	●	1825-1000D300	■
NEW 0.1050	1/8	0.315	1 1/2	1825-1050.315	●	1825-1050L315	●	1825-1050D315	■
0.1094 (7/64)	1/8	0.328	1 1/2	1825-1094.328	●	1825-1094L328	●	1825-1094D328	■
NEW 0.1100	1/8	0.330	1 1/2	1825-1100.330	●	1825-1100L330	●	1825-1100D330	■
NEW 0.1150	1/8	0.345	1 1/2	1825-1150.345	●	1825-1150L345	●	1825-1150D345	■
NEW 0.1181	1/8	0.355	1 1/2	1825-1181.355	●	1825-1181L355	●	1825-1181D355	■
NEW 0.1200	1/8	0.360	1 1/2	1825-1200.360	●	1825-1200L360	●	1825-1200D360	■
0.1250 (1/8)	1/8	0.375	1 1/2	1825-1250.375	●	1825-1250L375	●	1825-1250D375	■
0.1406 (9/64)	3/16	0.500	2	1825-1406.500	●	1825-1406L500	●	1825-1406D500	■
NEW 0.1562 (5/32)	3/16	0.562	2	1825-1562.562	●	1825-1562L562	●	1825-1562D562	■
0.1563 (5/32)	3/16	0.500	2	1825-1563.500	●	1825-1563L500	●	1825-1563D500	■
0.1719 (11/64)	3/16	0.563	2	1825-1719.563	●	1825-1719L563	●	1825-1719D563	■
0.1875 (3/16)	3/16	0.563	2	1825-1875.563	●	1825-1875L563	●	1825-1875D563	■
NEW 0.1875 (3/16)	3/16	0.625	2	1825-1875.625	●	1825-1875L625	●	1825-1875D625	■
0.2031 (13/64)	1/4	0.625	2 1/2	1825-2031.625	●	1825-2031L625	●	1825-2031D625	■
0.2188 (7/32)	1/4	0.625	2 1/2	1825-2188.625	●	1825-2188L625	●	1825-2188D625	■
0.2344 (15/64)	1/4	0.750	2 1/2	1825-2344.750	●	1825-2344L750	●	1825-2344D750	■
0.2500 (1/4)	1/4	0.750	2 1/2	1825-2500.750	●	1825-2500L750	●	1825-2500D750	■

\*DLC is Amorphous Diamond

SERIES 1825 WORKPIECE MATERIAL															
Coating	P	P	H	H	M	K	N	N	N	N	N	N	S	S	
	Steel ~30HRC	Steel 30~40HRC	Hardened Steel ~55HRC	Hardened Steel ~68HRC	Stainless Steel	Cast Iron	Aluminum	Graphite	Copper Alloy	CFRP	Plastic	Thermoset Plastic	High Density Plastic	Nickel / Cobalt	Titanium Alloy
AlTiN	★	★	★	☆	☆	☆								☆	☆
DLC							☆	★	☆	★	★	★			
Uncoated							☆	☆	☆	☆	☆	☆	☆		☆

★ : Priority ☆ : Applicable Materials

Symbol Descriptions Page vii

● : U.S. Stock Standard  
■ : NOT STOCKED - Call for Delivery  
▲ : Coming Soon

(U.S.) 1.888.848.8449  
(International) 001.714.428.3636  
Pricing & Availability at [KyoceraPrecisionTools.com](http://KyoceraPrecisionTools.com)

DRILLS A  
END MILLS B  
ROUTERS C  
THREAD MILLS & TAPS D  
ENGRAVERS E  
BORING BARS F  
REAMERS G  
SAWS H  
TECHNICAL I  
INDEX J

## 4 FLUTE

**0.40mm - 6.00mm DIAMETER**

Mirror Surface Finishes

Sub Micron Grain Carbide

STANDARD LENGTH BALL NOSE END MILLS

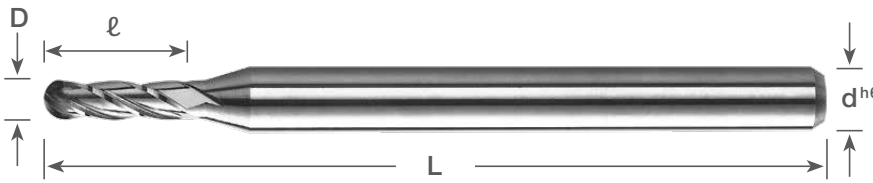

### STANDARD Length (Metric Sizes)

D	Dimensions (mm)				Uncoated		AlTiN Coating	
	$D^{+0.00mm/-0.02mm}$	$d^{h6}$	$\ell$	L	Part Number	Stock	Part Number	Stock
0.40		3	1.20	38	1825-0157.047	●	1825-0157L047	●
0.45		3	1.35	38	1825-0177.053	●	1825-0177L053	●
0.50		3	1.50	38	1825-0197.059	●	1825-0197L059	●
0.60		3	1.80	38	1825-0236.071	●	1825-0236L071	●
0.70		3	2.10	38	1825-0276.083	●	1825-0276L083	●
0.80		3	2.40	38	1825-0315.095	●	1825-0315L095	●
0.90		3	2.70	38	1825-0354.106	●	1825-0354L106	●
1.00		3	3.00	38	1825-0394.118	●	1825-0394L118	●
1.10		3	3.30	38	1825-0433.130	●	1825-0433L130	●
1.20		3	3.60	38	1825-0472.142	●	1825-0472L142	●
1.30		3	3.90	38	1825-0512.154	●	1825-0512L154	●
1.40		3	4.20	38	1825-0551.165	●	1825-0551L165	●
1.50		3	4.50	38	1825-0591.177	●	1825-0591L177	●
1.60		3	4.80	38	1825-0630.189	●	1825-0630L189	●
1.70		3	5.10	38	1825-0669.200	●	1825-0669L200	●
1.80		3	5.40	38	1825-0709.213	●	1825-0709L213	●
1.90		3	5.70	38	1825-0748.224	●	1825-0748L224	●
2.00		3	6.00	38	1825-0787.236	●	1825-0787L236	●
2.50		3	7.50	38	1825-0984.295	●	1825-0984L295	●
3.00		3	9.00	38	1825-1181.354	●	1825-1181L354	●
3.50		4	10.50	50	1825-1378.413	●	1825-1378L413	●
4.00		5	12.00	50	1825-1575.473	●	1825-1575L473	●
4.50		5	13.50	50	1825-1772.532	●	1825-1772L532	●
5.00		5	15.00	50	1825-1968.590	●	1825-1968L590	●
5.50		6	16.50	50	1825-2165.650	●	1825-2165L650	●
6.00		6	18.00	50	1825-2362.709	●	1825-2362L709	●

### SERIES 1825 WORKPIECE MATERIAL

Coating	P Steel ~30HRC	P Steel 30-40HRC	H Hardened Steel ~55HRC	H Hardened Steel ~68HRC	M Stainless Steel	K Cast Iron	N Aluminum	N Graphite	N Copper Alloy	N CFRP	N Plastic	N Thermoset Plastic	N High Density Plastic	S Nickel/ Cobalt	S Titanium Alloy
AlTiN	★	★	★	☆	☆	☆	☆	☆	☆	☆	☆	☆	☆	☆	☆
Uncoated							☆	☆	☆	☆	☆	☆	☆		☆

★ : Priority ☆ : Applicable Materials

Symbol Descriptions [Page vii](#)

## 4 FLUTE

STUB LENGTH BALL NOSE END MILLS

0.0100" - 0.0394" DIAMETER

Mirror Surface Finishes

Sub Micron Grain Carbide

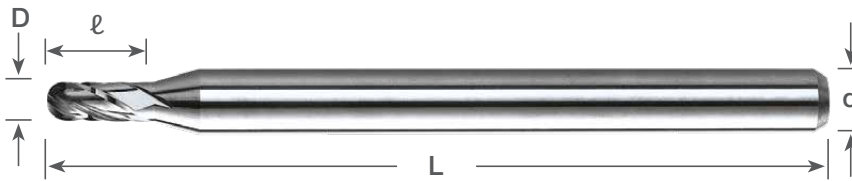

STUB Length (Inch Sizes)

	Dimensions (in)				Uncoated		AlTiN Coating		NEW DLC* Coating	
	D <sup>+0.000</sup> / <sub>-0.001</sub>	d	ℓ	L	Part Number	Stock	Part Number	Stock	Part Number	Stock
NEW	0.0100	1/8	0.015	1 1/2	1835-0100.015	●	1835-0100L015	●	1835-0100D015	■
NEW	0.0110	1/8	0.016	1 1/2	1835-0110.016	●	1835-0110L016	●	1835-0110D016	■
NEW	0.0120	1/8	0.018	1 1/2	1835-0120.018	●	1835-0120L018	●	1835-0120D018	■
NEW	0.0130	1/8	0.019	1 1/2	1835-0130.019	●	1835-0130L019	●	1835-0130D019	■
NEW	0.0140	1/8	0.021	1 1/2	1835-0140.021	●	1835-0140L021	●	1835-0140D021	■
	0.0156 (1/64)	1/8	0.023	1 1/2	1835-0156.023	●	1835-0156L023	●	1835-0156D023	■
NEW	0.0160	1/8	0.024	1 1/2	1835-0160.024	●	1835-0160L024	●	1835-0160D024	■
NEW	0.0170	1/8	0.026	1 1/2	1835-0170.026	●	1835-0170L026	●	1835-0170D026	■
NEW	0.0180	1/8	0.027	1 1/2	1835-0180.027	●	1835-0180L027	●	1835-0180D027	■
NEW	0.0190	1/8	0.029	1 1/2	1835-0190.029	●	1835-0190L029	●	1835-0190D029	■
NEW	0.0200	1/8	0.030	1 1/2	1835-0200.030	●	1835-0200L030	●	1835-0200D030	■
NEW	0.0210	1/8	0.031	1 1/2	1835-0210.031	●	1835-0210L031	●	1835-0210D031	■
NEW	0.0220	1/8	0.033	1 1/2	1835-0220.033	●	1835-0220L033	●	1835-0220D033	■
NEW	0.0230	1/8	0.035	1 1/2	1835-0230.035	●	1835-0230L035	●	1835-0230D035	■
NEW	0.0240	1/8	0.036	1 1/2	1835-0240.036	●	1835-0240L036	●	1835-0240D036	■
NEW	0.0250	1/8	0.037	1 1/2	1835-0250.037	●	1835-0250L037	●	1835-0250D037	■
NEW	0.0260	1/8	0.039	1 1/2	1835-0260.039	●	1835-0260L039	●	1835-0260D039	■
NEW	0.0270	1/8	0.041	1 1/2	1835-0270.041	●	1835-0270L041	●	1835-0270D041	■
NEW	0.0280	1/8	0.042	1 1/2	1835-0280.042	●	1835-0280L042	●	1835-0280D042	■
NEW	0.0290	1/8	0.043	1 1/2	1835-0290.043	●	1835-0290L043	●	1835-0290D043	■
NEW	0.0300	1/8	0.045	1 1/2	1835-0300.045	●	1835-0300L045	●	1835-0300D045	■
	0.0312 (1/32)	1/8	0.047	1 1/2	1835-0312.047	●	1835-0312L047	●	1835-0312D047	■
NEW	0.0320	1/8	0.048	1 1/2	1835-0320.048	●	1835-0320L048	●	1835-0320D048	■
NEW	0.0330	1/8	0.049	1 1/2	1835-0330.049	●	1835-0330L049	●	1835-0330D049	■
NEW	0.0340	1/8	0.051	1 1/2	1835-0340.051	●	1835-0340L051	●	1835-0340D051	■
NEW	0.0350	1/8	0.052	1 1/2	1835-0350.052	●	1835-0350L052	●	1835-0350D052	■
NEW	0.0360	1/8	0.054	1 1/2	1835-0360.054	●	1835-0360L054	●	1835-0360D054	■
NEW	0.0370	1/8	0.055	1 1/2	1835-0370.055	●	1835-0370L055	●	1835-0370D055	■
NEW	0.0380	1/8	0.057	1 1/2	1835-0380.057	●	1835-0380L057	●	1835-0380D057	■
NEW	0.0394	1/8	0.058	1 1/2	1835-0394.058	●	1835-0394L058	●	1835-0394D058	■

\*DLC is Amorphous Diamond

SERIES 1835 WORKPIECE MATERIAL															
Coating	P Steel ~30HRC	P Steel 30~40HRC	H Hardened Steel ~55HRC	H Hardened Steel ~68HRC	M Stainless Steel	K Cast Iron	N Aluminum	N Graphite	N Copper Alloy	N CFRP	N Plastic	N Thermoset Plastic	N High Density Plastic	S Nickel / Cobalt	S Titanium Alloy
AlTiN	★	★	★	☆	☆	☆								☆	☆
DLC							☆	★	☆	★	★	★			
Uncoated							☆	☆	☆	☆	☆	☆	☆		☆

★ : Priority ☆ : Applicable Materials

Symbol Descriptions Page vii

● : U.S. Stock Standard  
■ : NOT STOCKED - Call for Delivery  
▲ : Coming Soon

(U.S.) 1.888.848.8449  
(International) 001.714.428.3636  
Pricing & Availability at [KyoceraPrecisionTools.com](http://KyoceraPrecisionTools.com)

DRILLS A  
END MILLS B  
ROUTERS C  
THREAD MILLS & TAPS D  
ENGRAVERS E  
BORING BARS F  
REAMERS G  
SAWS H  
TECHNICAL I  
INDEX J

## 4 FLUTE

**0.0400" - 0.2500" DIAMETER**

Mirror Surface Finishes

Sub Micron Grain Carbide

### STUB LENGTH BALL NOSE END MILLS



### STUB Length (Inch Sizes)

	Dimensions (in)				Uncoated		AlTiN Coating		NEW DLC* Coating	
	D <sup>+0.000</sup> / <sub>-0.001</sub>	d	ℓ	L	Part Number	Stock	Part Number	Stock	Part Number	Stock
<b>NEW</b>	0.0400	1/8	0.060	1 1/2	1835-0400.060	●	1835-0400L060	●	1835-0400D060	■
<b>NEW</b>	0.0450	1/8	0.067	1 1/2	1835-0450.067	●	1835-0450L067	●	1835-0450D067	■
	0.0469 (3/64)	1/8	0.070	1 1/2	1835-0469.070	●	1835-0469L070	●	1835-0469D070	■
<b>NEW</b>	0.0500	1/8	0.075	1 1/2	1835-0500.075	●	1835-0500L075	●	1835-0500D075	■
<b>NEW</b>	0.0550	1/8	0.082	1 1/2	1835-0550.082	●	1835-0550L082	●	1835-0550D082	■
<b>NEW</b>	0.0600	1/8	0.090	1 1/2	1835-0600.090	●	1835-0600L090	●	1835-0600D090	■
	0.0625 (1/16)	1/8	0.094	1 1/2	1835-0625.094	●	1835-0625L094	●	1835-0625D094	■
<b>NEW</b>	0.0650	1/8	0.097	1 1/2	1835-0650.097	●	1835-0650L097	●	1835-0650D097	■
<b>NEW</b>	0.0700	1/8	0.105	1 1/2	1835-0700.105	●	1835-0700L105	●	1835-0700D105	■
<b>NEW</b>	0.0750	1/8	0.112	1 1/2	1835-0750.112	●	1835-0750L112	●	1835-0750D112	■
	0.0781 (5/64)	1/8	0.117	1 1/2	1835-0781.117	●	1835-0781L117	●	1835-0781D117	■
<b>NEW</b>	0.0800	1/8	0.120	1 1/2	1835-0800.120	●	1835-0800L120	●	1835-0800D120	■
<b>NEW</b>	0.0850	1/8	0.127	1 1/2	1835-0850.127	●	1835-0850L127	●	1835-0850D127	■
<b>NEW</b>	0.0900	1/8	0.135	1 1/2	1835-0900.135	●	1835-0900L135	●	1835-0900D135	■
	0.0938 (3/32)	1/8	0.141	1 1/2	1835-0938.141	●	1835-0938L141	●	1835-0938D141	■
<b>NEW</b>	0.0950	1/8	0.142	1 1/2	1835-0950.142	●	1835-0950L142	●	1835-0950D142	■
<b>NEW</b>	0.1000	1/8	0.150	1 1/2	1835-1000.150	●	1835-1000L150	●	1835-1000D150	■
	0.1094 (7/64)	1/8	0.164	1 1/2	1835-1094.164	●	1835-1094L164	●	1835-1094D164	■
<b>NEW</b>	0.1181	1/8	0.178	1 1/2	1835-1181.178	●	1835-1181L178	●	1835-1181D178	■
	0.1250 (1/8)	1/8	0.188	1 1/2	1835-1250.188	●	1835-1250L188	●	1835-1250D188	■
	0.1406 (9/64)	3/16	0.211	2	1835-1406.211	●	1835-1406L211	●	1835-1406D211	■
	0.1563 (5/32)	3/16	0.234	2	1835-1563.234	●	1835-1563L234	●	1835-1563D234	■
	0.1719 (11/64)	3/16	0.258	2	1835-1719.258	●	1835-1719L258	●	1835-1719D258	■
	0.1875 (3/16)	3/16	0.281	2	1835-1875.281	●	1835-1875L281	●	1835-1875D281	■
<b>NEW</b>	0.1875 (3/16)	3/16	0.312	2	1835-1875.312	●	1835-1875L312	●	1835-1875D312	■
	0.2031 (13/64)	1/4	0.305	2 1/2	1835-2031.305	●	1835-2031L305	●	1835-2031D305	■
	0.2188 (7/32)	1/4	0.328	2 1/2	1835-2188.328	●	1835-2188L328	●	1835-2188D328	■
	0.2344 (15/64)	1/4	0.352	2 1/2	1835-2344.352	●	1835-2344L352	●	1835-2344D352	■
	0.2500 (1/4)	1/4	0.375	2 1/2	1835-2500.375	●	1835-2500L375	●	1835-2500D375	■

\*DLC is Amorphous Diamond

### SERIES 1835 WORKPIECE MATERIAL

Coating	P Steel -30HRC	P Steel 30-40HRC	H Hardened Steel -55HRC	H Hardened Steel -68HRC	M Stainless Steel	K Cast Iron	N Aluminum	N Graphite	N Copper Alloy	N CFRP	N Plastic	N Thermoset Plastic	N High Density Plastic	S Nickel / Cobalt	S Titanium Alloy
AlTiN	★	★	★	☆	☆	☆								☆	☆
DLC							☆	★	☆	★	★	★			
Uncoated							☆	☆	☆	☆	☆	☆	☆		☆

★ : Priority ☆ : Applicable Materials

Symbol Descriptions [Page vii](#)



## 4 FLUTE

STUB LENGTH BALL NOSE END MILLS

**0.40mm - 6.00mm DIAMETER**

Mirror Surface Finishes

Sub Micron Grain Carbide

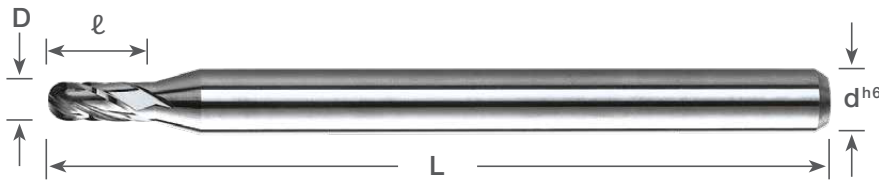

### STUB Length (Metric Sizes)

Dimensions (mm)				Uncoated		AlTiN Coating	
D <sup>+0.00mm</sup> <sub>-0.02mm</sub>	d <sup>h6</sup>	ℓ	L	Part Number	Stock	Part Number	Stock
0.40	3	0.60	38	1835-0157.024	●	1835-0157L024	●
0.45	3	0.68	38	1835-0177.027	●	1835-0177L027	●
0.50	3	0.75	38	1835-0197.030	●	1835-0197L030	●
0.60	3	0.90	38	1835-0236.035	●	1835-0236L035	●
0.70	3	1.05	38	1835-0276.041	●	1835-0276L041	●
0.80	3	1.20	38	1835-0315.047	●	1835-0315L047	●
0.90	3	1.35	38	1835-0354.053	●	1835-0354L053	●
1.00	3	1.50	38	1835-0394.059	●	1835-0394L059	●
1.50	3	2.25	38	1835-0591.089	●	1835-0591L089	●
2.00	3	3.00	38	1835-0787.118	●	1835-0787L118	●
2.50	3	3.75	38	1835-0984.148	●	1835-0984L148	●
3.00	3	4.50	38	1835-1181.177	●	1835-1181L177	●
3.50	4	5.25	50	1835-1378.207	●	1835-1378L207	●
4.00	5	6.00	50	1835-1575.236	●	1835-1575L236	●
4.50	5	6.75	50	1835-1772.266	●	1835-1772L266	●
5.00	5	7.50	50	1835-1968.295	●	1835-1968L295	●
5.50	6	8.25	50	1835-2165.325	●	1835-2165L325	●
6.00	6	9.00	50	1835-2362.354	●	1835-2362L354	●

SERIES 1835 WORKPIECE MATERIAL															
Coating	P	P	H	H	M	K	N	N	N	N	N	N	S	S	
	Steel ~30HRC	Steel 30~40HRC	Hardened Steel ~55HRC	Hardened Steel ~68HRC	Stainless Steel	Cast Iron	Aluminum	Graphite	Copper Alloy	CFRP	Plastic	Thermoset Plastic	High Density Plastic	Nickel / Cobalt	Titanium Alloy
AlTiN	★	★	★	☆	☆	☆								☆	☆
DLC							☆								
Uncoated							☆	☆	☆	☆	☆	☆	☆		☆

★ : Priority ☆ : Applicable Materials

Symbol Descriptions [Page vii](#)

● : U.S. Stock Standard  
 ■ : NOT STOCKED - Call for Delivery  
 ▲ : Coming Soon

(U.S.) 1.888.848.8449  
 (International) 001.714.428.3636  
 Pricing & Availability at [KyoceraPrecisionTools.com](http://KyoceraPrecisionTools.com)

DRILLS **A**  
 END MILLS **B**  
 ROUTERS **C**  
 THREAD MILLS & TAPS **D**  
 ENGRAVERS **E**  
 BORING BARS **F**  
 REAMERS **G**  
 SAWS **H**  
 TECHNICAL **I**  
 INDEX **J**

## 4 FLUTE

0.0100" - 0.0600" DIAMETER

Mirror Surface Finishes

Sub Micron Grain Carbide

### EXTENDED REACH BALL NOSE END MILLS

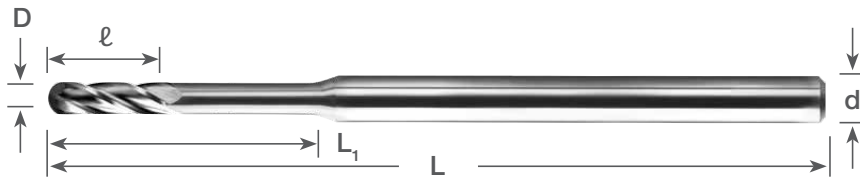

### EXTENDED Reach (Inch Sizes)

	Dimensions (in)					Uncoated		AlTiN Coating		NEW DLC* Coating	
	D <sup>+0.000</sup> / <sub>-0.001</sub>	d	ℓ	L	L <sub>1</sub>	Part Number	Stock	Part Number	Stock	Part Number	Stock
D	NEW 0.0100	1/8	0.030	1 1/2	0.080	1845-0100.080	●	1845-0100L080	●	1845-0100D080	■
	0.0100	1/8	0.030	1 1/2	0.100	1845-0100.100	●	1845-0100L100	●	1845-0100D100	■
	0.0150	1/8	0.045	1 1/2	0.128	1845-0150.128	●	1845-0150L128	●	1845-0150D128	■
	0.0150	1/8	0.045	1 1/2	0.150	1845-0150.150	●	1845-0150L150	●	1845-0150D150	■
	0.0156 (1/64)	1/8	0.047	1 1/2	0.120	1845-0156.120	●	1845-0156L120	●	1845-0156D120	■
	0.0200	1/8	0.060	1 1/2	0.170	1845-0200.170	●	1845-0200L170	●	1845-0200D170	■
	0.0200	1/8	0.060	1 1/2	0.200	1845-0200.200	●	1845-0200L200	●	1845-0200D200	■
	0.0250	1/8	0.075	1 1/2	0.213	1845-0250.213	●	1845-0250L213	●	1845-0250D213	■
	0.0250	1/8	0.075	1 1/2	0.250	1845-0250.250	●	1845-0250L250	●	1845-0250D250	■
	0.0300	1/8	0.090	1 1/2	0.270	1845-0300.270	●	1845-0300L270	●	1845-0300D270	■
F	0.0300	1/8	0.090	1 1/2	0.300	1845-0300.300	●	1845-0300L300	●	1845-0300D300	■
	0.0312 (1/32)	1/8	0.094	1 1/2	0.315	1845-0312.315	●	1845-0312L315	●	1845-0312D315	■
	0.0350	1/8	0.105	1 1/2	0.315	1845-0350.315	●	1845-0350L315	●	1845-0350D315	■
	0.0350	1/8	0.105	1 1/2	0.350	1845-0350.350	●	1845-0350L350	●	1845-0350D350	■
	0.0400	1/8	0.120	1 1/2	0.360	1845-0400.360	●	1845-0400L360	●	1845-0400D360	■
	0.0400	1/8	0.120	1 1/2	0.400	1845-0400.400	●	1845-0400L400	●	1845-0400D400	■
	0.0450	1/8	0.135	1 1/2	0.405	1845-0450.405	●	1845-0450L405	●	1845-0450D405	■
	0.0450	1/8	0.135	1 1/2	0.450	1845-0450.450	●	1845-0450L450	●	1845-0450D450	■
	0.0469 (3/64)	1/8	0.141	1 1/2	0.390	1845-0469.390	●	1845-0469L390	●	1845-0469D390	■
	NEW 0.0469 (3/64)	1/8	0.141	1 1/2	0.423	1845-0469.423	●	1845-0469L423	●	1845-0469D423	■
H	0.0500	1/8	0.150	1 1/2	0.500	1845-0500.500	●	1845-0500L500	●	1845-0500D500	■
	0.0550	1/8	0.165	1 1/2	0.500	1845-0550.500	●	1845-0550L500	●	1845-0550D500	■
	0.0600	1/8	0.180	1 1/2	0.500	1845-0600.500	●	1845-0600L500	●	1845-0600D500	■
	0.0600	1/8	0.180	2	0.600	1845-0600.600	●	1845-0600L600	●	1845-0600D600	■

\*DLC is Amorphous Diamond

### SERIES 1845 WORKPIECE MATERIAL

Coating	P	P	H	H	M	K	N	N	N	N	N	N	S	S	
	Steel ~30HRC	Steel 30-40HRC	Hardened Steel ~55HRC	Hardened Steel ~68HRC	Stainless Steel	Cast Iron	Aluminum	Graphite	Copper Alloy	CFRP	Plastic	Thermoset Plastic	High Density Plastic	Nickel / Cobalt	Titanium Alloy
AlTiN	★	★	★	☆	☆	☆								☆	☆
DLC							☆	★	☆	★	★	★			
Uncoated							☆	☆	☆	☆	☆	☆	☆		☆

★ : Priority ☆ : Applicable Materials

Symbol Descriptions Page vii

## 4 FLUTE

**0.0625" - 0.1250" DIAMETER**

Mirror Surface Finishes

Sub Micron Grain Carbide

EXTENDED REACH BALL NOSE END MILLS

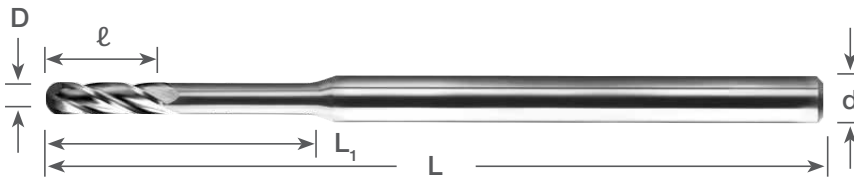

### EXTENDED Reach (Inch Sizes)

Dimensions (in)					Uncoated		AlTiN Coating		NEW DLC* Coating	
D <sup>+0.000</sup> <sub>-0.001</sub>	d	ℓ	L	L <sub>1</sub>	Part Number	Stock	Part Number	Stock	Part Number	Stock
NEW 0.0625 (1/16)	1/8	0.186	1 1/2	0.590	1845-0625.590A	●	1845-0625L590A	●	1845-0625D590A	■
0.0625 (1/16)	1/8	0.188	2	0.590	1845-0625.590	●	1845-0625L590	●	1845-0625D590	■
0.0650	1/8	0.195	1 1/2	0.500	1845-0650.500	●	1845-0650L500	●	1845-0650D500	■
0.0650	1/8	0.195	2	0.600	1845-0650.600	●	1845-0650L600	●	1845-0650D600	■
0.0700	1/8	0.210	1 1/2	0.500	1845-0700.500	●	1845-0700L500	●	1845-0700D500	■
0.0700	1/8	0.210	2	0.700	1845-0700.700	●	1845-0700L700	●	1845-0700D700	■
0.0750	1/8	0.225	1 1/2	0.500	1845-0750.500	●	1845-0750L500	●	1845-0750D500	■
0.0750	1/8	0.225	2	0.700	1845-0750.700	●	1845-0750L700	●	1845-0750D700	■
NEW 0.0781 (5/64)	1/8	0.234	1 1/2	0.590	1845-0781.590A	●	1845-0781L590A	●	1845-0781D590A	■
0.0781 (5/64)	1/8	0.234	2	0.590	1845-0781.590	●	1845-0781L590	●	1845-0781D590	■
0.0800	1/8	0.240	1 1/2	0.500	1845-0800.500	●	1845-0800L500	●	1845-0800D500	■
0.0800	1/8	0.240	2	0.750	1845-0800.750	●	1845-0800L750	●	1845-0800D750	■
0.0850	1/8	0.255	1 1/2	0.500	1845-0850.500	●	1845-0850L500	●	1845-0850D500	■
0.0850	1/8	0.255	2	0.750	1845-0850.750	●	1845-0850L750	●	1845-0850D750	■
0.0900	1/8	0.270	1 1/2	0.625	1845-0900.625	●	1845-0900L625	●	1845-0900D625	■
0.0900	1/8	0.270	2	0.750	1845-0900.750	●	1845-0900L750	●	1845-0900D750	■
NEW 0.0938 (3/32)	1/8	0.279	1 1/2	0.625	1845-0938.625	●	1845-0938L625	●	1845-0938D625	■
0.0938 (3/32)	1/8	0.281	2	0.590	1845-0938.590	●	1845-0938L590	●	1845-0938D590	■
0.0950	1/8	0.285	1 1/2	0.625	1845-0950.625	●	1845-0950L625	●	1845-0950D625	■
0.0950	1/8	0.285	2	0.750	1845-0950.750	●	1845-0950L750	●	1845-0950D750	■
0.1000	1/8	0.300	1 1/2	0.625	1845-1000.625	●	1845-1000L625	●	1845-1000D625	■
0.1000	1/8	0.300	2	0.750	1845-1000.750	●	1845-1000L750	●	1845-1000D750	■
0.1094 (7/64)	1/8	0.328	2	0.590	1845-1094.590	●	1845-1094L590	●	1845-1094D590	■
0.1100	1/8	0.330	2	0.750	1845-1100.750	●	1845-1100L750	●	1845-1100D750	■
0.1250 (1/8)	1/8	0.375	2	0.590	1845-1250.590	●	1845-1250L590	●	1845-1250D590	■

\*DLC is Amorphous Diamond

SERIES 1845 WORKPIECE MATERIAL															
Coating	P	P	H	H	M	K	N	N	N	N	N	N	S	S	
	Steel ~30HRC	Steel 30-40HRC	Hardened Steel ~55HRC	Hardened Steel ~68HRC	Stainless Steel	Cast Iron	Aluminum	Graphite	Copper Alloy	CFRP	Plastic	Thermoset Plastic	High Density Plastic	Nickel / Cobalt	Titanium Alloy
AlTiN	★	★	★	☆	☆	☆								☆	☆
DLC							☆	★	☆	★	★	★			
Uncoated							☆	☆	☆	☆	☆	☆	☆		☆

★ : Priority ☆ : Applicable Materials

Symbol Descriptions Page vii

- : U.S. Stock Standard
- : NOT STOCKED - Call for Delivery
- ▲ : Coming Soon

(U.S.) 1.888.848.8449  
 (International) 001.714.428.3636  
 Pricing & Availability at [KyoceraPrecisionTools.com](http://KyoceraPrecisionTools.com)

DRILLS A  
 END MILLS B  
 ROUTERS C  
 THREAD MILLS & TAPS D  
 ENGRAVERS E  
 BORING BARS F  
 REAMERS G  
 SAWS H  
 TECHNICAL I  
 INDEX J

## 4 FLUTE

**0.40mm - 6.00mm DIAMETER**

Mirror Surface Finishes

Sub Micron Grain Carbide

### EXTENDED REACH BALL NOSE END MILLS

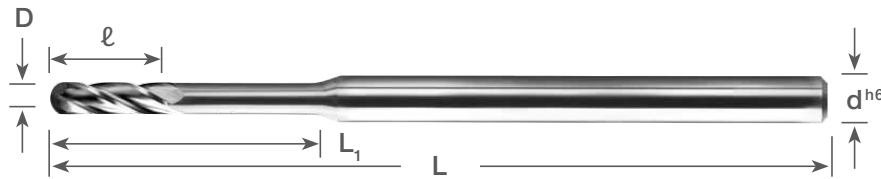

### EXTENDED Reach (Metric Sizes)

Dimensions (mm)					Uncoated		AlTiN Coating	
D	d <sup>h6</sup>	ℓ	L	L <sub>1</sub>	Part Number	Stock	Part Number	Stock
0.40	3	1.20	38	3	1845-0157.118	●	1845-0157L118	●
0.50	3	1.50	38	4	1845-0197.157	●	1845-0197L157	●
0.60	3	1.80	38	5	1845-0236.197	●	1845-0236L197	●
0.65	3	1.95	38	6	1845-0256.236	●	1845-0256L236	●
0.70	3	2.10	38	7	1845-0276.276	●	1845-0276L276	●
0.75	3	2.25	38	8	1845-0295.315	●	1845-0295L315	●
0.80	3	2.40	50	9	1845-0315.354	●	1845-0315L354	●
0.90	3	2.70	50	10	1845-0354.394	●	1845-0354L394	●
1.00	3	3.00	50	10	1845-0394.394	●	1845-0394L394	●
1.50	3	4.50	50	15	1845-0591.591	●	1845-0591L591	●
2.00	3	6.00	50	20	1845-0787.787	●	1845-0787L787	●
2.50	3	7.50	50	23	1845-0984.906	●	1845-0984L906	●
3.00	3	9.00	50	23	1845-1181.906	●	1845-1181L906	●
3.50	6	10.50	75	25	1845-1378.984	●	1845-1378L984	●
4.00	6	12.00	75	25	1845-1575.984	●	1845-1575L984	●
4.50	6	13.50	75	30	1845-1772.1181	●	1845-1772L1181	●
5.00	6	15.00	75	30	1845-1968.1181	●	1845-1968L1181	●
5.50	6	16.50	75	30	1845-2165.1181	●	1845-2165L1181	●
6.00	6	18.00	75	30	1845-2362.1181	●	1845-2362L1181	●

### SERIES 1845 WORKPIECE MATERIAL

Coating	P	P	H	H	M	K	N	N	N	N	N	N	S	S	
	Steel ~30HRC	Steel 30-40HRC	Hardened Steel ~55HRC	Hardened Steel ~68HRC	Stainless Steel	Cast Iron	Aluminum	Graphite	Copper Alloy	CFRP	Plastic	Thermoset Plastic	High Density Plastic	Nickel / Cobalt	Titanium Alloy
AlTiN	★	★	★	☆	☆	☆	☆	☆	☆	☆	☆	☆	☆	☆	☆
Uncoated							☆	☆	☆	☆	☆	☆	☆		☆

★ : Priority ☆ : Applicable Materials

Symbol Descriptions [Page vii](#)

## 2 FLUTE NEW

STANDARD LENGTH  
X-SMALL CORNER RADIUS END MILLS

0.0500" - 0.1000" DIAMETER

Mirror Surface Finishes  
Sub Micron Grain Carbide

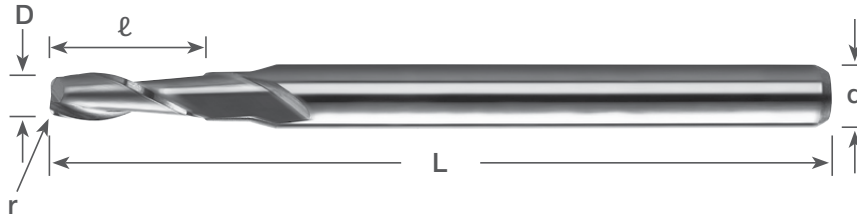

### X-SMALL Corner Radius STANDARD Length (Inch Sizes)

Dimensions (in)					Uncoated		AlTiN Coating		<span style="color:red">NEW</span> DLC* Coating	
D <sup>+0.000</sup> / <sub>-0.001</sub>	d	ℓ	L	r	Part Number	Stock	Part Number	Stock	Part Number	Stock
0.0500	1/8	0.150	1 1/2	0.005	1611-0500.150CR	●	1611-0500L150CR	●	1611-0500D150CR	■
0.0600	1/8	0.180	1 1/2	0.005	1611-0600.180CR	●	1611-0600L180CR	●	1611-0600D180CR	■
0.0700	1/8	0.210	1 1/2	0.005	1611-0700.210CR	●	1611-0700L210CR	●	1611-0700D210CR	■
0.0800	1/8	0.240	1 1/2	0.005	1611-0800.240CR	●	1611-0800L240CR	●	1611-0800D240CR	■
0.0900	1/8	0.270	1 1/2	0.005	1611-0900.270CR	●	1611-0900L270CR	●	1611-0900D270CR	■
0.1000	1/8	0.300	1 1/2	0.005	1611-1000.300CR	●	1611-1000L300CR	●	1611-1000D300CR	■

#### Corner Radius Tolerance

Diameter (D)	0.0500" - 0.1000"
+ / -	0.0015"

\*DLC is Amorphous Diamond

SERIES 1611 WORKPIECE MATERIAL															
Coating	P	P	H	H	M	K	N	N	N	N	N	N	S	S	
	Steel ~30HRC	Steel 30~40HRC	Hardened Steel ~55HRC	Hardened Steel ~68HRC	Stainless Steel	Cast Iron	Aluminum	Graphite	Copper Alloy	CFRP	Plastic	Thermoset Plastic	High Density Plastic	Nickel / Cobalt	Titanium Alloy
AlTiN	★	★	★	☆	☆	☆								☆	☆
DLC							☆	★	☆	★	★	★			
Uncoated							☆	☆	★	☆	★	★	☆		☆

★ : Priority ☆ : Applicable Materials

Symbol Descriptions [Page vii](#)

● : U.S. Stock Standard  
■ : NOT STOCKED - Call for Delivery  
▲ : Coming Soon

DRILLS A  
 END MILLS B  
 ROUTERS C  
 THREAD MILLS & TAPS D  
 ENGRAVERS E  
 BORING BARS F  
 REAMERS G  
 SAWS H  
 TECHNICAL I  
 INDEX J

## 2 FLUTE

0.0150" - 0.2500" DIAMETER

Mirror Surface Finishes

Sub Micron Grain Carbide

STANDARD LENGTH  
SMALL CORNER RADIUS END MILLS

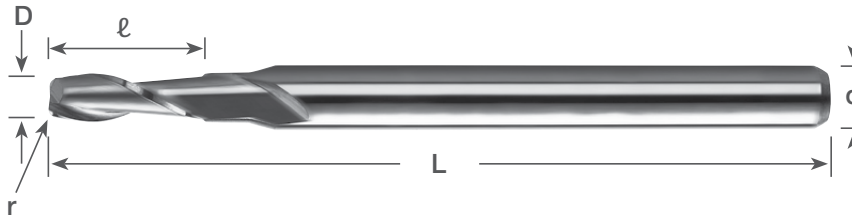

### SMALL Corner Radius STANDARD Length (Inch Sizes)

D	Dimensions (in)					Uncoated		AlTiN Coating		NEW DLC* Coating	
	D <sup>+0.000</sup> <sub>-0.001</sub>	d	ℓ	L	r	Part Number	Stock	Part Number	Stock	Part Number	Stock
NEW 0.0150	1/8	0.045	1 1/2	0.003	1612-0150.045CR	●	1612-0150L045CR	●	1612-0150D045CR	■	
0.0156 (1/64)	1/8	0.045	1 1/2	0.003	1612-0156.045CR	●	1612-0156L045CR	●	1612-0156D045CR	■	
0.0200	1/8	0.060	1 1/2	0.005	1612-0200.060CR	●	1612-0200L060CR	●	1612-0200D060CR	■	
0.0250	1/8	0.075	1 1/2	0.005	1612-0250.075CR	●	1612-0250L075CR	●	1612-0250D075CR	■	
0.0300	1/8	0.090	1 1/2	0.005	1612-0300.090CR	●	1612-0300L090CR	●	1612-0300D090CR	■	
NEW 0.0312 (1/32)	1/8	0.093	1 1/2	0.005	1612-0312.093CR	●	1612-0312L093CR	●	1612-0312D093CR	■	
0.0350	1/8	0.105	1 1/2	0.005	1612-0350.105CR	●	1612-0350L105CR	●	1612-0350D105CR	■	
0.0400	1/8	0.120	1 1/2	0.005	1612-0400.120CR	●	1612-0400L120CR	●	1612-0400D120CR	■	
0.0450	1/8	0.135	1 1/2	0.005	1612-0450.135CR	●	1612-0450L135CR	●	1612-0450D135CR	■	
NEW 0.0469 (3/64)	1/8	0.141	1 1/2	0.005	1612-0469.141CR	●	1612-0469L141CR	●	1612-0469D141CR	■	
0.0500	1/8	0.150	1 1/2	0.010	1612-0500.150CR	●	1612-0500L150CR	●	1612-0500D150CR	■	
NEW 0.0550	1/8	0.165	1 1/2	0.005	1612-0550.165CR	●	1612-0550L165CR	●	1612-0550D165CR	■	
0.0600	1/8	0.180	1 1/2	0.010	1612-0600.180CR	●	1612-0600L180CR	●	1612-0600D180CR	■	
NEW 0.0625 (1/16)	1/8	0.186	1 1/2	0.005	1612-0625.186CR	●	1612-0625L186CR	●	1612-0625D186CR	■	
NEW 0.0650	1/8	0.195	1 1/2	0.005	1612-0650.195CR	●	1612-0650L195CR	●	1612-0650D195CR	■	
0.0700	1/8	0.210	1 1/2	0.010	1612-0700.210CR	●	1612-0700L210CR	●	1612-0700D210CR	■	
NEW 0.0750	1/8	0.225	1 1/2	0.005	1612-0750.225CR	●	1612-0750L225CR	●	1612-0750D225CR	■	
NEW 0.0781 (5/64)	1/8	0.234	1 1/2	0.005	1612-0781.234CR	●	1612-0781L234CR	●	1612-0781D234CR	■	
0.0800	1/8	0.240	1 1/2	0.010	1612-0800.240CR	●	1612-0800L240CR	●	1612-0800D240CR	■	
NEW 0.0850	1/8	0.255	1 1/2	0.005	1612-0850.255CR	●	1612-0850L255CR	●	1612-0850D255CR	■	
0.0900	1/8	0.270	1 1/2	0.010	1612-0900.270CR	●	1612-0900L270CR	●	1612-0900D270CR	■	
NEW 0.0938 (3/32)	1/8	0.279	1 1/2	0.005	1612-0938.279CR	●	1612-0938L279CR	●	1612-0938D279CR	■	
NEW 0.0950	1/8	0.285	1 1/2	0.005	1612-0950.285CR	●	1612-0950L285CR	●	1612-0950D285CR	■	
0.1000	1/8	0.30	1 1/2	0.010	1612-1000.300CR	●	1612-1000L300CR	●	1612-1000D300CR	■	
NEW 0.1250 (1/8)	1/8	0.500	1 1/2	0.005	1612-1250.500CR	●	1612-1250L500CR	●	1612-1250D500CR	■	
NEW 0.1562 (5/32)	3/16	0.562	2	0.010	1612-1562.562CR	●	1612-1562L562CR	●	1612-1562D562CR	■	
NEW 0.1875 (3/16)	3/16	0.625	2	0.010	1612-1875.625CR	●	1612-1875L625CR	●	1612-1875D625CR	■	
NEW 0.2500 (1/4)	1/4	0.750	2 1/2	0.010	1612-2500.750CR	●	1612-2500L750CR	●	1612-2500D750CR	■	

#### Corner Radius Tolerance

\*DLC is Amorphous Diamond

Diameter (D)	0.0150" - 0.0350"	0.0400" - 0.1000"	0.1250" - 0.1875"	0.2500"
+ / -	0.0010"	0.0015"	0.0020"	0.0030"

#### SERIES 1612 WORKPIECE MATERIAL

Coating	P Steel ~30HRC	P Steel 30~40HRC	H Hardened Steel ~55HRC	H Hardened Steel ~68HRC	M Stainless Steel	K Cast Iron	N Aluminum	N Graphite	N Copper Alloy	N CFRP	N Plastic	N Thermoset Plastic	N High Density Plastic	S Nickel / Cobalt	S Titanium Alloy
AlTiN	★	★	★	☆	☆	☆								☆	☆
DLC							☆	★	☆	★	★	★			
Uncoated							☆	☆	★	☆	★	★	☆		☆

★ : Priority ☆ : Applicable Materials

Symbol Descriptions [Page vii](#)

## 2 FLUTE

STANDARD LENGTH  
STANDARD CORNER RADIUS END MILLS

0.0156" - 0.2500" DIAMETER

Mirror Surface Finishes  
Sub Micron Grain Carbide

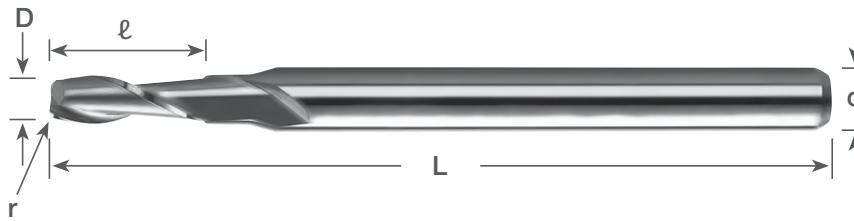

### STANDARD Corner Radius STANDARD Length (Inch Sizes)

	Dimensions (in)					Uncoated		AlTiN Coating		NEW DLC* Coating	
	D <sup>+0.000</sup> / <sub>-0.001</sub>	d	ℓ	L	r	Part Number	Stock	Part Number	Stock	Part Number	Stock
NEW	0.0156 (1/64)	1/8	0.045	1 1/2	0.005	1613-0156.045CR	●	1613-0156L045CR	●	1613-0156D045CR	■
NEW	0.0300	1/8	0.090	1 1/2	0.010	1613-0300.090CR	●	1613-0300L090CR	●	1613-0300D090CR	■
NEW	0.0312 (1/32)	1/8	0.093	1 1/2	0.010	1613-0312.093CR	●	1613-0312L093CR	●	1613-0312D093CR	■
NEW	0.0350	1/8	0.105	1 1/2	0.010	1613-0350.105CR	●	1613-0350L105CR	●	1613-0350D105CR	■
	0.0400	1/8	0.120	1 1/2	0.010	1613-0400.120CR	●	1613-0400L120CR	●	1613-0400D120CR	■
	0.0450	1/8	0.135	1 1/2	0.010	1613-0450.135CR	●	1613-0450L135CR	●	1613-0450D135CR	■
NEW	0.0469 (3/64)	1/8	0.141	1 1/2	0.010	1613-0469.141CR	●	1613-0469L141CR	●	1613-0469D141CR	■
	0.0500	1/8	0.150	1 1/2	0.015	1613-0500.150CR	●	1613-0500L150CR	●	1613-0500D150CR	■
NEW	0.0550	1/8	0.165	1 1/2	0.010	1613-0550.165CR	●	1613-0550L165CR	●	1613-0550D165CR	■
	0.0600	1/8	0.180	1 1/2	0.015	1613-0600.180CR	●	1613-0600L180CR	●	1613-0600D180CR	■
NEW	0.0625 (1/16)	1/8	0.186	1 1/2	0.010	1613-0625.186CR	●	1613-0625L186CR	●	1613-0625D186CR	■
NEW	0.0650	1/8	0.195	1 1/2	0.010	1613-0650.195CR	●	1613-0650L195CR	●	1613-0650D195CR	■
	0.0700	1/8	0.210	1 1/2	0.015	1613-0700.210CR	●	1613-0700L210CR	●	1613-0700D210CR	■
NEW	0.0750	1/8	0.225	1 1/2	0.010	1613-0750.225CR	●	1613-0750L225CR	●	1613-0750D225CR	■
NEW	0.0781 (5/64)	1/8	0.234	1 1/2	0.010	1613-0781.234CR	●	1613-0781L234CR	●	1613-0781D234CR	■
	0.0800	1/8	0.240	1 1/2	0.015	1613-0800.240CR	●	1613-0800L240CR	●	1613-0800D240CR	■
NEW	0.0850	1/8	0.255	1 1/2	0.010	1613-0850.255CR	●	1613-0850L255CR	●	1613-0850D255CR	■
	0.0900	1/8	0.270	1 1/2	0.015	1613-0900.270CR	●	1613-0900L270CR	●	1613-0900D270CR	■
NEW	0.0938 (3/32)	1/8	0.279	1 1/2	0.010	1613-0938.279CR	●	1613-0938L279CR	●	1613-0938D279CR	■
NEW	0.0950	1/8	0.285	1 1/2	0.010	1613-0950.285CR	●	1613-0950L285CR	●	1613-0950D285CR	■
	0.1000	1/8	0.300	1 1/2	0.015	1613-1000.300CR	●	1613-1000L300CR	●	1613-1000D300CR	■
NEW	0.1250 (1/8)	1/8	0.500	1 1/2	0.010	1613-1250.500CR	●	1613-1250L500CR	●	1613-1250D500CR	■
NEW	0.1562 (5/32)	3/16	0.562	2	0.015	1613-1562.562CR	●	1613-1562L562CR	●	1613-1562D562CR	■
NEW	0.1875 (3/16)	3/16	0.625	2	0.015	1613-1875.625CR	●	1613-1875L625CR	●	1613-1875D625CR	■
NEW	0.2500 (1/4)	1/4	0.750	2 1/2	0.015	1613-2500.750CR	●	1613-2500L750CR	●	1613-2500D750CR	■

#### Corner Radius Tolerance

\*DLC is Amorphous Diamond

Diameter (D)	0.0156" - 0.0350"	0.0400" - 0.1000"	0.1250" - 0.1875"	0.2500"
+ / -	0.0010"	0.0015"	0.0020"	0.0030"

SERIES 1613 WORKPIECE MATERIAL															
Coating	P	P	H	H	M	K	N	N	N	N	N	N	S	S	
	Steel ~30HRC	Steel 30~40HRC	Hardened Steel ~55HRC	Hardened Steel ~68HRC	Stainless Steel	Cast Iron	Aluminum	Graphite	Copper Alloy	CFRP	Plastic	Thermoset Plastic	High Density Plastic	Nickel / Cobalt	Titanium Alloy
AlTiN	★	★	★	☆	☆	☆								☆	☆
DLC							☆	★	☆	★	★	★			
Uncoated							☆	☆	★	☆	★	★	☆		☆

★ : Priority ☆ : Applicable Materials

Symbol Descriptions Page vii

● : U.S. Stock Standard  
■ : NOT STOCKED - Call for Delivery  
▲ : Coming Soon

(U.S.) 1.888.848.8449  
(International) 001.714.428.3636  
Pricing & Availability at [KyoceraPrecisionTools.com](http://KyoceraPrecisionTools.com)



## 2 FLUTE NEW

0.0450" - 0.5000" DIAMETER

Mirror Surface Finishes

Sub Micron Grain Carbide

STANDARD LENGTH  
LARGE / X-LARGE CORNER RADIUS END MILLS

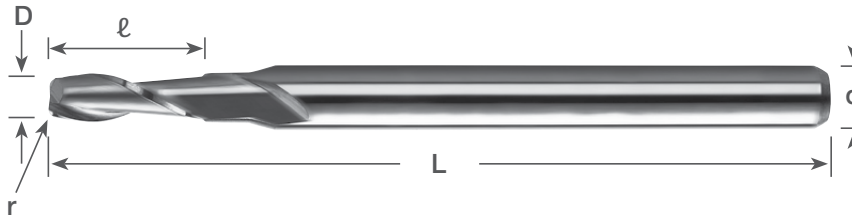

### LARGE Corner Radius STANDARD Length (Inch Sizes)

Dimensions (in)					Uncoated		AlTiN Coating		<span style="color:red">NEW</span> DLC* Coating	
D <sup>+0.000</sup> / <sub>-0.001</sub>	d	ℓ	L	r	Part Number	Stock	Part Number	Stock	Part Number	Stock
0.0450	1/8	0.135	1 1/2	0.015	1614-0450.135CR	●	1614-0450L135CR	●	1614-0450D135CR	■
0.0469 (3/64)	1/8	0.141	1 1/2	0.015	1614-0469.141CR	●	1614-0469L141CR	●	1614-0469D141CR	■
0.0550	1/8	0.165	1 1/2	0.015	1614-0550.165CR	●	1614-0550L165CR	●	1614-0550D165CR	■
0.0625 (1/16)	1/8	0.186	1 1/2	0.015	1614-0625.186CR	●	1614-0625L186CR	●	1614-0625D186CR	■
0.0650	1/8	0.195	1 1/2	0.015	1614-0650.195CR	●	1614-0650L195CR	●	1614-0650D195CR	■
0.0750	1/8	0.225	1 1/2	0.015	1614-0750.225CR	●	1614-0750L225CR	●	1614-0750D225CR	■
0.0781 (5/64)	1/8	0.234	1 1/2	0.015	1614-0781.234CR	●	1614-0781L234CR	●	1614-0781D234CR	■
0.0850	1/8	0.255	1 1/2	0.015	1614-0850.255CR	●	1614-0850L255CR	●	1614-0850D255CR	■
0.0938 (3/32)	1/8	0.279	1 1/2	0.015	1614-0938.279CR	●	1614-0938L279CR	●	1614-0938D279CR	■
0.0950	1/8	0.285	1 1/2	0.015	1614-0950.285CR	●	1614-0950L285CR	●	1614-0950D285CR	■
0.1000	1/8	0.300	1 1/2	0.015	1614-1000.300CR	●	1614-1000L300CR	●	1614-1000D300CR	■
0.1250 (1/8)	1/8	0.500	1 1/2	0.015	1614-1250.500CR	●	1614-1250L500CR	●	1614-1250D500CR	■
0.1875 (3/16)	3/16	0.625	2	0.020	1614-1875.625CR	●	1614-1875L625CR	●	1614-1875D625CR	■
0.2500 (1/4)	1/4	0.750	2 1/2	0.020	1614-2500.750CR	●	1614-2500L750CR	●	1614-2500D750CR	■

\*DLC is Amorphous Diamond

### X-LARGE Corner Radius STANDARD Length (Inch Sizes)

Dimensions (in)					Uncoated		AlTiN Coating		<span style="color:red">NEW</span> DLC* Coating	
D <sup>+0.000</sup> / <sub>-0.001</sub>	d	ℓ	L	r	Part Number	Stock	Part Number	Stock	Part Number	Stock
0.0625 (1/16)	1/8	0.186	1 1/2	0.020	1616-0625.186CR	●	1616-0625L186CR	●	1616-0625D186CR	■
0.0781 (5/64)	1/8	0.234	1 1/2	0.020	1616-0781.234CR	●	1616-0781L234CR	●	1616-0781D234CR	■
0.0938 (3/32)	1/8	0.279	1 1/2	0.020	1616-0938.279CR	●	1616-0938L279CR	●	1616-0938D279CR	■
0.1250 (1/8)	1/8	0.500	1 1/2	0.020	1616-1250.500CR	●	1616-1250L500CR	●	1616-1250D500CR	■
0.1875 (3/16)	3/16	0.625	2	0.030	1616-1875.625CR	●	1616-1875L625CR	●	1616-1875D625CR	■
0.2500 (1/4)	1/4	0.750	2 1/2	0.030	1616-2500.750CR	●	1616-2500L750CR	●	1616-2500D750CR	■
0.3750 (3/8)	3/8	1.000	2 1/2	0.030	1616-3750.1000C	●	1616-3750L1000C	●	1616-3750D1000C	■
0.5000 (1/2)	1/2	1.000	3	0.030	1616-5000.1000C	●	1616-5000L1000C	●	1616-5000D1000C	■

\*DLC is Amorphous Diamond

#### Corner Radius Tolerance

Diameter (D)	0.0450" - 0.1000"	0.1250" - 0.1875"	0.2500" - 0.5000"
+ / -	0.0015"	0.0020"	0.0030"

SERIES 1614 / 1616 WORKPIECE MATERIAL															
Coating	P Steel -30HRC	P Steel 30-40HRC	H Hardened Steel -55HRC	H Hardened Steel -68HRC	M Stainless Steel	K Cast Iron	N Aluminum	N Graphite	N Copper Alloy	N CFRP	N Plastic	N Thermoset Plastic	N High Density Plastic	S Nickel / Cobalt	S Titanium Alloy
AlTiN	★	★	★	☆	☆	☆								☆	☆
DLC							☆	★	☆	★	★	★			
Uncoated							☆	☆	★	☆	★	★	☆		☆

★ : Priority ☆ : Applicable Materials

Symbol Descriptions [Page vii](#)

## 2 FLUTE NEW

0.0938" - 0.5000" DIAMETER

Mirror Surface Finishes

Sub Micron Grain Carbide

STANDARD LENGTH

XX-LARGE / XXX-LARGE CORNER RADIUS END MILLS

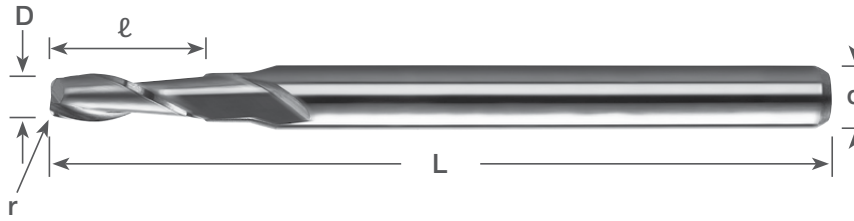

### XX-LARGE Corner Radius STANDARD Length (Inch Sizes)

Dimensions (in)					Uncoated		AlTiN Coating		<span style="color:red">NEW</span> DLC* Coating	
D <sup>+0.000</sup> / <sub>-0.001</sub>	d	ℓ	L	r	Part Number	Stock	Part Number	Stock	Part Number	Stock
0.0938 (3/32)	1/8	0.279	1 1/2	0.030	1617-0938.279CR	●	1617-0938L279CR	●	1617-0938D279CR	■
0.1250 (1/8)	1/8	0.500	1 1/2	0.030	1617-1250.500CR	●	1617-1250L500CR	●	1617-1250D500CR	■
0.1562 (5/32)	3/16	0.562	2	0.030	1617-1562.562CR	●	1617-1562L562CR	●	1617-1562D562CR	■
0.1875 (3/16)	3/16	0.625	2	0.045	1617-1875.625CR	●	1617-1875L625CR	●	1617-1875D625CR	■
0.2500 (1/4)	1/4	0.750	2 1/2	0.045	1617-2500.750CR	●	1617-2500L750CR	●	1617-2500D750CR	■

\*DLC is Amorphous Diamond

### XXX-LARGE Corner Radius STANDARD Length (Inch Sizes)

Dimensions (in)					Uncoated		AlTiN Coating		<span style="color:red">NEW</span> DLC* Coating	
D <sup>+0.000</sup> / <sub>-0.001</sub>	d	ℓ	L	r	Part Number	Stock	Part Number	Stock	Part Number	Stock
0.1875 (3/16)	3/16	0.625	2	0.060	1618-1875.625CR	●	1618-1875L625CR	●	-	-
0.2500 (1/4)	1/4	0.750	2 1/2	0.060	1618-2500.750CR	●	1618-2500L750CR	●	1618-2500D750CR	■
0.3750 (3/8)	3/8	1.000	2 1/2	0.060	1618-3750.1000C	●	1618-3750L1000C	●	-	-
0.5000 (1/2)	1/2	1.000	3	0.060	1618-5000.1000C	●	1618-5000L1000C	●	-	-

\*DLC is Amorphous Diamond

#### Corner Radius Tolerance

Diameter (D)	0.0938"	0.1250" - 0.1875"	0.2500" - 0.5000"
+ / -	0.0015"	0.0020"	0.0030"

SERIES 1617 / 1618 WORKPIECE MATERIAL															
Coating	P	P	H	H	M	K	N	N	N	N	N	N	S	S	
	Steel ~30HRC	Steel 30-40HRC	Hardened Steel ~55HRC	Hardened Steel ~68HRC	Stainless Steel	Cast Iron	Aluminum	Graphite	Copper Alloy	CFRP	Plastic	Thermoset Plastic	High Density Plastic	Nickel / Cobalt	Titanium Alloy
AlTiN	★	★	★	☆	☆	☆								☆	☆
DLC							☆	★	☆	★	★	★			
Uncoated							☆	☆	★	☆	★	★	☆		☆

★ : Priority ☆ : Applicable Materials

Symbol Descriptions [Page vii](#)

● : U.S. Stock Standard  
 ■ : NOT STOCKED - Call for Delivery  
 ▲ : Coming Soon

(U.S.) 1.888.848.8449  
 (International) 001.714.428.3636  
 Pricing & Availability at [KyoceraPrecisionTools.com](http://KyoceraPrecisionTools.com)

DRILLS A  
 END MILLS B  
 ROUTERS C  
 THREAD MILLS & TAPS D  
 ENGRAVERS E  
 BORING BARS F  
 REAMERS G  
 SAWS H  
 TECHNICAL I  
 INDEX J

# 3 FLUTE

1.00mm - 6.00mm DIAMETER

Mirror Surface Finishes  
Sub Micron Grain Carbide

STANDARD LENGTH HIGH HELIX CORNER RADIUS END MILLS

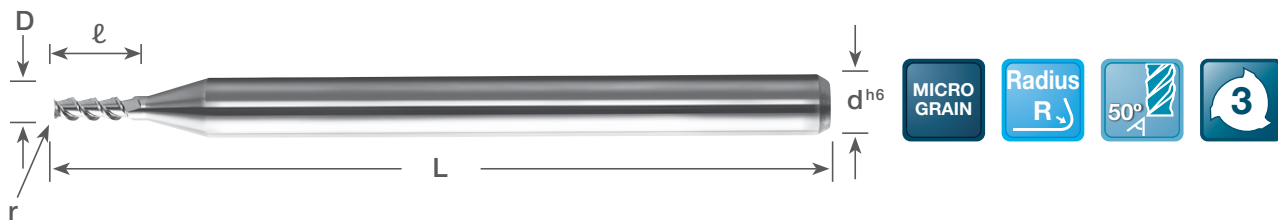

## HIGH HELIX Corner Radius STANDARD Length (Metric Sizes)

D	Dimensions (mm)					Uncoated		AlTiN Coating	
	D <sup>+0.00mm -0.02mm</sup>	d <sup>h6</sup>	ℓ	L	r	Part Number	Stock	Part Number	Stock
1.00		3	3.0	38	0.10	1703-0394.118R	●	1703-0394L118R	●
1.50		3	4.5	38	0.15	1703-0591.177R	●	1703-0591L177R	●
2.00		3	6.0	38	0.20	1703-0787.236R	●	1703-0787L236R	●
2.50		3	7.5	38	0.25	1703-0984.295R	●	1703-0984L295R	●
3.00		3	9.0	38	0.30	1703-1181.354R	●	1703-1181L354R	●
3.50		6	12.0	50	0.35	1703-1378.472R	●	1703-1378L472R	●
4.00		5	12.0	50	0.40	1703-1575.473R	●	1703-1575L473R	●
4.50		6	15.0	50	0.45	1703-1772.591R	●	1703-1772L591R	●
5.00		5	15.0	50	0.50	1703-1968.590R	●	1703-1968L590R	●
5.50		6	18.0	50	0.55	1703-2165.709R	●	1703-2165L709R	●
6.00		6	18.0	50	0.60	1703-2362.709R	●	1703-2362L709R	●

Corner Radius Tolerance

Diameter (D)	1.00mm - 6.00mm
+ / -	0.03mm

SERIES 1703 WORKPIECE MATERIAL

Coating	P Steel ~30HRC	P Steel 30-40HRC	H Hardened Steel ~55HRC	H Hardened Steel ~68HRC	M Stainless Steel	K Cast Iron	N Aluminum	N Graphite	N Copper Alloy	N CFRP	N Plastic	N Thermoset Plastic	N High Density Plastic	S Nickel / Cobalt	S Titanium Alloy
AlTiN	★	★	★	☆	☆	☆	☆	☆	☆	☆	☆	☆	☆	☆	☆
Uncoated							☆	☆	☆	☆	☆	☆	☆		☆

★ : Priority ☆ : Applicable Materials

Symbol Descriptions ● Page vii

## TITAN-AX™

REINFORCED SHANK

Also Available in Square End Styles [Page B14-B15](#)

0.0312" - 0.2500" DIAMETER  
1.00mm - 8.00mm DIAMETER

Variable Helix

AX High Performance Coating

Increased Shank Diameter for Maximum Rigidity

Sub Micron Grain Carbide

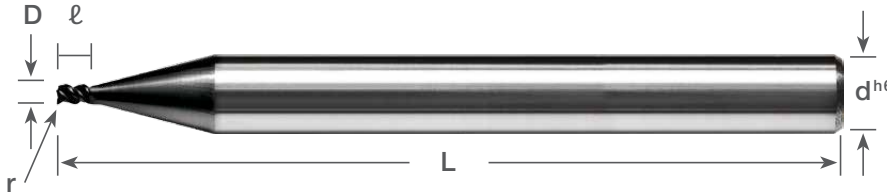

### STUB Length

TITAN-AX (Inch Sizes)

Dimensions (in)					AX Coating	
D <sup>+0.000 -0.001</sup>	d	ℓ	L	r	Part Number	Stock
0.0312 (1/32)	1/4	0.063	2 1/2	0.006	T0312O063CR	●
0.0469 (3/64)	1/4	0.094	2 1/2	0.010	T0469O094CR	●
0.0625 (1/16)	1/4	0.140	2 1/2	0.010	T0625O140CR	●
0.0781 (5/64)	1/4	0.140	2 1/2	0.010	T0781O140CR	●
0.0938 (3/32)	1/4	0.188	2 1/2	0.010	T0938O188CR	●
0.1094 (7/64)	1/4	0.188	2 1/2	0.010	T1094O188CR	●
0.1250 (1/8)	1/4	0.250	2 1/2	0.015	T1250O250CR	●
0.1562 (5/32)	1/4	0.375	2 1/2	0.015	T1562O375CR	●
0.1875 (3/16)	1/4	0.375	2 1/2	0.015	T1875O375CR	●
0.2188 (7/32)	1/4	0.375	2 1/2	0.015	T2188O375CR	●
0.2500 (1/4)	1/4	0.500	2 1/2	0.015	T2500O500CR	●

TITAN-AXM (Metric Sizes)

Dimensions (mm)					AX Coating	
D <sup>+0.00mm -0.02mm</sup>	d <sup>h6</sup>	ℓ	L	r	Part Number	Stock
1.00	6	1.5	63.5	0.10	T0394O059CR1	●
1.00	6	1.5	63.5	0.20	T0394O059CR2	●
1.00	6	1.5	63.5	0.30	T0394O059CR3	●
1.50	6	2.5	63.5	0.10	T0591O098CR1	●
1.50	6	2.5	63.5	0.20	T0591O098CR2	●
1.50	6	2.5	63.5	0.30	T0591O098CR3	●
1.50	6	2.5	63.5	0.50	T0591O098CR4	●
2.00	6	3.0	63.5	0.20	T0787O118CR1	●
2.00	6	3.0	63.5	0.30	T0787O118CR2	●
2.00	6	3.0	63.5	0.50	T0787O118CR3	●
2.50	6	4.0	63.5	0.20	T0984O157CR1	●
2.50	6	4.0	63.5	0.30	T0984O157CR2	●
2.50	6	4.0	63.5	0.50	T0984O157CR3	●
3.00	6	5.0	63.5	0.20	T1181O197CR1	●
3.00	6	5.0	63.5	0.30	T1181O197CR2	●
3.00	6	5.0	63.5	0.50	T1181O197CR3	●
3.00	6	5.0	63.5	1.00	T1181O197CR4	●
4.00	6	6.0	63.5	0.20	T1575O236CR1	●
4.00	6	6.0	63.5	0.30	T1575O236CR2	●
4.00	6	6.0	63.5	0.50	T1575O236CR3	●
4.00	6	6.0	63.5	1.00	T1575O236CR4	●
5.00	6	8.0	63.5	0.20	T1969O315CR1	●
5.00	6	8.0	63.5	0.30	T1969O315CR2	●
5.00	6	8.0	63.5	0.50	T1969O315CR3	●
5.00	6	8.0	63.5	1.00	T1969O315CR4	●
5.00	6	8.0	63.5	1.50	T1969O315CR5	●
6.00	6	9.0	63.5	0.20	T2362O354CR1	●
6.00	6	9.0	63.5	0.30	T2362O354CR2	●
6.00	6	9.0	63.5	0.50	T2362O354CR3	●
6.00	6	9.0	63.5	1.00	T2362O354CR4	●
6.00	6	9.0	63.5	1.50	T2362O354CR5	●
6.00	6	9.0	63.5	2.00	T2362O354CR6	●
8.00	8	12.0	63.5	0.20	T3150O472CR1	●
8.00	8	12.0	63.5	0.30	T3150O472CR2	●
8.00	8	12.0	63.5	0.50	T3150O472CR3	●
8.00	8	12.0	63.5	1.00	T3150O472CR4	●
8.00	8	12.0	63.5	1.50	T3150O472CR5	●
8.00	8	12.0	63.5	2.00	T3150O472CR6	●

#### Corner Radius Tolerance

Diameter (D)	0.0312" - 0.2500"	1.00mm - 8.00mm
+ / -	0.0020"	0.05mm

### TITAN-AX / TITAN-AXM WORKPIECE MATERIAL

Coating	P	P	H	H	M	K	N	N	N	N	N	N	S	S	
	Steel ~30HRC	Steel 30-40HRC	Hardened Steel ~55HRC	Hardened Steel ~68HRC	Stainless Steel	Cast Iron	Aluminum	Graphite	Copper Alloy	CFRP	Plastic	Thermoset Plastic	High Density Plastic	Nickel / Cobalt	Titanium Alloy
AX	☆	☆	★	★	☆	☆								★	★

★ : Priority ☆ : Applicable Materials

Symbol Descriptions [Page vii](#)

● : U.S. Stock Standard  
■ : NOT STOCKED - Call for Delivery  
▲ : Coming Soon

(U.S.) 1.888.848.8449  
(International) 001.714.428.3636  
Pricing & Availability at [KyoceraPrecisionTools.com](http://KyoceraPrecisionTools.com)

DRILLS A  
END MILLS B  
ROUTERS C  
THREAD MILLS & TAPS D  
ENGRAVERS E  
BORING BARS F  
REAMERS G  
SAWS H  
TECHNICAL I  
INDEX J

## TITAN-AX™

### REINFORCED SHANK

Also Available in Square End Styles [Page B14-B15](#)

**0.0312" - 0.2500" DIAMETER**  
**1.00mm - 8.00mm DIAMETER**

Variable Helix

AX High Performance Coating

Increased Shank Diameter for Maximum Rigidity

Sub Micron Grain Carbide

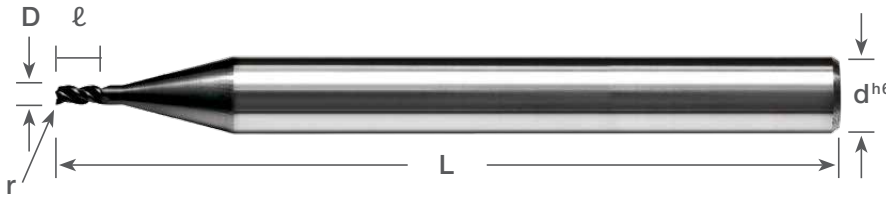

## STANDARD Length

TITAN-AX (Inch Sizes)

Dimensions (in)					AX Coating	
D	d	ℓ	L	r	Part Number	Stock
0.0312 (1/32)	1/4	0.094	2 1/2	0.006	T0312O094CR	●
0.0469 (3/64)	1/4	0.141	2 1/2	0.010	T0469O141CR	●
0.0625 (1/16)	1/4	0.188	2 1/2	0.010	T0625O188CR	●
0.0781 (5/64)	1/4	0.234	2 1/2	0.010	T0781O234CR	●
0.0938 (3/32)	1/4	0.375	2 1/2	0.010	T0938O375CR	●
0.1094 (7/64)	1/4	0.438	2 1/2	0.010	T1094O438CR	●
0.1250 (1/8)	1/4	0.500	2 1/2	0.015	T1250O500CR	●
0.1562 (5/32)	1/4	0.563	2 1/2	0.015	T1562O563CR	●
0.1875 (3/16)	1/4	0.625	2 1/2	0.015	T1875O625CR	●
0.2188 (7/32)	1/4	0.625	2 1/2	0.015	T2188O625CR	●
0.2500 (1/4)	1/4	0.750	2 1/2	0.015	T2500O750CR	●

TITAN-AXM (Metric Sizes)

Dimensions (mm)					AX Coating	
D	d <sup>h6</sup>	ℓ	L	r	Part Number	Stock
1.00	6	3.0	63.5	0.10	T0394O118CR1	●
1.00	6	3.0	63.5	0.20	T0394O118CR2	●
1.00	6	3.0	63.5	0.30	T0394O118CR3	●
1.50	6	4.5	63.5	0.10	T0591O177CR1	●
1.50	6	4.5	63.5	0.20	T0591O177CR2	●
1.50	6	4.5	63.5	0.30	T0591O177CR3	●
1.50	6	4.5	63.5	0.50	T0591O177CR4	●
2.00	6	6.0	63.5	0.20	T0787O236CR1	●
2.00	6	6.0	63.5	0.30	T0787O236CR2	●
2.00	6	6.0	63.5	0.50	T0787O236CR3	●
2.50	6	7.5	63.5	0.20	T0984O295CR1	●
2.50	6	7.5	63.5	0.30	T0984O295CR2	●
2.50	6	7.5	63.5	0.50	T0984O295CR3	●
3.00	6	9.0	63.5	0.20	T1181O354CR1	●
3.00	6	9.0	63.5	0.30	T1181O354CR2	●
3.00	6	9.0	63.5	0.50	T1181O354CR3	●
3.00	6	9.0	63.5	1.00	T1181O354CR4	●
4.00	6	12.0	63.5	0.20	T1575O472CR1	●
4.00	6	12.0	63.5	0.30	T1575O472CR2	●
4.00	6	12.0	63.5	0.50	T1575O472CR3	●
4.00	6	12.0	63.5	1.00	T1575O472CR4	●
5.00	6	15.0	63.5	0.20	T1969O591CR1	●
5.00	6	15.0	63.5	0.30	T1969O591CR2	●
5.00	6	15.0	63.5	0.50	T1969O591CR3	●
5.00	6	15.0	63.5	1.00	T1969O591CR4	●
5.00	6	15.0	63.5	1.50	T1969O591CR5	●
6.00	6	18.0	63.5	0.20	T2362O709CR1	●
6.00	6	18.0	63.5	0.30	T2362O709CR2	●
6.00	6	18.0	63.5	0.50	T2362O709CR3	●
6.00	6	18.0	63.5	1.00	T2362O709CR4	●
6.00	6	18.0	63.5	1.50	T2362O709CR5	●
6.00	6	18.0	63.5	2.00	T2362O709CR6	●
8.00	8	24.0	63.5	0.20	T3150O945CR1	●
8.00	8	24.0	63.5	0.30	T3150O945CR2	●
8.00	8	24.0	63.5	0.50	T3150O945CR3	●
8.00	8	24.0	63.5	1.00	T3150O945CR4	●
8.00	8	24.0	63.5	1.50	T3150O945CR5	●
8.00	8	24.0	63.5	2.00	T3150O945CR6	●

### Corner Radius Tolerance

Diameter (D)	0.0312" - 0.2500"	1.00mm - 8.00mm
+ / -	0.0020"	0.05mm

### TITAN-AX / TITAN-AXM WORKPIECE MATERIAL

Coating	P	P	H	H	M	K	N	N	N	N	N	N	S	S	
	Steel ~30HRC	Steel 30-40HRC	Hardened Steel ~55HRC	Hardened Steel ~68HRC	Stainless Steel	Cast Iron	Aluminum	Graphite	Copper Alloy	CFRP	Plastic	Thermoset Plastic	High Density Plastic	Nickel / Cobalt	Titanium Alloy
AX	☆	☆	★	★	☆	☆								★	★

★ : Priority ☆ : Applicable Materials

Symbol Descriptions [Page vii](#)

# TITAN-AX™

REINFORCED SHANK  
LONG REACH REDUCED NECK

Also Available in Square End Styles [Page B14-B15](#)

0.0312" - 0.2500" DIAMETER  
1.00mm - 8.00mm DIAMETER

Variable Helix

AX High Performance Coating

Increased Shank Diameter for Maximum Rigidity

Sub Micron Grain Carbide



## Extended Reach

TITAN-AX (Inch Sizes)

Dimensions (in)						AX Coating	
D <sup>+0.000 -0.001</sup>	d	ℓ	L	L <sub>1</sub>	r	Part Number	Stock
0.0312 (1/32)	1/4	0.094	2 1/2	0.155	0.006	T0312O094ERC	●
0.0469 (3/64)	1/4	0.141	2 1/2	0.230	0.010	T0469O141ERC	●
0.0625 (1/16)	1/4	0.188	2 1/2	0.312	0.010	T0625O188ERC	●
0.0781 (5/64)	1/4	0.234	2 1/2	0.390	0.010	T0781O234ERC	●
0.0938 (3/32)	1/4	0.375	2 1/2	0.465	0.010	T0938O375ERC	●
0.1094 (7/64)	1/4	0.438	2 1/2	0.545	0.010	T1094O438ERC	●
0.1250 (1/8)	1/4	0.500	2 1/2	0.625	0.015	T1250O500ERC	●
0.1562 (5/32)	1/4	0.563	2 1/2	0.781	0.015	T1562O563ERC	●
0.1875 (3/16)	1/4	0.625	2 1/2	0.938	0.015	T1875O625ERC	●
0.2188 (7/32)	1/4	0.625	2 1/2	1.093	0.015	T2188O625ERC	●
0.2500 (1/4)	1/4	0.750	2 1/2	1.250	0.015	T2500O750ERC	●

### Corner Radius Tolerance

Diameter (D)	0.0312" - 0.2500"	1.00mm - 8.00mm
+ / -	0.0020"	0.05mm

TITAN-AXM (Metric Sizes)

Dimensions (mm)						AX Coating	
D <sup>+0.00mm -0.02mm</sup>	d <sup>h6</sup>	ℓ	L	L <sub>1</sub>	r	Part Number	Stock
1.00	6	3.0	75	10	0.10	T0394O118ECR1	●
1.00	6	3.0	75	10	0.20	T0394O118ECR2	●
1.00	6	3.0	75	10	0.30	T0394O118ECR3	●
1.50	6	4.5	75	15	0.10	T0591O177ECR1	●
1.50	6	4.5	75	15	0.20	T0591O177ECR2	●
1.50	6	4.5	75	15	0.30	T0591O177ECR3	●
1.50	6	4.5	75	15	0.50	T0591O177ECR4	●
2.00	6	6.0	75	20	0.20	T0787O236ECR1	●
2.00	6	6.0	75	20	0.30	T0787O236ECR2	●
2.00	6	6.0	75	20	0.50	T0787O236ECR3	●
2.50	6	7.5	75	25	0.20	T0984O295ECR1	●
2.50	6	7.5	75	25	0.30	T0984O295ECR2	●
2.50	6	7.5	75	25	0.50	T0984O295ECR3	●
3.00	6	9.0	75	30	0.20	T1181O354ECR1	●
3.00	6	9.0	75	30	0.30	T1181O354ECR2	●
3.00	6	9.0	75	30	0.50	T1181O354ECR3	●
3.00	6	9.0	75	30	1.00	T1181O354ECR4	●
4.00	6	12.0	75	30	0.20	T1575O472ECR1	●
4.00	6	12.0	75	30	0.30	T1575O472ECR2	●
4.00	6	12.0	75	30	0.50	T1575O472ECR3	●
4.00	6	12.0	75	30	1.00	T1575O472ECR4	●
5.00	6	15.0	75	40	0.20	T1969O591ECR1	●
5.00	6	15.0	75	40	0.30	T1969O591ECR2	●
5.00	6	15.0	75	40	0.50	T1969O591ECR3	●
5.00	6	15.0	75	40	1.00	T1969O591ECR4	●
5.00	6	15.0	75	40	1.50	T1969O591ECR5	●
6.00	6	18.0	75	45	0.20	T2362O709ECR1	●
6.00	6	18.0	75	45	0.30	T2362O709ECR2	●
6.00	6	18.0	75	45	0.50	T2362O709ECR3	●
6.00	6	18.0	75	45	1.00	T2362O709ECR4	●
6.00	6	18.0	75	45	1.50	T2362O709ECR5	●
6.00	6	18.0	75	45	2.00	T2362O709ECR6	●
8.00	8	24.0	100	50	0.20	T3150O945ECR1	●
8.00	8	24.0	100	50	0.30	T3150O945ECR2	●
8.00	8	24.0	100	50	0.50	T3150O945ECR3	●
8.00	8	24.0	100	50	1.00	T3150O945ECR4	●
8.00	8	24.0	100	50	1.50	T3150O945ECR5	●
8.00	8	24.0	100	50	2.00	T3150O945ECR6	●

### TITAN-AX / TITAN-AXM WORKPIECE MATERIAL

Coating	P	P	H	H	M	K	N	N	N	N	N	N	S	S	
	Steel ~30HRC	Steel 30-40HRC	Hardened Steel ~55HRC	Hardened Steel ~68HRC	Stainless Steel	Cast Iron	Aluminum	Graphite	Copper Alloy	CFRP	Plastic	Thermoset Plastic	High Density Plastic	Nickel / Cobalt	Titanium Alloy
AX	☆	☆	★	★	☆	☆								★	★

★ : Priority ☆ : Applicable Materials

Symbol Descriptions [Page vii](#)

- : U.S. Stock Standard
- : NOT STOCKED - Call for Delivery
- ▲ : Coming Soon

(U.S.) 1.888.848.8449  
(International) 001.714.428.3636  
Pricing & Availability at [KyoceraPrecisionTools.com](http://KyoceraPrecisionTools.com)



## 3 FLUTE NEW

0.0156" - 0.2500" DIAMETER

Mirror Surface Finishes  
Sub Micron Grain Carbide

EXTENDED REACH  
SMALL CORNER RADIUS END MILLS

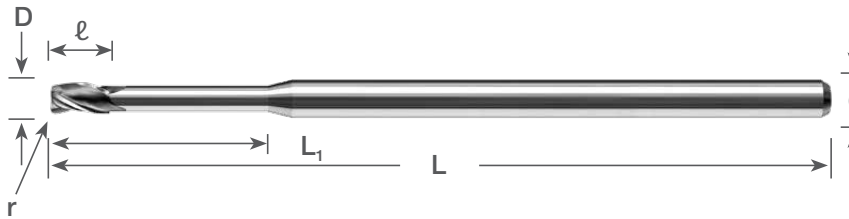

### SMALL Corner Radius EXTENDED Reach (Inch Sizes)

Dimensions (in)	Uncoated		AlTiN Coating		NEW DLC* Coating	
	Part Number	Stock	Part Number	Stock	Part Number	Stock
D <sup>+0.000</sup> <sub>-0.001</sub>	d	l	L	L <sub>1</sub>	r	
0.0156 (1/64)	1/8	0.022	2.5	0.078	0.003	1743-0156.078CR ● 1743-0156L078CR ● 1743-0156D078CR ■
0.0156 (1/64)	1/8	0.022	2.5	0.125	0.003	1743-0156.125CR ● 1743-0156L125CR ● 1743-0156D125CR ■
0.0200	1/8	0.030	2 1/2	0.100	0.005	1743-0200.100CR ● 1743-0200L100CR ● 1743-0200D100CR ■
0.0200	1/8	0.030	2 1/2	0.160	0.005	1743-0200.160CR ● 1743-0200L160CR ● 1743-0200D160CR ■
0.0250	1/8	0.037	2 1/2	0.125	0.005	1743-0250.125CR ● 1743-0250L125CR ● 1743-0250D125CR ■
0.0250	1/8	0.037	2 1/2	0.203	0.005	1743-0250.203CR ● 1743-0250L203CR ● 1743-0250D203CR ■
0.0312 (1/32)	1/8	0.046	2.5	0.156	0.005	1743-0312.156CR ● 1743-0312L156CR ● 1743-0312D156CR ■
0.0312 (1/32)	1/8	0.046	2.5	0.250	0.005	1743-0312.250CR ● 1743-0312L250CR ● 1743-0312D250CR ■
0.0312 (1/32)	1/8	0.046	2.5	0.375	0.005	1743-0312.375CR ● 1743-0312L375CR ● 1743-0312D375CR ■
0.0469 (3/64)	1/8	0.070	2.5	0.250	0.005	1743-0469.250CR ● 1743-0469L250CR ● 1743-0469D250CR ■
0.0469 (3/64)	1/8	0.070	2.5	0.375	0.005	1743-0469.375CR ● 1743-0469L375CR ● 1743-0469D375CR ■
0.0469 (3/64)	1/8	0.070	2.5	0.570	0.005	1743-0469.570CR ● 1743-0469L570CR ● 1743-0469D570CR ■
0.0625 (1/16)	1/8	0.093	2.5	0.312	0.005	1743-0625.312CR ● 1743-0625L312CR ● 1743-0625D312CR ■
0.0625 (1/16)	1/8	0.093	2.5	0.500	0.005	1743-0625.500CR ● 1743-0625L500CR ● 1743-0625D500CR ■
0.0625 (1/16)	1/8	0.093	2.5	0.750	0.005	1743-0625.750CR ● 1743-0625L750CR ● 1743-0625D750CR ■
0.0781 (5/64)	1/8	0.117	2.5	0.406	0.005	1743-0781.406CR ● 1743-0781L406CR ● 1743-0781D406CR ■
0.0781 (5/64)	1/8	0.117	2.5	0.625	0.005	1743-0781.625CR ● 1743-0781L625CR ● 1743-0781D625CR ■
0.0781 (5/64)	1/8	0.117	2.5	0.940	0.005	1743-0781.940CR ● 1743-0781L940CR ● 1743-0781D940CR ■
0.0938 (3/32)	1/8	0.139	2.5	0.500	0.005	1743-0938.500CR ● 1743-0938L500CR ● 1743-0938D500CR ■
0.0938 (3/32)	1/8	0.139	2.5	0.750	0.005	1743-0938.750CR ● 1743-0938L750CR ● 1743-0938D750CR ■
0.0938 (3/32)	1/8	0.139	2.5	1.125	0.005	1743-0938.1125C ● 1743-0938L1125C ● 1743-0938D1125C ■
0.1250 (1/8)	1/8	0.187	2.5	0.625	0.010	1743-1250.625CR ● 1743-1250L625CR ● 1743-1250D625CR ■
0.1250 (1/8)	1/8	0.187	2.5	1.000	0.010	1743-1250.1000C ● 1743-1250L1000C ● 1743-1250D1000C ■
0.1250 (1/8)	1/8	0.187	3	1.500	0.010	1743-1250.1500C ● 1743-1250L1500C ● 1743-1250D1500C ■
0.1562 (5/32)	3/16	0.234	3	0.750	0.010	1743-1562.750CR ● 1743-1562L750CR ● 1743-1562D750CR ■
0.1562 (5/32)	3/16	0.234	3	1.250	0.010	1743-1562.1250C ● 1743-1562L1250C ● 1743-1562D1250C ■
0.1875 (3/16)	3/16	0.281	3	1.000	0.015	1743-1875.1000C ● 1743-1875L1000C ● 1743-1875D1000C ■
0.1875 (3/16)	3/16	0.281	3	1.500	0.015	1743-1875.1500C ● 1743-1875L1500C ● 1743-1875D1500C ■
0.1875 (3/16)	3/16	0.281	4	2.250	0.015	1743-1875.2250C ● 1743-1875L2250C ● 1743-1875D2250C ■
0.2500 (1/4)	1/4	0.375	4	1.250	0.015	1743-2500.1250C ● 1743-2500L1250C ● 1743-2500D1250C ■
0.2500 (1/4)	1/4	0.375	4	2.000	0.015	1743-2500.2000C ● 1743-2500L2000C ● 1743-2500D2000C ■
0.2500 (1/4)	1/4	0.375	6	3.000	0.015	1743-2500.3000C ● 1743-2500L3000C ● 1743-2500D3000C ■

\*DLC is Amorphous Diamond

#### Corner Radius Tolerance

Diameter (D)	0.0156" - 0.0312"	0.0469" - 0.0938"	0.1250" - 0.1875"	0.2500"
+ / -	0.0010"	0.0015"	0.0020"	0.0030"

#### SERIES 1743 WORKPIECE MATERIAL

Coating	P Steel -30HRC	P Steel 30-40HRC	H Hardened Steel -55HRC	H Hardened Steel -68HRC	M Stainless Steel	K Cast Iron	N Aluminum	N Graphite	N Copper Alloy	N CFRP	N Plastic	N Thermoset Plastic	N High Density Plastic	S Nickel / Cobalt	S Titanium Alloy
AlTiN	★	★	★	☆	☆	☆								☆	☆
DLC							☆	★	☆	★	★	★			
Uncoated							☆	☆	★	☆	★	★	☆		☆

★ : Priority ☆ : Applicable Materials

Symbol Descriptions [Page vii](#)



## 3 FLUTE NEW

0.0312" - 0.2500" DIAMETER

EXTENDED REACH  
STANDARD CORNER RADIUS END MILLS

Mirror Surface Finishes  
Sub Micron Grain Carbide

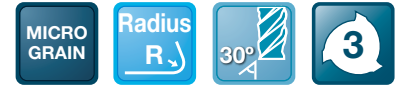
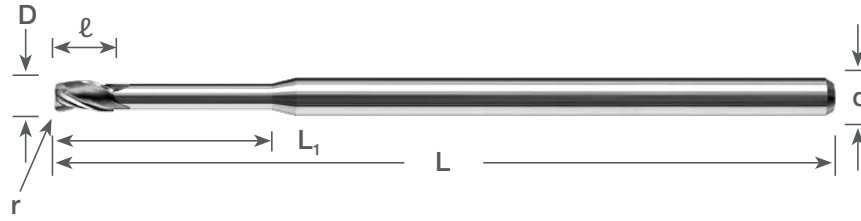

### STANDARD Corner Radius EXTENDED Reach (Inch Sizes)

Dimensions (in)						Uncoated		AlTiN Coating		NEW DLC* Coating	
D <sup>+0.000</sup> <sub>-0.001</sub>	d	ℓ	L	L <sub>1</sub>	r	Part Number	Stock	Part Number	Stock	Part Number	Stock
0.0312 (1/32)	1/8	0.046	2 1/2	0.156	0.010	1744-0312.156CR	●	1744-0312L156CR	●	1744-0312D156CR	■
0.0312 (1/32)	1/8	0.046	2 1/2	0.250	0.010	1744-0312.250CR	●	1744-0312L250CR	●	1744-0312D250CR	■
0.0312 (1/32)	1/8	0.046	2 1/2	0.375	0.010	1744-0312.375CR	●	1744-0312L375CR	●	1744-0312D375CR	■
0.0469 (3/64)	1/8	0.070	2 1/2	0.250	0.010	1744-0469.250CR	●	1744-0469L250CR	●	1744-0469D250CR	■
0.0469 (3/64)	1/8	0.070	2 1/2	0.375	0.010	1744-0469.375CR	●	1744-0469L375CR	●	1744-0469D375CR	■
0.0469 (3/64)	1/8	0.070	2 1/2	0.570	0.010	1744-0469.570CR	●	1744-0469L570CR	●	1744-0469D570CR	■
0.0625 (1/16)	1/8	0.093	2 1/2	0.312	0.010	1744-0625.312CR	●	1744-0625L312CR	●	1744-0625D312CR	■
0.0625 (1/16)	1/8	0.093	2 1/2	0.500	0.010	1744-0625.500CR	●	1744-0625L500CR	●	1744-0625D500CR	■
0.0625 (1/16)	1/8	0.093	2 1/2	0.750	0.010	1744-0625.750CR	●	1744-0625L750CR	●	1744-0625D750CR	■
0.0781 (5/64)	1/8	0.117	2 1/2	0.406	0.010	1744-0781.406CR	●	1744-0781L406CR	●	1744-0781D406CR	■
0.0781 (5/64)	1/8	0.117	2 1/2	0.625	0.010	1744-0781.625CR	●	1744-0781L625CR	●	1744-0781D625CR	■
0.0781 (5/64)	1/8	0.117	2 1/2	0.940	0.010	1744-0781.940CR	●	1744-0781L940CR	●	1744-0781D940CR	■
0.0938 (3/32)	1/8	0.139	2 1/2	0.500	0.010	1744-0938.500CR	●	1744-0938L500CR	●	1744-0938D500CR	■
0.0938 (3/32)	1/8	0.139	2 1/2	0.750	0.010	1744-0938.750CR	●	1744-0938L750CR	●	1744-0938D750CR	■
0.0938 (3/32)	1/8	0.139	2 1/2	1.125	0.010	1744-0938.1125C	●	1744-0938L1125C	●	1744-0938D1125C	■
0.1250 (1/8)	1/8	0.187	2 1/2	0.625	0.015	1744-1250.625CR	●	1744-1250L625CR	●	1744-1250D625CR	■
0.1250 (1/8)	1/8	0.187	2 1/2	1.000	0.015	1744-1250.1000C	●	1744-1250L1000C	●	1744-1250D1000C	■
0.1250 (1/8)	1/8	0.187	3	1.500	0.015	1744-1250.1500C	●	1744-1250L1500C	●	1744-1250D1500C	■
0.1562 (5/32)	3/16	0.234	3	0.750	0.015	1744-1562.750CR	●	1744-1562L750CR	●	1744-1562D750CR	■
0.1562 (5/32)	3/16	0.234	3	1.250	0.015	1744-1562.1250C	●	1744-1562L1250C	●	1744-1562D1250C	■
0.1875 (3/16)	3/16	0.281	3	1.000	0.030	1744-1875.1000C	●	1744-1875L1000C	●	1744-1875D1000C	■
0.1875 (3/16)	3/16	0.281	3	1.500	0.030	1744-1875.1500C	●	1744-1875L1500C	●	1744-1875D1500C	■
0.1875 (3/16)	3/16	0.281	4	2.250	0.030	1744-1875.2250C	●	1744-1875L2250C	●	1744-1875D2250C	■
0.2500 (1/4)	1/4	0.375	4	1.250	0.030	1744-2500.1250C	●	1744-2500L1250C	●	1744-2500D1250C	■
0.2500 (1/4)	1/4	0.375	4	2.000	0.030	1744-2500.2000C	●	1744-2500L2000C	●	1744-2500D2000C	■
0.2500 (1/4)	1/4	0.375	6	3.000	0.030	1744-2500.3000C	●	1744-2500L3000C	●	1744-2500D3000C	■

#### Corner Radius Tolerance

\*DLC is Amorphous Diamond

Diameter (D)	0.0312"	0.0469" - 0.0938"	0.1250" - 0.1875"	0.2500"
+ / -	0.0010"	0.0015"	0.0020"	0.0030"

SERIES 1744 WORKPIECE MATERIAL															
Coating	P	P	H	H	M	K	N	N	N	N	N	N	S	S	
	Steel ~30HRC	Steel 30-40HRC	Hardened Steel ~55HRC	Hardened Steel ~68HRC	Stainless Steel	Cast Iron	Aluminum	Graphite	Copper Alloy	CFRP	Plastic	Thermoset Plastic	High Density Plastic	Nickel / Cobalt	Titanium Alloy
AlTiN	★	★	★	☆	☆	☆								☆	☆
DLC							☆	★	☆	★	★	★			
Uncoated							☆	☆	★	☆	★	★	☆		☆

★ : Priority ☆ : Applicable Materials

Symbol Descriptions [Page vii](#)

● : U.S. Stock Standard  
■ : NOT STOCKED - Call for Delivery  
▲ : Coming Soon

(U.S.) 1.888.848.8449  
(International) 001.714.428.3636  
Pricing & Availability at [KyoceraPrecisionTools.com](http://KyoceraPrecisionTools.com)

DRILLS A  
 END MILLS B  
 ROUTERS C  
 THREAD MILLS & TAPS D  
 ENGRAVERS E  
 BORING BARS F  
 REAMERS G  
 SAWS H  
 TECHNICAL I  
 INDEX J

## 3 FLUTE NEW

0.0625" - 0.1250" DIAMETER

Mirror Surface Finishes

Sub Micron Grain Carbide

EXTENDED REACH LARGE CORNER RADIUS END MILLS

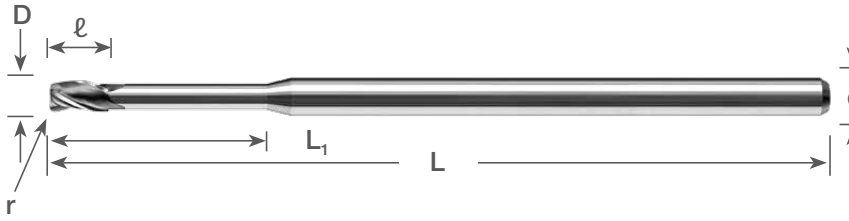

### LARGE Corner Radius EXTENDED Reach (Inch Sizes)

Dimensions (in)	Uncoated		AlTiN Coating		NEW DLC* Coating	
	Part Number	Stock	Part Number	Stock	Part Number	Stock
D <sup>+0.000</sup> <sub>-0.001</sub>	d	ℓ	L	L <sub>1</sub>	r	
0.0625 (1/16)	1/8	0.093	2 1/2	0.312	0.015	1746-0625.312CR ●
0.0625 (1/16)	1/8	0.093	2 1/2	0.500	0.015	1746-0625.500CR ●
0.0625 (1/16)	1/8	0.093	2 1/2	0.750	0.015	1746-0625.750CR ●
0.0781 (5/64)	1/8	0.117	2 1/2	0.406	0.015	1746-0781.406CR ●
0.0781 (5/64)	1/8	0.117	2 1/2	0.625	0.015	1746-0781.625CR ●
0.0781 (5/64)	1/8	0.117	2 1/2	0.940	0.015	1746-0781.940CR ●
0.0938 (3/32)	1/8	0.139	2 1/2	0.500	0.015	1746-0938.500CR ●
0.0938 (3/32)	1/8	0.139	2 1/2	0.750	0.015	1746-0938.750CR ●
0.0938 (3/32)	1/8	0.139	2 1/2	1.125	0.015	1746-0938.1125C ●
0.1250 (1/8)	1/8	0.187	2 1/2	0.625	0.030	1746-1250.625CR ●
0.1250 (1/8)	1/8	0.187	2 1/2	1.000	0.030	1746-1250.1000C ●
0.1250 (1/8)	1/8	0.187	3	1.500	0.030	1746-1250.1500C ●

\*DLC is Amorphous Diamond

#### Corner Radius Tolerance

Diameter (D)	0.0625" - 0.0938"	0.1250"
+ / -	0.0015"	0.0020"

#### SERIES 1746 WORKPIECE MATERIAL

Coating	P	P	H	H	M	K	N	N	N	N	N	N	N	S	S
	Steel ~30HRC	Steel 30-40HRC	Hardened Steel ~55HRC	Hardened Steel ~68HRC	Stainless Steel	Cast Iron	Aluminum	Graphite	Copper Alloy	CFRP	Plastic	Thermoset Plastic	High Density Plastic	Nickel / Cobalt	Titanium Alloy
AlTiN	★	★	★	☆	☆	☆								☆	☆
DLC							☆	★	☆	★	★	★			
Uncoated							☆	☆	★	☆	★	★	☆		☆

★ : Priority ☆ : Applicable Materials

Symbol Descriptions [Page vii](#)

# 4 FLUTE

STANDARD LENGTH HIGH HELIX CORNER RADIUS END MILLS

1.00mm - 6.00mm DIAMETER

Mirror Surface Finishes  
Sub Micron Grain Carbide

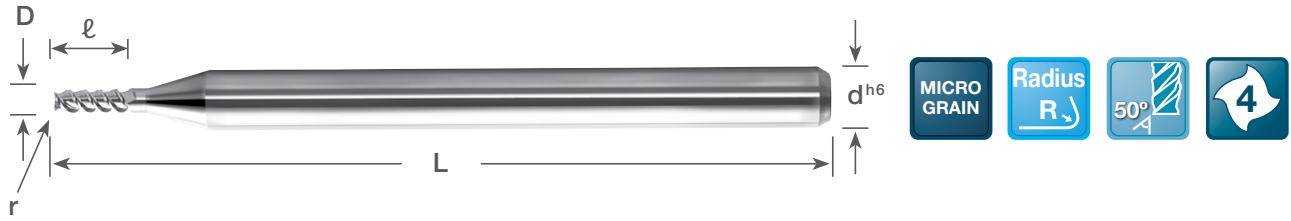

## HIGH HELIX Corner Radius STANDARD Length (Metric Sizes)

Dimensions (mm)					Uncoated		AlTiN Coating	
D <sup>+0.00mm -0.02mm</sup>	d <sup>h6</sup>	ℓ	L	r	Part Number	Stock	Part Number	Stock
1.00	3	3.0	38	0.10	1804-0394.118R	●	1804-0394L118R	●
1.50	3	4.5	38	0.15	1804-0591.177R	●	1804-0591L177R	●
2.00	3	6.0	38	0.20	1804-0787.236R	●	1804-0787L236R	●
2.50	3	7.5	38	0.25	1804-0984.295R	●	1804-0984L295R	●
3.00	3	9.0	38	0.30	1804-1181.354R	●	1804-1181L354R	●
3.50	5	12.0	50	0.35	1804-1378.473R	●	1804-1378L473R	●
4.00	5	12.0	50	0.40	1804-1575.473R	●	1804-1575L473R	●
4.50	5	15.0	50	0.45	1804-1772.590R	●	1804-1772L590R	●
5.00	5	15.0	50	0.50	1804-1968.590R	●	1804-1968L590R	●
5.50	6	18.0	50	0.55	1804-2165.709R	●	1804-2165L709R	●
6.00	6	18.0	50	0.60	1804-2362.709R	●	1804-2362L709R	●

**Corner Radius Tolerance**

Diameter (D)	1.00mm - 6.00mm
+ / -	0.03mm

SERIES 1804 WORKPIECE MATERIAL															
Coating	P	P	H	H	M	K	N	N	N	N	N	N	N	S	S
	Steel ~30HRC	Steel 30~40HRC	Hardened Steel ~55HRC	Hardened Steel ~68HRC	Stainless Steel	Cast Iron	Aluminum	Graphite	Copper Alloy	CFRP	Plastic	Thermoset Plastic	High Density Plastic	Nickel / Cobalt	Titanium Alloy
AlTiN	★	★	★	☆	☆	☆	☆	☆	☆	☆	☆	☆	☆	☆	☆
Uncoated							☆	☆	☆	☆	☆	☆	☆		☆

★ : Priority ☆ : Applicable Materials

Symbol Descriptions [Page vii](#)

● : U.S. Stock Standard  
■ : NOT STOCKED - Call for Delivery  
▲ : Coming Soon

DRILLS **A**

END MILLS **B**

ROUTERS **C**

THREAD MILLS & TAPS **D**

ENGRAVERS **E**

BORING BARS **F**

REAMERS **G**

SAWS **H**

TECHNICAL **I**

INDEX **J**

## 4 FLUTE

0.0150" - 0.2500" DIAMETER

Mirror Surface Finishes

Sub Micron Grain Carbide

STANDARD LENGTH  
SMALL CORNER RADIUS END MILLS

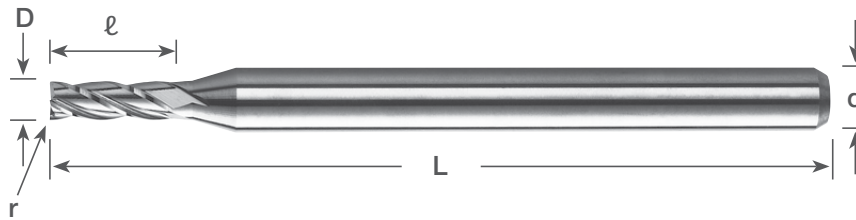

### SMALL Corner Radius STANDARD Length (Inch Sizes)

Dimensions (in)	Uncoated		AlTiN Coating		NEW DLC* Coating						
	D	d	l	L	Part Number	Stock	Part Number	Stock	Part Number	Stock	
	0.0150	1/8	0.045	1 1/2	0.003	1812-0150.045CR	●	1812-0150L045CR	●	1812-0150D045CR	■
NEW	0.0156 (1/64)	1/8	0.045	1 1/2	0.003	1812-0156.045CR	●	1812-0156L045CR	●	1812-0156D045CR	■
NEW	0.0200	1/8	0.030	1 1/2	0.005	1812-0200.030CR	●	1812-0200L030CR	●	1812-0200D030CR	■
	0.0200	1/8	0.060	1 1/2	0.005	1812-0200.060CR	●	1812-0200L060CR	●	1812-0200D060CR	■
NEW	0.0250	1/8	0.038	1 1/2	0.005	1812-0250.038CR	●	1812-0250L038CR	●	1812-0250D038CR	■
	0.0250	1/8	0.075	1 1/2	0.005	1812-0250.075CR	●	1812-0250L075CR	●	1812-0250D075CR	■
	0.0300	1/8	0.090	1 1/2	0.005	1812-0300.090CR	●	1812-0300L090CR	●	1812-0300D090CR	■
NEW	0.0312 (1/32)	1/8	0.047	1 1/2	0.005	1812-0312.047CR	●	1812-0312L047CR	●	1812-0312D047CR	■
NEW	0.0312 (1/32)	1/8	0.093	1 1/2	0.005	1812-0312.093CR	●	1812-0312L093CR	●	1812-0312D093CR	■
	0.0350	1/8	0.105	1 1/2	0.005	1812-0350.105CR	●	1812-0350L105CR	●	1812-0350D105CR	■
	0.0400	1/8	0.120	1 1/2	0.005	1812-0400.120CR	●	1812-0400L120CR	●	1812-0400D120CR	■
	0.0450	1/8	0.135	1 1/2	0.005	1812-0450.135CR	●	1812-0450L135CR	●	1812-0450D135CR	■
NEW	0.0469 (3/64)	1/8	0.071	1 1/2	0.005	1812-0469.071CR	●	1812-0469L071CR	●	1812-0469D071CR	■
NEW	0.0469 (3/64)	1/8	0.141	1 1/2	0.005	1812-0469.141CR	●	1812-0469L141CR	●	1812-0469D141CR	■
	0.0500	1/8	0.150	1 1/2	0.010	1812-0500.150CR	●	1812-0500L150CR	●	1812-0500D150CR	■
NEW	0.0550	1/8	0.165	1 1/2	0.005	1812-0550.165CR	●	1812-0550L165CR	●	1812-0550D165CR	■
	0.0600	1/8	0.180	1 1/2	0.010	1812-0600.180CR	●	1812-0600L180CR	●	1812-0600D180CR	■
NEW	0.0625 (1/16)	1/8	0.093	1 1/2	0.005	1812-0625.093CR	●	1812-0625L093CR	●	1812-0625D093CR	■
NEW	0.0625 (1/16)	1/8	0.186	1 1/2	0.005	1812-0625.186CR	●	1812-0625L186CR	●	1812-0625D186CR	■
NEW	0.0650	1/8	0.195	1 1/2	0.005	1812-0650.195CR	●	1812-0650L195CR	●	1812-0650D195CR	■
	0.0700	1/8	0.210	1 1/2	0.010	1812-0700.210CR	●	1812-0700L210CR	●	1812-0700D210CR	■
NEW	0.0750	1/8	0.225	1 1/2	0.005	1812-0750.225CR	●	1812-0750L225CR	●	1812-0750D225CR	■
NEW	0.0781 (5/64)	1/8	0.117	1 1/2	0.005	1812-0781.117CR	●	1812-0781L117CR	●	1812-0781D117CR	■
NEW	0.0781 (5/64)	1/8	0.234	1 1/2	0.005	1812-0781.234CR	●	1812-0781L234CR	●	1812-0781D234CR	■
	0.0800	1/8	0.240	1 1/2	0.010	1812-0800.240CR	●	1812-0800L240CR	●	1812-0800D240CR	■
NEW	0.0850	1/8	0.255	1 1/2	0.005	1812-0850.255CR	●	1812-0850L255CR	●	1812-0850D255CR	■
	0.0900	1/8	0.270	1 1/2	0.010	1812-0900.270CR	●	1812-0900L270CR	●	1812-0900D270CR	■
NEW	0.0938 (3/32)	1/8	0.140	1 1/2	0.005	1812-0938.140CR	●	1812-0938L140CR	●	1812-0938D140CR	■
NEW	0.0938 (3/32)	1/8	0.279	1 1/2	0.005	1812-0938.279CR	●	1812-0938L279CR	●	1812-0938D279CR	■
NEW	0.0950	1/8	0.285	1 1/2	0.005	1812-0950.285CR	●	1812-0950L285CR	●	1812-0950D285CR	■
	0.1000	1/8	0.300	1 1/2	0.010	1812-1000.300CR	●	1812-1000L300CR	●	1812-1000D300CR	■
NEW	0.1250 (1/8)	1/8	0.500	1 1/2	0.005	1812-1250.500CR	●	1812-1250L500CR	●	1812-1250D500CR	■
NEW	0.1562 (5/32)	3/16	0.562	2	0.010	1812-1562.562CR	●	1812-1562L562CR	●	1812-1562D562CR	■
NEW	0.1875 (3/16)	3/16	0.625	2	0.010	1812-1875.625CR	●	1812-1875L625CR	●	1812-1875D625CR	■
NEW	0.2500 (1/4)	1/4	0.750	2 1/2	0.010	1812-2500.750CR	●	1812-2500L750CR	●	1812-2500D750CR	■

#### Corner Radius Tolerance

\*DLC is Amorphous Diamond

Diameter (D)	0.0150" - 0.0350"	0.0400" - 0.1000"	0.1250" - 0.1875"	0.2500"
+ / -	0.0010"	0.0015"	0.0020"	0.0030"

#### SERIES 1812 WORKPIECE MATERIAL

Coating	P Steel -30HRC	P Steel 30-40HRC	H Hardened Steel -55HRC	H Hardened Steel -68HRC	M Stainless Steel	K Cast Iron	N Aluminum	N Graphite	N Copper Alloy	N CFRP	N Plastic	N Thermoset Plastic	N High Density Plastic	S Nickel / Cobalt	S Titanium Alloy
AlTiN	★	★	★	☆	☆	☆								☆	☆
DLC							☆	★	☆	★	★	★			
Uncoated							☆	☆	☆	☆	☆	☆	☆		☆

★ : Priority ☆ : Applicable Materials

Symbol Descriptions Page vii

## 4 FLUTE

0.0156" - 0.2500" DIAMETER

STANDARD LENGTH  
STANDARD CORNER RADIUS END MILLS

Mirror Surface Finishes  
Sub Micron Grain Carbide

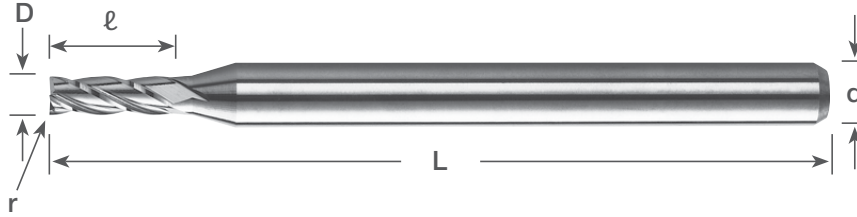

### STANDARD Corner Radius STANDARD Length (Inch Sizes)

	Dimensions (in)					Uncoated		AlTiN Coating		NEW DLC* Coating	
	D <sup>+0.000</sup> / <sub>-0.001</sub>	d	ℓ	L	r	Part Number	Stock	Part Number	Stock	Part Number	Stock
NEW	0.0156 (1/64)	1/8	0.045	1 1/2	0.005	1813-0156.045CR	●	1813-0156L045CR	●	1813-0156D045CR	■
NEW	0.0300	1/8	0.090	1 1/2	0.010	1813-0300.090CR	●	1813-0300L090CR	●	1813-0300D090CR	■
NEW	0.0312 (1/32)	1/8	0.093	1 1/2	0.010	1813-0312.093CR	●	1813-0312L093CR	●	1813-0312D093CR	■
NEW	0.0350	1/8	0.105	1 1/2	0.010	1813-0350.105CR	●	1813-0350L105CR	●	1813-0350D105CR	■
	0.0400	1/8	0.120	1 1/2	0.010	1813-0400.120CR	●	1813-0400L120CR	●	1813-0400D120CR	■
	0.0450	1/8	0.135	1 1/2	0.010	1813-0450.135CR	●	1813-0450L135CR	●	1813-0450D135CR	■
NEW	0.0469 (3/64)	1/8	0.071	1 1/2	0.010	1813-0469.071CR	●	1813-0469L071CR	●	1813-0469D071CR	■
NEW	0.0469 (3/64)	1/8	0.141	1 1/2	0.010	1813-0469.141CR	●	1813-0469L141CR	●	1813-0469D141CR	■
	0.0500	1/8	0.150	1 1/2	0.015	1813-0500.150CR	●	1813-0500L150CR	●	1813-0500D150CR	■
NEW	0.0550	1/8	0.165	1 1/2	0.010	1813-0550.165CR	●	1813-0550L165CR	●	1813-0550D165CR	■
	0.0600	1/8	0.180	1 1/2	0.015	1813-0600.180CR	●	1813-0600L180CR	●	1813-0600D180CR	■
NEW	0.0625 (1/16)	1/8	0.093	1 1/2	0.010	1813-0625.093CR	●	1813-0625L093CR	●	1813-0625D093CR	■
NEW	0.0625 (1/16)	1/8	0.186	1 1/2	0.010	1813-0625.186CR	●	1813-0625L186CR	●	1813-0625D186CR	■
NEW	0.0650	1/8	0.195	1 1/2	0.010	1813-0650.195CR	●	1813-0650L195CR	●	1813-0650D195CR	■
	0.0700	1/8	0.210	1 1/2	0.015	1813-0700.210CR	●	1813-0700L210CR	●	1813-0700D210CR	■
NEW	0.0750	1/8	0.225	1 1/2	0.010	1813-0750.225CR	●	1813-0750L225CR	●	1813-0750D225CR	■
NEW	0.0781 (5/64)	1/8	0.117	1 1/2	0.010	1813-0781.117CR	●	1813-0781L117CR	●	1813-0781D117CR	■
NEW	0.0781 (5/64)	1/8	0.234	1 1/2	0.010	1813-0781.234CR	●	1813-0781L234CR	●	1813-0781D234CR	■
	0.0800	1/8	0.240	1 1/2	0.015	1813-0800.240CR	●	1813-0800L240CR	●	1813-0800D240CR	■
NEW	0.0850	1/8	0.255	1 1/2	0.010	1813-0850.255CR	●	1813-0850L255CR	●	1813-0850D255CR	■
	0.0900	1/8	0.270	1 1/2	0.015	1813-0900.270CR	●	1813-0900L270CR	●	1813-0900D270CR	■
NEW	0.0938 (3/32)	1/8	0.140	1 1/2	0.010	1813-0938.140CR	●	1813-0938L140CR	●	1813-0938D140CR	■
NEW	0.0938 (3/32)	1/8	0.279	1 1/2	0.010	1813-0938.279CR	●	1813-0938L279CR	●	1813-0938D279CR	■
NEW	0.0950	1/8	0.285	1 1/2	0.010	1813-0950.285CR	●	1813-0950L285CR	●	1813-0950D285CR	■
	0.1000	1/8	0.300	1 1/2	0.015	1813-1000.300CR	●	1813-1000L300CR	●	1813-1000D300CR	■
NEW	0.1250 (1/8)	1/8	0.500	1 1/2	0.010	1813-1250.500CR	●	1813-1250L500CR	●	1813-1250D500CR	■
NEW	0.1562 (5/32)	3/16	0.562	2	0.015	1813-1562.562CR	●	1813-1562L562CR	●	1813-1562D562CR	■
NEW	0.1875 (3/16)	3/16	0.625	2	0.015	1813-1875.625CR	●	1813-1875L625CR	●	1813-1875D625CR	■
NEW	0.2500 (1/4)	1/4	0.750	2 1/2	0.015	1813-2500.750CR	●	1813-2500L750CR	●	1813-2500D750CR	■

#### Corner Radius Tolerance

\*DLC is Amorphous Diamond

Diameter (D)	0.0150" - 0.0350"	0.0400" - 0.1000"	0.1250" - 0.1875"	0.2500"
+ / -	0.0010"	0.0015"	0.0020"	0.0030"

#### SERIES 1813 WORKPIECE MATERIAL

Coating	P Steel ~30HRC	P Steel 30-40HRC	H Hardened Steel ~55HRC	H Hardened Steel ~68HRC	M Stainless Steel	K Cast Iron	N Aluminum	N Graphite	N Copper Alloy	N CFRP	N Plastic	N Thermoset Plastic	N High Density Plastic	S Nickel / Cobalt	S Titanium Alloy
AlTiN	★	★	★	☆	☆	☆								☆	☆
DLC							☆	★	☆	★	★	★			
Uncoated							☆	☆	☆	☆	☆	☆	☆		☆

★ : Priority ☆ : Applicable Materials

Symbol Descriptions Page vii

● : U.S. Stock Standard  
■ : NOT STOCKED - Call for Delivery  
▲ : Coming Soon

## 4 FLUTE NEW

0.0450" - 0.2500" DIAMETER

Mirror Surface Finishes

Sub Micron Grain Carbide

STANDARD LENGTH  
LARGE / X-LARGE CORNER RADIUS END MILLS

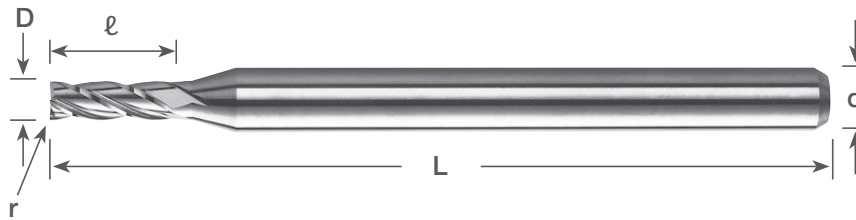

### LARGE Corner Radius STANDARD Length (Inch Sizes)

Dimensions (in)					Uncoated		AlTiN Coating		DLC* Coating	
D <sup>+0.000 -0.001</sup>	d	ℓ	L	r	Part Number	Stock	Part Number	Stock	Part Number	Stock
0.0450	1/8	0.135	1 1/2	0.015	1814-0450.135CR	●	1814-0450L135CR	●	1814-0450D135CR	■
0.0469 (3/64)	1/8	0.071	1 1/2	0.015	1814-0469.071CR	●	1814-0469L071CR	●	1814-0469D071CR	■
0.0469 (3/64)	1/8	0.141	1 1/2	0.015	1814-0469.141CR	●	1814-0469L141CR	●	1814-0469D141CR	■
0.0550	1/8	0.165	1 1/2	0.015	1814-0550.165CR	●	1814-0550L165CR	●	1814-0550D165CR	■
0.0625 (1/16)	1/8	0.093	1 1/2	0.015	1814-0625.093CR	●	1814-0625L093CR	●	1814-0625D093CR	■
0.0625 (1/16)	1/8	0.186	1 1/2	0.015	1814-0625.186CR	●	1814-0625L186CR	●	1814-0625D186CR	■
0.0650	1/8	0.195	1 1/2	0.015	1814-0650.195CR	●	1814-0650L195CR	●	1814-0650D195CR	■
0.0750	1/8	0.225	1 1/2	0.015	1814-0750.225CR	●	1814-0750L225CR	●	1814-0750D225CR	■
0.0781 (5/64)	1/8	0.117	1 1/2	0.015	1814-0781.117CR	●	1814-0781L117CR	●	1814-0781D117CR	■
0.0781 (5/64)	1/8	0.234	1 1/2	0.015	1814-0781.234CR	●	1814-0781L234CR	●	1814-0781D234CR	■
0.0850	1/8	0.255	1 1/2	0.015	1814-0850.255CR	●	1814-0850L255CR	●	1814-0850D255CR	■
0.0938 (3/32)	1/8	0.140	1 1/2	0.015	1814-0938.140CR	●	1814-0938L140CR	●	1814-0938D140CR	■
0.0938 (3/32)	1/8	0.279	1 1/2	0.015	1814-0938.279CR	●	1814-0938L279CR	●	1814-0938D279CR	■
0.0950	1/8	0.285	1 1/2	0.015	1814-0950.285CR	●	1814-0950L285CR	●	1814-0950D285CR	■
0.1250 (1/8)	1/8	0.500	1 1/2	0.015	1814-1250.500CR	●	1814-1250L500CR	●	1814-1250D500CR	■
0.1875 (3/16)	3/16	0.625	2	0.020	1814-1875.625CR	●	1814-1875L625CR	●	1814-1875D625CR	■
0.2500 (1/4)	1/4	0.750	2 1/2	0.020	1814-2500.750CR	●	1814-2500L750CR	●	1814-2500D750CR	■

\*DLC is Amorphous Diamond

### X-LARGE Corner Radius STANDARD Length (Inch Sizes)

Dimensions (in)					Uncoated		AlTiN Coating		DLC* Coating	
D <sup>+0.000 -0.001</sup>	d	ℓ	L	r	Part Number	Stock	Part Number	Stock	Part Number	Stock
0.0625 (1/16)	1/8	0.186	1 1/2	0.020	1816-0625.186CR	●	1816-0625L186CR	●	1816-0625D186CR	■
0.0781 (5/64)	1/8	0.150	1 1/2	0.020	1816-0781.234CR	●	1816-0781L234CR	●	1816-0781D234CR	■
0.0938 (3/32)	1/8	0.140	1 1/2	0.020	1816-0938.140CR	●	1816-0938L140CR	●	1816-0938D140CR	■
0.1250 (1/8)	1/8	0.500	1 1/2	0.020	1816-1250.500CR	●	1816-1250L500CR	●	1816-1250D500CR	■
0.1875 (3/16)	3/16	0.625	2	0.030	1816-1875.625CR	●	1816-1875L625CR	●	1816-1875D625CR	■
0.2500 (1/4)	1/4	0.750	2 1/2	0.030	1816-2500.750CR	●	1816-2500L750CR	●	1816-2500D750CR	■

\*DLC is Amorphous Diamond

#### Corner Radius Tolerance

Diameter (D)	0.0450" - 0.0950"	0.1250" - 0.1875"	0.2500" - 0.5000"
+ / -	0.0015"	0.0020"	0.0030"

#### SERIES 1814 / 1816 WORKPIECE MATERIAL

Coating	P Steel ~30HRC	P Steel 30~40HRC	H Hardened Steel ~55HRC	H Hardened Steel ~68HRC	M Stainless Steel	K Cast Iron	N Aluminum	N Graphite	N Copper Alloy	N CFRP	N Plastic	N Thermoset Plastic	N High Density Plastic	S Nickel / Cobalt	S Titanium Alloy
AlTiN	★	★	★	☆	☆	☆								☆	☆
DLC							☆	★	☆	★	★	★			
Uncoated							☆	☆	☆	☆	☆	☆	☆		☆

★ : Priority ☆ : Applicable Materials

Symbol Descriptions [Page vii](#)

## 4 FLUTE

0.0938" - 0.2500" DIAMETER

Mirror Surface Finishes

Sub Micron Grain Carbide

STANDARD LENGTH

XX-LARGE / XXX-LARGE CORNER RADIUS END MILLS

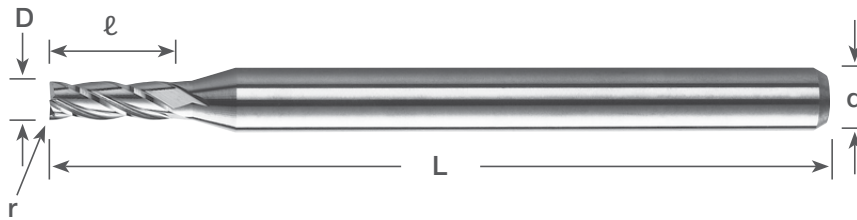

### XX-LARGE Corner Radius STANDARD Length (Inch Sizes)

Dimensions (in)					Uncoated		AlTiN Coating		NEW DLC* Coating	
D <sup>+0.000</sup> / <sub>-0.001</sub>	d	ℓ	L	r	Part Number	Stock	Part Number	Stock	Part Number	Stock
0.0938 (3/32)	1/8	0.279	1 1/2	0.030	1817-0938.279CR	●	1817-0938L279CR	●	1817-0938D279CR	■
0.1250 (1/8)	1/8	0.500	1 1/2	0.030	1817-1250.500CR	●	1817-1250L500CR	●	1817-1250D500CR	■
0.1562 (5/32)	3/16	0.562	2	0.030	1817-1562.562CR	●	1817-1562L562CR	●	1817-1562D562CR	■
0.1875 (3/16)	3/16	0.625	2	0.045	1817-1875.625CR	●	1817-1875L625CR	●	1817-1875D625CR	■
0.2500 (1/4)	1/4	0.750	2 1/2	0.045	1817-2500.750CR	●	1817-2500L750CR	●	1817-2500D750CR	■

\*DLC is Amorphous Diamond

### XXX-LARGE Corner Radius STANDARD Length (Inch Sizes)

Dimensions (in)					Uncoated		AlTiN Coating		NEW DLC* Coating	
D <sup>+0.000</sup> / <sub>-0.001</sub>	d	ℓ	L	r	Part Number	Stock	Part Number	Stock	Part Number	Stock
0.1875 (3/16)	3/16	0.625	2	0.060	1818-1875.625CR	●	1818-1875L625CR	●	1818-1875D625CR	■
0.2500 (1/4)	1/4	0.750	2 1/2	0.060	1818-2500.750CR	●	1818-2500L750CR	●	1818-2500D750CR	■

#### Corner Radius Tolerance

\*DLC is Amorphous Diamond

Diameter (D)	0.0938"	0.1250" - 0.1875"	0.2500"
+ / -	0.0015"	0.0020"	0.0030"

### SERIES 1817 / 1818 WORKPIECE MATERIAL

Coating	P Steel ~30HRC	P Steel 30-40HRC	H Hardened Steel ~55HRC	H Hardened Steel ~68HRC	M Stainless Steel	K Cast Iron	N Aluminum	N Graphite	N Copper Alloy	N CFRP	N Plastic	N Thermoset Plastic	N High Density Plastic	S Nickel / Cobalt	S Titanium Alloy
AlTiN	★	★	★	☆	☆	☆								☆	☆
DLC							☆	★	☆	★	★	★			
Uncoated							☆	☆	☆	☆	☆	☆	☆		☆

★ : Priority ☆ : Applicable Materials

Symbol Descriptions Page vii

● : U.S. Stock Standard  
 ■ : NOT STOCKED - Call for Delivery  
 ▲ : Coming Soon

(U.S.) 1.888.848.8449  
 (International) 001.714.428.3636  
 Pricing & Availability at [KyoceraPrecisionTools.com](http://KyoceraPrecisionTools.com)

DRILLS A  
 END MILLS B  
 ROUTERS C  
 THREAD MILLS & TAPS D  
 ENGRAVERS E  
 BORING BARS F  
 REAMERS G  
 SAWS H  
 TECHNICAL I  
 INDEX J



# 4 FLUTE APOLLO

0.1250" - 1.0000" DIAMETER

Variable Helix

Unequal Flutes to Reduce Chatter

Can be used as a rougher or a finishing tool

## VARIABLE HELIX END MILLS

Excellent for Alloy Steel, Nickel Inconel Alloys, Stainless Steel, and Carbon Steel

Excellent for Alloy Steel, Nickel Steel, Stainless Steel, and Carbon Steel

AlCrN Coating

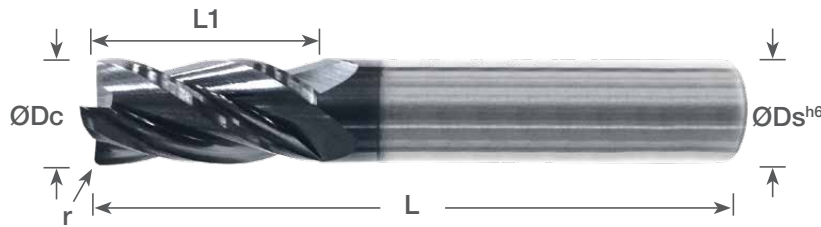

### STUB Length (Inch Sizes)

Dimensions (in)					AlCrN Coating	
ØDc	ØDs <sup>h6</sup>	L	L1	r	Part Number	Stock
0.2500 (1/4)	1/4	2	1/2	0.015 - 0.020	AP4-2500.500	●
0.3125 (5/16)	5/16	2	1/2	0.015 - 0.020	AP4-3125.500	●
0.3750 (3/8)	3/8	2	5/8	0.015 - 0.020	AP4-3750.625	●
0.5000 (1/2)	1/2	2-1/2	5/8	0.025 - 0.030	AP4-5000.625	●
0.6250 (5/8)	5/8	3	3/4	0.030 - 0.035	AP4-6250.750	●
0.7500 (3/4)	3/4	3	1	0.030 - 0.035	AP4-7500.1000	●

### STANDARD Length (Inch Sizes)

Dimensions (in)					AlCrN Coating	
ØDc	ØDs <sup>h6</sup>	L	L1	r	Part Number	Stock
0.1250 (1/8)	1/8	1-1/2	1/2	0.010 - 0.015	AP4-1250.500	●
0.1875 (3/16)	3/16	2	5/8	0.015 - 0.020	AP4-1875.625	●
0.2500 (1/4)	1/4	2-1/2	3/4	0.015 - 0.020	AP4-2500.750	●
0.3125 (5/16)	5/16	2-1/2	13/16	0.015 - 0.020	AP4-3125.813	●
0.3750 (3/8)	3/8	2-1/2	1	0.015 - 0.020	AP4-3750.1000	●
0.4375 (7/16)	7/16	2-3/4	1	0.015 - 0.020	AP4-4375.1000	●
0.5000 (1/2)	1/2	3	1	0.025 - 0.030	AP4-5000.1000	●
0.6250 (5/8)	5/8	3-1/2	1-1/4	0.030 - 0.035	AP4-6250.1250	●
0.7500 (3/4)	3/4	4	1-1/2	0.030 - 0.035	AP4-7500.1500	●
1.0000 (1)	1	4	1-1/2	0.030 - 0.035	AP4-10000.1500	●

### LONG Length (Inch Sizes)

Dimensions (in)					AlCrN Coating	
ØDc	ØDs <sup>h6</sup>	L	L1	r	Part Number	Stock
0.2500 (1/4)	1/4	3	1-1/8	0.015 - 0.020	AP4-2500.1125	●
0.3125 (5/16)	5/16	3	1-1/8	0.015 - 0.020	AP4-3125.1125	●
0.3750 (3/8)	3/8	3	1-1/8	0.015 - 0.020	AP4-3750.1125	●
0.5000 (1/2)	1/2	4	2	0.025 - 0.030	AP4-5000.2000	●
0.6250 (5/8)	5/8	5	2-1/4	0.030 - 0.035	AP4-6250.2250	●
0.7500 (3/4)	3/4	5	2-1/4	0.030 - 0.035	AP4-7500.2250	●

**Cutting Diameter Tolerances**  
 0.1250" - 0.2500" = +0.0000/-0.0012  
 0.3125" - 0.3750" = +0.0000/-0.0016  
 0.4375" - 1.0000" = +0.0000/-0.0020

SERIES AP4 WORKPIECE MATERIAL															
Coating	P	P	H	H	M	K	N	N	N	N	N	S	S		
	Steel ~30HRC	Steel 30-40HRC	Hardened Steel ~55HRC	Hardened Steel ~68HRC	Stainless Steel	Cast Iron	Aluminum	Graphite	Copper Alloy	CFRP	Plastic	Thermoset Plastic	High Density Plastic	Nickel / Cobalt	Titanium Alloy
AlCrN	☆	☆	★	★	★	☆			☆					★	★

★ : Priority ☆ : Applicable Materials

Symbol Descriptions Page vii

# 4 FLUTE APOLLO

3mm - 25mm DIAMETER

Variable Helix

Unequal Flutes to Reduce Chatter

Can be used as a rougher or a finishing tool

## VARIABLE HELIX END MILLS

Excellent for Alloy Steel, Nickel Inconel Alloys, Stainless Steel, and Carbon Steel

Excellent for Alloy Steel, Nickel Steel, Stainless Steel, and Carbon Steel

AICrN Coating

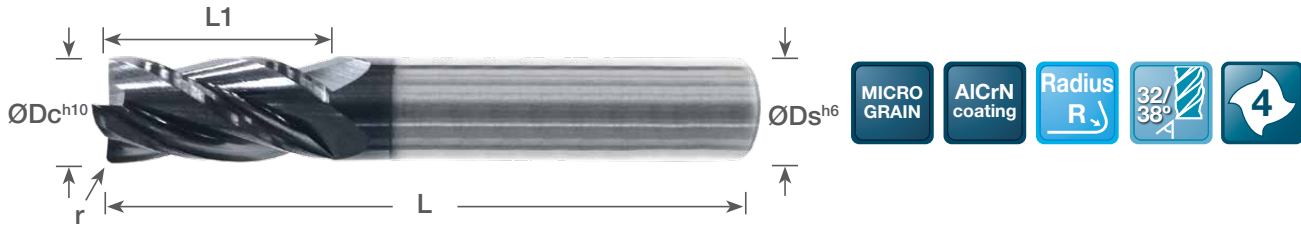

### STUB Length (Metric Sizes)

Dimensions (mm)					AICrN Coating	
ØDc <sup>h10</sup>	ØDs <sup>h6</sup>	L	L1	r	Part Number	Stock
3	3	38	6	0.4	AP4M-1181.236	●
6	6	50	10	0.4	AP4M-2362.394	●
8	8	50	12	0.4	AP4M-3150.472	●
10	10	50	12	0.4	AP4M-3937.787	●
12	12	63	16	0.7	AP4M-4724.630	●
16	16	89	20	0.7	AP4M-6299.787	●
20	20	100	22	0.7	AP4M-7874.866	●

### STANDARD Length (Metric Sizes)

Dimensions (mm)					AICrN Coating	
ØDc <sup>h10</sup>	ØDs <sup>h6</sup>	L	L1	r	Part Number	Stock
4	4	50	14	0.4	AP4M-1575.551	●
6	6	63	20	0.4	AP4M-2362.787	●
8	8	63	20	0.4	AP4M-3150.787	●
10	10	70	25	0.4	AP4M-3937.984	●
12	12	75	25	0.6	AP4M-4724.984	●
16	16	89	32	0.7	AP4M-6299.1260	●
20	20	100	38	0.7	AP4M-7874.1496	●
25	25	100	38	0.7	AP4M-9843.1496	●

### LONG Length (Metric Sizes)

Dimensions (mm)					AICrN Coating	
ØDc <sup>h10</sup>	ØDs <sup>h6</sup>	L	L1	r	Part Number	Stock
6	6	75	25	0.4	AP4M-2362.984	●
8	8	75	25	0.4	AP4M-3150.984	●
10	10	75	30	0.4	AP4M-3937.1181	●
12	12	100	50	0.6	AP4M-4724.1969	●
14	14	125	50	0.6	AP4M-5511.1969	●
16	16	125	50	0.7	AP4M-6299.1969	●
18	18	125	50	0.7	AP4M-7087.1969	●
20	20	125	50	0.8	AP4M-7874.1969	●
25	25	125	50	0.8	AP4M-9843.1969	●

SERIES AP4M WORKPIECE MATERIAL															
Coating	P	P	H	H	M	K	N	N	N	N	N	S	S		
	Steel ~30HRC	Steel 30-40HRC	Hardened Steel ~55HRC	Hardened Steel ~68HRC	Stainless Steel	Cast Iron	Aluminum	Graphite	Copper Alloy	CFRP	Plastic	Thermoset Plastic	High Density Plastic	Nickel / Cobalt	Titanium Alloy
AICrN	☆	☆	★	★	★	☆			☆					★	★

★ : Priority ☆ : Applicable Materials

Symbol Descriptions Page vii

● : U.S. Stock Standard  
 ■ : NOT STOCKED - Call for Delivery  
 ▲ : Coming Soon

(U.S.) 1.888.848.8449  
 (International) 001.714.428.3636  
 Pricing & Availability at [KyoceraPrecisionTools.com](http://KyoceraPrecisionTools.com)

DRILLS A  
 END MILLS B  
 ROUTERS C  
 THREAD MILLS & TAPS D  
 ENGRAVERS E  
 BORING BARS F  
 REAMERS G  
 SAWS H  
 TECHNICAL I  
 INDEX J

## 5 FLUTE

1.00mm - 6.00mm DIAMETER

Mirror Surface Finishes

Sub Micron Grain Carbide

STANDARD LENGTH  
HIGH HELIX CORNER RADIUS END MILLS

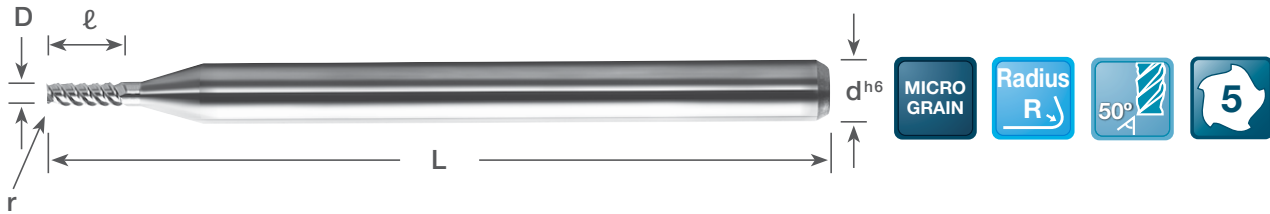

### HIGH HELIX Corner Radius STANDARD Length (Inch Sizes)

D	Dimensions (mm)					Uncoated		AlTiN Coating	
	D <sup>+0.00mm</sup> / <sub>-0.02mm</sub>	d <sup>h6</sup>	ℓ	L	r	Part Number	Stock	Part Number	Stock
1.00		3	3.00	38	0.10	1905-0394.118R	●	1905-0394L118R	●
1.50		3	4.50	38	0.15	1905-0591.177R	●	1905-0591L177R	●
2.00		3	6.00	38	0.20	1905-0787.236R	●	1905-0787L236R	●
2.50		3	7.50	38	0.25	1905-0984.295R	●	1905-0984L295R	●
3.00		3	9.00	38	0.30	1905-1181.354R	●	1905-1181L354R	●
3.50		6	12.00	50	0.35	1905-1378.473R	●	1905-1378L473R	●
4.00		5	12.00	50	0.40	1905-1575.473R	●	1905-1575L473R	●
4.50		6	15.00	50	0.45	1905-1772.590R	●	1905-1772L590R	●
5.00		5	15.00	50	0.50	1905-1968.590R	●	1905-1968L590R	●
5.50		6	15.00	50	0.55	1905-2165.709R	●	1905-2165L709R	●
6.00		6	18.00	50	0.60	1905-2362.709R	●	1905-2362L709R	●

#### Corner Radius Tolerance

Diameter (D)	1.00mm - 6.00mm
+ / -	0.03mm

### SERIES 1905 WORKPIECE MATERIAL

Coating	P Steel ~30HRC	P Steel 30-40HRC	H Hardened Steel ~55HRC	H Hardened Steel ~68HRC	M Stainless Steel	K Cast Iron	N Aluminum	N Graphite	N Copper Alloy	N CFRP	N Plastic	N Thermoset Plastic	N High Density Plastic	S Nickel / Cobalt	S Titanium Alloy
AlTiN	★	★	★	☆	☆	☆								☆	☆
Uncoated							☆	☆	☆	☆	☆	☆	☆		☆

★ : Priority ☆ : Applicable Materials

Symbol Descriptions [Page vii](#)

# 5 FLUTE APOLLO

VARIABLE HELIX END MILLS

0.2500" - 1.0000" DIAMETER

Variable Helix

Unequal Flutes to Reduce Chatter

Can be used as a rougher or a finishing tool

Excellent for Alloy Steel, Nickel Steel, Stainless Steel, and Carbon Steel

AlCrN Coating

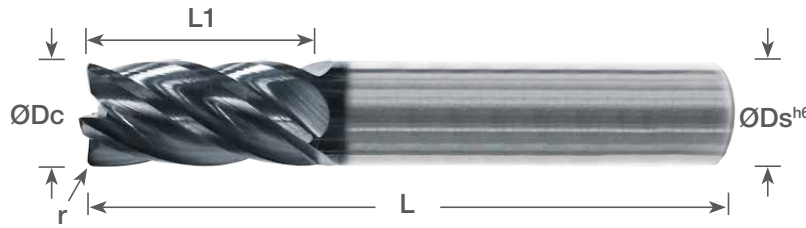

## STANDARD Length (Inch Sizes)

Dimensions (in)					AlCrN Coating	
ØDc	ØDs <sup>h6</sup>	L	L1	r	Part Number	Stock
0.2500 (1/4)	1/4	2-1/2	3/4	0.015 - 0.020	AP5-2500.750	●
0.3750 (3/8)	3/8	2-1/2	1	0.015 - 0.020	AP5-3750.1000	●
0.5000 (1/2)	1/2	3	1	0.025 - 0.030	AP5-5000.1000	●
0.6250 (5/8)	5/8	3-1/2	1-1/4	0.030 - 0.035	AP5-6250.1250	●
0.7500 (3/4)	3/4	4	1-1/2	0.030 - 0.035	AP5-7500.1500	●
1.0000 (1)	1	4	1-1/2	0.030 - 0.035	AP5-10000.1500	●

**Cutting Diameter Tolerances**  
 0.2500" = +0.0000/-0.0012  
 0.3750" = +0.0000/-0.0016  
 0.5000" - 1.0000" = +0.0000/-0.0020

DRILLS **A**

END MILLS **B**

ROUTERS **C**

THREAD MILLS & TAPS **D**

ENGRAVERS **E**

BORING BARS **F**

REAMERS **G**

SAWS **H**

TECHNICAL **I**

INDEX **J**

SERIES AP5 WORKPIECE MATERIAL															
Coating	P	P	H	H	M	K	N	N	N	N	N	N	S	S	
	Steel ~30HRC	Steel 30-40HRC	Hardened Steel ~55HRC	Hardened Steel ~68HRC	Stainless Steel	Cast Iron	Aluminum	Graphite	Copper Alloy	CFRP	Plastic	Thermoset Plastic	High Density Plastic	Nickel / Cobalt	Titanium Alloy
AlCrN	☆	☆	★	★	★	☆			☆					☆	☆

★ : Priority ☆ : Applicable Materials

Symbol Descriptions [Page vii](#)

● : U.S. Stock Standard  
 ■ : NOT STOCKED - Call for Delivery  
 ▲ : Coming Soon

4.00mm - 25.00mm DIAMETER

Variable Helix

Unequal Flutes to Reduce Chatter

Can be used as a rougher or a finishing tool

Excellent for Alloy Steel, Nickel Steel, Stainless Steel, and Carbon Steel

AlCrN Coating

## 5 FLUTE APOLLO

VARIABLE HELIX END MILLS

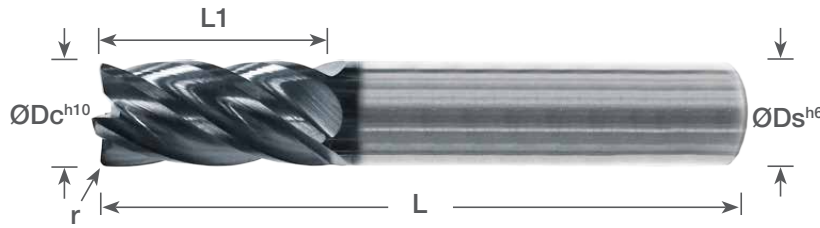

### STANDARD Length (Metric Sizes)

Dimensions (mm)					AlCrN Coating	
ØDc <sup>h10</sup>	ØDs <sup>h6</sup>	L	L1	r	Part Number	Stock
4	4	51	14	0.4	AP5M-1575.551	●
6	6	63	20	0.4	AP5M-2362.787	●
8	8	63	20	0.4	AP5M-3150.787	●
10	10	70	25	0.4	AP5M-3937.984	●
12	12	75	25	0.6	AP5M-4724.984	●
16	16	89	32	0.7	AP5M-6299.1260	●
20	20	100	38	0.7	AP5M-7874.1496	●
25	25	100	38	0.7	AP5M-9843.1496	●

- A DRILLS
- B END MILLS
- C ROUTERS
- D THREAD MILLS & TAPS
- E ENGRAVERS
- F BORING BARS
- G REAMERS
- H SAWS
- I TECHNICAL
- J INDEX

SERIES AP5M WORKPIECE MATERIAL															
Coating	P Steel ~30HRC	P Steel 30-40HRC	H Hardened Steel ~55HRC	H Hardened Steel ~68HRC	M Stainless Steel	K Cast Iron	N Aluminum	N Graphite	N Copper Alloy	N CFRP	N Plastic	N Thermoset Plastic	N High Density Plastic	S Nickel / Cobalt	S Titanium Alloy
AlCrN	☆	☆	★	★	★	☆			☆					☆	☆

★ : Priority ☆ : Applicable Materials

Symbol Descriptions [Page vii](#)

## VULCAN

COMPRESSION END MILL  
FOR ROUTING COMPOSITES

0.2500" - 0.5000" DIAMETER  
6.00mm - 12.00mm DIAMETER

No Delamination of Carbon Fiber Composite  
Sharp, Clean Cutting Performance in Profiling Operations  
Capable of Center Cutting for Initial Plunge into the Workpiece  
High Performance CVD Diamond Coating



### Inch Sizes

Dimensions (in)					No. of Flutes	CVD Diamond Coating	
ØDc <sup>+0.000"</sup> <sup>-0.003"</sup>	ØDs <sup>h6</sup>	L1	*L2	L3		Part Number	Stock
0.2500 (1/4)	1/4	2 1/2	1	0.175	4	1890-2500V1000	●
0.3125 (5/16)	5/16	2 1/2	1	0.220	4	1890-3125V1000	●
0.3750 (3/8)	3/8	2 1/2	1 1/8	0.265	6	1890-3750V1125	●
0.5000 (1/2)	1/2	3 1/2	1 1/2	0.360	8	1890-5000V1500	●

\*L2 dimensions refers to the length of cut.

### Metric Sizes

Dimensions (mm)					No. of Flutes	CVD Diamond Coating	
ØDc <sup>+0.00mm</sup> <sup>-0.08mm</sup>	ØDs <sup>h6</sup>	L1	*L2	L3		Part Number	Stock
6	6	63	25	4.10	4	1890-2362V709	●
8	8	63	25	5.58	4	1890-3150V984	●
10	10	63	28	7.05	6	1890-3937V984	●
12	12	89	38	8.60	8	1890-4724V1496	●

\*L2 dimensions refers to the length of cut.

DRILLS A  
END MILLS B  
ROUTERS C  
THREAD MILLS & TAPS D  
ENGRAVERS E  
BORING BARS F  
REAMERS G  
SAWS H  
TECHNICAL I  
INDEX J

VULCAN WORKPIECE MATERIAL															
Coating	P	P	H	H	M	N	N	N	N	N	N	N	S	S	
	Steel ~30HRC	Steel 30-40HRC	Hardened Steel ~55HRC	Hardened Steel ~68HRC	Stainless Steel	Carbon	Graphite	CFRP	AFRP	GFRP	Plastic	Machinable Glass	Machinable Ceramic	Nickel / Cobalt	Titanium Alloy
CVD Diamond						★	★	★	★	★	★	★	★		

★ : Priority ☆ : Applicable Materials

Symbol Descriptions Page vii

● : U.S. Stock Standard  
■ : NOT STOCKED - Call for Delivery  
▲ : Coming Soon

(U.S.) 1.888.848.8449  
(International) 001.714.428.3636  
Pricing & Availability at [KyoceraPrecisionTools.com](http://KyoceraPrecisionTools.com)

## 1/8" SHANK

CHAMFER MILLS

**30° - 120° ANGLES**

Mirror Surface Finishes

Sub Micron Grain Carbide

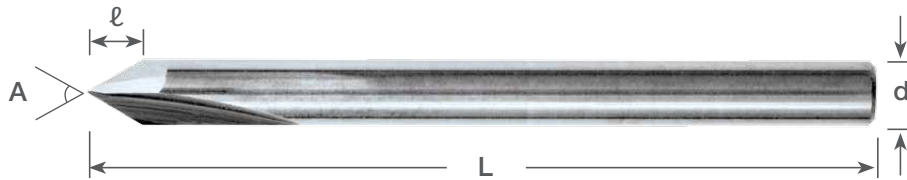

### 30° - 120° Angles

Included Angle A (+/- 1°)	Side Angle (+/- 1°)	Dimensions (in)			Uncoated		AlTiN Coating	
		ℓ	d	L	Part Number	Stock	Part Number	Stock
30°	15°	0.230	1/8	1 1/2	CM-030.230	●	CM-030L230	●
45°	22.5°	0.150	1/8	1 1/2	CM-045.150	●	CM-045L150	●
50°	25°	0.130	1/8	1 1/2	CM-050.130	●	CM-050L130	●
60°	30°	0.105	1/8	1 1/2	CM-060.105	●	CM-060L105	●
82°	41°	0.070	1/8	1 1/2	CM-082.070	●	CM-082L070	●
90°	45°	0.060	1/8	1 1/2	CM-090.060	●	CM-090L060	●
100°	50°	0.050	1/8	1 1/2	CM-100.050	●	CM-100L050	●
118°	59°	0.036	1/8	1 1/2	CM-118.036	●	CM-118L036	●
120°	60°	0.035	1/8	1 1/2	CM-120.035	●	CM-120L035	●

- A DRILLS
- B END MILLS
- C ROUTERS
- D THREAD MILLS & TAPS
- E ENGRAVERS
- F BORING BARS
- G REAMERS
- H SAWS
- I TECHNICAL
- J INDEX

SERIES CM WORKPIECE MATERIAL															
Coating	P Steel ~30HRC	P Steel 30-40HRC	H Hardened Steel ~55HRC	H Hardened Steel ~68HRC	M Stainless Steel	K Cast Iron	N Aluminum	N Graphite	N Copper Alloy	N CFRP	N Plastic	N Thermoset Plastic	N High Density Plastic	S Nickel / Cobalt	S Titanium Alloy
AlTiN	★	★	★	☆	☆	☆								☆	☆
Uncoated	☆	☆	☆	☆	☆	☆	★		★				☆		☆

★ : Priority ☆ : Applicable Materials

Symbol Descriptions [Page vii](#)



# METRIC SHANK

CHAMFER MILLS

60°, 90°, 120° ANGLES

Mirror Surface Finishes

Sub Micron Grain Carbide

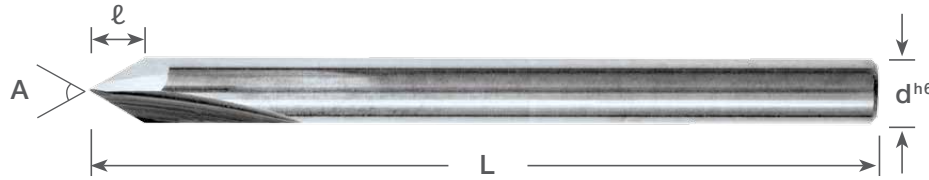

## 60° Angle

Included Angle A (+/- 1°)	Side Angle (+/- 1°)	Dimensions (mm)			Uncoated		AlTiN Coating	
		ℓ	d <sup>h6</sup>	L	Part Number	Stock	Part Number	Stock
60°	15°	2.5	3.00	38	CMM-1181.060	●	CMM-1181L060	●
60°	15°	5.2	6.00	50	CMM-2362.060	●	CMM-2362L060	●
60°	15°	6.9	8.00	59	CMM-3150.060	●	CMM-3150L060	●
60°	15°	8.6	10.00	60	CMM-3937.060	●	CMM-3937L060	●
60°	15°	10.3	12.00	70	CMM-4724.060	●	CMM-4724L060	●

## 90° Angle

Included Angle A (+/- 1°)	Side Angle (+/- 1°)	Dimensions (mm)			Uncoated		AlTiN Coating	
		ℓ	d <sup>h6</sup>	L	Part Number	Stock	Part Number	Stock
90°	45°	1.5	3.00	38	CMM-1181.090	●	CMM-1181L090	●
90°	45°	3.0	6.00	50	CMM-2362.090	●	CMM-2362L090	●
90°	45°	4.0	8.00	59	CMM-3150.090	●	CMM-3150L090	●
90°	45°	5.0	10.00	60	CMM-3937.090	●	CMM-3937L090	●
90°	45°	6.0	12.00	70	CMM-4724.090	●	CMM-4724L090	●

## 120° Angle

Included Angle A (+/- 1°)	Side Angle (+/- 1°)	Dimensions (mm)			Uncoated		AlTiN Coating	
		ℓ	d <sup>h6</sup>	L	Part Number	Stock	Part Number	Stock
120°	60°	0.8	3.00	38	CMM-1181.120	●	CMM-1181L120	●
120°	60°	1.7	6.00	50	CMM-2362.120	●	CMM-2362L120	●
120°	60°	2.3	8.00	59	CMM-3150.120	●	CMM-3150L120	●
120°	60°	2.8	10.00	60	CMM-3937.120	●	CMM-3937L120	●
120°	60°	3.4	12.00	70	CMM-4724.120	●	CMM-4724L120	●

SERIES CMM WORKPIECE MATERIAL															
Coating	P	P	H	H	M	K	N	N	N	N	N	N	S	S	
	Steel ~30HRC	Steel 30-40HRC	Hardened Steel ~55HRC	Hardened Steel ~68HRC	Stainless Steel	Cast Iron	Aluminum	Graphite	Copper Alloy	CFRP	Plastic	Thermoset Plastic	High Density Plastic	Nickel / Cobalt	Titanium Alloy
AlTiN	★	★	★	☆	☆	☆	☆	☆	☆	☆	☆	☆	☆	☆	☆
Uncoated	☆	☆	☆	☆	☆	☆	★	☆	☆	☆	☆	☆	☆	☆	☆

★ : Priority ☆ : Applicable Materials

Symbol Descriptions [Page vii](#)

- : U.S. Stock Standard
- : NOT STOCKED - Call for Delivery
- ▲ : Coming Soon

(U.S.) 1.888.848.8449  
 (International) 001.714.428.3636  
 Pricing & Availability at [KyoceraPrecisionTools.com](http://KyoceraPrecisionTools.com)

DRILLS **A**

END MILLS **B**

ROUTERS **C**

THREAD MILLS & TAPS **D**

ENGRAVERS **E**

BORING BARS **F**

REAMERS **G**

SAWS **H**

TECHNICAL **I**

INDEX **J**

<b>A</b>	DRILLS
<b>B</b>	END MILLS
<b>C</b>	ROUTERS
<b>D</b>	THREAD MILLS & TAPS
<b>E</b>	ENGRAVERS
<b>F</b>	BORING BARS
<b>G</b>	REAMERS
<b>H</b>	SAWS
<b>I</b>	TECHNICAL
<b>J</b>	INDEX

★ : Priority ☆ : Applicable Materials

Symbol Descriptions [Page vii](#)



# ROUTERS

## C1 - C6

### DIAMOND PATTERN ROUTERS C2 - C5

SERIES 2120	1/32" - 1/4" Dia.	Up Cut	C2
SERIES 2120	0.80mm - 8.00mm Dia.	Up Cut	C3
SERIES 2121	1/32" - 1/4" Dia.	Down Cut	C4
SERIES 2121	0.80mm - 8.00mm Dia.	Down Cut	C5

### CHIPBREAKER PATTERN ROUTERS C6

SERIES 2320	1/32" - 1/8" Dia.	Up Cut	C6
SERIES 2320	0.80mm - 8.00mm Dia.	Up Cut	C6

# UP CUT

DIAMOND PATTERN ROUTER BITS  
CFRP, FIBERGLASS, AND COMPOSITE MATERIALS

**1/32" - 1/4" DIAMETER**  
Sub Micron Grain Carbide  
Chips Exhausted Upwards  
DLC is Amorphous Diamond

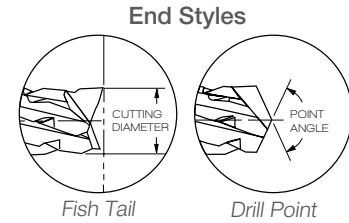

## UP CUT (Inch Sizes)

Dimensions (in)				End Style	Uncoated		DLC* Coating		CVD Diamond	
D	d	ℓ	L		Part Number	Stock	Part Number	Stock	Part Number	Stock
1/32	1/8	0.255	1 1/2	Fish Tail	2120-0312.255F	●	2120-0312D255F	●	2120-0312V255F	●
1/32	1/8	0.255	1 1/2	Drill Point	2120-0312.255D	●	2120-0312D255D	●	2120-0312V255D	●
3/64	1/8	0.255	1 1/2	Fish Tail	2120-0469.255F	●	2120-0469D255F	●	2120-0469V255F	●
3/64	1/8	0.255	1 1/2	Drill Point	2120-0469.255D	●	2120-0469D255D	●	2120-0469V255D	●
1/16	1/8	0.255	1 1/2	Fish Tail	2120-0625.255F	●	2120-0625D255F	●	2120-0625V255F	●
1/16	1/8	0.255	1 1/2	Drill Point	2120-0625.255D	●	2120-0625D255D	●	2120-0625V255D	●
3/32	1/8	0.395	1 1/2	Fish Tail	2120-0938.395F	●	2120-0938D395F	●	2120-0938V395F	●
3/32	1/8	0.395	1 1/2	Drill Point	2120-0938.395D	●	2120-0938D395D	●	2120-0938V395D	●
1/8	1/8	0.500	1 1/2	Fish Tail	2120-1250.500F	●	2120-1250D500F	●	2120-1250V500F	●
1/8	1/8	0.500	1 1/2	Drill Point	2120-1250.500D	●	2120-1250D500D	●	2120-1250V500D	●
3/16	3/16	0.625	2	Fish Tail	2120-1875.2625F	●	2120-1875D2625F	●	2120-1875V2625F	●
3/16	3/16	0.625	2	Drill Point	2120-1875.2625D	●	2120-1875D2625D	●	2120-1875V2625D	●
1/4	1/4	0.750	2	Fish Tail	2120-2500.2750F	●	2120-2500D2750F	●	2120-2500V2750F	●
1/4	1/4	0.750	2	Drill Point	2120-2500.2750D	●	2120-2500D2750D	●	2120-2500V2750D	●
1/4	1/4	0.750	2 1/2	Fish Tail	2120-2500.3750F	●	2120-2500D3750F	●	2120-2500V3750F	●
1/4	1/4	0.750	2 1/2	Drill Point	2120-2500.3750D	●	2120-2500D3750D	●	2120-2500V3750D	●
1/4	1/4	1.000	3	Fish Tail	2120-2500.4100F	●	2120-2500D4100F	●	2120-2500V4100F	●
1/4	1/4	1.000	3	Drill Point	2120-2500.4100D	●	2120-2500D4100D	●	2120-2500V4100D	●

\*DLC is Amorphous Diamond

SERIES 2120 WORKPIECE MATERIAL															
Coating	P Steel ~30HRC	P Steel 30-40HRC	H Hardened Steel ~55HRC	H Hardened Steel ~68HRC	M Stainless Steel	K Cast Iron	N Aluminum	N Graphite	N Copper Alloy	N CFRP	N Plastic	N Thermoset Plastic	N High Density Plastic	S Nickel / Cobalt	S Titanium Alloy
CVD Diamond							☆	★		★					
DLC							☆	☆		☆					
Uncoated							☆		★	★	☆	☆	☆		

★ : Priority ☆ : Applicable Materials

Symbol Descriptions [Page vii](#)

## UP CUT

DIAMOND PATTERN ROUTER BITS  
CFRP, FIBERGLASS, AND COMPOSITE MATERIALS

**0.80mm - 8.00mm DIAMETER**

Sub Micron Grain Carbide

Chips Exhausted Upwards

DLC is Amorphous Diamond

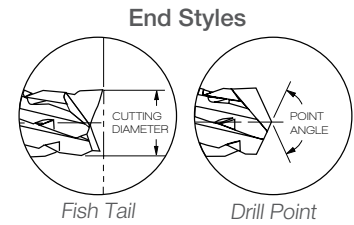

### UP CUT (Metric Sizes)

Dimensions (mm)				End Style	Uncoated		DLC* Coating		CVD Diamond	
D	dh6	l	L		Part Number	Stock	Part Number	Stock	Part Number	Stock
0.80	3	4	38	Fish Tail	2120-0315.157F	●	2120-0315D157F	●	2120-0315V157F	●
0.80	3	4	38	Drill Point	2120-0315.157D	●	2120-0315D157D	●	2120-0315V157D	●
1.00	3	5	38	Fish Tail	2120-0394.197F	●	2120-0394D197F	●	2120-0394V197F	●
1.00	3	5	38	Drill Point	2120-0394.197D	●	2120-0394D197D	●	2120-0394V197D	●
1.50	3	8	38	Fish Tail	2120-0591.315F	●	2120-0591D315F	●	2120-0591V315F	●
1.50	3	8	38	Drill Point	2120-0591.315D	●	2120-0591D315D	●	2120-0591V315D	●
2.00	3	9	38	Fish Tail	2120-0787.354F	●	2120-0787D354F	●	2120-0787V354F	●
2.00	3	9	38	Drill Point	2120-0787.354D	●	2120-0787D354D	●	2120-0787V354D	●
3.00	3	12	38	Fish Tail	2120-1181.472F	●	2120-1181D472F	●	2120-1181V472F	●
3.00	3	12	38	Drill Point	2120-1181.472D	●	2120-1181D472D	●	2120-1181V472D	●
4.00	4	15	40	Fish Tail	2120-1575.591F	●	2120-1575D591F	●	2120-1575V591F	●
4.00	4	15	40	Drill Point	2120-1575.591D	●	2120-1575D591D	●	2120-1575V591D	●
5.00	5	20	50	Fish Tail	2120-1968.787F	●	2120-1968D787F	●	2120-1968V787F	●
5.00	5	20	50	Drill Point	2120-1968.787D	●	2120-1968D787D	●	2120-1968V787D	●
6.00	6	20	50	Fish Tail	2120-2362.787F	●	2120-2362D787F	●	2120-2362V787F	●
6.00	6	20	50	Drill Point	2120-2362.787D	●	2120-2362D787D	●	2120-2362V787D	●
8.00	8	25	63	Fish Tail	2120-3150.984F	●	2120-3150D984F	●	2120-3150V984F	●
8.00	8	25	63	Drill Point	2120-3150.984D	●	2120-3150D984D	●	2120-3150V984D	●

\*DLC is Amorphous Diamond

SERIES 2120 WORKPIECE MATERIAL															
Coating	P Steel ~30HRC	P Steel 30-40HRC	H Hardened Steel ~55HRC	H Hardened Steel ~68HRC	M Stainless Steel	K Cast Iron	N Aluminum	N Graphite	N Copper Alloy	N CFRP	N Plastic	N Thermoset Plastic	N High Density Plastic	S Nickel / Cobalt	S Titanium Alloy
CVD Diamond							☆	★		★					
DLC							☆	☆		☆					
Uncoated							☆		★	★	☆	☆	☆		

★ : Priority ☆ : Applicable Materials

Symbol Descriptions [Page vii](#)

● : U.S. Stock Standard  
■ : NOT STOCKED - Call for Delivery  
▲ : Coming Soon

(U.S.) 1.888.848.8449  
(International) 001.714.428.3636  
Pricing & Availability at [KyoceraPrecisionTools.com](http://KyoceraPrecisionTools.com)

DRILLS **A**  
 END MILLS **B**  
 ROUTERS **C**  
 THREAD MILLS & TAPS **D**  
 ENGRAVERS **E**  
 BORING BARS **F**  
 REAMERS **G**  
 SAWS **H**  
 TECHNICAL **I**  
 INDEX **J**

## DOWN CUT

DIAMOND PATTERN ROUTER BITS  
CFRP, FIBERGLASS, AND COMPOSITE MATERIALS

**1/32" - 1/4" DIAMETER**

Sub Micron Grain Carbide  
Chips Exhausted Downwards  
DLC is Amorphous Diamond

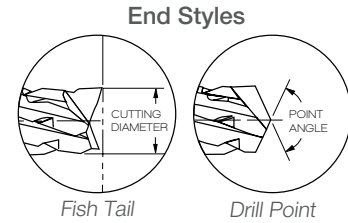

### DOWN CUT (Inch Sizes)

	Dimensions (in)				End Style	Uncoated		DLC* Coating		CVD Diamond	
	D	d	ℓ	L		Part Number	Stock	Part Number	Stock	Part Number	Stock
	1/32	1/8	0.255	1 1/2	Fish Tail	2121-0312.255F	●	2121-0312D255F	●	2121-0312V255F	●
	1/32	1/8	0.255	1 1/2	Drill Point	2121-0312.255D	●	2121-0312D255D	●	2121-0312V255D	●
	3/64	1/8	0.255	1 1/2	Fish Tail	2121-0469.255F	●	2121-0469D255F	●	2121-0469V255F	●
	3/64	1/8	0.255	1 1/2	Drill Point	2121-0469.255D	●	2121-0469D255D	●	2121-0469V255D	●
	1/16	1/8	0.255	1 1/2	Fish Tail	2121-0625.255F	●	2121-0625D255F	●	2121-0625V255F	●
	1/16	1/8	0.255	1 1/2	Drill Point	2121-0625.255D	●	2121-0625D255D	●	2121-0625V255D	●
	3/32	1/8	0.395	1 1/2	Fish Tail	2121-0938.395F	●	2121-0938D395F	●	2121-0938V395F	●
	3/32	1/8	0.395	1 1/2	Drill Point	2121-0938.395D	●	2121-0938D395D	●	2121-0938V395D	●
	1/8	1/8	0.500	1 1/2	Fish Tail	2121-1250.500F	●	2121-1250D500F	●	2121-1250V500F	●
	1/8	1/8	0.500	1 1/2	Drill Point	2121-1250.500D	●	2121-1250D500D	●	2121-1250V500D	●
	3/16	3/16	0.625	2	Fish Tail	2121-1875.2625F	●	2121-1875D2625F	●	2121-1875V2625F	●
	3/16	3/16	0.625	2	Drill Point	2121-1875.2625D	●	2121-1875D2625D	●	2121-1875V2625D	●
	1/4	1/4	0.750	2	Fish Tail	2121-2500.2750F	●	2121-2500D2750F	●	2121-2500V2750F	●
	1/4	1/4	0.750	2	Drill Point	2121-2500.2750D	●	2121-2500D2750D	●	2121-2500V2750D	●
	1/4	1/4	0.750	2 1/2	Fish Tail	2121-2500.3750F	●	2121-2500D3750F	●	2121-2500V3750F	●
	1/4	1/4	0.750	2 1/2	Drill Point	2121-2500.3750D	●	2121-2500D3750D	●	2121-2500V3750D	●
	1/4	1/4	1.000	3	Fish Tail	2121-2500.4100F	●	2121-2500D4100F	●	2121-2500V4100F	●
	1/4	1/4	1.000	3	Drill Point	2121-2500.4100D	●	2121-2500D4100D	●	2121-2500V4100D	●

\*DLC is Amorphous Diamond

SERIES 2121 WORKPIECE MATERIAL															
Coating	P Steel ~30HRC	P Steel 30-40HRC	H Hardened Steel ~55HRC	H Hardened Steel ~68HRC	M Stainless Steel	K Cast Iron	N Aluminum	N Graphite	N Copper Alloy	N CFRP	N Plastic	N Thermoset Plastic	N High Density Plastic	S Nickel / Cobalt	S Titanium Alloy
CVD Diamond							☆	★		★					
DLC							☆	☆		☆					
Uncoated							☆		★	★	☆	☆	☆		

★ : Priority ☆ : Applicable Materials

Symbol Descriptions [Page vii](#)

## DOWN CUT

DIAMOND PATTERN ROUTER BITS  
CFRP, FIBERGLASS, AND COMPOSITE MATERIALS

**0.80mm - 8.00mm DIAMETER**

Sub Micron Grain Carbide  
Chips Exhausted Downwards  
DLC is Amorphous Diamond

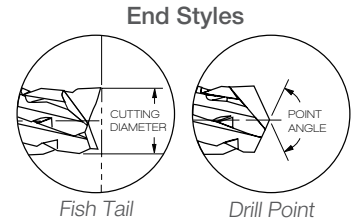

### DOWN CUT (Metric Sizes)

Dimensions (mm)				End Style	Uncoated		DLC* Coating		CVD Diamond	
D	dh6	l	L		Part Number	Stock	Part Number	Stock	Part Number	Stock
0.80	3	4	38	Fish Tail	2121-0315.157F	●	2121-0315D157F	●	2121-0315V157F	●
0.80	3	4	38	Drill Point	2121-0315.157D	●	2121-0315D157D	●	2121-0315V157D	●
1.00	3	5	38	Fish Tail	2121-0394.197F	●	2121-0394D197F	●	2121-0394V197F	●
1.00	3	5	38	Drill Point	2121-0394.197D	●	2121-0394D197D	●	2121-0394V197D	●
1.50	3	8	38	Fish Tail	2121-0591.315F	●	2121-0591D315F	●	2121-0591V315F	●
1.50	3	8	38	Drill Point	2121-0591.315D	●	2121-0591D315D	●	2121-0591V315D	●
2.00	3	9	38	Fish Tail	2121-0787.354F	●	2121-0787D354F	●	2121-0787V354F	●
2.00	3	9	38	Drill Point	2121-0787.354D	●	2121-0787D354D	●	2121-0787V354D	●
3.00	3	12	38	Fish Tail	2121-1181.472F	●	2121-1181D472F	●	2121-1181V472F	●
3.00	3	12	38	Drill Point	2121-1181.472D	●	2121-1181D472D	●	2121-1181V472D	●
4.00	4	15	40	Fish Tail	2121-1575.591F	●	2121-1575D591F	●	2121-1575V591F	●
4.00	4	15	40	Drill Point	2121-1575.591D	●	2121-1575D591D	●	2121-1575V591D	●
5.00	5	20	50	Fish Tail	2121-1968.787F	●	2121-1968D787F	●	2121-1968V787F	●
5.00	5	20	50	Drill Point	2121-1968.787D	●	2121-1968D787D	●	2121-1968V787D	●
6.00	6	20	50	Fish Tail	2121-2362.787F	●	2121-2362D787F	●	2121-2362V787F	●
6.00	6	20	50	Drill Point	2121-2362.787D	●	2121-2362D787D	●	2121-2362V787D	●
8.00	8	25	63	Fish Tail	2121-3150.984F	●	2121-3150D984F	●	2121-3150V984F	●
8.00	8	25	63	Drill Point	2121-3150.984D	●	2121-3150D984D	●	2121-3150V984D	●

\*DLC is Amorphous Diamond

SERIES 2121 WORKPIECE MATERIAL															
Coating	P	P	H	H	M	K	N	N	N	N	N	N	S	S	
	Steel ~30HRC	Steel 30-40HRC	Hardened Steel ~55HRC	Hardened Steel ~68HRC	Stainless Steel	Cast Iron	Aluminum	Graphite	Copper Alloy	CFRP	Plastic	Thermoset Plastic	High Density Plastic	Nickel / Cobalt	Titanium Alloy
CVD Diamond							☆	★		★					
DLC							☆	☆		☆					
Uncoated							☆		★	★	☆	☆	☆		

★ : Priority ☆ : Applicable Materials

Symbol Descriptions [Page vii](#)

● : U.S. Stock Standard  
■ : NOT STOCKED - Call for Delivery  
▲ : Coming Soon

(U.S.) 1.888.848.8449  
(International) 001.714.428.3636  
Pricing & Availability at [KyoceraPrecisionTools.com](http://KyoceraPrecisionTools.com)

DRILLS **A**  
 END MILLS **B**  
 ROUTERS **C**  
 THREAD MILLS & TAPS **D**  
 ENGRAVERS **E**  
 BORING BARS **F**  
 REAMERS **G**  
 SAWS **H**  
 TECHNICAL **I**  
 INDEX **J**



# UP CUT

CHIPBREAKER PATTERN ROUTER BITS  
CFRP, FIBERGLASS, AND COMPOSITE MATERIALS

**1/32" - 1/8" DIAMETER**  
**0.80mm - 8.00mm DIAMETER**  
Sub Micron Grain Carbide  
Chips Exhausted Upwards  
For Finer Part Edge Finishes  
DLC is Amorphous Diamond

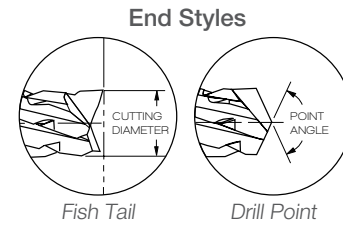

## UP CUT (Inch Sizes)

Dimensions (in)				End Style	Uncoated		DLC* Coating		CVD Diamond	
D	d	ℓ	L		Part Number	Stock	Part Number	Stock	Part Number	Stock
1/32	1/8	0.255	1 1/2	Fish Tail	2320-0312.255F	●	2320-0312D255F	●	2320-0312V255F	●
1/32	1/8	0.255	1 1/2	Drill Point	2320-0312.255D	●	2320-0312D255D	●	2320-0312V255D	●
3/64	1/8	0.255	1 1/2	Fish Tail	2320-0469.255F	●	2320-0469D255F	●	2320-0469V255F	●
3/64	1/8	0.255	1 1/2	Drill Point	2320-0469.255D	●	2320-0469D255D	●	2320-0469V255D	●
1/16	1/8	0.255	1 1/2	Fish Tail	2320-0625.255F	●	2320-0625D255F	●	2320-0625V255F	●
1/16	1/8	0.255	1 1/2	Drill Point	2320-0625.255D	●	2320-0625D255D	●	2320-0625V255D	●
3/32	1/8	0.395	1 1/2	Fish Tail	2320-0938.395F	●	2320-0938D395F	●	2320-0938V395F	●
3/32	1/8	0.395	1 1/2	Drill Point	2320-0938.395D	●	2320-0938D395D	●	2320-0938V395D	●
1/8	1/8	0.500	1 1/2	Fish Tail	2320-1250.500F	●	2320-1250D500F	●	2320-1250V500F	●
1/8	1/8	0.500	1 1/2	Drill Point	2320-1250.500D	●	2320-1250D500D	●	2320-1250V500D	●

\*DLC is Amorphous Diamond

## UP CUT (Metric Sizes)

Dimensions (mm)				End Style	Uncoated		DLC* Coating		CVD Diamond	
D	d <sup>h6</sup>	ℓ	L		Part Number	Stock	Part Number	Stock	Part Number	Stock
0.80	3	4	38	Fish Tail	2320-0315.157F	●	2320-0315D157F	●	2320-0315V157F	●
0.80	3	4	38	Drill Point	2320-0315.157D	●	2320-0315D157D	●	2320-0315V157D	●
1.00	3	5	38	Fish Tail	2320-0394.197F	●	2320-0394D197F	●	2320-0394V197F	●
1.00	3	5	38	Drill Point	2320-0394.197D	●	2320-0394D197D	●	2320-0394V197D	●
1.50	3	8	38	Fish Tail	2320-0591.315F	●	2320-0591D315F	●	2320-0591V315F	●
1.50	3	8	38	Drill Point	2320-0591.315D	●	2320-0591D315D	●	2320-0591V315D	●
2.00	3	9	38	Fish Tail	2320-0787.354F	●	2320-0787D354F	●	2320-0787V354F	●
2.00	3	9	38	Drill Point	2320-0787.354D	●	2320-0787D354D	●	2320-0787V354D	●
3.00	3	12	38	Fish Tail	2320-1181.472F	●	2320-1181D472F	●	2320-1181V472F	●
3.00	3	12	38	Drill Point	2320-1181.472D	●	2320-1181D472D	●	2320-1181V472D	●
4.00	4	15	40	Fish Tail	2320-1575.591F	●	2320-1575D591F	●	2320-1575V591F	●
4.00	4	15	40	Drill Point	2320-1575.591D	●	2320-1575D591D	●	2320-1575V591D	●
5.00	5	20	50	Fish Tail	2320-1968.787F	●	2320-1968D787F	●	2320-1968V787F	●
5.00	5	20	50	Drill Point	2320-1968.787D	●	2320-1968D787D	●	2320-1968V787D	●
6.00	6	20	50	Fish Tail	2320-2362.787F	●	2320-2362D787F	●	2320-2362V787F	●
6.00	6	20	50	Drill Point	2320-2362.787D	●	2320-2362D787D	●	2320-2362V787D	●
8.00	8	25	63	Fish Tail	2320-3150.984F	●	2320-3150D984F	●	2320-3150V984F	●
8.00	8	25	63	Drill Point	2320-3150.984D	●	2320-3150D984D	●	2320-3150V984D	●

\*DLC is Amorphous Diamond

SERIES 2320 WORKPIECE MATERIAL															
Coating	P Steel ~30HRC	P Steel 30-40HRC	H Hardened Steel ~55HRC	H Hardened Steel ~68HRC	M Stainless Steel	K Cast Iron	N Aluminum	N Graphite	N Copper Alloy	N CFRP	N Plastic	N Thermoset Plastic	N High Density Plastic	S Nickel / Cobalt	S Titanium Alloy
CVD Diamond							☆	★		★					
DLC							☆	☆		☆					
Uncoated							☆		★	★	☆	☆	☆		

★ : Priority ☆ : Applicable Materials

Symbol Descriptions [Page vii](#)

# D

# THREAD MILLS & TAPS

## D1 - D47

### THREAD MILLS D2

SERIES 98M	M0.5 - M8 Threads	D2
------------	-------------------	----

### SPECIAL TAPS D3 - D22

TAPS STYLE GUIDE	D4 - D5
------------------	---------

INCH SIZES	D6 - D15
------------	----------

METRIC SIZES	D16 - D21
--------------	-----------

### SPECIAL TAPS ENGINEERING DATA D22 - D47

TAP MARKING SYSTEM	D22
--------------------	-----

UNJ PROFILE	D23
-------------	-----

TAP CLASSES & SIZE	D24 - D25
--------------------	-----------

TERMS ILLUSTRATIONS	D26 - D27
---------------------	-----------

TERMS DEFINITIONS	D28 - D29
-------------------	-----------

THREAD FORMING TAPS	D30
---------------------	-----

RECOMMENDATIONS FOR INCH THREAD CLASSES	D31
---	-----

RECOMMENDATIONS FOR METRIC THREAD CLASSES	D32 - D33
---	-----------

INCH TAP FORMULAS	D34
-------------------	-----

METRIC TAP FORMULAS	D35
---------------------	-----

MATERIALS / TREATMENTS / FLUIDS	D36
---------------------------------	-----

SPEEDS & FEEDS	D37
----------------	-----

TAP DIMENSIONS	D38 - D47
----------------	-----------

# STANDARD LENGTH

**M0.5 - M8 THREADS**

Mirror Surface Finishes

Sub Micron Grain Carbide

Excellent for Titanium Dental Implants

MICRO THREAD MILLS  
SINGLE POINT THREAD MILLING



## STANDARD Length

Metric Thread	Number of Flutes	Dimensions (mm)				Uncoated		AlTiN Coating	
		D	d <sup>h6</sup>	ℓ	L	Part Number	Stock	Part Number	Stock
M0.5 X 0.125	2	0.30	3	1.00	38	98M05-0125.2FA1	●	98M05-0125L2FA1	●
M0.6 X 0.15	2	0.37	3	1.00	38	98M06-0150.2FA1	●	98M06-0150L2FA1	●
M0.7 X 0.175	2	0.45	3	2.00	38	98M07-0175.2FA1	●	98M07-0175L2FA1	●
M0.8 X 0.20	2	0.51	3	2.00	38	98M08-0200.2FA1	●	98M08-0200L2FA1	●
M0.9 X 0.25	2	0.58	3	2.00	38	98M09-0225.2FA1	●	98M09-0225L2FA1	●
M1.0 X 0.25	2	0.65	3	5.00	38	98M10-0250.2FA1	●	98M10-0250L2FA1	●
M1.1 X 0.25	4	0.75	3	5.00	38	98M11-0250.4FA1	●	98M11-0250L4FA1	●
M1.2 X 0.25	4	0.85	3	5.00	38	98M12-0250.4FA1	●	98M12-0250L4FA1	●
M1.4 X 0.30	4	1.00	3	5.00	38	98M14-0300.4FA1	●	98M14-0300L4FA1	●
M1.6 X 0.35	4	1.15	3	7.00	38	98M16-0350.4FA1	●	98M16-0350L4FA1	●
M1.8 X 0.35	4	1.35	3	7.00	38	98M18-0350.4FA1	●	98M18-0350L4FA1	●
M2.0 X 0.40	4	1.50	3	7.00	38	98M20-0400.4FA1	●	98M20-0400L4FA1	●
M2.5 X 0.45	4	1.95	4	9.40	50	98M25-0450.4FB1	●	98M25-0450L4FB1	●
M3 X 0.5	4	2.40	4	9.40	50	98M30-0500.4FB1	●	98M30-0500L4FB1	●
M3.5 X 0.6	4	2.80	4	9.40	50	98M35-0600.4FB1	●	98M35-0600L4FB1	●
M4 X 0.7	4	3.10	6	12.70	64	98M40-0700.4FB1	●	98M40-0700L4FB1	●
M5 X 0.8	4	3.85	6	12.70	64	98M50-0800.4FB1	●	98M50-0800L4FB1	●
M6 X 1	4	4.65	6	12.70	64	98M60-1000.4FB1	●	98M60-1000L4FB1	●
M8 X 1.25	4	5.95	6	12.70	64	98M80-1250.4FB1	●	98M80-1250L4FB1	●

SERIES 98M WORKPIECE MATERIAL															
Coating	P Steel ~30HRC	P Steel 30-40HRC	H Hardened Steel ~55HRC	H Hardened Steel ~68HRC	M Stainless Steel	K Cast Iron	N Aluminum	N Graphite	N Copper Alloy	N CFRP	N Plastic	N Thermoset Plastic	N High Density Plastic	S Nickel / Cobalt	S Titanium Alloy
AlTiN	★	★	★	☆	☆	☆			☆						
Uncoated							☆		★	★	☆		☆		★

★ : Priority ☆ : Applicable Materials

Symbol Descriptions [Page vii](#)



# SPECIAL TAPS

PAGES D4 - D47

DRILLS	<b>A</b>
END MILLS	<b>B</b>
ROUTERS	<b>C</b>
THREAD MILLS & TAPS	<b>D</b>
ENGRAVERS	<b>E</b>
BORING BARS	<b>F</b>
REAMERS	<b>G</b>
SAWS	<b>H</b>
TECHNICAL	<b>I</b>
INDEX	<b>J</b>

# TAP STYLE GUIDE

A	DRILLS
B	END MILLS
C	ROUTERS
D	THREAD MILLS & TAPS
E	ENGRAVERS
F	BORING BARS
G	REAMERS
H	SAWS
I	TECHNICAL
J	INDEX



## HAND TAP #1

These standard style taps have straight flutes of a number specified as either standard or optional. Hand taps are for general purpose applications such as production tapping or hand tapping operations. Taper, plug and bottoming styles provide versatility in tough materials, blind and through holes.



## SPIRAL POINT TAP #2

As to general physical dimensions, spiral point taps are identical with the standard hand tap. However, the spiral point tap has the cutting face of the first few threads cut at a predetermined angle relative to the tap's axis angle to force the evacuation of chips ahead of the cutting action. This feature, plus the excellent shearing action of the flute, make spiral pointed taps ideal for production tapping of through holes. Typically, this type of tap has a shallower flute passage than conventional taps. This gives the spiral point tap more cross-sectional area, which means greater strength, allows higher tapping speeds, and requires less power to drive.



## S.T.I. TAP #3

S.T.I. (Screw Thread Insert) Taps are special taps for helical coil wire screw thread inserts, which provide positive means for protecting and strengthening tapped threads in any material. These STI taps are correctly sized to produce an internal thread that accommodates a helical coil wire screw thread insert. The insert, in turn, will accept a screw thread of the nominal size and pitch at final assembly. Screw thread inserts provide stronger tapped threads (stronger assemblies) due to a more balanced distribution of loads throughout the length of thread engagement.



## EXTENSION TAP #4

These taps are made to conventional tap dimensions, except that they have an extended shank to tap hard to reach or holes that are inaccessible with standard length taps. Thread length, shank diameter, and shank square are made to standard specifications listed on **Page 198**. Extension taps are available in both hand and spiral point styles, and in small shank style.



## THREAD FORMING TAP #5

These taps have no flutes except as optionally designed with one or more lubrication grooves. The thread form is lobed so there is a finite number of points contacting the work. This tap does not cut metal, so it is 'chipless', and consequently will not cause a chip problem. The tool forms the thread by extrusion, thus thread size can be closely maintained. The fluteless design allows high quality threads, faster tapping speeds, higher production, and generates no chips which simplifies tapping of blind bottoming holes (threads can be formed the full depth of the hole).



## SPIRAL FLUTED TAP #6

These taps, as the name implies, are made with spiral flutes instead of straight flutes. This spiral fluting feature aids in drawing chips out of a hole, or serves to bridge a gap inside the hole such as a keyway or cross-hole. Commonly available in slow spiral (25-30° helix angle) or fast spiral (45-60°).



## SMALL SHANK EXTENSION TAP #7

These taps are made to conventional tap dimensions, except that they have an extended shank to tap hard to reach inaccessible holes. Thread length and shank square are made to standard specifications listed on **Page 200**. These taps are designed with a smaller shank diameter. Extension taps are available in both hand and spiral point styles, and in small shank style.



## PIPE TAP #8

These taps are for producing standard straight or tapered pipe threads in a wide range of pipe connections. Manufactured with the appropriate design variations to cut specified pipe thread forms.



## PIPE INTERRUPTED THREAD TAP #9

These taps are for producing standard tapered pipe threads in a wide range of pipe connections. Manufactured with the appropriate design variations to cut specified pipe thread forms. Thread length, shank diameter, and square are made to standard specifications listed on **Page 204** (Standard Pipe Tap Dimensions). These pipe taps feature interrupted threads which have an odd number of lands with alternate teeth in the thread helix removed. The removal of every other tooth helps to break the chip and allows a greater supply of lubrication to reach the cutting teeth, reducing the incidence of torn threads. Ideal for pipe tapping non-ferrous metals, low carbon steel, as well as titanium and high hardness alloys.



## PIPE EXTENSION TAP #10

These taps are for producing standard straight or tapered pipe threads in a wide range of pipe connections. Manufactured with the appropriate design variations to cut specified pipe thread forms. These extension pipe taps have an extended shank to tap hard to reach or inaccessible holes. Thread length, shank diameter, and shank square are made to standard specifications listed on **Page 204** (Standard Pipe Tap Dimensions).



## PIPE EXTENSION INTERRUPTED THREAD TAP #11

These taps are for producing standard tapered pipe threads in a wide range of pipe connections. Manufactured with the appropriate design variations to cut specified pipe thread forms. These extension pipe taps have an extended shank to tap hard to reach or inaccessible holes. Thread length, shank diameter, and square are made to standard specifications listed on **Page 204** (Standard Pipe Tap Dimensions). These pipe extension taps feature interrupted threads which have an odd number of lands with alternate teeth in the thread helix removed. The removal of every other tooth helps to break the chip and allows a greater supply of lubrication to reach the cutting teeth, reducing the incidence of torn threads. Ideal for pipe tapping non-ferrous metals, low carbon steel, as well as titanium and high hardness alloys.



## ACME THREAD TAP #12

Acme screw threads were devised to allow rotary and transversing motion on machines; and are also used in jacks, valves, presses and other mechanisms where heavy loads are encountered. The acme thread is characterized by a 29° included angle. Acme taps typically require specialized engineering and design due to the nature and severity of cut required in producing Acme threads.

DRILLS	A
END MILLS	B
ROUTERS	C
THREAD MILLS & TAPS	D
ENGRAVERS	E
BORING BARS	F
REAMERS	G
SAWS	H
TECHNICAL	I
INDEX	J

# TAPS BY SIZE

- A DRILLS
- B END MILLS
- C ROUTERS
- D THREAD MILLS & TAPS
- E ENGRAVERS
- F BORING BARS
- G REAMERS
- H SAWS
- I TECHNICAL
- J INDEX

SIZE / DESCRIPTION	GH#	Class of Fit	No. of Flutes	EDP Number Plug	Stock	EDP Number Bottom	Stock	Style Page 164 - 165
--------------------	-----	--------------	---------------	-----------------	-------	-------------------	-------	----------------------

<b>#2-56 NC</b>								
<i>Recommended Hole Size based on 75% Thread = .0689"</i>								
SPIRAL POINT	4	-	2	14010	◆	-	-	See Page <a href="#">D4 (#2)</a>
SPIRAL POINT	5	-	2	14011	◆	-	-	See Page <a href="#">D4 (#2)</a>
SPIRAL POINT +.003	7	-	2	14012	◆	-	-	See Page <a href="#">D4 (#2)</a>

<b>#4-40 NC</b>								
<i>Recommended Hole Size based on 75% Thread = .0878"</i>								
SPIRAL POINT	3	-	2	14013	◆	-	-	See Page <a href="#">D4 (#2)</a>
SPIRAL POINT	4	-	2	14014	◆	-	-	See Page <a href="#">D4 (#2)</a>
SPIRAL POINT	5	-	2	14015	◆	-	-	See Page <a href="#">D4 (#2)</a>
+.005 SPIRAL POINT	11	PLATING	2	14016	◆	-	-	See Page <a href="#">D4 (#2)</a>
STI HAND TAP	1	3B	3	14017	◆	14018	◆	See Page <a href="#">D4 (#3)</a>

<b>#5-40 NC</b>								
<i>Recommended Hole Size based on 75% Thread = .1008"</i>								
+.005 SPIRAL POINT	11	PLATING	2	14019	◆	-	-	See Page <a href="#">D4 (#2)</a>

<b>#6-32 NC</b>								
<i>Recommended Hole Size based on 75% Thread = .1077"</i>								
L.H. SPIRAL POINT	3	2B	2	14020	◆	-	-	See Page <a href="#">D4 (#2)</a>
HAND TAP	5	-	3	14021	◆	14022	◆	See Page <a href="#">D4 (#1)</a>
+.003 SPIRAL POINT	7	-	2	14023	◆	-	-	See Page <a href="#">D4 (#2)</a>
+.005 HAND TAP	11	PLATING	3	14024	◆	14025	◆	See Page <a href="#">D4 (#1)</a>
+.005 SPIRAL POINT	11	PLATING	2	14026	◆	-	-	See Page <a href="#">D4 (#2)</a>
6" EXT SPIRAL POINT	3	2B	2	14027	◆	-	-	See Page <a href="#">D4 (#4)</a>

<b>#6-48 NS</b>								
<i>Recommended Hole Size based on 75% Thread = .118"</i>								
HAND TAP	2	3B	3	14028	◆	14029	◆	See Page <a href="#">D4 (#1)</a>
SPIRAL POINT	2	3B	2	14030	◆	-	-	See Page <a href="#">D4 (#2)</a>

<b>#8-32 NC</b>								
<i>Recommended Hole Size based on 75% Thread = .1337"</i> <i>THREAD FORMING TAP at 65% Thread = .1502"</i>								
+.003 HAND TAP	7	-	4	14031	◆	14032	◆	See Page <a href="#">D4 (#1)</a>
+.003 SPIRAL POINT	7	-	2	14033	◆	-	-	See Page <a href="#">D4 (#2)</a>
+.005 SPIRAL POINT	11	PLATING	2	14034	◆	-	-	See Page <a href="#">D4 (#2)</a>
6" EXT SPIRAL POINT	3	2B	2	14035	◆	-	-	See Page <a href="#">D4 (#4)</a>
THREAD FORMING TAP	3	3B	0	14036	◆	14037	◆	See Page <a href="#">D4 (#5)</a>
THREAD FORMING TAP	5	2B	0	14038	◆	14039	◆	See Page <a href="#">D4 (#5)</a>

<b>#8-40 NS</b>								
<i>Recommended Hole Size based on 75% Thread = .1398"</i>								
HAND TAP	2	3B	4	14040	◆	14041	◆	See Page <a href="#">D4 (#1)</a>
SPIRAL POINT	2	3B	2	14042	◆	-	-	See Page <a href="#">D4 (#2)</a>



SIZE / DESCRIPTION	GH#	Class of Fit	No. of Flutes	EDP Number Plug	Stock	EDP Number Bottom	Stock	Style Page 164 - 165
--------------------	-----	--------------	---------------	-----------------	-------	-------------------	-------	----------------------

DRILLS **A**

END MILLS **B**

ROUTERS **C**

THREAD MILLS & TAPS **D**

ENGRAVERS **E**

BORING BARS **F**

REAMERS **G**

SAWS **H**

TECHNICAL **I**

INDEX **J**

<b>#10-24 NC</b>								
Recommended Hole Size based on 75% Thread = .149"								
SPIRAL POINT	5	-	2	14043	◆	-	-	See Page <a href="#">D4 (#2)</a>
+.003 SPIRAL POINT	7	-	2	14044	◆	-	-	See Page <a href="#">D4 (#2)</a>
+.005 HAND TAP	11	PLATING	4	14045	◆	14046	◆	See Page <a href="#">D4 (#1)</a>
+.005 SPIRAL POINT	11	PLATING	2	14047	◆	-	-	See Page <a href="#">D4 (#2)</a>
4" EXT SPIRAL POINT	3	3B	2	14048	◆	-	-	See Page <a href="#">D4 (#4)</a>
6" EXT HAND TAP	3	3B	4	14049	◆	14050	◆	See Page <a href="#">D4 (#4)</a>
6" EXT SPIRAL POINT	3	3B	2	14051	◆	-	-	See Page <a href="#">D4 (#4)</a>
THREAD FORMING TAP	10	PLATING	0	14052	◆	14053	◆	See Page <a href="#">D4 (#5)</a>

<b>#10-32 NF</b>								
Recommended Hole Size based on 75% Thread = .1597"								
L.H. SPIRAL POINT	3	2B	2	14054	◆	-	-	See Page <a href="#">D4 (#2)</a>
HAND TAP	4	-	4	14055	◆	14056	◆	See Page <a href="#">D4 (#1)</a>
SPIRAL POINT	4	-	2	14057	◆	-	-	See Page <a href="#">D4 (#2)</a>
HAND TAP	5	-	4	14058	◆	14059	◆	See Page <a href="#">D4 (#1)</a>
SPIRAL POINT	5	-	2	14060	◆	-	-	See Page <a href="#">D4 (#2)</a>
+.003 HAND TAP	7	-	4	14061	◆	14062	◆	See Page <a href="#">D4 (#1)</a>
+.003 SPIRAL POINT	7	-	2	14063	◆	-	-	See Page <a href="#">D4 (#2)</a>
+.005 SPIRAL POINT	11	PLATING	2	14064	◆	-	-	See Page <a href="#">D4 (#2)</a>
4" EXT SPIRAL POINT	3	2B	2	14065	◆	-	-	See Page <a href="#">D4 (#4)</a>
6" EXT HAND TAP	3	2B	4	14066	◆	14067	◆	See Page <a href="#">D4 (#4)</a>
6" EXT SPIRAL POINT	3	2B	2	14068	◆	-	-	See Page <a href="#">D4 (#4)</a>
STI HAND TAP	2	3B	3	14069	◆	14070	◆	See Page <a href="#">D4 (#3)</a>

<b>#10-36 NS</b>								
Recommended Hole Size based on 75% Thread = .163"								
HAND TAP	2	3B	4	14071	◆	14072	◆	See Page <a href="#">D4 (#1)</a>

<b>#10-40 NS</b>								
Recommended Hole Size based on 75% Thread = .1658"								
SPIRAL POINT	2	3B	2	14073	◆	-	-	See Page <a href="#">D4 (#2)</a>

<b>#10-48 NS</b>								
Recommended Hole Size based on 75% Thread = .1700"								
HAND TAP	2	3B	4	14074	◆	14075	◆	See Page <a href="#">D4 (#1)</a>

<b>#10-56 NS</b>								
Recommended Hole Size based on 75% Thread = .1729"								
HAND TAP	2	3B	4	14076	◆	14077	◆	See Page <a href="#">D4 (#1)</a>

<b>.210-36 NS</b>								
Recommended Hole Size based on 75% Thread = .183"								
HAND TAP	3	3B	4	14078	◆	14079	◆	See Page <a href="#">D4 (#1)</a>

<b>#12-32 NEF</b>								
Recommended Hole Size based on 75% Thread = .1857"								
HAND TAP	3	3B	4	14080	◆	14081	◆	See Page <a href="#">D4 (#1)</a>
SPIRAL POINT	3	3B	2	14082	◆	-	-	See Page <a href="#">D4 (#2)</a>

◆ : Usually Ships in 24-48 Hours  
Depending on Size and Quantity

SIZE / DESCRIPTION	GH#	Class of Fit	No. of Flutes	EDP Number Plug	Stock	EDP Number Bottom	Stock	Style Page 164 - 165
<b>#14-24 NS</b>	<i>Recommended Hole Size based on 75% Thread = .201"</i>							
HAND TAP	3	3B	4	14083	◆	14084	◆	See Page <a href="#">D4 (#1)</a>
<b>1/16"-27 PIPE TAP NPSI NPSF NPT/F NPS</b>	<i>Recommended Hole Size: NPT/NPTF = .246"</i>							
NPT/F INT. THD	-	-	5	14085	◆	-	-	See Page <a href="#">D5 (#9)</a>
NPT/F 4" EXT TAPER	-	-	4	14086	◆	-	-	See Page <a href="#">D5 (#10)</a>
NPT/F 6" EXT TAPER	-	-	4	14087	◆	-	-	See Page <a href="#">D5 (#10)</a>
<b>1/8"-27 PIPE TAP NPSI NPSF NPT/F NPS</b>	<i>Recommended Hole Size: NPT/NPTF = .332" NPSF/NPSI = .3438"</i>							
NPT/F 4" EXT TAPER	-	-	4	14088	◆	-	-	See Page <a href="#">D5 (#10)</a>
NPT/F 6" EXT TAPER	-	-	4	14089	◆	-	-	See Page <a href="#">D5 (#10)</a>
NPT/F 6" EXT INT THD TAPER	-	-	5	14090	◆	-	-	See Page <a href="#">D5 (#11)</a>
NPSF EXT x 6"	-	-	4	14091	◆	-	-	See Page <a href="#">D5 (#10)</a>
NPSI STRAIGHT	-	-	4	14092	◆	-	-	See Page <a href="#">D5 (#8)</a>
<b>1/8"-28 55° WHITWORTH PIPE</b>	<i>Recommended Hole Size BSPT = .3281" / BSPP = .3438"</i>							
BSPT TAPER - MODIFIED	-	-	4	14093	◆	14094	◆	See Page <a href="#">D5 (#8)</a>
BSPP PARALLEL - MODIFIED	-	-	4	14095	◆	14096	◆	See Page <a href="#">D5 (#8)</a>
<b>1/4"-18 PIPE TAP NPSI NPSF NPT/F NPS</b>	<i>Recommended Hole Size: NPT/NPTF = .4375" NPSF / NPSI = .4375"</i>							
NPT/F 6" EXT TAPER	-	-	4	14097	◆	-	-	See Page <a href="#">D5 (#10)</a>
NPT/F 6" EXT INT THD TAPER	-	-	5	14098	◆	-	-	See Page <a href="#">D5 (#11)</a>
NPT/F 8" EXT TAPER	-	-	4	14099	◆	-	-	See Page <a href="#">D5 (#10)</a>
NPSF EXT x 6"	-	-	4	14100	◆	-	-	See Page <a href="#">D5 (#10)</a>
<b>1/4"-19 55° WHITWORTH PIPE</b>	<i>Recommended Hole Size: BSPT = .4375" / BSPP = .4531"</i>							
BSPT TAPER - MODIFIED	-	-	4	14101	◆	14102	◆	See Page <a href="#">D5 (#8)</a>
BSPP PARALLEL - MODIFIED	-	-	4	14103	◆	14104	◆	See Page <a href="#">D5 (#8)</a>
BSPP PARALLEL - FULL FORM	-	-	4	14105	◆	-	-	See Page <a href="#">D5 (#8)</a>
<b>1/4"-20 NC</b>	<i>Recommended Hole Size based on 75% Thread = .2015"</i>							
L.H. SPIRAL POINT	3	3B	2	14106	◆	-	-	See Page <a href="#">D4 (#2)</a>
+.003 HAND TAP	7	-	4	14107	◆	14108	◆	See Page <a href="#">D4 (#1)</a>
+.003 SPIRAL POINT	7	-	2	14109	◆	-	-	See Page <a href="#">D4 (#2)</a>
+.005 HAND TAP	11	PLATING	4	14110	◆	14111	◆	See Page <a href="#">D4 (#1)</a>
+.005 SPIRAL POINT	11	PLATING	2	14112	◆	-	-	See Page <a href="#">D4 (#2)</a>
4" EXT SP PT SM SHK	3	3B	2	14113	◆	-	-	See Page <a href="#">D5 (#7)</a>
4" EXT SPIRAL POINT	3	3B	2	14114	◆	-	-	See Page <a href="#">D4 (#4)</a>
6" EXT HAND TAP	3	3B	4	14115	◆	14116	◆	See Page <a href="#">D4 (#4)</a>
6" EXT SM SHK HAND	3	3B	4	14117	◆	14118	◆	See Page <a href="#">D5 (#7)</a>
6" EXT SPIRAL POINT	3	3B	2	14119	◆	-	-	See Page <a href="#">D4 (#4)</a>
6" EXT SP PT SM SHK	3	3B	2	14120	◆	-	-	See Page <a href="#">D5 (#7)</a>

SIZE / DESCRIPTION	GH#	Class of Fit	No. of Flutes	EDP Number Plug	Stock	EDP Number Bottom	Stock	Style Page 164 - 165
<b>1/4"-24 NS</b>								
Recommended Hole Size based on 75% Thread = .209"								
HAND TAP	3	3B	4	14121	◆	14122	◆	See Page <a href="#">D4 (#1)</a>
SPIRAL POINT	3	3B	2	14123	◆	-	-	See Page <a href="#">D4 (#2)</a>
<b>1/4"-28 NF</b>								
Recommended Hole Size based on 75% Thread = .2153" THREAD FORMING TAP at 65% Thread = .2342"								
L.H. SPIRAL POINT	3	3B	2	14124	◆	-	-	See Page <a href="#">D4 (#2)</a>
HAND TAP	5	-	4	14125	◆	14126	◆	See Page <a href="#">D4 (#1)</a>
+.003 HAND TAP	7	-	4	14127	◆	14128	◆	See Page <a href="#">D4 (#1)</a>
+.003 SPIRAL POINT	7	-	2	14129	◆	-	-	See Page <a href="#">D4 (#2)</a>
+.005 HAND TAP	11	PLATING	4	14130	◆	14131	◆	See Page <a href="#">D4 (#1)</a>
+.005 SPIRAL POINT	11	PLATING	2	14132	◆	-	-	See Page <a href="#">D4 (#2)</a>
6" EXT HAND TAP	3	3B	4	14133	◆	14134	◆	See Page <a href="#">D4 (#4)</a>
6" EXT SPIRAL POINT	3	3B	2	14135	◆	-	-	See Page <a href="#">D4 (#4)</a>
6" EXT SP PT SM SHK	3	3B	2	14136	◆	-	-	See Page <a href="#">D5 (#7)</a>
THREAD FORMING TAP	6	2B	0	14137	◆	14138	◆	See Page <a href="#">D4 (#5)</a>
<b>1/4"-32 NEF</b>								
Recommended Hole Size based on 75% Thread = .2197"								
HAND TAP	3	3B	4	14139	◆	14140	◆	See Page <a href="#">D4 (#1)</a>
SPIRAL POINT	3	3B	2	14141	◆	-	-	See Page <a href="#">D4 (#2)</a>
<b>1/4"-36 NS</b>								
Recommended Hole Size based on 75% Thread = .2230"								
HAND TAP	2	3B	4	14142	◆	14143	◆	See Page <a href="#">D4 (#1)</a>
SPIRAL POINT	2	3B	2	14144	◆	-	-	See Page <a href="#">D4 (#2)</a>
<b>1/4"-40 NS</b>								
Recommended Hole Size based on 75% Thread = .2258"								
HAND TAP	2	3B	4	14145	◆	14146	◆	See Page <a href="#">D4 (#1)</a>
SPIRAL POINT	2	3B	3	14147	◆	-	-	See Page <a href="#">D4 (#2)</a>
<b>1/4"-48 NS</b>								
Recommended Hole Size based on 75% Thread = .230"								
HAND TAP	2	3B	4	14148	◆	14149	◆	See Page <a href="#">D4 (#1)</a>
<b>1/4"-80 NS</b>								
Recommended Hole Size based on 75% Thread = .2379"								
HAND TAP	2	3B	4	14150	◆	14151	◆	See Page <a href="#">D4 (#1)</a>
<b>5/16"-18 NC</b>								
Recommended Hole Size based on 75% Thread = .2589"								
L.H. SPIRAL POINT	3	3B	2	14152	◆	-	-	See Page <a href="#">D4 (#2)</a>
+.005 SPIRAL POINT	11	PLATING	2	14153	◆	-	-	See Page <a href="#">D4 (#2)</a>
4" EXT SPIRAL POINT	3	3B	2	14154	◆	-	-	See Page <a href="#">D4 (#4)</a>
4" EXT SP PT SM SHK	3	3B	2	14155	◆	-	-	See Page <a href="#">D5 (#7)</a>
6" EXT HAND TAP	3	3B	4	14156	◆	14157	◆	See Page <a href="#">D4 (#4)</a>
6" EXT SPIRAL POINT	3	3B	2	14158	◆	-	-	See Page <a href="#">D4 (#4)</a>
6" EXT SP PT SM SHK	3	3B	2	14159	◆	-	-	See Page <a href="#">D5 (#7)</a>

DRILLS	<b>A</b>
END MILLS	<b>B</b>
ROUTERS	<b>C</b>
THREAD MILLS & TAPS	<b>D</b>
ENGRAVERS	<b>E</b>
BORING BARS	<b>F</b>
REAMERS	<b>G</b>
SAWS	<b>H</b>
TECHNICAL	<b>I</b>
INDEX	<b>J</b>

SIZE / DESCRIPTION		GH#	Class of Fit	No. of Flutes	EDP Number Plug	Stock	EDP Number Bottom	Stock	Style Page 164 - 165	
A	DRILLS	<b>5/16"-20 NS</b>		Recommended Hole Size based on 75% Thread = .264"						
		HAND TAP	3	3B	4	14160	◆	14161	◆	See Page <a href="#">D4 (#1)</a>
B	END MILLS	<b>5/16"-24 NF</b>		Recommended Hole Size based on 75% Thread = .2715" for STI = .3281"						
		L.H. SPIRAL POINT	3	3B	2	14162	◆	-	-	See Page <a href="#">D4 (#2)</a>
		HAND TAP	5	-	4	14163	◆	14164	◆	See Page <a href="#">D4 (#1)</a>
		6" EXT SP PT SM SHK	3	3B	2	14165	◆	-	-	See Page <a href="#">D5 (#7)</a>
C	ROUTERS	STI SPIRAL POINT	2	3B	3	14166	◆	-	-	See Page <a href="#">D4 (#3)</a>
		<b>5/16"-32 NEF</b>		Recommended Hole Size based on 75% Thread = .2822"						
D	THREAD MILLS & TAPS	HAND TAP	3	3B	4	14167	◆	14168	◆	See Page <a href="#">D4 (#1)</a>
		SPIRAL POINT	3	3B	2	14169	◆	-	-	See Page <a href="#">D4 (#2)</a>
		HAND TAP	5	-	4	14170	◆	14171	◆	See Page <a href="#">D4 (#1)</a>
E	ENGRAVERS	<b>3/8"-16 NC</b>		Recommended Hole Size based on 75% Thread = .3144"						
		L.H. SPIRAL POINT	3	3B	3	14172	◆	-	-	See Page <a href="#">D4 (#2)</a>
		SPIRAL POINT	3	3B	2	14173	◆	-	-	See Page <a href="#">D4 (#2)</a>
		+.005 SPIRAL POINT	11	PLATING	3	14174	◆	-	-	See Page <a href="#">D4 (#2)</a>
		4" EXT SP PT SM SHK	3	3B	3	14175	◆	-	-	See Page <a href="#">D5 (#7)</a>
		4" EXT SPIRAL POINT	3	3B	3	14176	◆	-	-	See Page <a href="#">D4 (#4)</a>
		6" EXT HAND TAP	3	3B	4	14177	◆	14178	◆	See Page <a href="#">D4 (#4)</a>
		6" EXT SM SHANK	3	3B	4	14179	◆	14180	◆	See Page <a href="#">D5 (#7)</a>
		6" EXT SPIRAL POINT	3	3B	3	14181	◆	-	-	See Page <a href="#">D4 (#4)</a>
		6" EXT SP PT SM SHK	3	3B	3	14182	◆	-	-	See Page <a href="#">D5 (#7)</a>
F	BORING BARS	6" EXT SPIRAL POINT	5	2B	3	14183	◆	-	-	See Page <a href="#">D4 (#4)</a>
		<b>3/8"-18 PIPE TAP NPSI NPSF NPT/F NPS</b>		Recommended Hole Size: NPT = .5625" / NPTF = .5781" NPSF/NPSI = .5781"						
G	REAMERS	NPT/F 6" EXT TAPER	-	-	4	14184	◆	-	-	See Page <a href="#">D5 (#10)</a>
		NPT/F 6" EXT INT THD TAPER	-	-	5	14185	◆	-	-	See Page <a href="#">D5 (#11)</a>
		NPSF 6" EXTENSION	-	-	4	14186	◆	-	-	See Page <a href="#">D5 (#10)</a>
H	SAWS	<b>3/8"-19 55° WHITWORTH PIPE</b>		Recommended Hole Size: BSPT = .5781" / BSPP = .5938"						
		BSPT TAPER - MODIFIED	-	-	4	14187	◆	14188	◆	See Page <a href="#">D5 (#8)</a>
		BSPP PARALLEL - MODIFIED	-	-	4	14189	◆	14190	◆	See Page <a href="#">D5 (#8)</a>
		BSPT TAPER - FULL FORM	-	-	4	14191	◆	-	-	See Page <a href="#">D5 (#8)</a>
I	TECHNICAL	<b>3/8"-20 NS</b>		Recommended Hole Size based on 75% Thread = .3265"						
		HAND TAP	3	3B	4	14192	◆	14193	◆	See Page <a href="#">D4 (#1)</a>
J	INDEX									

SIZE / DESCRIPTION	GH#	Class of Fit	No. of Flutes	EDP Number Plug	Stock	EDP Number Bottom	Stock	Style Page 164 - 165
<b>3/8"-24 NF</b>								
Recommended Hole Size based on 75% Thread = .3340"								
L.H. SPIRAL POINT	3	3B	3	14194	◆	-	-	See Page <a href="#">D4 (#2)</a>
HAND TAP	5	-	4	14195	◆	14196	◆	See Page <a href="#">D4 (#1)</a>
+.003 SPIRAL POINT	7	-	3	14197	◆	-	-	See Page <a href="#">D4 (#2)</a>
+.005 HAND TAP	11	PLATING	4	14198	◆	14199	◆	See Page <a href="#">D4 (#1)</a>
+.005 SPIRAL POINT	11	PLATING	3	14200	◆	-	-	See Page <a href="#">D4 (#2)</a>
6" EXT HAND TAP	3	3B	4	14201	◆	14202	◆	See Page <a href="#">D4 (#4)</a>
<b>3/8"-27 NS</b>								
Recommended Hole Size based on 75% Thread = .339"								
HAND TAP	3	3B	4	14203	◆	14204	◆	See Page <a href="#">D4 (#1)</a>
<b>3/8"-32 NEF</b>								
Recommended Hole Size based on 75% Thread = .3447"								
HAND TAP	3	3B	4	14205	◆	14206	◆	See Page <a href="#">D4 (#1)</a>
SPIRAL POINT	3	3B	3	14207	◆	-	-	See Page <a href="#">D4 (#2)</a>
HAND TAP	5	-	4	14208	◆	14209	◆	See Page <a href="#">D4 (#1)</a>
<b>3/8"-40 NS</b>								
Recommended Hole Size based on 75% Thread = .3508"								
HAND TAP	2	3B	4	14210	◆	14211	◆	See Page <a href="#">D4 (#1)</a>
<b>7/16"-24 NS</b>								
Recommended Hole Size based on 75% Thread = .3965"								
HAND TAP	3	3B	4	14212	◆	14213	◆	See Page <a href="#">D4 (#1)</a>
HAND TAP	5	2B	4	14214	◆	14215	◆	See Page <a href="#">D4 (#1)</a>
<b>7/16"-32 NS</b>								
Recommended Hole Size based on 75% Thread = .4072"								
HAND TAP	3	3B	4	14216	◆	14217	◆	See Page <a href="#">D4 (#1)</a>
<b>15/32"-32 NS</b>								
Recommended Hole Size based on 75% Thread = .4384"								
HAND TAP	3	3B	6	14218	◆	14219	◆	See Page <a href="#">D4 (#1)</a>
<b>1/2"-10 ACME</b>								
Recommended Hole Size = .4000"								
L.H. HAND TAP	-	2G	4	14220	◆	-	-	See Page <a href="#">D5 (#12)</a>
<b>1/2"-13 NC</b>								
Recommended Hole Size based on 75% Thread = .4251"								
L.H. SPIRAL POINT	3	3B	3	14221	◆	-	-	See Page <a href="#">D4 (#2)</a>
+.005 HAND TAP	11	PLATING	4	14222	◆	14223	◆	See Page <a href="#">D4 (#1)</a>
+.005 SPIRAL POINT	11	PLATING	3	14224	◆	-	-	See Page <a href="#">D4 (#2)</a>
6" EXT HAND TAP	3	3B	4	14225	◆	14226	◆	See Page <a href="#">D4 (#4)</a>
6" EXT SPIRAL POINT	3	3B	3	14227	◆	-	-	See Page <a href="#">D4 (#4)</a>

DRILLS	<b>A</b>
END MILLS	<b>B</b>
ROUTERS	<b>C</b>
THREAD MILLS & TAPS	<b>D</b>
ENGRAVERS	<b>E</b>
BORING BARS	<b>F</b>
REAMERS	<b>G</b>
SAWS	<b>H</b>
TECHNICAL	<b>I</b>
INDEX	<b>J</b>

◆ : Usually Ships in 24-48 Hours  
Depending on Size and Quantity

		SIZE / DESCRIPTION			GH#	Class of Fit	No. of Flutes	EDP Number Plug	Stock	EDP Number Bottom	Stock	Style	
					Recommended Hole Size based on 75% Thread = .703" NPSF/NPSI = .7188"						Page 164 - 165		
A	DRILLS	<b>1/2"-14 PIPE TAP</b>		<i>Recommended Hole Size based on 75% Thread = .703" NPSF/NPSI = .7188"</i>									
		<b>NPSI NPSF NPT/F NPS</b>											
		NPT/F LEFT HAND TAPER		-	-	4	14228	◆	-	-	See Page <a href="#">D5 (#8)</a>		
		NPT/F 6" EXT TAPER		-	-	4	14229	◆	-	-	See Page <a href="#">D5 (#10)</a>		
		NPT/F 6" EXT INT THD TAPER		-	-	5	14230	◆	-	-	See Page <a href="#">D5 (#11)</a>		
B	END MILLS	NPSF EXT x 6"		-	-	4	14231	◆	-	-	See Page <a href="#">D5 (#10)</a>		
		<b>1/2"-14 55° WHITWORTH PIPE</b>		<i>Recommended Hole Size: BSPT = .7188" / BSPP = .7344"</i>									
C	ROUTERS	BSPT TAPER - MODIFIED		-	-	4	14232	◆	14233	◆	See Page <a href="#">D5 (#8)</a>		
		BSPP PARALLEL - MODIFIED		-	-	4	14234	◆	14235	◆	See Page <a href="#">D5 (#8)</a>		
		BSPP PARALLEL - FULL FORM		-	-	4	14236	◆	-	-	See Page <a href="#">D5 (#8)</a>		
D	THREAD MILLS & TAPS	<b>1/2"-20 NF</b>		<i>Recommended Hole Size based on 75% Thread = .4515"</i>									
		L.H. HAND TAP		3	3B	4	14237	◆	14238	◆	See Page <a href="#">D4 (#1)</a>		
		L.H. SPIRAL POINT		3	3B	3	14239	◆	-	-	See Page <a href="#">D4 (#2)</a>		
		HAND TAP		5	2B	4	-	-	14240	◆	See Page <a href="#">D4 (#1)</a>		
		+.003 HAND TAP		7	-	4	14241	◆	14242	◆	See Page <a href="#">D4 (#1)</a>		
		+.005 HAND TAP		11	PLATING	4	14243	◆	14244	◆	See Page <a href="#">D4 (#1)</a>		
		+.005 SPIRAL POINT		11	PLATING	3	14245	◆	-	-	See Page <a href="#">D4 (#2)</a>		
E	ENGRAVERS	6" EXT HAND TAP		3	3B	4	14246	◆	14247	◆	See Page <a href="#">D4 (#4)</a>		
		<b>1/2"-24 NS</b>		<i>Recommended Hole Size based on 75% Thread = .459"</i>									
		HAND TAP		3	3B	4	14248	◆	14249	◆	See Page <a href="#">D4 (#1)</a>		
		<b>1/2"-28 NEF</b>		<i>Recommended Hole Size based on 75% Thread = .4653"</i>									
		HAND TAP		3	3B	4	14250	◆	14251	◆	See Page <a href="#">D4 (#1)</a>		
		SPIRAL POINT		3	3B	3	14252	◆	-	-	See Page <a href="#">D4 (#2)</a>		
		HAND TAP		5	2B	4	14253	◆	14254	◆	See Page <a href="#">D4 (#1)</a>		
F	BORING BARS	<b>1/2"-32 NS</b>		<i>Recommended Hole Size based on 75% Thread = .4697"</i>									
		HAND TAP		3	3B	6	14255	◆	14256	◆	See Page <a href="#">D4 (#1)</a>		
G	REAMERS	<b>9/16"-12 NC</b>		<i>Recommended Hole Size based on 75% Thread = .4817"</i>									
		SPIRAL POINT		3	3B	3	14257	◆	-	-	See Page <a href="#">D4 (#2)</a>		
		<b>9/16"-18 NF</b>		<i>Recommended Hole Size based on 75% Thread = .5089"</i>									
H	SAWS	SPIRAL POINT		3	3B	3	14258	◆	-	-	See Page <a href="#">D4 (#2)</a>		
		<b>9/16"-20 NS</b>		<i>Recommended Hole Size based on 75% Thread = .514"</i>									
I	TECHNICAL	HAND TAP		3	3B	4	14259	◆	14260	◆	See Page <a href="#">D4 (#1)</a>		
		<b>9/16"-18 NF</b>		<i>Recommended Hole Size based on 75% Thread = .5089"</i>									
J	INDEX	SPIRAL POINT		3	3B	3	14258	◆	-	-	See Page <a href="#">D4 (#2)</a>		
		<b>9/16"-20 NS</b>		<i>Recommended Hole Size based on 75% Thread = .514"</i>									
		HAND TAP		3	3B	4	14259	◆	14260	◆	See Page <a href="#">D4 (#1)</a>		

SIZE / DESCRIPTION	GH#	Class of Fit	No. of Flutes	EDP Number Plug	Stock	EDP Number Bottom	Stock	Style Page 164 - 165
<b>9/16"-24 NEF</b>	Recommended Hole Size based on 75% Thread = .5215"							
HAND TAP	3	3B	4	14261	◆	14262	◆	See Page 164 (#1)
HAND TAP	5	2B	4	14263	◆	14264	◆	See Page 164 (#1)
<b>9/16"-32 NS</b>	Recommended Hole Size based on 75% Thread = .5322"							
HAND TAP	3	3B	6	14265	◆	14266	◆	See Page 164 (#1)
<b>5/8"-11 NC</b>	Recommended Hole Size based on 75% Thread = .5365"							
+.005 SPIRAL POINT	11	PLATING	3	14267	◆	-	-	See Page 164 (#2)
6" EXT HAND TAP	3	3B	4	14268	◆	14269	◆	See Page 164 (#4)
6" EXT SPIRAL POINT	3	3B	3	14270	◆	-	-	See Page 164 (#4)
8" EXT HAND TAP	3	3B	4	14271	◆	14272	◆	See Page 164 (#4)
<b>5/8"-18 NF</b>	Recommended Hole Size based on 75% Thread = .5714"							
+.005 HAND TAP	11	PLATING	4	14273	◆	14274	◆	See Page 164 (#4)
<b>5/8"-20 NS</b>	Recommended Hole Size based on 75% Thread = .5765"							
HAND TAP	3	3B	4	14275	◆	14276	◆	See Page 164 (#1)
<b>5/8"-24 NEF</b>	Recommended Hole Size based on 75% Thread = .5840"							
HAND TAP	3	3B	6	14277	◆	14278	◆	See Page 164 (#1)
HAND TAP	5	2B	6	14279	◆	14280	◆	See Page 164 (#1)
<b>5/8"-32 NS</b>	Recommended Hole Size based on 75% Thread = .5947"							
HAND TAP	3	3B	6	14281	◆	14282	◆	See Page 164 (#1)
<b>11/16"-18 NS</b>	Recommended Hole Size based on 75% Thread = .6339"							
HAND TAP	3	3B	4	14283	◆	14284	◆	See Page 164 (#1)
<b>3/4"-10 NC</b>	Recommended Hole Size based on 75% Thread = .6526"							
L.H. HAND TAP	3	3B	4	14285	◆	14286	◆	See Page 164 (#1)
+.005 HAND TAP	11	PLATING	4	14287	◆	14288	◆	See Page 164 (#1)
+.005 SPIRAL POINT	11	PLATING	3	14289	◆	-	-	See Page 164 (#2)
6" EXT HAND TAP	3	3B	4	14290	◆	14291	◆	See Page 164 (#4)
6" EXT SP PT	3	3B	3	14292	◆	-	-	See Page 164 (#4)
8" EXT HAND TAP	3	3B	4	14293	◆	14294	◆	See Page 164 (#4)
<b>3/4"-14 PIPE TAP NPSI NPSF NPT/F NPS</b>	Recommended Hole Size: NPT = .9063" / NPTF = .9219"							
NPT/F LEFT HAND TAPER	-	-	5	14295	◆	-	-	See Page 165 (#8)
NPT/F 6" EXT TAPER	-	-	5	14296	◆	-	-	See Page 165 (#10)
NPT/F 6" EXT INT THD TAPER	-	-	5	14297	◆	-	-	See Page 165 (#11)

DRILLS	A
END MILLS	B
ROUTERS	C
THREAD MILLS & TAPS	D
ENGRAVERS	E
BORING BARS	F
REAMERS	G
SAWS	H
TECHNICAL	I
INDEX	J

◆ : Usually Ships in 24-48 Hours  
Depending on Size and Quantity



	SIZE / DESCRIPTION	GH#	Class of Fit	No. of Flutes	EDP Number Plug	Stock	EDP Number Bottom	Stock	Style Page 164 - 165	
A	<b>3/4"-14 55° WHITWORTH PIPE</b>	Recommended Hole Size: BSPT = .938" / BSPP = .965"								
		BSPP PARALLEL - MODIFIED	-	-	5	14298	◆	14299	◆	See Page 164 (#8)
B	<b>3/4"-16 NF</b>	Recommended Hole Size based on 75% Thread = .6894" THREAD FORMING TAP at 65% Thread = .7224"								
		+ .003 HAND TAP	7	-	4	14300	◆	14301	◆	See Page 164 (#1)
		THREAD FORMING TAP	7	3B	0	14302	◆	14303	◆	See Page 164 (#5)
C	<b>3/4"-20 NEF</b>	Recommended Hole Size based on 75% Thread = .7015"								
		HAND TAP	3	3B	6	14304	◆	14305	◆	See Page 164 (#1)
D	<b>3/4"-24 NS</b>	Recommended Hole Size based on 75% Thread = .709"								
		HAND TAP	3	3B	6	14306	◆	14307	◆	See Page 164 (#1)
E	<b>.800"-36 A.M.O. MOD. WHITWORTH</b>	Recommended Hole Size Thread = .7644"								
		HAND TAP	2	-	6	14308	◆	14309	◆	See Page 164 (#1)
F	<b>7/8"-9 NC</b>	Recommended Hole Size based on 75% Thread = .7667"								
		SPIRAL POINT	4	3B	3	14310	◆	-	-	See Page 164 (#2)
		+ .005 HAND TAP	11	PLATING	4	14311	◆	14312	◆	See Page 164 (#1)
		8" EXT HAND TAP	4	3B	4	14313	◆	14314	◆	See Page 164 (#4)
G	<b>7/8"-14 NF</b>	Recommended Hole Size based on 75% Thread = .8056"								
		HAND TAP	6	2B	4	14315	◆	14316	◆	See Page 164 (#1)
H	<b>7/8"-18 NS</b>	Recommended Hole Size based on 75% Thread = .8214"								
		HAND TAP	3	3B	4	14317	◆	14318	◆	See Page 164 (#1)
I	<b>15/16"-16 NS</b>	Recommended Hole Size based on 75% Thread = .8769"								
		HAND TAP	3	3B	6	14319	◆	14320	◆	See Page 164 (#1)
J	<b>1"-8 NC</b>	Recommended Hole Size based on 75% Thread = .8781"								
		L.H. HAND TAP	4	3B	4	14321	◆	14322	◆	See Page 164 (#1)
		+ .005 HAND TAP	11	PLATING	4	14323	◆	14324	◆	See Page 164 (#1)
		+ .010 HAND TAP	21	-	4	14325	◆	14326	◆	See Page 164 (#1)
		8" EXT HAND TAP	4	3B	4	14327	◆	14328	◆	See Page 164 (#4)
		10" EXT HAND TAP	4	3B	4	14329	◆	14330	◆	See Page 164 (#4)
J	<b>1"-14 NS</b>	Recommended Hole Size based on 75% Thread = .9306"								
		SPIRAL POINT	4	3B	3	14331	◆	-	-	See Page 164 (#2)

SIZE / DESCRIPTION	GH#	Class of Fit	No. of Flutes	EDP Number Plug	Stock	EDP Number Bottom	Stock	Style Page 164 - 165
<b>1"-16 NS</b>	Recommended Hole Size based on 75% Thread = .9394"							
HAND TAP	3	3B	6	14332	◆	14333	◆	See Page <a href="#">D4 (#1)</a>
<b>1"-18 NS</b>	Recommended Hole Size based on 75% Thread = .9464"							
HAND TAP	3	3B	6	14334	◆	14335	◆	See Page <a href="#">D4 (#1)</a>
<b>1"-20 NEF</b>	Recommended Hole Size based on 75% Thread = .9515"							
HAND TAP	3	3B	6	14336	◆	14337	◆	See Page <a href="#">D4 (#1)</a>
<b>1"-32 NS</b>	Recommended Hole Size based on 75% Thread = .9817"							
HAND TAP	3	3B	6	14338	◆	14339	◆	See Page <a href="#">D4 (#1)</a>
<b>1 1/16"-12 NS</b>	Recommended Hole Size based on 75% Thread = .9817"							
HAND TAP	4	-	4	14340	◆	14341	◆	See Page <a href="#">D4 (#1)</a>
HAND TAP	5	3B	4	14342	◆	14343	◆	See Page <a href="#">D4 (#1)</a>
HAND TAP	7	2B	4	14344	◆	14345	◆	See Page <a href="#">D4 (#1)</a>
<b>1 3/16"-12 NS</b>	Recommended Hole Size based on 75% Thread = 1.106"							
HAND TAP	5	3B	6	14346	◆	14347	◆	See Page <a href="#">D4 (#1)</a>
<b>1 1/4"-7 NC</b>	Recommended Hole Size based on 75% Thread = 1.110"							
SPIRAL POINT	4	3B	3	14348	◆	-	-	See Page <a href="#">D4 (#2)</a>
10" EXTENSION	4	3B	4	14349	◆	14350	◆	See Page <a href="#">D4 (#4)</a>
12" EXTENSION	4	3B	4	14351	◆	14352	◆	See Page <a href="#">D4 (#4)</a>
<b>1 1/4"-20 NS</b>	Recommended Hole Size based on 75% Thread = 1.201"							
HAND TAP	4	3B	6	14353	◆	14354	◆	See Page <a href="#">D4 (#1)</a>
<b>1 5/16"-12 NS</b>	Recommended Hole Size based on 75% Thread = 1.232"							
HAND TAP	5	3B	6	14355	◆	14356	◆	See Page <a href="#">D4 (#1)</a>
<b>1 1/2"-6 NC</b>	Recommended Hole Size based on 75% Thread = 1.337"							
10" EXTENSION	4	3B	4	14357	◆	14358	◆	See Page <a href="#">D4 (#4)</a>
<b>1 5/8"-12 NS</b>	Recommended Hole Size based on 75% Thread = 1.544"							
HAND TAP	4	3B	6	14359	◆	14360	◆	See Page <a href="#">D4 (#1)</a>

DRILLS	<b>A</b>
END MILLS	<b>B</b>
ROUTERS	<b>C</b>
THREAD MILLS & TAPS	<b>D</b>
ENGRAVERS	<b>E</b>
BORING BARS	<b>F</b>
REAMERS	<b>G</b>
SAWS	<b>H</b>
TECHNICAL	<b>I</b>
INDEX	<b>J</b>

◆ : Usually Ships in 24-48 Hours  
Depending on Size and Quantity

SIZE / DESCRIPTION		D#	Class of Fit	No. of Flutes	EDP Number Plug	Stock	EDP Number Bottom	Stock	Style Page 164 - 165	
A	DRILLS	<b>M1.6 x 0.35</b>		Recommended Hole Size Based on 75% Thread = 1.25mm						
		HAND TAP	3	6H	2	14361	◆	-	-	See Page <a href="#">D4 (#1)</a>
		SPIRAL POINT	3	6H	0	14362	◆	-	-	See Page <a href="#">D4 (#2)</a>
B	END MILLS	<b>M1.8 x 0.35</b>		Recommended Hole Size Based on 75% Thread = 1.45mm						
		HAND TAP	3	6H	2	14363	◆	14364	◆	See Page <a href="#">D4 (#1)</a>
C	ROUTERS	<b>M2 x 0.4</b>		Recommended Hole Size Based on 75% Thread = 1.6mm						
		HAND TAP	3	6H	3	14365	◆	14366	◆	See Page <a href="#">D4 (#1)</a>
		SPIRAL POINT	3	6H	2	14367	◆	-	-	See Page <a href="#">D4 (#2)</a>
D	THREAD MILLS & TAPS	<b>M2.2 x 0.45</b>		Recommended Hole Size Based on 75% Thread = 1.75mm						
		HAND TAP	3	6H	3	14368	◆	14369	◆	See Page <a href="#">D4 (#1)</a>
		SPIRAL POINT	3	6H	2	14370	◆	-	-	See Page <a href="#">D4 (#2)</a>
E	ENGRAVERS	<b>M2.5 x 0.45</b>		Recommended Hole Size Based on 75% Thread = 2.05mm						
		HAND TAP	3	6H	3	14371	◆	14372	◆	See Page <a href="#">D4 (#1)</a>
		SPIRAL POINT	3	6H	2	14373	◆	-	-	See Page <a href="#">D4 (#2)</a>
F	BORING BARS	<b>M3 x 0.5</b>		Recommended Hole Size Based on 75% Thread = 2.5mm						
		HAND TAP	3	6H	3	14374	◆	14375	◆	See Page <a href="#">D4 (#1)</a>
		SPIRAL POINT	3	6H	2	14376	◆	-	-	See Page <a href="#">D4 (#2)</a>
G	REAMERS	<b>M3 x 0.5</b>		Recommended Hole Size Based on 75% Thread = 2.5mm						
		+.076mm SPIRAL POINT	7	-	2	14377	◆	-	-	See Page <a href="#">D4 (#2)</a>
		HAND TAP	3	6H	3	14374	◆	14375	◆	See Page <a href="#">D4 (#1)</a>
H	SAWS	<b>M4 x 0.75</b>		Recommended Hole Size Based on 75% Thread = 3.25mm						
		HAND TAP	4	6H	4	14378	◆	14379	◆	See Page <a href="#">D4 (#1)</a>
		HAND TAP	4	6H	4	14380	◆	14381	◆	See Page <a href="#">D4 (#1)</a>
I	TECHNICAL	<b>M4 x 0.7</b>		Recommended Hole Size Based on 75% Thread = 3.3mm						
		SPIRAL POINT	4	6H	2	14382	◆	-	◆	See Page <a href="#">D4 (#2)</a>
		HAND TAP	2	4H	4	14383	◆	14384	◆	See Page <a href="#">D4 (#1)</a>
		+.076mm SPIRAL POINT	7	-	2	14385	◆	-	-	See Page <a href="#">D4 (#2)</a>
		6" EXT HAND TAP	4	6H	4	14386	◆	14387	◆	See Page <a href="#">D4 (#4)</a>
		6" EXT SPIRAL POINT	4	6H	2	14388	◆	-	-	See Page <a href="#">D4 (#4)</a>
J	INDEX	<b>M5 x 0.8</b>		Recommended Hole Size Based on 75% Thread = 4.2mm						
		+.127mm HAND TAP	11	PLATING	4	14389	◆	14390	◆	See Page <a href="#">D4 (#1)</a>
		HAND TAP	4	6H	4	14391	◆	14392	◆	See Page <a href="#">D4 (#1)</a>
		SPIRAL POINT	4	6H	2	14393	◆	-	-	See Page <a href="#">D4 (#2)</a>
		HAND TAP	2	4H	4	14394	◆	14395	◆	See Page <a href="#">D4 (#1)</a>
		REGULAR SPIRAL FLUTE	4	6H	2	14396	◆	14397	◆	See Page <a href="#">D4 (#6)</a>
		+.076mm SPIRAL POINT	7	-	2	14398	◆	-	-	See Page <a href="#">D4 (#2)</a>
		6" EXT SPIRAL POINT	4	6H	2	14399	◆	-	-	See Page <a href="#">D4 (#4)</a>

SIZE / DESCRIPTION	D#	Class of Fit	No. of Flutes	EDP Number Plug		EDP Number Bottom		Style Page 164 - 165
					Stock		Stock	

### M5 x 0.5

Recommended Hole Size Based on 75% Thread = 4.5mm

HAND TAP	3	6H	4	14401	◆	14402	◆	See Page 164 (#1)
SPIRAL POINT	3	6H	2	14403	◆	-	-	See Page 164 (#2)

### M6 x 1.0

Recommended Hole Size Based on 75% Thread = 5mm  
THREAD FORMING TAP at 65% Thread = 5.56mm

HAND TAP	5	6H	4	14404	◆	14405	◆	See Page 164 (#1)
HAND TAP	3	4H	4	14406	◆	14407	◆	See Page 164 (#1)
L.H. HAND TAP	5	6H	4	14408	◆	14409	◆	See Page 164 (#1)
6" EXT HAND TAP	5	6H	4	14410	◆	14411	◆	See Page 164 (#4)
6" EXT SPIRAL POINT	5	6H	2	14412	◆	-	-	See Page 164 (#4)
+.127mm HAND TAP	11	PLATING	4	14413	◆	14414	◆	See Page 164 (#1)
+.127mm SPIRAL POINT	11	PLATING	2	14415	◆	-	-	See Page 164 (#2)
THREAD FORMING TAP	8	6H	0	14416	◆	14417	◆	See Page 164 (#5)

### M6 x 0.75

Recommended Hole Size Based on 75% Thread = 5.25mm

HAND TAP	3	4H	4	14418	◆	14419	◆	See Page 164 (#1)
SPIRAL POINT	3	4H	2	14420	◆	-	-	See Page 164 (#2)

### M6 x 0.5

Recommended Hole Size Based on 75% Thread = 5.5mm

HAND TAP	3	6H	4	14421	◆	14422	◆	See Page 164 (#1)
----------	---	----	---	-------	---	-------	---	-------------------

### M8 x 1.25

Recommended Hole Size Based on 75% Thread = 6.75mm

HAND TAP	5	6H	4	14423	◆	14424	◆	See Page 164 (#1)
SPIRAL POINT	5	6H	2	14425	◆	-	-	See Page 164 (#2)
HAND TAP	3	4H	4	14426	◆	14427	◆	See Page 164 (#1)
SPIRAL POINT	3	4H	2	14428	◆	-	-	See Page 164 (#2)
FAST SPIRAL FLUTE	5	6H	3	14429	◆	14430	◆	See Page 164 (#6)
L.H. HAND TAP	5	6H	4	14431	◆	14432	◆	See Page 164 (#1)
6" EXT HAND TAP	5	6H	4	14433	◆	14434	◆	See Page 164 (#4)
6" EXT SPIRAL POINT	5	6H	2	14435	◆	-	-	See Page 164 (#4)
+.127mm SPIRAL POINT	11	PLATING	2	14436	◆	-	-	See Page 164 (#2)

### M8 x 1.0

Recommended Hole Size Based on 75% Thread = 7mm  
THREAD FORMING TAP at 65% Thread = 7.56mm

HAND TAP	5	6H	4	14437	◆	14438	◆	See Page 164 (#1)
SPIRAL POINT	5	6H	2	14439	◆	-	-	See Page 164 (#2)
HAND TAP	3	4H	4	14440	◆	14441	◆	See Page 164 (#1)
SPIRAL POINT	3	4H	2	14442	◆	-	-	See Page 164 (#2)
THREAD FORMING TAP	8	6H	0	14443	◆	14444	◆	See Page 164 (#5)

### M8 x 0.75

Recommended Hole Size Based on 75% Thread = 7.25mm

HAND TAP	5	6H	4	14445	◆	14446	◆	See Page 164 (#1)
----------	---	----	---	-------	---	-------	---	-------------------

### M8 x 0.5

Recommended Hole Size Based on 75% Thread = 7.5mm

HAND TAP	4	6H	4	14447	◆	14448	◆	See Page 164 (#1)
----------	---	----	---	-------	---	-------	---	-------------------

◆ : Usually Ships in 24-48 Hours  
Depending on Size and Quantity

DRILLS	A
END MILLS	B
ROUTERS	C
THREAD MILLS & TAPS	D
ENGRAVERS	E
BORING BARS	F
REAMERS	G
SAWS	H
TECHNICAL	I
INDEX	J

SIZE / DESCRIPTION		D#	Class of Fit	No. of Flutes	EDP Number Plug	Stock	EDP Number Bottom	Stock	Style Page 164 - 165	
A	DRILLS	<b>M9 x 1.25</b>		Recommended Hole Size Based on 75% Thread = 7.75mm						
		HAND TAP	5	6H	4	14449	◆	14450	◆	See Page <a href="#">D4 (#1)</a>
B	END MILLS	<b>M9 x 1.0</b>		Recommended Hole Size Based on 75% Thread = 8mm						
		HAND TAP	5	6H	4	14451	◆	14452	◆	See Page <a href="#">D4 (#1)</a>
C	ROUTERS	<b>M10 x 1.5</b>		Recommended Hole Size Based on 75% Thread = 8.5mm THREAD FORMING TAP at 65% Thread = 9.34mm						
		HAND TAP	6	6H	4	14453	◆	14454	◆	See Page <a href="#">D4 (#1)</a>
D	THREAD MILLS & TAPS	SPIRAL POINT	6	6H	3	14455	◆	-	-	See Page <a href="#">D4 (#2)</a>
		HAND TAP	3	4H	4	14456	◆	14457	◆	See Page <a href="#">D4 (#1)</a>
		FAST SPIRAL FLUTE	6	6H	3	14458	◆	14459	◆	See Page <a href="#">D4 (#6)</a>
		L.H. HAND TAP	6	6H	4	14460	◆	14461	◆	See Page <a href="#">D4 (#1)</a>
		6" EXT HAND .323 SHK	6	6H	4	14462	◆	14463	◆	See Page <a href="#">D5 (#7)</a>
		6" EXT SP PT .323 SHK	6	6H	3	14464	◆	-	-	See Page <a href="#">D5 (#7)</a>
		6" EXT HAND TAP	6	6H	4	14465	◆	14466	◆	See Page <a href="#">D4 (#4)</a>
		6" EXT SPIRAL POINT	6	6H	3	14467	◆	-	-	See Page <a href="#">D4 (#4)</a>
		+.127mm SPIRAL POINT	11	PLATING	3	14468	◆	-	-	See Page <a href="#">D4 (#2)</a>
		THREAD FORMING TAP	10	6H	0	14469	◆	14470	◆	See Page <a href="#">D4 (#5)</a>
E	ENGRAVERS	<b>M10 x 1.25</b>		Recommended Hole Size Based on 75% Thread = 8.75mm						
		HAND TAP	5	6H	4	14471	◆	14472	◆	See Page <a href="#">D4 (#1)</a>
F	BORING BARS	SPIRAL POINT	5	6H	3	14473	◆	-	-	See Page <a href="#">D4 (#2)</a>
		+.127mm SPIRAL POINT	11	PLATING	3	14474	◆	-	-	See Page <a href="#">D4 (#2)</a>
		<b>M10 x 1.0</b>		Recommended Hole Size Based on 75% Thread = 9mm						
G	REAMERS	SPARK PL HAND	3	-	4	14475	◆	14476	◆	See Page <a href="#">D4 (#1)</a>
		HAND TAP	5	6H	4	14477	◆	14478	◆	See Page <a href="#">D4 (#1)</a>
		SPIRAL POINT	5	6H	3	14479	◆	-	-	See Page <a href="#">D4 (#2)</a>
H	SAWS	<b>M11 x 1.5</b>		Recommended Hole Size Based on 75% Thread = 9.5mm						
		HAND TAP	6	6H	4	14480	◆	14481	◆	See Page <a href="#">D4 (#1)</a>
I	TECHNICAL	<b>M11 x 1.0</b>		Recommended Hole Size Based on 75% Thread = 10mm						
		HAND TAP	5	6H	4	14482	◆	14483	◆	See Page <a href="#">D4 (#1)</a>
J	INDEX	<b>M12 x 1.75</b>		Recommended Hole Size Based on 75% Thread = 10.25mm						
		SPIRAL POINT	6	6H	3	14484	◆	-	-	See Page <a href="#">D4 (#2)</a>
		HAND TAP	3	4H	4	14485	◆	14486	◆	See Page <a href="#">D4 (#1)</a>
		L.H. HAND TAP	6	6H	4	14487	◆	14488	◆	See Page <a href="#">D4 (#1)</a>
		6" EXT HAND TAP	6	6H	4	14489	◆	14490	◆	See Page <a href="#">D4 (#4)</a>
		6" EXT SP PT	6	6H	3	14491	◆	-	-	See Page <a href="#">D4 (#4)</a>
		+.127mm SPIRAL POINT	11	PLATING	3	14492	◆	-	-	See Page <a href="#">D4 (#2)</a>

SIZE / DESCRIPTION	D#	Class of Fit	No. of Flutes	EDP Number Plug	Stock	EDP Number Bottom	Stock	Style Page 164 - 165
<b>M12 x 1.5</b> Recommended Hole Size Based on 75% Thread = 10.50mm								
HAND TAP	6	6H	4	14493	◆	14494	◆	See Page <a href="#">D4 (#1)</a>
SPIRAL POINT	6	6H	3	14495	◆	-	-	See Page <a href="#">D4 (#2)</a>
<b>M12 x 1.25</b> Recommended Hole Size Based on 75% Thread = 10.75mm THREAD FORMING TAP at 65% Thread = 11.45mm								
HAND TAP	5	6H	4	14496	◆	14497	◆	See Page <a href="#">D4 (#1)</a>
SPIRAL POINT	5	6H	3	14498	◆	-	-	See Page <a href="#">D4 (#2)</a>
THREAD FORMING TAP	10	6H	0	14499	◆	14500	◆	See Page <a href="#">D4 (#5)</a>
<b>M12 x 1.0</b> Recommended Hole Size Based on 75% Thread = 11mm								
HAND TAP	5	6H	4	14501	◆	14502	◆	See Page <a href="#">D4 (#1)</a>
SPIRAL POINT	5	6H	3	14503	◆	-	-	See Page <a href="#">D4 (#2)</a>
<b>M14 x 2.0</b> THREAD FORMING TAP at 65% Thread = 13.13mm								
THREAD FORMING TAP	12	6H	0	14504	◆	14505	◆	See Page <a href="#">D4 (#5)</a>
<b>M14 x 1.5</b> Recommended Hole Size Based on 75% Thread = 12.5mm								
HAND TAP	6	6H	4	14506	◆	14507	◆	See Page <a href="#">D4 (#1)</a>
SPIRAL POINT	6	6H	3	14508	◆	-	-	See Page <a href="#">D4 (#2)</a>
HAND TAP	3	4H	4	14509	◆	14510	◆	See Page <a href="#">D4 (#1)</a>
<b>M14 x 1.25</b> Recommended Hole Size Based on 75% Thread = 12.75mm								
SPARK PL HAND	4	-	4	14511	◆	14512	◆	See Page <a href="#">D4 (#1)</a>
<b>M14 x 1.0</b> Recommended Hole Size Based on 75% Thread = 13mm								
HAND TAP	5	6H	4	14513	◆	14514	◆	See Page <a href="#">D4 (#1)</a>
<b>M16 x 2.0</b> Recommended Hole Size Based on 75% Thread = 14mm								
SPIRAL POINT	7	6H	3	14515	◆	-	-	See Page <a href="#">D4 (#2)</a>
SPIRAL POINT	4	4H	3	14516	◆	-	-	See Page <a href="#">D4 (#2)</a>
L.H. HAND TAP	7	6H	4	14517	◆	14518	◆	See Page <a href="#">D4 (#1)</a>
6" EXT HAND TAP	7	6H	4	14519	◆	14520	◆	See Page <a href="#">D4 (#4)</a>
6" EXT SPIRAL POINT	7	6H	3	14521	◆	-	-	See Page <a href="#">D4 (#4)</a>
+.127mm HAND TAP	11	PLATING	4	14522	◆	14523	◆	See Page <a href="#">D4 (#1)</a>
+.127mm SPIRAL POINT	11	PLATING	3	14524	◆	-	-	See Page <a href="#">D4 (#2)</a>
<b>M16 x 1.5</b> Recommended Hole Size Based on 75% Thread = 14.5mm								
HAND TAP	6	6H	4	14525	◆	14526	◆	See Page <a href="#">D4 (#1)</a>
SPIRAL POINT	6	6H	3	14527	◆	-	-	See Page <a href="#">D4 (#2)</a>
<b>M16 x 1.0</b> Recommended Hole Size Based on 75% Thread = 15mm								
HAND TAP	5	6H	4	14528	◆	14529	◆	See Page <a href="#">D4 (#1)</a>

DRILLS	<b>A</b>
END MILLS	<b>B</b>
ROUTERS	<b>C</b>
THREAD MILLS & TAPS	<b>D</b>
ENGRAVERS	<b>E</b>
BORING BARS	<b>F</b>
REAMERS	<b>G</b>
SAWS	<b>H</b>
TECHNICAL	<b>I</b>
INDEX	<b>J</b>

SIZE / DESCRIPTION		D#	Class of Fit	No. of Flutes	EDP Number Plug	Stock	EDP Number Bottom	Stock	Style Page 164 - 165	
A	DRILLS	<b>M18 x 1.5</b>		Recommended Hole Size Based on 75% Thread = 16.5mm						
		HAND TAP	6	6H	4	14530	◆	14531	◆	See Page 164 (#1)
		L.H. HAND TAP	6	6H	4	14532	◆	14533	◆	See Page 164 (#1)
B	END MILLS	<b>M18 x 1.0</b>		Recommended Hole Size Based on 75% Thread = 17mm						
		HAND TAP	5	6H	4	14534	◆	14535	◆	See Page 164 (#1)
		<b>M20 x 2.5</b>		Recommended Hole Size Based on 75% Thread = 17.5mm						
C	ROUTERS	HAND TAP	7	6H	4	14536	◆	14537	◆	See Page 164 (#1)
		SPIRAL POINT	7	6H	3	14538	◆	-	-	See Page 164 (#2)
		6" EXT HAND TAP	7	6H	4	14539	◆	14540	◆	See Page 164 (#4)
D	THREAD MILLS & TAPS	<b>M20 x 1.5</b>		Recommended Hole Size Based on 75% Thread = 18.5mm						
		HAND TAP	6	6H	4	14541	◆	14542	◆	See Page 164 (#1)
		<b>M20 x 1.0</b>		Recommended Hole Size Based on 75% Thread = 19mm						
E	ENGRAVERS	HAND TAP	6	6H	4	14543	◆	14544	◆	See Page 164 (#1)
		<b>M22 x 2.5</b>		Recommended Hole Size Based on 75% Thread = 19.5mm						
		HAND TAP	7	6H	4	14545	◆	14546	◆	See Page 164 (#1)
F	BORING BARS	<b>M22 x 1.5</b>		Recommended Hole Size Based on 75% Thread = 20.5mm						
		HAND TAP	6	6H	4	14547	◆	14548	◆	See Page 164 (#1)
		<b>M24 x 3.0</b>		Recommended Hole Size Based on 75% Thread = 21mm						
G	REAMERS	HAND TAP	8	6H	4	14549	◆	14550	◆	See Page 164 (#1)
		SPIRAL POINT	8	6H	3	14551	◆	-	-	See Page 164 (#2)
		<b>M24 x 2.0</b>		Recommended Hole Size Based on 75% Thread = 22mm						
H	SAWS	HAND TAP	7	6H	4	14552	◆	14553	◆	See Page 164 (#1)
		<b>M24 x 1.5</b>		Recommended Hole Size Based on 75% Thread = 22.5mm						
		HAND TAP	6	6H	4	14554	◆	14555	◆	See Page 164 (#1)
I	TECHNICAL	<b>M26 x 1.5</b>		Recommended Hole Size Based on 75% Thread = 24.5mm						
		HAND TAP	6	6H	6	14556	◆	14557	◆	See Page 164 (#1)
		<b>M27 x 3.0</b>		Recommended Hole Size Based on 75% Thread = 24mm						
J	INDEX	HAND TAP	8	6H	4	14558	◆	14559	◆	See Page 164 (#1)



SIZE / DESCRIPTION	D#	Class of Fit	No. of Flutes	EDP Number Plug	Stock	EDP Number Bottom	Stock	Style Page 164 - 165
<b>M27 x 2.0</b>	Recommended Hole Size Based on 75% Thread = 25mm							
HAND TAP	7	6H	4	14560	◆	14561	◆	See Page <a href="#">D4 (#1)</a>
<b>M30 x 3.5</b>	Recommended Hole Size Based on 75% Thread = 26.5mm							
HAND TAP	9	6H	4	14562	◆	14563	◆	See Page <a href="#">D4 (#1)</a>
<b>M30 x 2.0</b>	Recommended Hole Size Based on 75% Thread = 28mm							
HAND TAP	7	6H	4	14564	◆	14565	◆	See Page <a href="#">D4 (#1)</a>
HAND TAP	5	4H	4	14566	◆	14567	◆	See Page <a href="#">D4 (#1)</a>
<b>M30 x 1.5</b>	Recommended Hole Size Based on 75% Thread = 28.5mm							
HAND TAP	6	6H	6	14568	◆	14569	◆	See Page <a href="#">D4 (#1)</a>
<b>M33 x 2.0</b>	Recommended Hole Size Based on 75% Thread = 31mm							
HAND TAP	7	6H	4	14570	◆	14571	◆	See Page <a href="#">D4 (#1)</a>
<b>M35 x 1.5</b>	Recommended Hole Size Based on 75% Thread = 33.5mm							
HAND TAP	6	6H	6	14572	◆	14573	◆	See Page <a href="#">D4 (#1)</a>
<b>M36 x 2.0</b>	Recommended Hole Size Based on 75% Thread = 34mm							
HAND TAP	7	6H	6	14574	◆	14575	◆	See Page <a href="#">D4 (#1)</a>
<b>M36 x 1.5</b>	Recommended Hole Size Based on 75% Thread = 34.5mm							
HAND TAP	6	6H	6	14576	◆	14577	◆	See Page <a href="#">D4 (#1)</a>
<b>M40 x 1.5</b>	Recommended Hole Size Based on 75% Thread = 38.5mm							
HAND TAP	6	6H	6	14578	◆	14579	◆	See Page <a href="#">D4 (#1)</a>
<b>M42 x 4.5</b>	Recommended Hole Size Based on 75% Thread = 37.5mm							
HAND TAP	10	6H	6	14580	◆	14581	◆	See Page <a href="#">D4 (#1)</a>

DRILLS	<b>A</b>
END MILLS	<b>B</b>
ROUTERS	<b>C</b>
THREAD MILLS & TAPS	<b>D</b>
ENGRAVERS	<b>E</b>
BORING BARS	<b>F</b>
REAMERS	<b>G</b>
SAWS	<b>H</b>
TECHNICAL	<b>I</b>
INDEX	<b>J</b>

◆ : Usually Ships in 24-48 Hours  
Depending on Size and Quantity

### STANDARD SYSTEM OF TAP MARKING

Taps, dies and other types of threading tools are marked according to the Standard System of Marking Ground Thread Taps. Tools are marked with the nominal size, number of threads per inch (pitch), and the appropriate thread form symbol and pitch diameter symbol. Symbols typically used are listed.

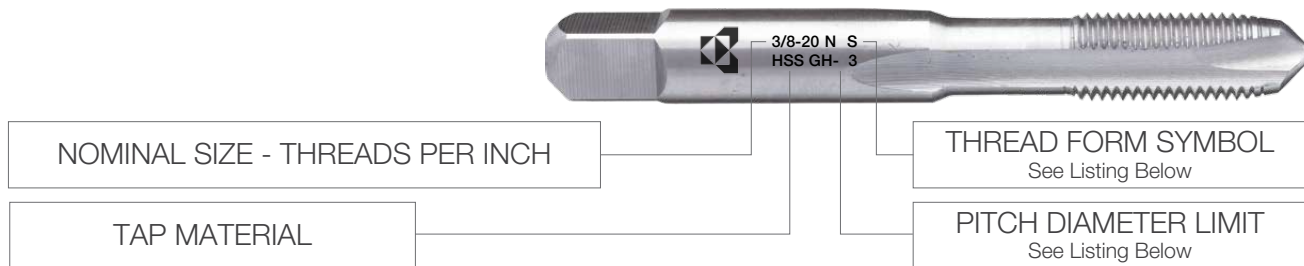

#### PITCH DIAMETER LIMIT SYMBOLS

All standard ground thread taps are marked with the letter “G” to designate Ground Thread. The letter G will be followed by the letter “H” to designate above basic; or the letter “L” to designate below basic. The number following H or L signifies the number of .0005” steps above or below the basic pitch diameter. For instance, the tap pictured above is a 3/8” dia. tap with 20 threads per inch (pitch), and has a NS (American National Special Thread) thread form. The tap is made from High Speed Steel, and the GH-3 pitch diameter limit symbol indicates a Ground Thread tap with pitch diameter limits .0010 to .0015 over basic.

Pitch Diameter Limits for taps to 1” diameter inclusive:

- L1 = Basic to Basic minus .0005
- H1 = Basic to Basic plus .0005
- H2 = Basic plus .0005 to Basic plus .0010
- H3 = Basic plus .0010 to Basic plus .0015
- H4 = Basic plus .0015 to Basic plus .0020
- H5 = Basic plus .0020 to Basic plus .0025
- H6 = Basic plus .0025 to Basic plus .0030

Taps larger than 1” dia. are ground to a .0010” tolerance on the pitch diameter and are, for example, H4 (Basic plus .0010” to Basic plus .0020” ).

#### THREAD FORM SYMBOLS

ACME-C	Acme Thread-Centralizing	NPTF	Dryseal American National Standard Taper Pipe Thread
ACME-G	Acme Thread-General Purpose	NPTR	American National Standard Taper Pipe Thread for Railing Joints (Tap marked NPT)
AMO	American Standard Microscope Objective Thread	NS	American National Thread-Special
ANPT	Aeronautical National Form Taper Pipe Thread (Ground thread tap marked NPT)	PG	Panzer Gewinde
BA	British Association Standard Thread	PTF	Dryseal SAE Short Taper Pipe Thread
BSF	British Standard Fine Thread Series	SGT	Special Gas Taper Thread
BSP	British Standard Pipe	SPL-PTF	Dryseal Special Taper Pipe Thread
BSPP	British Standard Pipe (Parallel) Thread	STI	Special Thread for Helical Coil Wire Screw Thread Inserts
BSPT	British Standard Taper Pipe Thread	Stub Acme	Stub Acme Thread
BSW	British Standard Whitworth Coarse Thread Series	*UN	Unified Constant Pitch Thread Series
M	Metric ScrewThread Series	*UNC	Unified Coarse Thread Series
N	American National 8, 12 and 16 Thread Series (8N, 12N, 16N)	*UNEF	Unified Extra Fine Thread Series
NBUTT	American Buttress Screw Thread	*UNF	Unified Fine Thread Series
NC	American National Coarse Thread Series	UNJ**	Unified Thread Series with a 0.15011P to 0.18042P Controlled Root Radius on External Thread only.
NEF	American National Extra Fine Thread Series	UNJC	Unified Coarse Thread Series with a 0.15011P to 0.18042P Controlled Root Radius on External Thread only.
NF	American National Fine Thread Series	UNJF	Unified Fine Thread Series with a 0.15011P to 0.18042P Controlled Root Radius on External Thread only.
NGO	National Gas Outlet Thread	UNM	Unified Miniature Thread Series
NGT	National Gas Taper Thread (see “SGT”)	UNR	Unified Constant Pitch Thread Series with a 0.108P to 0.144P Controlled Root Radius; Ext. thread only.
NH	American National Hose Coupling and Fire Hose Coupling Threads	UNRC	Unified Coarse Thread Series with a 0.108P to 0.144P Controlled Root Radius; Ext. thread only.
NPS	For tap marking only (See NPSC, NPSM)	UNRF	Unified Fine Thread Series with a 0.108P to 0.144P Controlled Root Radius; External thread only.
NPSC	American National Standard Straight Pipe Thread in Pipe Couplings (Tap marked NPS)	*UNS	Unified Thread-Special
NPSF	Dryseal American National Standard Fuel Internal Straight Pipe Thread	V	A 60° “V” thread with Truncated Crest and Root. The theoretical “V” Form is usually flattened to the user’s specifications.
NPSH	American National Standard Straight Pipe Thread for Hose Couplings	WHIT	British Standard Whitworth Special Thread
NPSI	Dryseal American National Standard Intermediate Internal Straight Pipe Thread		
NPSL	American National Standard Straight Pipe Thread for Loose Fitting Mechanical Joints with Locknuts		
NPSM	American National Standard Straight Pipe Threads for Free-Fitting Mechanical Joints for Fixtures (Tap marked NPS)		
NPT	American National Standard Taper Pipe Thread (See ANPT, NPTR)		

\*Taps are not marked with “U” but with the symbol for the corresponding American Standard thread form with which it is compatible.  
 \*\* See page D23 for additional information on UNJ taps.

- A DRILLS
- B END MILLS
- C ROUTERS
- D THREAD MILLS & TAPS
- E ENGRAVERS
- F BORING BARS
- G REAMERS
- H SAWS
- I TECHNICAL
- J INDEX

## INCH SCREW THREADS - UNJ PROFILE

### Controlled Root Radius with Increased Minor Diameter

The UNJ thread standard (ASME B1.15) defines a system of threads for highly stressed applications requiring high fatigue strength. It was derived from a military specification (MIL-S-8879). MIL-S-8879 was primarily thought of and used for aerospace fastener and threaded component applications. Due to the increase in both its use and types of applications, the American Society of Mechanical Engineers developed and published ASME B1.15 in 1995.

**Form.** UNJ screw threads are of the same form as Unified Screw Threads to ASME/ANSI B1.1 except:

**External threads:** the root has a maximum and minimum prescribed continuous radius, and is not merely rounded due to tool wear.

**Internal threads:** the minor diameter is increased to accommodate the maximum root radius of the external thread. There is no radius requirement for either the crest or the root of the internal thread.

**Designation.** UNJ product threads are identified by the letter “J” in the thread symbol, and a thread class symbol including an “A” for external threads or a “B” for internal threads.

**Use of Unified Tooling.** Many of the UNJ thread form characteristics are the same as for UN threads. Therefore, some of the tooling used to produce one form can be used to produce the other.

**External UNJ threads** must be produced with a prescribed root radius; therefore, standard Unified Screw Thread (UN) tooling may not be used.

**Internal UNJ threads** are not required to have a root radius; therefore, ground thread taps designed to produce Unified Screw Threads of the proper class of fit may be used. The letter “J” need not be marked on the tap. The larger product minor diameter of the UNJ internal thread requires the use of a larger tap drill than is used when producing Unified Screw Threads.

- UNJ Thread Form: Unified Thread Series with a 0.15011P to 0.18042P controlled root radius on external thread only. (As defined by MIL-S-8879C)
- UNJ internal threads do not require radius; only external thread requires radius on root.
- UNJ external thread assembles only with UNJ internal thread.
- UNJ tap is standard 2B or 3B class of fit.

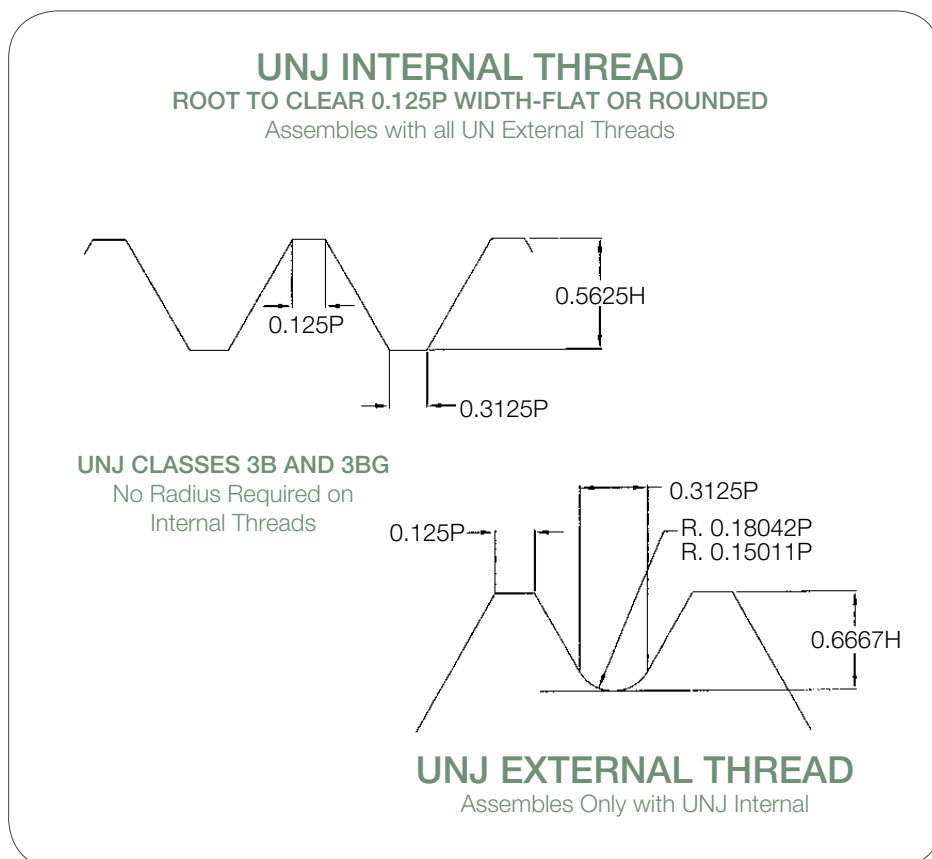

## CLASS OF FIT / CLASSES OF THREADS / TAP SIZE

A

DRILLS

**CLASSES OF THREADS AND TAP SIZE:**

There is a direct relationship between the size of a tap and the size of the thread that it cuts. Size refers to pitch diameter and its relationship to the class of fit required. If two threaded parts are assembled, the looseness or tightness of the fit is determined by contact on the flanks of the threads only. This contact is controlled by the pitch diameters of each part.

**CLASSES OF THREAD:** When threaded parts are mated, the two parts must assemble with a degree of tightness dictated by the use of the fastener. In addition, the internal thread must be

large enough to allow the external thread to enter it for the required length of engagement. A system of thread classes, each representing a comparative degree of tightness, has been established and universally adopted, to provide manufacturers and users of threaded products with a common language of specification. The thread classes designate minimum and maximum pitch diameters for internal and external threads. It is important to remember that classes of thread actually represents manufacturing tolerances. The closer the tolerance required, the higher the cost involved in producing the parts. Therefore, designers and engineers should always try to select the class of thread with the widest permissible tolerance.

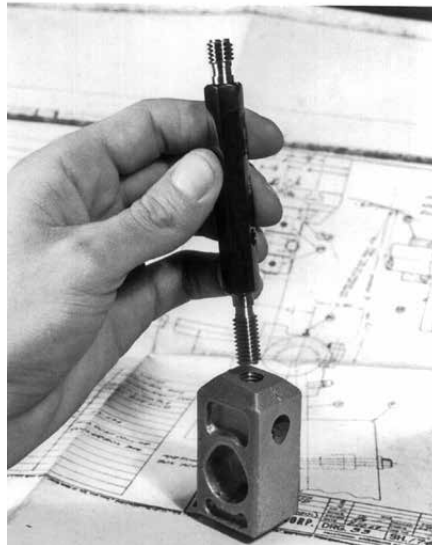

**TAP SIZE:** Due to material variability and machining conditions, taps rarely cut their own size. The thread size produced is usually larger, but can be smaller due to shrinkage. Tap manufacturers realized that to tap a specified class of thread, several different ground thread tap limits would be required. These limits represent small, defined variations in tap size. A numbering system was developed to designate each series of limits, but these limit numbers are not to be confused with the classes of threads. Ground thread tap limits are designated by the letter H (high) above basic pitch diameter, or L (low) below basic pitch diameter, and these numbers establish

the tolerance range in relation to basic pitch diameter. As an example, in sizes 1" and smaller, an H1 tap has a tolerance range of from basic to .0005" over basic; an H2 tap from .0005" over basic to .001" over basic, (see **Chart 1A** on this page). In addition, metric threads are also designated in much the same way. The thread tap limits are designated by the letter D (ground, high) above basic pitch diameter, or U (ground, low) below basic pitch diameter. As an example, in sizes M25 and smaller, a D1 tap has a size of .0005" over basic to tap max. P.D.; a D2 tap has a size of .001" over basic to tap max. P.D., (see **Chart 1B**). The Tables on **pages D31-D33** list recommended limit numbers for different classes of thread. Several different limit numbers are available for each diameter and pitch combination. Consequently, it is possible to select the "H" or "L" limit, or the "D" or "U" limit most suitable for the required tapping operation. Please contact our Customer Service Dept. for questions regarding tap limits and their relation to classes of fit.

B

END MILLS

C

ROUTERS

D

THREAD MILLS &amp; TAPS

E

ENGRAVERS

F

BORING BARS

G

REAMERS

H

SAWS

I

TECHNICAL

J

INDEX

**CHART 1A**

Pitch Diameter Limits for taps to 1" diameter inclusive:

- L1 = Basic to Basic minus 0.0005
- H1 = Basic to Basic plus 0.0005
- H2 = Basic plus 0.0005 to Basic plus 0.0010
- H3 = Basic plus 0.0010 to Basic plus 0.0015
- H4 = Basic plus 0.0015 to Basic plus 0.0020
- H5 = Basic plus 0.0020 to Basic plus 0.0025
- H6 = Basic plus 0.0025 to Basic plus 0.0030

Taps larger than 1" dia. are ground to a 0.0010" tolerance on the pitch diameter and are, for example,

H4 (Basic plus 0.0010" to Basic plus 0.0020").

**CHART 1B**

Pitch Diameter Limits for taps to 1" diameter inclusive:

(Metric taps generally have more manufacturing tolerance than 0.0005 to the minus side.)

- U1 = Basic minus 0.0005 = min. tap P.D.
- D1 = Basic plus 0.0005 = max. tap P.D.
- D2 = Basic plus 0.0010 = max. tap P.D.
- D3 = Basic plus 0.0015 = max. tap P.D.
- D4 = Basic plus 0.0020 = max. tap P.D.
- D5 = Basic plus 0.0025 = max. tap P.D.
- D6 = Basic plus 0.0030 = max. tap P.D.

CLASS OF FIT / CLASSES OF THREADS / TAP SIZE (cont.)

On Charts 2A and 2B (below), examples of the relationship of Class of Fit to various tap limit sizes is shown for both Imperial and Metric sizes. In chart 2A, using a 1/4"-20NC or UNC thread size, it is obvious that an H5 limit (+.0025" over basic pitch diameter) can be used to cut the tightest class of thread in most

machining situations, as can the H1 limit (+.0005" over basic P.D.). However, tool wear would force the discarding of the H1 tap long before the H5 would be worn to an undersize condition. **The rule is obvious: always select the largest "H" limit possible to achieve proper class of fit, and maximum tool life.**

CHART 2A COMPARISON OF PITCH DIAMETER LIMITS TO CLASS OF FIT

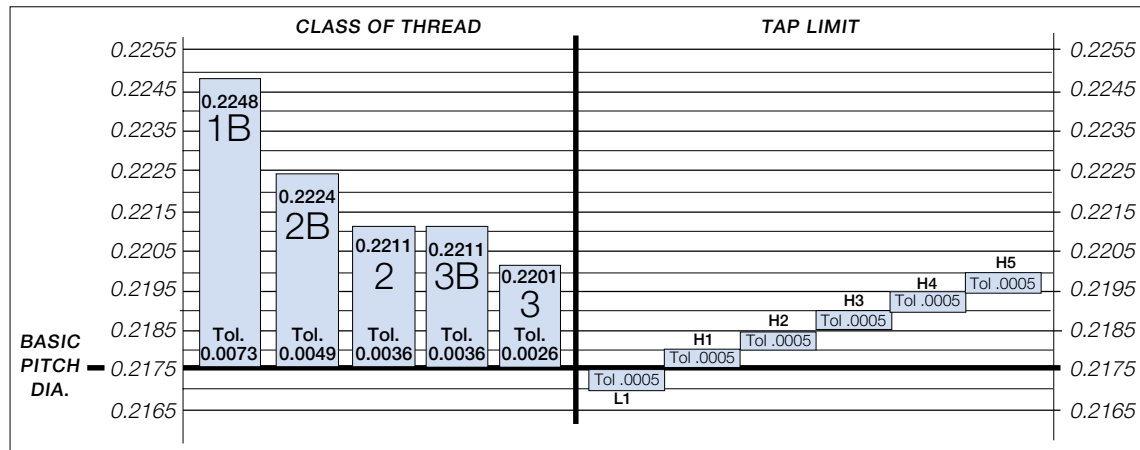
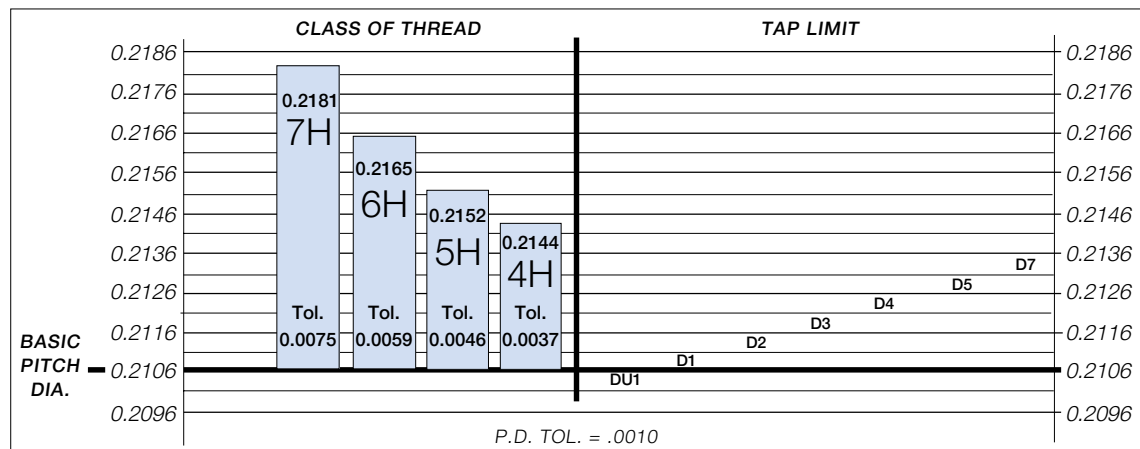

Chart 2B shows the same relationship with a metric thread. Using a M6 X 1.0, it is obvious that a D5 limit (+.0025" over basic pitch diameter) can be used to cut the standard class of thread in most machining situations, as can the D1 limit (+.0005" over basic P.D.).

However, tool wear would force the discarding of the D1 tap long before the D5 would be worn to an undersize condition. **The rule is obvious: always select the largest "D" limit possible to achieve proper class of fit, and maximum tool life.**

CHART 2B COMPARISON OF PITCH DIAMETER LIMITS TO CLASS OF FIT



SCREW THREAD CLASSES OVERVIEW

Screw thread classes are distinguished from each other by the amount of tolerance and allowance. Class 1A and Class 1B: The combination of Class 1A for external threads and Class 1B for internal threads is intended to cover the manufacture of threaded parts where quick and easy assembly is necessary or desired, and an allowance is provided to permit ready assembly. Class 2A and Class 2B: The combination of Class 2A for external threads and Class 2B for internal threads designed for screws, bolts and nuts, is also suitable for a variety of other applications. A similar allowance is provided

which minimizes galling and seizure encountered in assembly and use. It also accommodates, to a limited extent, plating, finishes or coatings. Class 3A and 3B: The combination of Class 3A for external threads and Class 3B for internal threads is provided for those applications where closeness of fit and accuracy of lead and angle of thread are important. These threads are obtained consistently only by use of high quality production equipment supported by a very efficient system of gauging and inspection. No allowance is provided.

DRILLS A  
 END MILLS B  
 ROUTERS C  
 THREAD MILLS & TAPS D  
 ENGRAVERS E  
 BORING BARS F  
 REAMERS G  
 SAWS H  
 TECHNICAL I  
 INDEX J

ILLUSTRATION OF TERMS APPLYING TO TAPS

- A DRILLS
- B END MILLS
- C ROUTERS
- D THREAD MILLS & TAPS**
- E ENGRAVERS
- F BORING BARS
- G REAMERS
- H SAWS
- I TECHNICAL
- J INDEX

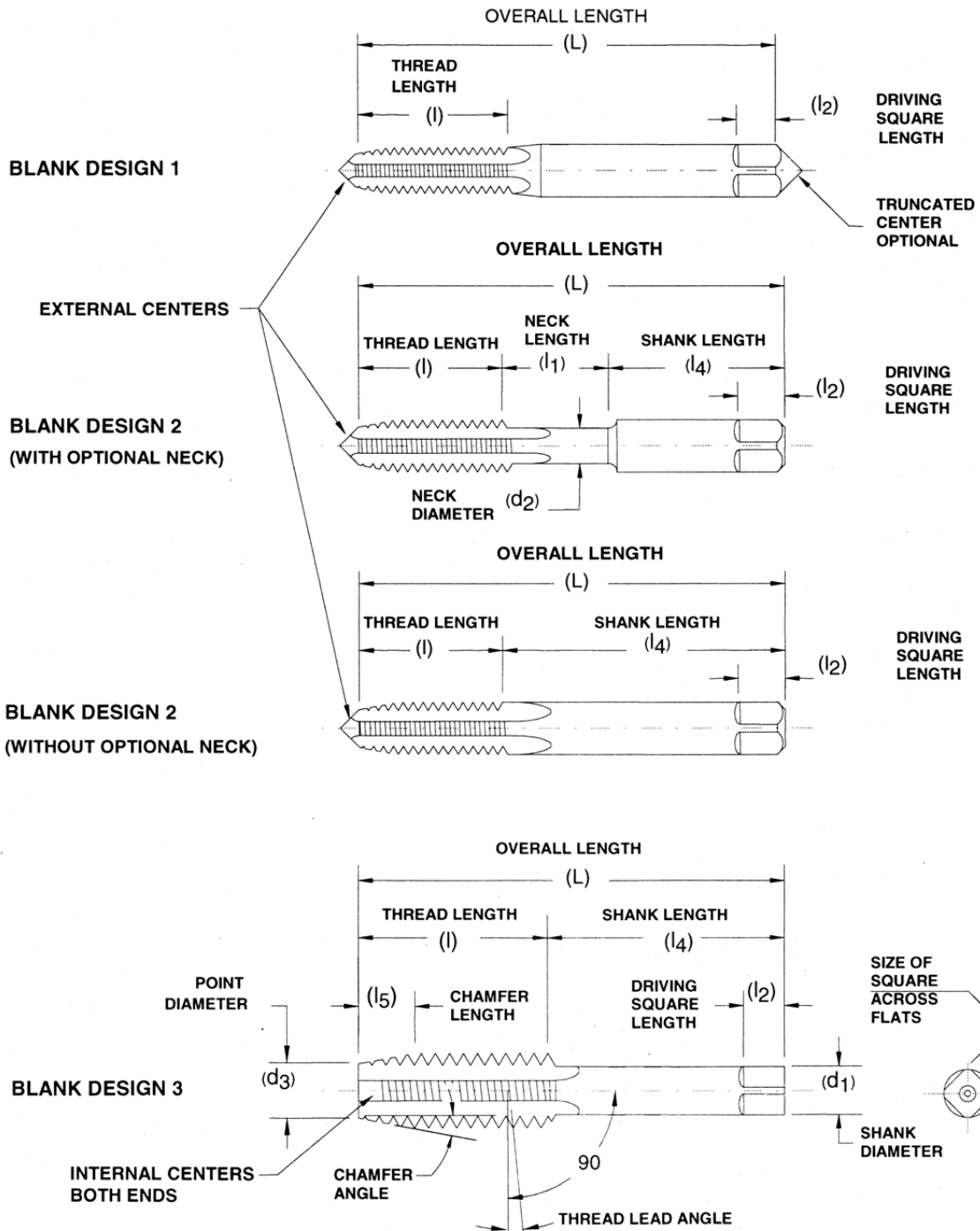
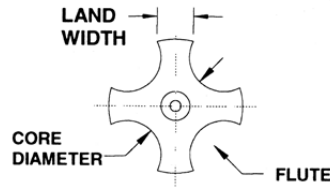
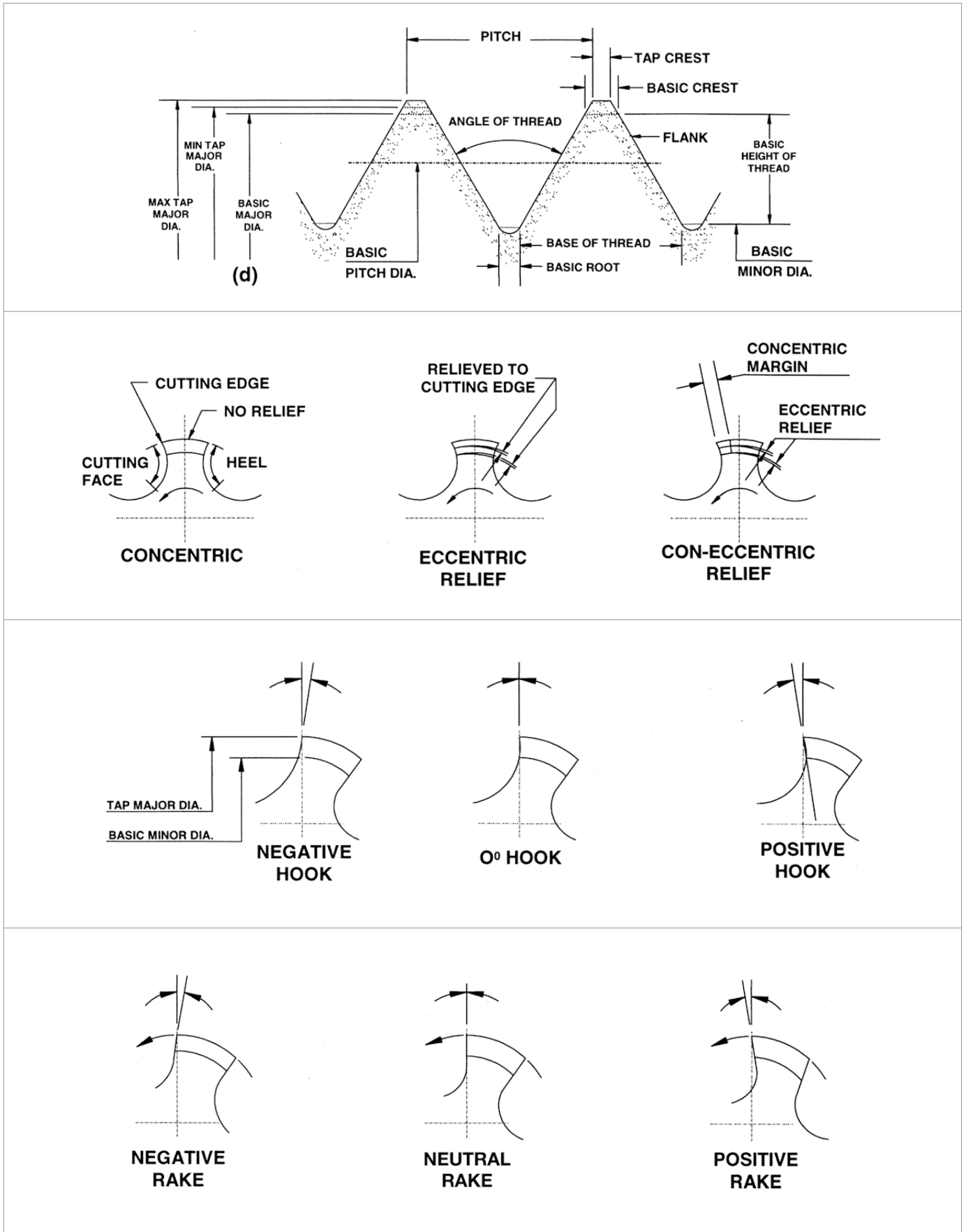



ILLUSTRATION OF TERMS APPLYING TO TAPS (cont.)



DRILLS	<b>A</b>
END MILLS	<b>B</b>
ROUTERS	<b>C</b>
THREAD MILLS & TAPS	<b>D</b>
ENGRAVERS	<b>E</b>
BORING BARS	<b>F</b>
REAMERS	<b>G</b>
SAWS	<b>H</b>
TECHNICAL	<b>I</b>
INDEX	<b>J</b>



## DEFINITION OF TERMS APPLYING TO TAPS

A	DRILLS	<p><b>ALLOWANCE</b> Minimum clearance between two mating parts; the prescribed variations from the basic size.</p>
B	END MILLS	<p><b>ANGLE OF THREAD</b> The angle included between the sides of the thread measured in an axial plane.</p>
C	ROUTERS	<p><b>AXIS</b> The imaginary straight line that forms the longitudinal center line of the tool or threaded part.</p>
D	THREAD MILLS & TAPS	<p><b>BACK TAPER</b> A gradual decrease in the diameter of the thread form on a tap from the chamfered end of the land towards the back which creates a slight radial relief in the threads.</p>
E	ENGRAVERS	<p><b>BASE OF THREAD</b> The bottom section of the thread; the greatest section between the two adjacent roots.</p>
F	BORING BARS	<p><b>BASIC SIZE</b> The theoretical or nominal standard size from which all variations are derived by application of allowances and tolerances.</p>
G	REAMERS	<p><b>CHAMFER</b> The tapering of the threads at the front end of each land of a tap by cutting away and relieving the crest of the first few teeth to distribute the cutting action over several teeth; Taper taps are chamfered 7-10 threads; plug taps are chamfered 3-5 threads; bottoming taps are chamfered 1-2 threads; taper pipe taps are chamfered 2-3.5 threads.</p>
H	SAWS	<p><b>CHAMFER RELIEF</b> The gradual decrease in land height from cutting edge to heel on the chamfered portion, to provide clearance for the cutting action as the tap advances.</p>
I	TECHNICAL	<p><b>CREST</b> The top surface joining the two sides or flanks of the thread; the crest of an external thread is at its major diameter, while the crest of an internal thread is at its minor diameter.</p>
J	INDEX	<p><b>CUTTING FACE</b> The leading side of the land in the direction of cutting rotation on which the chip forms.</p>
		<p><b>FLUTE</b> The longitudinal channels formed in a tap to create cutting edges on the thread profile, and to provide chip spaces and cutting fluid passages.</p>
		<p><b>HEEL</b> The edge of the land opposite the cutting edge.</p>
		<p><b>HEIGHT OF THREAD</b> The distance, measured radially, between the crest and the base of a thread.</p>

**HELIX ANGLE**

The angle made by the advance of the thread as it wraps around an imaginary cylinder.

**HOOK**

The undercut on the face of the teeth.

**HOOK ANGLE**

The inclination of a concave cutting face, usually specified either as Chordal Hook or Tangential Hook.

**Chordal Hook Angle:** The angle between the chord passing through the root and crest of a thread form at the cutting face, and a radial line through the crest at the cutting edge.

**Tangential Hook Angle:** The angle between a line tangent to a hook cutting face at the cutting edge and a radial line to the same point.

**INTERRUPTED THREAD TAP**

A tap having an odd number of lands with alternate teeth along the thread helix removed. In some cases alternate teeth are removed only for a portion of the thread length.

**LAND**

The part of the tap body which remains after the flutes are cut, and on which the threads are finally ground. The threaded section between the flutes of a tap.

**LEAD**

The axial distance a tap will advance along its axis in one complete turn. On a single start, the lead and the pitch are identical; on a double start, the lead is twice the pitch.

**MAJOR DIAMETER**

Commonly known as the "outside diameter." It is the largest diameter of the thread.

**MINOR DIAMETER**

Commonly known as the "root diameter." It is the smallest diameter of the thread.

**PERCENT OF THREAD**

One-half the difference between the basic major diameter and the actual minor diameter of an internal thread, divided by the basic thread height, expressed as a percentage.

**PITCH**

The distance from any point on a screw thread to a corresponding point on the next thread, measured parallel to the axis and on the same side of the axis. The pitch equals one divided by the number of threads per inch.

## DEFINITION OF TERMS APPLYING TO TAPS (cont.)

**PITCH DIAMETER**

On a straight thread, the pitch diameter is the diameter of the imaginary co-axial cylinder...the surface of which would pass through the thread profiles at such points as to make the width of the groove equal to one-half of the basic pitch. On a perfect thread this occurs at the point where the widths of the thread and groove are equal. On a taper thread, the pitch diameter at a given position on the thread axis is the diameter of the pitch cone at that position.

**RAKE**

The angular relationship of the straight cutting face of a tooth with respect to a radial line through the crest of the tooth at the cutting edge. Positive rake means that the crest of the cutting face is angularly ahead of the balance of the cutting face of the tooth. Negative rake means that the crest of the cutting face is angularly behind the balance of the cutting face of the tooth. Zero rake means that the cutting face is directly on a radial line.

**RELIEF (or Thread Relief)**

The removal of metal from behind the cutting edge to provide clearance and reduce friction between the part being threaded and the threaded land.

**ROOT**

The bottom surface joining the sides of two adjacent threads, and is identical with or immediately adjacent to the cylinder or cone from which the thread projects.

**SPIRAL FLUTE**

A flute with uniform axial lead in a spiral path around the axis of a tap.

**SPIRAL POINT**

The angular fluting in the cutting face of the land at the chamfered end; formed at an angle with respect to the tap axis of opposite hand to that of rotation. Its length is usually greater than the chamfer length and its angle with respect to the tap axis is usually made great enough to direct the chips ahead of the taps cutting action.

**STRAIGHT FLUTE**

A flute that forms a cutting edge lying in an axial plane.

**TOLERANCE**

In producing a tap to given specifications, tolerance is: (a.) the total permissible variation of a size; (b.) the difference between the limits of size.

## CHAMFERS FOR THREAD CUTTING TAPS

The tap chamfer is the tapering of the threads to distribute cutting action over several teeth. The type of hole to be tapped has much to do with the chamfer style of that tap that's best suited. Some holes go all the way through; some, while not through-holes, are relatively deep; some are quite shallow (a little deeper than diameter). Each of these three kinds of holes - through, deep-bottoming blind, and shallow bottoming - has a tap chamfer best suited to threading requirements.

**TAPER TAPS**

This style, with a **7-10 thread chamfer**, has the longest chamfer of the three to distribute action over the maximum number of teeth; and the taper also acts as a guide in starting the cutting action in the hole. Taper style taps start the thread square with the workpiece. Taper taps are commonly used in through holes and in materials where a tapered guide is necessary.

**PLUG TAPS**

This style, with a **3-5 thread chamfer**, is most widely used in through holes and where there is sufficient room at the bottom in blind holes.

**SEMI (or Modified) BOTTOMING TAPS**

This style, with a **2 to 2.5 thread chamfer**, should be used whenever possible in difficult material applications in blind holes, when threads are not required to the bottom of the hole.

**BOTTOMING TAPS**

This style, designed with a **1 to 2 thread chamfer**, is made with just enough chamfer for starting in the hole; as the name implies, it is designed to thread blind holes to the bottom.

**NOTE:** Taper, plug and bottoming taps as a set, in a given size (for example: 1/4-20 NC) are identical as to size, length and vital measurements; the difference is in the chamfered threaded portion at the point. As a rule, such taps when used by and are furnished in sets of three of a given size... namely, taper, plug and bottoming (and should be used in that order).

THREAD FORMING TAPS DATA

THREAD FORMING TAP ENTRY LENGTHS:

Entry taper length is measured on the full diameter of the thread forming lobes and is the axial distance from the entry diameter position to the theoretical intersection of tap major diameter and entry taper angle.

Whenever entry taper length is specified in terms of number of threads, this length is measured in number of pitches (p).  
 BOTTOMING LENGTH = 1-1/2 to 2-1/2 PITCHES  
 PLUG LENGTH = 3 to 5 PITCHES

The chamfer on BOTTOM taps is approximately 2 threads long and requires a drilled hole depth 3-4 pitches beyond the full thread required. When a controlled maximum chamfer shorter than 2 threads is required, an additional charge will apply. We will not guarantee the performance of taps with the shorter chamfer.

Entry diameter, measured at the thread crest nearest the front of the tap, is an appropriate amount smaller than the diameter of the hole drilled for tapping. See below for tap/drill size formulas, and formulas to determine maximum and minimum drill hole sizes for appropriate percent of thread.

**TAPPING SPEEDS:** Form taps operate most efficiently at spindle speeds 1-1/2 to 2 times faster than those recommended for conventional cutting taps, especially in softer materials and/or with fine pitch form taps. As higher

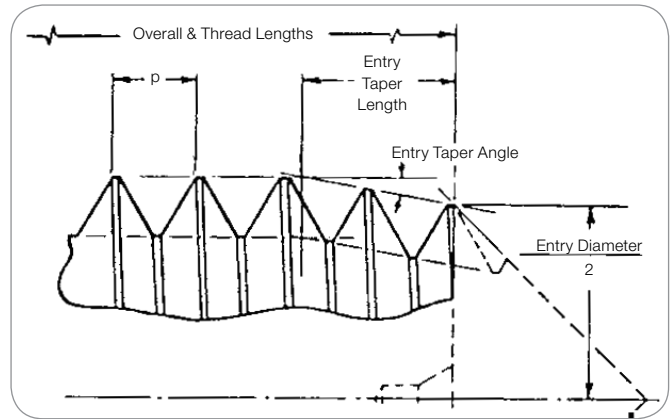

speeds are attained, adequate lubrication is essential for prolonged tap life and thread quality.

**LUBRICATION:** Since it is more important to 'lubricate' the cold-forming tap than to 'cool' the tap, form taps should be used with conventional lubricating cutting oils or EP (extreme pressure) rated oil...soluble oils and similar coolants are not recommended.

**PRE-TAPPED HOLE SIZE:** cold forming taps require a larger pre-tapped hole size than conventional cutting taps. To insure a properly tapped (cold formed) hole, adhere to the following:

FORMULA FOR TAP / DRILL SIZES FOR DECIMAL / INCH FORM TAPS:

$$\text{HOLE SIZE} = \text{Basic Tap O.D.} - \left( \frac{0.0068 \times \% \text{ of Thread}^*}{\text{Threads per Inch}} \right)$$

For example:

To determine drill size for a 1/4-20 thread forming tap at 65% of thread:  $0.250 - \left( \frac{0.0068 \times 65}{20} \right) = 0.2279$

\* Use whole number for % of thread...for 65%, use 65 (not 0.65).

FORMULA FOR TAP / DRILL SIZES FOR METRIC FORM TAPS:

$$\text{HOLE SIZE (mm)} = \text{Basic Tap O.D.(mm)} - \left( \frac{\% \text{ of Thread} \times \text{mm Pitch}}{147.06} \right)$$

\* Use whole number for % of thread...for 65%, use 65 (not .65).

There is no true method of predicting percent of thread that will be obtained when tapping with forming taps due to the many variables involved. As a starting point, however, 55% for maximum drill size and 75% for minimum drill size can be used as a guide. Any desired percent of thread can be approximated by using drill sizes in between. To determine theoretical maximum and minimum drill sizes (for average operating conditions), see formulas below.

For UNIFIED INCH Threads:

**Max. Drill Size** = Basic Major Diameter -  $\frac{3}{8N}$   
**Min. Drill Size** = Basic Major Diameter -  $\frac{1}{2N}$

N = T.P.I. (Threads per Inch)

For 60° Metric Threads:

**Max. Drill Size** = Basic Major Diameter - 0.375P  
**Min. Drill Size** = Basic Major Diameter - 0.5P

P = Pitch

Note: For Basic Major Diameter and Pitch, use millimeter value to obtain drill size in mm. To convert mm to inch value, divide by 25.4:

$$\frac{\text{mm Value}}{25.4} = \text{Inch Value}$$

**TAP RECOMMENDATIONS FOR CLASSES OF THREAD**

Unified and American National Screw Threads

Nominal Size	T.P.I. NC UNC	T.P.I. NF UNF	Recommended Tap for Class of Thread				Pitch Diameter Limits for Class of Thread				
			Class 2	Class 3	Class 2B	Class 3B	Min. All Classes (Basic)	Max. Class 2	Max. Class 3	Max. Class 2B	Max. Class 3B
0	-	80	GH1	GH1	GH2	GH1	0.0519	0.0536	0.0532	0.0542	0.0536
1	64	-	GH1	GH1	GH2	GH1	0.0629	0.0648	0.0643	0.0655	0.0648
1	-	72	GH1	GH1	GH2	GH1	0.0640	0.0658	0.0653	0.0665	0.0659
2	56	-	GH1	GH1	GH2	GH1	0.0744	0.0764	0.0759	0.0772	0.0765
2	-	64	GH1	GH1	GH2	GH1	0.0759	0.0778	0.0773	0.0786	0.0779
3	48	-	GH1	GH1	GH2	GH1	0.0855	0.0877	0.0871	0.0885	0.0877
3	-	56	GH1	GH1	GH2	GH1	0.0874	0.0894	0.0889	0.0902	0.0895
4	40	-	GH2	GH1	GH2	GH2	0.0958	0.0982	0.0975	0.0991	0.0982
4	-	48	GH1	GH1	GH2	GH1	0.0985	0.1007	0.1001	0.1016	0.1008
5	40	-	GH2	GH1	GH2	GH2	0.1088	0.1112	0.1105	0.1121	0.1113
5	-	44	GH1	GH1	GH2	GH1	0.1102	0.1125	0.1118	0.1134	0.1126
6	32	-	GH2	GH1	GH3	GH2	0.1177	0.1204	0.1196	0.1214	0.1204
6	-	40	GH2	GH1	GH2	GH2	0.1218	0.1242	0.1235	0.1252	0.1243
8	32	-	GH2	GH1	GH3	GH2	0.1437	0.1464	0.1456	0.1475	0.1465
8	-	36	GH2	GH1	GH2	GH2	0.1460	0.1485	0.1478	0.1496	0.1487
10	24	-	GH3	GH1	GH3	GH3	0.1629	0.1662	0.1653	0.1672	0.1661
10	-	32	GH2	GH1	GH3	GH2	0.1697	0.1724	0.1716	0.1736	0.1726
12	24	-	GH3	GH1	GH3	GH3	0.1889	0.1922	0.1913	0.1933	0.1922
12	-	28	GH3	GH1	GH3	GH3	0.1928	0.1959	0.1950	0.1970	0.1959
1/4	20	-	GH3	GH2	GH5	GH3	0.2175	0.2211	0.2201	0.2223	0.2211
1/4	-	28	GH3	GH1	GH4	GH3	0.2268	0.2299	0.2290	0.2311	0.2300
5/16	18	-	GH3	GH2	GH5	GH3	0.2764	0.2805	0.2794	0.2817	0.2803
5/16	-	24	GH3	GH1	GH4	GH3	0.2854	0.2887	0.2878	0.2902	0.2890
3/8	16	-	GH3	GH2	GH5	GH3	0.3344	0.3389	0.3376	0.3401	0.3387
3/8	-	24	GH3	GH1	GH4	GH3	0.3479	0.3512	0.3503	0.3528	0.3516
7/16	14	-	GH5	GH3	GH5	GH3	0.3911	0.3960	0.3947	0.3972	0.3957
7/16	-	20	GH3	GH1	GH5	GH3	0.4050	0.4086	0.4076	0.4104	0.4091
1/2	13	-	GH5	GH3	GH5	GH3	0.4500	0.4552	0.4537	0.4565	0.4548
1/2	-	20	GH3	GH1	GH5	GH3	0.4675	0.4711	0.4701	0.4731	0.4717
9/16	12	-	GH5	GH3	GH5	GH3	0.5084	0.5140	0.5124	0.5152	0.5135
9/16	-	18	GH3	GH2	GH5	GH3	0.5264	0.5305	0.5294	0.5323	0.5308
5/8	11	-	GH5	GH3	GH5	GH3	0.5660	0.5719	0.5702	0.5732	0.5714
5/8	-	18	GH3	GH2	GH5	GH3	0.5889	0.5930	0.5919	0.5949	0.5934
3/4	10	-	GH5	GH3	GH5	GH3	0.6850	0.6914	0.6895	0.6927	0.6907
3/4	-	16	GH3	GH2	GH5	GH3	0.7094	0.7139	0.7126	0.7159	0.7143
7/8	9	-	GH6	GH4	GH6	GH4	0.8028	0.8098	0.8077	0.8110	0.8089
7/8	-	14	GH4	GH2	GH6	GH4	0.8286	0.8335	0.8322	0.8356	0.8339
1	8	-	GH6	GH4	GH6	GH4	0.9188	0.9264	0.9242	0.9276	0.9254
1	-	12	GH4	GH2	GH6	GH4	0.9459	0.9515	0.9499	0.9535	0.9516
1	-	14*	GH4	GH2	GH6	GH4	0.9536	0.9585	0.9572	0.9609	0.9590
1-1/8	7	-	GH8	GH4	GH8	GH4	1.0322	1.0407	1.0381	1.0416	1.0393
1-1/8	-	12	GH4	GH4	GH6	GH4	1.0709	1.0765	1.0749	1.0787	1.0768
1-1/4	7	-	GH8	GH4	GH8	GH4	1.1572	1.1657	1.1631	1.1668	1.1644
1-1/4	-	12	GH4	GH4	GH6	GH4	1.1959	1.2015	1.1999	1.2039	1.2019
1-3/8	6	-	GH8	GH4	GH8	GH4	1.2667	1.2768	1.2738	1.2771	1.2745
1-3/8	-	12	GH4	GH4	GH6	GH4	1.3209	1.3265	1.3249	1.3291	1.327
1-1/2	6	-	GH8	GH4	GH8	GH4	1.3917	1.4018	1.3988	1.4022	1.3996
1-1/2	-	12	GH4	GH4	GH6	GH4	1.4459	1.4515	1.4499	1.4542	1.4522

\*UN

These are general tap recommendations to produce the Class of Thread indicated in average materials when used with reasonable care. However, if the tap specified does not give a satisfactory gage fit in the work, please consult the factory.

DRILLS **A**

END MILLS **B**

ROUTERS **C**

THREAD MILLS & TAPS **D**

ENGRAVERS **E**

BORING BARS **F**

REAMERS **G**

SAWS **H**

TECHNICAL **I**

INDEX **J**

## METRIC TAP RECOMMENDATIONS FOR CLASSES OF THREAD (ISO)

	Size mm	Pitch mm	Recommended Tap for Class of Thread		Pitch Diameter Limits for Class of Thread		
			4H	6H	Min. (Basic)	Max. 4H	Max. 6H
<b>A</b> DRILLS	M1.5	0.35	D1	D2	1.273	1.326	1.358
	M1.6	0.35	D1	D3	1.373	1.426	1.458
<b>B</b> END MILLS	M1.8	0.35	D1	D3	1.573	1.626	1.658
	M2	0.45	D1	D2	1.708	1.768	1.803
	M2	0.40	D1	D3	1.740	1.796	1.830
<b>C</b> ROUTERS	M2.2	0.45	D1	D3	1.908	1.968	2.003
	M2.3	0.40	D1	D2	2.040	2.096	2.130
	M2.5	0.45	D1	D3	2.208	2.268	2.303
<b>D</b> THREAD MILLS & TAPS	M2.6	0.45	D1	D2	2.308	2.368	2.403
	M3	0.60	D1	D2	2.610	2.681	2.722
<b>E</b> ENGRAVERS	M3	0.50	D1	D3	2.675	2.738	2.775
	M3.5	0.60	D1	D4	3.110	3.181	3.222
	M4	0.75	D2	D3	3.513	3.588	3.631
	M4	0.70	D2	D4	3.545	3.620	3.663
	M4.5	0.75	D2	D4	4.013	4.088	4.131
<b>F</b> BORING BARS	M5	1.00	D2	D3	4.350	4.440	4.490
	M5	0.90	D2	D3	4.415	4.501	4.549
	M5	0.80	D2	D4	4.480	4.560	4.605
	M5.5	0.90	D2	D3	4.915	5.002	5.050
<b>G</b> REAMERS	M6	1.00	D3	D5	5.350	5.445	5.500
	M6	0.75	D3	D4	5.513	5.598	5.645
	M7	1.00	D3	D5	6.350	6.445	6.500
	M7	0.75	D2	D4	6.513	6.598	6.645
	M8	1.25	D3	D5	7.188	7.288	7.348
<b>H</b> SAWS	M8	1.00	D3	D5	7.350	7.445	7.500
	M9	1.25	D3	D5	8.188	8.288	8.348
	M9	1.00	D3	D5	8.350	8.445	8.500
	M10	1.50	D3	D6	9.026	9.138	9.206
<b>I</b> TECHNICAL	M10	1.25	D3	D5	9.188	9.288	9.348
	M10	1.00	D3	D5	9.350	9.445	9.500
	M11	1.50	D3	D5	10.026	10.138	10.206
	M12	1.75	D3	D6	10.863	10.988	11.063
	M12	1.50	D3	D6	11.026	11.144	11.216
<b>J</b> INDEX	M12	1.25	D3	D5	11.188	11.300	11.368
	M14	2.00	D3	D7	12.701	12.833	12.913
	M14	1.50	D3	D6	13.026	13.144	13.216
	M14	1.25	D3	D5	13.188	13.300	13.368

These are general tap recommendations to produce the Class of Thread indicated in average materials when used with reasonable care. However, if the tap specified does not give a satisfactory gage fit in the work, please consult the factory.

## METRIC TAP RECOMMENDATIONS FOR CLASSES OF THREAD

(ISO) Cont.

Size mm	Pitch mm	Recommended Tap for Class of Thread		Pitch Diameter Limits for Class of Thread		
		4H	6H	Min. (Basic)	Max. 4H	Max. 6H
M16	2.00	D4	D7	14.701	14.833	14.913
M16	1.50	D3	D6	15.026	15.144	15.216
M17	1.50	D3	D5	16.026	16.144	16.216
M18	2.50	D4	D7	16.376	16.516	16.600
M18	2.00	D4	D6	16.701	16.833	16.913
M18	1.50	D3	D6	17.026	17.144	17.216
M19	2.50	D4	D6	17.376	17.516	17.600
M20	2.50	D4	D7	18.376	18.516	18.600
M20	2.00	D4	D6	18.701	18.833	18.913
M20	1.50	D3	D6	19.026	19.144	19.216
M22	2.50	D4	D7	20.376	20.516	20.600
M22	2.00	D4	D6	20.701	20.833	20.913
M22	1.50	D3	D6	21.026	21.144	21.216
M24	3.00	D4	D8	22.051	22.221	22.316
M24	2.00	D4	D7	22.701	22.841	22.925
M24	1.50	D3	D5	23.026	23.151	23.226
M25	2.00	D4	D7	23.701	23.841	23.925
M25	1.50	D3	D5	24.026	24.151	24.226
M26	3.00	D5	D8	24.051	24.221	24.316
M27	3.00	D5	D8	25.051	25.221	25.316
M27	2.00	D5	D7	25.701	25.841	25.925
M28	3.00	D5	D8	26.051	26.221	26.316
M28	2.00	D5	D7	26.701	26.841	26.925
M30	3.50	D5	D9	27.727	27.907	28.007
M30	3.00	D5	D8	28.051	28.221	28.316
M30	2.00	D5	D7	28.701	28.841	28.925
M32	3.50	D5	D9	29.727	29.907	30.007
M32	2.00	D5	D7	30.701	30.841	30.925
M33	3.50	D5	D9	30.727	30.907	31.007
M33	3.00	D5	D8	31.051	31.221	31.316
M33	2.00	D5	D7	31.701	31.841	31.925
M34	3.50	D5	D9	31.727	31.907	32.007
M36	4.00	D5	D9	33.402	33.592	33.702
M36	3.00	D5	D8	34.051	34.221	34.316
M36	2.00	D5	D7	34.701	34.841	34.925
M38	4.00	D5	D9	35.402	35.592	35.702
M39	4.00	D6	D9	36.402	36.592	36.702
M39	3.00	D6	D8	37.051	37.221	37.316
M39	2.00	D6	D7	37.701	37.841	37.925

These are general tap recommendations to produce the Class of Thread indicated in average materials when used with reasonable care. However, if the tap specified does not give a satisfactory gage fit in the work, please consult the factory.

**FORMULA FOR TAP / DRILL SIZES**  
(INCH)

METHOD 1

$$\text{Drilled Hole Size (in.)} = \text{Basic Major Dia. of Thread (in.)} - \frac{.013 \times \% \text{ of Full Thread}^*}{\# \text{ of Threads per Inch (T.P.I.)}$$

\* Use whole number for % of thread...for 65%, use 65 (not .65).

METHOD 2

$$\text{Nominal O.D.} - (\text{Dbl. Thread Depth} \times \% \text{ of Full Thread}) = \text{Drilled Hole Size}$$

*EXAMPLE: To find the hole size for obtaining 75% of thread in a 1/4-20 tapped hole, follow first column down to 20 threads, then across to 75% of thread. This figure (0.0485), when subtracted from the 0.250 diameter, is 0.2015, which is the required diameter of hole. See equation:*

$$0.2500 - 0.0485 = 0.2015$$

To figure whether or not pitch is too coarse for diameter:  
(Double thread depth) X 3 = x  
x = the smallest diameter possible for that T.P.I.

Threads per Inch	Double Thread Depth	50% Thread	55% Thread	60% Thread	65% Thread	70% Thread	75% Thread	80% Thread	85% Thread
6	0.21651	0.1083	0.1192	0.1300	0.1408	0.1517	0.1625	0.1733	0.1842
7	0.18558	0.0929	0.1021	0.1114	0.1207	0.1300	0.1393	0.1486	0.1579
8	0.16238	0.0813	0.0894	0.0975	0.1056	0.1138	0.1219	0.1300	0.1381
9	0.14434	0.0722	0.0794	0.0866	0.0939	0.1011	0.1083	0.1156	0.1228
10	0.12990	0.0649	0.0714	0.0779	0.0844	0.0909	0.0974	0.1039	0.1105
11	0.11809	0.0590	0.0649	0.0708	0.0767	0.0826	0.0885	0.0944	0.1005
12	0.10825	0.0541	0.0595	0.0649	0.0702	0.0755	0.0808	0.0861	0.0921
13	0.09992	0.0499	0.0549	0.0599	0.0649	0.0699	0.0749	0.0799	0.0850
14	0.09278	0.0464	0.0510	0.0556	0.0602	0.0648	0.0694	0.0740	0.0789
16	0.08119	0.0406	0.0446	0.0486	0.0526	0.0566	0.0606	0.0646	0.0691
18	0.07217	0.0361	0.0396	0.0431	0.0466	0.0501	0.0536	0.0571	0.0614
20	0.06495	0.0325	0.0357	0.0389	0.0421	0.0453	0.0485	0.0517	0.0553
24	0.05412	0.0270	0.0298	0.0326	0.0354	0.0382	0.0410	0.0438	0.0460
27	0.04811	0.0240	0.0264	0.0288	0.0312	0.0336	0.0360	0.0384	0.0409
28	0.04639	0.0232	0.0254	0.0276	0.0298	0.0324	0.0347	0.0370	0.0395
30	0.04330	0.0216	0.0238	0.0260	0.0282	0.0304	0.0326	0.0348	0.0368
32	0.04059	0.0203	0.0223	0.0243	0.0263	0.0283	0.0303	0.0323	0.0345
36	0.03608	0.0180	0.0198	0.0216	0.0234	0.0252	0.0270	0.0288	0.0307
40	0.03247	0.0162	0.0178	0.0194	0.0210	0.0226	0.0242	0.0258	0.0276
44	0.02952	0.0147	0.0162	0.0177	0.0192	0.0207	0.0222	0.0237	0.0251
48	0.02706	0.0135	0.0148	0.0161	0.0174	0.0187	0.0200	0.0213	0.0230
56	0.02319	0.0116	0.0127	0.0138	0.0149	0.0160	0.0171	0.0182	0.0197
64	0.02029	0.0101	0.0111	0.0121	0.0131	0.0141	0.0151	0.0161	0.0173
72	0.01804	0.0090	0.0099	0.0107	0.0115	0.0123	0.0131	0.0139	0.0153
80	0.01623	0.0081	0.0089	0.0097	0.0105	0.0113	0.0121	0.0129	0.0138

Figures in table show amount to subtract from O.D. of screw to obtain specific percentages of thread. Select nearest size commercial stock drill.



**FORMULA FOR TAP / DRILL SIZES**  
(METRIC)

METHOD 1

$$\text{Drilled Hole Size (mm)} = \text{Basic Major Dia. of Thread (mm)} - \frac{\% \text{ of Full Thread} \times \text{mm Pitch}}{76.98}$$

\* Use whole number for % of thread...for 65%, use 65 (not .65).

METHOD 2

Nominal O.D. - (Dbl. Thread Depth X % of Full Thread) = Drilled Hole Size

EXAMPLE: To find the hole size for obtaining 75% of thread in a (M6) 6mm x 1.00 tapped hole, follow first column down to 1.00 threads, then across to 75% of thread. This figure (0.9743), when subtracted from 6mm diameter, is 5.0257, which is the required diameter of hole. See equation:  
 $M6 - (1.2990 \times 75) = (6 - 0.9743) = 5.0257\text{mm}$

To figure whether or not pitch is too coarse for diameter:  
 (Double thread depth) X 3 = x  
 x = the smallest diameter possible for that T.P.I.

NOTE: All numbers are shown in millimeters (mm). To convert metric values to inches, divide by 25.4

mm Pitch	Double Thread Depth	50% Thread	55% Thread	60% Thread	65% Thread	70% Thread	75% Thread	80% Thread	85% Thread
4.00	5.19630	2.5982	2.8580	3.1178	3.3776	3.6374	3.8972	4.1570	4.4169
3.50	4.54660	2.2733	2.5006	2.7280	2.9553	3.1826	3.4100	3.6373	3.8646
3.00	3.89690	1.9485	2.1433	2.3381	2.5330	2.7278	2.9227	3.1175	3.3124
2.50	3.24760	1.6238	1.7862	1.9486	2.1109	2.2733	2.4357	2.5981	2.7605
2.00	2.59790	1.2990	1.4288	1.5587	1.6886	1.8185	1.9484	2.0783	2.2082
1.75	2.27330	1.1367	1.2503	1.3640	1.4776	1.5913	1.7050	1.8186	1.9323
1.50	1.94870	0.9744	1.0718	1.1692	1.2667	1.3641	1.4615	1.5590	1.6564
1.25	1.62360	0.8118	0.8930	0.9742	1.0553	1.1365	1.2177	1.2989	1.3801
1.00	1.29900	0.6495	0.7145	0.7794	0.8444	0.9093	0.9743	1.0392	1.1042
0.90	1.16870	0.5844	0.6428	0.7012	0.7597	0.8181	0.8765	0.9350	0.9934
0.80	1.03940	0.5197	0.5717	0.6236	0.6756	0.7276	0.7796	0.8315	0.8835
0.75	0.97430	0.4871	0.5359	0.5846	0.6333	0.6820	0.7307	0.7794	0.8282
0.70	0.90930	0.4547	0.5001	0.5456	0.5910	0.6365	0.6820	0.7274	0.7729
0.60	0.77930	0.3897	0.4286	0.4676	0.5065	0.5455	0.5845	0.6234	0.6624
0.50	0.64210	0.3211	0.3532	0.3853	0.4174	0.4495	0.4816	0.5137	0.5458
0.45	0.58470	0.2924	0.3216	0.3508	0.3801	0.4093	0.4385	0.4678	0.4970
0.40	0.51970	0.2599	0.2858	0.3118	0.3378	0.3638	0.3898	0.4158	0.4417
0.35	0.45470	0.2274	0.2501	0.2728	0.2956	0.3183	0.3410	0.3638	0.3865
0.30	0.38960	0.1948	0.2143	0.2338	0.2532	0.2727	0.2922	0.3117	0.3312
0.25	0.32460	0.1663	0.1785	0.1948	0.2110	0.2272	0.2434	0.2597	0.2759

Figures in table show amount to subtract from O.D. of screw to obtain specific percentages of thread. Select nearest size commercial stock drill.

DRILLS **A**

END MILLS **B**

ROUTERS **C**

THREAD MILLS & TAPS **D**

ENGRAVERS **E**

BORING BARS **F**

REAMERS **G**

SAWS **H**

TECHNICAL **I**

INDEX **J**

**MATERIAL HOOK OR RAKE ANGLES,  
SUGGESTED SURFACE TREATMENTS,  
CUTTING FLUIDS & CUTTING SPEEDS**  
(Starting Recommendations Only)

<b>A</b>	DRILLS
<b>B</b>	END MILLS
<b>C</b>	ROUTERS
<b>D</b>	THREAD MILLS & TAPS
<b>E</b>	ENGRAVERS
<b>F</b>	BORING BARS
<b>G</b>	REAMERS
<b>H</b>	SAWS
<b>I</b>	TECHNICAL
<b>J</b>	INDEX

Material To Be Tapped	Hook or Rake Angle	Suggested Surface Treatment**	Lubricant / Coolant	Speed / SFM
ALUMINUM (WROUGHT)	12° - 15° HOOK	TiN, TiCN	Soluble, Light Base, or Lard Oil	90 - 150
ALUMINUM DIE CASTING	8° - 10° HOOK	TiN, TiCN, CrN, TiAlN+WC/C	Soluble or Lard Oil	65 - 75
ALUMINUM BRONZE	0° - 3° RAKE	N, TiN	Mineral Oil w/Lard, or Light Oil	20 - 60
BAKELITE (HARD PLASTIC)	0° - 3° RAKE	TiCN	Dry or Air Jet	25 - 40
BERYLLIUM COPPER	12° - 14° HOOK	TiAlN+WC/C, CrN, N	Soluble Light Base Oil	50 - 90
BRASS	0° - 3° RAKE	None, TiCN	Soluble Light Base Oil	100 - 200
BRONZE (FREE-MACHINING)	2° - 6° HOOK	None, TiCN, N	Soluble Light Base Oil	80 - 150
CAST BRASS	2° - 5° RAKE	N, TiCN	Soluble Light Base Oil	100 - 200
CAST IRON (GRAY)	0° - 3° RAKE	N, TiCN	Dry or Soluble Oil	20 - 80
COPPER	18° HOOK	TiAlN+WC/C, CrN	Soluble Light Base Oil	80 - 150
COPPER - NICKEL	12° HOOK	N, TiCN	Soluble Light Base Oil	10 - 20
DELTRIN	5° - 8° HOOK	TiAlN+WC/C, TiN, N	Dry, Air Jet, or Water Soluble	65 - 100
DUCTILE IRON	3° - 6° HOOK	N+O, TiN, TiCN	Soluble or Sulphur Based Oils	30 - 50
DURALUMIN	12° - 14° HOOK	TiAlN+WC/C, CrN	Soluble or Lard Oil	50 - 90
FERRO-TIC	0° - 3° NEG RAKE	None	Anti-Seize Compound	8 - 20
FIBERGLASS	0° - 3° RAKE	TiCN	Dry or Air Jet	25 - 40
HASTELLOY	12° - 15° HOOK	CrN	Sulphur Based Oils	8 - 20
INCONEL	12° - 15° HOOK	N, CrN	Sulphur Based Oils	8 - 20
MAGNESIUM	18° - 20° HOOK (MUST)	CrN	Soluble Light Base Oil	100 - 150
MALLEABLE IRON	3° RAKE	N+O, TiN, TiCN	Soluble or Sulphur Based Oils	30 - 50
MANGANESE	0° - 3° RAKE	TiCN	Sulphur Based Oils	8 - 20
MANGANESE BRONZE	0° - 3° RAKE	N, TiCN	Soluble Light Base Oil	20 - 60
MOLYBDENUM	12° - 14° HOOK	N, TiN, TiCN	Sulphur Based Oils	20 - 45
MONEL	12° - 15° HOOK	N, TiCN	Sulphur Based Oils	8 - 20
NAVAL BRASS	0° - 3° RAKE	N	Soluble Light Base Oil	100 - 200
NAVAL BRONZE	2° - 6° HOOK	None, TiCN	Soluble Light Base Oil	80 - 150
NICKEL SILVER	0° - 3° RAKE	N, TiCN	Sulphur Based Oils	20 - 60
NICKEL (PURE)	12° - 15° HOOK	N, TiCN	Soluble Light Base Oil	5 - 25
NITRALLOY	0° RAKE	N, TiCN	Sulphur Based Oils	8 - 20
NITRONIC (*NO GUARANTEE)	12° - 14° POS RAKE	N, TiN, TiCN	Sulphur Based Oils	8 - 20
NYLON	5° - 8° HOOK	N, TiN	Dry, Air Jet or Water Soluble	65 - 100
PLASTICS:				
THERMOPLASTIC (SOFT)	5° - 8° HOOK	N, TiN	Dry, Air Jet or Water Soluble	65 - 100
ABS, DELTRIN, NYLON, PVC, etc.				
THERMOSETTING (HARD)	0° - 3° RAKE	TiCN	Dry or Air Jet	25 - 40
BAKELITE, L AMINATES,				
PHENOLIC, POLYESTERS, etc.				
POWDERED METAL (Sintered)	0° RAKE	TiCN	Soluble Light Base Oil	25 - 80
RUBBER, HARD	0° - 3° RAKE	None	Dry	50 - 200
SILICON BRONZE	0° - 3° RAKE	N, TiCN	Soluble Light Base Oil	20 - 60
STEEL:				
CARBON STEEL	10° - 12° HOOK	O, N, TiN	Sulphur Based Oils	40 - 90
COLD-ROLLED STEEL (1018, etc.)	10° - 12° HOOK	O, N, TiN	Sulphur Based Oils	40 - 90
FORGED	10° - 12° HOOK	O, N, TiN	Sulphur Based Oils	20 - 50
LEADED (12L14, etc.)	12° HOOK	O, N, TiN	Sulphur Based Oils	40 - 90
STAINLESS:				
FREE MACHINING	12° - 14° HOOK	N, TiN, TiCN	Sulphur Based Oils	20 - 40
PRECIP. HARDENING	12° - 14° HOOK	N, TiN, TiCN	Sulphur Based Oils	8 - 20
TOOL STEEL	12° - 14° HOOK	N, TiN, TiCN	Sulphur Based Oils	20 - 50
TITANIUM	15° - 20° HOOK	O, N, CrN	Sulphur Based Oils	20 - 50
TUNGSTEN	5° RAKE	TiN	Sulphur Based Oils	8 - 20
TURCITE (SOFT PLASTIC)	5° - 8° HOOK	N, TiN	Dry, Air Jet or Water Soluble	65 - 100
ZAMAK (ZINC DIE CAST)	10° - 12° RAKE	TiCN, TiN, CrN, TiAlN+WC/C	Soluble Light Base Oil	50 - 200
ZINC	10° - 12° RAKE	TiCN, TiN, CrN, TiAlN+WC/C	Soluble Light Base Oil	50 - 200

\* If problems are encountered when tapping nitronic (or any other material), please consult Tool Designers.

\*\* See page D46 for definitions of tool coating abbreviations.

## SPEEDS & FEEDS FOR TAPS

(Use Only as Suggested Starting R.P.M.)

### MACHINE SCREW AND FRACTIONAL SIZES

Inch Tap Size (UNC/UNF)	Inch Taper Pipe Taps (NPT/NPTF)	Surface Feet per Minute (SFM)																	
		5'	10'	15'	20'	25'	30'	40'	50'	60'	70'	80'	90'	100'	110'	120'	130'	140'	150'
		Revolutions per Minute (RPM)																	
0 (0.060)	-	318	637	955	1273	1592	1910	2546	3183	3820	4456	5093	5729	6366	7003	7639	8276	8913	9549
1 (0.073)	-	273	546	819	1046	1308	1570	2093	2617	3140	3663	4186	4710	5233	5756	6279	6805	7326	7849
2 (0.086)	-	212	424	637	888	1110	1333	1777	2221	2665	3109	3554	3999	4442	4886	5330	5774	6218	6662
3 (0.099)	-	191	382	573	772	964	1157	1543	1929	2315	2701	3086	3472	3858	4244	4629	5015	5401	5787
4 (0.112)	-	174	347	521	682	853	1023	1364	1705	2046	2387	2728	3069	3411	3751	4092	4434	4775	5116
5 (0.125)	-	147	294	441	611	764	917	1222	1528	1833	2139	2445	2750	3055	3361	3667	3973	4278	4584
6 (0.138)	-	136	273	409	553	691	829	1106	1362	1659	1935	2212	2488	2766	3042	3318	3595	3871	4148
8 (0.164)	-	119	239	358	466	563	699	932	1165	1398	1631	1864	2097	2330	2563	2796	3029	3262	3495
10 (0.190)	-	101	201	302	402	502	603	804	1005	1205	1406	1607	1808	2009	2210	2411	2612	2813	3014
12 (0.216)	-	87	174	260	354	442	531	707	884	1061	1238	1415	1592	1769	1945	2122	2300	2476	2653
14 (0.242)	-	79	158	237	316	395	474	631	789	947	1105	1263	1421	1579	1735	1894	2052	2210	2368
1/4	-	76	153	229	306	382	458	611	764	917	1070	1222	1375	1528	1681	1833	1986	2139	2292
5/16	1/16	62	123	185	245	306	367	489	611	733	856	978	1100	1222	1345	1467	1589	1711	1833
3/8	-	50	101	151	204	255	305	407	509	611	713	815	917	1019	1120	1222	1324	1426	1528
7/16	1/8	43	87	130	175	219	262	349	437	524	611	696	786	873	960	1048	1135	1222	1310
1/2	-	38	76	115	153	191	229	305	382	458	535	611	688	764	840	917	993	1070	1146
9/16	1/4	34	68	102	137	172	206	274	342	410	478	547	616	683	752	820	888	952	1020
5/8	-	32	64	96	122	153	183	244	305	367	428	489	550	611	672	733	794	856	917
11/16	3/8	28	55	83	111	138	167	222	278	333	369	444	500	556	611	667	722	778	833
3/4	-	25	51	76	102	128	153	203	255	305	357	407	458	509	560	611	662	713	764
7/8	1/2	22	43	65	87	109	131	175	218	262	306	350	392	437	480	524	568	611	655
1	-	19	38	57	76	96	115	153	191	230	268	305	344	382	420	458	497	535	573
1 1/8	3/4	17	34	51	68	84	102	136	170	204	238	272	306	340	373	407	441	475	509
1 1/4	-	15	31	46	61	76	92	122	153	183	214	244	275	305	336	367	397	428	458
1 3/8	1	14	28	42	56	69	83	111	139	167	194	222	250	278	306	333	361	389	417
1 1/2	-	13	25	38	51	63	76	102	127	152	178	204	229	255	280	305	331	356	382
1 5/5	-	12	23	35	47	59	71	94	118	141	165	188	212	235	259	282	306	329	353
13/4	1 1/4	11	22	33	44	55	65	87	109	131	153	175	196	218	240	262	284	306	327
17/8	1 1/2	10	20	30	41	51	61	81	102	122	143	163	183	204	224	244	265	285	306
2	-	9	19	29	38	48	57	76	96	115	134	153	172	191	210	229	248	267	287

### METRIC SIZES

Metric Tap Size	Decimal Equivalent Size	Surface Feet per Minute (SFM)																	
		5'	10'	15'	20'	25'	30'	40'	50'	60'	70'	80'	90'	100'	110'	120'	130'	140'	150'
		Revolutions per Minute (RPM)																	
M1	0.0394	490	979	1469	1959	2449	2938	3918	4897	5877	6856	7836	8815	9795	10774	11754	12733	13713	14692
M2	0.0787	242	484	725	967	1209	1451	1934	2418	2901	3385	3868	4352	4835	5319	5803	6286	6770	7253
M3	0.1181	162	324	486	647	809	971	1295	1619	1942	2266	2590	2914	3237	3561	3885	4208	4532	4855
M3.5	0.1378	138	277	415	554	692	830	1107	1384	1661	1935	2214	2491	2768	3045	3322	3599	3875	4152
M4	0.1575	122	243	365	487	608	730	973	1217	1460	1703	1946	2190	2433	2676	2920	3163	3406	3650
M5	0.1969	97	194	291	388	485	582	776	970	1163	1257	1551	1745	1939	2133	2327	2521	2715	2909
M6	0.2362	81	162	243	324	405	486	647	809	971	1133	1295	1457	1619	1781	1942	2104	2266	2428
M7	0.2756	69	138	208	277	346	415	554	692	830	969	1107	1246	1384	1522	1661	1799	1938	2076
M8	0.3150	61	121	182	243	303	364	485	606	728	849	970	1091	1213	1334	1455	1577	1696	1819
M10	0.3937	48	97	145	194	242	291	386	485	582	679	776	873	970	1067	1163	1260	1357	1454
M12	0.4724	40	81	121	162	202	243	324	405	486	567	647	728	809	890	971	1052	1133	1214
M14	0.5512	35	69	104	139	173	208	277	347	416	485	555	624	693	763	832	901	971	1040
M16	0.6299	30	61	91	121	152	182	243	303	364	424	485	546	606	667	728	788	849	910
M18	0.7087	27	54	81	108	135	162	216	269	323	377	431	485	539	593	647	700	754	808
M20	0.7874	24	49	73	97	121	146	194	243	291	340	388	437	485	534	582	631	680	728
M22	0.8661	22	44	66	88	110	132	175	221	265	309	353	397	441	485	529	573	618	662
M24	0.9449	20	40	61	81	101	121	162	202	243	283	323	364	404	445	485	526	566	606
M27	1.0630	18	35	54	72	90	108	144	180	216	252	287	323	359	395	431	467	503	539
M30	1.1811	16	32	49	65	81	97	129	162	194	226	259	291	323	356	388	420	453	485

### Factors to be Considered when Determining Tapping Speeds:

- Material to be tapped
- Depth of hole
- Length of chamfer on tap
- Pitch of thread
- Percentage of full thread to be cut
- Lubrication
- Machine equipment and rigidity
- Horizontal or vertical tapping

<b>Speeds &amp; Feeds Equations</b>	<b>INCH:</b>	S.F.M. = 0.26 X R.P.M. X TOOL DIAMETER	R.P.M. = $\frac{3.82 \times \text{S.F.M.}}{\text{TOOL DIAMETER}}$
	<b>METRIC:</b>	M/MIN. = $\frac{\pi \times \text{TOOL DIA.} \times \text{R.P.M.}}{1000}$	R.P.M. = $\frac{\text{m/min} \times 1000}{\pi \times \text{TOOL DIA.}}$

**STANDARD TAP DIMENSIONS / GROUND THREAD**

(Ref. USCTI Table 302)

General Dimensions

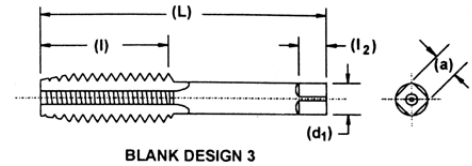
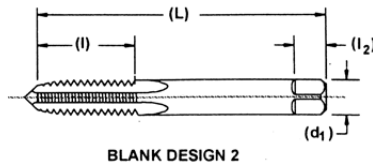
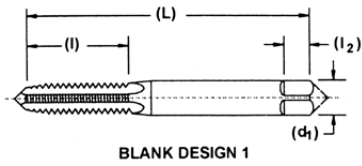

Nominal Diameter Range - Inches		Machine Screw Size No.		Nominal Fractional Diameter Inches	Nominal Metric Diameter Millimeters, (in)	Blank Design No.	Tap Dimensions - Inches				
							Overall Length L	Thread Length l	Square Length l <sub>2</sub>	Shank Dia. d <sub>1</sub>	Size of Square a
0.052	0.065	0	(0.0600)	-	M 1.6 (0.0630)	1	1.63	0.31	0.19	0.1410	0.1100
0.065	0.078	1	(0.0730)	-	M1.8 (0.0709)	1	1.69	0.38	0.19	0.1410	0.1100
0.078	0.091	2	(0.0860)	-	M2 (0.0787), M2.2 (0.0866)	1	1.75	0.44	0.19	0.1410	0.1100
0.091	0.104	3	(0.0990)	-	M2.5 (0.0984)	1	1.81	0.50	0.19	0.1410	0.1100
0.104	0.117	4	(0.1120)	-	-	1	1.88	0.56	0.19	0.1410	0.1100
0.117	0.130	5	(0.1250)	-	M3 (0.1181)	1	1.94	0.63	0.19	0.1410	0.1100
0.130	0.145	6	(0.1380)	-	M3.5 (0.1378)	1	2.00	0.69	0.19	0.1410	0.1100
0.145	0.171	8	(0.1640)	-	M4 (0.1575)	1	2.13	0.75	0.25	0.1680	0.1310
0.171	0.197	10	(0.1900)	-	M4.5 (0.1772), M5 (0.1969)	1	2.38	0.88	0.25	0.1940	0.1520
0.197	0.223	12	(0.2160)	-	-	1	2.38	0.94	0.28	0.2200	0.1650
0.223	0.260	-	1/4 (0.2500)	-	M6 (0.2362)	2	2.50	1.00	0.31	0.2550	0.1910
0.260	0.323	-	5/16 (0.3125)	-	M7 (0.2756), M8 (0.3150)	2	2.72	1.13	0.38	0.3180	0.2380
0.323	0.395	-	3/8 (0.3750)	-	M10 (0.3937)	2	2.94	1.25	0.44	0.3810	0.2860
0.395	0.448	-	7/16 (0.4375)	-	-	3	3.16	1.44	0.41	0.3230	0.2420
0.448	0.510	-	1/2 (0.5000)	-	M12 (0.4724)	3	3.38	1.66	0.44	0.3670	0.2750
0.510	0.573	-	9/16 (0.5625)	-	M14 (0.5512)	3	3.59	1.66	0.50	0.4290	0.3220
0.573	0.635	-	5/8 (0.6250)	-	M16 (0.6299)	3	3.81	1.81	0.56	0.4800	0.3600
0.635	0.709	-	11/16 (0.6875)	-	M18 (0.7087)	3	4.03	1.81	0.63	0.5420	0.4060
0.709	0.760	-	3/4 (0.7500)	-	-	3	4.25	2.00	0.69	0.5900	0.4420
0.760	0.823	-	13/16 (0.8125)	-	M20 (0.7874)	3	4.47	2.00	0.69	0.6520	0.4890
0.823	0.885	-	7/8 (0.8750)	-	M22 (0.8661)	3	4.69	2.22	0.75	0.6970	0.5230
0.885	0.948	-	15/16 (0.9375)	-	M24 (0.9449)	3	4.91	2.22	0.75	0.7600	0.5700
0.948	1.010	-	1 (1.0000)	-	M25 (0.9843)	3	5.13	2.50	0.81	0.8000	0.6000
1.010	1.073	-	1-1/16 (1.0625)	-	M27 (1.0630)	3	5.13	2.50	0.88	0.8960	0.6720
1.073	1.135	-	1-1/8 (1.1250)	-	-	3	5.44	2.56	0.88	0.8960	0.6720
1.135	1.198	-	1-3/16 (1.1875)	-	M30 (1.1811)	3	5.44	2.56	1.00	1.0210	0.7660
1.198	1.260	-	1-1/4 (1.2500)	-	-	3	5.75	2.56	1.00	1.0210	0.7660
1.260	1.323	-	1-5/16 (1.3125)	-	M33 (1.2992)	3	5.75	2.56	1.06	1.1080	0.8310
1.323	1.385	-	1-3/8 (1.3750)	-	-	3	6.06	3.00	1.06	1.1080	0.8310
1.385	1.448	-	1-7/16 (1.4375)	-	M36 (1.4173)	3	6.06	3.00	1.13	1.2330	0.9250
1.448	1.510	-	1-1/2 (1.5000)	-	-	3	6.38	3.00	1.13	1.2330	0.9250
1.510	1.635	-	1-5/8 (1.6250)	-	M39 (1.5354)	3	6.69	3.19	1.13	1.3050	0.9790
1.635	1.760	-	1-3/4 (1.7500)	-	M42 (1.6535)	3	7.00	3.19	1.25	1.4300	1.0720
1.760	1.885	-	1-7/8 (1.8750)	-	-	3	7.31	3.56	1.25	1.5190	1.1390
1.885	2.010	-	2 (2.0000)	-	M48 (1.8898)	3	7.63	3.56	1.38	1.6440	1.2330

(Continued on Next Page)

**STANDARD TAP DIMENSIONS / GROUND THREAD (Cont.)**

(Ref. USCTI Table 302)

General Dimensions

Nominal Diameter Range - Inches		Nominal Fractional Diameter Inches		Nominal Metric Diameter Millimeters, (in)	Blank Design No.	Tap Dimensions - Inches				
						Overall Length L	Thread Length l	Square Length l <sub>2</sub>	Shank Dia. d <sub>1</sub>	Size of Square a
2.010	2.135	2 1/8	(2.1250)	-	3	8.00	3.56	1.38	1.7690	1.3270
2.135	2.260	2 1/4	(2.2500)	M56 (2.2047)	3	8.25	3.56	1.44	1.8940	1.4200
2.260	2.385	2 3/8	(2.3750)	-	3	8.50	4.00	1.44	2.0190	1.5140
2.385	2.510	2 1/2	(2.5000)	-	3	8.75	4.00	1.50	2.1000	1.5750
2.510	2.635	2 5/8	(2.6250)	M64 (2.5197)	3	8.75	4.00	1.50	2.2250	1.6690
2.635	2.760	2 3/4	(2.7500)	-	3	9.25	4.00	1.56	2.3500	1.7620
2.760	2.885	2 7/8	(2.8750)	M72 (2.8346)	3	9.25	4.00	1.56	2.4750	1.8560
2.885	3.010	3	(3.0000)	-	3	9.75	4.56	1.63	2.5430	1.9070
3.010	3.135	3 1/8	(3.1250)	-	3	9.75	4.56	1.63	2.6680	2.0010
3.135	3.260	3 1/4	(3.2500)	M80 (3.1496)	3	10.00	4.56	1.75	2.7930	2.0950
3.260	3.385	3 3/8	(3.3750)	-	3	10.00	4.56	1.75	2.8830	2.1620
3.385	3.510	3 1/2	(3.5000)	-	3	10.25	4.94	2.00	3.0080	2.2560
3.510	3.635	3 5/8	(3.6250)	M90 (3.5433)	3	10.25	4.94	2.00	3.1330	2.3500
3.635	3.760	3 3/4	(3.7500)	-	3	10.50	5.31	2.13	3.2170	2.4130
3.760	3.885	3 7/8	(3.8750)	-	3	10.50	5.31	2.13	3.3420	2.5060
3.885	4.010	4	(4.0000)	M100 (3.9370)	3	10.75	5.31	2.25	3.4670	2.6000

**SPECIAL TAPS**

Unless otherwise specified:

Special taps over 1.010" to 1.510" diameter inclusive, having 14 or more threads per inch or 1.75 millimeter pitch and finer, and sizes over 1.510" diameter with 10 or more threads per inch or 2.5 millimeter pitch and finer, are made to general dimensions shown in Table 303 (USCTI).

Special tap thread limits are determined by using the formulas shown in Table 331 (USCTI) for Unified Inch Screw Threads and Table 341 (USCTI) for Metric M-Profile Screw Threads.

**NOTES**

Tap sizes 0.395" and smaller have an external center on the thread end (may be removed on bottoming taps). Sizes 0.223" and smaller have an external center on the shank end. Sizes 0.224" thru 0.395" have truncated partial cone centers on the shank end (length of cone approx. 1/4 of diameter of shank). Sizes over 0.395" have internal centers on both the thread and shank ends.

For standard thread limits and tolerances for Unified Inch Screw Threads see table 327 (USCTI) and for Metric Threads see Table 337 (USCTI).

For eccentricity tolerances of tap elements see Table 317 (USCTI).

Element	Nominal Diameter Range - Inches		Direction	Tolerance (in)
	Over	To (Inc.)		
Length Overall - L	0.0520	1.0100	Plus or Minus	0.0310
	1.0100	4.0100	Plus or Minus	0.0630
Length of Thread - l	0.0520	0.2230	Plus or Minus	0.0470
	0.2230	0.5100	Plus or Minus	0.0630
	0.5100	1.5100	Plus or Minus	0.0940
Length of Square - l <sub>2</sub>	0.0520	1.0100	Plus or Minus	0.0310
	1.0100	4.0100	Plus or Minus	0.0630
	0.0520	0.2230	Minus	0.0015
Diameter of Shank - d <sub>1</sub>	0.2230	0.6350	Minus	0.0015
	0.6350	1.0100	Minus	0.0020
	1.0100	1.5100	Minus	0.0020
	1.5100	2.0100	Minus	0.0030
	2.0100	4.0100	Minus	0.0030
	0.0520	0.5100	Minus	0.0040
Size of Square - a	0.5100	1.0100	Minus	0.0060
	1.0100	2.0100	Minus	0.0080
	2.0100	4.0100	Minus	0.0100

DRILLS **A**

END MILLS **B**

ROUTERS **C**

THREAD MILLS & TAPS **D**

ENGRAVERS **E**

BORING BARS **F**

REAMERS **G**

SAWS **H**

TECHNICAL **I**

INDEX **J**

**OPTIONAL NECK AND SHORTENED THREAD LENGTH**

Tap Dimensions, Ground Thread

(Ref. USCTI Table 302-A)

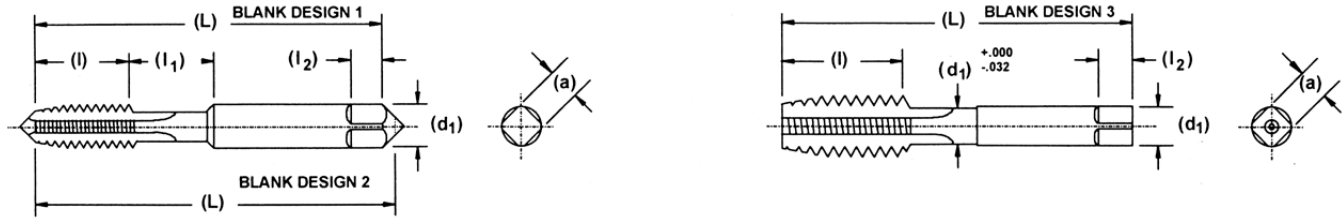

Nominal Diameter Range - Inches	Machine Screw Size No.	Nominal Fractional Diameter Inches	Nominal Metric Diameter Millimeters, (in)	Blank Design No.	Tap Dimensions - Inches					
					Overall Length L	Thread Length l	Thread Length l <sub>1</sub>	Square Length l <sub>2</sub>	Shank Dia. d <sub>1</sub>	Size of Square a
0.104	0.117	4 (0.1120)	-	1	1.88	0.31	0.25	0.19	0.1410	0.1100
0.117	0.130	5 (0.1250)	M3 (0.1181)	1	1.94	0.31	0.31	0.19	0.1410	0.1100
0.130	0.145	6 (0.1380)	M3.5 (0.1378)	1	2.00	0.38	0.31	0.19	0.1410	0.1100
0.145	0.171	8 (0.1640)	M4 (0.1575)	1	2.13	0.38	0.38	0.25	0.1680	0.1310
0.171	0.197	10 (0.1900)	M4.5 (0.1772), M5 (0.1969)	1	2.38	0.50	0.38	0.25	0.1940	0.1520
0.197	0.223	12 (0.2160)	-	1	2.38	0.50	0.44	0.28	0.2200	0.1650
0.223	0.260	-	1/4 (0.2500)	2	2.50	0.63	0.38	0.31	0.2550	0.1910
0.260	0.323	-	5/16 (0.3125)	2	2.72	0.69	0.44	0.38	0.3180	0.2380
0.323	0.395	-	3/8 (0.3750)	2	2.94	0.75	0.50	0.44	0.3810	0.2860
0.395	0.448	-	7/16 (0.4375)	3	3.16	0.88	-	0.41	0.3230	0.2420
0.448	0.510	-	1/2 (0.5000)	3	3.38	0.94	-	0.44	0.3670	0.2750
0.510	0.573	-	9/16 (0.5625)	3	3.59	1.00	-	0.50	0.4290	0.3220
0.573	0.635	-	5/8 (0.6250)	3	3.81	1.09	-	0.56	0.4800	0.3600
0.635	0.709	-	11/16 (0.6875)	3	4.03	1.09	-	0.63	0.5420	0.4060
0.709	0.760	-	3/4 (0.7500)	3	4.25	1.22	-	0.69	0.5900	0.4420
0.760	0.823	-	13/16 (0.8125)	3	4.47	1.22	-	0.69	0.6520	0.4890
0.823	0.885	-	7/8 (0.8750)	3	4.69	1.34	-	0.75	0.6970	0.5230
0.885	0.948	-	15/16 (0.9375)	3	4.91	1.34	-	0.75	0.7600	0.5700
0.948	1.010	-	1 (1.0000)	3	5.13	1.50	-	0.81	0.8000	0.6000

**NOTES**

1. Thread Length "l" is based on a length of 12 pitches of the UNC thread series.
2. Thread Length "l" is a minimum value and has no tolerance.
3. When Thread Length "l" is added to Neck Length "l<sub>1</sub>" the total shall be no less than the minimum Table 302 Thread Length "l".
4. Unless otherwise specified, all tolerances are in accordance with Table 302.
5. For eccentricity tolerances, see Table 317.

**SPECIAL FINE PITCH TAPS / SHORT SERIES**

Tap Dimensions, Ground Thread  
(Ref. USCTI Table 303)

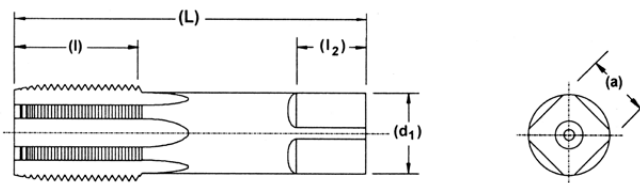

Unless otherwise specified, special taps 1.010" to 1.510" diameter inclusive, having 14 or more threads per inch or 1.75mm pitch and finer, and sizes over 1.510" diameter with 10 or more threads per inch, or 2.5mm pitch and finer, will be made to the general dimensions shown below:

Nominal Diameter Range - Inches		Nominal Fractional Diameter Inches	Nominal Metric Diameter Millimeters, (in)	Tap Dimensions - Inches				
Over	To (Inc.)			Overall Length L	Thread Length l	Square Length l <sub>2</sub>	Shank Dia. d <sub>1</sub>	Size of Square a
1.010	1.073	1 1/16	M27	4.00	1.50	0.88	0.8960	0.6720
1.073	1.135	1 1/8	-	4.00	1.50	0.88	0.8960	0.6720
1.135	1.198	1 3/16	M30	4.00	1.50	1.00	1.0210	0.7660
1.198	1.260	1 1/4	-	4.00	1.50	1.00	1.0210	0.7660
1.260	1.323	1 5/16	M33	4.00	1.50	1.00	1.1080	0.8310
1.323	1.385	1 3/8	-	4.00	1.50	1.00	1.1080	0.8310
1.385	1.448	1 7/16	M36	4.00	1.50	1.00	1.2330	0.9250
1.448	1.510	1 1/2	-	4.00	1.50	1.00	1.2330	0.9250
1.510	1.635	1 5/8	M39	5.00	2.00	1.13	1.3050	0.9790
1.635	1.760	1 3/4	M42	5.00	2.00	1.25	1.4300	1.0720
1.760	1.885	1 7/8	-	5.00	2.00	1.25	1.5190	1.1390
1.885	2.010	2	M48	5.00	2.00	1.38	1.6440	1.2330
2.010	2.135	2 1/8	-	5.25	2.00	1.38	1.7690	1.3270
2.135	2.260	2 1/4	M56	5.25	2.00	1.44	1.8940	1.4200
2.260	2.385	2 3/8	-	5.25	2.00	1.44	2.0190	1.5140
2.385	2.510	2 1/2	-	5.25	2.00	1.50	2.1000	1.5750
2.510	2.635	2 5/8	M64	5.50	2.00	1.50	2.1000	1.5750
2.635	2.760	2 3/4	-	5.50	2.00	1.50	2.1000	1.5750
2.760	2.885	2 7/8	M72	5.50	2.00	1.50	2.1000	1.5750
2.885	3.010	3	-	5.50	2.00	1.50	2.1000	1.5750
3.010	3.135	3 1/8	-	5.75	2.00	1.50	2.1000	1.5750
3.135	3.260	3 1/4	M80	5.75	2.00	1.50	2.1000	1.5750
3.260	3.385	3 3/8	-	5.75	2.00	1.50	2.1000	1.5750
3.385	3.510	3 1/2	-	5.75	2.00	1.50	2.1000	1.5750
3.510	3.635	3 5/8	M90	6.00	2.00	1.75	2.1000	1.5750
3.635	3.760	3 3/4	-	6.00	2.00	1.75	2.1000	1.5750
3.760	3.885	3 7/8	-	6.00	2.00	1.75	2.1000	1.5750
3.885	4.010	4	M100	6.00	2.00	1.75	2.1000	1.5750

**NOTES**

- For tolerances see Table 302.
- For standard thread limits and tolerances for Unified Inch Screw Threads see Table 327A.
- For standard thread limits and tolerances for Metric Threads see Tables 337 and 341.
- For eccentricity tolerances of tap elements see Table 317.

DRILLS **A**

END MILLS **B**

ROUTERS **C**

THREAD MILLS & TAPS **D**

ENGRAVERS **E**

BORING BARS **F**

REAMERS **G**

SAWS **H**

TECHNICAL **I**

INDEX **J**



**SPECIAL EXTENSION TAPS**

Ground Thread

(Ref. USCTI Table 303-A)

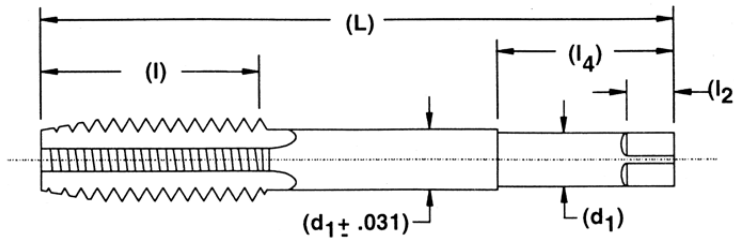

Unless otherwise specified, special extension taps will be furnished with dimensions and tolerances as shown for Machine Screw and Fractional taps in Tables 302 and 303, and for Pipe taps in Table 311.

Exceptions:

1. Types of centers are optional with manufacturer.
2. Tolerances on shank diameter  $d_1$  for  $l_4$  length as shown in the following table.
3. Shank eccentricity tolerance in Table 317 applies only to the  $l_4$  length shown in the following table.
4. Length of Close Tolerance Shank,  $(L_4)$  is minimum.

Nominal Tap Size		Thread Length $l$	Shank Dia. $d_1$	Square Length $l_2$	Size of Square	Ground Shank Length $l_4$
Fractional	Machine Screw					
-	6	0.688	0.141	0.188	0.110	1.13
-	8	0.750	0.168	0.250	0.131	1.25
-	10 - 12	0.875	0.194	0.250	0.152	1.38
1/4	14	1.000	0.255	0.313	0.191	1.50
1/4*	-	1.000	0.185	0.250	0.138	Full Length
5/16	-	1.130	0.318	0.375	0.238	1.56
5/16*	-	1.130	0.240	0.281	0.180	Full Length
3/8	-	1.250	0.381	0.438	0.286	1.63
3/8*	-	1.250	0.275	0.375	0.206	Full Length
7/16	-	1.440	0.323	0.406	0.242	1.69
1/2	-	1.660	0.367	0.438	0.275	1.69
9/16	-	1.660	0.429	0.500	0.322	1.88
5/8	-	1.810	0.480	0.563	0.360	2.00
3/4	-	2.000	0.590	0.688	0.442	2.25
7/8	-	2.220	0.697	0.750	0.523	2.50
1	-	2.500	0.800	0.813	0.600	2.63
1-1/8	-	2.560	0.896	0.875	0.672	2.75
1-1/4	-	2.560	1.021	1.000	0.766	2.88
1-3/8	-	3.000	1.108	1.063	0.831	3.00
1-1/2	-	3.000	1.233	1.125	0.925	3.00

\* Small Shank

Tolerances  
for Shank Diameter,  $d_1$  and  $l_4$  length

Size Range		Direction	Tolerance (in)
Fractional	Machine Screw		
1/4 to 5/8 incl.	0 - 14 incl.	Minus	0.003
11/16 to 1-1/2 incl.		Minus	0.004

**PULLEY TAP DIMENSIONS**

Tap Dimensions, Ground Thread  
(Ref. USCTI Table 310)

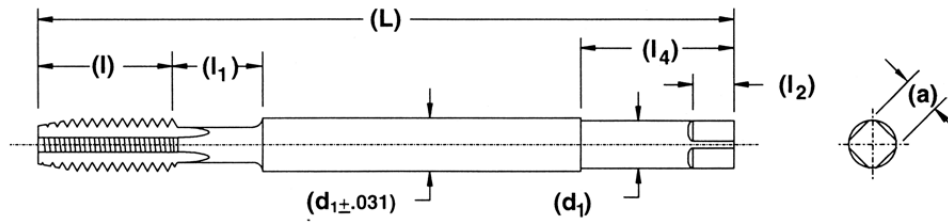

Nominal Fractional Diameter Inches	Tap Dimensions - Inches						
	Overall Length L	Thread Length l	Neck Length l <sub>1</sub>	Square Length l <sub>2</sub>	Length of Shank Close Tol. Section l <sub>4</sub>	Shank Dia. d <sub>1</sub>	Size of Square a
1/4 (.2500)	6,8	1.00	0.38	0.31	1.50	0.2550	0.1910
5/16 (.3125)	6,8	1.13	0.38	0.38	1.56	0.3180	0.2380
3/8 (.3750)	6, 8, 10	1.25	0.38	0.44	1.63	0.3810	0.2860
7/16 (.4375)	6,8	1.44	0.44	0.50	1.69	0.4440	0.3330
1/2 (.5000)	6, 8, 10, 12	1.66	0.50	0.56	1.69	0.5070	0.3800
5/8 (.6250)	6, 8, 10, 12	1.81	0.63	0.69	2.00	0.6330	0.4750
3/4 (.7500)	10, 12	2.00	0.75	0.75	2.25	0.7590	0.5690

Tolerances

Element	Size Range	Direction	Tolerance
Overall Length - L	1/4 to 3/4 inc.	Plus or Minus	0.063
Thread Length - l	1/4 to 3/4 inc.	Plus or Minus	0.063
Neck Length - l <sub>1</sub>	1/4 to 3/4 inc.	See Note - 1	See Note - 1
Square Length - l <sub>2</sub>	1/4 to 3/4 inc.	Plus or Minus	0.031
Length of Shank (close tol.) - l <sub>4</sub>	1/4 to 3/4 inc.	See Note - 2	See Note - 2
Shank Diameter - d <sub>1</sub>	1/4 to 3/4 inc.	Minus	0.005
Size of Square - a	1/4 to 1/2 inc.	Minus	0.004
	5/8 to 3/4 inc.	Minus	0.006

NOTES

- l<sub>1</sub>, (Neck Length); neck and its length is optional with manufacturer.
- l<sub>4</sub>, (Length of Close Tolerance Shank) is minimum length which is held to eccentricity tolerances per Table 317.

GENERAL NOTES

- These taps have an internal center in the thread end.
- These taps are made to the H3 limits shown in Table 327.
- For eccentricity tolerances of taps elements see Table 317.
- d<sub>1</sub>, (Shank diameter) is approximately the same as the maximum major diameter for that size.
- a, (Size of Square) is equal to .75 X d<sub>1</sub> to the nearest .001 inch.

DRILLS A  
 END MILLS B  
 ROUTERS C  
 THREAD MILLS & TAPS D  
 ENGRAVERS E  
 BORING BARS F  
 REAMERS G  
 SAWS H  
 TECHNICAL I  
 INDEX J

**STANDARD PIPE TAP / STRAIGHT & TAPER**

Ground Thread  
(Ref. USCTI Table 311)

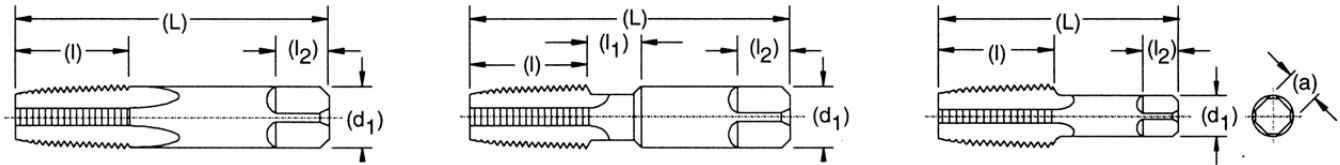

Tap Dimensions - Inches						
Nominal Size Inches	Overall Length L	Thread Length l	Square Length l <sub>2</sub>	Shank Dia. d <sub>1</sub>	Size of Square a	Optional Neck Length l <sub>1</sub>
1/16	2.13	0.69	0.38	0.3125	0.2340	0.3750
1/8*	2.13	0.75	0.38	0.3125	0.2340	-
1/8	2.13	0.75	0.38	0.4375	0.3280	0.3750
1/4	2.44	1.06	0.44	0.5625	0.4210	0.3750
3/8	2.56	1.06	0.50	0.7000	0.5310	0.3750
1/2	3.13	1.38	0.63	0.6875	0.5150	-
3/4	3.25	1.38	0.69	0.9063	0.6790	-
1	3.75	1.75	0.81	1.1250	0.8430	-
1-1/4	4.00	1.75	0.94	1.3125	0.9840	-
1-1/2	4.25	1.75	1.00	1.5000	1.1250	-
2	4.50	1.75	1.13	1.8750	1.4060	-
2-1/2	5.50	2.56	1.25	2.2500	1.6870	-
3	6.00	2.63	1.38	2.6250	1.9680	-
3-1/2	6.50	2.69	1.50	2.8125	2.1080	-
4	6.75	2.75	1.56	3.0000	2.2500	-

\* Small Shank

Tolerances

Element	Size Range	Direction	Tolerance
Overall Length - L	1/16 to 3/4 inc.	Plus or Minus	0.0310
	1 to 4 inc.	Plus or Minus	0.0630
Thread Length - l	1/16 to 3/4 inc.	Plus or Minus	0.0630
	1 to 1-1/4 inc.	Plus or Minus	0.0940
	1-1/2 to 4	Plus or Minus	0.1250
Square Length - l <sub>2</sub>	1/16 to 3/4 inc.	Plus or Minus	0.0310
	1 to 4 inc.	Plus or Minus	0.0630
Shank Diameter - d <sub>1</sub>	1/16 to 1/8	Minus	0.0015
	1/4 to 1 inc.	Minus	0.0020
	1-1/4 to 4 inc.	Minus	0.0030
Size of Square - a	1/16 to 1/8	Minus	0.0040
	1/4 to 3/4 inc.	Minus	0.0060
	1 to 4 inc.	Minus	0.0080

NOTE: For thread limits and tolerances see USCTI Tables 335, 335A and 338. For eccentricity tolerances of taps see Table 317.

**TAPER PIPE TAP / THREAD LIMITS**

Ground Thread

(Ref. USCTI Table 338)

- American National Standard Taper Pipe Thread Form (NPT)
- Aeronautical National Taper Pipe Thread Form (ANPT)
- Dryseal American National Standard Taper Pipe Thread Form (NPTF)

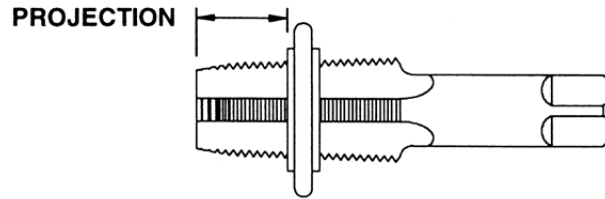

Tap Thread Limits							
Nominal Size Inches	Threads Per Inch	Projection* Inches	Projection Tolerance + or -	Taper Per Foot Limits		Length L <sub>1</sub>	Tap Drill Size ** NPT, ANPT, NPTF
				MIN	MAX		
1/16	27	0.3120	0.0630	0.7190	0.7810	0.1600	C
1/8	27	0.3120	0.0630	0.7190	0.7810	0.1615	Q
1/4	18	0.4590	0.0630	0.7190	0.7810	0.2278	7/16
3/8	18	0.4540	0.0630	0.7190	0.7810	0.2400	9/16
1/2	14	0.5790	0.0630	0.7190	0.7810	0.3200	45/64
3/4	14	0.5650	0.0630	0.7190	0.7810	0.3390	29/32
1	11-1/2	0.6780	0.0940	0.7190	0.7810	0.4000	1-9/64
1-1/4	11-1/2	0.6860	0.0940	0.7190	0.7810	0.4200	1-31/64
1-1/2	11-1/2	0.6990	0.0940	0.7190	0.7810	0.4200	1-23/32
2	11-1/2	0.6670	0.0940	0.7190	0.7810	0.4360	2-3/16
2-1/2	8	0.9250	0.0940	0.7340	0.7810	0.6820	2-39/64
3	8	0.9250	0.0940	0.7340	0.7810	0.7660	3-15/64
3-1/2	8	0.9380	0.1250	0.7340	0.7810	0.8210	-
4	8	0.9500	0.1250	0.7340	0.7810	0.8440	-

**NOTES**

\* Distance small end of tap projects through L<sub>1</sub> Taper Thread Ring Gage.

\*\* Recommended size given permit direct tapping without reaming the hole, but only give a full thread for approx. the L<sub>1</sub> length.

**LEAD TOLERANCE**

A maximum lead deviation of plus or minus .0005" within any two threads not farther than 1" is permitted.

DRILLS **A**

END MILLS **B**

ROUTERS **C**

THREAD MILLS & TAPS **D**

ENGRAVERS **E**

BORING BARS **F**

REAMERS **G**

SAWS **H**

TECHNICAL **I**

INDEX **J**

**ECCENTRICITY TOLERANCES OF TAP ELEMENTS**

When Tested on Dead Centers

(Ref. USCTI Table 317)

Applicable to Tables 302, 303, 303A, and 311

Element	Size Range			Ground Thread	
	Inch & Mach. Screw	Pipe	Metric	Eccentricity	t.i.v.*
Square (at central point)	#0 - 1/2	1/16 - 1/8	M1.6 - M12	0.0030	0.0060
	Over 1/2 Thru 4	1/4 - 4	Over M12 Thru M100	0.0040	0.0080
Shank	#0 - 5/16	1/16	M1.6 - M8	0.0005	0.0010
	Over 5/16 Thru 4	1/8 - 4	Over M8 Thru M100	0.0008	0.0016
Major Diameter	#0 - 5/16	1/16	M1.6 - M8	0.0005	0.0010
	Over 5/16 Thru 4	1/8 - 4	Over M8 Thru M100	0.0008	0.0016
Pitch Diameter (at first full thread)	#0 - 1/2	1/16	M1.6 - M8	0.0005	0.0010
	Over 1/2 Thru 4	1/8 - 4	Over M8 Thru M100	0.0008	0.0016
Chamfer **	#0 - 1/2	1/16 - 1/8	M1.6 - M12	0.0010	0.0020
	Over 1/2 Thru 4	1/4 - 4	Over M12 Thru M100	0.0015	0.0030

\* t.i.v. = Total indicator variation. Figures are given for both eccentricity and total indicator variation to avoid misunderstanding.

\*\* Chamfer should preferably be inspected by light projection to avoid errors due to indicator contact points dropping into the grooves.

**COATING ABBREVIATIONS**See **Page 196** for Coating Recommendations

<b>CrN:</b>	Chromium Nitride	<b>TiAlN:</b>	Titanium Aluminum Nitride
<b>N:</b>	Nitride	<b>TiCN:</b>	Titanium Carbonitride
<b>N + O:</b>	Nitride + Oxide	<b>TiN:</b>	Titanium Nitride
<b>O:</b>	Stream Oxide	<b>WC/C:</b>	Tungsten Carbide / Carbon
<b>AlCrN</b>	Aluminum Chromium Nitride	<b>DLC:</b>	Diamond-like Carbon

TANDEM ACME TAP DIMENSIONS

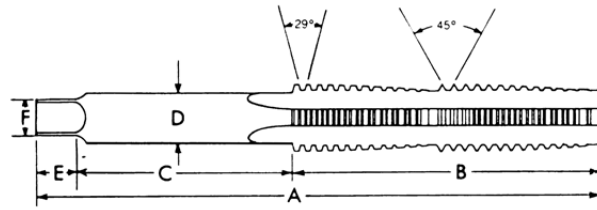

Size & Pitch	Overall Length A	Thread Length B	Round Shank		Square		Maximum Depth of Nut	
			Length C	Diameter D	Length E	Across Flats F	Bronze & Steel	Brass & Cast Iron
1/4-16	3	13/4	1	0.185	1/4	0.138	1/2	3/4
5/16-14	3 13/32	17/8	1 1/4	0.220	9/32	0.165	5/8	7/8
3/8-12	4 1/16	21/8	15/8	0.255	5/16	0.191	5/8	1
1/2-10	5	2 9/16	2	0.367	7/16	0.275	1	1 1/2
5/8-8	6 1/4	3 3/16	2 1/2	0.480	9/16	0.360	1 1/4	1 7/8
3/4-6	7 15/16	4 5/16	3	0.542	5/8	0.406	1 1/2	2 1/4
7/8-6	8 5/8	4 3/8	3 1/2	0.697	3/4	0.523	1 3/4	2 5/8
1-5	10 1/8	5 1/4	4	0.697	3/4	0.523	2	3
1 1/8-5	10 3/4	5 1/4	4 1/2	0.800	13/16	0.600	2 1/4	3 3/8
1 1/4-5	11 1/8	5 1/4	4 3/4	0.896	7/8	0.672	2 1/2	3 3/4
1 3/8-4	12 1/4	5 7/8	5 1/8	1.108	1 1/4	0.831	2 3/4	4 1/8
1 1/2-4	12 5/8	5 7/8	5 1/2	1.233	1 1/4	0.925	3	4 1/2
1 3/4-4	13 3/8	5 7/8	6 1/4	1.430	1 1/4	1.072	3 1/2	5
2-4	14 7/8	6 1/2	7	1.644	1 3/8	1.233	4	6

DRILLS A

END MILLS B

ROUTERS C

THREAD MILLS & TAPS D

ENGRAVERS E

BORING BARS F

REAMERS G

SAWS H

TECHNICAL I

INDEX J

<b>A</b>	DRILLS
<b>B</b>	END MILLS
<b>C</b>	ROUTERS
<b>D</b>	THREAD MILLS & TAPS
<b>E</b>	ENGRAVERS
<b>F</b>	BORING BARS
<b>G</b>	REAMERS
<b>H</b>	SAWS
<b>I</b>	TECHNICAL
<b>J</b>	INDEX





# ENGRAVERS

E1 - E4

**MICRO ENGRAVING TOOLS** E2

SERIES EGR      2 Flute      30° - 90° Angles      E2

**MICRO HALF ROUND ENGRAVING TOOLS** E3

SERIES HR      1 Flute      0.005" - 0.0315" Line Widths      E3

**MICRO SPADE TOOLS** E4

SERIES SPD      2 Flute      30° - 118° Angles      E4

# 2 FLUTE

MICRO ENGRAVING TOOLS FOR GENERAL PURPOSE ENGRAVING

**30° - 90° ANGLES**  
 Complete Diameter Selection  
 Mirror Surface Finishes  
 Sub Micron Grain Carbide

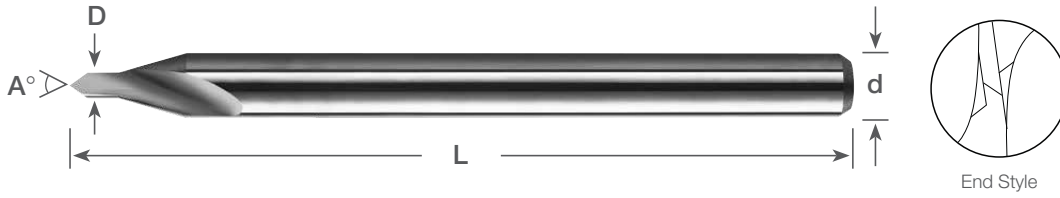

1/8" Shank

A°	Dimensions (in)			Uncoated	
	D	d	L	Part Number	Stock
30°	0.050	1/8	1 1/2	EGR1250-030	●
60°	0.050	1/8	1 1/2	EGR1250-060	●
90°	0.050	1/8	1 1/2	EGR1250-090	●

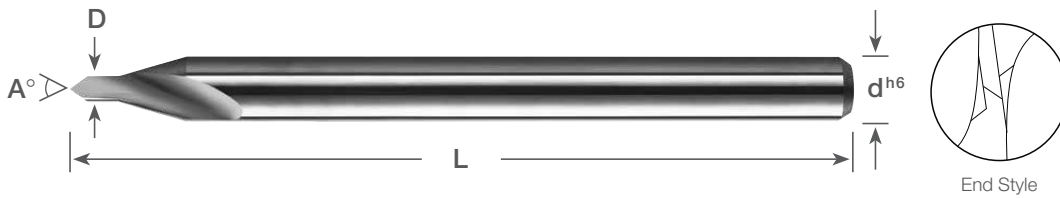

3.00mm Shank

A°	Dimensions (mm)			Uncoated	
	D	d <sup>h6</sup>	L	Part Number	Stock
30°	1.27	3	38	EGR1181-030	●
60°	1.27	3	38	EGR1181-060	●
90°	1.27	3	38	EGR1181-090	●

SERIES EGR WORKPIECE MATERIAL

Coating	P	P	H	H	M	K	N	N	N	N	N	N	S	S	
	Steel ~30HRC	Steel 30-40HRC	Hardened Steel ~55HRC	Hardened Steel ~68HRC	Stainless Steel	Cast Iron	Aluminum	Graphite	Copper Alloy	CFRP	Plastic	Thermoset Plastic	High Density Plastic	Nickel / Cobalt	Titanium Alloy
Uncoated	★	★	☆	☆	☆		☆	☆	☆	☆				☆	☆

★ : Priority ☆ : Applicable Materials

Symbol Descriptions Page vii

# HALF ROUND

MICRO ENGRAVING TOOLS FOR  
GENERAL PURPOSE ENGRAVING

0.0050" - 0.0315" LINE WIDTHS  
0.25mm - 0.80mm LINE WIDTHS  
Complete Diameter Selection  
Mirror Surface Finishes  
Sub Micron Grain Carbide

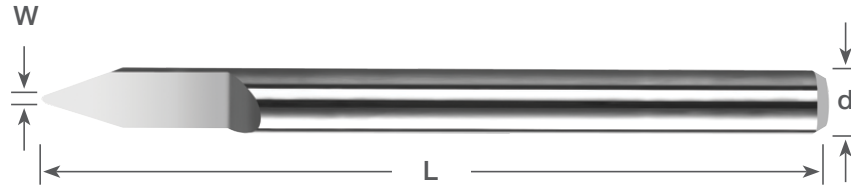

## 1/8" Shank



Letter Height	Dimensions (in)			Uncoated	
	W <sup>+0.0004"</sup> <sub>-0.0004"</sub>	d	L	Part Number	Stock
1/16	0.005	1/8	1 1/2	HR125SSS005A	●
3/32	0.010	1/8	1 1/2	HR125SSS010A	●
1/8	0.015	1/8	1 1/2	HR125SSS015A	●
3/16	0.020	1/8	1 1/2	HR125SSS020A	●
7/32	0.025	1/8	1 1/2	HR125SSS025A	●

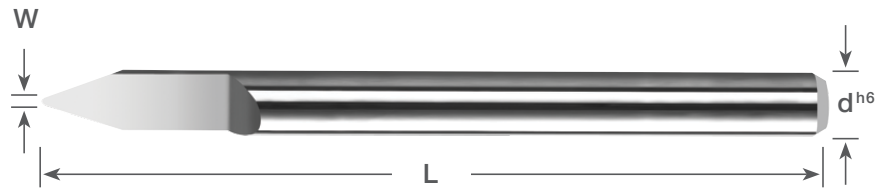

## 3.00mm Shank



Letter Height	Dimensions (mm)			Uncoated	
	W <sup>+0.010mm</sup> <sub>-0.010mm</sub>	d <sup>h6</sup>	L	Part Number	Stock
2.40	0.25	3	38	HR118SSS025A	●
2.75	0.30	3	38	HR118SSS030A	●
3.10	0.35	3	38	HR118SSS035A	●
3.45	0.40	3	38	HR118SSS040A	●
3.80	0.45	3	38	HR118SSS045A	●
4.75	0.50	3	38	HR118SSS050A	●
5.50	0.60	3	38	HR118SSS060A	●
6.25	0.70	3	38	HR118SSS070A	●
7.00	0.80	3	38	HR118SSS080A	●

SERIES HR WORKPIECE MATERIAL															
Coating	P	P	H	H	M	K	N	N	N	N	N	N	S	S	
	Steel ~30HRC	Steel 30~40HRC	Hardened Steel ~55HRC	Hardened Steel ~68HRC	Stainless Steel	Cast Iron	Aluminum	Graphite	Copper Alloy	CFRP	Plastic	Thermoset Plastic	High Density Plastic	Nickel / Cobalt	Titanium Alloy
Uncoated	★	★	☆	☆	☆		☆	☆	☆	☆				☆	☆

★ : Priority ☆ : Applicable Materials

Symbol Descriptions Page vii

● : U.S. Stock Standard  
■ : NOT STOCKED - Call for Delivery  
▲ : Coming Soon

(U.S.) 1.888.848.8449  
(International) 001.714.428.3636  
Pricing & Availability at [KyoceraPrecisionTools.com](http://KyoceraPrecisionTools.com)

# SPADE

MICRO ENGRAVING TOOLS FOR SPOTTING OR CHAMFERING

**30° - 118° ANGLES**  
Mirror Surface Finishes  
Sub Micron Grain Carbide



1/8" Shank

A° <sup>+1°</sup> / <sub>-1°</sub>	Dimensions (in)		Uncoated	
	d	L	Part Number	Stock
30°	1/8	1 1/2	SPD1250-030	●
45°	1/8	1 1/2	SPD1250-045	●
60°	1/8	1 1/2	SPD1250-060	●
90°	1/8	1 1/2	SPD1250-090	●
118°	1/8	1 1/2	SPD1250-118	●

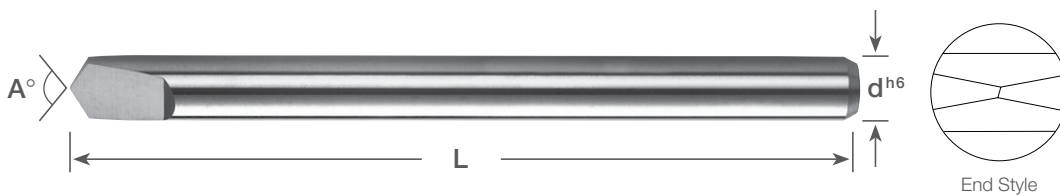

3.00mm Shank

A° <sup>+1°</sup> / <sub>-1°</sub>	Dimensions (mm)		Uncoated	
	d <sup>h6</sup>	L	Part Number	Stock
30°	3	38	SPD1181-030	●
45°	3	38	SPD1181-045	●
60°	3	38	SPD1181-060	●
90°	3	38	SPD1181-090	●
118°	3	38	SPD1181-118	●

SERIES SPD WORKPIECE MATERIAL

Coating	P Steel ~30HRC	P Steel 30-40HRC	H Hardened Steel ~55HRC	H Hardened Steel ~68HRC	M Stainless Steel	K Cast Iron	N Aluminum	N Graphite	N Copper Alloy	N CFRP	N Plastic	N Thermoset Plastic	N High Density Plastic	S Nickel / Cobalt	S Titanium Alloy
Uncoated	★	★	☆	☆	☆		☆	☆	☆	☆				☆	☆

★ : Priority ☆ : Applicable Materials

Symbol Descriptions Page vii



# BORING BARS

F1 - F5

MICRO BORING BARS			F2 - F5
SERIES MBS	0.0150" - 0.2400" Dia.	Standard Length	F2
SERIES MBS	0.40mm - 6.00mm Dia.	Standard Length	F3
SERIES MBE	0.0150" - 0.2400" Dia.	Extended Length	F4
SERIES MBE	0.40mm - 6.00mm Dia.	Extended Length	F5

\* Custom Boring Bars and Groove Tools available upon request.

# STANDARD LENGTH

0.0150" - 0.2400" DIAMETER

Mirror Surface Finishes  
Sub Micron Grain Carbide

INTERNAL DIAMETER PROFILE BORING



## STANDARD LENGTH (Inch Sizes)

D <sup>+0.0000</sup> <sub>-0.0025</sub>	Dimensions (in)			Uncoated		AlTiN Coating	
	d	L <sub>1</sub>	L	Part Number	Stock	Part Number	Stock
0.0150	1/8	0.030	1 1/2	MBS-0150.030	●	MBS-0150L030	●
0.0200	1/8	0.030	1 1/2	MBS-0200.030	●	MBS-0200L030	●
0.0250	1/8	0.050	1 1/2	MBS-0250.050	●	MBS-0250L050	●
0.0300	1/8	0.050	1 1/2	MBS-0300.050	●	MBS-0300L050	●
0.0350	1/8	0.050	1 1/2	MBS-0350.050	●	MBS-0350L050	●
0.0400	1/8	0.050	1 1/2	MBS-0400.050	●	MBS-0400L050	●
0.0450	1/8	0.100	1 1/2	MBS-0450.100	●	MBS-0450L100	●
0.0500	1/8	0.100	1 1/2	MBS-0500.100	●	MBS-0500L100	●
0.0550	1/8	0.100	1 1/2	MBS-0550.100	●	MBS-0550L100	●
0.0600	1/8	0.100	1 1/2	MBS-0600.100	●	MBS-0600L100	●
0.0800	1/8	0.250	1 1/2	MBS-0800.250	●	MBS-0800L250	●
0.1000	1/8	0.375	1 1/2	MBS-1000.375	●	MBS-1000L375	●
0.1100	1/8	0.500	1 1/2	MBS-1100.500	●	MBS-1100L500	●
0.1200	3/16	0.600	2	MBS-1200.600	●	MBS-1200L600	●
0.1400	3/16	0.700	2	MBS-1400.700	●	MBS-1400L700	●
0.1600	3/16	0.800	2 1/2	MBS-1600.800	●	MBS-1600L800	●
0.1800	1/4	0.900	2 1/2	MBS-1800.900	●	MBS-1800L900	●
0.2000	1/4	1.000	3	MBS-2000.1000	●	MBS-2000L1000	●
0.2200	1/4	1.250	3	MBS-2200.1250	●	MBS-2200L1250	●
0.2400	1/4	1.500	3	MBS-2400.1500	●	MBS-2400L1500	●

Coating	SERIES MBS WORKPIECE MATERIAL														
	P Steel ~30HRC	P Steel 30-40HRC	H Hardened Steel ~55HRC	H Hardened Steel ~68HRC	M Stainless Steel	K Cast Iron	N Aluminum	N Graphite	N Copper Alloy	N CFRP	N Plastic	N Thermoset Plastic	N High Density Plastic	S Nickel / Cobalt	S Titanium Alloy
AlTiN	★	★	★	☆	☆	☆			☆					☆	☆
Uncoated	★	★	★	☆	☆		☆		☆				☆		

★ : Priority ☆ : Applicable Materials

Symbol Descriptions [Page vii](#)

# STANDARD LENGTH

INTERNAL DIAMETER PROFILE BORING

0.40mm - 6.00mm DIAMETER

Mirror Surface Finishes

Sub Micron Grain Carbide



## STANDARD LENGTH (Metric Sizes)

D <sup>+0.00</sup> <sub>-0.06mm</sub>	Dimensions (mm)			Uncoated		AlTiN Coating	
	d <sup>h6</sup>	L <sub>1</sub>	L	Part Number	Stock	Part Number	Stock
0.40	3	1	38	MBS-0157.039	●	MBS-0157L039	●
0.50	3	1	38	MBS-0197.039	●	MBS-0197L039	●
0.60	3	1.3	38	MBS-0236.051	●	MBS-0236L051	●
0.70	3	1.3	38	MBS-0276.051	●	MBS-0276L051	●
0.80	3	1.3	38	MBS-0315.051	●	MBS-0315L051	●
0.90	3	1.3	38	MBS-0354.051	●	MBS-0354L051	●
1.00	3	2.5	38	MBS-0394.098	●	MBS-0394L098	●
1.10	3	2.5	38	MBS-0433.098	●	MBS-0433L098	●
1.20	3	2.5	38	MBS-0472.098	●	MBS-0472L098	●
1.30	3	2.5	38	MBS-0512.098	●	MBS-0512L098	●
1.50	3	6	38	MBS-0591.236	●	MBS-0591L236	●
1.70	3	7	38	MBS-0669.276	●	MBS-0669L276	●
2.00	3	8	38	MBS-0787.315	●	MBS-0787L315	●
3.00	5	15	50	MBS-1181.591	●	MBS-1181L591	●
3.50	5	20	50	MBS-1378.787	●	MBS-1378L787	●
4.00	5	22	50	MBS-1575.866	●	MBS-1575L866	●
4.50	8	23	65	MBS-1772.906	●	MBS-1772L906	●
5.00	8	25	65	MBS-1969.984	●	MBS-1969L984	●
5.50	8	27	65	MBS-2165.1063	●	MBS-2165L1063	●
6.00	8	29	65	MBS-2362.1142	●	MBS-2362L1142	●

DRILLS A  
 END MILLS B  
 ROUTERS C  
 THREAD MILLS & TAPS D  
 ENGRAVERS E  
 BORING BARS F  
 REAMERS G  
 SAWS H  
 TECHNICAL I  
 INDEX J

SERIES MBS WORKPIECE MATERIAL															
Coating	P Steel ~30HRC	P Steel 30-40HRC	H Hardened Steel ~55HRC	H Hardened Steel ~68HRC	M Stainless Steel	K Cast Iron	N Aluminum	N Graphite	N Copper Alloy	N CFRP	N Plastic	N Thermoset Plastic	N High Density Plastic	S Nickel / Cobalt	S Titanium Alloy
AlTiN	★	★	★	☆	☆	☆			☆				☆	☆	☆
Uncoated	★	★	★	☆	☆		☆		☆				☆		

★ : Priority ☆ : Applicable Materials

Symbol Descriptions Page vii

● : U.S. Stock Standard  
 ■ : NOT STOCKED - Call for Delivery  
 ▲ : Coming Soon

(U.S.) 1.888.848.8449  
 (International) 001.714.428.3636  
 Pricing & Availability at [KyoceraPrecisionTools.com](http://KyoceraPrecisionTools.com)





# EXTENDED REACH

0.0150" - 0.2400" DIAMETER

INTERNAL DIAMETER PROFILE BORING

Mirror Surface Finishes  
Sub Micron Grain Carbide

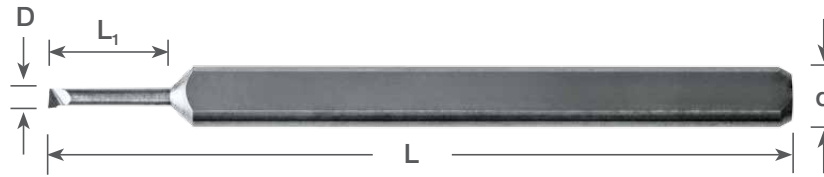

## EXTENDED REACH (Inch Sizes)

D <sup>+0.0000</sup> -0.0025	Dimensions (in)			Uncoated		AlTiN Coating	
	d	L <sub>1</sub>	L	Part Number	Stock	Part Number	Stock
0.0150	1/8	0.075	1 1/2	MBE-0150.075	●	MBE-0150L075	●
0.0200	1/8	0.075	1 1/2	MBE-0200.075	●	MBE-0200L075	●
0.0250	1/8	0.125	1 1/2	MBE-0250.125	●	MBE-0250L125	●
0.0300	1/8	0.125	1 1/2	MBE-0300.125	●	MBE-0300L125	●
0.0350	1/8	0.125	1 1/2	MBE-0350.125	●	MBE-0350L125	●
0.0400	1/8	0.125	1 1/2	MBE-0400.125	●	MBE-0400L125	●
0.0450	1/8	0.250	1 1/2	MBE-0450.250	●	MBE-0450L250	●
0.0500	1/8	0.250	1 1/2	MBE-0500.250	●	MBE-0500L250	●
0.0550	1/8	0.250	1 1/2	MBE-0550.250	●	MBE-0550L250	●
0.0600	1/8	0.250	1 1/2	MBE-0600.250	●	MBE-0600L250	●
0.0800	1/8	0.500	1 1/2	MBE-0800.500	●	MBE-0800L500	●
0.1000	1/8	0.600	1 1/2	MBE-1000.600	●	MBE-1000L600	●
0.1100	1/8	0.700	1 1/2	MBE-1100.700	●	MBE-1100L700	●
0.1200	3/16	0.850	2	MBE-1200.850	●	MBE-1200L850	●
0.1400	3/16	0.900	2	MBE-1400.900	●	MBE-1400L900	●
0.1600	3/16	1.100	2 1/2	MBE-1600.1100	●	MBE-1600L1100	●
0.1800	1/4	1.250	2 1/2	MBE-1800.1250	●	MBE-1800L1250	●
0.2000	1/4	1.400	3	MBE-2000.1400	●	MBE-2000L1400	●
0.2200	1/4	1.500	3	MBE-2200.1500	●	MBE-2200L1500	●
0.2400	1/4	1.750	3	MBE-2400.1750	●	MBE-2400L1750	●

Coating	SERIES MBE WORKPIECE MATERIAL														
	P Steel ~30HRC	P Steel 30-40HRC	H Hardened Steel ~55HRC	H Hardened Steel ~68HRC	M Stainless Steel	K Cast Iron	N Aluminum	N Graphite	N Copper Alloy	N CFRP	N Plastic	N Thermoset Plastic	N High Density Plastic	S Nickel / Cobalt	S Titanium Alloy
AlTiN	★	★	★	☆	☆	☆			☆					☆	☆
Uncoated	★	★	★	☆	☆		☆		☆				☆		

★ : Priority ☆ : Applicable Materials

Symbol Descriptions Page vii

# EXTENDED REACH

INTERNAL DIAMETER PROFILE BORING

0.40mm - 6.00mm DIAMETER

Mirror Surface Finishes  
Sub Micron Grain Carbide



## EXTENDED REACH (Metric Sizes)

D <sup>+0.0000</sup> -0.0025	Dimensions (mm)			Uncoated		AlTiN Coating	
	d <sup>h6</sup>	L <sub>1</sub>	L	Part Number	Stock	Part Number	Stock
0.40	3	2	38	MBE-0157.079	●	MBE-0157L079	●
0.50	3	2	38	MBE-0197.079	●	MBE-0197L079	●
0.60	3	3	38	MBE-0236.118	●	MBE-0236L118	●
0.70	3	3	38	MBE-0276.118	●	MBE-0276L118	●
0.80	3	3	38	MBE-0315.118	●	MBE-0315L118	●
0.90	3	3	38	MBE-0354.118	●	MBE-0354L118	●
1.00	3	5	38	MBE-0394.197	●	MBE-0394L197	●
1.10	3	5	38	MBE-0433.197	●	MBE-0433L197	●
1.20	3	5	38	MBE-0472.197	●	MBE-0472L197	●
1.30	3	5	38	MBE-0512.197	●	MBE-0512L197	●
1.50	3	10	38	MBE-0591.394	●	MBE-0591L394	●
1.70	3	10	38	MBE-0669.394	●	MBE-0669L394	●
2.00	3	10	38	MBE-0787.394	●	MBE-0787L394	●
3.00	5	20	50	MBE-1181.787	●	MBE-1181L787	●
3.50	5	25	50	MBE-1378.984	●	MBE-1378L984	●
4.00	5	27	50	MBE-1575.1063	●	MBE-1575L1063	●
4.50	8	32	65	MBE-1772.1260	●	MBE-1772L1260	●
5.00	8	32	65	MBE-1969.1260	●	MBE-1969L1260	●
5.50	8	32	65	MBE-2165.1260	●	MBE-2165L1260	●
6.00	8	35	65	MBE-2362.1378	●	MBE-2362L1378	●

SERIES MBE WORKPIECE MATERIAL															
Coating	P Steel ~30HRC	P Steel 30-40HRC	H Hardened Steel ~55HRC	H Hardened Steel ~68HRC	M Stainless Steel	K Cast Iron	N Aluminum	N Graphite	N Copper Alloy	N CFRP	N Plastic	N Thermoset Plastic	N High Density Plastic	S Nickel / Cobalt	S Titanium Alloy
AlTiN	★	★	★	☆	☆	☆			☆					☆	☆
Uncoated	★	★	★	☆	☆		☆		☆				☆		

★ : Priority ☆ : Applicable Materials

Symbol Descriptions Page vii

- : U.S. Stock Standard
- : NOT STOCKED - Call for Delivery
- ▲ : Coming Soon

(U.S.) 1.888.848.8449  
(International) 001.714.428.3636  
Pricing & Availability at [KyoceraPrecisionTools.com](http://KyoceraPrecisionTools.com)



DRILLS A  
 END MILLS B  
 ROUTERS C  
 THREAD MILLS & TAPS D  
 ENGRAVERS E  
 BORING BARS F  
 REAMERS G  
 SAWS H  
 TECHNICAL I  
 INDEX J

<b>A</b>	DRILLS
<b>B</b>	END MILLS
<b>C</b>	ROUTERS
<b>D</b>	THREAD MILLS & TAPS
<b>E</b>	ENGRAVERS
<b>F</b>	BORING BARS
<b>G</b>	REAMERS
<b>H</b>	SAWS
<b>I</b>	TECHNICAL
<b>J</b>	INDEX



# REAMERS

## G1 - G15

### 3.00MM SHANK MICRO REAMERS

G2 - G9

SERIES MR34	0.20mm - 0.49mm Dia.	4 Flute	G2
	0.50mm - 0.79mm Dia.	4 Flute	G3
	0.80mm - 1.09mm Dia.	4 Flute	G4
	1.10mm - 1.39mm Dia.	4 Flute	G5
	1.40mm - 1.69mm Dia.	4 Flute	G6
	1.70mm - 1.99mm Dia.	4 Flute	G7
	2.00mm - 2.19mm Dia.	4 Flute	G8
	2.20mm - 2.40mm Dia.	4 Flute	G9

### 4.00MM SHANK MICRO REAMERS

G10 - G12

SERIES MR46	2.41mm - 2.72mm Dia.	6 Flute	G10
	2.73mm - 3.10mm Dia.	6 Flute	G11
	3.20mm - 3.90mm Dia.	6 Flute	G12

### 6.00MM SHANK MICRO REAMERS

G13

SERIES MR66	3.97mm - 5.90mm Dia.	6 Flute	G13
-------------	----------------------	---------	-----

### 8.00MM SHANK MICRO REAMERS

G14

SERIES MR86	5.97mm - 7.90mm Dia.	6 Flute	G14
-------------	----------------------	---------	-----

### 10.00MM SHANK MICRO REAMERS

G15

SERIES MR106	7.97mm - 8.03mm Dia.	6 Flute	G15
--------------	----------------------	---------	-----

# 3.00mm SHANK

4 FLUTE MICRO REAMERS

0.20mm - 0.49mm DIAMETER

Mirror Surface Finishes

Sub Micron Grain Carbide

Left Hand Spiral, Right Hand Cutting

For Reaming Through Holes

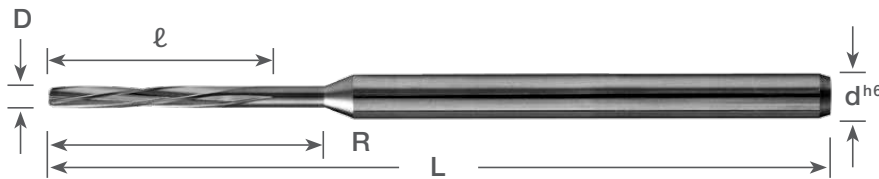

## STANDARD Length (Metric Sizes)

Dimensions (mm)					Uncoated	
D <sup>+0.003mm</sup> <sub>-0.000mm</sub>	d <sup>h6</sup>	ℓ	L	R	Part Number	Stock
0.20	3	1.50	50	3	MR34-0079.059	●
0.21	3	1.50	50	3	MR34-0083.059	●
0.22	3	1.50	50	3	MR34-0087.059	●
0.23	3	1.50	50	3	MR34-0091.059	●
0.24	3	1.50	50	3	MR34-0094.059	●
0.25	3	1.50	50	3	MR34-0098.059	●
0.26	3	1.50	50	3	MR34-0102.059	●
0.27	3	1.50	50	3	MR34-0106.059	●
0.28	3	1.50	50	3	MR34-0110.059	●
0.29	3	1.50	50	3	MR34-0114.059	●
0.30	3	2.00	50	4	MR34-0118.079	●
0.31	3	2.00	50	4	MR34-0122.079	●
0.32	3	2.00	50	4	MR34-0126.079	●
0.33	3	2.00	50	4	MR34-0130.079	●
0.34	3	2.00	50	4	MR34-0134.079	●
0.35	3	2.00	50	4	MR34-0138.079	●
0.36	3	2.00	50	4	MR34-0142.079	●
0.37	3	2.00	50	4	MR34-0146.079	●
0.38	3	2.00	50	4	MR34-0150.079	●
0.39	3	2.00	50	4	MR34-0154.079	●
0.40	3	2.50	50	5	MR34-0157.099	●
0.41	3	2.50	50	5	MR34-0161.099	●
0.42	3	2.50	50	5	MR34-0165.099	●
0.43	3	2.50	50	5	MR34-0169.099	●
0.44	3	2.50	50	5	MR34-0173.099	●
0.45	3	2.50	50	5	MR34-0177.099	●
0.46	3	2.50	50	5	MR34-0181.099	●
0.47	3	2.50	50	5	MR34-0185.099	●
0.48	3	2.50	50	5	MR34-0189.099	●
0.49	3	2.50	50	5	MR34-0193.099	●

### SERIES MR34 WORKPIECE MATERIAL

Coating	P Steel ~30HRC	P Steel 30-40HRC	H Hardened Steel ~55HRC	H Hardened Steel ~68HRC	M Stainless Steel	K Cast Iron	N Aluminum	N Graphite	N Copper Alloy	N CFRP	N Plastic	N Thermoset Plastic	N High Density Plastic	S Nickel / Cobalt	S Titanium Alloy
Uncoated	★	★	★	★	★	☆	☆	☆	☆	☆	☆	☆	☆	★	★

★ : Priority ☆ : Applicable Materials

Symbol Descriptions Page vii

# 3.00mm SHANK

4 FLUTE MICRO REAMERS

0.50mm - 0.79mm DIAMETER

Mirror Surface Finishes

Sub Micron Grain Carbide

Left Hand Spiral, Right Hand Cutting

For Reaming Through Holes

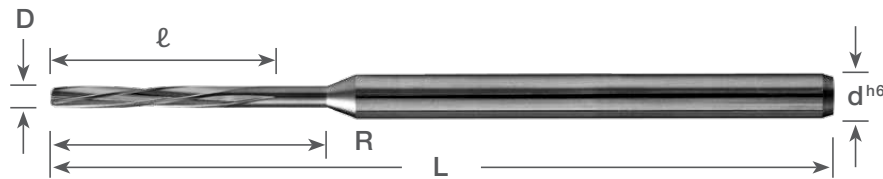

## STANDARD Length (Metric Sizes)

Dimensions (mm)					Uncoated	
D <sup>+0.003mm</sup> <sub>-0.000mm</sub>	d <sup>h6</sup>	ℓ	L	R	Part Number	Stock
0.50	3	3	50	6	MR34-0197.118	●
0.51	3	3	50	6	MR34-0201.118	●
0.52	3	3	50	6	MR34-0205.118	●
0.53	3	3	50	6	MR34-0209.118	●
0.54	3	3	50	6	MR34-0213.118	●
0.55	3	3	50	6	MR34-0216.118	●
0.56	3	3	50	6	MR34-0220.118	●
0.57	3	3	50	6	MR34-0224.118	●
0.58	3	3	50	6	MR34-0228.118	●
0.59	3	3	50	6	MR34-0232.118	●
0.60	3	7	50	18	MR34-0236.281	●
0.61	3	7	50	18	MR34-0240.281	●
0.62	3	7	50	18	MR34-0244.281	●
0.63	3	7	50	18	MR34-0248.281	●
0.64	3	7	50	18	MR34-0252.281	●
0.65	3	7	50	18	MR34-0256.281	●
0.66	3	7	50	18	MR34-0260.281	●
0.67	3	7	50	18	MR34-0264.281	●
0.68	3	7	50	18	MR34-0268.281	●
0.69	3	7	50	18	MR34-0272.281	●
0.70	3	7	50	18	MR34-0276.281	●
0.71	3	7	50	18	MR34-0279.281	●
0.72	3	7	50	18	MR34-0283.281	●
0.73	3	7	50	18	MR34-0287.281	●
0.74	3	7	50	18	MR34-0291.281	●
0.75	3	7	50	18	MR34-0295.281	●
0.76	3	7	50	18	MR34-0299.281	●
0.77	3	7	50	18	MR34-0303.281	●
0.78	3	7	50	18	MR34-0307.281	●
0.79	3	7	50	18	MR34-0311.281	●

SERIES MR34 WORKPIECE MATERIAL															
Coating	P	P	H	H	M	K	N	N	N	N	N	N	S	S	
	Steel ~30HRC	Steel 30-40HRC	Hardened Steel ~55HRC	Hardened Steel ~68HRC	Stainless Steel	Cast Iron	Aluminum	Graphite	Copper Alloy	CFRP	Plastic	Thermoset Plastic	High Density Plastic	Nickel / Cobalt	Titanium Alloy
Uncoated	★	★	★	★	★	☆	☆	☆	☆	☆	☆	☆	☆	★	★

★ : Priority ☆ : Applicable Materials

Symbol Descriptions Page vii

- : U.S. Stock Standard
- : NOT STOCKED - Call for Delivery
- ▲ : Coming Soon

(U.S.) 1.888.848.8449  
 (International) 001.714.428.3636  
 Pricing & Availability at [KyoceraPrecisionTools.com](http://KyoceraPrecisionTools.com)

DRILLS A  
 END MILLS B  
 ROUTERS C  
 THREAD MILLS & TAPS D  
 ENGRAVERS E  
 BORING BARS F  
 REAMERS G  
 SAWS H  
 TECHNICAL I  
 INDEX J

# 3.00mm SHANK

4 FLUTE MICRO REAMERS

0.80mm - 1.09mm DIAMETER

Mirror Surface Finishes

Sub Micron Grain Carbide

Left Hand Spiral, Right Hand Cutting

For Reaming Through Holes

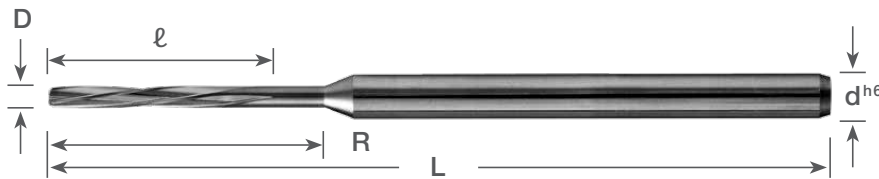

## STANDARD Length (Metric Sizes)

Dimensions (mm)					Uncoated	
D <sup>+0.003mm</sup> <sub>-0.000mm</sub>	d <sup>h6</sup>	l	L	R	Part Number	Stock
0.80	3	7	50	18	MR34-0315.281	●
0.81	3	7	50	18	MR34-0319.281	●
0.82	3	7	50	18	MR34-0323.281	●
0.83	3	7	50	18	MR34-0327.281	●
0.84	3	7	50	18	MR34-0331.281	●
0.85	3	7	50	18	MR34-0335.281	●
0.86	3	7	50	18	MR34-0338.281	●
0.87	3	7	50	18	MR34-0342.281	●
0.88	3	7	50	18	MR34-0346.281	●
0.89	3	7	50	18	MR34-0350.281	●
0.90	3	7	50	18	MR34-0354.281	●
0.91	3	7	50	18	MR34-0358.281	●
0.92	3	7	50	18	MR34-0362.281	●
0.93	3	7	50	18	MR34-0366.281	●
0.94	3	7	50	18	MR34-0370.281	●
0.95	3	7	50	18	MR34-0374.281	●
0.96	3	7	50	18	MR34-0378.281	●
0.97	3	7	50	18	MR34-0382.281	●
0.98	3	7	50	18	MR34-0386.281	●
0.99	3	7	50	18	MR34-0390.281	●
1.00	3	7	50	18	MR34-0394.281	●
1.01	3	7	50	18	MR34-0398.281	●
1.02	3	7	50	18	MR34-0401.281	●
1.03	3	7	50	18	MR34-0405.281	●
1.04	3	7	50	18	MR34-0409.281	●
1.05	3	7	50	18	MR34-0413.281	●
1.06	3	10	50	18	MR34-0417.406	●
1.07	3	10	50	18	MR34-0421.406	●
1.08	3	10	50	18	MR34-0425.406	●
1.09	3	10	50	18	MR34-0429.406	●

### SERIES MR34 WORKPIECE MATERIAL

Coating	P Steel ~30HRC	P Steel 30-40HRC	H Hardened Steel ~55HRC	H Hardened Steel ~68HRC	M Stainless Steel	K Cast Iron	N Aluminum	N Graphite	N Copper Alloy	N CFRP	N Plastic	N Thermoset Plastic	N High Density Plastic	S Nickel / Cobalt	S Titanium Alloy
Uncoated	★	★	★	★	★	☆	☆	☆	☆	☆	☆	☆	☆	★	★

★ : Priority ☆ : Applicable Materials

Symbol Descriptions Page vii

## 3.00mm SHANK

4 FLUTE MICRO REAMERS

**1.10mm - 1.39mm DIAMETER**

Mirror Surface Finishes

Sub Micron Grain Carbide

Left Hand Spiral, Right Hand Cutting

For Reaming Through Holes

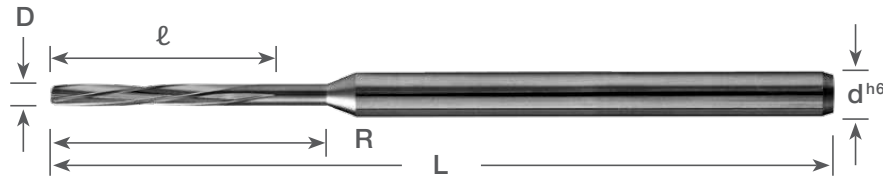

### STANDARD Length (Metric Sizes)

Dimensions (mm)					Uncoated	
D <sup>+0.003mm</sup> <sub>-0.000mm</sub>	d <sup>h6</sup>	l	L	R	Part Number	Stock
1.10	3	10	50	18	MR34-0433.406	●
1.11	3	10	50	18	MR34-0437.406	●
1.12	3	10	50	18	MR34-0441.406	●
1.13	3	10	50	18	MR34-0445.406	●
1.14	3	10	50	18	MR34-0449.406	●
1.15	3	10	50	18	MR34-0453.406	●
1.16	3	10	50	18	MR34-0457.406	●
1.17	3	10	50	18	MR34-0461.406	●
1.18	3	10	50	18	MR34-0464.406	●
1.19	3	10	50	18	MR34-0468.406	●
1.20	3	10	50	18	MR34-0472.406	●
1.21	3	10	50	18	MR34-0476.406	●
1.22	3	10	50	18	MR34-0480.406	●
1.23	3	10	50	18	MR34-0484.406	●
1.24	3	10	50	18	MR34-0488.406	●
1.25	3	10	50	18	MR34-0492.406	●
1.26	3	10	50	18	MR34-0496.406	●
1.27	3	10	50	18	MR34-0500.406	●
1.28	3	10	50	18	MR34-0504.406	●
1.29	3	10	50	18	MR34-0508.406	●
1.30	3	10	50	18	MR34-0512.406	●
1.31	3	10	50	18	MR34-0516.406	●
1.32	3	10	50	18	MR34-0520.406	●
1.33	3	10	50	18	MR34-0523.406	●
1.34	3	10	50	18	MR34-0527.406	●
1.35	3	10	50	18	MR34-0531.406	●
1.36	3	10	50	18	MR34-0535.406	●
1.37	3	10	50	18	MR34-0539.406	●
1.38	3	10	50	18	MR34-0543.406	●
1.39	3	10	50	18	MR34-0547.406	●

SERIES MR34 WORKPIECE MATERIAL															
Coating	P	P	H	H	M	K	N	N	N	N	N	N	S	S	
	Steel ~30HRC	Steel 30-40HRC	Hardened Steel ~55HRC	Hardened Steel ~68HRC	Stainless Steel	Cast Iron	Aluminum	Graphite	Copper Alloy	CFRP	Plastic	Thermoset Plastic	High Density Plastic	Nickel / Cobalt	Titanium Alloy
Uncoated	★	★	★	★	★	☆	☆	☆	☆	☆	☆	☆	☆	★	★

★ : Priority ☆ : Applicable Materials

Symbol Descriptions Page vii

● : U.S. Stock Standard  
 ■ : NOT STOCKED - Call for Delivery  
 ▲ : Coming Soon

(U.S.) 1.888.848.8449  
 (International) 001.714.428.3636  
 Pricing & Availability at [KyoceraPrecisionTools.com](http://KyoceraPrecisionTools.com)

DRILLS A  
 END MILLS B  
 ROUTERS C  
 THREAD MILLS & TAPS D  
 ENGRAVERS E  
 BORING BARS F  
**REAMERS G**  
 SAWS H  
 TECHNICAL I  
 INDEX J



## 3.00mm SHANK

4 FLUTE MICRO REAMERS

**1.40mm - 1.69mm DIAMETER**

Mirror Surface Finishes

Sub Micron Grain Carbide

Left Hand Spiral, Right Hand Cutting

For Reaming Through Holes

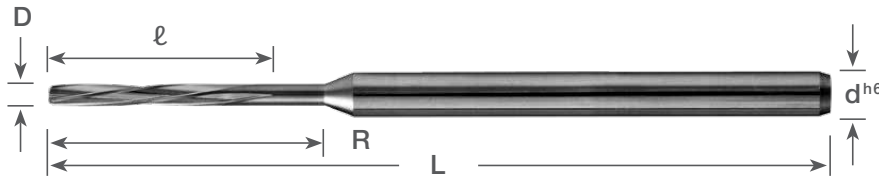

### STANDARD Length (Metric Sizes)

Dimensions (mm)					Uncoated	
D <sup>+0.003mm</sup> <sub>-0.000mm</sub>	d <sup>h6</sup>	l	L	R	Part Number	Stock
1.40	3	10	50	18	MR34-0551.406	●
1.41	3	10	50	18	MR34-0555.406	●
1.42	3	10	50	18	MR34-0559.406	●
1.43	3	10	50	18	MR34-0563.406	●
1.44	3	10	50	18	MR34-0567.406	●
1.45	3	10	50	18	MR34-0571.406	●
1.46	3	10	50	18	MR34-0575.406	●
1.47	3	10	50	18	MR34-0579.406	●
1.48	3	10	50	18	MR34-0583.406	●
1.49	3	10	50	18	MR34-0586.406	●
1.50	3	10	50	18	MR34-0590.406	●
1.51	3	10	50	18	MR34-0594.406	●
1.52	3	10	50	18	MR34-0598.406	●
1.53	3	10	50	18	MR34-0602.406	●
1.54	3	10	50	18	MR34-0606.406	●
1.55	3	10	50	18	MR34-0610.406	●
1.56	3	10	50	18	MR34-0614.406	●
1.57	3	10	50	18	MR34-0618.406	●
1.58	3	10	50	18	MR34-0622.406	●
1.59	3	10	50	18	MR34-0626.406	●
1.60	3	10	50	18	MR34-0630.406	●
1.61	3	10	50	18	MR34-0634.406	●
1.62	3	10	50	18	MR34-0638.406	●
1.63	3	10	50	18	MR34-0642.406	●
1.64	3	10	50	18	MR34-0646.406	●
1.65	3	10	50	18	MR34-0649.406	●
1.66	3	10	50	18	MR34-0653.406	●
1.67	3	10	50	18	MR34-0657.406	●
1.68	3	10	50	18	MR34-0661.406	●
1.69	3	10	50	18	MR34-0665.406	●

### SERIES MR34 WORKPIECE MATERIAL

Coating	P Steel ~30HRC	P Steel 30-40HRC	H Hardened Steel ~55HRC	H Hardened Steel ~68HRC	M Stainless Steel	K Cast Iron	N Aluminum	N Graphite	N Copper Alloy	N CFRP	N Plastic	N Thermoset Plastic	N High Density Plastic	S Nickel / Cobalt	S Titanium Alloy
Uncoated	★	★	★	★	★	☆	☆	☆	☆	☆	☆	☆	☆	★	★

★ : Priority ☆ : Applicable Materials

Symbol Descriptions [Page vii](#)

## 3.00mm SHANK

4 FLUTE MICRO REAMERS

**1.70mm - 1.99mm DIAMETER**

Mirror Surface Finishes

Sub Micron Grain Carbide

Left Hand Spiral, Right Hand Cutting

For Reaming Through Holes

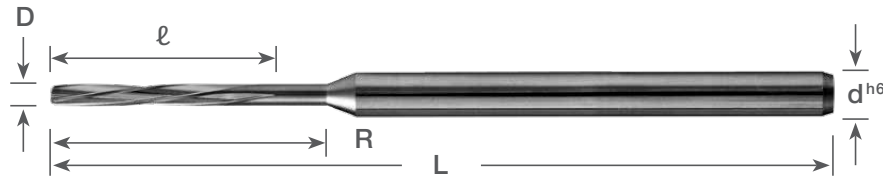

### STANDARD Length (Metric Sizes)

Dimensions (mm)					Uncoated	
D <sup>+0.003mm</sup> <sub>-0.000mm</sub>	d <sup>h6</sup>	ℓ	L	R	Part Number	Stock
1.70	3	10	50	18.00	MR34-0669.406	●
1.71	3	10	50	18.00	MR34-0673.406	●
1.72	3	10	50	18.00	MR34-0677.406	●
1.73	3	10	50	18.00	MR34-0681.406	●
1.74	3	10	50	18.00	MR34-0685.406	●
1.75	3	10	50	18.00	MR34-0689.406	●
1.76	3	10	50	18.00	MR34-0693.406	●
1.77	3	10	50	18.00	MR34-0697.406	●
1.78	3	10	50	18.00	MR34-0701.406	●
1.79	3	10	50	18.00	MR34-0705.406	●
1.80	3	10	50	18.00	MR34-0708.406	●
1.81	3	10	50	18.00	MR34-0712.406	●
1.82	3	10	50	18.00	MR34-0716.406	●
1.83	3	10	50	18.00	MR34-0720.406	●
1.84	3	10	50	18.00	MR34-0724.406	●
1.85	3	10	50	18.00	MR34-0728.406	●
1.86	3	10	50	18.00	MR34-0732.406	●
1.87	3	10	50	18.00	MR34-0736.406	●
1.88	3	10	50	18.00	MR34-0740.406	●
1.89	3	10	50	18.00	MR34-0744.406	●
1.90	3	10	50	18.00	MR34-0748.406	●
1.91	3	10	50	18.00	MR34-0752.406	●
1.92	3	10	50	18.00	MR34-0756.406	●
1.93	3	10	50	18.00	MR34-0760.406	●
1.94	3	10	50	18.00	MR34-0764.406	●
1.95	3	10	50	18.00	MR34-0768.406	●
1.96	3	11	50	20.50	MR34-0771.438	●
1.97	3	11	50	20.50	MR34-0775.438	●
1.98	3	11	50	20.50	MR34-0779.438	●
1.99	3	11	50	20.50	MR34-0783.438	●

SERIES MR34 WORKPIECE MATERIAL															
Coating	P	P	H	H	M	K	N	N	N	N	N	N	S	S	
	Steel ~30HRC	Steel 30~40HRC	Hardened Steel ~55HRC	Hardened Steel ~68HRC	Stainless Steel	Cast Iron	Aluminum	Graphite	Copper Alloy	CFRP	Plastic	Thermoset Plastic	High Density Plastic	Nickel / Cobalt	Titanium Alloy
Uncoated	★	★	★	★	★	☆	☆	☆	☆	☆	☆	☆	☆	★	★

★ : Priority ☆ : Applicable Materials

Symbol Descriptions Page vii

- : U.S. Stock Standard
- : NOT STOCKED - Call for Delivery
- ▲ : Coming Soon

(U.S.) 1.888.848.8449  
 (International) 001.714.428.3636  
 Pricing & Availability at [KyoceraPrecisionTools.com](http://KyoceraPrecisionTools.com)

DRILLS A  
 END MILLS B  
 ROUTERS C  
 THREAD MILLS & TAPS D  
 ENGRAVERS E  
 BORING BARS F  
**REAMERS G**  
 SAWS H  
 TECHNICAL I  
 INDEX J

# 3.00mm SHANK

4 FLUTE MICRO REAMERS

2.00mm - 2.19mm DIAMETER

Mirror Surface Finishes

Sub Micron Grain Carbide

Left Hand Spiral, Right Hand Cutting

For Reaming Through Holes

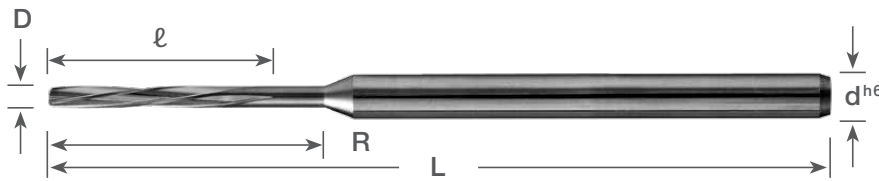

## STANDARD Length (Metric Sizes)

Dimensions (mm)					Uncoated	
D <sup>+0.003mm</sup> <sub>-0.000mm</sub>	d <sup>h6</sup>	l	L	R	Part Number	Stock
2.00	3	11	50	20.50	MR34-0787.438	●
2.01	3	11	50	20.50	MR34-0791.438	●
2.02	3	11	50	20.50	MR34-0795.438	●
2.03	3	11	50	20.50	MR34-0799.438	●
2.04	3	11	50	20.50	MR34-0803.438	●
2.05	3	11	50	20.50	MR34-0807.438	●
2.06	3	11	50	20.50	MR34-0811.438	●
2.07	3	11	50	20.50	MR34-0815.438	●
2.08	3	11	50	20.50	MR34-0819.438	●
2.09	3	11	50	20.50	MR34-0823.438	●
2.10	3	11	50	20.50	MR34-0827.438	●
2.11	3	11	50	20.50	MR34-0830.438	●
2.12	3	11	50	20.50	MR34-0835.438	●
2.13	3	11	50	20.50	MR34-0838.438	●
2.14	3	11	50	20.50	MR34-0843.438	●
2.15	3	11	50	20.50	MR34-0846.438	●
2.16	3	11	50	20.50	MR34-0850.438	●
2.17	3	11	50	20.50	MR34-0854.438	●
2.18	3	11	50	20.50	MR34-0858.438	●
2.19	3	11	50	20.50	MR34-0862.438	●

### SERIES MR34 WORKPIECE MATERIAL

Coating	P Steel ~30HRC	P Steel 30-40HRC	H Hardened Steel ~55HRC	H Hardened Steel ~68HRC	M Stainless Steel	K Cast Iron	N Aluminum	N Graphite	N Copper Alloy	N CFRP	N Plastic	N Thermoset Plastic	N High Density Plastic	S Nickel / Cobalt	S Titanium Alloy
Uncoated	★	★	★	★	★	☆	☆	☆	☆	☆	☆	☆	☆	★	★

★ : Priority ☆ : Applicable Materials

Symbol Descriptions Page vii

## 3.00mm SHANK

4 FLUTE MICRO REAMERS

**2.20mm - 2.40mm DIAMETER**

Mirror Surface Finishes

Sub Micron Grain Carbide

Left Hand Spiral, Right Hand Cutting

For Reaming Through Holes

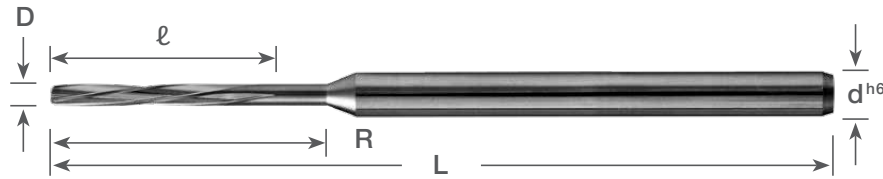

### STANDARD Length (Metric Sizes)

Dimensions (mm)					Uncoated	
D <sup>+0.003mm</sup> <sub>-0.000mm</sub>	d <sup>h6</sup>	ℓ	L	R	Part Number	Stock
2.20	3	11	50	20.50	MR34-0866.438	●
2.21	3	11	50	20.50	MR34-0870.438	●
2.22	3	11	50	20.50	MR34-0874.438	●
2.23	3	11	50	20.50	MR34-0878.438	●
2.24	3	11	50	20.50	MR34-0882.438	●
2.25	3	11	50	20.50	MR34-0886.438	●
2.26	3	11	50	20.50	MR34-0890.438	●
2.27	3	11	50	20.50	MR34-0894.438	●
2.28	3	11	50	20.50	MR34-0896.438	●
2.29	3	11	50	20.50	MR34-0901.438	●
2.30	3	11	50	20.50	MR34-0906.438	●
2.31	3	11	50	20.50	MR34-0909.438	●
2.32	3	11	50	20.50	MR34-0913.438	●
2.33	3	11	50	20.50	MR34-0917.438	●
2.34	3	11	50	20.50	MR34-0921.438	●
2.35	3	11	50	20.50	MR34-0925.438	●
2.36	3	11	50	20.50	MR34-0929.438	●
2.37	3	11	50	20.50	MR34-0933.438	●
2.38	3	11	50	20.50	MR34-0937.438	●
2.39	3	11	50	20.50	MR34-0941.438	●
2.40	3	11	50	20.50	MR34-0945.438	●

SERIES MR34 WORKPIECE MATERIAL															
Coating	P	P	H	H	M	K	N	N	N	N	N	N	S	S	
	Steel ~30HRC	Steel 30~40HRC	Hardened Steel ~55HRC	Hardened Steel ~68HRC	Stainless Steel	Cast Iron	Aluminum	Graphite	Copper Alloy	CFRP	Plastic	Thermoset Plastic	High Density Plastic	Nickel / Cobalt	Titanium Alloy
Uncoated	★	★	★	★	★	☆	☆	☆	☆	☆	☆	☆	☆	★	★

★ : Priority ☆ : Applicable Materials

Symbol Descriptions [Page vii](#)

● : U.S. Stock Standard  
 ■ : NOT STOCKED - Call for Delivery  
 ▲ : Coming Soon

(U.S.) 1.888.848.8449  
 (International) 001.714.428.3636  
 Pricing & Availability at [KyoceraPrecisionTools.com](http://KyoceraPrecisionTools.com)

DRILLS **A**  
 END MILLS **B**  
 ROUTERS **C**  
 THREAD MILLS & TAPS **D**  
 ENGRAVERS **E**  
 BORING BARS **F**  
**REAMERS G**  
 SAWS **H**  
 TECHNICAL **I**  
 INDEX **J**

# 4.00mm SHANK

6 FLUTE MICRO REAMERS

2.41mm - 2.72mm DIAMETER

Mirror Surface Finishes

Sub Micron Grain Carbide

Left Hand Spiral, Right Hand Cutting

For Reaming Through Holes

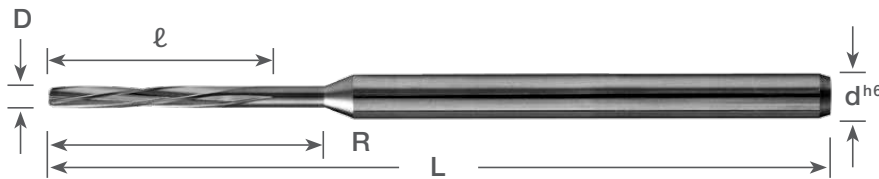

## STANDARD Length (Metric Sizes)

Dimensions (mm)						Uncoated	
D <sup>+0.003mm</sup> <sub>-0.000mm</sub>	d <sup>h6</sup>	ℓ	L	R	Part Number	Stock	
2.41	4	14	75	51	MR46-0949.563	●	
2.42	4	14	75	51	MR46-0953.563	●	
2.43	4	14	75	51	MR46-0957.563	●	
2.44	4	14	75	51	MR46-0960.563	●	
2.45	4	14	75	51	MR46-0965.563	●	
2.46	4	14	75	51	MR46-0968.563	●	
2.47	4	14	75	51	MR46-0972.563	●	
2.48	4	14	75	51	MR46-0976.563	●	
2.49	4	14	75	51	MR46-0980.563	●	
2.50	4	14	75	51	MR46-0984.563	●	
2.51	4	14	75	51	MR46-0988.563	●	
2.52	4	14	75	51	MR46-0992.563	●	
2.53	4	14	75	51	MR46-0996.563	●	
2.54	4	14	75	51	MR46-1000.563	●	
2.55	4	14	75	51	MR46-1004.563	●	
2.56	4	14	75	51	MR46-1008.563	●	
2.57	4	14	75	51	MR46-1012.563	●	
2.58	4	14	75	51	MR46-1015.563	●	
2.59	4	14	75	51	MR46-1019.563	●	
2.60	4	14	75	51	MR46-1024.563	●	
2.61	4	14	75	51	MR46-1028.563	●	
2.62	4	14	75	51	MR46-1031.563	●	
2.63	4	14	75	51	MR46-1035.563	●	
2.64	4	14	75	51	MR46-1039.563	●	
2.65	4	14	75	51	MR46-1043.563	●	
2.66	4	14	75	51	MR46-1047.563	●	
2.67	4	14	75	51	MR46-1051.563	●	
2.68	4	14	75	51	MR46-1055.563	●	
2.69	4	14	75	51	MR46-1059.563	●	
2.70	4	14	75	51	MR46-1063.563	●	
2.71	4	14	75	51	MR46-1067.563	●	
2.72	4	14	75	51	MR46-1071.563	●	

### SERIES MR46 WORKPIECE MATERIAL

Coating	P Steel ~30HRC	P Steel 30-40HRC	H Hardened Steel ~55HRC	H Hardened Steel ~68HRC	M Stainless Steel	K Cast Iron	N Aluminum	N Graphite	N Copper Alloy	N CFRP	N Plastic	N Thermoset Plastic	N High Density Plastic	S Nickel / Cobalt	S Titanium Alloy
Uncoated	★	★	★	★	★	☆	☆	☆	☆	☆	☆	☆	☆	★	★

★ : Priority ☆ : Applicable Materials

Symbol Descriptions Page vii

## 4.00mm SHANK

6 FLUTE MICRO REAMERS

**2.73mm - 3.10mm DIAMETER**

Mirror Surface Finishes

Sub Micron Grain Carbide

Left Hand Spiral, Right Hand Cutting

For Reaming Through Holes

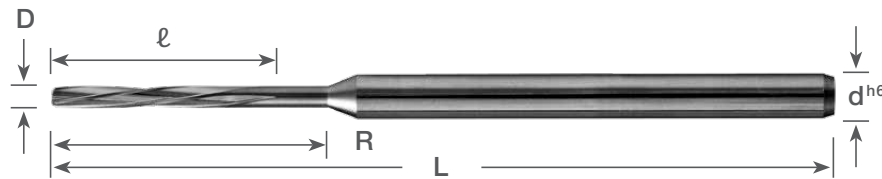

### STANDARD Length (Metric Sizes)

Dimensions (mm)					Uncoated	
D <sup>+0.003mm</sup> <sub>-0.000mm</sub>	d <sup>h6</sup>	ℓ	L	R	Part Number	Stock
2.73	4	14	75	51	MR46-1075.563	●
2.74	4	14	75	51	MR46-1078.563	●
2.75	4	14	75	51	MR46-1083.563	●
2.76	4	14	75	51	MR46-1087.563	●
2.77	4	14	75	51	MR46-1090.563	●
2.78	4	14	75	51	MR46-1094.563	●
2.79	4	14	75	51	MR46-1098.563	●
2.80	4	14	75	51	MR46-1102.563	●
2.81	4	14	75	51	MR46-1106.563	●
2.82	4	14	75	51	MR46-1110.563	●
2.83	4	14	75	51	MR46-1114.563	●
2.84	4	14	75	51	MR46-1118.563	●
2.85	4	14	75	51	MR46-1122.563	●
2.87	4	14	75	51	MR46-1130.563	●
2.88	4	14	75	51	MR46-1134.563	●
2.89	4	14	75	51	MR46-1138.563	●
2.90	4	14	75	51	MR46-1141.563	●
2.91	4	14	75	51	MR46-1146.563	●
2.92	4	14	75	51	MR46-1149.563	●
2.93	4	14	75	51	MR46-1154.563	●
2.94	4	14	75	51	MR46-1157.563	●
2.95	4	16	75	51	MR46-1161.625	●
2.96	4	16	75	51	MR46-1164.625	●
2.97	4	16	75	51	MR46-1169.625	●
2.98	4	16	75	51	MR46-1173.625	●
2.99	4	16	75	51	MR46-1177.625	●
3.00	4	16	75	51	MR46-1181.625	●
3.01	4	16	75	51	MR46-1185.625	●
3.02	4	16	75	51	MR46-1189.625	●
3.03	4	16	75	51	MR46-1193.625	●
3.05	4	16	75	51	MR46-1200.625	●
3.10	4	16	75	51	MR46-1220.625	●

SERIES MR46 WORKPIECE MATERIAL															
Coating	P	P	H	H	M	K	N	N	N	N	N	N	S	S	
	Steel ~30HRC	Steel 30-40HRC	Hardened Steel ~55HRC	Hardened Steel ~68HRC	Stainless Steel	Cast Iron	Aluminum	Graphite	Copper Alloy	CFRP	Plastic	Thermoset Plastic	High Density Plastic	Nickel / Cobalt	Titanium Alloy
Uncoated	★	★	★	★	★	☆	☆	☆	☆	☆	☆	☆	☆	★	★

★ : Priority ☆ : Applicable Materials

Symbol Descriptions Page vii

- : U.S. Stock Standard
- : NOT STOCKED - Call for Delivery
- ▲ : Coming Soon

(U.S.) 1.888.848.8449  
 (International) 001.714.428.3636  
 Pricing & Availability at [KyoceraPrecisionTools.com](http://KyoceraPrecisionTools.com)

DRILLS A  
 END MILLS B  
 ROUTERS C  
 THREAD MILLS & TAPS D  
 ENGRAVERS E  
 BORING BARS F  
**REAMERS G**  
 SAWS H  
 TECHNICAL I  
 INDEX J

# 4.00mm SHANK

6 FLUTE MICRO REAMERS

3.20mm - 3.90mm DIAMETER

Mirror Surface Finishes

Sub Micron Grain Carbide

Left Hand Spiral, Right Hand Cutting

For Reaming Through Holes

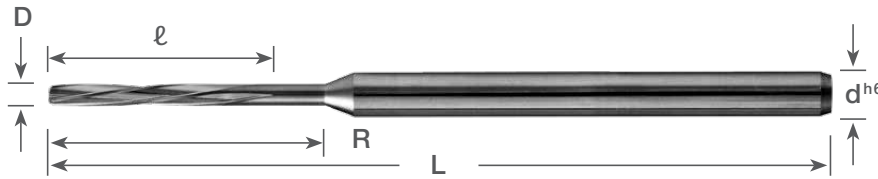

## STANDARD Length (Metric Sizes)

Dimensions (mm)					Uncoated		AlTiN Coating	
D	d <sup>h6</sup>	ℓ	L	R	Part Number	Stock	Part Number	Stock
3.20	4	17	64	36	MR46-1260.669	●	MR46-1260L669	●
3.30	4	17	64	36	MR46-1299.669	●	MR46-1299L669	●
3.40	4	17	64	36	MR46-1339.669	●	MR46-1339L669	●
3.50	4	17	64	36	MR46-1378.669	●	MR46-1378L669	●
3.60	4	17	64	36	MR46-1417.669	●	MR46-1417L669	●
3.70	4	17	64	36	MR46-1457.669	●	MR46-1457L669	●
3.80	4	17	64	36	MR46-1496.669	●	MR46-1496L669	●
3.90	4	17	64	36	MR46-1535.669	●	MR46-1535L669	●

- A DRILLS
- B END MILLS
- C ROUTERS
- D THREAD MILLS & TAPS
- E ENGRAVERS
- F BORING BARS
- G REAMERS
- H SAWS
- I TECHNICAL
- J INDEX

SERIES MR46 WORKPIECE MATERIAL															
Coating	P	P	H	H	M	K	N	N	N	N	N	N	S	S	
	Steel ~30HRC	Steel 30-40HRC	Hardened Steel ~55HRC	Hardened Steel ~68HRC	Stainless Steel	Cast Iron	Aluminum	Graphite	Copper Alloy	CFRP	Plastic	Thermoset Plastic	High Density Plastic	Nickel / Cobalt	Titanium Alloy
AlTiN	★	★	★	★	★	☆	☆	☆	☆	☆	☆	☆	☆	☆	☆
Uncoated	☆	☆	☆	☆	☆	☆	☆	☆	☆	☆	☆	☆	☆	☆	☆

★ : Priority ☆ : Applicable Materials

Symbol Descriptions Page vii

# 6.00mm SHANK

6 FLUTE MICRO REAMERS

3.97mm - 5.90mm DIAMETER

Mirror Surface Finishes

Sub Micron Grain Carbide

Left Hand Spiral, Right Hand Cutting

For Reaming Through Holes

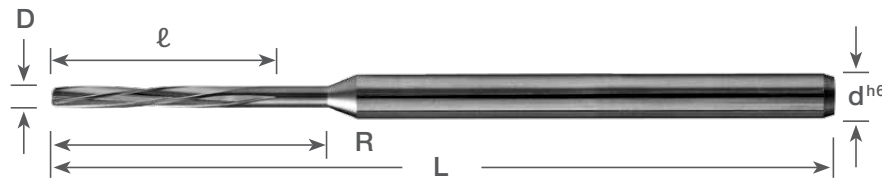

## STANDARD Length (Metric Sizes)

Dimensions (mm)					Uncoated		AlTiN Coating	
D <sup>+0.003mm</sup> <sub>-0.000mm</sub>	d <sup>h6</sup>	ℓ	L	R	Part Number	Stock	Part Number	Stock
3.97	6	21	77	45	MR66-1563.827	●	MR66-1563L827	●
3.98	6	21	77	45	MR66-1567.827	●	MR66-1567L827	●
3.99	6	21	77	45	MR66-1571.827	●	MR66-1571L827	●
4.00	6	21	77	45	MR66-1575.827	●	MR66-1575L827	●
4.01	6	21	77	45	MR66-1579.827	●	MR66-1579L827	●
4.02	6	21	77	45	MR66-1583.827	●	MR66-1583L827	●
4.03	6	21	77	45	MR66-1587.827	●	MR66-1587L827	●
4.10	6	21	77	45	MR66-1614.827	●	MR66-1614L827	●
4.20	6	21	77	45	MR66-1654.827	●	MR66-1654L827	●
4.30	6	21	77	45	MR66-1693.827	●	MR66-1693L827	●
4.40	6	21	77	45	MR66-1732.827	●	MR66-1732L827	●
4.50	6	21	77	45	MR66-1772.827	●	MR66-1772L827	●
4.60	6	21	77	45	MR66-1811.827	●	MR66-1811L827	●
4.70	6	21	77	45	MR66-1850.827	●	MR66-1850L827	●
4.80	6	21	77	45	MR66-1890.827	●	MR66-1890L827	●
4.90	6	21	77	45	MR66-1929.827	●	MR66-1929L827	●
4.97	6	26	93	59	MR66-1957.1024	●	MR66-1957L1024	●
4.98	6	26	93	59	MR66-1961.1024	●	MR66-1961L1024	●
4.99	6	26	93	59	MR66-1965.1024	●	MR66-1965L1024	●
5.00	6	26	93	59	MR66-1968.1024	●	MR66-1968L1024	●
5.01	6	26	93	59	MR66-1972.1024	●	MR66-1972L1024	●
5.02	6	26	93	59	MR66-1976.1024	●	MR66-1976L1024	●
5.03	6	26	93	59	MR66-1980.1024	●	MR66-1980L1024	●
5.10	6	26	93	59	MR66-2008.1024	●	MR66-2008L1024	●
5.20	6	26	93	59	MR66-2047.1024	●	MR66-2047L1024	●
5.30	6	26	93	59	MR66-2087.1024	●	MR66-2087L1024	●
5.40	6	26	93	59	MR66-2126.1024	●	MR66-2126L1024	●
5.50	6	26	93	59	MR66-2165.1024	●	MR66-2165L1024	●
5.60	6	26	93	59	MR66-2205.1024	●	MR66-2205L1024	●
5.70	6	26	93	59	MR66-2244.1024	●	MR66-2244L1024	●
5.80	6	26	93	59	MR66-2283.1024	●	MR66-2283L1024	●
5.90	6	26	93	59	MR66-2323.1024	●	MR66-2323L1024	●

SERIES MR66 WORKPIECE MATERIAL															
Coating	P Steel ~30HRC	P Steel 30-40HRC	H Hardened Steel ~55HRC	H Hardened Steel ~68HRC	M Stainless Steel	K Cast Iron	N Aluminum	N Graphite	N Copper Alloy	N CFRP	N Plastic	N Thermoset Plastic	N High Density Plastic	S Nickel / Cobalt	S Titanium Alloy
AlTiN	★	★	★	★	★	☆	☆	☆	☆	☆	☆	☆	☆	☆	☆
Uncoated	☆	☆	☆	☆	☆	☆	☆	☆	☆	☆	☆	☆	☆	☆	☆

★ : Priority ☆ : Applicable Materials

Symbol Descriptions Page vii

- : U.S. Stock Standard
- : NOT STOCKED - Call for Delivery
- ▲ : Coming Soon

(U.S.) 1.888.848.8449  
 (International) 001.714.428.3636  
 Pricing & Availability at [KyoceraPrecisionTools.com](http://KyoceraPrecisionTools.com)

DRILLS A  
 END MILLS B  
 ROUTERS C  
 THREAD MILLS & TAPS D  
 ENGRAVERS E  
 BORING BARS F  
**REAMERS G**  
 SAWS H  
 TECHNICAL I  
 INDEX J



# 8.00mm SHANK

6 FLUTE MICRO REAMERS

5.97mm - 7.90mm DIAMETER

Mirror Surface Finishes

Sub Micron Grain Carbide

Left Hand Spiral, Right Hand Cutting

For Reaming Through Holes

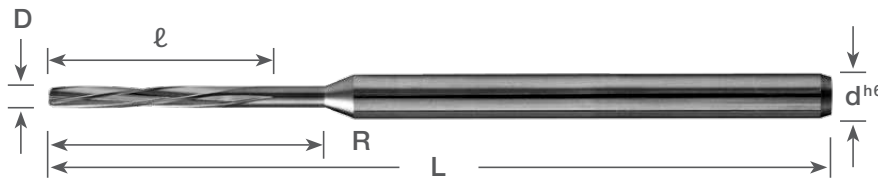

## STANDARD Length (Metric Sizes)

Dimensions (mm)					Uncoated		AlTiN Coating	
D	d <sup>h6</sup>	ℓ	L	R	Part Number	Stock	Part Number	Stock
5.97	8	26	93	59	MR86-2350.1024	●	MR86-2350L1024	●
5.98	8	26	93	59	MR86-2354.1024	●	MR86-2354L1024	●
5.99	8	26	93	59	MR86-2358.1024	●	MR86-2358L1024	●
6.00	8	26	93	59	MR86-2362.1024	●	MR86-2362L1024	●
6.01	8	26	93	59	MR86-2366.1024	●	MR86-2366L1024	●
6.02	8	26	93	59	MR86-2370.1024	●	MR86-2370L1024	●
6.03	8	26	93	59	MR86-2374.1024	●	MR86-2374L1024	●
6.10	8	26	93	59	MR86-2402.1024	●	MR86-2402L1024	●
6.20	8	26	93	59	MR86-2441.1024	●	MR86-2441L1024	●
6.30	8	26	93	59	MR86-2480.1024	●	MR86-2480L1024	●
6.40	8	26	93	59	MR86-2520.1024	●	MR86-2520L1024	●
6.50	8	26	93	59	MR86-2559.1024	●	MR86-2559L1024	●
6.60	8	26	93	59	MR86-2598.1024	●	MR86-2598L1024	●
6.70	8	26	93	59	MR86-2638.1024	●	MR86-2638L1024	●
6.80	8	26	93	59	MR86-2677.1024	●	MR86-2677L1024	●
6.90	8	26	93	59	MR86-2717.1024	●	MR86-2717L1024	●
6.97	8	31	109	69	MR86-2744.1220	●	MR86-2744L1220	●
6.98	8	31	109	69	MR86-2748.1220	●	MR86-2748L1220	●
6.99	8	31	109	69	MR86-2752.1220	●	MR86-2752L1220	●
7.00	8	31	109	69	MR86-2756.1220	●	MR86-2756L1220	●
7.01	8	31	109	69	MR86-2760.1220	●	MR86-2760L1220	●
7.02	8	31	109	69	MR86-2764.1220	●	MR86-2764L1220	●
7.03	8	31	109	69	MR86-2768.1220	●	MR86-2768L1220	●
7.10	8	31	109	69	MR86-2795.1220	●	MR86-2795L1220	●
7.20	8	31	109	69	MR86-2835.1220	●	MR86-2835L1220	●
7.30	8	31	109	69	MR86-2874.1220	●	MR86-2874L1220	●
7.40	8	31	109	69	MR86-2913.1220	●	MR86-2913L1220	●
7.50	8	31	109	69	MR86-2953.1220	●	MR86-2953L1220	●
7.60	8	31	109	69	MR86-2992.1220	●	MR86-2992L1220	●
7.70	8	31	109	69	MR86-3031.1220	●	MR86-3031L1220	●
7.80	8	31	109	69	MR86-3071.1220	●	MR86-3071L1220	●
7.90	8	31	109	69	MR86-3110.1220	●	MR86-3110L1220	●

### SERIES MR86 WORKPIECE MATERIAL

Coating	P	P	H	H	M	K	N	N	N	N	N	N	S	S	
	Steel ~30HRC	Steel 30-40HRC	Hardened Steel ~55HRC	Hardened Steel ~68HRC	Stainless Steel	Cast Iron	Aluminum	Graphite	Copper Alloy	CFRP	Plastic	Thermoset Plastic	High Density Plastic	Nickel / Cobalt	Titanium Alloy
AlTiN	★	★	★	★	★	☆	☆	☆	☆	☆	☆	☆	☆	☆	☆
Uncoated	☆	☆	☆	☆	☆	☆	☆	☆	☆	☆	☆	☆	☆	☆	☆

★ : Priority ☆ : Applicable Materials

Symbol Descriptions [Page vii](#)

# 10.00mm SHANK

6 FLUTE MICRO REAMERS

7.97mm - 8.03mm DIAMETER

Mirror Surface Finishes

Sub Micron Grain Carbide

Left Hand Spiral, Right Hand Cutting  
For Reaming Through Holes

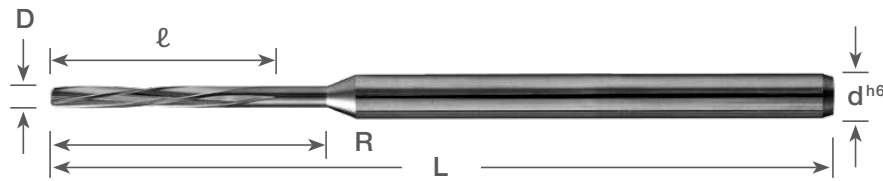

## STANDARD Length (Metric Sizes)

Dimensions (mm)					Uncoated		AlTiN Coating	
D	d <sup>h6</sup>	ℓ	L	R	Part Number	Stock	Part Number	Stock
7.97	10	33	133	75	MR106-3138.1299	●	MR106-3138L1299	●
7.98	10	33	133	75	MR106-3142.1299	●	MR106-3142L1299	●
7.99	10	33	133	75	MR106-3146.1299	●	MR106-3146L1299	●
8.00	10	33	133	75	MR106-3150.1299	●	MR106-3150L1299	●
8.01	10	33	133	75	MR106-3154.1299	●	MR106-3154L1299	●
8.02	10	33	133	75	MR106-3157.1299	●	MR106-3157L1299	●
8.03	10	33	133	75	MR106-3161.1299	●	MR106-3161L1299	●

DRILLS A  
END MILLS B  
ROUTERS C  
THREAD MILLS & TAPS D  
ENGRAVERS E  
BORING BARS F  
REAMERS G  
SAWS H  
TECHNICAL I  
INDEX J

SERIES MR106 WORKPIECE MATERIAL															
Coating	P	P	H	H	M	K	N	N	N	N	N	N	S	S	
	Steel ~30HRC	Steel 30~40HRC	Hardened Steel ~55HRC	Hardened Steel ~68HRC	Stainless Steel	Cast Iron	Aluminum	Graphite	Copper Alloy	CFRP	Plastic	Thermoset Plastic	High Density Plastic	Nickel / Cobalt	Titanium Alloy
AlTiN	★	★	★	★	★	☆	☆	☆	☆	☆	☆	☆	☆	☆	☆
Uncoated	☆	☆	☆	☆	☆	☆	☆	☆	☆	☆	☆	☆	☆	☆	☆

★ : Priority ☆ : Applicable Materials

Symbol Descriptions Page vii

● : U.S. Stock Standard  
■ : NOT STOCKED - Call for Delivery  
▲ : Coming Soon

(U.S.) 1.888.848.8449  
(International) 001.714.428.3636  
Pricing & Availability at [KyoceraPrecisionTools.com](http://KyoceraPrecisionTools.com)

<b>A</b>	DRILLS
<b>B</b>	END MILLS
<b>C</b>	ROUTERS
<b>D</b>	THREAD MILLS & TAPS
<b>E</b>	ENGRAVERS
<b>F</b>	BORING BARS
<b>G</b>	REAMERS
<b>H</b>	SAWS
<b>I</b>	TECHNICAL
<b>J</b>	INDEX



# SAWS

## H1 - H20

<b>24 HOUR SAW PROGRAM</b>	H2
<b>TEST APPLICATION DATA SHEET</b>	H3
<b>FEATURES &amp; BENEFITS</b>	H4 - H5
<b>SOLID CARBIDE SAWS</b>	H6 - H18
SAWS	<hr/>
3/4" - 4" Diameters	H6 - H11
20mm - 100mm Diameters	H12 - H18
<b>RECOMMENDED CUTTING CONDITIONS</b>	H19 - H20

---

## **24-HOUR SERVICE!**

*Inch & Metric Sizes!*

---



✓ **24-HOUR SHIPMENT** of premium quality SOLID CARBIDE “*THIN SAWS*”

- Diameter Range - INCH: 3/4” through 4” • METRIC: 20mm through 100mm
- Thickness Range - INCH: 0.008” through 0.250” • METRIC: .20mm through 6.35mm
- Arbor hole sizes - INCH: 1/4”, 5/16”, 3/8”, 1/2”, 5/8”, 7/8”, 1”  
METRIC: 5mm, 8mm, 10mm, 13mm, 16mm, 22mm
- Tolerances - INCH: +0.0005”/ -0.0000” on ID and thickness; O.D. tolerance = +0.005”/-0.000”  
METRIC: +0.013mm/ -0.0000mm on ID and thickness; O.D. tolerance = +0.13mm/-0.000mm

- ✓ Up to 6-pieces in 24-hours.
- ✓ Unsurpassed accuracy and tolerances provide consistent, dependable performance.
- ✓ Standard square tooth configurations available.
- ✓ Technical expertise to solve difficult or unusual sawing, slitting, slotting and cutting operations.
- ✓ For Special Applications, see “**Saws Test Application Data Sheet**” and Contact us at **1.888.848.8449** to request a quote.
- ✓ Our tool designers will be pleased to assist with your specific needs.

SAWS TEST APPLICATION DATA SHEET

Kyocera Sales Rep.: \_\_\_\_\_  
Customer Name: \_\_\_\_\_ Date: \_\_\_\_/\_\_\_\_/\_\_\_\_  
City/State: \_\_\_\_\_ Distributor: \_\_\_\_\_  
Phone: \_\_\_\_\_ Fax: \_\_\_\_\_ E-Mail: \_\_\_\_\_  
Contact: \_\_\_\_\_ Title: \_\_\_\_\_ Extn.: \_\_\_\_\_

**GENERAL INFORMATION**

(Application) B/P or Job # \_\_\_\_\_  
 SC  C-Tipped  H.S.S. Saw Dia. \_\_\_\_\_ Saw Width \_\_\_\_\_ Tolerance \_\_\_\_\_  
Arbor Hole Dia. \_\_\_\_\_ # Teeth \_\_\_\_\_ Special Tooth Form \_\_\_\_\_  
Keyway (Y/N) \_\_\_\_\_ Keyway Dimension \_\_\_\_\_ Hub (Y/N) \_\_\_\_\_  
Hub Dimension: Dia. \_\_\_\_\_ Thickness \_\_\_\_\_ Rake Angle \_\_\_\_\_  
Positive / Negative \_\_\_\_\_ Surface Treatment \_\_\_\_\_  
Unique Job Details \_\_\_\_\_

**JOB APPLICATION**

Operation \_\_\_\_\_ Slot Width \_\_\_\_\_ Tolerance \_\_\_\_\_  
Depth of Cut \_\_\_\_\_ Tolerance \_\_\_\_\_ Material \_\_\_\_\_  
Hardness \_\_\_\_\_ Machine Tool \_\_\_\_\_ Condition \_\_\_\_\_  
Speed \_\_\_\_\_ Feed \_\_\_\_\_ Coolant Type \_\_\_\_\_ Mix \_\_\_\_\_  
Are saws ganged? (Y/N) \_\_\_\_\_ If yes, tolerance required \_\_\_\_\_  
Form to be generated \_\_\_\_\_ (Sketch or B/P helpful)

**COMPETITION**

Brand Name \_\_\_\_\_ Price (\$) \_\_\_\_\_  
Delivery \_\_\_\_\_ Annual Usage \_\_\_\_\_  
Current performance info. or problem \_\_\_\_\_  
Criteria for successful test \_\_\_\_\_

**TEST EVALUATION**

PO# \_\_\_\_\_ Date \_\_\_\_\_ Dist. PO# \_\_\_\_\_  
Results \_\_\_\_\_  
Were you present for test? Y/N \_\_\_\_\_ Comments \_\_\_\_\_

## FEATURES AND BENEFITS

*Solid Carbide Saws*

### SOLID CARBIDE THIN SAWS & CUTTERS

*Designed and manufactured to your exact specifications.*

- Solid Carbide Saws as THIN as .0020"
- As THICK as 1.000"
- O.D.'s to 7.5"
- Tolerances to: +.0005"  
- .0000"
- Modified and Special Saws available, with tighter tolerances when required.



### EXTREME THINNESS

Our solid carbide saws can be manufactured as thin as .0020" (a human hair is about .0040" thick!). This extreme miniaturization is made possible through our numerous years of experience, a dedicated team of saw-makers unparalleled the world over, and our service-oriented approach to meeting your cutting tool requirements. We're prepared to work with you on your specific saw application.

### EXTREME PRECISION AND MINIATURIZATION

The miniature saw shown at left has an O.D. of .5000" with 24 precision teeth. We take pride in producing saws with precision and tolerances unexcelled by any other manufacturer. We will provide saws with any degree of precision and tolerance required by your job application.



A	DRILLS
B	END MILLS
C	ROUTERS
D	THREAD MILLS & TAPS
E	ENGRAVERS
F	BORING BARS
G	REAMERS
H	SAWS
I	TECHNICAL
J	INDEX

**FEATURES AND BENEFITS**

*Solid Carbide Saws*



Our cutters are manufactured with dish towards the arbor hole to avoid dragging in the cut, thereby reducing side friction. This feature is especially helpful in deep cuts, cutting copper, certain plastics and where parts tend to compress on the saw blade from cutting pressures.

Our solid carbide saws excel in overcoming the abrasive action encountered in individual and gang slotting of tough steels, cast irons and exotic non-ferrous and non-metallic materials such as fiberglass, epoxies and composites.

Use of solid carbide saws permits a far greater number of teeth in a given saw size than is possible with carbide tipped saws. A greater number of teeth allows reduced chip load, higher speeds and feeds, and improved quality of the finished cut.

Titanium Nitride (TiN) coating and other surface treatments can be added to all cutters for superior cutting performance and finish, providing up to 8 times increase in tool life in many materials.

Cutters with an O.D. of 2" or larger are stocked with standard hubs and keyways to give you the highest performance. Cutters may be ordered without hubs or keyways.

Timely shipment of your tooling is of paramount importance because we believe that customer satisfaction is our most important goal. We realize that we can gain the highest degree of customer confidence by manufacturing and shipping only the best saws and cutters available.

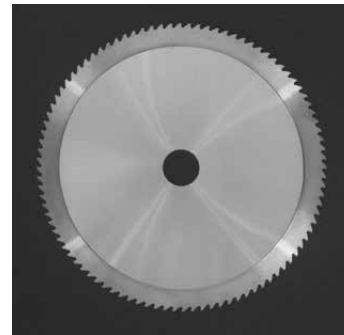

*Our precision solid carbide saws provide the ultimate combination of:*

- Maximum cutting speeds for minimum cost per unit of production and maximum output;
- Maximum tool life (up to 100 times the life of high speed steel), giving dramatic savings in machine downtime, regrinding and tool costs;
- Maximum precision and finish of cut (generally burr-free);
- Maximum precision of saw tolerances;   
 +.0005" / -.0000" on thickness, and   
 +.005" / -.000" outside diameter.   
 (Tighter tolerances are available as specials.)

DRILLS	<b>A</b>
END MILLS	<b>B</b>
ROUTERS	<b>C</b>
THREAD MILLS & TAPS	<b>D</b>
ENGRAVERS	<b>E</b>
BORING BARS	<b>F</b>
REAMERS	<b>G</b>
<b>SAWS</b>	<b>H</b>
TECHNICAL	<b>I</b>
INDEX	<b>J</b>



<b>A</b>	DRILLS
<b>B</b>	END MILLS
<b>C</b>	ROUTERS
<b>D</b>	THREAD MILLS & TAPS
<b>E</b>	ENGRAVERS
<b>F</b>	BORING BARS
<b>G</b>	REAMERS
<b>H</b>	SAWS
<b>I</b>	TECHNICAL
<b>J</b>	INDEX

Standard Tolerances	Saw Dia. (in)	Arbor Hole Dia. (in)	Saw Width			No. of Teeth	Part Number	Stock
			Fraction (in)	Decimal (in)	Metric (mm)			
Saw Dia. +0.005" -0.000"	3/4	1/4	1/32	0.0313	0.795	18	SC075002500031-18	◆
			3/64	0.0469	1.191	18	SC075002500047-18	◆
			1/16	0.0625	1.588	18	SC075002500063-18	◆
Arbor Hole Size +0.0005" -0.0000"	1	3/8	-	0.0080	0.203	20	SC100003750008-20	◆
			-	0.0100	0.254	20	SC100003750010-20	◆
			-	0.0120	0.305	20	SC100003750012-20	◆
			-	0.0140	0.356	20	SC100003750014-20	◆
			1/64	0.0156	0.396	20	SC100003750015-20	◆
			-	0.0180	0.457	20	SC100003750018-20	◆
Side Run-Out < 0.0005"	1	3/8	-	0.0200	0.508	20	SC100003750020-20	◆
			-	0.0230	0.584	20	SC100003750023-20	◆
			-	0.0250	0.635	20	SC100003750025-20	◆
Thickness +0.0005" -0.0000"	1	3/8	-	0.0280	0.711	20	SC100003750028-20	◆
			-	0.0300	0.762	20	SC100003750030-20	◆
			1/32	0.0313	0.795	20	SC100003750031-20	◆
Standard Tolerances	1	3/8	-	0.0350	0.889	20	SC100003750035-20	◆
			-	0.0394	1.000	20	SC100003750039-20	◆
			-	0.0400	1.016	20	SC100003750040-20	◆
			3/64	0.0469	1.191	20	SC100003750047-20	◆
			-	0.0500	1.270	20	SC100003750050-20	◆
			-	0.0510	1.295	20	SC100003750051-20	◆
			-	0.0600	1.524	20	SC100003750060-20	◆
			1/16	0.0625	1.588	20	SC100003750063-20	◆
			-	0.0700	1.778	20	SC100003750070-20	◆
			5/64	0.0781	1.984	20	SC100003750078-20	◆
			-	0.0787	2.000	20	SC100003750079-20	◆
			-	0.0800	2.032	20	SC100003750080-20	◆
Standard Tolerances	1	3/8	-	0.0900	2.286	20	SC100003750090-20	◆
			3/32	0.0938	2.383	20	SC100003750094-20	◆
			-	0.1000	2.540	20	SC100003750100-20	◆
			-	0.1100	2.794	20	SC100003750110-20	◆
			-	0.1181	3.000	20	SC100003750118-20	◆
			-	0.1200	3.048	20	SC100003750120-20	◆
			1/8	0.1250	3.175	20	SC100003750125-20	◆
			-	0.1300	3.302	20	SC100003750130-20	◆
			-	0.1400	3.556	20	SC100003750140-20	◆
			-	0.1500	3.810	20	SC100003750150-20	◆
			5/32	0.1563	3.970	20	SC100003750156-20	◆
			-	0.1575	4.001	20	SC100003750158-20	◆
Standard Tolerances	1	3/8	-	0.1600	4.064	20	SC100003750160-20	◆
			-	0.1700	4.318	20	SC100003750170-20	◆
			-	0.1800	4.572	20	SC100003750180-20	◆
			3/16	0.1875	4.763	20	SC100003750188-20	◆
			-	0.1900	4.826	20	SC100003750190-20	◆
			-	0.1969	5.000	20	SC100003750197-20	◆
			-	0.2000	5.080	20	SC100003750200-20	◆
			-	0.2100	5.334	20	SC100003750210-20	◆
			7/32	0.2188	5.558	20	SC100003750219-20	◆
			-	0.2200	5.588	20	SC100003750220-20	◆
			-	0.2300	5.842	20	SC100003750230-20	◆
			-	0.2362	6.000	20	SC100003750236-20	◆
Standard Tolerances	1	3/8	-	0.2400	6.096	20	SC100003750240-20	◆
			1/4	0.2500	6.350	20	SC100003750250-20	◆

Recommended cutting conditions [Page H19](#)

Saw Dia. (in)	Arbor Hole Dia. (in)	Saw Width			No. of Teeth	Part Number	Stock	Standard Tolerances
		Fraction (in)	Decimal (in)	Metric (mm)				
1-1/4	5/16	1/32	0.0313	0.795	24	SC125003130031-24	◆	<b>Saw Dia.</b> +0.005" -0.000"  <b>Arbor Hole Size</b> +0.0005" -0.0000"  <b>Side Run-Out</b> < 0.0005"  <b>Thickness</b> +0.0005" -0.0000"
		3/64	0.0469	1.191	24	SC125003130047-24	◆	
		1/16	0.0625	1.588	24	SC125003130063-24	◆	
		3/32	0.0938	2.383	24	SC125003130094-24	◆	
	1/2	1/8	0.1250	3.175	24	SC125003130125-24	◆	
		1/32	0.0313	0.795	24	SC125005000031-24	◆	
		3/64	0.0469	1.191	24	SC125005000047-24	◆	
		1/16	0.0625	1.588	24	SC125005000063-24	◆	
1-1/2	1/2	3/32	0.0938	2.383	24	SC125005000094-24	◆	
		1/8	0.1250	3.175	24	SC125005000125-24	◆	
		1/32	0.0313	0.795	32	SC150005000031-32	◆	
		3/64	0.0469	1.191	32	SC150005000047-32	◆	
		1/16	0.0625	1.588	32	SC150005000063-32	◆	
1-3/4	1/2	3/32	0.0938	2.383	32	SC150005000094-32	◆	
		1/8	0.1250	3.175	32	SC150005000125-32	◆	
		1/32	0.0313	0.795	36	SC175005000031-36	◆	
		3/64	0.0469	1.191	36	SC175005000047-36	◆	
	5/8	1/16	0.0625	1.588	36	SC175005000063-36	◆	
		1/32	0.0313	0.795	36	SC175006250031-36	◆	
		3/64	0.0469	1.191	36	SC175006250047-36	◆	
		1/16	0.0625	1.588	36	SC175006250063-36	◆	
	7/8	1/32	0.0313	0.795	36	SC175008750031-36	◆	
		3/64	0.0469	1.191	36	SC175008750047-36	◆	
		1/16	0.0625	1.588	36	SC175008750063-36	◆	
		3/32	0.0938	2.383	36	SC175008750094-36	◆	
2	1/2	1/8	0.1250	3.175	36	SC175008750125-36	◆	
		-	0.0080	0.203	36	SC200005000008-36	◆	
		-	0.0100	0.254	36	SC200005000010-36	◆	
		-	0.0120	0.305	36	SC200005000012-36	◆	
		-	0.0140	0.356	36	SC200005000014-36	◆	
		1/64	0.0156	0.396	36	SC200005000015-36	◆	
		-	0.0180	0.457	36	SC200005000018-36	◆	
		-	0.0200	0.508	36	SC200005000020-36	◆	
		-	0.0230	0.584	36	SC200005000023-36	◆	
		-	0.0250	0.635	36	SC200005000025-36	◆	
		-	0.0280	0.711	36	SC200005000028-36	◆	
		-	0.0300	0.762	36	SC200005000030-36	◆	
		1/32	0.0313	0.795	36	SC200005000031-36	◆	
		-	0.0350	0.889	36	SC200005000035-36	◆	
		-	0.0394	1.001	36	SC200005000039-36	◆	
		-	0.0400	1.016	36	SC200005000040-36	◆	
		3/64	0.0469	1.191	36	SC200005000047-36	◆	
		-	0.0500	1.270	36	SC200005000050-36	◆	
		-	0.0510	1.295	36	SC200005000051-36	◆	
		-	0.0600	1.524	36	SC200005000060-36	◆	
		1/16	0.0625	1.588	36	SC200005000063-36	◆	
		-	0.0700	1.778	36	SC200005000070-36	◆	
		5/64	0.0781	1.984	36	SC200005000078-36	◆	
		-	0.0787	1.999	36	SC200005000079-36	◆	
		-	0.0800	2.032	36	SC200005000080-36	◆	
		-	0.0900	2.286	36	SC200005000090-36	◆	
		3/32	0.0938	2.383	36	SC200005000094-36	◆	
		-	0.1000	2.540	36	SC200005000100-36	◆	

DRILLS	A
END MILLS	B
ROUTERS	C
THREAD MILLS & TAPS	D
ENGRAVERS	E
BORING BARS	F
REAMERS	G
SAWS	H
TECHNICAL	I
INDEX	J

Recommended cutting conditions  Page H19

◆ : Usually Ships in 24-48 Hours  
Depending on Size and Quantity

(U.S.) 1.888.848.8449  
(International) 001.714.428.3636  
Pricing & Availability at [KyoceraPrecisionTools.com](http://KyoceraPrecisionTools.com)



<b>A</b>	DRILLS
<b>B</b>	END MILLS
<b>C</b>	ROUTERS
<b>D</b>	THREAD MILLS & TAPS
<b>E</b>	ENGRAVERS
<b>F</b>	BORING BARS
<b>G</b>	REAMERS
<b>H</b>	SAWS
<b>I</b>	TECHNICAL
<b>J</b>	INDEX

Standard Tolerances		Saw Dia. (in)	Arbor Hole Dia. (in)	Fraction (in)	Saw Width Decimal (in)	Metric (mm)	No. of Teeth	Part Number	Stock		
Saw Dia. +0.005" -0.000"		2	1/2	-	0.1100	2.794	36	SC200005000110-36	◆		
				-	0.1181	3.000	36	SC200005000118-36	◆		
				-	0.1200	3.048	36	SC200005000120-36	◆		
				1/8	0.1250	3.175	36	SC200005000125-36	◆		
Arbor Hole Size +0.0005" -0.0000"		2	1/2	-	0.1300	3.302	36	SC200005000130-36	◆		
				-	0.1400	3.556	36	SC200005000140-36	◆		
				-	0.1500	3.810	36	SC200005000150-36	◆		
				5/32	0.1563	3.969	36	SC200005000156-36	◆		
Side Run-Out < 0.0005"		2	1/2	-	0.1575	4.000	36	SC200005000158-36	◆		
				-	0.1600	4.064	36	SC200005000160-36	◆		
				-	0.1700	4.318	36	SC200005000170-36	◆		
				-	0.1800	4.572	36	SC200005000180-36	◆		
Thickness +0.0005" -0.0000"		2	1/2	3/16	0.1875	4.763	36	SC200005000188-36	◆		
				-	0.1900	4.826	36	SC200005000190-36	◆		
				-	0.1969	5.000	36	SC200005000197-36	◆		
				-	0.2000	5.080	36	SC200005000200-36	◆		
		2	1/2	-	0.2100	5.334	36	SC200005000210-36	◆		
				7/32	0.2188	5.556	36	SC200005000219-36	◆		
				-	0.2200	5.588	36	SC200005000220-36	◆		
				-	0.2300	5.842	36	SC200005000230-36	◆		
				-	0.2362	6.000	36	SC200005000236-36	◆		
				-	0.2400	6.096	36	SC200005000240-36	◆		
				1/4	0.2500	6.350	36	SC200005000250-36	◆		
				1	1/2	1/16	0.0625	1.588	24	SC200010000063-24	◆
						3/32	0.0938	2.381	24	SC200010000094-24	◆
						1/8	0.1250	3.175	24	SC200010000125-24	◆
						1/32	0.0313	0.794	36	SC200010000031-36	◆
						3/64	0.0469	1.191	36	SC200010000047-36	◆
						1/16	0.0625	1.588	36	SC200010000063-36	◆
						3/32	0.0938	2.381	36	SC200010000094-36	◆
						1/8	0.1250	3.175	36	SC200010000125-36	◆
						3/16	0.1875	4.763	36	SC200010000188-36	◆
		1/4	0.2500			6.350	36	SC200010000250-36	◆		
		1/16	0.0625			1.588	48	SC200010000063-48	◆		
		3/32	0.0938			2.381	48	SC200010000094-48	◆		
		1/8	0.1250			3.175	48	SC200010000125-48	◆		
		1/32	0.0313			0.794	40	SC225005000031-40	◆		
		3/64	0.0469			1.191	40	SC225005000047-40	◆		
		1/16	0.0625			1.588	40	SC225005000063-40	◆		
		3/32	0.0938	2.381	40	SC225005000094-40	◆				
		1/8	0.1250	3.175	40	SC225005000125-40	◆				
		5/32	0.1563	3.969	40	SC225005000156-40	◆				
		2-1/4	5/8	1/16	0.0625	1.588	28	SC225006250063-28	◆		
				3/32	0.0938	2.381	28	SC225006250094-28	◆		
				1/8	0.1250	3.175	28	SC225006250125-28	◆		
				1/16	0.0625	1.588	56	SC225006250063-56	◆		
				3/32	0.0938	2.381	56	SC225006250094-56	◆		
				1/8	0.1250	3.175	56	SC225006250125-56	◆		
				1/32	0.0313	0.794	40	SC225010000031-40	◆		
				3/64	0.0469	1.191	40	SC225010000047-40	◆		
			1	5/8	1/16	0.0625	1.588	40	SC225010000063-40	◆	
					3/32	0.0938	2.381	40	SC225010000094-40	◆	
					1/8	0.1250	3.175	40	SC225010000125-40	◆	
					5/32	0.1563	3.969	40	SC225010000156-40	◆	

Recommended cutting conditions [Page H19](#)

Saw Dia. (in)	Arbor Hole Dia. (in)	Fraction (in)	Saw Width Decimal (in)	Metric (mm)	No. of Teeth	Part Number	Stock	Standard Tolerances
2-1/2	5/8	-	0.0080	0.203	48	SC250006250008-48	◆	Saw Dia. +0.005" -0.000"
		-	0.0100	0.254	48	SC250006250010-48	◆	
		-	0.0120	0.305	48	SC250006250012-48	◆	
		-	0.0140	0.356	48	SC250006250014-48	◆	
		1/64	0.0156	0.397	48	SC250006250015-48	◆	Arbor Hole Size +0.0005" -0.0000"
		-	0.0180	0.457	48	SC250006250018-48	◆	
		-	0.0200	0.508	48	SC250006250020-48	◆	
		-	0.0230	0.584	48	SC250006250023-48	◆	
		-	0.0250	0.635	48	SC250006250025-48	◆	Side Run-Out < 0.0005"
		-	0.0280	0.711	48	SC250006250028-48	◆	
		1/32	0.0300	0.762	48	SC250006250030-48	◆	
		-	0.0313	0.794	48	SC250006250031-48	◆	
		-	0.0350	0.889	48	SC250006250035-48	◆	Thickness +0.0005" -0.0000"
		-	0.0394	1.000	48	SC250006250039-48	◆	
		-	0.0400	1.016	48	SC250006250040-48	◆	
		3/64	0.0469	1.191	48	SC250006250047-48	◆	
		-	0.0500	1.270	48	SC250006250050-48	◆	DRILLS <b>A</b>
		-	0.0510	1.295	48	SC250006250051-48	◆	
		-	0.0600	1.524	48	SC250006250060-48	◆	
		1/16	0.0625	1.588	48	SC250006250063-48	◆	
		-	0.0700	1.778	48	SC250006250070-48	◆	
		5/64	0.0781	1.984	48	SC250006250078-48	◆	
		-	0.0787	2.000	48	SC250006250079-48	◆	ROUTERS <b>C</b>
		-	0.0800	2.032	48	SC250006250080-48	◆	
		-	0.0900	2.286	48	SC250006250090-48	◆	
		3/32	0.0938	2.381	48	SC250006250094-48	◆	
		-	0.1000	2.540	48	SC250006250100-48	◆	
		-	0.1100	2.794	48	SC250006250110-48	◆	
		-	0.1181	3.000	48	SC250006250118-48	◆	ENGRAVERS <b>E</b>
		-	0.1200	3.048	48	SC250006250120-48	◆	
		1/8	0.1250	3.175	48	SC250006250125-48	◆	
		-	0.1300	3.302	48	SC250006250130-48	◆	
	-	0.1400	3.556	48	SC250006250140-48	◆		
	-	0.1500	3.810	48	SC250006250150-48	◆		
	5/32	0.1563	3.969	48	SC250006250156-48	◆	REAMERS <b>G</b>	
	-	0.1575	4.000	48	SC250006250158-48	◆		
	-	0.1600	4.064	48	SC250006250160-48	◆		
	-	0.1700	4.318	48	SC250006250170-48	◆		SAWS <b>H</b>
	-	0.1800	4.572	48	SC250006250180-48	◆		
	3/16	0.1875	4.763	48	SC250006250188-48	◆		
	-	0.1900	4.826	48	SC250006250190-48	◆	TECHNICAL <b>I</b>	
	-	0.1969	5.000	48	SC250006250197-48	◆		
	-	0.2000	5.080	48	SC250006250200-48	◆		
	-	0.2100	5.334	48	SC250006250210-48	◆		INDEX <b>J</b>
	7/32	0.2188	5.556	48	SC250006250219-48	◆		
	-	0.2200	5.588	48	SC250006250220-48	◆		
	-	0.2300	5.842	48	SC250006250230-48	◆		
	-	0.2362	6.000	48	SC250006250236-48	◆	1	
-	0.2400	6.096	48	SC250006250240-48	◆			
1/4	0.2500	6.350	48	SC250006250250-48	◆			
1/16	0.0625	1.588	28	SC250010000063-28	◆			
		3/32	0.0938	2.381	28	SC250010000094-28	◆	
		1/8	0.1250	3.175	28	SC250010000125-28	◆	
		5/32	0.1563	3.969	28	SC250010000156-28	◆	

Recommended cutting conditions Page H19

◆ : Usually Ships in 24-48 Hours  
Depending on Size and Quantity

(U.S.) 1.888.848.8449  
(International) 001.714.428.3636  
Pricing & Availability at [KyoceraPrecisionTools.com](http://KyoceraPrecisionTools.com)



<b>A</b>	DRILLS
<b>B</b>	END MILLS
<b>C</b>	ROUTERS
<b>D</b>	THREAD MILLS & TAPS
<b>E</b>	ENGRAVERS
<b>F</b>	BORING BARS
<b>G</b>	REAMERS
<b>H</b>	SAWS
<b>I</b>	TECHNICAL
<b>J</b>	INDEX

Standard Tolerances		Saw Dia. (in)	Arbor Hole Dia. (in)	Fraction (in)	Saw Width Decimal (in)	Metric (mm)	No. of Teeth	Part Number	Stock
Saw Dia. +0.005" -0.000"	2-1/2	1	1/32	0.0313	0.794	48	SC250010000031-48	◆	
			3/64	0.0469	1.191	48	SC250010000047-48	◆	
			1/16	0.0625	1.588	48	SC250010000063-48	◆	
			3/32	0.0938	2.383	48	SC250010000094-48	◆	
Arbor Hole Size +0.0005" -0.0000"	2-1/2	1	1/8	0.1250	3.175	48	SC250010000125-48	◆	
			5/32	0.1563	3.969	48	SC250010000156-48	◆	
			3/16	0.1875	4.763	48	SC250010000188-48	◆	
			1/4	0.2500	6.350	48	SC250010000250-48	◆	
Side Run-Out < 0.0005"	2-1/2	1	1/16	0.0625	1.588	56	SC250010000063-56	◆	
			3/32	0.0938	2.381	56	SC250010000094-56	◆	
			1/8	0.1250	3.175	56	SC250010000125-56	◆	
			5/32	0.1563	3.969	56	SC250010000156-56	◆	
Thickness +0.0005" -0.0000"	2-3/4	1	1/16	0.0625	1.588	30	SC275010000063-30	◆	
			3/32	0.0938	2.381	30	SC275010000094-30	◆	
			1/8	0.1250	3.175	30	SC275010000125-30	◆	
			5/32	0.1563	3.969	30	SC275010000156-30	◆	
			-	0.0080	0.203	60	SC275010000008-60	◆	
			-	0.0100	0.254	60	SC275010000010-60	◆	
			-	0.0120	0.305	60	SC275010000012-60	◆	
			-	0.0140	0.356	60	SC275010000014-60	◆	
			1/64	0.0156	0.397	60	SC275010000015-60	◆	
			-	0.0180	0.457	60	SC275010000018-60	◆	
			-	0.0200	0.508	60	SC275010000020-60	◆	
			-	0.0230	0.584	60	SC275010000023-60	◆	
			-	0.0250	0.635	60	SC275010000025-60	◆	
			-	0.0280	0.711	60	SC275010000028-60	◆	
			-	0.0300	0.762	60	SC275010000030-60	◆	
			1/32	0.0313	0.794	60	SC275010000031-60	◆	
			-	0.0350	0.889	60	SC275010000035-60	◆	
			-	0.0394	1.000	60	SC275010000039-60	◆	
			-	0.0400	1.016	60	SC275010000040-60	◆	
			3/64	0.0469	1.191	60	SC275010000047-60	◆	
			-	0.0500	1.270	60	SC275010000050-60	◆	
			-	0.0510	1.295	60	SC275010000051-60	◆	
			-	0.0600	1.524	60	SC275010000060-60	◆	
			1/16	0.0625	1.588	60	SC275010000063-60	◆	
			-	0.0700	1.778	60	SC275010000070-60	◆	
			5/64	0.0781	1.984	60	SC275010000078-60	◆	
			-	0.0787	2.000	60	SC275010000079-60	◆	
			-	0.0800	2.032	60	SC275010000080-60	◆	
			-	0.0900	2.286	60	SC275010000090-60	◆	
			3/32	0.0938	2.381	60	SC275010000094-60	◆	
			-	0.1000	2.540	60	SC275010000100-60	◆	
			-	0.1100	2.794	60	SC275010000110-60	◆	
			-	0.1181	3.000	60	SC275010000118-60	◆	
			-	0.1200	3.048	60	SC275010000120-60	◆	
			1/8	0.1250	3.175	60	SC275010000125-60	◆	
			-	0.1300	3.302	60	SC275010000130-60	◆	
			-	0.1400	3.556	60	SC275010000140-60	◆	
			-	0.1500	3.810	60	SC275010000150-60	◆	
			5/32	0.1563	3.969	60	SC275010000156-60	◆	
			-	0.1575	4.000	60	SC275010000158-60	◆	
			-	0.1600	4.064	60	SC275010000160-60	◆	

Recommended cutting conditions [Page H19](#)

Saw Dia. (in)	Arbor Hole Dia. (in)	Saw Width			No. of Teeth	Part Number	Stock	Standard Tolerances
		Fraction (in)	Decimal (in)	Metric (mm)				
2-3/4	1	-	0.1700	4.318	60	SC275010000170-60	◆	Saw Dia. +0.005" -0.000"
		-	0.1800	4.572	60	SC275010000180-60	◆	
		3/16	0.1875	4.763	60	SC275010000188-60	◆	
		-	0.1900	4.826	60	SC275010000190-60	◆	
		-	0.1969	5.000	60	SC275010000197-60	◆	Arbor Hole Size +0.0005" -0.0000"
		-	0.2000	5.080	60	SC275010000200-60	◆	
		-	0.2100	5.334	60	SC275010000210-60	◆	
		7/32	0.2188	5.556	60	SC275010000219-60	◆	
		-	0.2200	5.588	60	SC275010000220-60	◆	Side Run-Out < 0.0005"
		-	0.2300	5.842	60	SC275010000230-60	◆	
		-	0.2362	6.000	60	SC275010000236-60	◆	
		-	0.2400	6.096	60	SC275010000240-60	◆	
		1/4	0.2500	6.350	60	SC275010000250-60	◆	Thickness +0.0005" -0.0000"
3	1	1/16	0.0625	1.588	30	SC300010000063-30	◆	
		3/32	0.0938	2.381	30	SC300010000094-30	◆	
		1/8	0.1250	3.175	30	SC300010000125-30	◆	
		5/32	0.1563	3.969	30	SC300010000156-30	◆	
		1/32	0.0313	0.794	60	SC300010000031-60	◆	
		3/64	0.0469	1.191	60	SC300010000047-60	◆	
		1/16	0.0625	1.588	60	SC300010000063-60	◆	
		3/32	0.0938	2.381	60	SC300010000094-60	◆	
		1/8	0.1250	3.175	60	SC300010000125-60	◆	
		5/32	0.1563	3.969	60	SC300010000156-60	◆	
		3/16	0.1875	4.763	60	SC300010000188-60	◆	
		1/4	0.2500	6.350	60	SC300010000250-60	◆	
4	1	1/16	0.0625	1.588	36	SC400010000063-36	◆	
		3/32	0.0938	2.381	36	SC400010000094-36	◆	
		1/8	0.1250	3.175	36	SC400010000125-36	◆	
		5/32	0.1563	3.969	36	SC400010000156-36	◆	
		1/4	0.2500	6.350	36	SC400010000250-36	◆	
		1/32	0.0313	0.794	72	SC400010000031-72	◆	
		3/64	0.0469	1.191	72	SC400010000047-72	◆	
		1/16	0.0625	1.588	72	SC400010000063-72	◆	
		3/32	0.0938	2.381	72	SC400010000094-72	◆	
		1/8	0.1250	3.175	72	SC400010000125-72	◆	
		5/32	0.1563	3.969	72	SC400010000156-72	◆	
		3/16	0.1875	4.763	72	SC400010000188-72	◆	
1/4	0.2500	6.350	72	SC400010000250-72	◆			

Recommended cutting conditions Page H19

DRILLS	A
END MILLS	B
ROUTERS	C
THREAD MILLS & TAPS	D
ENGRAVERS	E
BORING BARS	F
REAMERS	G
SAWS	H
TECHNICAL	I
INDEX	J

<b>A</b>	DRILLS
<b>B</b>	END MILLS
<b>C</b>	ROUTERS
<b>D</b>	THREAD MILLS & TAPS
<b>E</b>	ENGRAVERS
<b>F</b>	BORING BARS
<b>G</b>	REAMERS
<b>H</b>	SAWS
<b>I</b>	TECHNICAL
<b>J</b>	INDEX

Standard Tolerances	Saw Dia. (mm)	Arbor Hole Dia. (mm)	Saw Width			No. of Teeth	Part Number	Stock
			Fraction (in)	Decimal (in)	Metric (mm)			
Saw Dia. +0.1270mm -0.000mm	20	5	1/32	0.0313	0.794	10	SC20050794-10	◆
			3/64	0.0469	1.191	10	SC20051191-10	◆
			1/16	0.0625	1.588	10	SC20051588-10	◆
			1/32	0.0313	0.794	20	SC20050794-20	◆
			3/64	0.0469	1.191	20	SC20051191-20	◆
			1/16	0.0625	1.588	20	SC20051588-20	◆
Arbor Hole Size +0.0127mm -0.000mm	20	5	-	0.0080	0.203	10	SC25080203-10	◆
			-	0.0100	0.254	10	SC25080254-10	◆
			-	0.0120	0.305	10	SC25080305-10	◆
			-	0.0140	0.356	10	SC25080356-10	◆
			-	0.0156	0.396	10	SC25080396-10	◆
			-	0.0180	0.457	10	SC25080457-10	◆
Side Run-Out < 0.0127mm	20	5	-	0.0200	0.508	10	SC25080508-10	◆
			-	0.0230	0.584	10	SC25080584-10	◆
			-	0.0250	0.635	10	SC25080635-10	◆
			-	0.0280	0.711	10	SC25080711-10	◆
			-	0.0300	0.762	10	SC25080762-10	◆
			1/32	0.0313	0.795	10	SC25080795-10	◆
Thickness +0.0127mm -0.000mm	20	5	-	0.0350	0.889	10	SC25080889-10	◆
			-	0.0394	1.001	10	SC25081001-10	◆
			-	0.0400	1.016	10	SC25081016-10	◆
			3/64	0.0469	1.191	10	SC25081191-10	◆
			-	0.0500	1.270	10	SC25081270-10	◆
			-	0.0510	1.295	10	SC25081295-10	◆
	25	8	-	0.0600	1.524	10	SC25081524-10	◆
			1/16	0.0625	1.588	10	SC25081588-10	◆
			-	0.0700	1.778	10	SC25081778-10	◆
			-	0.0781	1.984	10	SC25081984-10	◆
			-	0.0787	1.999	10	SC25081999-10	◆
			-	0.0800	2.032	10	SC25082032-10	◆
	25	8	-	0.0900	2.286	10	SC25082286-10	◆
			3/32	0.0938	2.383	10	SC25082383-10	◆
			-	0.1000	2.540	10	SC25082540-10	◆
			-	0.1100	2.794	10	SC25082794-10	◆
			-	0.1181	3.000	10	SC25083000-10	◆
			-	0.1200	3.048	10	SC25083048-10	◆
	25	8	-	0.1250	3.175	10	SC25083175-10	◆
			-	0.1300	3.302	10	SC25083302-10	◆
			-	0.1400	3.556	10	SC25083556-10	◆
			-	0.1500	3.810	10	SC25083810-10	◆
			5/32	0.1563	3.970	10	SC25083970-10	◆
			-	0.1575	4.001	10	SC25084001-10	◆
	25	8	-	0.1600	4.064	10	SC25084064-10	◆
			-	0.1700	4.318	10	SC25084318-10	◆
			-	0.1800	4.572	10	SC25084572-10	◆
			3/16	0.1875	4.763	10	SC25084763-10	◆
			-	0.1900	4.826	10	SC25084826-10	◆
			-	0.1969	5.001	10	SC25085001-10	◆
	25	8	-	0.2000	5.080	10	SC25085080-10	◆
			-	0.2100	5.334	10	SC25085334-10	◆
			-	0.2188	5.558	10	SC25085558-10	◆
			-	0.2200	5.588	10	SC25085588-10	◆
			-	0.2300	5.842	10	SC25085842-10	◆
			-	0.2300	5.842	10	SC25085842-10	◆

Recommended cutting conditions [Page H19](#)



Saw Dia. (mm)	Arbor Hole Dia. (mm)	Saw Width			No. of Teeth	Part Number	Stock	Standard Tolerances
		Fraction (in)	Decimal (in)	Metric (mm)				
25	8	-	0.2362	5.999	10	SC25085999-10	◆	Saw Dia. +0.1270mm -0.000mm
		-	0.2400	6.096	10	SC25086096-10	◆	
		-	0.2500	6.350	10	SC25086350-10	◆	
		-	0.0080	0.203	20	SC25080203-20	◆	
		-	0.0100	0.254	20	SC25080254-20	◆	
		-	0.0120	0.305	20	SC25080305-20	◆	
		-	0.0140	0.356	20	SC25080356-20	◆	
		-	0.0156	0.396	20	SC25080396-20	◆	Side Run-Out < 0.0127mm
		-	0.0180	0.457	20	SC25080457-20	◆	
		-	0.0200	0.508	20	SC25080508-20	◆	
		-	0.0230	0.584	20	SC25080584-20	◆	
		-	0.0250	0.635	20	SC25080635-20	◆	Thickness +0.0127mm -0.0000mm
		-	0.0280	0.711	20	SC25080711-20	◆	
		-	0.0300	0.762	20	SC25080762-20	◆	
		1/32	0.0313	0.795	20	SC25080795-20	◆	
		-	0.0350	0.889	20	SC25080889-20	◆	DRILLS <b>A</b>
		-	0.0394	1.001	20	SC25081001-20	◆	
		-	0.0400	1.016	20	SC25081016-20	◆	
		3/64	0.0469	1.191	20	SC25081191-20	◆	
		-	0.0500	1.270	20	SC25081270-20	◆	
		-	0.0510	1.295	20	SC25081295-20	◆	
		-	0.0600	1.524	20	SC25081524-20	◆	ROUTERS <b>C</b>
		1/16	0.0625	1.588	20	SC25081588-20	◆	
		-	0.0700	1.778	20	SC25081778-20	◆	
		-	0.0781	1.984	20	SC25081984-20	◆	
		-	0.0787	1.999	20	SC25081999-20	◆	
		-	0.0800	2.032	20	SC25082032-20	◆	
		-	0.0900	2.286	20	SC25082286-20	◆	ENGRAVERS <b>E</b>
		3/32	0.0938	2.383	20	SC25082383-20	◆	
		-	0.1000	2.540	20	SC25082540-20	◆	
		-	0.1100	2.794	20	SC25082794-20	◆	
		-	0.1181	3.000	20	SC25083000-20	◆	
		-	0.1200	3.048	20	SC25083048-20	◆	
		-	0.1250	3.175	20	SC25083175-20	◆	REAMERS <b>G</b>
		-	0.1300	3.302	20	SC25083302-20	◆	
		-	0.1400	3.556	20	SC25083556-20	◆	
		-	0.1500	3.810	20	SC25083810-20	◆	
		5/32	0.1563	3.970	20	SC25083970-20	◆	
		-	0.1575	4.001	20	SC25084001-20	◆	
		-	0.1600	4.064	20	SC25084064-20	◆	TECHNICAL <b>I</b>
-	0.1700	4.318	20	SC25084318-20	◆			
-	0.1800	4.572	20	SC25084572-20	◆			
3/16	0.1875	4.763	20	SC25084763-20	◆	INDEX <b>J</b>		
-	0.1900	4.826	20	SC25084826-20	◆			
-	0.1969	5.001	20	SC25085001-20	◆			
-	0.2000	5.080	20	SC25085080-20	◆			
-	0.2100	5.334	20	SC25085334-20	◆			
-	0.2188	5.558	20	SC25085558-20	◆			
-	0.2200	5.588	20	SC25085588-20	◆			
-	0.2300	5.842	20	SC25085842-20	◆			
-	0.2362	5.999	20	SC25085999-20	◆			
-	0.2400	6.096	20	SC25086096-20	◆			
-	0.2500	6.350	20	SC25086350-20	◆			

Recommended cutting conditions Page H19

◆ : Usually Ships in 24-48 Hours  
Depending on Size and Quantity



<b>A</b>	DRILLS
<b>B</b>	END MILLS
<b>C</b>	ROUTERS
<b>D</b>	THREAD MILLS & TAPS
<b>E</b>	ENGRAVERS
<b>F</b>	BORING BARS
<b>G</b>	REAMERS
<b>H</b>	SAWS
<b>I</b>	TECHNICAL
<b>J</b>	INDEX

Standard Tolerances	Saw Dia. (mm)	Arbor Hole Dia. (mm)	Saw Width			No. of Teeth	Part Number	Stock
			Fraction (in)	Decimal (in)	Metric (mm)			
Saw Dia. +0.1270mm -0.000mm	30	8	1/32	0.0313	0.794	16	SC30080794-16	◆
			3/64	0.0469	1.191	16	SC30081191-16	◆
			1/16	0.0625	1.588	16	SC30081588-16	◆
			3/32	0.0938	2.383	16	SC30082383-16	◆
			1/8	0.1250	3.175	16	SC30083175-16	◆
			1/32	0.0313	0.794	32	SC30080794-32	◆
			3/64	0.0469	1.191	32	SC30081191-32	◆
			1/16	0.0625	1.588	32	SC30081588-32	◆
			3/32	0.0938	2.383	32	SC30082383-32	◆
			1/8	0.1250	3.175	32	SC30083175-32	◆
			1/32	0.0313	0.794	16	SC40100794-16	◆
			3/64	0.0469	1.191	16	SC40101191-16	◆
Arbor Hole Size +0.0127mm -0.0000mm	40	10	1/16	0.0625	1.588	16	SC40101588-16	◆
			3/32	0.0938	2.383	16	SC40102383-16	◆
			1/8	0.1250	3.175	16	SC40103175-16	◆
			1/32	0.0313	0.794	32	SC40100794-32	◆
			3/64	0.0469	1.191	32	SC40101191-32	◆
			1/16	0.0625	1.588	32	SC40101588-32	◆
			3/32	0.0938	2.383	32	SC40102383-32	◆
			1/8	0.1250	3.175	32	SC40103175-32	◆
			-	0.0080	0.203	20	SC50130203-20	◆
			-	0.0100	0.254	20	SC50130254-20	◆
			-	0.0120	0.305	20	SC50130305-20	◆
			-	0.0140	0.356	20	SC50130356-20	◆
Side Run-Out < 0.0127mm	50	13	-	0.0156	0.396	20	SC50130396-20	◆
			-	0.0180	0.457	20	SC50130457-20	◆
			-	0.0200	0.508	20	SC50130508-20	◆
			-	0.0230	0.584	20	SC50130584-20	◆
			-	0.0250	0.635	20	SC50130635-20	◆
			-	0.0280	0.711	20	SC50130711-20	◆
			-	0.0300	0.762	20	SC50130762-20	◆
			1/32	0.0313	0.795	20	SC50130795-20	◆
			-	0.0350	0.889	20	SC50130889-20	◆
			-	0.0394	1.001	20	SC50131001-20	◆
			-	0.0400	1.016	20	SC50131016-20	◆
			3/64	0.0469	1.191	20	SC50131191-20	◆
Thickness +0.0127mm -0.0000mm	50	13	-	0.0500	1.270	20	SC50131270-20	◆
			-	0.0510	1.295	20	SC50131295-20	◆
			-	0.0600	1.524	20	SC50131524-20	◆
			1/16	0.0625	1.588	20	SC50131588-20	◆
			-	0.0700	1.778	20	SC50131778-20	◆
			-	0.0781	1.984	20	SC50131984-20	◆
			-	0.0787	1.999	20	SC50131999-20	◆
			-	0.0800	2.032	20	SC50132032-20	◆
			-	0.0900	2.286	20	SC50132286-20	◆
			3/32	0.0938	2.383	20	SC50132383-20	◆
			-	0.1000	2.540	20	SC50132540-20	◆
			-	0.1100	2.794	20	SC50132794-20	◆
Recommended cutting conditions <a href="#">Page H19</a>								

Saw Dia. (mm)	Arbor Hole Dia. (mm)	Saw Width			No. of Teeth	Part Number	Stock	Standard Tolerances
		Fraction (in)	Decimal (in)	Metric (mm)				
50	13	-	0.1500	3.810	20	SC50133810-20	◆	Saw Dia. +0.1270mm -0.000mm
		5/32	0.1563	3.970	20	SC50133970-20	◆	
		-	0.1575	4.001	20	SC50134001-20	◆	
		-	0.1600	4.064	20	SC50134064-20	◆	
		-	0.1700	4.318	20	SC50134318-20	◆	Arbor Hole Size +0.0127mm -0.000mm
		-	0.1800	4.572	20	SC50134572-20	◆	
		3/16	0.1875	4.763	20	SC50134763-20	◆	
		-	0.1900	4.826	20	SC50134826-20	◆	
		-	0.1969	5.001	20	SC50135001-20	◆	Side Run-Out < 0.0127mm
		-	0.2000	5.080	20	SC50135080-20	◆	
		-	0.2100	5.334	20	SC50135334-20	◆	
		-	0.2188	5.558	20	SC50135558-20	◆	
		-	0.2200	5.588	20	SC50135588-20	◆	Thickness +0.0127mm -0.000mm
		-	0.2300	5.842	20	SC50135842-20	◆	
		-	0.2362	5.999	20	SC50135999-20	◆	
		-	0.2400	6.096	20	SC50136096-20	◆	
		-	0.2500	6.350	20	SC50136350-20	◆	DRILLS <b>A</b>
		-	0.0080	0.203	40	SC50130203-40	◆	
		-	0.0100	0.254	40	SC50130254-40	◆	
		-	0.0120	0.305	40	SC50130305-40	◆	
		-	0.0140	0.356	40	SC50130356-40	◆	END MILLS <b>B</b>
		-	0.0156	0.396	40	SC50130396-40	◆	
		-	0.0180	0.457	40	SC50130457-40	◆	
		-	0.0200	0.508	40	SC50130508-40	◆	
		-	0.0230	0.584	40	SC50130584-40	◆	ROUTERS <b>C</b>
		-	0.0250	0.635	40	SC50130635-40	◆	
		-	0.0280	0.711	40	SC50130711-40	◆	
		-	0.0300	0.762	40	SC50130762-40	◆	
		1/32	0.0313	0.795	40	SC50130795-40	◆	THREAD MILLS & TAPS <b>D</b>
		-	0.0350	0.889	40	SC50130889-40	◆	
		-	0.0394	1.001	40	SC50131001-40	◆	
		-	0.0400	1.016	40	SC50131016-40	◆	
		3/64	0.0469	1.191	40	SC50131191-40	◆	ENGRAVERS <b>E</b>
		-	0.0500	1.270	40	SC50131270-40	◆	
		-	0.0510	1.295	40	SC50131295-40	◆	
		-	0.0600	1.524	40	SC50131524-40	◆	
		1/16	0.0625	1.588	40	SC50131588-40	◆	BORING BARS <b>F</b>
		-	0.0700	1.778	40	SC50131778-40	◆	
		-	0.0781	1.984	40	SC50131984-40	◆	
		-	0.0787	1.999	40	SC50131999-40	◆	
-	0.0800	2.032	40	SC50132032-40	◆	REAMERS <b>G</b>		
-	0.0900	2.286	40	SC50132286-40	◆			
3/32	0.0938	2.383	40	SC50132383-40	◆			
-	0.1000	2.540	40	SC50132540-40	◆			
-	0.1100	2.794	40	SC50132794-40	◆	SAWS <b>H</b>		
-	0.1181	3.000	40	SC50133000-40	◆			
-	0.1200	3.048	40	SC50133048-40	◆			
-	0.1250	3.175	40	SC50133175-40	◆			
-	0.1300	3.302	40	SC50133302-40	◆	TECHNICAL <b>I</b>		
-	0.1400	3.556	40	SC50133556-40	◆			
-	0.1500	3.810	40	SC50133810-40	◆			
5/32	0.1563	3.970	40	SC50133970-40	◆			
-	0.1575	4.001	40	SC50134001-40	◆	INDEX <b>J</b>		

Recommended cutting conditions Page H19

◆ : Usually Ships in 24-48 Hours  
Depending on Size and Quantity

- A** DRILLS
- B** END MILLS
- C** ROUTERS
- D** THREAD MILLS & TAPS
- E** ENGRAVERS
- F** BORING BARS
- G** REAMERS
- H** SAWS
- I** TECHNICAL
- J** INDEX

Standard Tolerances		Saw Dia. (mm)	Arbor Hole Dia. (mm)	Fraction (in)	Saw Width Decimal (in)	Metric (mm)	No. of Teeth	Part Number	Stock
<b>Saw Dia.</b> +0.1270mm -0.000mm	<b>Arbor Hole Size</b> +0.0127mm -0.0000mm	50	13	-	0.1600	4.064	40	SC50134064-40	◆
				-	0.1700	4.318	40	SC50134318-40	◆
				-	0.1800	4.572	40	SC50134572-40	◆
				3/16	0.1875	4.763	40	SC50134763-40	◆
				-	0.1900	4.826	40	SC50134826-40	◆
				-	0.1969	5.001	40	SC50135001-40	◆
				-	0.2000	5.080	40	SC50135080-40	◆
				-	0.2100	5.334	40	SC50135334-40	◆
				-	0.2188	5.558	40	SC50135558-40	◆
				-	0.2200	5.588	40	SC50135588-40	◆
				-	0.2300	5.842	40	SC50135842-40	◆
				<b>Side Run-Out</b> < 0.0127mm	<b>Thickness</b> +0.0127mm -0.0000mm	50	13	-	0.2362
-	0.2400	6.096	40					SC50136096-40	◆
-	0.2500	6.350	40					SC50136350-40	◆
-	0.0080	0.203	24					SC63160203-24	◆
-	0.0100	0.254	24					SC63160254-24	◆
-	0.0120	0.305	24					SC63160305-24	◆
-	0.0140	0.356	24					SC63160356-24	◆
-	0.0156	0.396	24					SC63160396-24	◆
-	0.0180	0.457	24					SC63160457-24	◆
-	0.0200	0.508	24					SC63160508-24	◆
-	0.0230	0.584	24					SC63160584-24	◆
<b>Thickness</b> +0.0127mm -0.0000mm	<b>Thickness</b> +0.0127mm -0.0000mm	63	16					-	0.0250
				-	0.0280	0.711	24	SC63160711-24	◆
				-	0.0300	0.762	24	SC63160762-24	◆
				1/32	0.0313	0.795	24	SC63160795-24	◆
				-	0.0350	0.889	24	SC63160889-24	◆
				-	0.0394	1.001	24	SC63161001-24	◆
				-	0.0400	1.016	24	SC63161016-24	◆
				3/64	0.0469	1.191	24	SC63161191-24	◆
				-	0.0500	1.270	24	SC63161270-24	◆
				-	0.0510	1.295	24	SC63161295-24	◆
				-	0.0600	1.524	24	SC63161524-24	◆
				<b>Thickness</b> +0.0127mm -0.0000mm	<b>Thickness</b> +0.0127mm -0.0000mm	63	16	1/16	0.0625
-	0.0700	1.778	24					SC63161778-24	◆
-	0.0781	1.984	24					SC63161984-24	◆
-	0.0787	1.999	24					SC63161999-24	◆
-	0.0800	2.032	24					SC63162032-24	◆
-	0.0900	2.286	24					SC63162286-24	◆
3/32	0.0938	2.383	24					SC63162383-24	◆
-	0.1000	2.540	24					SC63162540-24	◆
-	0.1100	2.794	24					SC63162794-24	◆
-	0.1181	3.000	24					SC63163000-24	◆
-	0.1200	3.048	24					SC63163048-24	◆
<b>Thickness</b> +0.0127mm -0.0000mm	<b>Thickness</b> +0.0127mm -0.0000mm	63	16					-	0.1250
				-	0.1300	3.302	24	SC63163302-24	◆
				-	0.1400	3.556	24	SC63163556-24	◆
				-	0.1500	3.810	24	SC63163810-24	◆
				5/32	0.1563	3.970	24	SC63163970-24	◆
				-	0.1575	4.001	24	SC63164001-24	◆
				-	0.1600	4.064	24	SC63164064-24	◆
				-	0.1700	4.318	24	SC63164318-24	◆
				-	0.1800	4.572	24	SC63164572-24	◆

Recommended cutting conditions [Page H19](#)

Saw Dia. (mm)	Arbor Hole Dia. (mm)	Saw Width			No. of Teeth	Part Number	Stock	Standard Tolerances
		Fraction (in)	Decimal (in)	Metric (mm)				
63	16	3/16	0.1875	4.763	24	SC63164763-24	◆	Saw Dia. +0.1270mm -0.000mm
		-	0.1900	4.826	24	SC63164826-24	◆	
		-	0.1969	5.001	24	SC63165001-24	◆	
		-	0.2000	5.080	24	SC63165080-24	◆	
		-	0.2100	5.334	24	SC63165334-24	◆	Arbor Hole Size +0.0127mm -0.000mm
		-	0.2188	5.558	24	SC63165558-24	◆	
		-	0.2200	5.588	24	SC63165588-24	◆	
		-	0.2300	5.842	24	SC63165842-24	◆	
		-	0.2362	5.999	24	SC63165999-24	◆	Side Run-Out < 0.0127mm
		-	0.2400	6.096	24	SC63166096-24	◆	
		-	0.2500	6.350	24	SC63166350-24	◆	
		-	0.0080	0.203	48	SC63160203-48	◆	
		-	0.0100	0.254	48	SC63160254-48	◆	Thickness +0.0127mm -0.000mm
		-	0.0120	0.305	48	SC63160305-48	◆	
		-	0.0140	0.356	48	SC63160356-48	◆	
		-	0.0156	0.396	48	SC63160396-48	◆	
		-	0.0180	0.457	48	SC63160457-48	◆	A
		-	0.0200	0.508	48	SC63160508-48	◆	
		-	0.0230	0.584	48	SC63160584-48	◆	
		-	0.0250	0.635	48	SC63160635-48	◆	
		-	0.0280	0.711	48	SC63160711-48	◆	B
		-	0.0300	0.762	48	SC63160762-48	◆	
		1/32	0.0313	0.795	48	SC63160795-48	◆	
		-	0.0350	0.889	48	SC63160889-48	◆	
		-	0.0394	1.001	48	SC63161001-48	◆	C
		-	0.0400	1.016	48	SC63161016-48	◆	
		3/64	0.0469	1.191	48	SC63161191-48	◆	
		-	0.0500	1.270	48	SC63161270-48	◆	
		-	0.0510	1.295	48	SC63161295-48	◆	D
		-	0.0600	1.524	48	SC63161524-48	◆	
		1/16	0.0625	1.588	48	SC63161588-48	◆	
		-	0.0700	1.778	48	SC63161778-48	◆	
		-	0.0781	1.984	48	SC63161984-48	◆	E
		-	0.0787	1.999	48	SC63161999-48	◆	
		-	0.0800	2.032	48	SC63162032-48	◆	
		-	0.0900	2.286	48	SC63162286-48	◆	
		3/32	0.0938	2.383	48	SC63162383-48	◆	F
		-	0.1000	2.540	48	SC63162540-48	◆	
		-	0.1100	2.794	48	SC63162794-48	◆	
		-	0.1181	3.000	48	SC63163000-48	◆	
-	0.1200	3.048	48	SC63163048-48	◆	G		
-	0.1250	3.175	48	SC63163175-48	◆			
-	0.1300	3.302	48	SC63163302-48	◆			
-	0.1400	3.556	48	SC63163556-48	◆			
-	0.1500	3.810	48	SC63163810-48	◆	H		
5/32	0.1563	3.970	48	SC63163970-48	◆			
-	0.1575	4.001	48	SC63164001-48	◆			
-	0.1600	4.064	48	SC63164064-48	◆			
-	0.1700	4.318	48	SC63164318-48	◆	I		
-	0.1800	4.572	48	SC63164572-48	◆			
3/16	0.1875	4.763	48	SC63164763-48	◆			
-	0.1900	4.826	48	SC63164826-48	◆			
-	0.1969	5.001	48	SC63165001-48	◆	J		

Recommended cutting conditions Page H19

◆ : Usually Ships in 24-48 Hours  
Depending on Size and Quantity

	Standard Tolerances	Saw Dia. (mm)	Arbor Hole Dia. (mm)	Saw Width			No. of Teeth	Part Number	Stock
				Fraction (in)	Decimal (in)	Metric (mm)			
A DRILLS	Saw Dia. +0.1270mm -0.000mm	63	16	-	0.2000	5.080	48	SC63165080-48	◆
				-	0.2100	5.334	48	SC63165334-48	◆
				-	0.2188	5.558	48	SC63165558-48	◆
				-	0.2200	5.588	48	SC63165588-48	◆
				-	0.2300	5.842	48	SC63165842-48	◆
				-	0.2362	5.999	48	SC63165999-48	◆
				-	0.2400	6.096	48	SC63166096-48	◆
				-	0.2500	6.350	48	SC63166350-48	◆
B END MILLS	Arbor Hole Size +0.0127mm -0.000mm	63	16	1/32	0.0313	0.794	30	SC80220794-30	◆
				3/64	0.0469	1.191	30	SC80221191-30	◆
				1/16	0.0625	1.588	30	SC80221588-30	◆
				3/32	0.0938	2.383	30	SC80222383-30	◆
				1/8	0.1250	3.175	30	SC80223175-30	◆
				5/32	0.1563	3.969	30	SC80223969-30	◆
				3/16	0.1875	4.763	30	SC80224763-30	◆
				1/4	0.2500	6.350	30	SC80226350-30	◆
C ROUTERS	Side Run-Out < 0.0127mm	80	22	1/32	0.0313	0.794	60	SC80220794-60	◆
				3/64	0.0469	1.191	60	SC80221191-60	◆
				1/16	0.0625	1.588	60	SC80221588-60	◆
				3/32	0.0938	2.383	60	SC80222383-60	◆
				1/8	0.1250	3.175	60	SC80223175-60	◆
				5/32	0.1563	3.969	60	SC80223969-60	◆
				3/16	0.1875	4.763	60	SC80224763-60	◆
				1/4	0.2500	6.350	60	SC80226350-60	◆
D THREAD MILLS & TAPS	Thickness +0.0127mm -0.000mm	80	22	1/32	0.0313	0.794	40	SC100220794-40	◆
				3/64	0.0469	1.191	40	SC100221191-40	◆
				1/16	0.0625	1.588	40	SC100221588-40	◆
				3/32	0.0938	2.383	40	SC100222383-40	◆
				1/8	0.1250	3.175	40	SC100223175-40	◆
				5/32	0.1563	3.969	40	SC100223969-40	◆
				3/16	0.1875	4.763	40	SC100224763-40	◆
				1/4	0.2500	6.350	40	SC100226350-40	◆
E ENGRAVERS		100	22	1/32	0.0313	0.794	80	SC100220794-80	◆
				3/64	0.0469	1.191	80	SC100221191-80	◆
				1/16	0.0625	1.588	80	SC100221588-80	◆
				3/32	0.0938	2.383	80	SC100222383-80	◆
				1/8	0.1250	3.175	80	SC100223175-80	◆
				5/32	0.1563	3.969	80	SC100223969-80	◆
				3/16	0.1875	4.763	80	SC100224763-80	◆
				1/4	0.2500	6.350	80	SC100226350-80	◆
F BORING BARS		100	22	1/32	0.0313	0.794	80	SC100220794-80	◆
				3/64	0.0469	1.191	80	SC100221191-80	◆
				1/16	0.0625	1.588	80	SC100221588-80	◆
				3/32	0.0938	2.383	80	SC100222383-80	◆
				1/8	0.1250	3.175	80	SC100223175-80	◆
				5/32	0.1563	3.969	80	SC100223969-80	◆
				3/16	0.1875	4.763	80	SC100224763-80	◆
				1/4	0.2500	6.350	80	SC100226350-80	◆
G REAMERS		100	22	1/32	0.0313	0.794	80	SC100220794-80	◆
				3/64	0.0469	1.191	80	SC100221191-80	◆
				1/16	0.0625	1.588	80	SC100221588-80	◆
				3/32	0.0938	2.383	80	SC100222383-80	◆
				1/8	0.1250	3.175	80	SC100223175-80	◆
				5/32	0.1563	3.969	80	SC100223969-80	◆
				3/16	0.1875	4.763	80	SC100224763-80	◆
				1/4	0.2500	6.350	80	SC100226350-80	◆
H SAWS		100	22	1/32	0.0313	0.794	80	SC100220794-80	◆
				3/64	0.0469	1.191	80	SC100221191-80	◆
				1/16	0.0625	1.588	80	SC100221588-80	◆
				3/32	0.0938	2.383	80	SC100222383-80	◆
				1/8	0.1250	3.175	80	SC100223175-80	◆
				5/32	0.1563	3.969	80	SC100223969-80	◆
				3/16	0.1875	4.763	80	SC100224763-80	◆
				1/4	0.2500	6.350	80	SC100226350-80	◆
I TECHNICAL		100	22	1/32	0.0313	0.794	80	SC100220794-80	◆
				3/64	0.0469	1.191	80	SC100221191-80	◆
				1/16	0.0625	1.588	80	SC100221588-80	◆
				3/32	0.0938	2.383	80	SC100222383-80	◆
				1/8	0.1250	3.175	80	SC100223175-80	◆
				5/32	0.1563	3.969	80	SC100223969-80	◆
				3/16	0.1875	4.763	80	SC100224763-80	◆
				1/4	0.2500	6.350	80	SC100226350-80	◆
J INDEX		100	22	1/32	0.0313	0.794	80	SC100220794-80	◆
				3/64	0.0469	1.191	80	SC100221191-80	◆
				1/16	0.0625	1.588	80	SC100221588-80	◆
				3/32	0.0938	2.383	80	SC100222383-80	◆
				1/8	0.1250	3.175	80	SC100223175-80	◆
				5/32	0.1563	3.969	80	SC100223969-80	◆
				3/16	0.1875	4.763	80	SC100224763-80	◆
				1/4	0.2500	6.350	80	SC100226350-80	◆

Recommended cutting conditions [Page H19](#)

# RECOMMENDED CUTTING CONDITIONS

These are general cutting speed recommendations of SFM rates, and may vary from application to application.

Material* To Be Cut	Hardness Range (Bhn**)	Carbide Saw Cutting Speed SFM / (m/min.)	Material* To Be Cut	Hardness Range (Bhn**)	Carbide Saw Cutting Speed SFM / (m/min.)
Free Machining Carbon Steels-Wrought	100-425	130-555 (40-170)	Malleable Cast Irons	110-320	130-470 (40-145)
Carbon Steels- Wrought	85-425	105-530 (35-165)	Chromium-Nickel Alloy Castings	275-375	85-105 (25-35)
Carbon & Ferritic Alloy Steels (High Temp. Service)	150-200	320-425 (100-130)	Aluminum Alloys-Wrought	30-150	3400-4250 (1042-1300)
Free Machining Alloy Steels-Wrought	150-425	35-470 (11-145)	Aluminum Alloys-Cast	40-125	2125-5315 (640-1615)
Alloy Steels, Wrought	125-425	35-425 (11-130)	Magnesium Alloys-Wrought	40-125	5100-6375 (1555-1955)
High Strength Steels-Wrought	225-400	35-255 (11-80)	Magnesium Alloys-Cast	50-90	5100-6375 (1555-1955)
Maraging Steels- Wrought	275-425	35-215 (11-65)	Titanium Alloys-Wrought	110-440	65-530 (25-165)
Tool Steels- Wrought	100-375	35-470 (11-145)	Titanium Alloys-Cast	150-350	170-470 (55-145)
Nitriding Steels- Wrought	200-350	150-215 (50-65)	Copper Alloys-Wrought	10R <sub>B</sub> -100R <sub>B</sub>	340-2125 (105-640)
Armor Plate, Ship Plate, Aircraft Plate-Wrought	200-350	65-215 (25-65)	Copper Alloys-Cast	40-200	340-1700 (105-510)
Structural Steels- Wrought	100-400	35-255 (11-80)	Nickel Alloys- Wrought and Cast	80-360	65-300 (25-90)
Free Machining Stainless Steels-Wrought	135-425	150-470 (50-145)	Beryllium Nickel Alloys- Wrought and Cast	200-425 47-52R <sub>C</sub>	35-215 (11-65)
Stainless Steels- Wrought	135-425	35-425 (11-130)	High Temp. Alloys- Wrought and Cast	140-475	35-255 (11-80)
Precipitation Hardening Stainless Steels-Wrought	150-440	85-340 (25-105)	Refractory Alloys- Cast, P/M	170-320	150-300 (50-90)
Stainless Steels- Cast	135-425	105-425 (35-130)	Zinc Alloys- Cast	80-100	1380-1700 (425-510)
Precipitation Hardening Stainless Steels-Cast	325-450	65-130 (25-40)	Lead Alloys- Cast	5-20	1065-1275 (325-385)
Carbon Steels- Cast	100-300	170-530 (55-165)	TiN Alloys- Cast	15-30	1065-1275 (325-385)
Alloy Steels- Cast	150-400	105-340 (35-105)	Zirconium Alloys- Wrought	140-280	215-255 (65-80)
Tool Steels- Cast	150-375 & 48-50R <sub>C</sub>	35-300 (11-90)	Manganese- Wrought	140-220	105-130 (35-40)
Gray Cast Irons	120-320	105-470 (35-145)	P/M Alloys- Copper	50-70R <sub>F</sub>	170-215 (55-65)
Compacted Graphite Cast Irons	120-330	105-170 (35-55)	P/M Alloys- Brasses	35-81R <sub>H</sub>	215-255 (65-80)
Ductile Cast Irons	120-330	85-510 (25-160)	P/M Alloys- Bronzes	30-75R <sub>F</sub>	170-215 (55-65)

DRILLS	<b>A</b>
END MILLS	<b>B</b>
ROUTERS	<b>C</b>
THREAD MILLS & TAPS	<b>D</b>
ENGRAVERS	<b>E</b>
BORING BARS	<b>F</b>
REAMERS	<b>G</b>
SAWS	<b>H</b>
TECHNICAL	<b>I</b>
INDEX	<b>J</b>

(Continued on Next Page)

\*Materials list from Machining Data Handbook-3rd Edition, published by the Machinability Data Center. For specific metals/materials within each material category, refer to Machining Data Handbook.

\*\*Hardness range listed in Brinell unless otherwise noted. 'Range' covers all metals/materials listed within each material group.

\*\*\*Thermosetting plastics have various hardness scales. Refer to Machining Data Handbook.

# RECOMMENDED CUTTING CONDITIONS

A DRILLS  
B END MILLS  
C ROUTERS  
D THREAD MILLS & TAPS  
E ENGRAVERS  
F BORING BARS  
G REAMERS  
H SAWS  
I TECHNICAL  
J INDEX

Material* To Be Cut	Hardness Range (Bhn**)	Carbide Saw Cutting Speed SFM / (m/min.)
P/M Alloys- Copper-Nickel Alloys	22-100RH	170-215 55-65
P/M Alloys- Nickel and Nickel Alloys	70-83	170-215 55-65
P/M Alloys- Refractory Metal Base	101-260	405-510 124-160
P/M Alloys- Irons	50-67	215-255 65-80
P/M Alloys- Steels	101-426	150-255 50-80
P/M Alloys- Stainless Steels	107-285	170-215 55-65
P/M Alloys- Aluminum Alloys	55-98RH	510-640 160-195
Machinable Carbides	40-51Rc	35-45 11-13
Free Machining Magnetic Alloys	185-240	215-340 65-105
Magnetic Alloys	185-240	55-215 16-65
Free Machining Controlled Expansion Alloys	125-220	215-255 65-80
Controlled Expansion Alloys	125-250	35-45 11-13
Carbons and Graphites	8-100 Shore	150-215 50-65
Glasses and Ceramics- Machinable	250 Knoop	85-105 25-35
Plastics- Thermoplastics	60-120RM	1065-1490 325-450
Plastics- Thermosetting	50-120RR ***	340-1490 105-450

\*Materials list from Machining Data Handbook-3rd Edition, published by the Machinability Data Center. For specific metals/materials within each material category, refer to Machining Data Handbook.

\*\*Hardness range listed in Brinell unless otherwise noted. 'Range' covers all metals/materials listed within each material group.

\*\*\*Thermosetting plastics have various hardness scales. Refer to Machining Data Handbook.

## USEFUL METALWORKING FORMULAS

<b>SFM</b>	=	.262 X (CUTTER DIA. X RPM) (or) (RPM X CUTTER DIA.) ÷ .382
<b>RPM</b>	=	(3.82 X SFPM) ÷ CUTTER DIA. (or) SFPM ÷ (CUTTER DIA. X .262)
<b>IPM</b>	=	IPR X (# TEETH X RPM)
<b>IPT</b>	=	IPM ÷ (# TEETH X RPM)
<b>IPR</b>	=	IPM ÷ RPM
<b>CIM</b>	=	IPR X SPD. X DOC
<b>HP</b>	=	CIM X UHF
<b>FORCE</b>	=	(33,000 X HP) ÷ SFM

## FEED RATES:

Carbide Saws:

.0002"- .0015" (in.per tooth - IPT)  
or chip load per tooth - CLPT)

NOTE: This is a conservative recommendation as a starting point for feed rates, and may vary depending on material being cut and cutting speed (SFM).

## COATINGS FOR SAWS AND CUTTERS

Cutting tool surface coatings are available upon request. Tool coatings provide tool wear resistance while significantly improving the performance of saws in most applications, particularly when cutting ferrous materials. These coatings are extremely thin, harder than steel and greatly reduce friction and wear. The most common coatings available for carbide saws are:

**TiN: Titanium Nitride** - General purpose TiN hard coating. Best suited for iron-based materials, unalloyed and alloyed steels and hardened steels.

**TiCN: Titanium Carbonitride** - Enhanced hardness and wear resistance over TiN with better surface lubricity. Suited for difficult to machine materials such as cast iron, aluminum alloys, tool steels, copper, Inconel, titanium alloys and nonferrous materials.

**TiAlN: Titanium Aluminum Nitride** - Nano-layered coating, high toughness and oxidation resistance. Recommended for high temperature cutting, and a good choice when coating carbide. Suited for difficult materials like cast iron, aluminum alloys, tool steels and nickel alloys.

**AlCrN: Aluminum Chromium Nitride** - Expanded performance capabilities over titanium-based coatings. Highest oxidation resistance and hot hardness for high temperature wear resistance. Can be used in wet/dry cutting applications. Well suited for a wide range of materials - cast iron, unalloyed steels, high strength steels, high hardness steels.

### RECOMMENDED CUTTING CONDITIONS

12 - 124

DRILLING	Carbide Micro Drills	Inch	12
	Carbide Micro Drills	Metric	13
	Carbide Drills	Inch	14
	Carbide Drills	Metric	15
	Carbide Center Drills	Inch	16
	Carbide Center Drills	Metric	17
	*Carbide Step Drills	Inch	18
	*Carbide Step Drills	Metric	19
	Carbide Spotting Drills	Inch	110
	Carbide Spotting Drills	Metric	111
	*Carbide Chamfer Drills	Inch	112
	*Carbide Chamfer Drills	Metric	113
	Carbide Coolant Fed Micro Drills	Inch	114
	Carbide Coolant Fed Micro Drills	Metric	115
	Carbide High Performance Coolant Drills	Inch	116
	Carbide High Performance Coolant Drills	Metric	117
MILLING	Carbide Micro End Mills	Inch	118
	Carbide Micro End Mills	Metric	119
	Carbide Micro Mold End Mills	Inch	120
	Carbide Micro Mold End Mills	Metric	121
	Carbide End Mills	Inch	122
	Carbide End Mills	Metric	123
	Compression End Mills	Inch	124
	Compression End Mills	Metric	124
REAMING	Carbide Micro Reamers	Metric	125

### PRE-DRILL DIAMETERS FOR REAMERS

126

### COATING GUIDE

126

### VICKERS HARDNESS CONVERSION

127 - 129

### MATERIAL LIST & CROSS REFERENCE

130 - 139

### CUSTOM TOOL FORMS

140 - 153











\* *Specials*



# INCH











## INCH CARBIDE MICRO DRILLS

A	DRILLS
B	END MILLS
C	ROUTERS
D	THREAD MILLS & TAPS
E	ENGRAVERS
F	BORING BARS
G	REAMERS
H	SAWS
I	TECHNICAL
J	INDEX

Material	Property	Vc : SFM Uncoated	Vc : SFM AlTiN	Feed : (ipt)				
				Ø < 0.0394"	Ø < 0.0591"	Ø < 0.0787"	Ø < 0.0984"	Ø < 0.1181"
	<70 ksi	65 ~ 165	65 ~ 165	0.00138 ~ 0.00177	0.00157 ~ 0.00217	0.00197 ~ 0.00256	0.00236 ~ 0.00295	0.00256 ~ 0.00315
	<115 ksi	65 ~ 165	65 ~ 165	0.00118 ~ 0.00138	0.00138 ~ 0.00177	0.00157 ~ 0.00217	0.00197 ~ 0.00256	0.00217 ~ 0.00276
	<145 ksi	50 ~ 115	50 ~ 115	0.00079 ~ 0.00098	0.00098 ~ 0.00138	0.00118 ~ 0.00157	0.00138 ~ 0.00177	0.00157 ~ 0.00197
	<190 ksi	35 ~ 80	35 ~ 80	0.00098 ~ 0.00059	0.00039 ~ 0.00059	0.00059 ~ 0.00079	0.00059 ~ 0.00098	0.00079 ~ 0.00098
	55HRC	65 ~ 150	65 ~ 150	0.00059 ~ 0.00079	0.00079 ~ 0.00118	0.00098 ~ 0.00138	0.00118 ~ 0.00157	0.00138 ~ 0.00177
	Austenitic	50 ~ 130	50 ~ 130	0.00079 ~ 0.00098	0.00098 ~ 0.00138	0.00118 ~ 0.00157	0.00138 ~ 0.00177	0.00157 ~ 0.00197
	Martensitic	35 ~ 80	35 ~ 80	0.00098 ~ 0.00039	0.00020 ~ 0.00039	0.00039 ~ 0.00059	0.00039 ~ 0.00059	0.00059 ~ 0.00079
	-	15 ~ 35	15 ~ 35	0.00039 ~ 0.00059	0.00039 ~ 0.00059	0.00059 ~ 0.00079	0.00079 ~ 0.00098	0.00079 ~ 0.00098
	<130 ksi	15 ~ 35	15 ~ 35	0.00059 ~ 0.00059	0.00020 ~ 0.00039	0.00039 ~ 0.00059	0.00039 ~ 0.00059	0.00059 ~ 0.00079
	>130 ksi							
	<8HRC	80 ~ 215	80 ~ 215	0.00157 ~ 0.00197	0.00177 ~ 0.00256	0.00236 ~ 0.00295	0.00276 ~ 0.00354	0.00315 ~ 0.00374
	>8HRC	80 ~ 200	80 ~ 200	0.00157 ~ 0.00197	0.00177 ~ 0.00256	0.00236 ~ 0.00295	0.00276 ~ 0.00354	0.00315 ~ 0.00374
	Aluminum	165 ~ 500	165 ~ 500	0.00157 ~ 0.00197	0.00177 ~ 0.00256	0.00236 ~ 0.00295	0.00276 ~ 0.00354	0.00315 ~ 0.00374
	Silicon <6%	150 ~ 360	150 ~ 360	0.00157 ~ 0.00197	0.00177 ~ 0.00256	0.00236 ~ 0.00295	0.00276 ~ 0.00354	0.00315 ~ 0.00374
	Silicon >6%	150 ~ 360	150 ~ 360	0.00177 ~ 0.00236	0.00217 ~ 0.00295	0.00276 ~ 0.00354	0.00315 ~ 0.00394	0.00354 ~ 0.00472
	Brass	160 ~ 300	160 ~ 300	0.00118 ~ 0.00236	0.00236 ~ 0.00394	0.00394 ~ 0.00591	0.00591 ~ 0.00709	0.00709 ~ 0.00787
	-	265 ~ 395	265 ~ 395	0.00118 ~ 0.00236	0.00118 ~ 0.00236	0.00118 ~ 0.00236	0.00118 ~ 0.00236	0.00118 ~ 0.00236

# METRIC

## METRIC CARBIDE MICRO DRILLS













Material	Property	Vc : m/min Uncoated	Vc : m/min AlTiN	Feed : (mm/t)				
				Ø < 1.0	Ø < 1.5	Ø < 2.0	Ø < 2.5	Ø < 3.0
	<500 MPa	20 ~ 50	20 ~ 50	0.035 ~ 0.045	0.040 ~ 0.055	0.050 ~ 0.065	0.060 ~ 0.075	0.065 ~ 0.080
	<800 MPa	20 ~ 50	20 ~ 50	0.030 ~ 0.035	0.035 ~ 0.045	0.040 ~ 0.055	0.050 ~ 0.065	0.055 ~ 0.070
	<1,000 MPa	15 ~ 35	15 ~ 35	0.020 ~ 0.025	0.025 ~ 0.035	0.030 ~ 0.040	0.035 ~ 0.045	0.040 ~ 0.050
	<1,300 MPa	10 ~ 25	10 ~ 25	0.010 ~ 0.015	0.010 ~ 0.015	0.015 ~ 0.020	0.015 ~ 0.025	0.020 ~ 0.025
	55HRC	20 ~ 50	20 ~ 50	0.015 ~ 0.020	0.020 ~ 0.030	0.025 ~ 0.035	0.030 ~ 0.040	0.035 ~ 0.045
	Austenitic	15 ~ 40	15 ~ 40	0.020 ~ 0.025	0.025 ~ 0.035	0.030 ~ 0.040	0.035 ~ 0.045	0.040 ~ 0.050
	Martensitic	10 ~ 25	10 ~ 25	0.005 ~ 0.010	0.005 ~ 0.010	0.010 ~ 0.015	0.010 ~ 0.015	0.015 ~ 0.020
	-	5 ~ 10	5 ~ 10	0.010 ~ 0.015	0.010 ~ 0.015	0.015 ~ 0.020	0.020 ~ 0.025	0.020 ~ 0.025
	<900 MPa	5 ~ 10	5 ~ 10	0.005 ~ 0.010	0.005 ~ 0.010	0.010 0.015	0.010 ~ 0.015	0.015 ~ 0.020
	>900 MPa							
	<180 HB	25 ~ 65	25 ~ 65	0.040 ~ 0.050	0.045 ~ 0.065	0.060 ~ 0.075	0.070 ~ 0.090	0.080 ~ 0.095
	>180 HB	25 ~ 60	25 ~ 60	0.040 ~ 0.050	0.045 ~ 0.065	0.060 ~ 0.075	0.070 ~ 0.090	0.080 ~ 0.095
	Aluminum	50 ~ 150	50 ~ 150	0.040 ~ 0.050	0.045 ~ 0.065	0.060 ~ 0.075	0.070 ~ 0.090	0.080 ~ 0.095
	Silicon <6%	45 ~ 110	45 ~ 110	0.040 ~ 0.050	0.045 ~ 0.065	0.060 ~ 0.075	0.070 ~ 0.090	0.080 ~ 0.095
	Silicon >6%	45 ~ 110	45 ~ 110	0.045 ~ 0.060	0.055 ~ 0.075	0.070 ~ 0.090	0.080 ~ 0.100	0.090 ~ 0.120
	Brass	50 ~ 90	50 ~ 90	0.030 ~ 0.060	0.060 ~ 0.100	0.100 ~ 0.150	0.150 ~ 0.180	0.180 ~ 0.200
	-	80 ~ 120	80 ~ 120	0.030 ~ 0.060	0.030 ~ 0.060	0.030 0.060	0.030 ~ 0.060	0.030 ~ 0.060

- DRILLS **A**
- END MILLS **B**
- ROUTERS **C**
- THREAD MILLS & TAPS **D**
- ENGRAVERS **E**
- BORING BARS **F**
- REAMERS **G**
- SAWS **H**
- TECHNICAL **I**
- INDEX **J**

# INCH













## INCH CARBIDE DRILLS

<b>A</b>	DRILLS
<b>B</b>	END MILLS
<b>C</b>	ROUTERS
<b>D</b>	THREAD MILLS & TAPS
<b>E</b>	ENGRAVERS
<b>F</b>	BORING BARS
<b>G</b>	REAMERS
<b>H</b>	SAWS
<b>I</b>	TECHNICAL
<b>J</b>	INDEX

Material	Property	Vc : SFM Uncoated	Vc : SFM AlTiN	Feed : (ipt)				
				Ø0.0787"	Ø0.1575"	Ø0.3150"	Ø0.4724"	Ø0.6299"
	<70 ksi	330	330	0.00157	0.00236	0.00472	0.00669	0.00906
	<115 ksi	330	330	0.00157	0.00236	0.00472	0.00669	0.00906
	<145 ksi	260	260	0.00118	0.00157	0.00315	0.00512	0.00630
	<190 ksi	130	195	0.00079	0.00157	0.00276	0.00433	0.00630
	55HRC	20 ~ 35	25 ~ 40	0.00079	0.00118	0.00236	0.00276	0.00315
	68HRC	20 ~ 35	25 ~ 40	0.00079	0.00118	0.00236	0.00276	0.00315
	Ferritic	230	260	0.00118	0.00157	0.00315	0.00512	0.00630
	Martensitic	165	195	0.00118	0.00157	0.00315	0.00512	0.00630
	Austenitic	150	130	0.00118	0.00157	0.00315	0.00512	0.00630
	-	115	165	0.00079	0.00157	0.00276	0.00433	0.00630
	-	80	130	0.00079	0.00118	0.00236	0.00276	0.00315
	<130 ksi	115	165	0.00118	0.00157	0.00315	0.00512	0.00630
	>130 ksi	80	130	0.00157	0.00236	0.00472	0.00669	0.00906
	<8HRC	230	260	0.00236	0.00354	0.00787	0.00984	0.01378
	>8HRC	195	165	0.00197	0.00315	0.00472	0.00945	0.01102
	Silicon <10%	490	490	0.00197	0.00315	0.00472	0.00945	0.01102
	Silicon >10%	260	260	0.00197	0.00315	0.00472	0.00945	0.01102
	-	330	330	0.00236	0.00354	0.00787	0.00984	0.01378
	thermoplastic	330	330 ~ 655	0.00079	0.00157	0.00276	0.00433	0.00630
	thermoset	330	330 ~ 655	0.00079	0.00157	0.00276	0.00433	0.00630
	-	330	330 ~ 490	0.00079	0.00157	0.00276	0.00433	0.00630

# METRIC

## METRIC CARBIDE DRILLS









Material	Property	Vc : m/min Uncoated	Vc : m/min AlTiN	Feed : (mm/t)				
				Ø2	Ø4	Ø8	Ø12	Ø16
	<500 MPa	100	100	0.04	0.06	0.12	0.17	0.23
	<800 MPa	100	100	0.04	0.06	0.12	0.17	0.23
	<1,000 MPa	80	80	0.03	0.04	0.08	0.13	0.16
	<1,300 MPa	40	60	0.02	0.04	0.07	0.11	0.16
	55HRC	6 ~ 10	8 ~ 12	0.02	0.03	0.06	0.07	0.08
	68HRC	6 ~ 10	8 ~ 12	0.02	0.03	0.06	0.07	0.08
	Ferritic	70	80	0.03	0.04	0.08	0.13	0.16
	Martensitic	50	60	0.03	0.04	0.08	0.13	0.16
	Austenitic	45	40	0.03	0.04	0.08	0.13	0.16
	-	35	50	0.02	0.04	0.07	0.11	0.16
	-	25	40	0.02	0.03	0.06	0.07	0.08
	<900 MPa	35	50	0.03	0.04	0.08	0.13	0.16
	>900 MPa	25	40	0.04	0.06	0.12	0.17	0.23
	<180 HB	70	80	0.06	0.09	0.20	0.25	0.35
	>180 HB	60	50	0.05	0.08	0.12	0.24	0.28
	Silicon <10%	150	150	0.05	0.08	0.12	0.24	0.28
	Silicon >10%	80	80	0.05	0.08	0.12	0.24	0.28
	-	100	100	0.06	0.09	0.20	0.25	0.35
	thermoplastic	100	100 ~ 200	0.02	0.04	0.07	0.11	0.16
	thermoset	100	100 ~ 200	0.02	0.04	0.07	0.11	0.16
	-	100	100 ~ 150	0.02	0.04	0.07	0.11	0.16

DRILLS	<b>A</b>
END MILLS	<b>B</b>
ROUTERS	<b>C</b>
THREAD MILLS & TAPS	<b>D</b>
ENGRAVERS	<b>E</b>
BORING BARS	<b>F</b>
REAMERS	<b>G</b>
SAWS	<b>H</b>
TECHNICAL	<b>I</b>
INDEX	<b>J</b>

# INCH









## INCH CARBIDE CENTER DRILLS

<b>A</b>	DRILLS
<b>B</b>	END MILLS
<b>C</b>	ROUTERS
<b>D</b>	THREAD MILLS & TAPS
<b>E</b>	ENGRAVERS
<b>F</b>	BORING BARS
<b>G</b>	REAMERS
<b>H</b>	SAWS
<b>I</b>	TECHNICAL
<b>J</b>	INDEX

Material	Property	Vc : SFM Uncoated	Vc : SFM AlTiN	Feed : (ipt)				
				Ø < 0.0787"	Ø < 0.1181"	Ø < 0.2362"	Ø < 0.3937"	Ø < 0.6299"
	<70 ksi	230 ~ 260	260 ~ 295	0.0039	0.0047	0.0087	0.0130	0.0177
	<115 ksi	195 ~ 245	230 ~ 295	0.0039	0.0047	0.0087	0.0130	0.0177
	<145 ksi	165 ~ 195	195 ~ 230	0.0028	0.0031	0.0059	0.0091	0.0122
	<190 ksi	80 ~ 130	100 ~ 165	0.0024	0.0028	0.0051	0.0079	0.0106
	-	65 ~ 100	100 ~ 130	0.0024	0.0031	0.0059	0.0079	0.0118
	-	65 ~ 80	100 ~ 130	0.0197	0.0276	0.0051	0.0071	0.0106
	<130 ksi	65 ~ 100	100 ~ 130	0.0024	0.0031	0.0059	0.0079	0.0118
	>130 ksi							
	<8HRC	165 ~ 195	195 ~ 230	0.0039	0.0047	0.0087	0.0130	0.0177
	>8HRC	115 ~ 165	130 ~ 195	0.0031	0.0039	0.0067	0.0118	0.0157
	Silicon <10%	330 ~ 490	330 ~ 495	0.0047	0.0059	0.0079	0.0098	0.0157
	Silicon >10%	230 ~ 295	230 ~ 295	0.0047	0.0059	0.0079	0.0098	0.0157
	-	230 ~ 295	230 ~ 295	0.0047	0.0059	0.0079	0.0098	0.0157
	-	490 ~ 655	490 ~ 655	0.0051	0.0059	0.0098	0.0157	0.0197

# METRIC

## METRIC CARBIDE CENTER DRILLS









Material	Property	Vc : m/min Uncoated	Vc : m/min AlTiN	Feed : (mm/t)				
				Ø2	Ø3	Ø6	Ø10	Ø16
	<500 MPa	70 ~ 80	80 ~ 90	0.10	0.12	0.22	0.33	0.45
	<800 MPa	60 ~ 75	70 ~ 90	0.10	0.12	0.22	0.33	0.45
	<1,000 MPa	50 ~ 60	60 ~ 70	0.07	0.08	0.15	0.23	0.31
	<1,300 MPa	25 ~ 40	30 ~ 50	0.06	0.07	0.13	0.20	0.27
	-	20 ~ 30	30 ~ 40	0.06	0.08	0.15	0.20	0.30
	-	20 ~ 25	30 ~ 40	0.50	0.70	0.13	0.18	0.27
	<900 MPa	20 ~ 30	30 ~ 40	0.06	0.08	0.15	0.20	0.30
	>900 MPa							
	<180 HB	50 ~ 60	60 ~ 70	0.10	0.12	0.22	0.33	0.45
	>180 HB	35 ~ 50	40 ~ 60	0.08	0.10	0.17	0.30	0.40
	Silicon <10%	100 ~ 150	100 ~ 150	0.12	0.15	0.20	0.25	0.40
	Silicon >10%	70 ~ 90	70 ~ 90	0.12	0.15	0.20	0.25	0.40
	-	70 ~ 90	70 ~ 90	0.12	0.15	0.20	0.25	0.40
	-	150 ~ 200	150 ~ 200	0.13	0.15	0.25	0.40	0.50

- DRILLS **A**
- END MILLS **B**
- ROUTERS **C**
- THREAD MILLS & TAPS **D**
- ENGRAVERS **E**
- BORING BARS **F**
- REAMERS **G**
- SAWS **H**
- TECHNICAL **I**
- INDEX **J**

## INCH

(Specials)

### INCH CARBIDE STEP DRILLS

Material	Property	Vc : SFM AITiN	Feed : (ipt)							
			Ø0.1181"	Ø0.1575"	Ø0.1969"	Ø0.2362"	Ø0.3150"	Ø0.3937"	Ø0.4724"	Ø0.6299"
	<115 ksi	195 ~ 395	0.0028	0.0035	0.0047	0.0055	0.0079	0.0094	0.0114	0.0138
	<145 ksi	130 ~ 260	0.0020	0.0024	0.0031	0.0035	0.0047	0.0055	0.0067	0.0091
	<190 ksi	65 ~ 130	0.0016	0.0016	0.0020	0.0024	0.0028	0.0035	0.0043	0.0063
	-	130 ~ 230	0.0016	0.0020	0.0024	0.0028	0.0035	0.0043	0.0051	0.0071
	-	50 ~ 100	0.0016	0.0020	0.0024	0.0028	0.0035	0.0043	0.0051	0.0071
	<130 ksi	50 ~ 100	0.0020	0.0024	0.0031	0.0035	0.0047	0.0055	0.0067	0.0091
	>130 ksi									
	<8HRC	130 ~ 330	0.0028	0.0035	0.0047	0.0055	0.0079	0.0094	0.0114	0.0138
	>8HRC	130 ~ 260	0.0024	0.0035	0.0043	0.0051	0.0063	0.0083	0.0094	0.0110
	-	395 ~ 490	0.0024	0.0035	0.0043	0.0051	0.0063	0.0083	0.0094	0.0110
	Bronze	195 ~ 330	0.0028	0.0035	0.0047	0.0055	0.0079	0.0094	0.0114	0.0138
	Brass	130 ~ 260	0.0020	0.0024	0.0031	0.0035	0.0047	0.0055	0.0067	0.0091

- A DRILLS
- B END MILLS
- C ROUTERS
- D THREAD MILLS & TAPS
- E ENGRAVERS
- F BORING BARS
- G REAMERS
- H SAWS
- I TECHNICAL
- J INDEX

# METRIC

(Specials)

## METRIC CARBIDE STEP DRILLS

Material	Property	Vc : m/min AlTiN	Feed : (mm/t)							
			Ø3	Ø4	Ø5	Ø6	Ø8	Ø10	Ø12	Ø16
	<800 MPa	60 ~ 120	0.07	0.09	0.12	0.14	0.20	0.24	0.29	0.35
	<1,000 MPa	40 ~ 80	0.05	0.06	0.08	0.09	0.12	0.14	0.17	0.23
	<1,300 MPa	20 ~ 40	0.04	0.04	0.05	0.06	0.07	0.09	0.11	0.16
	-	40 ~ 70	0.04	0.05	0.06	0.07	0.09	0.11	0.13	0.18
	-	15 ~ 30	0.04	0.05	0.06	0.07	0.09	0.11	0.13	0.18
	<900 MPa	15 ~ 30	0.05	0.06	0.08	0.09	0.12	0.14	0.17	0.23
	>900 MPa									
	<180 HB	40 ~ 100	0.07	0.09	0.12	0.14	0.20	0.24	0.29	0.35
	>180 HB	40 ~ 80	0.06	0.09	0.11	0.13	0.16	0.21	0.24	0.28
	-	120 ~ 150	0.06	0.09	0.11	0.13	0.16	0.21	0.24	0.28
	Bronze	60 ~ 100	0.07	0.09	0.12	0.14	0.20	0.24	0.29	0.35
	Brass	40 ~ 80	0.05	0.06	0.08	0.09	0.12	0.14	0.17	0.23









- DRILLS **A**
- END MILLS **B**
- ROUTERS **C**
- THREAD MILLS & TAPS **D**
- ENGRAVERS **E**
- BORING BARS **F**
- REAMERS **G**
- SAWS **H**
- TECHNICAL **I**
- INDEX **J**



# INCH









## INCH CARBIDE SPOTTING DRILLS

- A DRILLS
- B END MILLS
- C ROUTERS
- D THREAD MILLS & TAPS
- E ENGRAVERS
- F BORING BARS
- G REAMERS
- H SAWS
- I TECHNICAL
- J INDEX

Material	Property	Vc : SFM Uncoated	Vc : SFM AlTiN	Feed : (ipt)				
				Ø0.0787"	Ø0.1181"	Ø0.2362"	Ø0.3937"	Ø0.6299"
	>70 ksi	260 ~ 330	330 ~ 395	0.0039	0.0047	0.0087	0.0130	0.0177
	<115 ksi	195 ~ 295	260 ~ 360	0.0039	0.0047	0.0087	0.0130	0.0177
	<145 ksi	180 ~ 245	195 ~ 260	0.0028	0.0031	0.0059	0.0091	0.0122
	<190 ksi	100 ~ 165	130 ~ 195	0.0024	0.0028	0.0051	0.0079	0.0106
	-	80 ~ 165	100 ~ 195	0.0024	0.0031	0.0059	0.0079	0.0118
	-	80 ~ 115	100 ~ 130	0.0197	0.0276	0.0051	0.0071	0.0106
	<130 ksi	115	100 ~ 130	0.0024	0.0024	0.0059	0.0079	0.0118
	>130 ksi							
	<8HRC	260 ~ 330	260 ~ 295	0.0039	0.0047	0.0087	0.0130	0.0177
	>8HRC	195 ~ 295	230 ~ 295	0.0031	0.0039	0.0067	0.0118	0.0157
	-	330 ~ 590	490 ~ 655	0.0047	0.0059	0.0079	0.0098	0.0157
	-	295 ~ 395	360 ~ 460	0.0047	0.0059	0.0079	0.0098	0.0157
	-	330 ~ 590	490 ~ 655	0.0047	0.0059	0.0079	0.0098	0.0157

# METRIC

## METRIC CARBIDE SPOTTING DRILLS

Material	Property	Vc : m/min Uncoated	Vc : m/min AlTiN	Feed : (mm/t)				
				Ø2	Ø3	Ø6	Ø10	Ø16
	>500 MPa	80 ~ 100	100 ~ 120	0.10	0.12	0.22	0.33	0.45
	<800 MPa	60 ~ 90	80 ~ 110	0.10	0.12	0.22	0.33	0.45
	<1,000 MPa	55 ~ 75	60 ~ 80	0.07	0.08	0.15	0.23	0.31
	<1,300 MPa	30 ~ 50	40 ~ 60	0.06	0.07	0.13	0.20	0.27
	-	25 ~ 50	30 ~ 60	0.06	0.08	0.15	0.20	0.30
	-	25 ~ 35	30 ~ 40	0.50	0.70	0.13	0.18	0.27
	<900 MPa	35 ~ 35	30 ~ 40	0.06	0.06	0.15	0.20	0.30
	>900 MPa							
	<180 HB	80 ~ 100	80 ~ 90	0.10	0.12	0.22	0.33	0.45
	>180 HB	60 ~ 90	70 ~ 90	0.08	0.10	0.17	0.30	0.40
	-	100 ~ 180	150 ~ 200	0.12	0.15	0.20	0.25	0.40
	-	90 ~ 120	110 ~ 140	0.12	0.15	0.20	0.25	0.40
	-	100 ~ 180	150 ~ 200	0.12	0.15	0.20	0.25	0.40











- DRILLS **A**
- END MILLS **B**
- ROUTERS **C**
- THREAD MILLS & TAPS **D**
- ENGRAVERS **E**
- BORING BARS **F**
- REAMERS **G**
- SAWS **H**
- TECHNICAL **I**
- INDEX **J**

# INCH

(Specials)

## INCH CARBIDE CHAMFERING DRILLS











<b>A</b>	DRILLS
<b>B</b>	END MILLS
<b>C</b>	ROUTERS
<b>D</b>	THREAD MILLS & TAPS
<b>E</b>	ENGRAVERS
<b>F</b>	BORING BARS
<b>G</b>	REAMERS
<b>H</b>	SAWS
<b>I</b>	TECHNICAL
<b>J</b>	INDEX

Material	Property	Vc : SFM Uncoated	Vc : SFM AlTiN	Feed : (ipt)							
				Ø0.0787"	Ø0.1575"	Ø0.2362"	Ø0.3150"	Ø0.3937"	Ø0.4724"	Ø0.6299"	Ø0.7874"
	<70 ksi	230	245	0.00098	0.00197	0.00315	0.00551	0.00551	0.00748	0.00945	0.01102
	<115 ksi	130	195	0.00098	0.00197	0.00315	0.00551	0.00551	0.00748	0.00945	0.01102
	<145 ksi	115	130	0.00091	0.00177	0.00276	0.00472	0.00472	0.00709	0.00866	0.01102
	<190 ksi	100	115	0.00091	0.00177	0.00276	0.00472	0.00669	0.00669	0.00866	0.01024
	55HRC	80	100	0.00079	0.00157	0.00236	0.00433	0.00433	0.00630	0.00866	0.00984
	68HRC	80	100	0.00079	0.00157	0.00236	0.00433	0.00433	0.00630	0.00866	0.00984
	Ferritic	80	100	0.00091	0.00177	0.00276	0.00472	0.00669	0.00669	0.00866	0.01024
	Austenitic	80	100	0.00079	0.00157	0.00236	0.00433	0.00433	0.00630	0.00866	0.00984
	-	65	80	0.00079	0.00157	0.00236	0.00433	0.00433	0.00630	0.00866	0.00984
	<130 ksi	80	100	0.00079	0.00157	0.00236	0.00433	0.00433	0.00630	0.00866	0.00984
	>130 ksi										
	<8HRC	115	130	0.00091	0.00177	0.00276	0.00472	0.00472	0.00709	0.00866	0.01102
	>8HRC	100	115								
	-	490	655	0.00098	0.00197	0.00354	0.00591	0.00787	0.00787	0.01063	0.01378
	-	260	395	0.00197	0.00394	0.00591	0.00984	0.01181	0.01181	0.01378	0.01772
	-	490	-	0.00098	0.00197	0.00354	0.00591	0.00787	0.00787	0.01063	0.01378

# METRIC

(Specials)

## METRIC CARBIDE CHAMFERING DRILLS







Material	Property	Vc : m/min Uncoated	Vc : m/min AlTiN	Feed : (mm/t)							
				Ø2	Ø4	Ø6	Ø8	Ø10	Ø12	Ø16	Ø20
	<500 MPa	70	75	0.025	0.050	0.080	0.140	0.140	0.190	0.240	0.280
	<800 MPa	40	60	0.025	0.050	0.080	0.140	0.140	0.190	0.240	0.280
	<1,000 MPa	35	40	0.023	0.045	0.070	0.120	0.120	0.180	0.220	0.280
	<1,300 MPa	30	35	0.023	0.045	0.070	0.120	0.170	0.170	0.220	0.260
	55HRC	25	30	0.020	0.040	0.060	0.110	0.110	0.160	0.220	0.250
	68HRC	25	30	0.020	0.040	0.060	0.110	0.110	0.160	0.220	0.250
	Ferritic	25	30	0.023	0.045	0.070	0.120	0.170	0.170	0.220	0.260
	Austenitic	25	30	0.020	0.040	0.060	0.110	0.110	0.160	0.220	0.250
	-	20	25	0.020	0.040	0.060	0.110	0.110	0.160	0.220	0.250
	<900 MPa	25	30	0.020	0.040	0.060	0.110	0.110	0.160	0.220	0.250
	>900 MPa										
	<180 HB	35	40	0.023	0.045	0.070	0.120	0.120	0.180	0.220	0.280
	>180 HB	30	35								
	-	150	200	0.025	0.050	0.090	0.150	0.200	0.200	0.270	0.350
	-	80	120	0.050	0.100	0.150	0.250	0.300	0.300	0.350	0.450
	-	150	-	0.025	0.050	0.090	0.150	0.200	0.200	0.270	0.350

DRILLS	<b>A</b>
END MILLS	<b>B</b>
ROUTERS	<b>C</b>
THREAD MILLS & TAPS	<b>D</b>
ENGRAVERS	<b>E</b>
BORING BARS	<b>F</b>
REAMERS	<b>G</b>
SAWS	<b>H</b>
TECHNICAL	<b>I</b>
INDEX	<b>J</b>

# INCH







## INCH CARBIDE COOLANT MICRO DRILLS

<b>A</b>	DRILLS
<b>B</b>	END MILLS
<b>C</b>	ROUTERS
<b>D</b>	THREAD MILLS & TAPS
<b>E</b>	ENGRAVERS
<b>F</b>	BORING BARS
<b>G</b>	REAMERS
<b>H</b>	SAWS
<b>I</b>	TECHNICAL
<b>J</b>	INDEX

Material	Property	Vc : SFM Uncoated	Vc : SFM AlTiN	Feed : (ipt)				
				Ø < 0.0394"	Ø < 0.0591"	Ø < 0.0787"	Ø < 0.0984"	Ø < 0.1181"
	<70 ksi	65 ~ 165	80 ~ 260	0.0008 ~ 0.0016	0.0008 ~ 0.0016	0.0012 ~ 0.0024	0.0016 ~ 0.0031	0.0016 ~ 0.0031
	<115 ksi							
	<145 ksi	50 ~ 115	80 ~ 260	0.0008 ~ 0.0016	0.0008 ~ 0.0016	0.0012 ~ 0.0024	0.0016 ~ 0.0031	0.0016 ~ 0.0031
	<190 ksi							
	-	50 ~ 130	50 ~ 115	0.0004 ~ 0.0008	0.0004 ~ 0.0008	0.0008 ~ 0.0016	0.0012 ~ 0.0024	0.0012 ~ 0.0024
		35 ~ 80						
	<130 ksi	15 ~ 35	50 ~ 115	0.0004 ~ 0.0008	0.0004 ~ 0.0008	0.0008 ~ 0.0016	0.0012 ~ 0.0024	0.0012 ~ 0.0024
	>130 ksi							
	<8HRC	80 ~ 215	100 ~ 295	0.0008 ~ 0.0039	0.0008 ~ 0.0039	0.0012 ~ 0.0024	0.0016 ~ 0.0035	0.0016 ~ 0.0035
	>8HRC	80 ~ 195						
	Aluminum	165 ~ 490	80 ~ 260	0.0039 ~ 0.0059	0.0039 ~ 0.0059	0.0059 ~ 0.0098	0.0079 ~ 0.0118	0.0079 ~ 0.0118
	Silicon <12%	150 ~ 360						
	Silicon >12%	150 ~ 360						

# METRIC

## METRIC CARBIDE COOLANT MICRO DRILLS





Material	Property	Vc : m/min Uncoated	Vc : m/min AlTiN	Feed : (mm/t)				
				Ø < 1.0	Ø < 1.5	Ø < 2.0	Ø < 2.5	Ø < 3.0
	<500 MPa	20 ~ 50	25 ~ 80	0.02 ~ 0.04	0.02 ~ 0.04	0.03 ~ 0.06	0.04 ~ 0.08	0.04 ~ 0.08
	<800 MPa							
	<1,000 MPa	15 ~ 35	25 ~ 80	0.02 ~ 0.04	0.02 ~ 0.04	0.03 ~ 0.06	0.04 ~ 0.08	0.04 ~ 0.08
	<1,300 MPa	10 ~ 25	20 ~ 45	0.02 ~ 0.04	0.02 ~ 0.04	0.03 ~ 0.05	0.04 ~ 0.06	0.04 ~ 0.06
	-	15 ~ 40	15 ~ 35	0.01 ~ 0.02	0.01 ~ 0.02	0.02 ~ 0.04	0.03 ~ 0.06	0.03 ~ 0.06
	-	10 ~ 25						
	<900 MPa	5 ~ 10	15 ~ 35	0.01 ~ 0.02	0.01 ~ 0.02	0.02 ~ 0.04	0.03 ~ 0.06	0.03 ~ 0.06
	>900 MPa							
	<180 HB	25 ~ 65	30 ~ 90	0.02 ~ 0.05	0.02 ~ 0.05	0.03 ~ 0.06	0.04 ~ 0.09	0.04 ~ 0.09
	>180 HB	25 ~ 60	25 ~ 80	0.10 ~ 0.20	0.10 ~ 0.20	0.15 ~ 0.25	0.20 ~ 0.30	0.02 ~ 0.30
	Aluminum	50 ~ 150	50 ~ 200	0.03 ~ 0.06	0.03 ~ 0.06	0.04 ~ 0.07	0.07 ~ 0.12	0.07 ~ 0.12
	Silicon <12%	45 ~ 110						
	Silicon >12%	45 ~ 110						

- DRILLS **A**
- END MILLS **B**
- ROUTERS **C**
- THREAD MILLS & TAPS **D**
- ENGRAVERS **E**
- BORING BARS **F**
- REAMERS **G**
- SAWS **H**
- TECHNICAL **I**
- INDEX **J**

# INCH







## INCH CARBIDE HIGH PERFORMANCE COOLANT MICRO DRILLS

- A DRILLS
- B END MILLS
- C ROUTERS
- D THREAD MILLS & TAPS
- E ENGRAVERS
- F BORING BARS
- G REAMERS
- H SAWS
- I TECHNICAL
- J INDEX

Material	Property	Vc : SFM AITiN	Feed : (ipt)				
			Ø0.1575"	Ø0.03150"	Ø0.4724"	Ø0.6299"	Ø0.7874"
	<70 ksi	360	0.0047	0.0059	0.0110	0.0134	0.0161
	<115 ksi	330	0.0071	0.0098	0.0138	0.0150	0.0161
	<145 ksi	260	0.0063	0.0087	0.0122	0.0134	0.0146
	<190 ksi	215	0.0063	0.0087	0.0122	0.0134	0.0146
	-	200	0.0039	0.0051	0.0075	0.0087	0.0098
	-	80	0.0039	0.0051	0.0075	0.0087	0.0098
	<130 ksi	100	0.0031	0.0043	0.0063	0.0071	0.0079
	>130 ksi						
	<8HRC	295	0.0071	0.0087	0.0138	0.0150	0.0161
	>8HRC	260	0.0063	0.0098	0.0122	0.0134	0.0146

# METRIC

## METRIC CARBIDE HIGH PERFORMANCE COOLANT MICRO DRILLS

Material	Property	Vc : m/min AITiN	Feed : (mm/t)				
			Ø4	Ø8	Ø12	Ø16	Ø20
	<500 MPa	110	0.12	0.15	0.28	0.34	0.41
	<800 MPa	100	0.18	0.25	0.35	0.38	0.41
	<1,000 MPa	80	0.16	0.22	0.31	0.34	0.37
	<1,300 MPa	65	0.16	0.22	0.31	0.34	0.37
	-	40	0.10	0.13	0.19	0.22	0.25
	-	25	0.10	0.13	0.19	0.22	0.25
	<900 MPa	30	0.08	0.11	0.16	0.18	0.20
	>900 MPa						
	<180 HB	90	0.18	0.22	0.35	0.38	0.41
	>180 HB	80	0.16	0.25	0.31	0.34	0.37

- DRILLS **A**
- END MILLS **B**
- ROUTERS **C**
- THREAD MILLS & TAPS **D**
- ENGRAVERS **E**
- BORING BARS **F**
- REAMERS **G**
- SAWS **H**
- TECHNICAL **I**
- INDEX **J**



# INCH









## INCH CARBIDE MICRO END MILLS

<b>A</b>	DRILLS
<b>B</b>	END MILLS
<b>C</b>	ROUTERS
<b>D</b>	THREAD MILLS & TAPS
<b>E</b>	ENGRAVERS
<b>F</b>	BORING BARS
<b>G</b>	REAMERS
<b>H</b>	SAWS
<b>I</b>	TECHNICAL
<b>J</b>	INDEX

Material	Property	Vc : SFM Uncoated	Vc : SFM AITiN	Feed : (ipt)							
				Ø0.0079"	Ø0.0197"	Ø0.0315"	Ø0.0394"	Ø0.0591"	Ø0.0787"	Ø0.1181"	
	<70 ksi	195	260	Slotting ap = 0.0394" ae = 0.0394"	0.00004	0.00004	0.00008	0.00008	0.00012	0.00016	0.00024
				Finishing ap = 0.0394" ae = 0.0118"	0.00001	0.00001	0.00002	0.00002	0.00003	0.00004	0.00004
	<115 ksi	195	260	Slotting ap = 0.0394" ae = 0.0394"	0.00004	0.00004	0.00008	0.00008	0.00012	0.00016	0.00024
				Finishing ap = 0.0394" ae = 0.0118"	0.00001	0.00001	0.00002	0.00002	0.00003	0.00004	0.00004
	<145 ksi	195	260	Slotting ap = 0.0394" ae = 0.0394"	0.00004	0.00004	0.00008	0.00008	0.00012	0.00016	0.00024
				Finishing ap = 0.0394" ae = 0.0118"	0.00001	0.00001	0.00002	0.00002	0.00003	0.00004	0.00004
	-	80	150	Slotting ap = 0.0394" ae = 0.0394"	0.00004	0.00004	0.00008	0.00008	0.00012	0.00016	0.00024
				Finishing ap = 0.0394" ae = 0.0118"	0.00001	0.00001	0.00002	0.00002	0.00003	0.00004	0.00004
	-	-	80	Slotting ap = 0.0394" ae = 0.0394"	0.00004	0.00004	0.00008	0.00008	0.00012	0.00016	0.00024
				Finishing ap = 0.0394" ae = 0.0118"	0.00001	0.00001	0.00002	0.00002	0.00003	0.00004	0.00004
	-	-	80	Slotting ap = 0.0394" ae = 0.0394"	0.00004	0.00004	0.00008	0.00008	0.00012	0.00016	0.00024
				Finishing ap = 0.0394" ae = 0.0118"	0.00001	0.00001	0.00002	0.00002	0.00003	0.00004	0.00004
	-	195	260	Slotting ap = 0.0394" ae = 0.0394"	0.00004	0.00004	0.00008	0.00008	0.00012	0.00016	0.00024
				Finishing ap = 0.0394" ae = 0.0118"	0.00001	0.00001	0.00002	0.00002	0.00003	0.00004	0.00004
	-	490	-	Slotting ap = 0.0394" ae = 0.0394"	0.00008	0.00020	0.00035	0.00047	0.00071	0.00094	0.00142
				Finishing ap = 0.0394" ae = 0.0118"	0.00001	0.00004	0.00004	0.00004	0.00008	0.00008	0.00016
	-	260	-	Slotting ap = 0.0394" ae = 0.0394"	0.00008	0.00024	0.00031	0.00047	0.00071	0.00094	0.00142
				Finishing ap = 0.0394" ae = 0.0118"	0.00001	0.00004	0.00004	0.00004	0.00008	0.00008	0.00016
	-	260	-	Slotting ap = 0.0394" ae = 0.0394"	0.00008	0.00020	0.00031	0.00039	0.00059	0.00079	0.00118
				Finishing ap = 0.0394" ae = 0.0118"	0.00001	0.00004	0.00004	0.00004	0.00008	0.00008	0.00012

# METRIC

## METRIC CARBIDE MICRO END MILLS











Material	Property	Vc : m/min Uncoated	Vc : m/min AlTiN	Feed : (mm/t)							
				Ø0.2	Ø0.5	Ø0.8	Ø1.0	Ø1.5	Ø2.0	Ø3.0	
	<500 MPa	60	80	Slotting ap = 1.0 ae = 1.0	0.001	0.001	0.002	0.002	0.003	0.004	0.006
				Finishing ap = 1.0 ae = 0.3	0.001	0.001	0.001	0.001	0.001	0.001	0.001
	<800 MPa	60	80	Slotting ap = 1.0 ae = 1.0	0.001	0.001	0.002	0.002	0.003	0.004	0.006
				Finishing ap = 1.0 ae = 0.3	0.001	0.001	0.001	0.001	0.001	0.001	0.001
	<1,000 MPa	60	80	Slotting ap = 1.0 ae = 1.0	0.001	0.001	0.002	0.002	0.003	0.004	0.006
				Finishing ap = 1.0 ae = 0.3	0.001	0.001	0.001	0.001	0.001	0.001	0.001
	<1,300 MPa	40	60	Slotting ap = 1.0 ae = 1.0	0.001	0.001	0.002	0.002	0.003	0.004	0.006
				Finishing ap = 1.0 ae = 0.3	0.001	0.001	0.001	0.001	0.001	0.001	0.001
	-	25	45	Slotting ap = 1.0 ae = 1.0	0.001	0.001	0.002	0.002	0.003	0.004	0.006
				Finishing ap = 1.0 ae = 0.3	0.001	0.001	0.001	0.001	0.001	0.001	0.001
	-	-	25	Slotting ap = 1.0 ae = 1.0	0.001	0.001	0.002	0.002	0.003	0.004	0.006
				Finishing ap = 1.0 ae = 0.3	0.001	0.001	0.001	0.001	0.001	0.001	0.001
	-	-	25	Slotting ap = 1.0 ae = 1.0	0.001	0.001	0.002	0.002	0.003	0.004	0.006
				Finishing ap = 1.0 ae = 0.3	0.001	0.001	0.001	0.001	0.001	0.001	0.001
	-	60	80	Slotting ap = 1.0 ae = 1.0	0.001	0.001	0.002	0.002	0.003	0.004	0.006
				Finishing ap = 1.0 ae = 0.3	0.001	0.001	0.001	0.001	0.001	0.001	0.001
	-	150	-	Slotting ap = 1.0 ae = 1.0	0.002	0.005	0.009	0.012	0.018	0.024	0.036
				Finishing ap = 1.0 ae = 0.3	0.001	0.001	0.001	0.001	0.002	0.002	0.004
	-	80	-	Slotting ap = 1.0 ae = 1.0	0.002	0.006	0.008	0.012	0.018	0.024	0.036
				Finishing ap = 1.0 ae = 0.3	0.001	0.001	0.001	0.001	0.002	0.002	0.004
	-	80	-	Slotting ap = 1.0 ae = 1.0	0.002	0.005	0.008	0.010	0.015	0.020	0.030
				Finishing ap = 1.0 ae = 0.3	0.001	0.001	0.001	0.001	0.002	0.002	0.003

- DRILLS **A**
- END MILLS **B**
- ROUTERS **C**
- THREAD MILLS & TAPS **D**
- ENGRAVERS **E**
- BORING BARS **F**
- REAMERS **G**
- SAWS **H**
- TECHNICAL **I**
- INDEX **J**

# INCH

## INCH CARBIDE MICRO MOLD END MILLS











- A DRILLS
- B END MILLS
- C ROUTERS
- D THREAD MILLS & TAPS
- E ENGRAVERS
- F BORING BARS
- G REAMERS
- H SAWS
- I TECHNICAL
- J INDEX

Material	Property	Vc : SFM AITiN	Feed : (ipt)							
			Ø0.0079"	Ø0.0197"	Ø0.0315"	Ø0.0394"	Ø0.0591"	Ø0.0787"	Ø0.1181"	
	<70 ksi	655	High Speed ap = 0.0040" x Ø ae = 0.0394" x Ø	0.00008	0.00008	0.00016	0.00020	0.00020	0.00024	0.00028
			Copy Milling	0.00004	0.00008	0.00012	0.00016	0.00016	0.00020	0.00024
	<115 ksi	655	High Speed ap = 0.0040" x Ø ae = 0.0394" x Ø	0.00008	0.00008	0.00016	0.00020	0.00020	0.00024	0.00028
			Copy Milling	0.00004	0.00008	0.00012	0.00016	0.00016	0.00020	0.00024
	<145 ksi	655	High Speed ap = 0.0040" x Ø ae = 0.0394" x Ø	0.00008	0.00008	0.00016	0.00020	0.00020	0.00024	0.00028
			Copy Milling	0.00004	0.00008	0.00012	0.00016	0.00016	0.00020	0.00024
	<190 ksi	395	High Speed ap = 0.0040" x Ø ae = 0.0394" x Ø	0.00008	0.00008	0.00016	0.00020	0.00020	0.00024	0.00028
			Copy Milling	0.00004	0.00008	0.00012	0.00016	0.00016	0.00020	0.00024
	< 55HRC	260	High Speed ap = 0.0040" x Ø ae = 0.0394" x Ø	0.00008	0.00008	0.00016	0.00020	0.00020	0.00024	0.00028
	< 68HRC	195	High Speed ap = 0.0040" x Ø ae = 0.0394" x Ø	0.00008	0.00008	0.00016	0.00020	0.00020	0.00024	0.00028
	-	330	High Speed ap = 0.0040" x Ø ae = 0.0394" x Ø	0.00008	0.00008	0.00016	0.00020	0.00020	0.00024	0.00028
			Copy Milling	0.00004	0.00008	0.00012	0.00016	0.00016	0.00020	0.00024
	-	260	High Speed ap = 0.0040" x Ø ae = 0.0394" x Ø	0.00008	0.00008	0.00016	0.00020	0.00020	0.00024	0.00028
			Copy Milling	0.00004	0.00008	0.00012	0.00016	0.00016	0.00020	0.00024
	-	260	High Speed ap = 0.0040" x Ø ae = 0.0394" x Ø	0.00008	0.00008	0.00016	0.00020	0.00020	0.00024	0.00028
			Copy Milling	0.00004	0.00008	0.00012	0.00016	0.00016	0.00020	0.00024
	-	655	High Speed ap = 0.0040" x Ø ae = 0.0394" x Ø	0.00008	0.00008	0.00016	0.00020	0.00020	0.00024	0.00028
			Copy Milling	0.00004	0.00008	0.00012	0.00016	0.00016	0.00020	0.00024
	-	985	High Speed ap = 0.0040" x Ø ae = 0.0394" x Ø	0.00004	0.00012	0.00016	0.00020	0.00024	0.00031	0.00035
			Copy Milling	0.00004	0.00008	0.00012	0.00016	0.00020	0.00024	0.00028
	-	655	High Speed ap = 0.0040" x Ø ae = 0.0394" x Ø	0.00004	0.00012	0.00016	0.00020	0.00024	0.00031	0.00035
			Copy Milling	0.00004	0.00008	0.00012	0.00016	0.00020	0.00024	0.00028
	-	395	High Speed ap = 0.0040" x Ø ae = 0.0394" x Ø	0.00004	0.00012	0.00016	0.00020	0.00024	0.00031	0.00035
			Copy Milling	0.00004	0.00008	0.00012	0.00016	0.00020	0.00024	0.00028

ap = Depth of Cut ae = Width of Cut

# METRIC

## METRIC CARBIDE MICRO MOLD END MILLS

Material	Property	Vc : m/min AITiN	Feed : (mm/t)							
			Ø0.2	Ø0.5	Ø0.8	Ø1.0	Ø1.5	Ø2.0	Ø3.0	
	<500 MPa	200	High Speed ap = 0.1 x Ø ae = 1.0 x Ø	0.002	0.002	0.004	0.005	0.005	0.006	0.007
			Copy Milling	0.001	0.002	0.003	0.004	0.004	0.005	0.006
	<800 MPa	200	High Speed ap = 0.1 x Ø ae = 1.0 x Ø	0.002	0.002	0.004	0.005	0.005	0.006	0.007
			Copy Milling	0.001	0.002	0.003	0.004	0.004	0.005	0.006
	<500 MPa	200	High Speed ap = 0.1 x Ø ae = 1.0 x Ø	0.002	0.002	0.004	0.005	0.005	0.006	0.007
			Copy Milling	0.001	0.002	0.003	0.004	0.004	0.005	0.006
	<800 MPa	120	High Speed ap = 0.1 x Ø ae = 1.0 x Ø	0.002	0.002	0.004	0.005	0.005	0.006	0.007
			Copy Milling	0.001	0.002	0.003	0.004	0.004	0.005	0.006
	<500 MPa	80	High Speed ap = 0.1 x Ø ae = 1.0 x Ø	0.002	0.002	0.004	0.005	0.005	0.006	0.007
	<500 MPa	60	High Speed ap = 0.1 x Ø ae = 1.0 x Ø	0.002	0.002	0.004	0.005	0.005	0.006	0.007
	<800 MPa	100	High Speed ap = 0.1 x Ø ae = 1.0 x Ø	0.002	0.002	0.004	0.005	0.005	0.006	0.007
			Copy Milling	0.001	0.002	0.003	0.004	0.004	0.005	0.006
	<500 MPa	80	High Speed ap = 0.1 x Ø ae = 1.0 x Ø	0.002	0.002	0.004	0.005	0.005	0.006	0.007
			Copy Milling	0.001	0.002	0.003	0.004	0.004	0.005	0.006
	<800 MPa	80	High Speed ap = 0.1 x Ø ae = 1.0 x Ø	0.002	0.002	0.004	0.005	0.005	0.006	0.007
			Copy Milling	0.001	0.002	0.003	0.004	0.004	0.005	0.006
	<500 MPa	200	High Speed ap = 0.1 x Ø ae = 1.0 x Ø	0.002	0.002	0.004	0.005	0.005	0.006	0.007
			Copy Milling	0.001	0.002	0.003	0.004	0.004	0.005	0.006
	<800 MPa	300	High Speed ap = 0.1 x Ø ae = 1.0 x Ø	0.001	0.003	0.004	0.005	0.006	0.008	0.009
			Copy Milling	0.001	0.002	0.003	0.004	0.005	0.006	0.007
	<500 MPa	200	High Speed ap = 0.1 x Ø ae = 1.0 x Ø	0.001	0.003	0.004	0.005	0.006	0.008	0.009
			Copy Milling	0.001	0.002	0.003	0.004	0.005	0.006	0.007
	<800 MPa	120	High Speed ap = 0.1 x Ø ae = 1.0 x Ø	0.001	0.003	0.004	0.005	0.006	0.008	0.009
			Copy Milling	0.001	0.002	0.003	0.004	0.005	0.006	0.007

- DRILLS **A**
- END MILLS **B**
- ROUTERS **C**
- THREAD MILLS & TAPS **D**
- ENGRAVERS **E**
- BORING BARS **F**
- REAMERS **G**
- SAWS **H**
- TECHNICAL **I**
- INDEX **J**

## INCH











### INCH CARBIDE END MILLS

<b>A</b>	DRILLS
<b>B</b>	END MILLS
<b>C</b>	ROUTERS
<b>D</b>	THREAD MILLS & TAPS
<b>E</b>	ENGRAVERS
<b>F</b>	BORING BARS
<b>G</b>	REAMERS
<b>H</b>	SAWS
<b>I</b>	TECHNICAL
<b>J</b>	INDEX

Material	Property	Vc : SFM Uncoated	Vc : SFM AITIN	Feed : (ipt)								
				Ø0.157"	Ø0.236"	Ø0.315"	Ø0.394"	Ø0.472"	Ø0.630"	Ø0.787"	Ø0.984"	
	<60 ksi	330	490	Roughing	0.00067	0.00138	0.00181	0.00224	0.00280	0.00346	0.00402	0.00445
				Finishing	0.00094	0.00189	0.00252	0.00315	0.00390	0.00048	0.00563	0.00626
				Slotting	0.00047	0.00094	0.00126	0.00157	0.00197	0.00244	0.00087	0.00311
	<100 ksi	330	490	Roughing	0.00063	0.00126	0.00165	0.00205	0.00256	0.00319	0.00370	0.00409
				Finishing	0.00087	0.00173	0.00232	0.00287	0.00358	0.00445	0.00520	0.00575
				Slotting	0.00043	0.00087	0.00114	0.00146	0.00181	0.00224	0.00260	0.00287
	<145 ksi	230	360	Roughing	0.00051	0.00102	0.00134	0.00169	0.00209	0.00260	0.00303	0.00335
				Finishing	0.00071	0.00142	0.00189	0.00236	0.00295	0.00366	0.00425	0.00469
				Slotting	0.00035	0.00071	0.00094	0.00118	0.00146	0.00181	0.00213	0.00236
	<190 ksi	195	330	Roughing	0.00047	0.00091	0.00122	0.00150	0.00185	0.00232	0.00268	0.00299
				Finishing	0.00063	0.00126	0.00169	0.00209	0.00260	0.00323	0.00378	0.00417
				Slotting	0.00031	0.00063	0.00083	0.00106	0.00130	0.00161	0.00189	0.00209
	55HRC	100	195	Roughing	0.00039	0.00079	0.00106	0.00130	0.00161	0.00201	0.00236	0.00260
				Finishing	0.00055	0.00110	0.00146	0.00185	0.00228	0.00283	0.00331	0.00366
				Slotting	0.00028	0.00055	0.00075	0.00091	0.00114	0.00142	0.00165	0.00181
	68HRC	65	130	Roughing	0.00035	0.00067	0.00091	0.00114	0.00142	0.00173	0.00201	0.00224
				Finishing	0.00047	0.00094	0.00126	0.00157	0.00197	0.00244	0.00283	0.00311
				Slotting	0.00024	0.00047	0.00063	0.00079	0.00098	0.00122	0.00142	0.00157
	<130 ksi	195	295	Roughing	0.00051	0.00102	0.00134	0.00169	0.00209	0.00260	0.00303	0.00335
				Finishing	0.00071	0.00142	0.00189	0.00236	0.00295	0.00366	0.00425	0.00469
				Slotting	0.00035	0.00071	0.00094	0.00118	0.00146	0.00181	0.00213	0.00236
	>130 ksi	165	260	Roughing	0.00047	0.00091	0.00122	0.00150	0.00185	0.00232	0.00268	0.00299
				Finishing	0.00063	0.00126	0.00169	0.00209	0.00260	0.00323	0.00378	0.00417
				Slotting	0.00031	0.00063	0.00083	0.00106	0.00130	0.00161	0.00189	0.00209
	<130 ksi	130	195	Roughing	0.00039	0.00079	0.00106	0.00130	0.00161	0.00201	0.00236	0.00260
				Finishing	0.00055	0.00110	0.00146	0.00185	0.00228	0.00283	0.00331	0.00366
				Slotting	0.00028	0.00055	0.00075	0.00091	0.00114	0.00142	0.00165	0.00181
	>130 ksi	100	165	Roughing	0.00035	0.00067	0.00091	0.00114	0.00142	0.00173	0.00201	0.00224
				Finishing	0.00047	0.00094	0.00126	0.00157	0.00197	0.00244	0.00283	0.00311
				Slotting	0.00024	0.00047	0.00063	0.00079	0.00098	0.00122	0.00142	0.00157
	<130 ksi	100	165	Roughing	0.00039	0.00079	0.00106	0.00130	0.00161	0.00201	0.00236	0.00260
				Finishing	0.00055	0.00110	0.00146	0.00185	0.00228	0.00283	0.00331	0.00366
				Slotting	0.00028	0.00055	0.00075	0.00091	0.00114	0.00142	0.00165	0.00181
	>130 ksi	65	130	Roughing	0.00035	0.00067	0.00091	0.00114	0.00142	0.00173	0.00201	0.00224
				Finishing	0.00047	0.00094	0.00126	0.00157	0.00197	0.00244	0.00283	0.00311
				Slotting	0.00024	0.00047	0.00063	0.00079	0.00098	0.00122	0.00142	0.00157
	<8HRC	330	490	Roughing	0.00063	0.00126	0.00165	0.00205	0.00256	0.00319	0.00370	0.00409
				Finishing	0.00087	0.00173	0.00232	0.00287	0.00358	0.00445	0.00520	0.00575
				Slotting	0.00043	0.00087	0.00114	0.00146	0.00181	0.00224	0.00260	0.00287
	>8HRC	260	395	Roughing	0.00055	0.00114	0.00150	0.00189	0.00232	0.00291	0.00335	0.00374
				Finishing	0.00079	0.00157	0.00213	0.00264	0.00327	0.00406	0.00472	0.00520
				Slotting	0.00039	0.00079	0.00106	0.00130	0.00161	0.00201	0.00236	0.00260
	Silicon <10%	985	1640	Roughing	0.00067	0.00138	0.00181	0.00224	0.00280	0.00346	0.00402	0.00445
				Finishing	0.00055	0.00119	0.00252	0.00315	0.00390	0.00484	0.00563	0.00626
				Slotting	0.00047	0.00094	0.00126	0.00157	0.00197	0.00244	0.00283	0.00311
	Silicon >10%	655	1310	Roughing	0.00063	0.00126	0.00165	0.00205	0.00256	0.00319	0.00370	0.00409
				Finishing	0.00087	0.00173	0.00232	0.00287	0.00358	0.00445	0.00520	0.00575
				Slotting	0.00043	0.00087	0.00114	0.00146	0.00181	0.00224	0.00260	0.00287
	Bronze	330	490	Roughing	0.00055	0.00114	0.00150	0.00189	0.00232	0.00291	0.00335	0.00374
				Finishing	0.00079	0.00157	0.00213	0.00264	0.00327	0.00406	0.00472	0.00520
				Slotting	0.00039	0.00079	0.00106	0.00130	0.00161	0.00201	0.00236	0.00260
	Brass	260	395	Roughing	0.00055	0.00114	0.00150	0.00189	0.00232	0.00291	0.00335	0.00374
				Finishing	0.00079	0.00157	0.00213	0.00264	0.00327	0.00406	0.00472	0.00520
				Slotting	0.00039	0.00079	0.00106	0.00130	0.00161	0.00201	0.00236	0.00260
	-	985	1640	Roughing	0.00055	0.00114	0.00150	0.00189	0.00232	0.00291	0.00335	0.00374
				Finishing	0.00079	0.00157	0.00213	0.00264	0.00327	0.00406	0.00472	0.00520
				Slotting	0.00039	0.00079	0.00106	0.00130	0.00161	0.00201	0.00236	0.00260

# METRIC





## METRIC CARBIDE END MILLS

Material	Property	Vc : m/min Uncoated	Vc : m/min AlTiN	Feed : (mm/t)								
				Ø4	Ø6	Ø8	Ø10	Ø12	Ø16	Ø20	Ø25	
	<400 MPa	100	150	Roughing	0.017	0.035	0.046	0.057	0.071	0.088	0.102	0.113
				Finishing	0.024	0.048	0.064	0.080	0.099	0.12	0.143	0.159
				Slotting	0.012	0.024	0.032	0.040	0.050	0.062	0.072	0.079
	<700 MPa	100	150	Roughing	0.016	0.032	0.042	0.052	0.065	0.081	0.094	0.104
				Finishing	0.022	0.044	0.059	0.073	0.091	0.113	0.132	0.146
				Slotting	0.011	0.022	0.029	0.037	0.046	0.057	0.066	0.073
	<1,000 MPa	70	110	Roughing	0.013	0.026	0.034	0.043	0.053	0.066	0.077	0.085
				Finishing	0.018	0.036	0.048	0.060	0.075	0.093	0.108	0.119
				Slotting	0.009	0.018	0.024	0.030	0.037	0.046	0.054	0.060
	<1,300 MPa	60	100	Roughing	0.012	0.023	0.031	0.038	0.047	0.059	0.068	0.076
				Finishing	0.016	0.032	0.043	0.053	0.066	0.082	0.096	0.106
				Slotting	0.008	0.016	0.021	0.027	0.033	0.041	0.048	0.053
	55HRC	30	60	Roughing	0.010	0.020	0.027	0.033	0.041	0.051	0.060	0.066
				Finishing	0.014	0.028	0.037	0.047	0.058	0.072	0.084	0.093
				Slotting	0.007	0.014	0.019	0.023	0.029	0.036	0.042	0.046
	68HRC	20	40	Roughing	0.009	0.017	0.023	0.029	0.036	0.044	0.051	0.057
				Finishing	0.012	0.024	0.032	0.040	0.050	0.062	0.072	0.079
				Slotting	0.006	0.012	0.016	0.020	0.025	0.031	0.036	0.040
	<900 MPa	60	90	Roughing	0.013	0.026	0.034	0.043	0.053	0.066	0.077	0.085
				Finishing	0.018	0.036	0.048	0.060	0.075	0.093	0.108	0.119
				Slotting	0.009	0.018	0.024	0.030	0.037	0.046	0.054	0.060
	>900 MPa	50	80	Roughing	0.012	0.023	0.031	0.038	0.047	0.059	0.068	0.076
				Finishing	0.016	0.032	0.043	0.053	0.066	0.082	0.096	0.106
				Slotting	0.008	0.016	0.021	0.027	0.033	0.041	0.048	0.053
	<900 MPa	40	60	Roughing	0.010	0.020	0.027	0.033	0.041	0.051	0.060	0.066
				Finishing	0.014	0.028	0.037	0.047	0.058	0.072	0.084	0.093
				Slotting	0.007	0.014	0.019	0.023	0.029	0.036	0.042	0.046
	>900 MPa	30	50	Roughing	0.009	0.017	0.023	0.029	0.036	0.044	0.051	0.057
				Finishing	0.012	0.024	0.032	0.040	0.050	0.062	0.072	0.079
				Slotting	0.006	0.012	0.016	0.020	0.025	0.031	0.036	0.040
	<900 MPa	30	50	Roughing	0.010	0.020	0.027	0.033	0.041	0.051	0.060	0.066
				Finishing	0.014	0.028	0.037	0.047	0.058	0.072	0.084	0.093
				Slotting	0.007	0.014	0.019	0.023	0.029	0.036	0.042	0.046
	>900 MPa	20	40	Roughing	0.009	0.017	0.023	0.029	0.036	0.044	0.051	0.057
				Finishing	0.012	0.024	0.032	0.040	0.050	0.062	0.072	0.079
				Slotting	0.006	0.012	0.016	0.020	0.025	0.031	0.036	0.040
	<180 HB	100	150	Roughing	0.016	0.032	0.042	0.052	0.065	0.081	0.094	0.104
				Finishing	0.022	0.044	0.059	0.073	0.091	0.113	0.132	0.146
				Slotting	0.011	0.022	0.029	0.037	0.046	0.057	0.066	0.073
	>180 HB	80	120	Roughing	0.014	0.029	0.038	0.048	0.059	0.074	0.085	0.095
				Finishing	0.020	0.040	0.054	0.067	0.083	0.103	0.120	0.132
				Slotting	0.010	0.020	0.027	0.033	0.041	0.051	0.060	0.066
	Silicon <10%	300	500	Roughing	0.017	0.035	0.046	0.057	0.071	0.088	0.102	0.113
				Finishing	0.014	0.048	0.064	0.080	0.099	0.123	0.143	0.159
				Slotting	0.012	0.024	0.032	0.040	0.050	0.062	0.072	0.079
	Silicon >10%	200	400	Roughing	0.016	0.032	0.042	0.052	0.065	0.081	0.094	0.104
				Finishing	0.022	0.044	0.059	0.073	0.091	0.113	0.132	0.146
				Slotting	0.011	0.022	0.029	0.037	0.046	0.057	0.066	0.073
	Bronze	100	150	Roughing	0.014	0.029	0.038	0.048	0.059	0.074	0.085	0.095
				Finishing	0.020	0.040	0.054	0.067	0.083	0.103	0.120	0.132
				Slotting	0.010	0.020	0.027	0.033	0.041	0.051	0.060	0.066
	Brass	80	120	Roughing	0.014	0.029	0.038	0.048	0.059	0.074	0.085	0.095
				Finishing	0.020	0.040	0.054	0.067	0.083	0.103	0.120	0.132
				Slotting	0.010	0.020	0.027	0.033	0.041	0.051	0.060	0.066
	-	300	500	Roughing	0.014	0.029	0.038	0.048	0.059	0.074	0.085	0.095
				Finishing	0.020	0.040	0.054	0.067	0.083	0.103	0.120	0.132
				Slotting	0.010	0.020	0.027	0.033	0.041	0.051	0.060	0.066

- DRILLS **A**
- END MILLS **B**
- ROUTERS **C**
- THREAD MILLS & TAPS **D**
- ENGRAVERS **E**
- BORING BARS **F**
- REAMERS **G**
- SAWS **H**
- TECHNICAL **I**
- INDEX **J**

# INCH





## INCH COMPRESSION END MILLS

Material	Cut Type	Cutting Speed (sfm)	Feed Rate (inch/flute)			
			Cutting Diameter (ØDc)			
			1/4"	5/16"	3/8"	1/2"
 (Carbon Fiber, Aramid Fiber)	Profile	500	0.0016	0.0025	0.0030	0.0040
	Light Profile	825	0.0037	0.0057	0.0069	0.0092
 (Fiberglass)	Profile	400	0.0016	0.0025	0.0030	0.0040
	Light Profile	660	0.0037	0.0057	0.0069	0.0092
	Profile	600	0.0020	0.0031	0.0038	0.0050
	Light Profile	990	0.0046	0.0072	0.0086	0.0115
	Profile	1000	0.0020	0.0031	0.0038	0.0050
	Light Profile	1650	0.0046	0.0072	0.0086	0.0115
	Profile	50	0.0008	0.0013	0.0015	0.0020
	Light Profile	85	0.0018	0.0029	0.0034	0.0046

• Above recommendations are suggested starting parameters. Cutting speeds and feed rates may vary according to machining application.

# METRIC

## METRIC COMPRESSION END MILLS





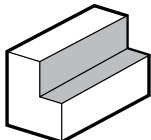
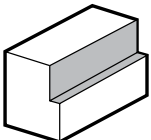



Material	Cut Type	Cutting Speed (m/min)	Feed Rate (mm/flute)			
			Cutting Diameter (ØDc)			
			6mm	8mm	10mm	12mm
 (Carbon Fiber, Aramid Fiber)	Profile	152	0.041	0.064	0.076	0.102
	Light Profile	251	0.094	0.145	0.175	0.234
 (Fiberglass)	Profile	122	0.041	0.064	0.076	0.102
	Light Profile	201	0.094	0.145	0.175	0.234
	Profile	183	0.051	0.079	0.097	0.127
	Light Profile	302	0.117	0.183	0.218	0.292
	Profile	305	0.051	0.079	0.097	0.127
	Light Profile	503	0.117	0.183	0.218	0.292
	Profile	15	0.020	0.033	0.038	0.051
	Light Profile	26	0.046	0.074	0.086	0.117









• Above recommendations are suggested starting parameters. Cutting speeds and feed rates may vary according to machining application.

Cut Type		
<b>Profile</b> Radial Width = 0.5 x ØDc Axial Depth = 1.5 x ØDc	<b>Light Profile</b> Radial Width = 0.05 x ØDc Axial Depth = L2	$\text{rpm} = \text{sfm} \times 3.82 / \text{ØDc}$ $\text{ipm} = (\text{inch/flute}) \times \text{no. of flutes} \times \text{rpm}$ <ul style="list-style-type: none"> <li>• Maximum recommended depths shown</li> <li>• Adjust speed and feed based upon resin type and/or fiber structure</li> <li>• Reduce speed when overheating causes melting or damage to resin</li> <li>• Reduce feed if delamination or fraying occurs</li> <li>• Finish cuts typically require reduced feed and cutting depths</li> <li>• Rates shown are for use without coolant; rates may be increased with coolant use</li> <li>• Dust collection is vital when machining dry</li> <li>• Diamond coating will increase tool life in graphite and composite materials</li> </ul>
		

# METRIC

## METRIC CARBIDE MICRO REAMERS

Material	Property	Vc : m/min AlTiN	Feed : (mm/t)			
			Ø < 0.345	Ø < 0.445	Ø < 0.545	Ø < 0.595
	<500 MPa	20	0.010	0.015	0.020	0.030
	<800 MPa	15	0.010	0.015	0.020	0.030
	<1,000 MPa	10	0.010	0.015	0.020	0.030
	<1,300 MPa					
	-	7	0.010	0.015	0.020	0.030
	-	5	0.010	0.015	0.020	0.030
	-	5	0.010	0.015	0.020	0.030
	<180 HB	15	0.010	0.015	0.020	0.035
	>180 HB	10	0.010	0.015	0.020	0.035
	-	20	0.010	0.015	0.020	0.035
	-	20	0.010	0.015	0.020	0.035

Material	Property	Vc : m/min AlTiN	Feed : (mm/t)		
			Ø2	Ø6	Ø10
	<500 MPa	25 ~ 40	0.150	0.150	0.250
	<800 MPa	20 ~ 25	0.100	0.120	0.180
	<1,000 MPa	12 ~ 18	0.080	0.100	0.180
	<1,300 MPa	10 ~ 15	0.080	0.090	0.150
	Ferritic	7 ~ 12	0.070	0.100	0.120
	Martensitic	7 ~ 12	0.070	0.100	0.120
	Austenitic	7 ~ 12	0.070	0.100	0.120
	-	6 ~ 10	0.070	0.100	0.120
	<900 MPa	6 ~ 10	0.070	0.100	0.120
	>900 MPa	6 ~ 10	0.070	0.100	0.120
	<180 HB	30 ~ 40	0.100	0.120	0.200
	>180 HB	8 ~ 15	0.070	0.100	0.150
	140-360 MPa	40 ~ 60	0.150	0.180	0.250
	Silicon <10%	15 ~ 25	0.080	0.200	0.380
	Silicon >10%	15 ~ 30	0.060	0.160	0.250
	Bronze	20 ~ 25	0.150	0.180	0.220
	Copper	25 ~ 30	0.120	0.180	0.200
	Brass	35 ~ 40	0.200	0.220	0.300

- DRILLS **A**
- END MILLS **B**
- ROUTERS **C**
- THREAD MILLS & TAPS **D**
- ENGRAVERS **E**
- BORING BARS **F**
- REAMERS **G**
- SAWS **H**
- TECHNICAL **I**
- INDEX **J**



# METRIC PRE-DRILL DIAMETERS

FOR REAMERS

Diameter (mm)										
0.3	0.24	0.24	0.24	0.24	0.24	0.24	0.24	0.24	0.24	0.24
0.4	0.32	0.32	0.32	0.32	0.32	0.32	0.32	0.32	0.32	0.32
0.5	0.42	0.42	0.42	0.42	0.42	0.42	0.42	0.42	0.42	0.42
0.6	0.50	0.50	0.50	0.50	0.50	0.50	0.50	0.50	0.50	0.50
0.8	0.68	0.68	0.68	0.68	0.68	0.68	0.68	0.68	0.68	0.68
1.0	0.85	0.85	0.85	0.85	0.85	0.85	0.85	0.85	0.85	0.85
2.0	1.80	1.80	1.80	1.80	1.80	1.80	1.80	1.80	1.80	1.80
3.0	2.80	2.80	2.80	2.80	2.80	2.80	2.80	2.80	2.80	2.80
4.0	3.80	3.80	3.80	3.80	3.80	3.80	3.80	3.80	3.80	3.80
5.0	4.80	4.80	4.80	4.80	4.80	4.80	4.80	4.80	4.80	4.80
6.0	5.80	5.80	5.80	5.80	5.80	5.80	5.80	5.80	5.80	5.80
8.0	7.80	7.80	7.80	7.80	7.70	7.70	7.80	7.70	7.80	7.80

## COATING GUIDE

Coating	TiN	TiCN	TiAlCN	TiAlN	AlTiN	AlTiN Nano	ZrN	CrN	CBC	AlTiN / Si <sub>3</sub> N <sub>4</sub>	AX	AlCrN / Si <sub>3</sub> N <sub>4</sub>	DLC	CVD Diamond
Nanohardness (Gpa)	24	37	28	28	38	38	20	18	20	45	36	42	77	87
Friction Coefficient (Fretting)	0.55	0.2	0.3	0.6	0.7	0.7	0.4	0.3	0.15	0.45	0.35	0.35	0.2	0.25
Thickness (µm) (Application Dependant)	1 - 5	1 - 4	1 - 4	1 - 4	1 - 3	2-4	1 - 4	1 - 4	0.5 - 1.5	1 - 4	1-4	1 - 5	1 - 3	8 - 12
Maximum Working Temperature	600 °C (1100 °F)	400 °C (750 °F)	500 °C (930 °F)	700 °C (1290 °F)	900 °C (1650 °F)	900 °C (1650 °F)	550 °C (1020 °F)	700 °C (1290 °F)	400 °C (750 °F)	1200 °C (2190 °F)	1100 °C (2010 °F)	1100 °C (2010 °F)	700 °C (1290 °F)	800 °C (1470 °F)
Color	Golden Yellow	Blue-Gray	Red Copper	Violet	Blue Black	Gray	Pale Yellow	Silver	Charcoal Gray	Blue Black	Silver Gray	Silver Gray	Black	Gray

VICKERS HARDNESS CONVERSION CHART

Rockwell						Rockwell Superficial				Brinell		Vickers	Shore	Approx. Tensile Strength (psi)
A	B	C	D	E	F	15-N	30-N	45-N	30-T	3000kg	500kg	136		
60kg Brale	100kg 1/16" Ball	150kg Brale	100kg Brale	100kg 1/8" Ball	60kg 1/16" Ball	15kg Brale	30kg Brale	45kg Brale	30kg 1/16" Ball	10mm Ball Steel	10mm Ball Steel	Diamond Pyramid	Scieroscope	
86.5	-	70	78.5	-	-	94.0	86.0	77.6	-	-	-	1076	101	-
86.0	-	69	77.7	-	-	93.5	85.0	76.5	-	-	-	1044	99	-
85.6	-	68	76.9	-	-	93.2	84.4	75.4	-	-	-	940	97	-
85.0	-	67	76.1	-	-	92.9	83.6	74.2	-	-	-	900	95	-
84.5	-	66	75.4	-	-	92.5	82.8	73.2	-	-	-	865	92	-
83.9	-	65	74.5	-	-	92.2	81.9	72.0	-	739	-	832	91	-
83.4	-	64	73.8	-	-	91.8	81.1	71.0	-	722	-	800	88	-
82.8	-	63	73.0	-	-	91.4	80.1	69.9	-	705	-	772	87	-
82.3	-	62	72.2	-	-	91.1	79.3	68.8	-	688	-	746	85	-
81.8	-	61	71.5	-	-	90.7	78.4	67.7	-	670	-	720	83	-
81.2	-	60	70.7	-	-	90.2	77.5	66.6	-	654	-	697	81	-
80.7	-	59	69.9	-	-	89.8	76.6	65.5	-	634	-	674	80	-
80.1	-	58	69.2	-	-	89.3	75.7	64.3	-	615	-	653	78	-
79.6	-	57	68.5	-	-	88.9	74.8	63.2	-	595	-	633	76	-
79.0	-	56	67.7	-	-	88.3	73.9	62.0	-	577	-	613	75	-
78.5	120	55	66.9	-	-	87.9	73.0	60.9	-	560	-	595	74	-
78.0	120	54	66.1	-	-	87.4	72.0	59.8	-	543	-	577	72	-
77.4	119	53	65.4	-	-	86.9	71.2	58.6	-	525	-	560	71	-
76.8	119	52	64.6	-	-	86.4	70.2	57.4	-	500	-	544	69	-
76.3	118	51	63.8	-	-	85.9	69.4	56.1	-	487	-	528	68	-
75.9	117	50	63.1	-	-	85.5	68.5	55.0	-	475	-	513	67	-
75.2	117	49	62.1	-	-	85.0	67.6	53.8	-	464	-	498	66	-
74.7	116	48	61.4	-	-	84.5	66.7	52.5	-	451	-	484	64	-
74.1	116	47	60.8	-	-	83.9	65.8	51.4	-	442	-	471	63	-
73.6	115	46	60.0	-	-	83.5	64.8	50.3	-	432	-	458	62	-
73.1	115	45	59.2	-	-	83.0	64.0	49.0	-	421	-	446	60	-
72.5	114	44	58.5	-	-	82.5	63.1	47.8	-	409	-	434	58	-
72.0	113	43	57.7	-	-	82.0	62.2	46.7	-	400	-	423	57	-
71.5	113	42	56.9	-	-	81.5	61.3	45.5	-	390	-	412	56	191,000
70.9	112	41	56.2	-	-	80.9	60.4	44.3	-	381	-	402	55	187,000
70.4	112	40	55.4	-	-	80.4	59.5	43.1	-	371	-	392	54	182,000
69.9	111	39	54.6	-	-	79.9	58.6	41.9	-	362	-	382	52	177,000
69.4	110	38	53.8	-	-	79.4	57.7	40.8	-	353	-	372	51	173,000
68.9	110	37	53.1	-	-	78.8	56.8	39.6	-	344	-	363	50	169,000
68.4	109	36	52.3	-	-	78.3	55.9	38.4	-	336	-	354	49	165,000
67.9	109	35	51.5	-	-	77.7	55.0	37.2	-	327	-	345	48	160,000
67.4	108	34	50.8	-	-	77.2	54.2	36.1	-	319	-	336	47	156,000
66.8	108	33	50.0	-	-	76.6	53.3	34.9	-	311	-	327	46	152,000
66.3	107	32	49.2	-	-	76.1	52.1	33.7	-	301	-	318	44	147,000
65.8	106	31	48.4	-	-	75.6	51.3	32.5	-	294	-	310	43	144,000
65.3	105	30	47.7	-	-	75.0	50.4	31.3	-	286	-	302	42	140,000
64.7	104	29	47.0	-	-	74.5	49.5	30.1	-	279	-	294	41	137,000
64.3	104	28	46.1	-	-	73.9	48.6	28.9	-	271	-	286	41	133,000
63.8	103	27	45.2	-	-	73.3	47.7	27.8	-	264	-	279	40	129,000
63.3	103	26	44.6	-	-	72.8	46.8	26.7	-	258	-	272	39	126,000
62.8	102	25	43.8	-	-	72.2	45.9	25.5	-	253	-	266	38	124,000
62.4	101	24	43.1	-	-	71.6	45.0	24.3	-	247	-	260	37	121,000
62.0	100	23	42.1	-	-	71.0	44.0	23.1	82.0	240	201	254	36	118,000
61.5	99	22	41.6	-	-	70.5	43.2	22.0	81.5	234	195	248	35	115,000

- DRILLS **A**
- END MILLS **B**
- ROUTERS **C**
- THREAD MILLS & TAPS **D**
- ENGRAVERS **E**
- BORING BARS **F**
- REAMERS **G**
- SAWS **H**
- TECHNICAL **I**
- INDEX **J**

		Rockwell						Rockwell Superficial				Brinell		Vickers	Shore	Approx. Tensile Strength (psi)
		A	B	C	D	E	F	15-N	30-N	45-N	30-T	3000kg	500kg	136		
		60kg Brale	100kg 1/16" Ball	150kg Brale	100kg Brale	100kg 1/8" Ball	60kg 1/16" Ball	15kg Brale	30kg Brale	45kg Brale	30kg 1/16" Ball	10mm Ball Steel	10mm Ball Steel	Diamond Pyramid	Sciuroscope	
A	DRILLS	61.0	98	21	40.9	-	-	69.9	42.3	20.7	81.0	228	189	243	35	112,000
		60.5	97	20	40.1	-	-	69.4	41.5	19.6	80.5	222	184	238	34	109,000
B	END MILLS	59.0	96	18	-	-	-	-	-	-	80.0	216	179	230	33	106,000
		58.0	95	16	-	-	-	-	-	-	79.0	210	175	222	32	103,000
		57.5	94	15	-	-	-	-	-	-	78.5	205	171	213	31	100,000
C	ROUTERS	57.0	93	13	-	-	-	-	-	-	78.0	200	167	208	30	98,000
		56.5	92	12	-	-	-	-	-	-	77.5	195	163	204	29	96,000
		56.0	91	10	-	-	-	-	-	-	77.0	190	160	196	28	93,000
		55.5	90	9	-	-	-	-	-	-	76.0	185	157	192	27	91,000
D	THREAD MILLS & TAPS	55.0	89	8	-	-	-	-	-	-	75.5	180	154	188	26	88,000
		54.0	88	7	-	-	-	-	-	-	75.0	176	151	184	26	86,000
		53.5	87	6	-	-	-	-	-	-	74.5	172	148	180	26	84,000
		53.0	86	5	-	-	-	-	-	-	74.0	169	145	176	25	83,000
		52.5	85	4	-	-	-	-	-	-	73.5	165	142	173	25	81,000
E	ENGRAVERS	52.0	84	3	-	-	-	-	-	-	73.0	162	140	170	25	79,000
		51.0	83	2	-	-	-	-	-	-	72.0	159	137	166	24	78,000
		50.5	82	1	-	-	-	-	-	-	71.5	156	135	163	24	76,000
		50.0	81	0	-	-	-	-	-	-	71.0	153	133	160	24	75,000
F	BORING BARS	49.5	80	-	-	-	-	-	-	-	70.0	150	130	-	-	73,000
		49.0	79	-	-	-	-	-	-	-	69.5	147	128	-	-	-
		48.5	78	-	-	-	-	-	-	-	69.0	144	126	-	-	-
		48.0	77	-	-	-	-	-	-	-	68.0	141	124	-	-	-
		47.0	76	-	-	-	-	-	-	-	67.5	139	122	-	-	-
G	REAMERS	46.5	75	-	-	-	99.5	-	-	-	67.0	137	120	-	-	-
		46.0	74	-	-	-	99.0	-	-	-	66.0	135	118	-	-	-
		45.5	73	-	-	-	98.5	-	-	-	65.5	132	116	-	-	-
		45.0	72	-	-	-	98.0	-	-	-	65.0	130	114	-	-	-
		44.5	71	-	-	100.0	97.5	-	-	-	64.2	127	112	-	-	-
H	SAWS	44.0	70	-	-	99.5	97.0	-	-	-	63.5	125	110	-	-	-
		43.5	69	-	-	99.0	96.0	-	-	-	62.8	123	109	-	-	-
		43.0	68	-	-	98.0	95.5	-	-	-	62.0	121	107	-	-	-
		42.5	67	-	-	97.5	95.0	-	-	-	61.4	119	106	-	-	-
		42.0	66	-	-	97.0	94.5	-	-	-	60.5	117	104	-	-	-
I	TECHNICAL	41.8	65	-	-	96.0	94.0	-	-	-	60.1	116	102	-	-	-
		41.5	64	-	-	95.5	93.5	-	-	-	59.5	114	101	-	-	-
		41.0	63	-	-	95.0	93.0	-	-	-	58.7	112	99	-	-	-
		40.5	62	-	-	94.5	92.0	-	-	-	58.0	110	98	-	-	-
		40.0	61	-	-	93.5	91.5	-	-	-	57.3	108	96	-	-	-
		39.5	60	-	-	93.0	91.0	-	-	-	56.5	107	95	-	-	-
		39.0	59	-	-	92.5	90.5	-	-	-	55.9	106	94	-	-	-
J	INDEX	38.5	58	-	-	92.0	90.0	-	-	-	55.0	104	92	-	-	-
		38.0	57	-	-	91.0	89.5	-	-	-	54.6	102	91	-	-	-
		37.8	56	-	-	90.5	89.0	-	-	-	54.0	101	90	-	-	-
		37.5	55	-	-	90.0	88.0	-	-	-	53.2	99	89	-	-	-
		37.0	54	-	-	89.5	87.5	-	-	-	52.5	-	87	-	-	-
		36.5	53	-	-	89.0	87.0	-	-	-	51.8	-	86	-	-	-
		36.0	52	-	-	88.0	86.5	-	-	-	51.0	-	85	-	-	-
		35.5	51	-	-	87.5	86.0	-	-	-	50.4	-	84	-	-	-
		35.0	50	-	-	87.0	85.5	-	-	-	49.5	-	83	-	-	-
		34.8	49	-	-	86.5	85.0	-	-	-	49.1	-	82	-	-	-
		34.5	48	-	-	85.5	84.5	-	-	-	48.5	-	81	-	-	-

Rockwell						Rockwell Superficial				Brinell		Vickers	Shore	Approx. Tensile Strength (psi)
A	B	C	D	E	F	15-N	30-N	45-N	30-T	3000kg	500kg	136		
60kg Brale	100kg 1/16" Ball	150kg Brale	100kg Brale	100kg 1/8" Ball	60kg 1/16" Ball	15kg Brale	30kg Brale	45kg Brale	30kg 1/16" Ball	10mm Ball Steel	10mm Ball Steel	Diamond Pyramid	Sciero-scope	
34.0	47	-	-	85.0	84.0	-	-	-	47.7	-	80	-	-	-
33.5	46	-	-	84.5	83.0	-	-	-	47.0	-	79	-	-	-
33.0	45	-	-	84.0	82.5	-	-	-	46.2	-	79	-	-	-
32.5	44	-	-	83.5	82.0	-	-	-	45.5	-	78	-	-	-
32.0	43	-	-	82.5	81.5	-	-	-	44.8	-	77	-	-	-
31.5	42	-	-	82.0	81.0	-	-	-	44.0	-	76	-	-	-
31.0	41	-	-	81.5	80.5	-	-	-	43.4	-	75	-	-	-
30.8	40	-	-	81.0	79.5	-	-	-	43.0	-	74	-	-	-
30.5	39	-	-	80.0	79.0	-	-	-	42.1	-	74	-	-	-
30.0	38	-	-	79.5	78.5	-	-	-	41.5	-	73	-	-	-
29.5	37	-	-	79.0	78.0	-	-	-	40.7	-	72	-	-	-
29.0	36	-	-	78.5	77.5	-	-	-	40.0	-	71	-	-	-
28.5	35	-	-	78.0	77.0	-	-	-	39.3	-	71	-	-	-
28.0	34	-	-	77.0	76.5	-	-	-	38.5	-	70	-	-	-
27.8	33	-	-	76.5	75.5	-	-	-	37.9	-	69	-	-	-
27.5	32	-	-	76.0	75.0	-	-	-	37.5	-	68	-	-	-
27.0	31	-	-	75.5	74.5	-	-	-	36.6	-	68	-	-	-
26.5	30	-	-	75.0	74.0	-	-	-	36.0	-	67	-	-	-
26.0	29	-	-	74.0	73.5	-	-	-	35.2	-	66	-	-	-
25.5	28	-	-	73.5	73.0	-	-	-	34.5	-	66	-	-	-
25.0	27	-	-	73.0	72.5	-	-	-	33.8	-	65	-	-	-
24.5	26	-	-	72.5	72.0	-	-	-	33.1	-	65	-	-	-
24.2	25	-	-	72.0	71.0	-	-	-	32.4	-	64	-	-	-
24.0	24	-	-	71.0	70.5	-	-	-	32.0	-	64	-	-	-
23.5	23	-	-	70.5	70.0	-	-	-	31.1	-	63	-	-	-
23.0	22	-	-	70.0	69.5	-	-	-	30.4	-	63	-	-	-
22.5	21	-	-	69.5	69.0	-	-	-	29.7	-	62	-	-	-
22.0	20	-	-	68.5	68.5	-	-	-	29.0	-	62	-	-	-
21.5	19	-	-	68.0	68.0	-	-	-	28.1	-	61	-	-	-
21.2	18	-	-	67.5	67.0	-	-	-	27.4	-	61	-	-	-
21.0	17	-	-	67.0	66.5	-	-	-	26.7	-	60	-	-	-
20.5	16	-	-	66.5	66.0	-	-	-	26.0	-	60	-	-	-
20.0	15	-	-	65.5	65.5	-	-	-	25.3	-	59	-	-	-
-	14	-	-	65.0	65.0	-	-	-	24.6	-	59	-	-	-
-	13	-	-	64.5	64.5	-	-	-	23.9	-	58	-	-	-
-	12	-	-	64.0	64.0	-	-	-	23.5	-	58	-	-	-
-	11	-	-	63.5	63.5	-	-	-	22.6	-	57	-	-	-
-	10	-	-	62.5	63.0	-	-	-	21.9	-	57	-	-	-
-	9	-	-	62.0	62.0	-	-	-	21.2	-	56	-	-	-
-	8	-	-	61.5	61.5	-	-	-	20.5	-	56	-	-	-
-	7	-	-	61.0	61.0	-	-	-	19.8	-	56	-	-	-
-	6	-	-	60.5	60.5	-	-	-	19.1	-	55	-	-	-
-	5	-	-	60.0	60.0	-	-	-	18.4	-	55	-	-	-
-	4	-	-	59.0	59.5	-	-	-	18.0	-	55	-	-	-
-	3	-	-	58.5	59.0	-	-	-	17.1	-	54	-	-	-
-	2	-	-	58.0	58.0	-	-	-	16.4	-	54	-	-	-
-	1	-	-	57.5	57.5	-	-	-	15.7	-	53	-	-	-
-	0	-	-	57.0	57.0	-	-	-	15.0	-	53	-	-	-

DRILLS	<b>A</b>
END MILLS	<b>B</b>
ROUTERS	<b>C</b>
THREAD MILLS & TAPS	<b>D</b>
ENGRAVERS	<b>E</b>
BORING BARS	<b>F</b>
REAMERS	<b>G</b>
SAWS	<b>H</b>
<b>TECHNICAL</b>	<b>I</b>
INDEX	<b>J</b>

<b>A</b>	DRILLS
<b>B</b>	END MILLS
<b>C</b>	ROUTERS
<b>D</b>	THREAD MILLS & TAPS
<b>E</b>	ENGRAVERS
<b>F</b>	BORING BARS
<b>G</b>	REAMERS
<b>H</b>	SAWS
<b>I</b>	TECHNICAL
<b>J</b>	INDEX

METAL			
Class	Name of JIS Standard	Symbol	
Structural Steel	Rolled Steel for Welded Structure	SM	
	Re-Rolled Steel	SRB	
	Rolled Steel for General Structure	SS	
	Light Gauge Steel for General Structure	SSC	
	Hot-Rolled Steel Plate, Sheet and Strip for Automobile Structural Use	SAPH	
Steel Sheet	Cold-Rolled Steel Plate, Sheet and Strip	SPC	
	Hot-Rolled Soft Steel Plate, Sheet and Strip	SPH	
Steel Pipe	Carbon Steel Pipe for Ordinary Piping	SGP	
	Carbon Steel Pipe for Boiler / Heat Exchanger	STB	
	Seamless Steel Pipe for High Pressure Gas Cylinder	STH	
	Carbon Steel Pipe for General Structural Use	STK	
	Carbon Steel Pipe for Machine Structural Use	STKM	
	Alloy Steel Pipe for Structural Use	STKS	
	Stainless Steel Pipe for Machine Structural Use	SUS-TK	
	Steel Square Pipe for General Structural Use	STKR	
	Alloy Steel Pipe for Ordinary Piping	STPA	
	Carbon Steel Pipe for Pressure Service	STPG	
	Carbon Steel Pipe for High-Temperature Service	STPT	
	Carbon Steel Pipe for High-Pressure Service	STS	
	Stainless Steel Pipe for Ordinary Piping	SUS-TP	
	Steel for Machine Structural Use	Carbon Steel for Machine Structural Use	SxxC, SxxCK
		Aluminium Chromium Molybdenum Steel	SACM
Chromium Molybdenum Steel		SCM	
Chromium Steel		SCr	
Nickel Chromium Steel		SNC	
Nickel Chromium Molybdenum Steel		SNCM	
Manganese Steel and Manganese Chromium Steel for Machine Structural Use		SMn, SMnC	
Carbon Tool Steel		SK	
Tool Steel	Hollow Drill Steel	SKC	
	Alloy Tool Steel	SKS, SKD, SKT	
	High Speed Tool Steel	SKH	
Special Steel	Free Cutting Carbon Steel	SUM	
	High Carbon Chromium Bearing Steel	SUJ	
	Spring Steel	SUP	
	Stainless Steel Bar	SUS-B	
Stainless Steel	Hot-Rolled Stainless Steel Plate, Sheet and Strip	SUS-HP, SUS-HS	
	Cold-Rolled Stainless Steel Plate, Sheet and Strip	SUS-CP, SUS-CS	
	Heat-Resisting Steel Bar	SUH-B, SUH-CB	
Heat Resistant Steel	Heat-Resisting Steel Plate and Sheet	SUH-HP, SUH-CP	
	Super Alloy	Corrosion-Resisting and Heat-Resisting Superalloy Bar	NCF-B
Corrosion-Resisting and Heat-Resisting Superalloy Plate and Sheet		NCF-P	
Forged Steel	Carbon Steel Forging	SF	
	Chromium Molybdenum Steel Forging	SFCM	
	Nickel Chromium Molybdenum Steel Forging	SFNCM	
Cast Iron	Gray Cast Iron	FC	
	Spheroidal Graphite Cast Iron	FCD	
	Blackheart Malleable Cast Iron	FCMB	
	Whiteheart Malleable Cast Iron	FCMW	
	Pearlitic Malleable Cast Iron	FCMP	
Cast Steel	Carbon Cast Steel	SC	
	High Tensile Strength Carbon Cast Steel & Low Alloy Cast Steel	SCC	
	Stainless Cast Steel	SCS	
	Heat-Resisting Cast Steel	SCH	
	High Manganese Cast Steel	SCMnH	
	Cast Steel for High Temperature and High Pressure Service	SCPH	

NON-FERROUS METAL		
Class	Name of JIS Standard	Symbol
Copper	Copper and Copper Alloy Sheet / Strip	CxxxP CxxxPP CxxxR
	Copper and Copper Alloy Rod and Bar	CxxxBD CxxxBDS CxxxBE
Aluminum Alloy and Aluminum Alloy Expanded Material	Aluminum and Al. Alloy Sheet / Strip	AxxxP AxxxPC
	Aluminum and Al. Alloy Rod, Bar, and Wire	AxxxBE AxxxBES AxxxBD AxxxBDS AxxxW AxxxWS
	Aluminum and Al. Alloy Extruded Shape	AxxxS
	Aluminum and Al. Alloy Forging	AxxxFD AxxxFH
Magnesium Alloy Expanded Material	Magnesium Alloy Sheet and Plate	MP
	Magnesium Alloy Rod and Bar	MB
Nickel Alloy	Nickel Copper Alloy Sheet and Plate	NCuP
	Nickel Copper Alloy Rod and Bar	NCuB
Titanium Expanded Material	Titanium Rod and Bar	TB
Casting	Brass Casting	CAC20x
	High Strength Brass Casting	CAC30x
	Bronze Casting	CAC40x
	Phosphoric Bronze Casting	CAC50x
	Aluminum Bronze Casting	CAC70x
	Aluminum Alloy Casting	AC
	Magnesium Alloy Casting	MC
	Zinc Alloy Die Casting	ZDCx
	Aluminum Alloy Die Casting	ADC
	Magnesium Alloy Die Casting	MD
	White Metal	WJ

STEEL								
CLASS	GERMANY DIN	UK BS	FRANCE NF	RUSSIA ГОСТ	USA AISI / SAE	JAPAN JIS	CHINA GB	
CARBON STEEL FOR MACHINE STRUCTURAL USE	C10E C10R	040A10 045A10 045M10	XC10		1010	S10C	08 10	
		040A12	XC12		1012	S12C		
	C15E C15R	055M15			1015	S15C	15	
			XC18		1017	S17C		
	C22 C22E C22R	070M20 C22 C22E C22R	C22 C22E C22R		1020	S20C	20	
					1023	S22C		
	C25 C25E C25R	C25 C25E C22R	C25 C25E C25R		1025	S25C	25	
				25Г	1029	S28C		
	C30 C30E C30R	080A30 080M30 C30 C30E C30R	C30 C30E C30R		30Г	1030	S30C	30
				30Г		S33C		
	C35 C35E C35R	C35 C35E C35R	C35 C35E C35R		35Г	1035	S35C	35
				35Г	1038	S38C		
	C40 C40E C40R	080M40 C40 C40E C40R	C40 C40E C40R		40Г	1039 1040	S40C	40
		080A42			40Г	1042 1043	S43C	
	C45 C45E C45R	C45 C45E C45R	C45 C45E C45R		45Г	1045 1046	S45C	45
		080A47			45Г		S48C	
	C50 C50E C50R	080M50 C50 C50E C50R	C50 C50E C50R		50Г	1049	S50C	50
					50Г	1050 1053	S53C	
	C55 C55E C55R	070M55 C55 C55E C55R	C55 C55E C55R			1055	S55C	55
	C60 C60E C60R	C60 C60E C60R	C60 C60E C60R		60Г	1059 1060	S58C	60
C10E	045A10 045M10		XC10			S09CK		
C15E			XC12			S15CK	15F	
			XC18			S20CK		

DRILLS	A
END MILLS	B
ROUTERS	C
THREAD MILLS & TAPS	D
ENGRAVERS	E
BORING BARS	F
REAMERS	G
SAWS	H
TECHNICAL	I
INDEX	J

STEEL													
CLASS	GERMANY DIN	UK BS	FRANCE NF	RUSSIA ГОСТ	USA AISI / SAE	JAPAN JIS	CHINA GB						
A DRILLS	NICKEL CHROMIUM STEEL	36NiCr6			40XH		SNC236						
		14NiCr10					SNC415	12CrNi2					
		36NiCr10			30XH3A			SNC631	30CrNi3				
		15NiCr13	655M13					SNC815	12Cr2Ni4				
		31NiCr14						SNC836	37CrNi3				
B END MILLS	NICKEL CHROMIUM MOLYBDENUM STEEL	20NiCrMo2 20NiCrMoS2	805A20 805M20 805A22 805M22	20NCD 2		8615 8617 8620 8622	SNCM220	20CrNiMo					
		40NiCrMo2-2				8637 8640	SNCM240						
								SNCM415					
		17NiCrMo6-4			20XH2M (20XHM)	4320		SNCM420	18CrNiMnMoA				
		30CrNiMo8						SNCM431					
		40NiCrMo6				4340		SNCM439	40CrNiMoA				
		34CrNiMo6						SNCM447					
								SNCM616					
								SNCM625					
								SNCM630					
C ROUTERS	NICKEL CHROMIUM MOLYBDENUM STEEL						SNCM815						
		D THREAD MILLS & TAPS	NICKEL CHROMIUM MOLYBDENUM STEEL	17Cr3 17CrS3			15X 15XA		SCr415	15Cr 15CrA			
							20X	5120	SCr420	20Cr			
				34Cr4 34CrS4	34Cr4 34CrS4	34Cr4 34CrS4	30X	5130 5132	SCr430	30Cr			
				37Cr4 37CrS4	37Cr4 37CrS4	37Cr4 37CrS4	35X	5132	SCr435	35Cr			
				41Cr4 41CrS4	530M40 41Cr4 41CrS4	41Cr4 41CrS4	40X	5140	SCr440	40Cr			
		E ENGRAVERS	NICKEL CHROMIUM MOLYBDENUM STEEL						SCr445	45Cr 50Cr			
				F BORING BARS	NICKEL CHROMIUM MOLYBDENUM STEEL	15CrMo4					SCM415	15CrMo	
						18CrMo4 18CrMoS4			20XM			SCM418	20CrMo
						20CrMo5	708M20		20XM			SCM420	
										SCM421			
			30XM 30XMA			4131		SCM430	30CrMo 30CrMoA				
G REAMERS	NICKEL CHROMIUM MOLYBDENUM STEEL						SCM432						
		34CrMo4 34CrMoS4	34CrMo4 34CrMoS4	34CrMo4 34CrMoS4	35XM	4137		SCM435	35CrMo				
		42CrMo4 42CrMoS4	708M40 709M40 42CrMo4 42CrMoS4	42CrMo4 42CrMoS4		4140 4142		SCM440	42CrMo				
						4145 4147		SCM445					
								SCM822					
H SAWS	NICKEL CHROMIUM MOLYBDENUM STEEL												
		I TECHNICAL	NICKEL CHROMIUM MOLYBDENUM STEEL										
J INDEX	NICKEL CHROMIUM MOLYBDENUM STEEL												

STEEL								
CLASS	GERMANY DIN	UK BS	FRANCE NF	RUSSIA ГОСТ	USA AISI / SAE	JAPAN JIS	CHINA GB	
MANGANESE CHROMIUM STEEL MANGANESE STEEL	20Mn5	150M19			1522	SMn420	20Mn2	
	34Mn5	150M36		30Г2 35Г2	1534	SMn433	30Mn2 35Mn2	
	36Mn5	150M36		35Г2 40Г2	1541	SMn438	40Mn2	
				40Г2 45Г2	1541	SMn443	45Mn2	
	16MnCr5				5115	SMnC420	15CrMn	
					5140	SMnC443	40CrMn	
STRUCTURAL STEEL WITH SPECIFIED HARDENABILITY BAND (H-SHAPE STEEL)					1522H	SMn420H		
						SMn433H		
					1541H	SMn438H		
					1541H	SMn443H		
						SMnC420H		
						SMnC443H		
	17Cr3 17CrS3				15X		SCr415H	15CrH
	17Cr3				20X	5120H	SCr420H	20Cr1H
	34Cr4 34CrS3	34Cr4 34CrS4	34Cr4 34CrS4		30X	5130H 5132H	SCr430H	
	37Cr4 34CrS4	37Cr4 37CrS4	37Cr4 37CrS4		35X	5135H	SCr435H	
	41Cr4 41CrS4	41Cr4 41CrS4	41Cr4 41CrS4		40X	5140H	SCr440H	40CrH
	15CrMo5					4118H	SCN415H	15CrMoH
	18CrMo4 18CrMoS4						SCM418H	
	18CrMo4	708H20				4118H	SCM420H	20CrMoH
	34CrMo4 34CrMoS4	34CrMo4 34CrMoS4	34CrMo4 34CrMoS4			4135H 4137H	SCM435H	
	42CrMo4 42CrMoS4	42CrMo4 42CrMoS4	42CrMo4 42CrMoS4			4140H 4142H	SCM440H	
						4145H 4147H	SCM445H	
							SCM822H	
							SNC415H	
							SNC631H	
	15NiCr13	655H13					SNC815H	12Cr2Ni4H
	21NiCrMo2	805H17 805H20 805H22		20N CD 2		8617H 8620H 8622H	SNCM220H	20CrNiMoH
	20NiCrMoS6-4					4320H	SNCM420H	20CrNi2MoH

DRILLS	A
END MILLS	B
ROUTERS	C
THREAD MILLS & TAPS	D
ENGRAVERS	E
BORING BARS	F
REAMERS	G
SAWS	H
TECHNICAL	I
INDEX	J



STEEL								
CLASS	GERMANY DIN	UK BS	FRANCE NF	RUSSIA ГОСТ	USA		JAPAN JIS	CHINA GB
					UNS	AISI		
A		284S16	Z12CMN17-07Az		S20100	201	SUS 201	1Cr17Mn6Ni5N
				12X17T9AH4	S20200	202	SUS 202	1Cr18Mn8Ni5N
B	X12CrNi17 7	301S21	Z11CN17-08	07X16H6	S30100	301	SUS 301	1Cr18Mn10Ni5Mo3N 1Cr17Ni7
	X2CrNiN18-7						SUS 301L	
C	X12CrNi17 7						SUS 301J1	
		302S25	Z12CN18-09	12X18H9	S30200	302	SUS 302	1Cr18Ni9
D					S30215	302B	SUS 302B	
	X10CrNiS18 9	303S21	Z8CNF18-09		S30300	303	SUS 303	Y1Cr18Ni9
E		303S41		12X18H10E	S30323	303Se	SUS 303Se	Y1Cr18Ni9Se
	X5CrNi18 10	304S31	Z7CN18-09	08X18H10	S30400	304	SUS 304	0Cr18Ni9
F	X2CrNi19 11	304S11	Z3CN19-11	03X18H11	S30403	304L	SUS 304L	00Cr18Ni10
			Z6CN19-09Az		S30451	304N	SUS 304N1	0Cr18Ni9N
G					S30452		SUS 304N2	0Cr19Ni10NbN
	X2CrNiN18 10		Z3CN18-10Az		S30453	304LN	SUS 304LN	00Cr18Ni10N
H							SUS 304J1	
							SUS 304J2	
I					S30431	S30431	SUS 304J3	
	X5CrNi18 12	305S19	Z8CN18-12	06X18H11	S30500	305	SUS 305	1Cr18Ni12
J							SUS 305J1	
			Z10CN24-13		S30908	309S	SUS 309S	0Cr23Ni13
K		310S31	Z8CN25-20	10X23H18	S31008	310S	SUS 310S	0Cr25Ni20
	X5CrNiMo17 12 2	316S31	Z7CND17-12-02		S31600	316	SUS 316	0Cr17Ni12Mo2
L	X5CrNiMo17 13 3		Z6CND18-12-03					
	X2CrNiMo17 13 2	316S11	Z3CND17-12-02		S31603	316L	SUS 316L	00Cr17Ni14Mo2
M	X2CrNiMo17 14 3		Z3CND17-13-03	03X17H14M3				
					S31651	316N	SUS 316N	0Cr17Ni12Mo2N
N	X2CrNiMoN17 12 2		Z3CND17-11Az		S31653	316LN	SUS 316LN	00Cr17Ni13Mo2N
	X2CrNiMoN17 13 3		Z3CND17-12Az					
O	X6CrNiMoTi17 12 2		Z6CNDT17-12	08X17H13M2T	S31635		SUS 316Ti	
							SUS 316J1	0Cr18Ni12Mo2Cu2
P							SUS 316J1L	00Cr18Ni14Mo2Cu2
		317S16			S31700	317	SUS 317	0Cr19Ni13Mo3
Q	X2CrNiMo18 16 4	317S12	Z3CND19-15-04		S31703	317L	SUS 317L	00Cr19Ni13Mo3
			Z3CND19-14Az		S31753		SUS 317LN	
R							SUS 317J1	0Cr18Ni16Mo5
							SUS 317J2	
S							SUS 317J3L	
					N08367		SUS 836L	
T		904S14	Z2NCDU25-20		N08904	N08904	SUS 890L	
	X6CrNiTi18 10	321S31	Z6CNT18-10	08X18H10T	S32100	321	SUS 321	1Cr18Ni9Ti 0Cr18Ni10Ti
U	X6CrNiNb18 10	347S31	Z6CNNb18-10	08X18H12B	S34700	347	SUS 347	0Cr18Ni11Nb
			Z6CN18-16		S38400	384	SUS 384	
V		394S17	Z2CNU18-10		S30430	304Cu	SUS XM7	0Cr18Ni9Cu3
			Z15CNS20-12		S38100		SUS XM15J1	0Cr18Ni13Si4
W					S32900	329	SUS 329J1	0Cr26Ni5Mo2
			Z3CNDU22-05Az	08X21H6M2T	S39240	S31803	SUS 329J3L	
X			Z3CNDU25-07Az		S39275	S31260	SUS 329J4L	

STAINLESS STEEL

STEEL								
CLASS	GERMANY DIN	UK BS	FRANCE NF	RUSSIA ГОСТ	USA		JAPAN JIS	CHINA GB
					UNS	AISI		
STAINLESS STEEL	X6CrAl13	405S17	Z8CA12		S40500	405	SUS 405	0Cr13Al 0Cr13
			Z3C14				SUS 410L	00Cr12
					S42900	429	SUS 429	
	X6Cr17	430S17	Z8C17	12X17	S43000	430	SUS 430	1Cr17
	X7CrMoS18		Z8CF17		S43020	430F	SUS 430F	Y1Cr17
	X6CrTi17		Z4CT17		S43035		SUS 430LX	
	X6CrNb17		Z4CNb17				SUS 430J1L	
	X6CrMo17 1	434S17	Z8CD17-01		S43400	434	SUS 434	1Cr17Mo
					S43600	436	SUS 436L	
							SUS 436J1L	
			Z3CDT18-02		S44400	444	SUS 444	
					S44700		SUS 447J1	00Cr30Mo2
			Z1CD26-01		S44627		SUS XM27	00Cr27Mo
					S40300	403	SUS 403	1Cr12
	X10Cr13	410S21	Z13C13		S41000	410	SUS 410	1Cr13
	X6Cr13	403S17	Z8C12	08X13	S41008	410S	SUS 410S	
							SUS 410F2	
	X12CrS13				S41025		SUS 410J1	1Cr13Mo 1Cr12Mo
		416S21	Z11CF13		S41600	416	SUS 416	Y1Cr13
	X20Cr13	420S29	Z20C13	20X13	S42000	420	SUS 420J1	2Cr13
	X30Cr13	420S37	Z33C13	30X13	S42000	420	SUS 420J2	3Cr13
			Z30CF13		S42020	420F	SUS 420F	Y3Cr13
							SUS 420F2	
							SUS 429J1	
	X20CrNi17 2	431S29	Z15CN16-02	20X17H2	S43100	431	SUS 431	1Cr17Ni2
			Z70C15		S44002	440A	SUS 440A	7Cr17
					S44003	440B	SUS 440B	8Cr17
			Z100CD17	95X18	S44004	440C	SUS 440C	9Cr18 11Cr17 9Cr18Mo
				S44020	S44020	SUS 440F	Y11Cr17	
X5CrNiCuNb16-4		Z6CNU17-04		S17400	S17400	SUS 630	0Cr17Ni4CuNb	
X7CrNiAl17 7		Z9CNA17-07	09X17H7 IO	S17700	S17700	SUS 631	0Cr17Ni7Al	
						SUS 632J1		

**Representative Classification of Stainless Steel**

*Stainless Steel (Austenitic Related)*

JIS	
SUS201	SUS309S
SUS202	SUS310S
SUS301	SUS316
SUS302	SUS316L
SUS302B	SUS316N
SUS303	SUS317
SUS303Se	SUS317L
SUS304	SUS321
SUS304L	SUS347
SUS304N1	SUS384
SUS304N2	SUSXM7
SUS305	SUSXM15J1
SUS308	

*Stainless Steel (Ferritic Related)*

JIS
SUS405
SUS429
SUS430
SUS430F
SUS434
SUSXM27

*Stainless Steel (Precipitation Hardened Related)*

JIS
SUS630
SUS631

*Stainless Steel (Martensitic Related)*

JIS
SUS403
SUS410
SUS410S
SUS416
SUS420J1
SUS420F
SUS431
SUS440A
SUS440B
SUS440C
SUS440F

DRILLS **A**  
 END MILLS **B**  
 ROUTERS **C**  
 THREAD MILLS & TAPS **D**  
 ENGRAVERS **E**  
 BORING BARS **F**  
 REAMERS **G**  
 SAWS **H**  
 TECHNICAL **I**  
 INDEX **J**

STEEL								
CLASS	GERMANY DIN	UK BS	FRANCE NF	RUSSIA ГОСТ	USA		JAPAN JIS	CHINA GB
					UNS	AISI		
HEAT RESISTING STEEL		331S42	Z35CNWS14-14	45X14H14B2M			SUH 31	
		349S52	Z52CMN21-09Az				SUH 35	
	X53CrMnNi21-9	349S54	Z55CMN21-09Az	55X20 Г 9AH4	S63008		SUH 36	5Cr21Mn9Ni4N
		381S34			S63017		SUH 37	2Cr21Ni12N
							SUH 38	
		309S24	Z15CN24-13		S30900	309	SUH 309	2Cr23Ni13
	CrNi2520	310S24	Z15CN25-20	20X25H20C2	S31000	310	SUH 310	2Cr25Ni20
			Z12NCS35-16		N08330	N08330	SUH 330	1Cr16Ni35
			Z6NCTV25-20		S66286		SUH 660	0Cr15Ni25Ti2MoAIVB
					R30155		SUH 661	
	CrAl1205						SUH 21	
	X6CrTi12	409S19	Z6CT12		S40900	409	SUH 409	
			Z3CT12				SUH 409L	
			Z12C25	15X28	S44600	446	SUH 446	2Cr25N
	X45CrSi9-3	401S45	Z45CS9		S65007		SUH 1	4Cr9Si2
			Z40CSD10	40X10C2M			SUH 3	4Cr10Si2Mo
		443S65	Z80CSN20-02				SUH 4	8Cr20Si2Ni
				40X 9C2			SUH 11	
			20X12BHMBФP			SUH 600	2Cr12MoVNbN	
				S42200		SUH 616	2Cr12NiMoWV	

**Representative Classification of Heat Resisting Steel**

*Heat Resisting Steel (Austenitic Related)*

JIS
SUH31
SUH35
SUH36
SUH37
SUH38
SUH309
SUH310
SUH330
SUH660
SUH661

*Heat Resisting Steel (Ferritic Related)*

JIS
SUH21
SUH409
SUH446

*Heat Resisting Steel (Martensitic Related)*

JIS
SUH1
SUH3
SUH4
SUH11
SUH600
SUH616

STEEL							
CLASS	GERMANY DIN	UK BS	FRANCE NF	RUSSIA ГОСТ	USA AISI / SAE	JAPAN JIS	CHINA GB
CARBON TOOL STEEL			C140E3U	Y13		SK140 (SK1)	T13
			C120E3U	Y12	W1-11½	SK120 (SK2)	T12
	C105W1		C105E2U	Y11	W1-10	SK105 (SK3)	T11
			C90E2U	Y10	W1-9	SK95 (SK4)	T10
	C80W1		C90E2U C80E2U	Y8Г Y9	W1-8	SK85 (SK5)	T8Mn T9
	C80W1		C80E2U C70E2U	Y8		SK75 (SK6)	T8
	C70W2		C70E2U	Y7		SK65 (SK7)	T7
HIGH SPEED TOOL STEEL		BT1	HS18-0-1	P18	T1	SKH2	W18CrV
	S18-1-2-5	BT4	HS18-1-1-5	P18K5Φ2	T4	SKH3	W18Cr4VCo5
		BT5	HS18-0-2-9	P18K5Φ	T5	SKH4	W18Cr4V2Co8
	S12-1-4-5	BT15	HS12-1-5-5		T15	SKH10	W12Cr4V5Co5
	S6-5-2	BM2	HS6-5-2	P6M5	M2	SKH51	W6Mo5Cr4V2
				P6M5Φ3	M3-1	SKH52	CW6Mo5Cr4V2 W6Mo5Cr4V3
	S6-5-3		HS6-5-3	P6M5Φ3	M3-2	SKH53	CW6Mo5Cr4V3
		BM4	HS6-5-4		M4	SKH54	
	S6-5-2-5	BM35	HS6-5-2-5HC	P6M5K5	M35 M41 M36	SKH55	W6Mo5Cr4V2Co5 W7Mo5Cr4V2Co5
	S10-4-3-10	BT42	HS10-4-3-10			SKH56	
			HS2-9-2		M7	SKH57	
	S2-10-1-8	BM42	HS2-9-1-8		M42	SKH58	W2Mo9Cr4V2
ALLOY TOOL STEEL				XB4	F2	SKS11	
	105WCr6		105WCr5	XBГ		SKS2	
						SKS21	W
						SKS5	
					L6	SKS51	
						SKS7	
			C140E3UCr4	13X		SKS8	Cr06
				6XB2C 5XB2CΦ	S1	SKS4	5CrW2Si 6CrW2Si
				4XB2C	S1	SKS41	4CrW2Si
		BW2	100V2		W2-9½ W2-8	SKS43 SKS44	
				9XBГ		SKS3	9CrWMn
	105WCr6		105WCr5	XBГ		SKS31	CrWMn
						SKS93	
						SKS94	
						SKS95	8MnSi
	X210Cr12	BD3	X200Cr12	X12	D3	SKD1	Cr12
	X153CrMoV12			X12MΦ	D2	SKD10	Cr12Mo1V1
	X153CrMoV12	BD2	X160CrMoV12		D2	SKD11	Cr12MoV
		BA2	X100CrMoV5		A2	SKD12	Cr5Mo1V
			X32WCrV3			SKD4	
X30WCrV9-3	BH21	X30WCrV9		H21	SKD5	3Cr2W8V	
X38CrMoV51	BH11	X38CrMoV5	4X5MΦC	H11	SKD6	4Cr5MoSiV	
X40CrMoV51	BH13	X40CrMoV5	4X5MΦ1C	H13	SKD61	4Cr5MoSiV1	
	BH12	X35CrWMoV5	3X3M3Φ	H12	SKD62		
X32CrMoV33	BH10	32CrMoV12-18		H10	SKD7	4Cr3Mo3SiV	
	BH19			H19	SKD8		
		55CrNiMoV4			SKT3		
55NiCrMoV6	BH224 / 5	55NiCrMoV7	5XHМ		SKT4	5CrNiMo	

DRILLS	<b>A</b>
END MILLS	<b>B</b>
ROUTERS	<b>C</b>
THREAD MILLS & TAPS	<b>D</b>
ENGRAVERS	<b>E</b>
BORING BARS	<b>F</b>
REAMERS	<b>G</b>
SAWS	<b>H</b>
TECHNICAL	<b>I</b>
INDEX	<b>J</b>

STEEL								
CLASS	GERMANY DIN	UK BS	FRANCE NF	RUSSIA ГОСТ	USA AISI / SAE	JAPAN JIS	CHINA GB	
A DRILLS				75 80 85	1075 1078	SUP3		
	56SiCr7		60Si7	60C2		SUP6	55Si2Mn	
	B END MILLS	61SiCr7		60Si7	60C2Г	9260	SUP7	60Si2Mn 60Si2MnA
		55Cr3		55Cr3		5155	SUP9	55CrMnA
	C ROUTERS	55Cr3		60Cr3		5160	SUP9A	60CrMnA
		50CrV4	735A51, 735H51	51CrV4	XΦA50XΓΦA	6150	SUP10	50CrVA
		51CrV4			50XΓP	51B60	SUP11A	60CrMnBA
		54SiCr6	685A57, 685H57	54SiCr6		9254	SUP12	
D THREAD MILLS & TAPS	60CrMn3-2	705A60, 705H60	60CrMo4		4161	SUP13	60CrMnMoA	
					1110	SUM11		
					1108	SUM12	Y12	
					1212	SUM21		
	9SMn28	(230M07)	S250		1213	SUM22	Y15	
	9SMnPb28		S250Pb		12L13	SUM22L	Y12Pb	
					1215	SUM23		
						SUM23L		
	9SMnPb28		S250Pb		12L14	SUM24L	Y15Pb	
	9SMn36		S300			SUM25		
	15S10				1117	SUM31		
						SUM31L		
		210M15, 210A15	(13MF4)			SUM32	Y20	
			(35MF6)		1137	SUM41	Y30 Y35	
E ENGRAVERS			(45MF6.1)		1141	SUM42	Y40Mn	
		(226M44)	(45MF6.3)		1144	SUM43		
F BORING BARS					51100	SUJ1	GCr4	
	100Cr6		100Cr6	ИЦХ15	52100	SUJ2	GCr5	
G REAMERS					ASTM A 485 Grade 1	SUJ3	GCr15SiMn	
						SUJ4	GCr15SiMo	
						SUJ5	GCr18Mo	
H SAWS								
I TECHNICAL								
J INDEX								

CAST IRON							
CLASS	GERMANY DIN	UK BS	FRANCE NF	RUSSIA ГОСТ	USA AISI / SAE	JAPAN JIS	CHINA GB
GRAY CAST IRON		100		CY10	NO.20	FC100	HT100
	GG15	150	FGL150	CY15	NO.30	FC150	HT150
	GG20	200	FGL200	CY20	NO.35	FC200	HT200
	GG25	250	FGL250	CY25	NO.45	FC250	HT250
	GG30	300	FGL300	CY30	NO.50	FC300	HT300
	GG35	350	FGL350	CY35	NO.60	FC350	HT350
	GG40		FGL400	CY40			
NODULAR CAST IRON	GGG40	400/17	FGS370-17	BY40	60-40-18	FCD400	QT400-18
		420/12	FGS400-12	BY45	65-45-12	FCD450	QT450-10
	GGG50	500/7	FGS500-7	BY50	70-50-05	FCD500	QT500-7
	GGG60	600/7	FGS600-2	BY60	80-60-03	FCD600	QT600-3
	GGG70	700/2	FGS700-2	BY70	100-70-03	FCD700	QT700-2
	GGG80	800/2	FGS800-2	BY80	120-90-02	FCD800	QT800-2
	900/2		BY100			QT900-2	

NON-FERROUS METAL							
CLASS	GERMANY DIN	UK BS	FRANCE NF	RUSSIA ГОСТ	USA AISI / SAE	JAPAN JIS	CHINA GB
ALUMINUM ALLOY	A199.99R			A99	1199		1A99
	A199.98R			A97			1A97
				A95			1A95
	A199.90	1080(1A)	1080A	A8		A1080	1A80
	A199.50	1050(1B)	1050A	A5	1050	A1050	1A50
	AlMg2.5	NS4	5052	Amg	5052	A5052	5A02
		NS5		AMg3			5A03
	AlMg5	NB6		AMg5V	5056	A5056	5A05
		NG61	5957		5456	A5556	5A30
	AlCu2.5Mg0.5		2117	D18	2036	A2117	2A01
	AlCuMg1	HF15	2017S	D1		A2017	2A11
	AlCuMg2		2024	D16AVTV	2124	A2024	2A12
					2319		2B16
				AK4		A2N01	2A80
				AK2	2218	A2018	2A90
	AlCuSiMn		2014	AK8	2014	A2014	2A14
		6061	6061		6061	A6061	
	AlZnMgCu1.5		7075	V95P	7175	A7075	7A09
ALUMINUM ALLOY CASTING	G-AlSi7Mg	LM25			356.2	AC4C	ZAISI7Mn
	G-Al12	LM6	A-S12-Y4	AL2	413.2	AC3A	ZAISI12
				AL5	355.2		ZAISI5Cu1Mg
	G-Al12(Cu)				413.0	AC8A	ZAISI2Cu2Mg1
				AL19			ZAlCu5Mn
					201.0		ZAlCu5MnCdVA
	G-AlMg10	LM10	AG11	AL8	520.2		ZAlMg10
G-AlMg5Si			AL13			ZAlMg5Si	

DRILLS **A**

END MILLS **B**

ROUTERS **C**

THREAD MILLS & TAPS **D**

ENGRAVERS **E**

BORING BARS **F**

REAMERS **G**

SAWS **H**

TECHNICAL **I**

INDEX **J**



**KYOCERA Precision Tools, Inc.**  
 Please FAX to (714) 428-3607  
 Attn: QuoteDesk - MIT  
 Email: KPTIQuoteDesk@Kyocera.com  
 Fillable Online Form Available at:  
[www.kyoceraprecisiontools.com/micro/custom-tools](http://www.kyoceraprecisiontools.com/micro/custom-tools)

**CUSTOM DRILL REQUEST**

Date: \_\_\_\_\_ Inquiry or RFQ#: \_\_\_\_\_

**CUSTOMER INFORMATION**

Company Name: \_\_\_\_\_ Phone: \_\_\_\_\_  
 Contact: \_\_\_\_\_ Fax: \_\_\_\_\_  
 Address: \_\_\_\_\_ Email: \_\_\_\_\_  
 City: \_\_\_\_\_ State: \_\_\_\_\_ Zip: \_\_\_\_\_ Country: \_\_\_\_\_  
 Kyocera Distributor Name: \_\_\_\_\_

**TECHNICAL INFORMATION**

Work Piece Information: \_\_\_\_\_ Material Code: \_\_\_\_\_ Hardness (HRc): \_\_\_\_\_  
 Type Holder: \_\_\_\_\_ Special Tolerance? : \_\_\_\_\_

**TOOL INFORMATION**

Similar to Kyocera Part Number: \_\_\_\_\_  
 Similar to Other Supplier Part Number: \_\_\_\_\_  
 Coating Type: \_\_\_\_\_ Coating Length from Tip: \_\_\_\_\_  
 Diameter "D" \_\_\_\_\_ LOC "ℓ" \_\_\_\_\_ Reach "L<sub>1</sub>" \_\_\_\_\_ Shank Diameter "d" \_\_\_\_\_  
 OAL "L" \_\_\_\_\_ # Flutes: \_\_\_\_\_ Point Angle: \_\_\_\_\_ Point Geometry: \_\_\_\_\_  
 End User: \_\_\_\_\_ Est. Yearly Consumption: \_\_\_\_\_ Quantity to Quote: \_\_\_\_\_  
 Additional Information Not Specified Elsewhere:

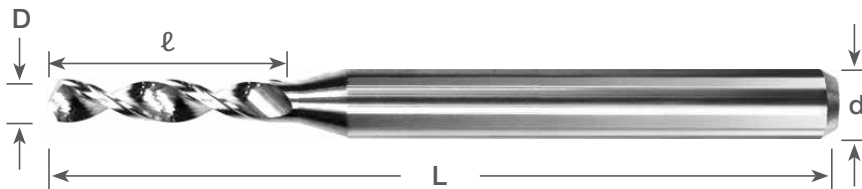



KYOCERA Precision Tools, Inc.  
 Please FAX to (714) 428-3607  
 Attn: QuoteDesk - MIT  
 Email: KPTIQuoteDesk@Kyocera.com  
 Fillable Online Form Available at:  
[www.kyoceraprecisiontools.com/micro/custom-tools](http://www.kyoceraprecisiontools.com/micro/custom-tools)

**CUSTOM REVERSE SHANK DRILL REQUEST**

Date: \_\_\_\_\_ Inquiry or RFQ#: \_\_\_\_\_

**CUSTOMER INFORMATION**

Company Name: \_\_\_\_\_ Phone: \_\_\_\_\_  
 Contact: \_\_\_\_\_ Fax: \_\_\_\_\_  
 Address: \_\_\_\_\_ Email: \_\_\_\_\_  
 City: \_\_\_\_\_ State: \_\_\_\_\_ Zip: \_\_\_\_\_ Country: \_\_\_\_\_  
 Kyocera Distributor Name: \_\_\_\_\_

**TECHNICAL INFORMATION**

Work Piece Information: \_\_\_\_\_ Material Code: \_\_\_\_\_ Hardness (HRC): \_\_\_\_\_  
 Type Holder: \_\_\_\_\_ Special Tolerance? : \_\_\_\_\_

**TOOL INFORMATION**

Similar to Kyocera Part Number: \_\_\_\_\_  
 Similar to Other Supplier Part Number: \_\_\_\_\_  
 Coating Type: \_\_\_\_\_ Coating Length from Tip: \_\_\_\_\_  
 Diameter "D" \_\_\_\_\_ LOC "ℓ" \_\_\_\_\_ Shank Diameter "d" \_\_\_\_\_  
 OAL "L" \_\_\_\_\_ # Flutes: \_\_\_\_\_ Point Angle: \_\_\_\_\_ Point Geometry: \_\_\_\_\_  
 End User: \_\_\_\_\_ Est. Yearly Consumption: \_\_\_\_\_ Quantity to Quote: \_\_\_\_\_  
 Additional Information Not Specified Elsewhere:

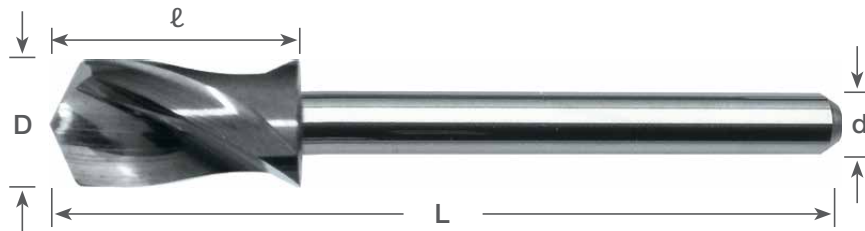





**KYOCERA Precision Tools, Inc.**  
 Please FAX to (714) 428-3607  
 Attn: QuoteDesk - MIT  
 Email: KPTIQuoteDesk@Kyocera.com  
 Fillable Online Form Available at:  
[www.kyoceraprecisiontools.com/micro/custom-tools](http://www.kyoceraprecisiontools.com/micro/custom-tools)

**CUSTOM COOLANT FED DRILL REQUEST**

Date: \_\_\_\_\_ Inquiry or RFQ#: \_\_\_\_\_

**CUSTOMER INFORMATION**

Company Name: \_\_\_\_\_ Phone: \_\_\_\_\_  
 Contact: \_\_\_\_\_ Fax: \_\_\_\_\_  
 Address: \_\_\_\_\_ Email: \_\_\_\_\_  
 City: \_\_\_\_\_ State: \_\_\_\_\_ Zip: \_\_\_\_\_ Country: \_\_\_\_\_  
 Kyocera Distributor Name: \_\_\_\_\_

**TECHNICAL INFORMATION**

Work Piece Information: \_\_\_\_\_ Material Code: \_\_\_\_\_ Hardness (HRC): \_\_\_\_\_  
 Type Holder: \_\_\_\_\_ Special Tolerance? : \_\_\_\_\_

**TOOL INFORMATION**

Similar to Kyocera Part Number: \_\_\_\_\_  
 Similar to Other Supplier Part Number: \_\_\_\_\_  
 Coating Type: \_\_\_\_\_ Coating Length from Tip: \_\_\_\_\_  
 Diameter "D" \_\_\_\_\_ LOC "ℓ" \_\_\_\_\_ Shank Diameter "d" \_\_\_\_\_  
 OAL "L" \_\_\_\_\_ # Flutes: \_\_\_\_\_ Point Angle: \_\_\_\_\_ Point Geometry: \_\_\_\_\_  
 End User: \_\_\_\_\_ Est. Yearly Consumption: \_\_\_\_\_ Quantity to Quote: \_\_\_\_\_  
 Additional Information Not Specified Elsewhere:

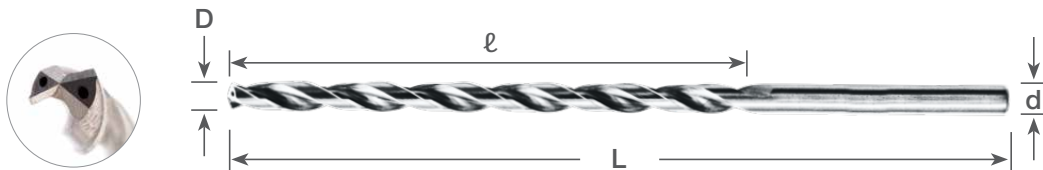



KYOCERA Precision Tools, Inc.  
 Please FAX to (714) 428-3607  
 Attn: QuoteDesk - MIT  
 Email: KPTIQuoteDesk@Kyocera.com  
 Fillable Online Form Available at:  
[www.kyoceraprecisiontools.com/micro/custom-tools](http://www.kyoceraprecisiontools.com/micro/custom-tools)

## CUSTOM STEP DRILL REQUEST

Date: \_\_\_\_\_ Inquiry or RFQ#: \_\_\_\_\_

### CUSTOMER INFORMATION

Company Name: \_\_\_\_\_ Phone: \_\_\_\_\_

Contact: \_\_\_\_\_ Fax: \_\_\_\_\_

Address: \_\_\_\_\_ Email: \_\_\_\_\_

City: \_\_\_\_\_ State: \_\_\_\_\_ Zip: \_\_\_\_\_ Country: \_\_\_\_\_

Kyocera Distributor Name: \_\_\_\_\_

### TECHNICAL INFORMATION

Work Piece Information: \_\_\_\_\_ Material Code: \_\_\_\_\_ Hardness (HRC): \_\_\_\_\_

Type Holder: \_\_\_\_\_ Special Tolerance? : \_\_\_\_\_

### TOOL INFORMATION

Similar to Kyocera Part Number: \_\_\_\_\_

Similar to Other Supplier Part Number: \_\_\_\_\_

Coating Type: \_\_\_\_\_ Coating Length from Tip: \_\_\_\_\_

Diameter "D" \_\_\_\_\_ Diameter "D<sub>1</sub>" \_\_\_\_\_ Step Angle "A" \_\_\_\_\_

LOC "ℓ" \_\_\_\_\_ Reach "L<sub>1</sub>" \_\_\_\_\_ Shank Diameter "d" \_\_\_\_\_

OAL "L" \_\_\_\_\_ # Flutes: \_\_\_\_\_ Point Angle: \_\_\_\_\_ Point Geometry: \_\_\_\_\_

End User: \_\_\_\_\_ Est. Yearly Consumption: \_\_\_\_\_ Quantity to Quote: \_\_\_\_\_

Additional Information Not Specified Elsewhere:

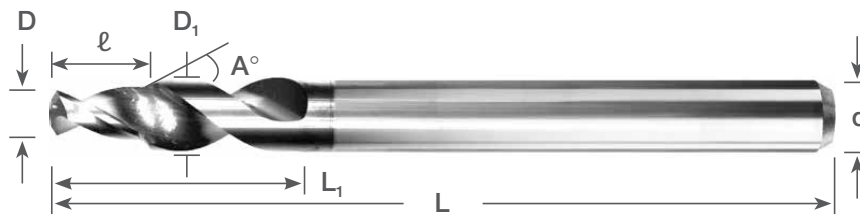



KYOCERA Precision Tools, Inc.  
 Please FAX to (714) 428-3607  
 Attn: QuoteDesk - MIT  
 Email: KPTIQuoteDesk@Kyocera.com  
 Fillable Online Form Available at:  
[www.kyoceraprecisiontools.com/micro/custom-tools](http://www.kyoceraprecisiontools.com/micro/custom-tools)

## CUSTOM SQUARE END MILL REQUEST

Date: \_\_\_\_\_ Inquiry or RFQ#: \_\_\_\_\_

### CUSTOMER INFORMATION

Company Name: \_\_\_\_\_ Phone: \_\_\_\_\_

Contact: \_\_\_\_\_ Fax: \_\_\_\_\_

Address: \_\_\_\_\_ Email: \_\_\_\_\_

City: \_\_\_\_\_ State: \_\_\_\_\_ Zip: \_\_\_\_\_ Country: \_\_\_\_\_

Kyocera Distributor Name: \_\_\_\_\_

### TECHNICAL INFORMATION

Work Piece Information: \_\_\_\_\_ Material Code: \_\_\_\_\_ Hardness (HRC): \_\_\_\_\_

Type Holder: \_\_\_\_\_ Special Tolerance? : \_\_\_\_\_

### TOOL INFORMATION

Similar to Kyocera Part Number: \_\_\_\_\_

Similar to Other Supplier Part Number: \_\_\_\_\_

Coating Type: \_\_\_\_\_ Coating Length from Tip: \_\_\_\_\_

Diameter "D" \_\_\_\_\_ LOC "ℓ" \_\_\_\_\_ Shank Diameter "d" \_\_\_\_\_

OAL "L" \_\_\_\_\_ # Flutes: \_\_\_\_\_

End User: \_\_\_\_\_ Est. Yearly Consumption: \_\_\_\_\_ Quantity to Quote: \_\_\_\_\_

Additional Information Not Specified Elsewhere:

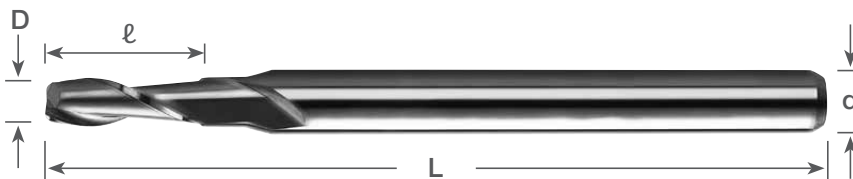



KYOCERA Precision Tools, Inc.  
 Please FAX to (714) 428-3607  
 Attn: QuoteDesk - MIT  
 Email: KPTIQuoteDesk@Kyocera.com  
 Fillable Online Form Available at:  
[www.kyoceraprecisiontools.com/micro/custom-tools](http://www.kyoceraprecisiontools.com/micro/custom-tools)

## CUSTOM BALL NOSE END MILL REQUEST

Date: \_\_\_\_\_ Inquiry or RFQ#: \_\_\_\_\_

### CUSTOMER INFORMATION

Company Name: \_\_\_\_\_ Phone: \_\_\_\_\_

Contact: \_\_\_\_\_ Fax: \_\_\_\_\_

Address: \_\_\_\_\_ Email: \_\_\_\_\_

City: \_\_\_\_\_ State: \_\_\_\_\_ Zip: \_\_\_\_\_ Country: \_\_\_\_\_

Kyocera Distributor Name: \_\_\_\_\_

### TECHNICAL INFORMATION

Work Piece Information: \_\_\_\_\_ Material Code: \_\_\_\_\_ Hardness (HRc): \_\_\_\_\_

Type Holder: \_\_\_\_\_ Special Tolerance? : \_\_\_\_\_

### TOOL INFORMATION

Similar to Kyocera Part Number: \_\_\_\_\_

Similar to Other Supplier Part Number: \_\_\_\_\_

Coating Type: \_\_\_\_\_ Coating Length from Tip: \_\_\_\_\_

Diameter "D" \_\_\_\_\_ LOC "ℓ" \_\_\_\_\_ Shank Diameter "d" \_\_\_\_\_

OAL "L" \_\_\_\_\_ # Flutes: \_\_\_\_\_

End User: \_\_\_\_\_ Est. Yearly Consumption: \_\_\_\_\_ Quantity to Quote: \_\_\_\_\_

Additional Information Not Specified Elsewhere:

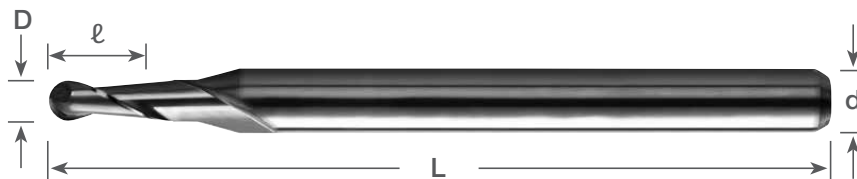



**KYOCERA Precision Tools, Inc.**  
 Please FAX to (714) 428-3607  
 Attn: QuoteDesk - MIT  
 Email: KPTIQuoteDesk@Kyocera.com  
 Fillable Online Form Available at:  
[www.kyoceraprecisiontools.com/micro/custom-tools](http://www.kyoceraprecisiontools.com/micro/custom-tools)

**CUSTOM EXTENDED REACH SQUARE END MILL REQUEST**

Date: \_\_\_\_\_ Inquiry or RFQ#: \_\_\_\_\_

**CUSTOMER INFORMATION**

Company Name: \_\_\_\_\_ Phone: \_\_\_\_\_  
 Contact: \_\_\_\_\_ Fax: \_\_\_\_\_  
 Address: \_\_\_\_\_ Email: \_\_\_\_\_  
 City: \_\_\_\_\_ State: \_\_\_\_\_ Zip: \_\_\_\_\_ Country: \_\_\_\_\_  
 Kyocera Distributor Name: \_\_\_\_\_

**TECHNICAL INFORMATION**

Work Piece Information: \_\_\_\_\_ Material Code: \_\_\_\_\_ Hardness (HRC): \_\_\_\_\_  
 Type Holder: \_\_\_\_\_ Special Tolerance? : \_\_\_\_\_

**TOOL INFORMATION**

Similar to Kyocera Part Number: \_\_\_\_\_  
 Similar to Other Supplier Part Number: \_\_\_\_\_  
 Coating Type: \_\_\_\_\_ Coating Length from Tip: \_\_\_\_\_  
 Diameter "D" \_\_\_\_\_ LOC "ℓ" \_\_\_\_\_ Shank Diameter "d" \_\_\_\_\_  
 OAL "L" \_\_\_\_\_ # Flutes: \_\_\_\_\_ Reach "L<sub>1</sub>" \_\_\_\_\_ Neck Diameter "D<sub>1</sub>" \_\_\_\_\_  
 End User: \_\_\_\_\_ Est. Yearly Consumption: \_\_\_\_\_ Quantity to Quote: \_\_\_\_\_

Additional Information Not Specified Elsewhere:

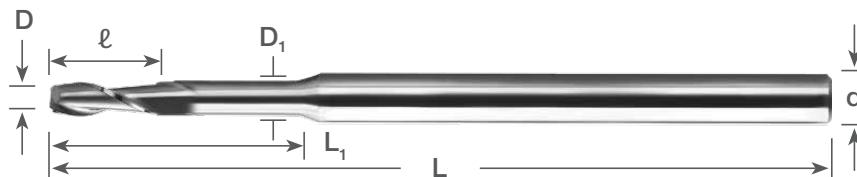



**CUSTOM EXTENDED REACH BALL NOSE END MILL REQUEST**

Date: \_\_\_\_\_ Inquiry or RFQ#: \_\_\_\_\_

**CUSTOMER INFORMATION**

Company Name: \_\_\_\_\_ Phone: \_\_\_\_\_  
 Contact: \_\_\_\_\_ Fax: \_\_\_\_\_  
 Address: \_\_\_\_\_ Email: \_\_\_\_\_  
 City: \_\_\_\_\_ State: \_\_\_\_\_ Zip: \_\_\_\_\_ Country: \_\_\_\_\_  
 Kyocera Distributor Name: \_\_\_\_\_

**TECHNICAL INFORMATION**

Work Piece Information: \_\_\_\_\_ Material Code: \_\_\_\_\_ Hardness (HRC): \_\_\_\_\_  
 Type Holder: \_\_\_\_\_ Special Tolerance? : \_\_\_\_\_

**TOOL INFORMATION**

Similar to Kyocera Part Number: \_\_\_\_\_  
 Similar to Other Supplier Part Number: \_\_\_\_\_  
 Coating Type: \_\_\_\_\_ Coating Length from Tip: \_\_\_\_\_  
 Diameter "D" \_\_\_\_\_ LOC "ℓ" \_\_\_\_\_ Shank Diameter "d" \_\_\_\_\_  
 OAL "L" \_\_\_\_\_ # Flutes: \_\_\_\_\_ Reach "L<sub>1</sub>" \_\_\_\_\_ Neck Diameter "D<sub>1</sub>" \_\_\_\_\_  
 End User: \_\_\_\_\_ Est. Yearly Consumption: \_\_\_\_\_ Quantity to Quote: \_\_\_\_\_

Additional Information Not Specified Elsewhere:

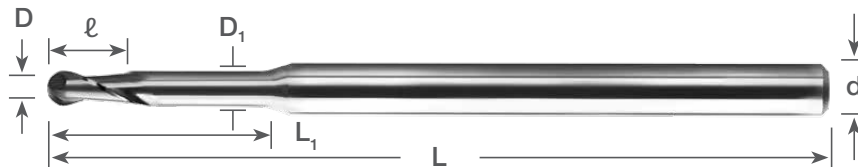



KYOCERA Precision Tools, Inc.  
 Please FAX to (714) 428-3607  
 Attn: QuoteDesk - MIT  
 Email: KPTIQuoteDesk@Kyocera.com  
 Fillable Online Form Available at:  
[www.kyoceraprecisiontools.com/micro/custom-tools](http://www.kyoceraprecisiontools.com/micro/custom-tools)

## CUSTOM CORNER RADIUS END MILL REQUEST

Date: \_\_\_\_\_ Inquiry or RFQ#: \_\_\_\_\_

### CUSTOMER INFORMATION

Company Name: \_\_\_\_\_ Phone: \_\_\_\_\_

Contact: \_\_\_\_\_ Fax: \_\_\_\_\_

Address: \_\_\_\_\_ Email: \_\_\_\_\_

City: \_\_\_\_\_ State: \_\_\_\_\_ Zip: \_\_\_\_\_ Country: \_\_\_\_\_

Kyocera Distributor Name: \_\_\_\_\_

### TECHNICAL INFORMATION

Work Piece Information: \_\_\_\_\_ Material Code: \_\_\_\_\_ Hardness (HRC): \_\_\_\_\_

Type Holder: \_\_\_\_\_ Special Tolerance? : \_\_\_\_\_

### TOOL INFORMATION

Similar to Kyocera Part Number: \_\_\_\_\_

Similar to Other Supplier Part Number: \_\_\_\_\_

Coating Type: \_\_\_\_\_ Coating Length from Tip: \_\_\_\_\_

Diameter "D" \_\_\_\_\_ LOC "ℓ" \_\_\_\_\_ Shank Diameter "d" \_\_\_\_\_

OAL "L" \_\_\_\_\_ # Flutes: \_\_\_\_\_ Corner Radius "r" \_\_\_\_\_

End User: \_\_\_\_\_ Est. Yearly Consumption: \_\_\_\_\_ Quantity to Quote: \_\_\_\_\_

Additional Information Not Specified Elsewhere:

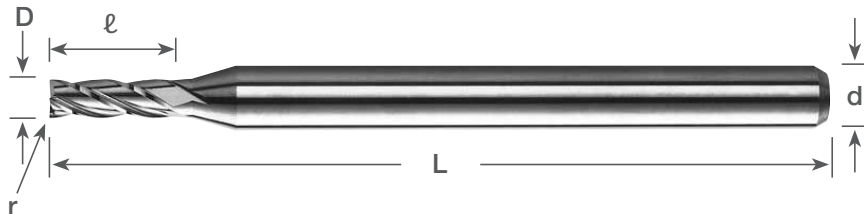

## CUSTOM TAPERED END MILL REQUEST

Date: \_\_\_\_\_ Inquiry or RFQ#: \_\_\_\_\_

### CUSTOMER INFORMATION

Company Name: \_\_\_\_\_ Phone: \_\_\_\_\_

Contact: \_\_\_\_\_ Fax: \_\_\_\_\_

Address: \_\_\_\_\_ Email: \_\_\_\_\_

City: \_\_\_\_\_ State: \_\_\_\_\_ Zip: \_\_\_\_\_ Country: \_\_\_\_\_

Kyocera Distributor Name: \_\_\_\_\_

### TECHNICAL INFORMATION

Work Piece Information: \_\_\_\_\_ Material Code: \_\_\_\_\_ Hardness (HRC): \_\_\_\_\_

Type Holder: \_\_\_\_\_ Special Tolerance? : \_\_\_\_\_

### TOOL INFORMATION

Similar to Kyocera Part Number: \_\_\_\_\_

Similar to Other Supplier Part Number: \_\_\_\_\_

Coating Type: \_\_\_\_\_ Coating Length from Tip: \_\_\_\_\_

Diameter "D" \_\_\_\_\_ Taper Angle "A": \_\_\_\_\_ Shoulder Angle "A<sub>1</sub>" 15°

LOC "ℓ" \_\_\_\_\_ Taper Length "L<sub>1</sub>" \_\_\_\_\_ Shank Diameter "d" \_\_\_\_\_

OAL "L" \_\_\_\_\_ # Flutes: \_\_\_\_\_ Helix Angle: Variable End Style: Square

End User: \_\_\_\_\_ Est. Yearly Consumption: \_\_\_\_\_ Quantity to Quote: \_\_\_\_\_

Additional Information Not Specified Elsewhere:

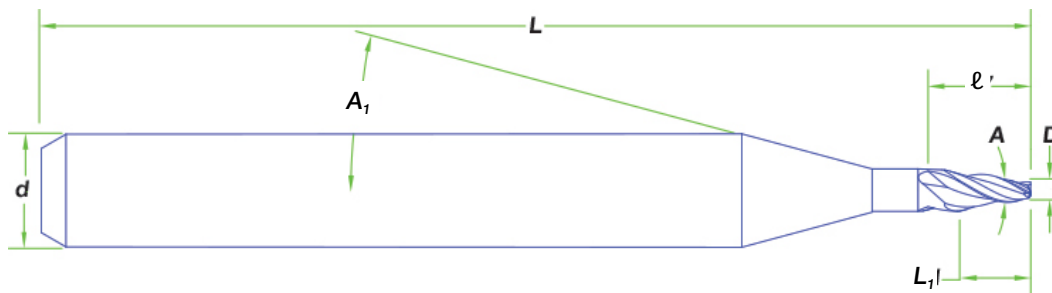





**KYOCERA Precision Tools, Inc.**  
 Please FAX to (714) 428-3607  
 Attn: QuoteDesk - MIT  
 Email: KPTIQuoteDesk@Kyocera.com  
 Fillable Online Form Available at:  
[www.kyoceraprecisiontools.com/micro/custom-tools](http://www.kyoceraprecisiontools.com/micro/custom-tools)

**CUSTOM REAMER REQUEST**

Date: \_\_\_\_\_ Inquiry or RFQ#: \_\_\_\_\_

**CUSTOMER INFORMATION**

Company Name: \_\_\_\_\_ Phone: \_\_\_\_\_  
 Contact: \_\_\_\_\_ Fax: \_\_\_\_\_  
 Address: \_\_\_\_\_ Email: \_\_\_\_\_  
 City: \_\_\_\_\_ State: \_\_\_\_\_ Zip: \_\_\_\_\_ Country: \_\_\_\_\_  
 Kyocera Distributor Name: \_\_\_\_\_

**TECHNICAL INFORMATION**

Work Piece Information: \_\_\_\_\_ Material Code: \_\_\_\_\_ Hardness (HRC): \_\_\_\_\_  
 Type Holder: \_\_\_\_\_ Special Tolerance? : \_\_\_\_\_

**TOOL INFORMATION**

Similar to Kyocera Part Number: \_\_\_\_\_  
 Similar to Other Supplier Part Number: \_\_\_\_\_  
 Coating Type: \_\_\_\_\_ Coating Length from Tip: \_\_\_\_\_  
 Diameter "D" \_\_\_\_\_ LOC "ℓ" \_\_\_\_\_ Shank Diameter "d" \_\_\_\_\_  
 OAL "L" \_\_\_\_\_ # Flutes: \_\_\_\_\_ Reach "R" \_\_\_\_\_  
 Direction of Cut: \_\_\_\_\_ Direction of Spiral: \_\_\_\_\_ Coolant Holes: \_\_\_\_\_  
 End User: \_\_\_\_\_ Est. Yearly Consumption: \_\_\_\_\_ Quantity to Quote: \_\_\_\_\_

Additional Information Not Specified Elsewhere:

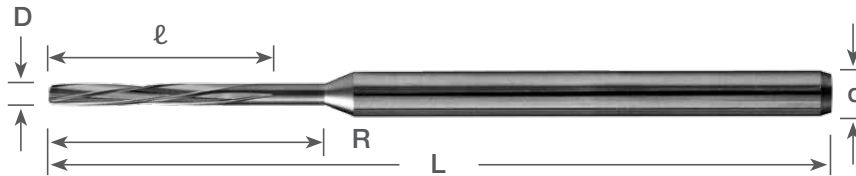



KYOCERA Precision Tools, Inc.  
 Please FAX to (714) 428-3607  
 Attn: QuoteDesk - MIT  
 Email: KPTIQuoteDesk@Kyocera.com  
 Fillable Online Form Available at:  
[www.kyoceraprecisiontools.com/micro/custom-tools](http://www.kyoceraprecisiontools.com/micro/custom-tools)

**CUSTOM ROUTER REQUEST**

Date: \_\_\_\_\_ Inquiry or RFQ#: \_\_\_\_\_

**CUSTOMER INFORMATION**

Company Name: \_\_\_\_\_ Phone: \_\_\_\_\_  
 Contact: \_\_\_\_\_ Fax: \_\_\_\_\_  
 Address: \_\_\_\_\_ Email: \_\_\_\_\_  
 City: \_\_\_\_\_ State: \_\_\_\_\_ Zip: \_\_\_\_\_ Country: \_\_\_\_\_  
 Kyocera Distributor Name: \_\_\_\_\_

**TECHNICAL INFORMATION**

Work Piece Information: \_\_\_\_\_ Material Code: \_\_\_\_\_ Hardness (HRC): \_\_\_\_\_  
 Type Holder: \_\_\_\_\_ Special Tolerance? : \_\_\_\_\_

**TOOL INFORMATION**

Similar to Kyocera Part Number: \_\_\_\_\_  
 Similar to Other Supplier Part Number: \_\_\_\_\_  
 Coating Type: \_\_\_\_\_ Coating Length from Tip: \_\_\_\_\_  
 Diameter "D" \_\_\_\_\_ LOC "ℓ" \_\_\_\_\_ Shank Diameter "d" \_\_\_\_\_  
 OAL "L" \_\_\_\_\_ Pattern: \_\_\_\_\_ Cut: \_\_\_\_\_ End Style: \_\_\_\_\_  
 End User: \_\_\_\_\_ Est. Yearly Consumption: \_\_\_\_\_ Quantity to Quote: \_\_\_\_\_

Additional Information Not Specified Elsewhere:



### CUSTOM BORING BAR TOOL REQUEST

Date: \_\_\_\_\_ Inquiry or RFQ#: \_\_\_\_\_

#### CUSTOMER INFORMATION

Company Name: \_\_\_\_\_ Phone: \_\_\_\_\_

Contact: \_\_\_\_\_ Fax: \_\_\_\_\_

Address: \_\_\_\_\_ Email: \_\_\_\_\_

City: \_\_\_\_\_ State: \_\_\_\_\_ Zip: \_\_\_\_\_ Country: \_\_\_\_\_

Kyocera Distributor Name: \_\_\_\_\_

#### TECHNICAL INFORMATION

Work Piece Information: \_\_\_\_\_ Material Code: \_\_\_\_\_ Hardness (HRc): \_\_\_\_\_

Type Holder: \_\_\_\_\_ Special Tolerance? : \_\_\_\_\_

#### TOOL INFORMATION

Similar to Kyocera Part Number: \_\_\_\_\_

Similar to Other Supplier Part Number: \_\_\_\_\_

Coating Type: \_\_\_\_\_ Coating Length from Tip: \_\_\_\_\_ Radius: \_\_\_\_\_

Tip Diameter "D" \_\_\_\_\_ Body Diameter "D<sub>1</sub>" \_\_\_\_\_ Shank Diameter "d" \_\_\_\_\_

OAL "L" \_\_\_\_\_ Reach "L<sub>1</sub>" \_\_\_\_\_ Tip Length "ℓ" \_\_\_\_\_

Shoulder Angle "A" \_\_\_\_\_ End Angle "A<sub>1</sub>" \_\_\_\_\_ Side Angle "A<sub>2</sub>" \_\_\_\_\_ Split Angle "A<sub>3</sub>" \_\_\_\_\_

End User: \_\_\_\_\_ Est. Yearly Consumption: \_\_\_\_\_ Quantity to Quote: \_\_\_\_\_

Additional Information Not Specified Elsewhere:

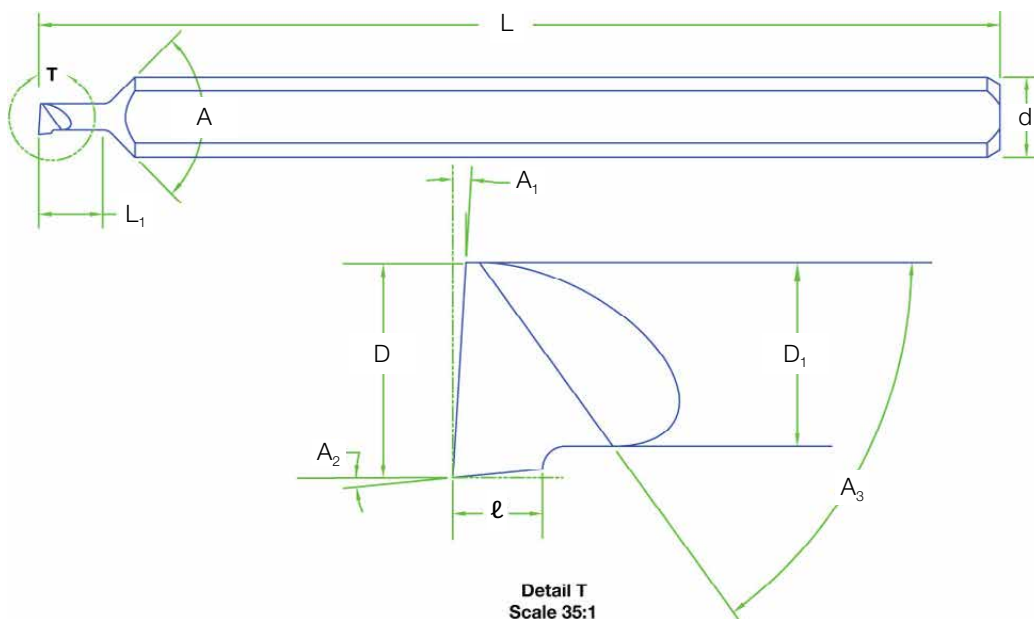



## CUSTOM GROOVE TOOL REQUEST

Date: \_\_\_\_\_ Inquiry or RFQ#: \_\_\_\_\_

### CUSTOMER INFORMATION

Company Name: \_\_\_\_\_ Phone: \_\_\_\_\_

Contact: \_\_\_\_\_ Fax: \_\_\_\_\_

Address: \_\_\_\_\_ Email: \_\_\_\_\_

City: \_\_\_\_\_ State: \_\_\_\_\_ Zip: \_\_\_\_\_ Country: \_\_\_\_\_

Kyocera Distributor Name: \_\_\_\_\_

### TECHNICAL INFORMATION

Work Piece Information: \_\_\_\_\_ Material Code: \_\_\_\_\_ Hardness [HRC]: \_\_\_\_\_

Type Holder: \_\_\_\_\_ Special Tolerance? : \_\_\_\_\_

### TOOL INFORMATION

Similar to Kyocera Part Number: \_\_\_\_\_

Similar to Other Supplier Part Number: \_\_\_\_\_

Coating Type: \_\_\_\_\_ Coating Length from Tip: \_\_\_\_\_ Groove Type 1, 2, 3: \_\_\_\_\_

Tip Diameter "D" \_\_\_\_\_ Body Diameter "D<sub>1</sub>" \_\_\_\_\_ Shank Diameter "d" \_\_\_\_\_

OAL "L" \_\_\_\_\_ Reach "L<sub>1</sub>" \_\_\_\_\_ Tip Width "ℓ" \_\_\_\_\_ Side Clearance: \_\_\_\_\_

Groove Depth: \_\_\_\_\_ Radius Front Side: \_\_\_\_\_ Radius Back Side: \_\_\_\_\_ Full Radius: \_\_\_\_\_

End User: \_\_\_\_\_ Est. Yearly Consumption: \_\_\_\_\_ Quantity to Quote: \_\_\_\_\_

Additional Information Not Specified Elsewhere:

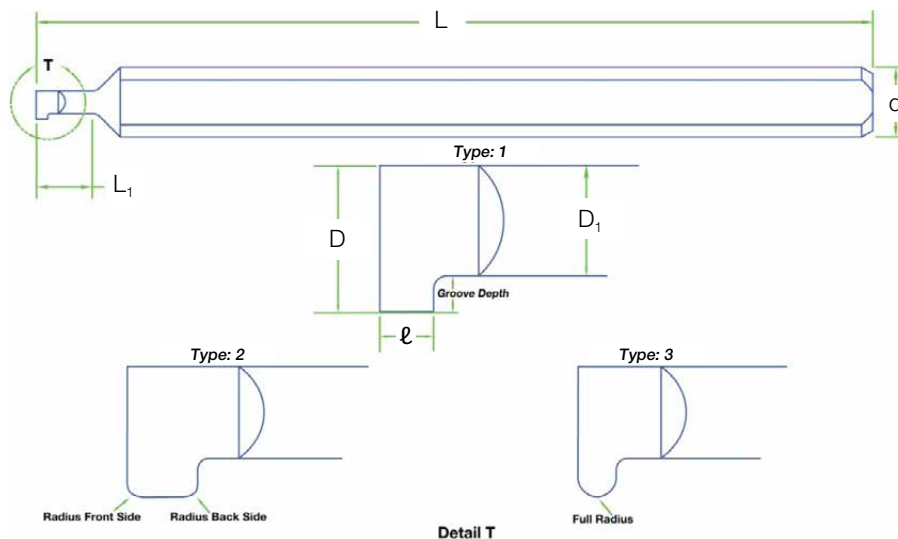

For groove shapes not shown above, please submit a sketch of the shape of groove desired.



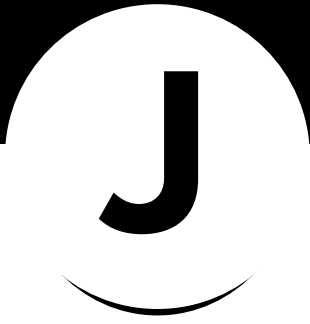

# INDEX

J1 - J3

*Listed in Alphanumeric Order*

## Part Numbers in Alphanumeric Order

○ : NUMBER □ : LETTER

- ...○○.○○... → Uncoated
- ...○○○○○○... → DLC Coating
- ...○○○○○○... → AlTiN Coating
- ...○○○○○○... → AlTiN NANO Coating
- ...○○○○○○... → AX Coating
- ...○○○○○○... → CVD Diamond

Part Number	Page	Category
080 -○○○○.90	A2	Spotting Drill (90° Point)
080 -○○○○.130	A2	Spotting Drill (130° Point)
081 -○○○○L90	A3	Spotting Drill
081 -○○○○L130	A3	Spotting Drill
105 -○○○○.○○○	A4 - A9	Micro Drill
105 -○○○○○○○○	A4 - A9	Micro Drill
14 ○○○	D6 - D21	Special Taps
155 -○○○○.○○○	A10 - A13	Inverse Dia. Micro Drill
160 -○○○○AG○○○(○)	A14	ORION High Performance Pilot Drill
1610 -○○○○.○○○	B3 - B6	Standard Length Square End Mill (2 Flute)
1610 -○○○○○○○○	B3 - B5	Standard Length Square End Mill (2 Flute)
1610 -○○○○○○○○	B3 - B6	Standard Length Square End Mill (2 Flute)
1611 -○○○○.○○○CR	B65	Standard Length X-Small Corner Radius End Mill (2 Flute)
1611 -○○○○○○○○CR	B65	Standard Length X-Small Corner Radius End Mill (2 Flute)
1611 -○○○○○○○○CR	B65	Standard Length X-Small Corner Radius End Mill (2 Flute)
1612 -○○○○.○○○CR	B66	Standard Length Small Corner Radius End Mill (2 Flute)
1612 -○○○○○○○○CR	B66	Standard Length Small Corner Radius End Mill (2 Flute)
1612 -○○○○○○○○CR	B66	Standard Length Small Corner Radius End Mill (2 Flute)
1612 -○○○○○○○○CR	B66	Standard Length Small Corner Radius End Mill (2 Flute)
1613 -○○○○.○○○CR	B67	Standard Length Standard Corner Radius End Mill (2 Flute)
1613 -○○○○○○○○CR	B67	Standard Length Standard Corner Radius End Mill (2 Flute)
1613 -○○○○○○○○CR	B67	Standard Length Standard Corner Radius End Mill (2 Flute)
1613 -○○○○○○○○CR	B67	Standard Length Standard Corner Radius End Mill (2 Flute)
1614 -○○○○.○○○CR	B68	Standard Length Large Corner Radius End Mill (2 Flute)
1614 -○○○○○○○○CR	B68	Standard Length Large Corner Radius End Mill (2 Flute)
1614 -○○○○○○○○CR	B68	Standard Length Large Corner Radius End Mill (2 Flute)
1614 -○○○○○○○○CR	B68	Standard Length Large Corner Radius End Mill (2 Flute)
1616 -○○○○.○○○(○)C(R)	B68	Standard Length X-Large Corner Radius End Mill (2 Flute)
1616 -○○○○○○○○(○)C(R)	B68	Standard Length X-Large Corner Radius End Mill (2 Flute)
1616 -○○○○○○○○(○)C(R)	B68	Standard Length X-Large Corner Radius End Mill (2 Flute)
1617 -○○○○.○○○CR	B69	Standard Length XX-Large Corner Radius End Mill (2 Flute)
1617 -○○○○○○○○CR	B69	Standard Length XX-Large Corner Radius End Mill (2 Flute)
1617 -○○○○○○○○CR	B69	Standard Length XX-Large Corner Radius End Mill (2 Flute)
1618 -○○○○.○○○(○)C(R)	B69	Standard Length XXX-Large Corner Radius End Mill (2 Flute)
1618 -○○○○○○○○(○)C(R)	B69	Standard Length XXX-Large Corner Radius End Mill (2 Flute)
1618 -○○○○○○○○(○)C(R)	B69	Standard Length XXX-Large Corner Radius End Mill (2 Flute)
1618 -○○○○○○○○(○)C(R)	B69	Standard Length XXX-Large Corner Radius End Mill (2 Flute)
1620 -○○○○.○○○	B7 - B10	Stub Length Square End Mill (2 Flute)
1620 -○○○○○○○○	B7 - B9	Stub Length Square End Mill (2 Flute)
1620 -○○○○○○○○	B7 - B10	Stub Length Square End Mill (2 Flute)
1625 -○○○○.○○○	B35 - B38	Standard Length Ball Nose End Mill (2 Flute)
1625 -○○○○○○○○	B35 - B37	Standard Length Ball Nose End Mill (2 Flute)
1625 -○○○○○○○○	B46	Hard Metal Milling Ball Nose End Mill (2 Flute)
1625 -○○○○○○○○	B47	Hard Metal Milling Extended Reach Ball Nose End Mill (2 Flute)

Part Number	Page	Category
1625 -○○○○○○○○	B35 - B38	Standard Length Ball Nose End Mill (2 Flute)
1635 -○○○○.○○○	B39 - B41	Stub Length Ball Nose End Mill (2 Flute)
1635 -○○○○○○○○	B39 - B40	Stub Length Ball Nose End Mill (2 Flute)
1635 -○○○○○○○○	B39 - B41	Stub Length Ball Nose End Mill (2 Flute)
1640 -○○○○.○○○	B11 - B13	Extended Reach Square End Mill (2 Flute)
1640 -○○○○○○○○	B11 - B13	Extended Reach Square End Mill (2 Flute)
1645 -○○○○.○○○(○)	B42 - B44	Extended Reach Ball Nose End Mill (2 Flute)
1645 -○○○○○○○○(○)	B42 - B43	Extended Reach Ball Nose End Mill (2 Flute)
1645 -○○○○○○○○(○)	B42 - B44	Extended Reach Ball Nose End Mill (2 Flute)
165 -○○○○AG○○○(○)	A15 - A18	ORION High Performance Pilot Drill
1685 -○○○○.○○○(○)□	B45	Reverse Shank Ball Nose End Mill (2 Flute)
1685 -○○○○○○○○(○)□	B45	Reverse Shank Ball Nose End Mill (2 Flute)
16RB ○○○○U-○(○)	B48	Rib Processing Ball Nose End Mill (2 Flute)
1703 -○○○○.○○○OR	B70	Standard Length High Helix Corner Radius End Mill (3 Flute)
1703 -○○○○○○○○OR	B70	Standard Length High Helix Corner Radius End Mill (3 Flute)
1710 -○○○○.○○○	B16 - B17	Standard Length Square End Mill (2 Flute)
1710 -○○○○○○○○	B16 - B17	Standard Length Square End Mill (3 Flute)
1710 -○○○○○○○○	B16 - B17	Standard Length Square End Mill (3 Flute)
1710 -○○○○○○○○	B16 - B17	Standard Length Square End Mill (3 Flute)
1725 -○○○○.○○○	B49	Standard Length Ball Nose End Mill (3 Flute)
1725 -○○○○○○○○	B49	Standard Length Ball Nose End Mill (3 Flute)
1725 -○○○○○○○○	B49	Standard Length Ball Nose End Mill (3 Flute)
1740 -○○○○.○○○(○)	B18 - B19	Extended Reach Square End Mill (3 Flute)
1740 -○○○○○○○○(○)	B18 - B19	Extended Reach Square End Mill (3 Flute)
1740 -○○○○○○○○(○)	B18 - B19	Extended Reach Square End Mill (3 Flute)
1742 -○○○○.○○○(○)	B20 - B24	Extended Reach Stub Length Square End Mill (3 Flute)
1742 -○○○○○○○○(○)	B20 - B24	Extended Reach Stub Length Square End Mill (3 Flute)
1742 -○○○○○○○○(○)	B20 - B24	Extended Reach Stub Length Square End Mill (3 Flute)
1742 -○○○○○○○○(○)	B20 - B24	Extended Reach Stub Length Square End Mill (3 Flute)
1743 -○○○○.○○○(○)C(R)	B74	Extended Reach Small Corner Radius End Mill (3 Flute)
1743 -○○○○○○○○(○)C(R)	B74	Extended Reach Small Corner Radius End Mill (3 Flute)
1743 -○○○○○○○○(○)C(R)	B74	Extended Reach Small Corner Radius End Mill (3 Flute)
1743 -○○○○○○○○(○)C(R)	B74	Extended Reach Small Corner Radius End Mill (3 Flute)
1744 -○○○○.○○○(○)C(R)	B75	Extended Reach Standard Corner Radius End Mill (3 Flute)
1744 -○○○○○○○○(○)C(R)	B75	Extended Reach Standard Corner Radius End Mill (3 Flute)
1744 -○○○○○○○○(○)C(R)	B75	Extended Reach Standard Corner Radius End Mill (3 Flute)
1745 -○○○○.○○○(○)	B50	Extended Reach Ball Nose End Mill (3 Flute)
1745 -○○○○○○○○(○)	B50	Extended Reach Ball Nose End Mill (3 Flute)
1745 -○○○○○○○○(○)	B50	Extended Reach Ball Nose End Mill (3 Flute)
1746 -○○○○.○○○(○)C(R)	B76	Extended Reach Large Corner Radius End Mill (3 Flute)
1746 -○○○○○○○○(○)C(R)	B76	Extended Reach Large Corner Radius End Mill (3 Flute)
1746 -○○○○○○○○(○)C(R)	B76	Extended Reach Large Corner Radius End Mill (3 Flute)
1746 -○○○○○○○○(○)C(R)	B76	Extended Reach Large Corner Radius End Mill (3 Flute)
1755 -○○○○.○○○(○)	B51 - B54	Extended Reach Stub Length Ball Nose End Mill (3 Flute)
1755 -○○○○○○○○(○)	B51 - B54	Extended Reach Stub Length Ball Nose End Mill (3 Flute)
1755 -○○○○○○○○(○)	B51 - B54	Extended Reach Stub Length Ball Nose End Mill (3 Flute)
1804 -○○○○.○○○OR	B77	Standard Length High Helix Corner Radius End Mill (4 Flute)
1804 -○○○○○○○○OR	B77	Standard Length High Helix Corner Radius End Mill (4 Flute)
1810 -○○○○.○○○(○)	B25 - B28	Standard Length Square End Mill (4 Flute)
1810 -○○○○○○○○(○)	B25 - B27	Standard Length Square End Mill (4 Flute)

## Part Numbers in Alphanumeric Order

○ : NUMBER □ : LETTER

Part Number	Page	Category
1810 -○○○○○○○○(○)	B25 - B28	Standard Length Square End Mill (4 Flute)
1812 -○○○○.○○○CR	B78	Standard Length Small Corner Radius End Mill (4 Flute)
1812 -○○○○○○○○○CR	B78	Standard Length Small Corner Radius End Mill (4 Flute)
1812 -○○○○○○○○○CR	B78	Standard Length Small Corner Radius End Mill (4 Flute)
1813 -○○○○.○○○CR	B79	Standard Length Standard Corner Radius End Mill (4 Flute)
1813 -○○○○○○○○○CR	B79	Standard Length Standard Corner Radius End Mill (4 Flute)
1813 -○○○○○○○○○CR	B79	Standard Length Standard Corner Radius End Mill (4 Flute)
1814 -○○○○.○○○CR	B80	Standard Length Large Corner Radius End Mill (4 Flute)
1814 -○○○○○○○○○CR	B80	Standard Length Large Corner Radius End Mill (4 Flute)
1814 -○○○○○○○○○CR	B80	Standard Length Large Corner Radius End Mill (4 Flute)
1816 -○○○○.○○○CR	B80	Standard Length X-Large Corner Radius End Mill (4 Flute)
1816 -○○○○○○○○○CR	B80	Standard Length X-Large Corner Radius End Mill (4 Flute)
1816 -○○○○○○○○○CR	B80	Standard Length X-Large Corner Radius End Mill (4 Flute)
1817 -○○○○.○○○CR	B81	Standard Length XX-Large Corner Radius End Mill (4 Flute)
1817 -○○○○○○○○○CR	B81	Standard Length XX-Large Corner Radius End Mill (4 Flute)
1817 -○○○○○○○○○CR	B81	Standard Length XX-Large Corner Radius End Mill (4 Flute)
1818 -○○○○.○○○CR	B81	Standard Length XXX-Large Corner Radius End Mill (4 Flute)
1818 -○○○○○○○○○CR	B81	Standard Length XXX-Large Corner Radius End Mill (4 Flute)
1818 -○○○○○○○○○CR	B81	Standard Length XXX-Large Corner Radius End Mill (4 Flute)
1820 -○○○○.○○○	B29 - B31	Stub Length Square End Mill (4 Flute)
1820 -○○○○○○○○○	B29 - B30	Stub Length Square End Mill (4 Flute)
1820 -○○○○○○○○○	B29 - B31	Stub Length Square End Mill (4 Flute)
1825 -○○○○.○○○	B55 - B58	Standard Length Ball Nose End Mill (4 Flute)
1825 -○○○○○○○○○	B55 - B57	Standard Length Ball Nose End Mill (4 Flute)
1825 -○○○○○○○○○	B55 - B58	Standard Length Ball Nose End Mill (4 Flute)
1835 -○○○○.○○○	B59 - B61	Stub Length Ball Nose End Mill (4 Flute)
1835 -○○○○○○○○○	B59 - B60	Stub Length Ball Nose End Mill (4 Flute)
1835 -○○○○○○○○○	B59 - B61	Stub Length Ball Nose End Mill (4 Flute)
1840 -○○○○.○○○(○)	B32 - B34	Extended Reach Square End Mill (4 Flute)
1840 -○○○○○○○○○(○)	B32 - B34	Extended Reach Square End Mill (4 Flute)
1845 -○○○○.○○○(○)	B62 - B64	Extended Reach Ball Nose End Mill (4 Flute)
1845 -○○○○○○○○○(○)	B62 - B63	Extended Reach Ball Nose End Mill (4 Flute)
1845 -○○○○○○○○○(○)	B62 - B64	Extended Reach Ball Nose End Mill (4 Flute)
1890 -○○○○○○○○○(○)	B87	VULCAN Compression End Mill
1905 -○○○○.○○○R	B84	Standard Length High Helix Corner Radius End Mill (5 Flute)
1905 -○○○○○○○○○R	B84	Standard Length High Helix Corner Radius End Mill (5 Flute)
2120 -○○○○.○○○□	C2 - C3	Up Cut Diamond Pattern Router Bit
2120 -○○○○○○○○○□	C2 - C3	Up Cut Diamond Pattern Router Bit
2120 -○○○○○○○○○□	C2 - C3	Up Cut Diamond Pattern Router Bit
2121 -○○○○.○○○□	C4 - C5	Down Cut Diamond Pattern Router Bit
2121 -○○○○○○○○○□	C4 - C5	Down Cut Diamond Pattern Router Bit
2121 -○○○○○○○○○□	C4 - C5	Down Cut Diamond Pattern Router Bit
226 -○○○○.○○○(○)	A19 - A31	Micro Drill
226 -○○○○○○○○○(○)	A19 - A31	Micro Drill
226L -○○○○.○○○(○)	A32 - A38	Left Hand Micro Drill
226L -○○○○○○○○○(○)	A32 - A38	Left Hand Micro Drill

Part Number	Page	Category
2320 -○○○○.○○○□	C6	Up Cut Chipbreaker Pattern Router Bit
2320 -○○○○○○○○○□	C6	Up Cut Chipbreaker Pattern Router Bit
2320 -○○○○○○○○○□	C6	Up Cut Chipbreaker Pattern Router Bit
390 -○○○○.○○○	A39	Ultra Precision Micro Drill
392 -○○○○.○○○	A40	Ultra Precision Micro Drill
392 -○○○○○○○○○	A40	Ultra Precision Micro Drill
813 -○○○○.○○○(○)	A41 - A44	Coolant Fed Micro Drill
813 -○○○○○○○○○(○)	A41 - A44	Coolant Fed Micro Drill
860 -○○○○○○○○○(○)	A45	HYDROS Coolant Fed Deep Drill
865 -○○○○○○○○○(○)	A46 - A49	HYDROS Coolant Fed Deep Drill
885 -○○○○.○○○	A50	Micro Drill for Brass
885 -○○○○○○○○○	A50	Micro Drill for Brass
98M 05-○○○○.○F□○	D2	Single Point Micro Thread Mill
98M 05-○○○○○○○○○□	D2	Single Point Micro Thread Mill
AP4 -○○○○.○○○(○)	B82	Variable Helix Corner Radius End Mill (4 Flute)
AP4M -○○○○(○).○○○(○)	B83	Variable Helix Corner Radius End Mill (4 Flute)
AP5 -○○○○(○).○○○(○)	B85	Variable Helix Corner Radius End Mill (4 Flute)
AP5M -○○○○(○).○○○(○)	B86	Variable Helix Corner Radius End Mill (4 Flute)
CM -○○○.○○○	B88	Chamfer Mill (30° - 120°)
CM -○○○○○○○○○	B88	Chamfer Mill (30° - 120°)
CMM -○○○○.○○○	B89	Chamfer Mill (60°, 90°, 120°)
CMM -○○○○○○○○○	B89	Chamfer Mill (60°, 90°, 120°)
EGR ○○○○-○○○	E2	General Purpose Engraver (2 Flute)
HR ○○○SS○○○A	E3	General Purpose Engraver (Half Round)
MBE -○○○○.○○○(○)	F4 - F5	Extended Reach Internal Diameter Profile Boring Bar
MBE -○○○○○○○○○(○)	F4 - F5	Extended Reach Internal Diameter Profile Boring Bar
MBS -○○○○.○○○(○)	F2 - F3	Standard Length Internal Diameter Profile Boring Bar
MBS -○○○○○○○○○(○)	F2 - F3	Standard Length Internal Diameter Profile Boring Bar
MR34 -○○○○.○○○	G2 - G9	3mm Shank Micro Reamer (4 Flute)
MR46 -○○○○.○○○	G10 - G12	4mm Shank Micro Reamer (6 Flute)
MR46 -○○○○○○○○○	G12	4mm Shank Micro Reamer (6 Flute)
MR66 -○○○○.○○○(○)	G13	6mm Shank Micro Reamer (6 Flute)
MR66 -○○○○○○○○○(○)	G13	6mm Shank Micro Reamer (6 Flute)
MR86 -○○○○.○○○(○)	G14	8mm Shank Micro Reamer (6 Flute)
MR86 -○○○○○○○○○(○)	G14	8mm Shank Micro Reamer (6 Flute)
MR106 -○○○○.○○○(○)	G15	10mm Shank Micro Reamer (6 Flute)
MR106 -○○○○○○○○○(○)	G15	10mm Shank Micro Reamer (6 Flute)
SC ○○○○○○○○○○○○○○-○○	H6 - H11	Micro Saw (Inch Sizes)
SC ○○○○○○○○○○-○○	H12 - H18	Micro Saw (Metric Sizes)
SPD ○○○○-○○○	E4	Spotting or Chamfering Engraver (Spade)
T ○○○○□○○○	B14	TITAN-AX Square End Mill (Stub & Standard Length)
T ○○○○□○○○ER	B15	TITAN-AX Square End Mill (Extended Reach)
T ○○○○□○○○CR	B71 - B72	TITAN-AX Inch Corner Radius End Mill (Stub & Standard Length)
T ○○○○□○○○CRO	B71 - B72	TITAN-AX Metric Corner Radius End Mill (Stub & Standard Length)
T ○○○○□○○○ECRO	B73	TITAN-AX Metric Corner Radius End Mill (Extended Reach)
T ○○○○□○○○ERC	B73	TITAN-AX Inch Corner Radius End Mill (Extended Reach)

DRILLS **A**  
 END MILLS **B**  
 ROUTERS **C**  
 THREAD MILLS & TAPS **D**  
 ENGRAVERS **E**  
 BORING BARS **F**  
 REAMERS **G**  
 SAWS **H**  
 TECHNICAL **I**  
 INDEX **J**



<b>A</b>	DRILLS
<b>B</b>	END MILLS
<b>C</b>	ROUTERS
<b>D</b>	THREAD MILLS & TAPS
<b>E</b>	ENGRAVERS
<b>F</b>	BORING BARS
<b>G</b>	REAMERS
<b>H</b>	SAWS
<b>I</b>	TECHNICAL
<b>J</b>	INDEX

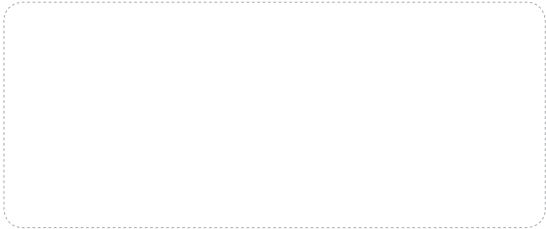

**KYOCERA Precision Tools, Inc.**

3565 Cadillac Ave.  
Costa Mesa, CA 92626  
Customer Service | (US) 1.888.848.8449  
Customer Service | (INT'L) 001.714.428.3636  
Technical Support | 1.800.823.7284 - Option 2



W | Official Website | [www.kyoceraprecisiontools.com](http://www.kyoceraprecisiontools.com)  
W | Distributor Website | <http://mykpti.kyocera.com>  
E | [cuttingtools@kyocera.com](mailto:cuttingtools@kyocera.com)

©KYOCERA Precision Tools, Inc.  
6/17, 10K Printed in U.S.A.