

THE NEW VALUE FRONTIER



2 0 1 3

KYOCERA Cutting Tools

Drilling Catalog



ADVANCING PRODUCTIVITY

Drilling Catalog

Table of Contents

KYOCERA Company Overview	iv
How to Order Kyocera Cutting Tools	v
Drilling Product Lineup & Inserts	1-2
Summary of Drilling Grades	3-4
DRZ Magic Drill	5-20
ZCMT Inserts	6
Inch Dia. / Inch Shank (Ø0.562" - Ø2.000")	Cutting Depth: 2xD / 3xD / 4xD / 5xD 7
Metric Dia. / Inch Shank (Ø13mm - Ø26mm)	Cutting Depth: 3xD 11
Metric Dia. / Metric Shank (Ø13mm - Ø59mm)	Cutting Depth: 2xD / 3xD / 4xD / 5xD 13
DRX Magic Drill	21-36
ZXMT Inserts	25
Inch Dia. / Inch Shank (Ø0.562" - Ø1.000")	Cutting Depth: 5xD 27
Metric Dia. / Metric Shank (Ø12mm - Ø60mm)	Cutting Depth: 2xD / 3xD / 4xD / 5xD 28
DRC Magic Drill	37-50
DC Inserts	38
SS-DRC (Straight Shank)	Cutting Depth: 3xD / 5xD / 8xD 41
Chamfering Attachment for SS-DRC	43
SF-DRC (Flanged Shank)	Cutting Depth: 3xD / 5xD / 8xD 45
DRS Mini-Magic Drill	51-52
DR Holeshot Drill	53-60
WCMX Inserts	53
Inch Dia. DR, DR-X3N & DR-X1 (Ø0.688" - Ø4.000")	54
CD Coremaster Coredrill	61-64
WCMX Inserts	61
Inch Dia. (Ø0.825" - Ø1.303") Fixed Pocket	62
Inch Dia. (Ø1.36" - Ø3.06") Adjustable Cartridge	62
Inch Dia. (Ø0.825" - Ø1.303") Extended Length Fixed Pocket	63
Inch Dia. (Ø1.35" - Ø3.15") Extended Length Adjustable Cartridge	63
SDR Stinger Drill	65-66
Fine Micro Drills	67-72
Counterbores & Countersinks	73-76
Adjustable Sleeves for DRZ & DRX	77-78
Customized Drills	79-80
Technical Information	81-99

Kyocera Cutting Tool Network

KYOCERA Cutting Tools Global Manufacturing Facilities



Okaya Factory (JAPAN)



Yokaichi Factory (JAPAN)

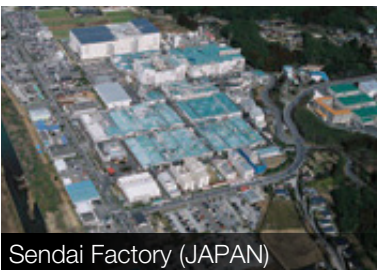

Sendai Factory (JAPAN)



Silong Factory (CHINA)



Incheon Factory (KOREA)



KYOCERA Cutting Tools North America Manufacturing Facilities



North Carolina Facility



Washington Facility



Ohio Facility



California Facility

Kyocera Cutting Tool Network

KYOCERA Cutting Tools Global Technical Centers



North American Technical Center (NC)

- **KYOCERA Industrial Ceramics Corp. (Hendersonville, NC)**
North American Headquarters and CT Manufacturing Facility
- **KYOCERA Industrial Ceramics Corp. (Vancouver, WA)**
Advanced Ceramics Components Facility
- **KYOCERA Cutting Tool Division (Wapakoneta, OH)**
CT Manufacturing Facility



Technical Center (BRAZIL)



Technical Center (JAPAN)



Technical Center (JAPAN)



Technical Center (JAPAN)



Sales Office and Technical Center (GERMANY)



Technical Center (KOREA)



Technical Center (SINGAPORE)



Technical Center (CHINA)

Company Profile

Kyocera Industrial Ceramics Corporation (KICC), a core company of the Kyocera Group, is a leading manufacturer and provider of **cutting tool products**, advanced ceramic components, liquid crystal displays, thermal printheads, metallized assemblies and industrial lenses. The Kyocera Group is a diversified network of companies working together to create new value for businesses and consumers. Kyoto, Japan-based Kyocera Corporation (NYSE: KYO), the group's global parent, employs approximately 64,000 people in 25 nations and recorded consolidated net sales of approximately US\$13 billion during the year ended March 31, 2010.

Kyocera's Cutting Tool Division is the market leader in Japan and a leading supplier of high-quality tooling solutions in North America with plants in Ohio, North Carolina, and Washington. Kyocera manufactures a diversified product line of turning, milling, Swiss, and drilling products. Our indexable inserts and steel products are manufactured to the highest quality standards and include coated and uncoated carbide, cermet, ceramic, CBN and PCD.

Kyocera's continuous **investment and focus on R&D** has resulted in market beating products such as our innovative CVD coated CA45-Series for cast iron, CA55-series for steel and CA65-series for stainless steel, our high performance MECH helical endmills, our highly acclaimed MFPN high-efficiency 10-edged face mill, and most recently our new line of MEGACOAT carbide, cermet, CBN and ceramic tools, just to name a few.

The Kyocera Industrial Ceramics Corporate headquarters are located in Mountain Home, NC which also serves as the primary North American cutting tool manufacturing plant and is home to the Cutting Tool Division Customer Service, Marketing, and Technical Center staff.

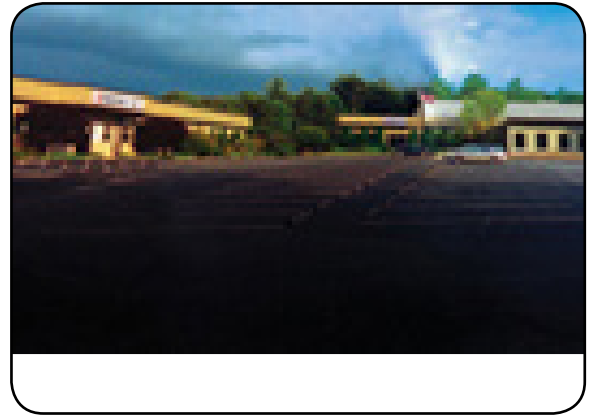

*KICC North American Headquarters
Hendersonville, NC*



*KICC, Cutting Tool Division Ohio Production Facility
Wapakoneta, OH*



How to Order Kyocera Cutting Tool Products

Kyocera Cutting Tool products are sold exclusively through our North American line of authorized distributors. To locate a local Kyocera Cutting Tool Distributor, please contact Kyocera Customer Service at 800-823-7284.

Using the Kyocera Product Catalogs

All standard Kyocera Cutting Tool Products are located in one of these four General Catalogs.

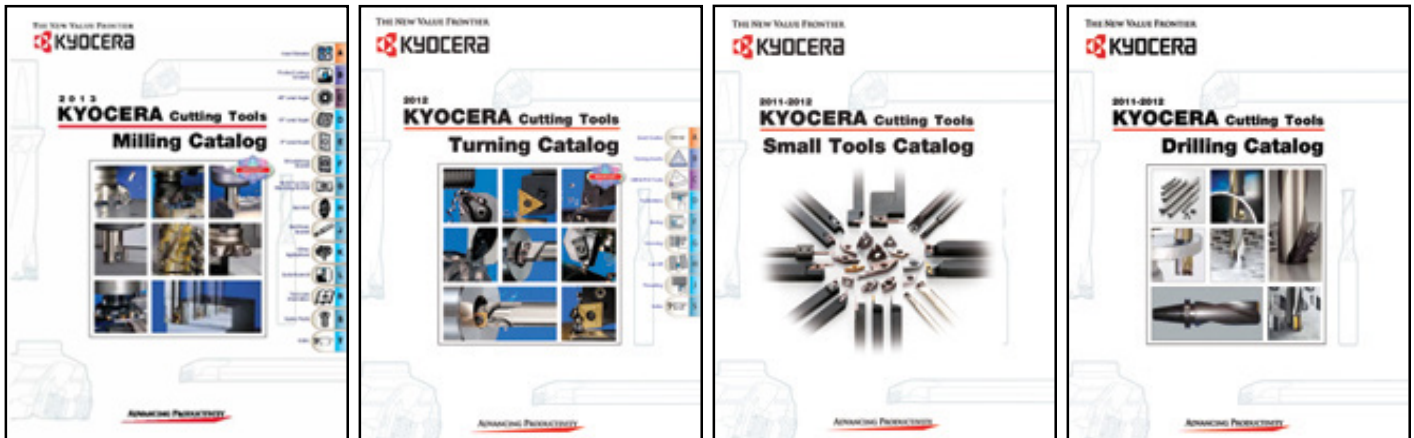

Stock Status Symbols

●: Indicates that an item is **Stock Standard** and available at our North American Headquarters in North Carolina. Stock Standard items will ship the same day if ordered by 4:30pm (EST).

○: Indicates that an item is **World Express** and available at our Worldwide Headquarters in Japan. Please allow 5-7 business days for World Express items to arrive.

All Stock Standard and World Express items are subject to availability

Kyocera Authorized Distributor Ordering Guide



Order online

To place an order for Kyocera Cutting Tools, please utilize the MyKICC Distributor Website -

<http://mykicc.kyocera.com>

In addition to placing orders, the MyKICC distributor website allows you to view real-time product availability, check pricing, view and download product and promotional literature, watch product training videos, and much, much more.



Call us

- Kyocera Cutting Tool Customer Service – (800) 823-7284.
Representatives are available Monday through Friday from 8:00am to 5:30pm (EST).
- Kyocera Applications Engineers – (800) 823-7284.
Engineers are available Monday through Friday from 8:00am to 5:00pm (EST).



Email us

- General Inquiries – cuttingtools@kyocera.com
- Customer Service – ctsales@kyocera.com
- Technical Center – cttechs@kyocera.com











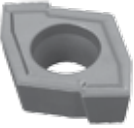



Drilling Product Lineup

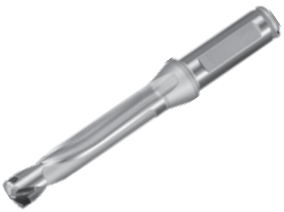

Product Lineup

Drilling

NEW ITEM

Drill Type	Cutting Dia (Cutting Depth)	Insert	Features
DRZ Magic Drill Page 5	 <p><u>Inch-Size</u> ø0.562-ø2.00 (2D,3D,4D, NEW 5D)</p> <p><u>Metric-Size</u> ø13-ø59 (2D, 3D) ø13-ø50 (4D) ø27-ø50 (5D)</p>	ZCMT Page 6  <p>Four cutting edges per insert promotes cost savings and increased efficiency</p>	<ul style="list-style-type: none"> Silver coating promotes extended tool life and improved chip flow Molded chipbreaker produces three separate chips for smooth chip evacuation Possible to drill into a slant face without pre-drilling <p><u>Chip Shape (Work Material: 1050) Cutting Dia. ø.906</u></p> <p>Chip from Outer Edge </p> <p>Chip from Inner Edge </p>
DRX Magic Drill Page 21	 <p><u>Inch-Size</u> ø0.562-ø1.00 (NEW 5D)</p> <p><u>Metric-Size</u> ø12-ø60 (2D, 3D) ø13-ø50 (4D) ø27-ø50 (5D)</p>	ZXMT Page 25  <p>Four cutting edges per Insert</p> <p>Three new chipbreakers for superior chip evacuation</p>	<ul style="list-style-type: none"> Twisted coolant hole technology provides superior chip evacuation Three new chipbreaker designs cover a variety of workpiece materials Wide chipbreaker on the outer edge produces small chips for better evacuation Possible to drill into a slant face without pre-drilling <p><u>Chip Shape (Work Material: 1050) Cutting Dia. ø.945</u></p> <p>Chip from Outer Edge </p> <p>Chip from Inner Edge </p>
DRC Magic Drill Page 37	 <p><u>Metric-Size</u> ø7.94-ø25.50 (3D / 5D / 8D)</p>	DC Page 38  <p>Inner and outer edges on one insert</p>	<p>DRC Lineup</p>  SS-DRC  SF-DRC  Chamfering Attachment
DRS Mini-Magic Drill Page 51	 <p><u>Inch-Size</u> ø0.394-ø0.492 (3.5D)</p>	DS Page 51  <p>One insert with inner and outer cutting edges</p>	<ul style="list-style-type: none"> Small chips with good chip evacuation Possible to drill into a slant face without pre-drilling High speed stable machining <p>Chip from Outer Edge </p> <p>Chip from Inner Edge </p>

Drill Type	Cutting Dia (Cutting Depth)	Insert	Features
<p>DR Holeshot Drill</p> <p>Page 53</p>	 <p>Inch-Size ø0.688~ø4.00</p>	<p>WCMX</p> <p>Page 53</p>  <p>WCMX available in new MEGACOAT Grade PR1230</p>	 <ul style="list-style-type: none"> • Flute design optimized for maximum rigidity and good chip evacuation • Swept back design enables drilling of stacked plates and welded assemblies
<p>CD Coremaster Coredrill</p> <p>Page 61</p>	 <p>Inch-Size ø0.825~ø3.15</p>	<p>WCMX</p> <p>Page 61</p>  <p>WCMX available in new MEGACOAT Grade PR1230</p>	<ul style="list-style-type: none"> • Available in both fixed pocket and adjustable cartridge providing 0.150" adjustment capability on diameter. • Fast, effective way to expand pre-existing holes. • Two effective flutes allow high feed-rates for improved productivity.
<p>SDR Stinger Drill</p> <p>Page 65</p>	 <p>Inch-Size ø0.484~ø0.844</p>	<p>TCMT</p> <p>Page 65</p>  <p>Three cutting edges per insert</p>	<ul style="list-style-type: none"> • Economical alternative to the Magic Drill • Perfect for job shops or small quantity production • Ideal for low horsepower machines
<p>Micro-Drills</p> <p>Page 67</p>	 <p>Drill Diameter ø0.10mm~ ø0.0.80mm</p>		<ul style="list-style-type: none"> • High quality cutting edge with minimized variability • A tougher ultra-micro grain carbide substrate improved cutting edge stability and anti-breakage performance • Ultra-thin high performance coating layer (FS Coating) enables high efficient and long lasting drilling application.
<p>NEW</p> <p>Counterbores Countersinks</p> <p>Page 73</p>		<p>TCMT</p> <p>Page 73</p>  <p>Three cutting edges per insert</p>	<p>Counterbores</p> <ul style="list-style-type: none"> • For socket head cap screws 1/4" to 3/4" and 6mm to 16mm <p>Countersinks</p> <ul style="list-style-type: none"> • For flat head cap screw sizes #10 to 3/4"



Drilling Insert Grades

Summary of Insert Grades

Workpiece Material		Steel (Carbon steel / Alloy steel)				Stainless steel / Cast steel				Cast Iron (Gray cast iron / Nodular cast iron)					
Cutting Range		← Finishing		→ Roughing		← Finishing		→ Roughing		← Finishing		→ Roughing			
Classification		P01	P10	P20	P30	P40	M01	M10	M20	M30	M40	K01	K10	K20	K30
Coated Carbide	PR Series		PR660	PR730	PR830	PR915	PR930	PR1025				PR905			
	MEGACOAT (PR Series)		PR1225	PR1230				PR1225				PR1210			
Carbide												KW10	GW15		
Workpiece Material		Non-ferrous Metals (Aluminum / Non-ferrous metals / Non-metals)				Titanium / Titanium alloys				Hardened materials (Hardened steel / Chilled cast iron)					
Cutting Range		← Finishing		→ Roughing		← Finishing		→ Roughing		← Finishing		→ Roughing			
Classification		N01	N10	N20	N30	S01	S10	S20	S30	H01	H10	H20	H30		
Coated Carbide	MEGACOAT (PR Series)									PR1230					
	Carbide		KW10	GW15			KW10	GW15							

Insert Material Selection Guide

Application	Cutting Range	P	M	K		N	S		H	Sintered steel	
		Steel	Stainless Steel	Gray Cast Iron	Nodular Cast Iron	Non-ferrous Metals	Heat-Resistant Alloys	Titanium Alloys	Hardened materials		
	Wear Resistance ↑ ↓ Toughness	PR930					PR660				
		PR730	PR730				PR1025				
		PR830	PR830	PR905	PR905	KW10	PR1225	KW10			
		PR915	PR915	PR1210	PR1210	GW15	PR1230				
		PR1025	PR1025	KW10	KW10		KW10				
		PR1225	PR1225				GW15				
		PR1230	PR660								
		PR660									

• Highlighted materials are recommended choice.

PVD Coated Carbide for Drilling

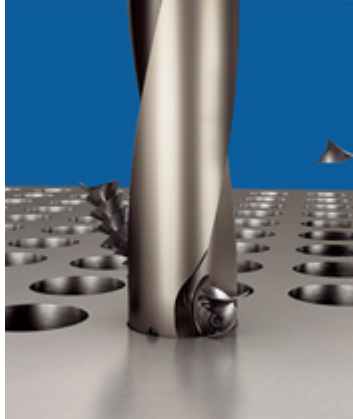



PVD Coated Carbide

KYOCERA's PVD coated carbide for drilling is coated on a very tough carbide substrate. Because of the low process temperature compared with CVD, it features no erosion of bending strength, less deterioration of coating and realizes superior tool life and stable cutting.



Features of PVD Coated Carbide for Drilling

Workpiece Material	Symbol	Color	Main Component	Advantages
 Steel	PR630	Gold	TiN	<ul style="list-style-type: none"> TiN base PVD coated carbide Application: General purpose drilling of steel
	PR730	Gold	TiAlN+TiN	<ul style="list-style-type: none"> Superior oxidation resistance with well balanced wear resistance and toughness Application: Stable and long tool life at high speed cutting of steel
	PR830	Gold	TiAlN+TiN	<ul style="list-style-type: none"> Improved high temperature stability and wear resistance by TiAlN base PVD coating Application: Stable and long tool life for drilling of steel
	PR1230	Blackish red	MEGACOAT	<ul style="list-style-type: none"> Superior wear and oxidation resistant MEGACOAT coating on special tough carbide substrate Application: Stable and high feed drilling of steel
 Stainless Steel	PR660	Gold	TiN	<ul style="list-style-type: none"> Superior adhesion-resistant TiN base PVD coated carbide on special tough carbide substrate Application: For steel, stainless steel, cast steel and heat-resistant alloys, low speed cutting
	PR1025	Reddish gray	TiCN	<ul style="list-style-type: none"> TiCN base PVD coating on micro-grain carbide Application: Stable and long tool life drilling of stainless steel
	PR1225	Blackish red	MEGACOAT	<ul style="list-style-type: none"> Superior wear and oxidation-resistant MEGACOAT coating on micro-grain carbide substrate Application: General and high feed drilling of steel, stainless steel, and heat-resistant alloys
 Cast Iron	PR905	Bluish violet	TiAlN	<ul style="list-style-type: none"> TiAlN base PVD coating on special tough carbide substrate for cast iron Application: Highly efficient stable drilling of gray and nodular cast iron
	PR1210	Blackish red	MEGACOAT	<ul style="list-style-type: none"> Superior wear and oxidation resistant MEGACOAT coating on special carbide substrate for cast iron Application: Highly efficient stable drilling of gray and nodular cast iron

Carbide



Carbide

Due to its superior mechanical features carbide is used in a variety of applications. KYOCERA produces a variety of carbides, including KW10 and GW15 for non-ferrous materials and micro-grain carbides for precision cutting.

Features

- Tough and hard
- Good thermal conductivity
- Suitable for cutting non-ferrous metals and non-metals
- Stable cutting at low cutting speeds, including drilling operations

Features of Carbide

Workpiece Material	Symbol	Color	Main Component	Advantages
 Non-ferrous materials	KW10	Gray	WC+Co	<ul style="list-style-type: none"> ISO identification symbol K carbide (K10 relevant) Application: Stable cutting of cast iron, non-ferrous materials and non-metals
	GW15	Gray	WC+Co	<ul style="list-style-type: none"> ISO identification symbol K carbide (equivalent to K10), tough micro-grain carbide Application: High wear resistance and toughness for cast iron, non-ferrous materials and non-metals

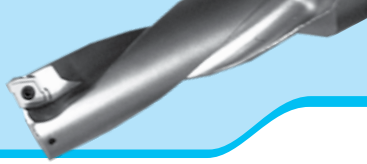

Magic Drill DRZ

- Single insert in both pockets and four cutting edges per insert promotes cost savings and increased efficiency
- Molded chipbreaker produces three separate chips for smooth chip evacuation
- Inserts available in new MEGACOAT PVD coated carbides for a variety of applications
- Able to offset drill and drill into slant workpieces without pre-drilling
- Excellent surface finishes

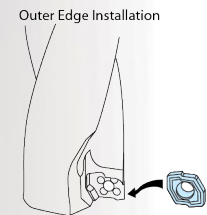

The same insert is used in both the inner and outer pockets

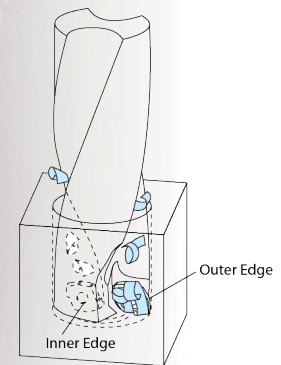
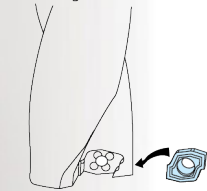

Chips are divided into a total of 3 pcs: 2 pcs from the outer edge and 1 pc from the inner edge.



Silver Nickel Coating

- Promotes tool life
- Improves chip flow

Shape	Description	Dimensions (inch)					Angle (°)	MEGACOAT Carbide				Reference Page for Toolholder	
		A	T	Ød	W	rε		Uncoated Carbide	PR1230	PR1225	PR1210		KW10
							α						
Classification of Usage ★ : 1st Choice ☆ : 2nd Choice (Steel; non heat treated)		P	Carbon Steel / Alloy Steel					★	☆				
			Mold Steel					★					
		M	Stainless Steel					☆	★				
		K	Cast Iron							★			
		N	Non-Ferrous Metal								★		

		ZCMT 050203	0.232	0.094	0.091	0.107	0.012	7°	●	●	●	●	7-18
		06T204	0.276	0.110	0.098	0.236	0.016		●	●	●	●	
		080304	0.381	0.125	0.114	0.323			●	●	●	●	
		10T304	0.473	0.156	0.173	0.409			●	●	●	●	
		12T306	0.562	0.156	0.220	0.504	0.024		●	●	●	●	
		150408	0.702	0.187	0.220	0.622	0.031		●	●	●	●	
		200608	0.898	0.250	0.256	0.799			●	●	●	●	
		ZCMT 050203SP	0.232	0.094	0.091	0.107	0.012	7°	●	●		●	7-18
		06T204SP	0.276	0.110	0.098	0.236	0.016		●	●		●	
		080304SP	0.381	0.125	0.114	0.323			●	●		●	
		10T304SP	0.473	0.156	0.173	0.409			●	●		●	
		12T306SP	0.562	0.156	0.220	0.504	0.024		●	●		●	
		150406SP	0.702	0.187	0.220	0.622	0.024		●	●		●	
		ZCMT 050203SU	0.232	0.094	0.091	0.107	0.012	7°	●	●			7-18
		06T204SU	0.276	0.110	0.098	0.236	0.016		●	●			

Insert Grade Features: ● Page 1

● : Stock Standard
○ : World Express

Suitable Chipbreaker (ZCMT)

Workpiece Material	Insert Size Chipbreaker Cutting Depth	ZCMT05									ZCMT06									ZCMT08											
		Standard			SP			SU			Standard			SP			SU			Standard			SP								
		2D	3D	4D	2D	3D	4D	2D	3D	4D	2D	3D	4D	2D	3D	4D	2D	3D	4D	2D	3D	4D	2D	3D	4D						
Low Carbon Steel		☆	☆	-	★	★	★	-	-	-	☆	☆	-	★	★	★	☆	☆	☆	☆	☆	-	★	★	★						
Carbon Steel		★	★	☆	☆	☆	★	-	-	-	★	★	☆	☆	☆	★	-	-	-	★	★	☆	☆	☆	★						
Alloy Steel		★	★	☆	☆	☆	★	-	-	-	★	★	☆	☆	☆	★	-	-	-	★	★	☆	☆	☆	★						
Mold Steel		★	★	☆	☆	☆	★	-	-	-	★	★	☆	☆	☆	★	-	-	-	★	★	☆	☆	☆	★						
Stainless Steel		☆	☆	-	★	★	★	☆	☆	-	-	-	-	☆	☆	☆	★	★	★	☆	☆	-	★	★	★						
Cast Iron		★	★	★	☆	☆	☆	-	-	-	★	★	★	☆	☆	☆	-	-	-	★	★	★	☆	☆	☆						
Aluminum Alloy		☆	☆	☆	★	★	★	-	-	-	☆	☆	☆	★	★	★	-	-	-	☆	☆	☆	★	★	★						
Brass		★	★	★	☆	☆	☆	-	-	-	★	★	★	☆	☆	☆	-	-	-	★	★	★	☆	☆	☆						
Titanium Alloy		☆	☆	☆	★	★	★	-	-	-	☆	☆	☆	★	★	★	-	-	-	☆	☆	☆	★	★	★						
Workpiece Material	Insert Size Chipbreaker Cutting Depth	ZCMT10									ZCMT12									ZCMT15									ZCMT20		
		Standard				SP					Standard			SP						Standard				SP					Standard		
		2D	3D	4D	5D	2D	3D	4D	5D	2D	3D	4D	2D	3D	4D	5D	2D	3D	4D	5D	2D	3D	4D	5D	2D	3D	4D				
Low Carbon Steel		☆	☆	-	-	★	★	★	★	☆	☆	-	-	★	★	★	★	☆	☆	-	-	★	★	★	★	★	★	★			
Carbon Steel		★	★	☆	☆	☆	☆	★	★	★	★	☆	☆	☆	☆	★	★	★	★	☆	☆	☆	☆	★	★	★	★	★			
Alloy Steel		★	★	☆	☆	☆	☆	★	★	★	★	☆	☆	☆	☆	★	★	★	★	☆	☆	☆	☆	★	★	★	★	★			
Mold Steel		★	★	☆	☆	☆	☆	★	★	★	★	☆	☆	☆	☆	★	★	★	★	☆	☆	☆	☆	★	★	★	★	★			
Stainless Steel		☆	☆	-	-	★	★	★	★	☆	☆	-	-	★	★	★	★	☆	☆	-	-	★	★	★	★	★	★	★			
Cast Iron		★	★	★	★	☆	☆	☆	☆	★	★	★	★	☆	☆	☆	☆	★	★	★	★	☆	☆	☆	☆	★	★	★			
Aluminum Alloy		☆	☆	☆	☆	★	★	★	★	☆	☆	☆	☆	★	★	★	★	☆	☆	☆	☆	★	★	★	★	★	★	★			
Brass		★	★	★	★	☆	☆	☆	☆	★	★	★	★	☆	☆	☆	☆	★	★	★	★	☆	☆	☆	☆	★	★	★			
Titanium Alloy		☆	☆	☆	☆	★	★	★	★	☆	☆	☆	☆	★	★	★	★	☆	☆	☆	☆	★	★	★	★	★	★	★			

• Standard chipbreakers (without symbol) may function better with interrupted cutting.

★ : 1st Recommendation ☆ : 2nd Recommendation

• When machining aluminum, chips become long and difficult to discharge at depths over 2D.

Inserts are sold in 10 piece boxes



Magic Drill DRZ

Drilling

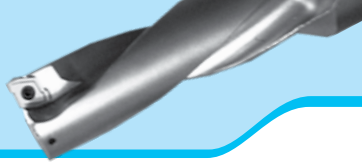

DRZ (Drilling Depth : 2 x D) Inch Dimension

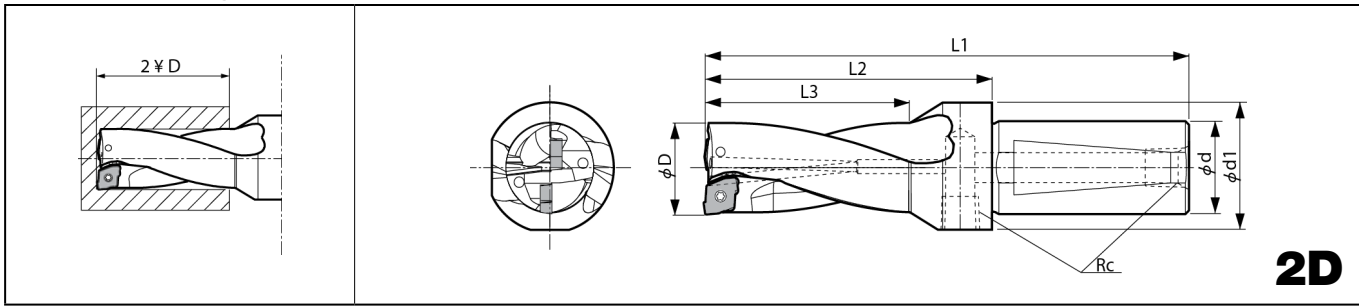

● Toolholder Dimensions

Description	Stock	No. of Insert	Dimension (inch)						Max. Offset (Radial)	Spare Parts			Applicable Inserts ● Page 6					
			ØD	L1	L2	L3	Ød	Ød1		Rc	Insert Screw	Wrench		Plug				
S75 -DRZ5621125-05G	●	2	0.562	3.87	2.18	1.125	0.75	1.06	1/8 NPT	+ 0.020	SB-2045TR	FT-6	GP-1N	ZCMT050203 ZCMT050203SP ZCMT050203SU				
S100 -DRZ6251250-06G	●	2	0.625	4.52	2.39	1.250	1.00	1.26	1/8 NPT	+ 0.043	SB-2260TR	DT-7	GP-1N	ZCMT06T204 ZCMT06T204SP ZCMT06T204SU				
-DRZ6561312-06G	●		0.656	4.52	2.39	1.312				+ 0.034								
-DRZ6881375-06G	●		0.688	4.56	2.43	1.375				+ 0.027								
-DRZ7501500-06G	●		0.750	4.73	2.61	1.500				+ 0.020								
-DRZ8121625-06G	●		0.812	4.93	2.81	1.625				+ 0.014								
-DRZ8751750-08G	●		0.875	5.02	2.90	1.750				+ 0.055								
-DRZ9381875-08G	●		0.938	5.17	3.05	1.875				+ 0.043								
-DRZ10002000-08G	●		1.000	5.24	3.11	2.000				+ 0.028								
-DRZ10622125-10G	●		1.062	5.67	3.54	2.125				+ 0.098								
-DRZ11252250-10G	●		1.125	5.74	3.62	2.250				+ 0.073								
-DRZ11882375-10G	●	1.188	5.86	3.74	2.375	+ 0.067	SB-4085TR	DT-15	GP-2N	ZCMT10T304 ZCMT10T304SP								
-DRZ12502500-10G	●	1.250	5.92	3.79	2.500	+ 0.047												
S125 -DRZ13122625-12G	●	2	1.312	6.82	4.10	2.625	1.25	2.17	1/4 NPT	+ 0.110	SB-5085TR	DT-20	GP-2N	ZCMT12T306 ZCMT12T304SP				
-DRZ13752750-12G	●		1.375	6.98	4.27	2.750				+ 0.094								
-DRZ14382875-12G	●		1.438	7.07	4.35	2.875				+ 0.078								
-DRZ15003000-12G	●		1.500	7.19	4.47	3.000				+ 0.067								
-DRZ15623125-12G	●		1.562	7.29	4.57	3.125				+ 0.047								
-DRZ16253250-15G	●		1.625	7.34	4.62	3.250				+ 0.150								
-DRZ16883375-15G	●		1.688	7.49	4.78	3.375				+ 0.138								
-DRZ17503500-15G	●		1.750	7.57	4.85	3.500				+ 0.122								
-DRZ18123625-15G	●		1.812	7.78	5.06	3.625				+ 0.106					SB-5085TR	DT-20	GP-2N	ZCMT150408 ZCMT150406SP
-DRZ18753750-15G	●		1.875	7.97	5.26	3.750				+ 0.087								
-DRZ19383875-15G	●	1.938	8.05	5.34	3.875	+ 0.070	2.36	1/4 NPT										
-DRZ20004000-15G	●	2.000	8.05	5.34	4.000	+ 0.055												

- When offset machining, reduce feed rate to .003ipr or less
- See ● Page 77 for Adjustable Sleeve ASL.

- : Stock Standard
- : World Express

Recommended Cutting Conditions ● Page 19



DRZ (Drilling Depth : 3 x D) Inch Dimension

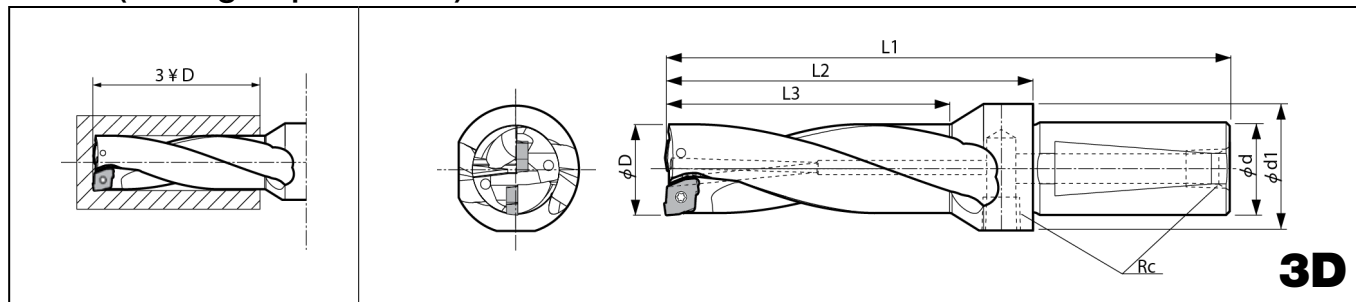

● Toolholder Dimensions

Description	Stock	No. of Insert	Dimension (inch)						Max. Offset (Radial)	Spare Parts			Applicable Inserts ● Page 6	
			ØD	L1	L2	L3	Ød	Ød1		Rc	Insert Screw 	Wrench 		Plug
S75 -DRZ5621687-05G	●	2	0.562	4.42	2.72	1.687	0.75	1.06	1/8 NPT	+ 0.020	SB-2045TR	FT-6	GP-1N	ZCMT050203 ZCMT050203SP ZCMT050203SU
S100 -DRZ6251875-06G	●	2	0.625	5.15	3.02	1.875	1.00	1.26	1/8 NPT	+ 0.043	SB-2260TR	DT-7	GP-1N	ZCMT06T204 ZCMT06T204SP ZCMT06T204SU
-DRZ6561969-06G	●		0.656	5.15	3.02	1.969				+ 0.034				
-DRZ6882062-06G	●		0.688	5.23	3.10	2.062				+ 0.027				
-DRZ7502250-06G	●		0.750	5.48	3.35	2.250				+ 0.020				
-DRZ8122438-06G	●		0.812	5.76	3.64	2.438				+ 0.014				
-DRZ8752625-08G	●		0.875	5.77	3.65	2.625				+ 0.055				
-DRZ9382814-08G	●		0.938	5.89	3.76	2.814				+ 0.043				
-DRZ10003000-08G	●		1.000	6.11	3.98	3.000				+ 0.028				
-DRZ10623187-10G	●		1.062	6.81	4.49	3.187				+ 0.098				
-DRZ11253375-10G	●		1.125	6.92	4.60	3.375				+ 0.073				
-DRZ11883562-10G	●	1.188	7.12	4.80	3.562	+ 0.067								
-DRZ12503750-10G	●	1.250	7.22	4.89	3.750	+ 0.047								
S125 -DRZ13123938-12G	●	2	1.312	8.00	5.28	3.938	1.25	2.17	1/4 NPT	+ 0.110	SB-5085TR	DT-20	GP-2N	ZCMT12T306 ZCMT12T304SP
-DRZ13754125-12G	●		1.375	8.24	5.53	4.125				+ 0.094				
-DRZ14384312-12G	●		1.438	8.37	5.65	4.312				+ 0.078				
-DRZ15004500-12G	●		1.500	8.57	5.85	4.500				+ 0.067				
-DRZ15624688-12G	●		1.562	8.69	5.97	4.688				+ 0.047				
-DRZ16254875-15G	●		1.625	8.83	6.11	4.875				+ 0.150				
-DRZ16885062-15G	●		1.688	8.93	6.21	5.062				+ 0.138				
-DRZ17505250-15G	●		1.750	9.18	6.47	5.250				+ 0.122				
-DRZ18125438-15G	●		1.812	9.47	6.75	5.438				+ 0.106				
-DRZ18755625-15G	●		1.875	9.65	6.93	5.625				+ 0.087				
-DRZ19385812-15G	●	1.938	9.86	7.15	5.812	+ 0.070								
-DRZ20006000-15G	●	2.000	9.88	7.17	6.000	+ 0.055								
								2.36	1/4 NPT					ZCMT150408 ZCMT150406SP

● When offset machining, reduce feed rate to .003ipr or less

● : Stock Standard

● See ● Page 77 for Adjustable Sleeve ASL.

○ : World Express

Recommended Cutting Conditions ● Page 19

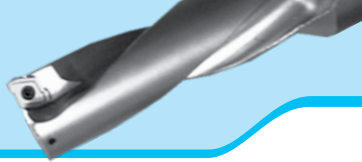

DRZ (Drilling Depth : 4 x D) Inch Dimension

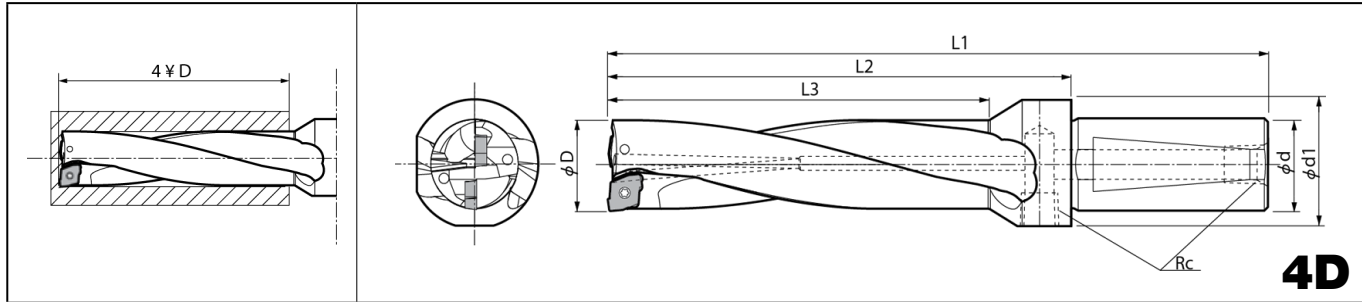

Toolholder Dimensions

Description	Stock	No. of Insert	Dimension (inch)						Max. Offset (Radial)	Spare Parts			Applicable Inserts ● Page 6																
			ØD	L1	L2	L3	Ød	Ød1		Rc	Insert Screw	Wrench		Plug															
S075 -DRZ5622250-05G	●	2	0.562	5.77	3.27	2.25	0.75	1.06	1/8 NPT	+ 0.020	SB-2045TR	FT-6	GP-1N	ZCMT050203 ZCMT050203SP ZCMT050203SU															
S100 -DRZ6252500-06G	●	2	0.625	6.65	3.65	2.50	1.26	1.26	1/8 NPT	+ 0.043	SB-2260TR	DT-7	GP-1N	ZCMT06T204 ZCMT06T204SP ZCMT06T204SU															
-DRZ6882750-06G	●		0.688	6.74	3.74	2.75																							
-DRZ7503000-06G	●		0.750	7.07	4.07	3.00																							
-DRZ8123250-06G	●		0.812	7.39	4.39	3.25																							
-DRZ8753500-08G	●	2	0.875	7.56	4.56	3.50	1.00	1.30	1/8 NPT	+ 0.055	SB-2570TR	DT-8	GP-1N	ZCMT080304 ZCMT080304SP															
-DRZ9383750-08G	●		0.938	7.77	4.77	3.75																							
-DRZ10004000-08G	●		1.000	8.06	5.06	4.00																							
-DRZ10004000-08G	●		1.000	8.06	5.06	4.00																							
S125 -DRZ10624250-10G	●	2	1.062	8.55	5.55	4.25	1.65	1.65	1/4 NPT	+ 0.098	SB-4085TR	DT-15	GP-2N	ZCMT10T304 ZCMT10T304SP															
-DRZ11254500-10G	●		1.125	8.84	5.84	4.50																							
-DRZ11884750-10G	●		1.188	8.98	5.98	4.75																							
-DRZ12505000-10G	●		1.250	9.30	6.30	5.00																							
S125 -DRZ13125250-12G	●	2	1.312	9.58	6.58	5.25	1.25	2.17	1/4 NPT	+ 0.110	SB-5085TR	DT-20	GP-2N	ZCMT12T306 ZCMT12T304SP															
-DRZ13755500-12G	●		1.375	9.91	6.91	5.50																							
-DRZ14385750-12G	●		1.438	10.07	7.07	5.75																							
-DRZ15006000-12G	●		1.500	10.35	7.35	6.00																							
-DRZ15626250-12G	●		1.562	10.50	7.50	6.25																							
S125 -DRZ16256500-15G	●	2	1.625	10.73	7.73	6.50	1.25	2.17	1/4 NPT	+ 0.150	SB-5085TR	DT-20	GP-2N	ZCMT150408 ZCMT150406SP															
S150 -DRZ16886750-15G	●	1.688	11.37	7.87	6.75	1.50	2.17	1/4 NPT							+ 0.138														
-DRZ17507000-15G	●	1.750	11.70	8.20	7.00				1.50	2.17	1/4 NPT	+ 0.122																	
-DRZ18127250-15G	●	1.812	12.06	8.56	7.25								1.50	2.36		1/4 NPT	+ 0.106												
-DRZ18757500-15G	●	1.875	12.28	8.78	7.50													1.50	2.36	1/4 NPT	+ 0.087								
-DRZ19387750-15G	●	1.938	12.58	9.08	7.75																	1.50	2.36	1/4 NPT	+ 0.070				
-DRZ20008000-15G	●	2.000	12.63	9.13	8.00																					1.50	2.36	1/4 NPT	+ 0.055
-DRZ20008000-15G	●	2.000	12.63	9.13	8.00																								

- When offset machining, reduce feed rate to .002ipr or less
- See ● Page 77 for Adjustable Sleeve ASL.

- : Stock Standard
- : World Express

Recommended Cutting Conditions ● Page 19

DRZ (Drilling Depth : 5 x D) Inch Dimension

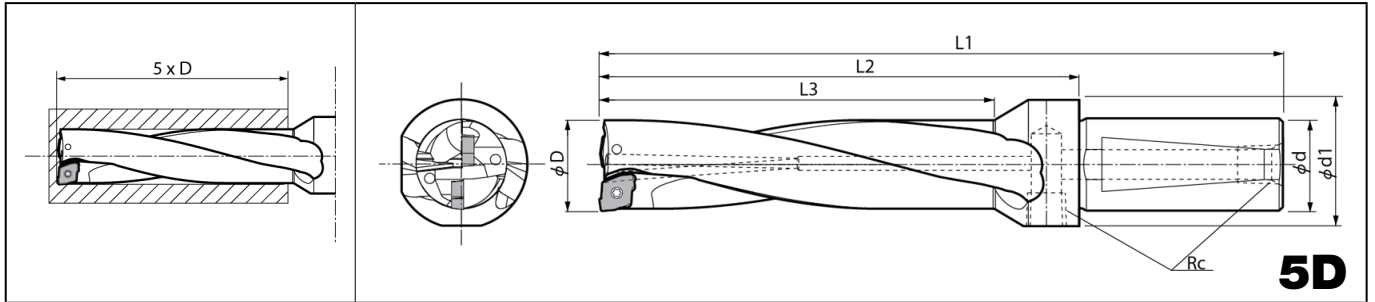

● Toolholder Dimensions

Description	Stock	No. of Insert	Dimension (inch)						Rc	Max. Offset (Radial)	Spare Parts		Applicable Inserts ● Page 6				
			ØD	L1	L2	L3	Ød	Ød1			Insert Screw	Wrench					
S125 -DRZ10625310-10G	●	2	1.062	9.61	6.61	5.31	1.25	1.65	1/4 NPT	+0.098	SB-4085TR	DT-15	ZCMT10T304 ZCMT10T304SP				
-DRZ11255625-10G	●		1.125	9.97	6.97	5.63								1.77	+0.073		
-DRZ11885940-10G	●		1.188	10.17	7.17	5.94										+0.067	
-DRZ12506250-10G	●		1.250	10.55	7.55	6.25											+0.047
-DRZ13126560-12G	●		1.312	10.89	7.89	6.56	1.25	2.17	1/4 NPT	+0.110	SB-5085TR	DT-20	ZCMT12T306 ZCMT12T304SP				
-DRZ13756875-12G	●		1.375	11.28	8.28	6.88								+0.094			
-DRZ14387190-12G	●		1.438	11.51	8.51	7.19									+0.078		
-DRZ15007500-12G	●		1.500	11.85	8.85	7.50										+0.067	
-DRZ15627810-12G	●		1.562	12.07	9.07	7.81	1.25	2.17	1/4 NPT	+0.047	SB-5085TR	DT-20	ZCMT150408 ZCMT150406SP				
-DRZ16258130-15G	●		1.625	12.35	9.35	8.13								+0.150			
S150 -DRZ16888440-15G	●	1.688	13.05	9.55	8.44	1.50									2.36	1/4 NPT	+0.138
-DRZ17508750-15G	●	1.750	13.45	9.95	8.75		2.17	+0.122									
-DRZ18129060-15G	●	1.812	13.87	10.37	9.06				+0.106								
-DRZ18759375-15G	●	1.875	14.15	10.65	9.38					+0.087							
-DRZ19389690-15G	●	1.938	14.51	11.01	9.69						+0.070						
-DRZ200010000-15G	●	2.000	14.63	11.13	10.00							+0.055					

- When offset machining, reduce feed rate to .002ipr or less
- See ● Page 77 for Adjustable Sleeve ASL.

- : Stock Standard
- : World Express

Recommended Cutting Conditions ● Page 19



Magic Drill DRZ

Drilling

NEW ITEM

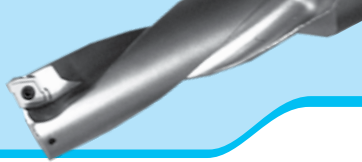

DRZ (Drilling Depth : 3 x D) Metric Dimension with Inch Shank

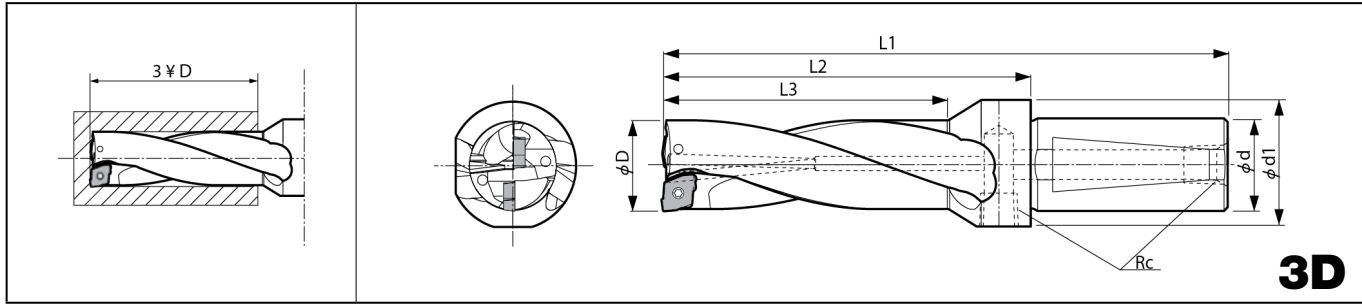



● Toolholder Dimensions

Description	Stock	No. of Insert	Dimension (inch)						Max. Offset (Radial)	Spare Parts			Applicable Inserts ● Page 6		
			ØD	L1	L2	L3	Ød	Ød1		Rc	Insert Screw	Wrench		Plug	
S075 -DRZ1339-05G	●	2	0.512 (13.0mm)	4.27	2.58	1.54	0.75	1.06	1/8 NPT	+ 0.020	SB-2045TR	FT-6	GP-1N	ZCMT050203 ZCMT050203SP ZCMT050203SU	
-DRZ135405-05G	●		0.531 (13.5mm)	4.27	2.58	1.59									+ 0.020
-DRZ1442-05G	●		0.551 (14.0mm)	4.42	2.72	1.65									+ 0.020
-DRZ145435-05G	●		0.571 (14.5mm)	4.42	2.72	1.71									+ 0.020
-DRZ1545-05G	●		0.591 (15.0mm)	4.52	2.83	1.77									+ 0.020
-DRZ155465-05G	●		0.610 (15.5mm)	4.52	2.83	1.83									+ 0.020
S100 -DRZ1648-06G	●	2	0.630 (16.0mm)	5.15	3.02	1.89	1.00	1.26	1/8 NPT	+ 0.043	SB-2260TR	DT-7	GP-1N	ZCMT06T204 ZCMT06T204SP ZCMT06T204SU	
-DRZ165495-06G	●		0.650 (16.5mm)	5.15	3.02	1.95									+ 0.035
-DRZ1751-06G	●		0.669 (17.0mm)	5.23	3.10	2.01									+ 0.031
-DRZ1854-06G	●		0.709 (18.0mm)	5.36	3.23	2.13									+ 0.024
-DRZ185555-06G	●		0.728 (18.5mm)	5.36	3.23	2.19									+ 0.024
-DRZ1957-06G	●		0.748 (19.0mm)	5.48	3.35	2.24									+ 0.020
-DRZ195585-06G	●		0.768 (19.5mm)	5.48	3.35	2.30									+ 0.020
-DRZ2060-06G	●		0.787 (20.0mm)	5.61	3.49	2.36									+ 0.020
-DRZ2163-06G	●		0.827 (21.0mm)	5.76	3.64	2.48									+ 0.008
-DRZ215645-08G	●		0.846 (21.5mm)	5.77	3.65	2.54									1.00
-DRZ2266-08G	●	0.866 (22.0mm)	5.77	3.65	2.60	+ 0.063									
-DRZ225675-08G	●	0.866 (22.0mm)	5.77	3.65	2.66	+ 0.055									
-DRZ2369-08G	●	0.906 (23.0mm)	5.89	3.76	2.72	+ 0.051									
-DRZ2472-08G	●	0.945 (24.0mm)	6.00	3.87	2.84	+ 0.043									
-DRZ2575-08G	●	0.984 (25.0mm)	6.11	3.98	2.95	+ 0.031									
-DRZ2678-08G	●	1.024 (26.0mm)	6.23	4.10	3.07	1.38	+ 0.024								

● When offset machining, reduce feed rate to .003ipr or less
● See ● Page 77 for Adjustable Sleeve ASL.

■ DRZ (Drilling Depth : 3 x D) Metric Dimension with Inch Shank

● Toolholder Dimension

Description	Stock	No. of Insert	Dimension (inch)							Max. Offset (Radial)	Spare Parts			Applicable Inserts ➔ Page 6		
			ØD	L1	L2	L3	Ød	Ød1	Rc		Insert Screw	Wrench	Plug			
																
S100 -DRZ2781-10G	●	2	1.063 (27.0mm)	6.81	4.49	3.19	1.00	1.65	1/4 NPT	+ 0.098	SB-4085TR	DT-15	GP-1N	ZCMT10T304 ZCMT10T304SP		
-DRZ2884-10G	●		1.102 (28.0mm)	6.92	4.60	3.31									1.65	+ 0.087
-DRZ2987-10G	●		1.142 (29.0mm)	7.04	4.72	3.43									1.65	+ 0.079
-DRZ3090-10G	●		1.181 (30.0mm)	7.12	4.80	3.54									1.77	+ 0.067
-DRZ3193-10G	●		1.220 (31.0mm)	7.22	4.89	3.66									1.77	+ 0.059
-DRZ3296-10G	●		1.260 (32.0mm)	7.36	5.04	3.78									1.77	+ 0.047
S125 -DRZ3399-12G	●	2	1.299 (33.0mm)	8.00	5.28	3.90	1.25	2.17	1/4 NPT	+ 0.114	SB-5085TR	DT-20	GP-2N	ZCMT12T306 ZCMT12T304SP		
-DRZ34102-12G	●		1.338 (34.0mm)	8.15	5.44	4.02									+ 0.106	
-DRZ35105-12G	●		1.378 (35.0mm)	8.24	5.53	4.13									+ 0.094	
-DRZ36108-12G	●		1.418 (36.0mm)	8.37	5.65	4.25									+ 0.087	
-DRZ37111-12G	●		1.457 (37.0mm)	8.46	5.74	4.37									+ 0.075	
-DRZ38114-12G	●		1.496 (38.0mm)	8.57	5.85	4.49									+ 0.067	
-DRZ39117-12G	●		1.535 (39.0mm)	8.69	5.97	4.61									+ 0.055	
-DRZ40120-12G	●		1.575 (40.0mm)	8.74	6.03	4.72									+ 0.047	
-DRZ41123-15G	●	2	1.614 (41.0mm)	8.83	6.11	4.84	1.25	2.17	1/4 NPT	+ 0.157	SB-5085TR	DT-20	GP-2N	ZCMT150408 ZCMT150406SP		
-DRZ42126-15G	●		1.654 (42.0mm)	8.93	6.21	4.96									2.17	+ 0.146
-DRZ43129-15G	●		1.693 (43.0mm)	9.07	6.35	5.08									2.17	+ 0.138
-DRZ44132-15G	●		1.732 (44.0mm)	9.18	6.47	5.20									2.17	+ 0.126
-DRZ45135-15G	●		1.772 (45.0mm)	9.22	6.51	5.32									2.17	+ 0.118
-DRZ46138-15G	●		1.811 (46.0mm)	9.47	6.75	5.43									2.36	+ 0.106
-DRZ47141-15G	●		1.850 (47.0mm)	9.65	6.93	5.55									2.36	+ 0.098
-DRZ48144-15G	●		1.890 (48.0mm)	9.74	7.03	5.67									2.36	+ 0.087
-DRZ49147-15G	●		1.929 (49.0mm)	9.86	7.15	5.79									2.36	+ 0.079
-DRZ50150-15G	●		1.968 (50.0mm)	9.88	7.17	5.91									2.36	+ 0.067

● When offset machining, reduce feed rate to .003ipr or less
 ● See Page 77 for Adjustable Sleeve ASL.

● : Stock Standard
 ○ : World Express

Recommended Cutting Conditions Page 19



Magic Drill DRZ

Drilling

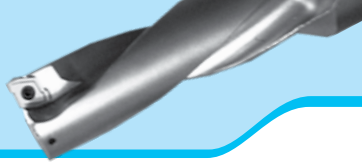

DRZ (Drilling Depth : 2 x D) Metric Dimension

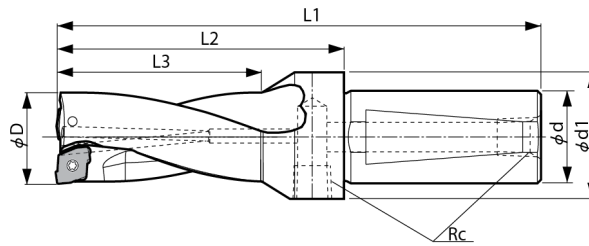
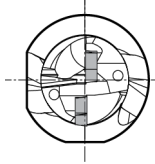
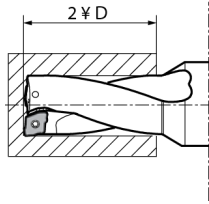

2D

Description	Stock	No. of Insert	Dimension (inch)									Max. Offset (Radial)	Spare Parts			Applicable Inserts Page 6					
			ØD	L1	L2	L3	Ød	Ød1	Rc	Insert Screw	Wrench		Plug								
S20 -DRZ1326-05	○	2	13	95	52	26	20	27	Rc 1/8	+0.5	SB-2045TR	DT-6	GP-1	ZCMT050203 ZCMT050203SP ZCMT050203SU							
-DRZ1428-05	○		14	98	55	28									+0.5						
-DRZ1530-05	○		15	100	57	30									+0.5						
S25 -DRZ1632-06	○	2	16	115	61	32	25	32	Rc 1/8	+1.1	SB-2260TR	DT-7	GP-1	ZCMT06T204 ZCMT06T204SP ZCMT06T204SU							
-DRZ1734-06	○		17	116	62	34									+0.8						
-DRZ1836-06	○		18	118	64	36									+0.6						
-DRZ1938-06	○		19	120	66	38									+0.5						
-DRZ2040-06	○		20	123	69	40									+0.5						
-DRZ2142-06	○		21	125	71	42									+0.2						
-DRZ2244-08	○		22	128	74	44									33	Rc 1/8	+1.6	SB-2570TR	DT-8	GP-1	ZCMT080304 ZCMT080304SP
-DRZ2346-08	○	23	130	76	46	+1.3															
-DRZ2448-08	○	24	131	77	48	25	35	Rc 1/8	+1.1	SB-2570TR	DT-8	GP-1	ZCMT080304 ZCMT080304SP								
-DRZ2550-08	○	25	133	79	50									+0.8							
-DRZ2652-08	○	26	135	81	52									+0.6							
S32 -DRZ2754-10	○	2	27	149	90	54	32	42	Rc 1/4	+2.5	SB-4085TR	DT-15	GP-2	ZCMT10T304 ZCMT10T304SP							
-DRZ2856-10	○		28	151	92	56									+2.2						
-DRZ2958-10	○		29	153	94	58									+2.0						
-DRZ3060-10	○		30	154	95	60									+1.7						
-DRZ3162-10	○		31	155	96	62									+1.5						
-DRZ3264-10	○	32	158	99	64	+1.2															
-DRZ4080-12	○	2	40	175	116	80	32	55	Rc 1/4	+1.2	SB-5085TR	DT-20	GP-2	ZCMT12T306 ZCMT12T304SP							
S40 -DRZ3366-12	○	2	33	173	104	66	40	55	Rc 1/4	+2.9	SB-5085TR	DT-20	GP-2	ZCMT12T306 ZCMT12T304SP							
-DRZ3468-12	○		34	176	107	68									+2.7						
-DRZ3570-12	○		35	177	108	70									+2.4						
-DRZ3672-12	○		36	180	111	72									+2.2						
-DRZ3774-12	○		37	181	112	74									+1.9						
-DRZ3876-12	○		38	183	114	76									+1.7						
-DRZ3978-12	○		39	185	116	78									+1.4						
-DRZ4080-12	○		40	185	116	80									+1.2						
-DRZ4182-15	○		41	186	117	82									55	Rc 1/4	+4.0	SB-5085TR	DT-20	GP-2	ZCMT150408 ZCMT150406SP
-DRZ4284-15	○		42	188	119	84															
-DRZ4386-15	○	43	190	121	86	40	60	Rc 1/4	+3.5	SB-5085TR	DT-20	GP-2	ZCMT150408 ZCMT150406SP								
-DRZ4488-15	○	44	192	123	88									+3.2							
-DRZ4590-15	○	45	192	123	90									+3.0							
-DRZ4692-15	○	46	198	129	92									+2.7							
-DRZ4794-15	○	47	201	132	94									+2.5							
-DRZ4896-15	○	48	203	134	96									+2.2							
-DRZ4998-15	○	49	204	135	98									+2.0							
-DRZ50100-15	○	50	204	135	100									+1.7							
-DRZ51102-15	○	51	205	136	102									+1.2							
-DRZ52104-15	○	52	205	136	104									+1.0							
-DRZ53106-15	○	53	208	139	106	+0.7															
-DRZ54108-20	○	54	214	145	108	40	65	Rc 1/4	+5.0	SB-60120TR	DT-25	GP-2	ZCMT200608								
-DRZ55110-20	○	55	215	146	110									+4.7							
-DRZ56112-20	○	56	217	148	112									+4.4							
-DRZ57114-20	○	57	219	150	114									+4.1							
-DRZ58116-20	○	58	221	152	116									+3.8							
-DRZ59118-20	○	59	223	154	118									+3.5							

■ DRZ (Drilling Depth : 3 x D) Metric Dimension

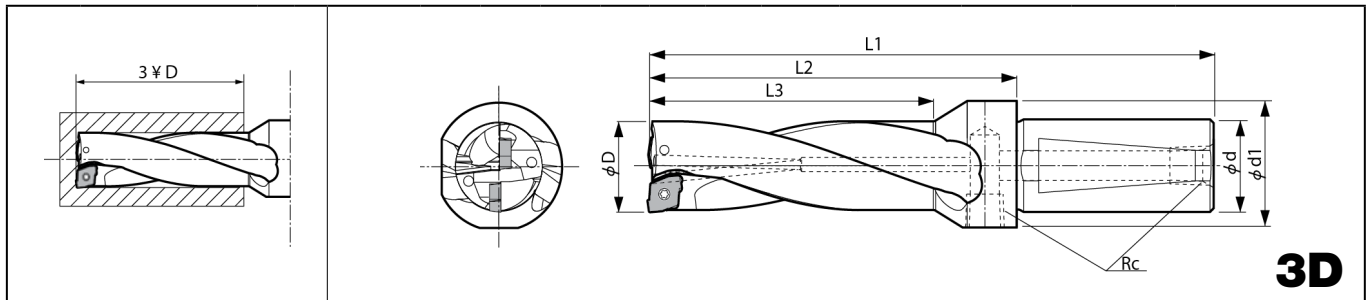

Description	Stock	No. of Insert	Dimension (inch)						Max. Offset (Radial)	Spare Parts			Applicable Inserts ➔ Page 6	
			ØD	L1	L2	L3	Ød	Ød1		Rc	Insert Screw	Wrench		Plug
S20 -DRZ1339-05	○	2	13	108	65	39	20	27	Rc 1/8	+0.5	SB-2045TR	FT-6	GP-1	ZCMT050203 ZCMT050203SP ZCMT050203SU
-DRZ135405-05	○		13.5	108	65	40.5				+0.5				
-DRZ1442-05	○		14	112	69	42				+0.5				
-DRZ145435-05	○		14.5	112	69	43.5				+0.5				
-DRZ1545-05	○		15	115	72	45				+0.5				
-DRZ155465-05	○		15.5	115	72	46.5				+0.5				
S25 -DRZ1648-06	○	2	16	131	77	48	25	32	Rc 1/8	+1.1	SB-2260TR	DT-7	GP-1	ZCMT06T204 ZCMT06T204SP ZCMT06T204SU
-DRZ165495-06	○		16.5	131	77	49.5				+0.9				
-DRZ1751-06	○		17	133	79	51				+0.8				
-DRZ175525-06	○		17.5	133	79	52.5				+0.7				
-DRZ1854-06	○		18	136	82	54				+0.6				
-DRZ185555-06	○		18.5	136	82	55.5				+0.6				
-DRZ1957-06	○		19	139	85	57				+0.5				
-DRZ195585-06	○		19.5	139	85	58.5				+0.5				
-DRZ2060-06	○		20	143	89	60				+0.5				
-DRZ205615-06	○		20.5	146	92	61.5				+0.3				
-DRZ2163-06	○		21	146	92	63				+0.2				
-DRZ215645-08	○		21.5	147	93	64.5				+1.8				
-DRZ2266-08	○		22	147	93	66				+1.6				
-DRZ225675-08	○		22.5	147	93	67.5				+1.4				
-DRZ2369-08	○	23	150	96	69	+1.3								
-DRZ235705-08	○	23.5	150	96	70.5	+1.2								
-DRZ2472-08	○	24	152	98	72	+1.1								
-DRZ245735-08	○	24.5	152	98	73.5	+0.9								
-DRZ2575-08	○	25	155	101	75	+0.8								
-DRZ255765-08	○	25.5	155	101	76.5	+0.7								
-DRZ2678-08	○	26	158	104	78	+0.6								
-DRZ265795-08	○	26.5	158	104	79.5	+0.5								
S32 -DRZ2781-10	○	2	27	173	114	81	32	42	Rc 1/4	+2.5	SB-4085TR	DT-15	GP-2	ZCMT10T304 ZCMT10T304SP
-DRZ275825-10	○		27.5	173	114	82.5				+2.3				
-DRZ2884-10	○		28	176	117	84				+2.2				
-DRZ285855-10	○		28.5	176	117	85.5				+2.1				
-DRZ2987-10	○		29	179	120	87				+2.0				
-DRZ295885-10	○		29.5	179	120	88.5				+1.8				
-DRZ3090-10	○		30	181	122	90				+1.7				
-DRZ305915-10	○		30.5	181	122	91.5				+1.5				
-DRZ3193-10	○		31	183	124	93				+1.5				
-DRZ315945-10	○		31.5	183	124	94.5	+1.3							
-DRZ3296-10	○		32	187	128	96	+1.2							
-DRZ325975-10	○		32.5	187	128	97.5	+1.0							
-DRZ3399-12	○		33	193	134	99	+2.9							
-DRZ34102-12	○		34	197	138	102	+2.7							
-DRZ35105-12	○		35	199	140	105	+2.4							
-DRZ36108-12	○		36	203	144	108	+2.2							
-DRZ37111-12	○		37	205	146	111	+1.9							
-DRZ38114-12	○		38	208	149	114	+1.7							
-DRZ39117-12	○	39	211	152	117	+1.4								
-DRZ40120-12	○	40	212	153	120	+1.2								

• When offset machining, reduce feed rate to f=0.08mm/rev (0.003ipr) or less.



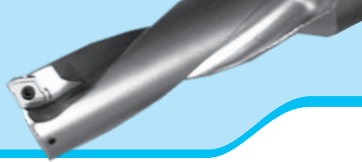

DRZ (Drilling Depth : 3 x D) Metric Dimension

Description	Stock	No. of Insert	Dimension (mm)							Max. Offset (Radial)	Spare Parts			Applicable Inserts ● Page 6	
			ØD	L1	L2	L3	Ød	Ød1	Rc		Insert Screw	Wrench	Plug		
S40 -DRZ3399-12	○	2	33	203	134	99	40	55	RC 1/4	+2.9	SB-5085TR	DT-20	GP-2	ZCMT12T306 ZCMT12T304SP	
-DRZ34102-12	○		34	207	138	102									+2.7
-DRZ35105-12	○		35	209	140	105									+2.4
-DRZ36108-12	○		36	213	144	108									+2.2
-DRZ37111-12	○		37	215	146	111									+1.9
-DRZ38114-12	○		38	218	149	114									+1.7
-DRZ39117-12	○		39	221	152	117									+1.4
-DRZ40120-12	○		40	222	153	120									+1.2
-DRZ41123-15	○		2	41	224	155									123
-DRZ42126-15	○	42		227	158	126	+3.7								
-DRZ43129-15	○	43		230	161	129	+3.5								
-DRZ44132-15	○	44		233	164	132	+3.2								
-DRZ45135-15	○	45		234	165	135	+3.0								
-DRZ46138-15	○	46		241	172	138	+2.7								
-DRZ47141-15	○	47		245	176	141	+2.5								
-DRZ48144-15	○	48		248	179	144	+2.2								
-DRZ49147-15	○	49		250	181	147	+2.0								
-DRZ50150-15	○	50		250	182	150	+1.7								
-DRZ51153-15	○	51		254	185	153	+1.2								
-DRZ52156-15	○	52		257	188	156	+1.0								
-DRZ53159-15	○	53	260	191	159	+0.7									
-DRZ54162-20	○	2	54	266	197	162	40	65	RC 1/4	+5.0	SB-60120TR	DT-20	GP-2	ZCMT200608	
-DRZ55165-20	○		55	269	200	165									+4.7
-DRZ56168-20	○		56	272	203	168									+4.4
-DRZ57171-20	○		57	275	206	171									+4.1
-DRZ58174-20	○		58	278	209	174									+3.8
-DRZ59177-20	○		59	281	212	177									+3.5

• When offset machining, reduce feed rate to $f=0.08\text{mm/rev}$ (.003ipr) or less.
Recommended Cutting Conditions ● Page 19

● : Stock Standard
○ : World Express



Magic Drill DRZ

Drilling

■ DRZ (Drilling Depth : 4 x D) Metric Dimension

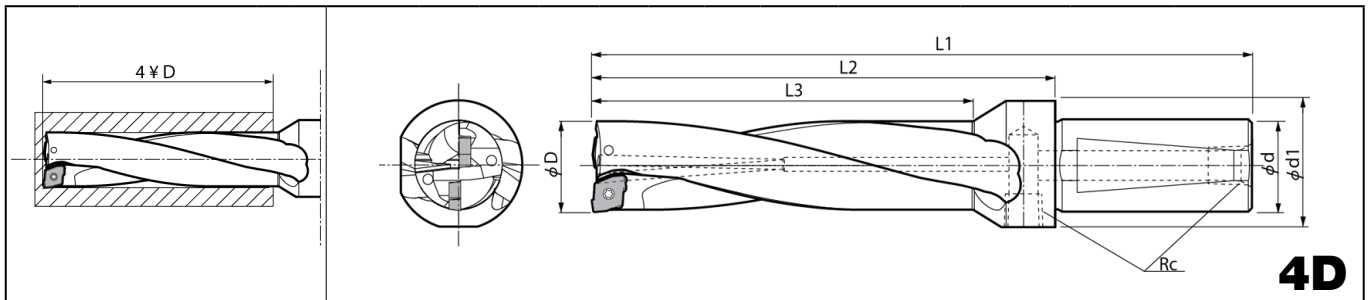

Description	Stock	No. of Insert	Dimension (mm)							Max. Offset (Radial)	Spare Parts			Applicable Inserts Page 6								
			ØD	L1	L2	L3	Ød	Ød1	Rc		Insert Screw	Wrench	Plug									
S20 -DRZ1352-05	○	2	13	121	78	52	20	27	Rc 1/8	+0.5	SB-2045TR	FT-6	GP-1	ZCMT050203 ZCMT050203SP ZCMT050203SU								
-DRZ135540-05	○		13.5	123	79	54				+0.5												
-DRZ1456-05	○		14	126	83	56				+0.5												
-DRZ145580-05	○		14.5	127	84	58				+0.5												
-DRZ1560-05	○		15	130	87	60				+0.5												
-DRZ155620-05	○		15.5	131	88	62				+0.5												
S25 -DRZ1664-06	○	2	16	147	93	64	25	32	Rc 1/8	+1.1	SB-2260TR	DT-7	GP-1	ZCMT06T204 ZCMT06T204SP ZCMT06T204SU								
-DRZ165660-06	○		16.5	146	93	66				+0.9												
-DRZ1768-06	○		17	149	95	68				+0.8												
-DRZ175700-06	○		17.5	147	97	70				+0.7												
-DRZ1872-06	○		18	153	99	72				+0.6												
-DRZ185740-06	○		18.5	155	101	74				+0.6												
-DRZ1976-06	○		19	157	103	76				+0.5												
-DRZ195780-06	○		19.5	159	105	78				+0.5												
-DRZ2080-06	○		20	156	102	80				+0.5												
-DRZ205820-06	○		20.5	163	113	82				+0.2												
-DRZ2184-06	○		21	161	107	84				+0.2												
-DRZ215860-08	○		21.5	169	115	86				+1.8												
-DRZ2288-08	○		22	169	115	88				+1.6												
-DRZ225900-08	○		22.5	169	115	90				+1.4												
-DRZ2392-08	○	23	173	119	92	+1.3																
-DRZ235940-08	○	23.5	173	118	94	+1.0																
-DRZ2496-08	○	2	24	176	122	96	25	33	Rc 1/8	+1.1	SB-2570TR	DT-8	GP-1	ZCMT080304 ZCMT080304SP								
-DRZ245980-08	○		24.5	177	123	98				+0.9												
-DRZ25100-08	○		25	180	126	100				+0.8												
-DRZ2551020-08	○		25.5	181	127	102				+0.7												
-DRZ26104-08	○		26	184	130	104				+0.6												
-DRZ2651060-08	○		26.5	185	131	106				+0.5												
-DRZ27108-10	○		2	27	200	141				108					32	42	Rc 1/4	+2.5	SB-4085TR	DT-15	GP-2	ZCMT10T304 ZCMT10T304SP
-DRZ2751100-10	○			27.5	201	142				110								+2.3				
-DRZ28112-10	○	28		204	145	112	+2.2															
-DRZ2851140-10	○	28.5		204	146	114	+2.1															
-DRZ29116-10	○	29		208	149	116	+2.0															
-DRZ2951180-10	○	29.5		209	150	118	+1.8															
-DRZ30120-10	○	30		211	152	120	+1.7															
-DRZ3051220-10	○	30.5		212	153	122	+1.6															
-DRZ31124-10	○	31		214	155	124	+1.5															
-DRZ3151260-10	○	31.5		216	157	126	+1.3															
-DRZ32128-10	○	32		219	160	128	+1.2															
-DRZ3251300-10	○	32.5		220	161	130	+1.1															
-DRZ33132-12	○	2	33	236	167	132	32	55	Rc 1/4	+2.9	SB-5085TR	DT-20	GP-2	ZCMT12T306 ZCMT12T304SP								
-DRZ34136-12	○		34	231	172	136				+2.7												
-DRZ35140-12	○		35	234	175	140				+2.4												
-DRZ36144-12	○		36	239	180	144				+2.2												
-DRZ37148-12	○		37	242	183	148				+1.9												
-DRZ38152-12	○		38	246	187	152				+1.7												
-DRZ39156-12	○		39	250	191	156				+1.4												
-DRZ40160-12	○		40	252	193	160				+1.2												

• When offset machining, reduce feed rate to f=0.08mm/rev (0.003ipr) or less.



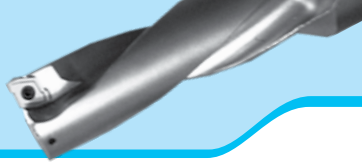

DRZ (Drilling Depth : 4 x D) Metric Dimension

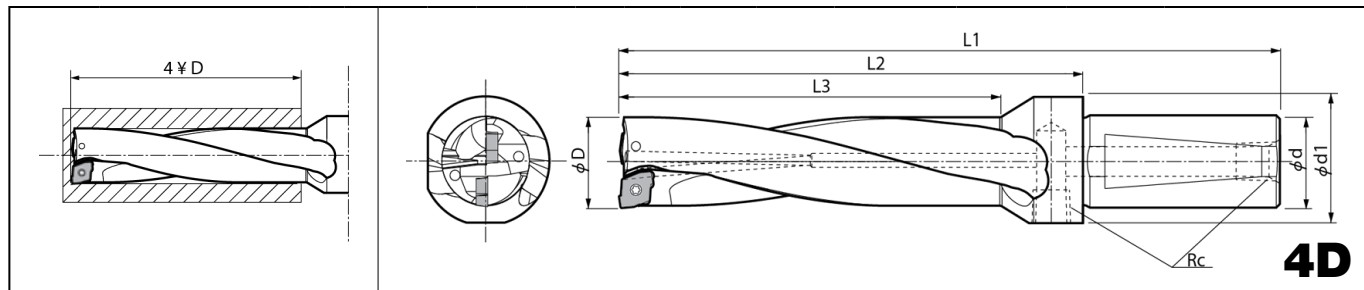

Description	Stock	No. of Insert	Dimension (mm)							Max. Offset (Radial)	Spare Parts			Applicable Inserts ➡ Page 6
			ØD	L1	L2	L3	Ød	Ød1	Rc		Insert Screw	Wrench	Plug	
S40 -DRZ33132-12	○	2	33	236	167	132	40	55	Rc1/4	+2.9	SB-5085TR	DT-20	GP-2	ZCMT12T306 ZCMT12T304SP
-DRZ34136-12	○		34	241	172	136				+2.7				
-DRZ35140-12	○		35	244	175	140				+2.4				
-DRZ36144-12	○		36	249	180	144				+2.2				
-DRZ37148-12	○		37	252	183	148				+1.9				
-DRZ38152-12	○		38	256	187	152				+1.7				
-DRZ39156-12	○		39	260	191	156				+1.4				
-DRZ40160-12	○		40	262	193	160				+1.2				
-DRZ41164-15	○	2	41	265	196	164	40	55	Rc1/4	+4.0	SB-5085TR	DT-20	GP-2	ZCMT150408 ZCMT150406SP
-DRZ42168-15	○		42	269	200	168				+3.7				
-DRZ43172-15	○		43	273	204	172				+3.5				
-DRZ44176-15	○		44	277	208	176				+3.2				
-DRZ45180-15	○		45	279	210	180				+3.0				
-DRZ46184-15	○		46	287	218	184				+2.7				
-DRZ47188-15	○		47	292	223	188				+2.5				
-DRZ48192-15	○		48	296	227	192				+2.2				
-DRZ49196-15	○	2	49	300	231	196	40	60	Rc1/4	+2.0	SB-5085TR	DT-20	GP-2	ZCMT150408 ZCMT150406SP
-DRZ50200-15	○		50	301	232	200				+1.7				

• When offset machining, reduce feed rate to f=0.08mm/rev (0.003ipr) or less.
Recommended Cutting Conditions ➡ Page 19

● : Stock Standard
○ : World Express

■ DRZ (Drilling Depth : 5 x D) Metric Dimension

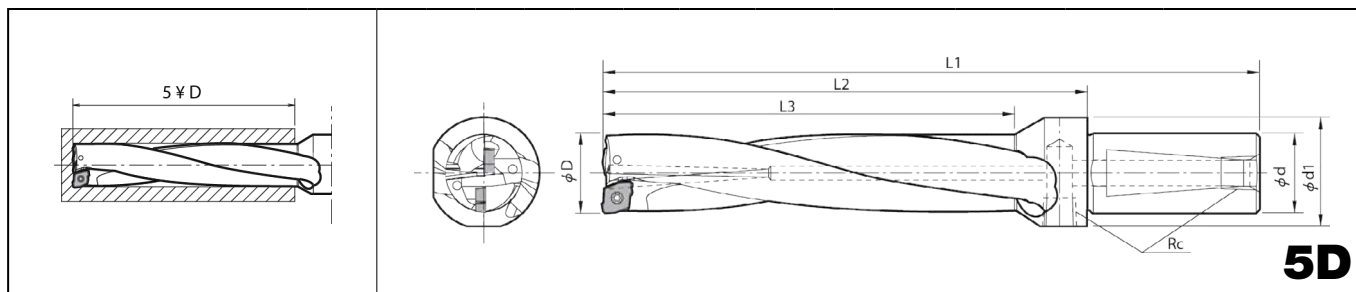

Description	Stock	No. of Insert	Dimension (mm)							Max. Offset (Radial)	Spare Parts			Applicable Inserts ● Page 6	
			ØD	L1	L2	L3	Ød	Ød1	Rc		Insert Screw	Wrench	Plug		
S32 -DRZ27135-10 -DRZ28140-10 -DRZ29145-10 -DRZ30150-10 -DRZ32160-10	○	2	27	227	168	135	32	42	Rc1/4	+2.5	SB-4085TR	DT-15	GP-2	ZCMT10T304 ZCMT10T304SP	
	○		28	232	173	140									+2.2
	○		29	237	178	145									+2.0
	○		30	241	182	150									+1.7
	○		32	251	192	160									+1.2
S40 -DRZ33165-12 -DRZ34170-12 -DRZ35175-12 -DRZ36180-12 -DRZ37185-12 -DRZ39195-12 -DRZ40200-12 -DRZ43215-15 -DRZ45225-15 -DRZ50250-15	○	2	33	269	200	165	40	55	Rc1/4	+2.9	SB-5085TR	DT-20	GP-2	ZCMT12T306 ZCMT12T304SP	
	○		34	275	206	170									+2.7
	○		35	279	210	175									+2.4
	○		36	285	216	180									+2.2
	○		37	289	220	185									+1.9
	○		39	299	230	195									+1.4
	○		40	302	233	200									+1.2
	○		43	316	247	215									+3.5
	○		45	324	255	225									+3.0
	○		50	351	282	250									+1.7

Recommended Cutting Conditions ● Page 19

● : Stock Standard
○ : World Express



Magic Drill DRZ

Drilling

Magic Drill DRZ

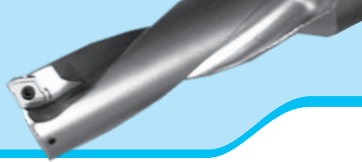

DRZ Recommended Cutting Conditions (Coolant)

Workpiece Material	Recommended Insert Grades (Cutting Speed Vc: sfm)										Cutting Diameter ØDc (inch)	Holder Type (Cutting Depth)			
	MEGACOAT			PVD Coated Carbide						Carbide		2D	3D	4D	5D
	PR1230	PR1225	PR1210	PR660	PR830	PR915	PR1025	PR930	PR905	KW10					
	Standard SP SU	Standard SP SU	Standard	Standard SP SU	Standard SP	Standard	Standard SP SU	Standard SP	Standard	Standard SP					
Low Carbon Steel	★	☆	-	☆	☆	☆	☆	☆	-	-	Ø0.512~Ø0.610	.0024~.0039	.0024~.0039	.0016~.0032	-
	400-725	400-725	-	400-725	400-800	400-800	400-725	400-725	-	-	Ø0.630~Ø1.024	.0032~.0059	.0032~.0059	.0024~.0047	-
											Ø1.063~Ø1.968	.0032~.0071	.0032~.0059	.0024~.0047	.0020~.0035
											Ø1.969~	.0032~.0071	.0032~.0059	.0024~.0047	-
Carbon Steel	★	☆	-	☆	☆	☆	☆	☆	-	-	Ø0.512~Ø0.610	.0024~.0039	.0024~.0039	.0016~.0032	-
	325-525	325-525	-	325-525	400-600	400-600	325-525	325-525	-	-	Ø0.630~Ø1.024	.0032~.0059	.0032~.0059	.0024~.0047	-
											Ø1.063~Ø1.968	.0032~.0071	.0032~.0059	.0024~.0047	.0020~.0035
											Ø1.969~	.0032~.0071	.0032~.0059	.0024~.0047	-
Alloy Steel	★	☆	-	☆	☆	☆	☆	☆	-	-	Ø0.512~Ø0.610	.0024~.0039	.0024~.0039	.0016~.0032	-
	250-460	250-460	-	250-460	325-525	325-525	250-460	250-460	-	-	Ø0.630~Ø1.024	.0032~.0059	.0032~.0059	.0024~.0047	-
											Ø1.063~Ø1.968	.0032~.0071	.0032~.0059	.0024~.0047	.0020~.0035
											Ø1.969~	.0032~.0071	.0032~.0059	.0024~.0047	-
Mold Steel	★	☆	-	☆	☆	☆	☆	☆	-	-	Ø0.512~Ø0.610	.0016~.0032	.0016~.0032	.0012~.0028	-
	230-425	230-425	-	230-425	250-500	250-500	230-425	230-425	-	-	Ø0.630~Ø1.024	.0032~.0047	.0024~.0039	.0024~.0032	-
											Ø1.063~Ø1.968	.0032~.0059	.0024~.0047	.0024~.0039	.0016~.0028
											Ø1.969~	.0032~.0059	.0024~.0047	.0024~.0039	-
Stainless Steel (Austenitic related)	☆	★	-	☆	☆	☆	☆	☆	-	-	Ø0.512~Ø0.610	.0016~.0032	.0016~.0032	.0012~.0024	-
	200-400	200-400	-	200-400	230-460	230-460	200-400	200-400	-	-	Ø0.630~Ø1.024	.0024~.0039	.0024~.0039	.0016~.0032	-
											Ø1.063~Ø1.968	.0024~.0039	.0024~.0047	.0016~.0032	.0016~.0028
											Ø1.969~	.0024~.0047	.0024~.0047	.0016~.0032	-
Gray Cast Iron	-	-	★	-	-	-	-	-	☆	☆	Ø0.512~Ø0.610	.0032~.0047	.0032~.0039	.0024~.0032	-
			325-500	-	-	-	-	-	325-500	325-400	Ø0.630~Ø1.024	.0039~.018	.0039~.0059	.0032~.0047	-
											Ø1.063~Ø1.968	.0039~.0078	.0039~.018	.0032~.0059	.0024~.0039
											Ø1.969~	.0039~.0078	.0039~.018	.0032~.0059	-
Nodular Cast Iron	-	-	★	-	-	-	-	-	☆	☆	Ø0.512~Ø0.610	.0032~.0047	.0032~.0039	.0024~.0032	-
			250-400	-	-	-	-	-	250-400	250-325	Ø0.630~Ø1.024	.0039~.018	.0039~.0059	.0032~.0047	-
											Ø1.063~Ø1.968	.0039~.0078	.0039~.018	.0032~.0059	.0024~.0039
											Ø1.969~	.0039~.0078	.0039~.018	.0032~.0059	-
Non-ferrous Metals	-	-	-	-	-	-	-	-	-	★	Ø0.512~Ø0.610	.0024~.0047	.0024~.0039	.0016~.0032	-
										600-2000	Ø0.630~Ø1.024	.0032~.0071	.0032~.0059	.0024~.0059	-
											Ø1.063~Ø1.968	.0032~.0078	.0032~.0071	.0024~.0059	.0020~.0039
Titanium Alloys	-	-	-	-	-	-	-	-	-	★	Ø0.512~Ø0.610	.0020~.0024	.0020~.0024	.0020~.0024	-
										130-230	Ø0.630~Ø1.024	.0020~.0028	.0020~.0028	.0020~.0028	-
											Ø1.063~Ø1.968	.0024~.0032	.0024~.0032	.0024~.0032	.0016~.0020
											Ø1.969~	.0024~.0032	.0024~.0032	.0024~.0032	-

• Apply a sufficient amount of coolant.

★ 1st Recommendation ☆: 2nd Recommendation









Magic Drill DRZ

Drilling

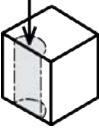
◆Cutting Conditions by Application

(Work Material : 1050)

Application		Plain Surface	Slant Surface	Half Cylindrical	Hole Expansion	Concave Surface	Pre-drilled Surface	Stacked Plates
Workpiece Shape								
DRS	SFM	270	270	Not Recommended	Not Recommended	270		
	f (ipr)	0.003	0.0016	Not Recommended	Not Recommended	Concave Part 0.0016 Continuous Part 0.003		
DRZ	SFM	400	400	400	400	400		
	f (ipr)	0.004	0.002	0.002	0.002	Concave Part 0.002 Continuous Part 0.004		
Coolant		Yes	Yes	Yes	Yes	Yes	-	-



Magic Drill DRX

Drilling

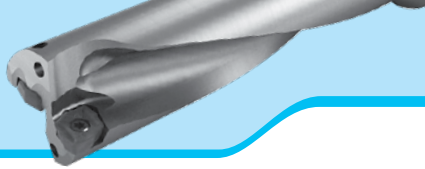

Magic Drill DRX

- New 5xD inch-size offering
- New twisted coolant hole technology for improved chip evacuation
- Three new chipbreakers for a variety of workpiece materials
- New MEGACOAT insert grades cover a variety of applications
- Balanced cutting system for precision drilling and excellent surface finishes
- New Technology: Twisted Coolant Holes

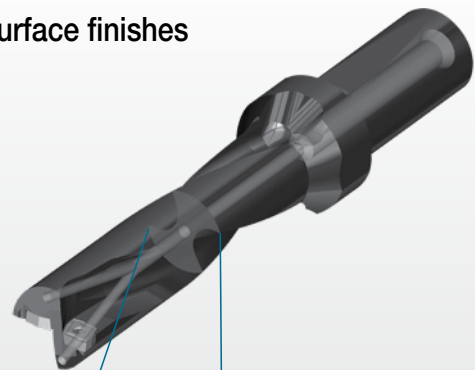
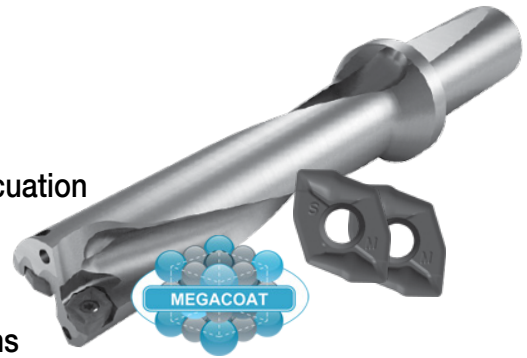

Magic Drill DRX

Drilling

Twisted Coolant Hole technology design provides

Superior Chip Evacuation



The flute space of the internal cutting edge side is 1.6 times larger than the DRZ style drill, providing increased chip evacuation

The coolant performance has 1.25 times more volume than the DRZ style drill

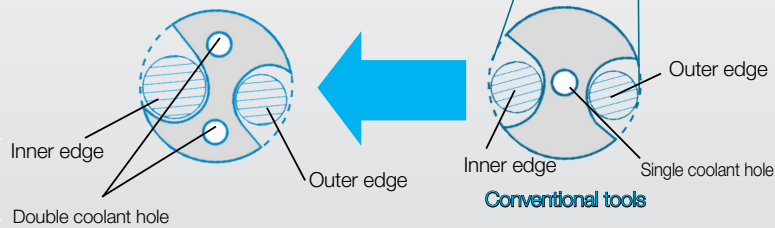

The special alloy provides tool holder rigidity and increased reliability



■ Three New MEGACOAT Insert Grades

(PR1230: for Steel, PR1225: for Stainless Steel / Low Carbon Steel, PR1210: for Cast Iron)

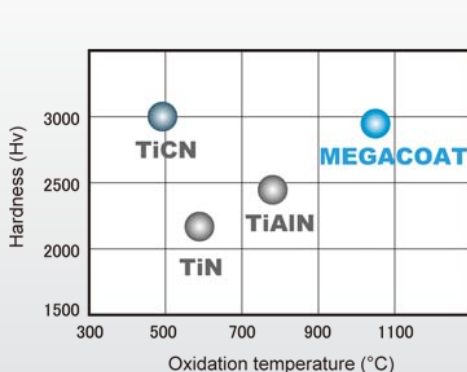

MEGACOAT Coating Technology provides longer and more stable tool life

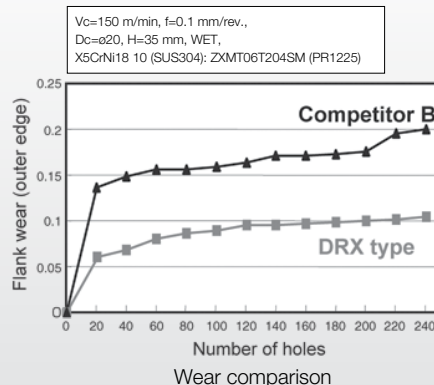

MEGACOAT achieves better wear resistance than competitor B achieving longer tool life

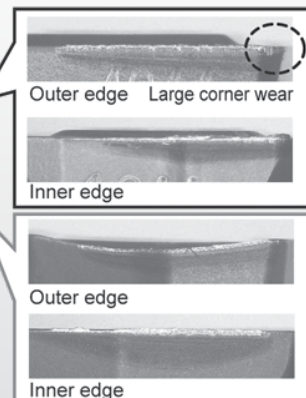

Balanced Cutting System

Vibration comparison

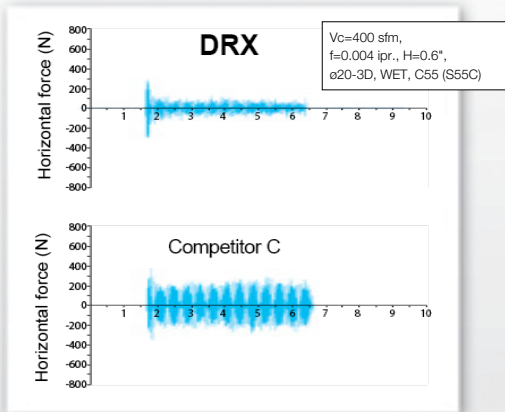

Less vibration due to balanced cutting system

Better surface finish

Variation of drilling diameter

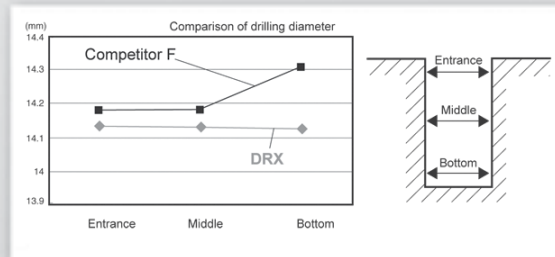

Surface finish comparison

$V_c=600 \text{ sfm}$, $f=0.006 \text{ ipr}$, $H=2.4''$ (through hole),
 $\phi 20\text{-}3\text{D}$, WET, C45 (S45C), NC Lathe

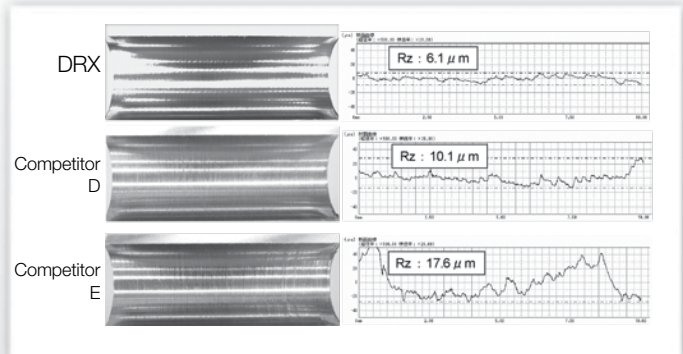

Better surface finish than Competitor D and E

$V_c=180\text{m/min}$, $f=0.08\text{mm/rev.}$, $H=56\text{mm}$ (blind hole),
 $\phi 14\text{-}4\text{D}$, WET, C50

Compared to competitor F, the DRX's excellent chip evacuation performance provides good balance and less variation in cutting dia. drastically improving straight machining capability

New chipbreaker design covers a variety of workplace materials

New chipbreaker features

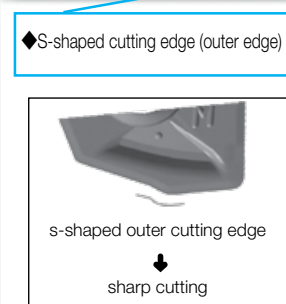
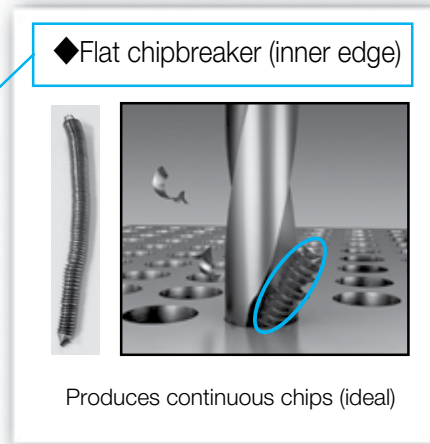
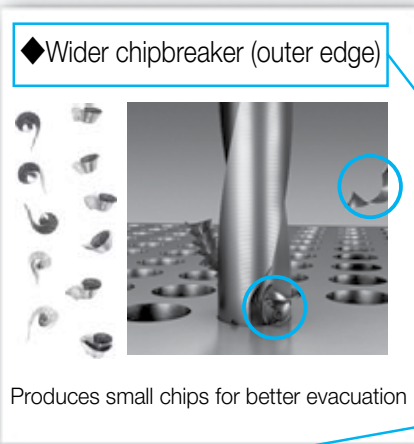

$V_c=120\text{m/min}$, $f=0.1\text{mm/rev.}$, $H=15\text{mm}$, $\phi 20\text{-}3\text{D}$, WET, C55 (S55C)

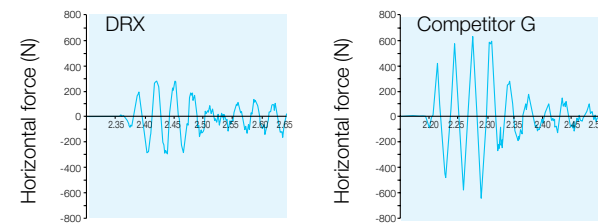

Cutting force comparison of outer edge at the start of drilling

Lowered impact force at the start

Reduces sudden breakage



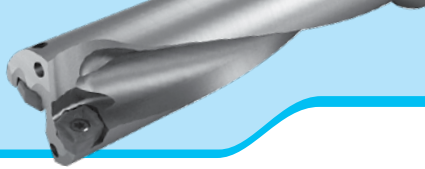

Chipbreaker Selection

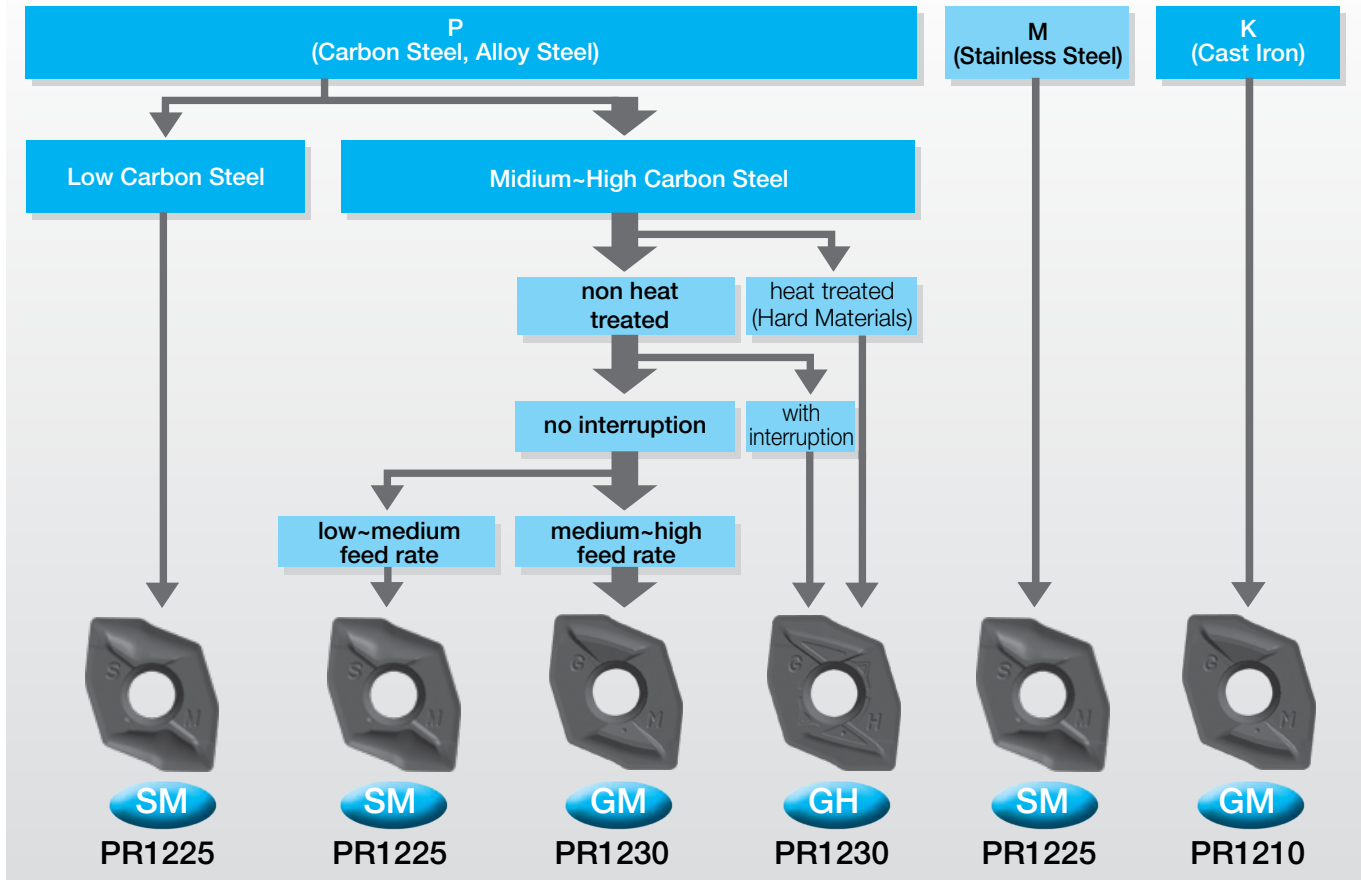

Magic Drill DRX

Drilling



Three chipbreakers for a variety of materials

◆ GM Chipbreaker...General Cutting

For Steel: PR1230 For Cast Iron: PR1210

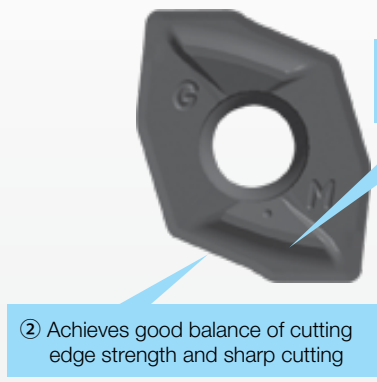

① Wider chipbreaker can cover a variety of materials

② Achieves good balance of cutting edge strength and sharp cutting

For general cutting

Optimized cutting edge strength, sharpness and chip control

◆ GH Chipbreaker...Tough Edge

For hard materials, interrupted machining: PR1230

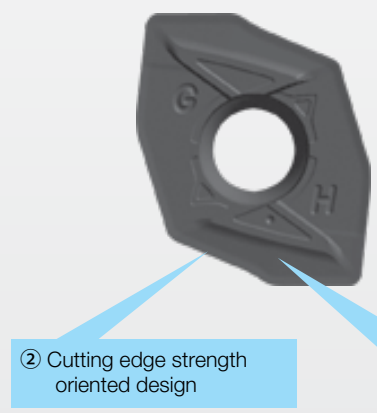

② Cutting edge strength oriented design

1st recommended chipbreaker for hard materials & interrupted operations

Cutting edge strength oriented design of chipbreaker

① Wider chipbreaker control breakage by pressed chips

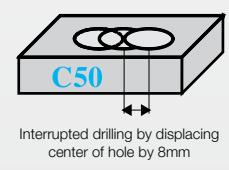

Interrupted drilling by displacing center of hole by 8mm

• Chipping resistance comparison

Vc=260 sfm, f=0.003 ipr, H=0.39", Dc=ø.79", 3D type, WET, C50 (S50C)

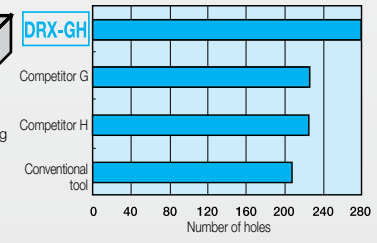

Better chipping resistance than competitors

◆ SM Chipbreaker...Sharp Cutting for Deeper Drilling

For Stainless Steel, Low Carbon Steel: PR1225

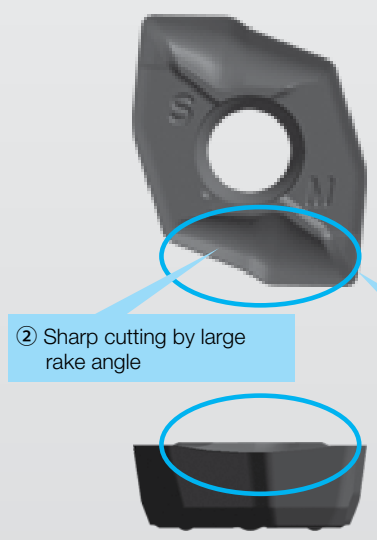

② Sharp cutting by large rake angle

① U-shaped cutting edge breaks chips by growing cracks from both ends

Outstanding chip control achieved by splitting chips from the outer edges

For deep drilling of difficult to control chips materials such as stainless steel and low carbon steel

Sharp cutting by large rake angle
Stable chip control by newly designed chipbreaker and U-shaped cutting edge

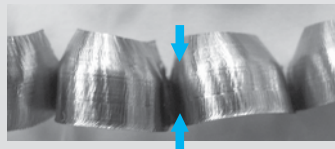

Chip breaking system of SM chipbreaker (Outer edge)







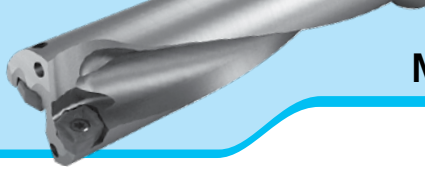

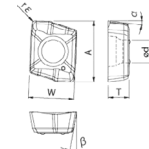

Magic Drill DRX

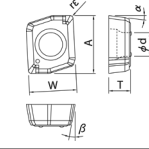
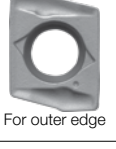
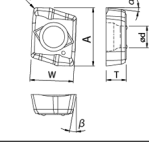
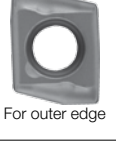
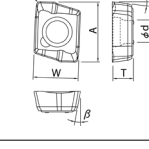
Magic Drill DRX Inserts

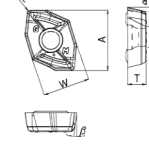

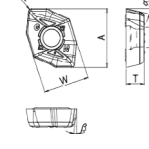
Drilling Magic Drill DRX

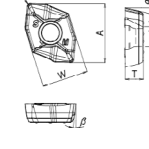
Insert		Description	Dimension (mm)					Angle (°)		MEGACOAT			Carbide	Reference Page for Toolholder				
			A	T	ød	W	re	α	β	PR1230	PR1225	PR1210			GW15			
			Classification of Usage ★ : 1st Choice ☆ : 2nd Choice (Steel; non heat treated)															
								P		Carbon steel / Alloy steel			★	☆				
								M		Mold Steel			★	☆				
								M		Stainless Steel			☆	★				
								K		Cast Iron					★			
								N		Non-ferrous Metals						★		
		ZXMT 030203GM-E	0.256	0.091	0.094	0.189	0.012	7°	10°			○						
		ZXMT 030203GM-I	0.232	0.091	0.094	0.189	0.012	7°	10°			○	○	○	○			
		ZXMT 030203GH-E	0.256	0.091	0.094	0.189	0.012	7°	10°			○						
		ZXMT 030203SM-E	0.256	0.091	0.094	0.189	0.012	7°	10°				○		○			
		ZXMT 040203GM	0.244	0.102	0.094	0.201	0.012	13°	7°			○			●			
		05T203GM	0.287	0.108	0.098	0.217	0.012					○				●		
		06T204GM	0.339	0.114	0.110	0.252	0.016					○						
		070305GM	0.402	0.128	0.118	0.315	0.020					○					●	
		09T306GM	0.480	0.159	0.142	0.378	0.024					●					○	
		11T306GM	0.571	0.160	0.181	0.457	0.024					○					○	
		140408GM	0.709	0.192	0.224	0.567	0.031					●					○	
		170608GM	0.870	0.259	0.268	0.697	0.031					●					○	
		ZXMT 040203GH	0.244	0.102	0.094	0.201	0.012	13°	7°			○						
		05T203GH	0.287	0.108	0.098	0.217	0.012					○						
		06T204GH	0.339	0.114	0.110	0.252	0.016					○						
		070305GH	0.402	0.128	0.118	0.315	0.020					○						
		09T306GH	0.480	0.159	0.142	0.378	0.024					○						
		11T306GH	0.571	0.160	0.181	0.457	0.024					○						
		140408GH	0.709	0.192	0.224	0.567	0.031					○						
		170608GH	0.870	0.259	0.268	0.697	0.031					○						
		ZXMT 040203SM	0.244	0.102	0.094	0.201	0.012	13°	7°				○			○		
		05T203SM	0.287	0.108	0.098	0.217	0.012											○
		06T204SM	0.339	0.114	0.110	0.252	0.016											○
		070305SM	0.402	0.128	0.118	0.315	0.020											○
		09T306SM	0.480	0.159	0.142	0.378	0.024											○
		11T306SM	0.571	0.160	0.181	0.457	0.024											○
		140408SM	0.709	0.192	0.224	0.567	0.031											○
		170608SM	0.870	0.259	0.268	0.697	0.031											○

Page 27-34

Suitable Chipbreaker (ZXMT)

Workpiece Material	Insert Type	ZXMT type											
	Chipbreaker	GM				GH				SM			
	Cutting Depth	2D	3D	4D	5D	2D	3D	4D	5D	2D	3D	4D	5D
Low Carbon Steel		☆	☆	☆	☆					★	★	★	★
Carbon steel		★	★	★	☆	☆	☆	☆	☆	☆	☆	☆	★
Alloy Steel		★	★	★	☆	☆	☆	☆	☆	☆	☆	☆	★
Mold steel		☆	☆	☆	☆	★	★	★	★				
Stainless Steel										★	★	★	★
Cast Iron		★	★	★	★								
Aluminum Alloys										★	★	★	★
Brass										★	★	★	★
Titanium Alloys										★	★	★	★

★: 1st Recommendation ☆: 2nd Recommendation

How to select ZXMT03

ZXMT03 type (Cutting Dia.: Ø12~Ø13)

- For outer edge, please select "E" insert from three different chipbreakers for each application.
- For inner edge, please select "I" insert (GM chipbreaker only).

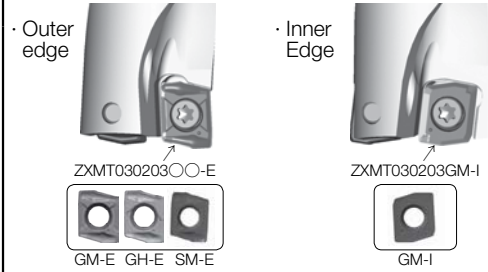

Advantages of the Chipbreaker

Chipbreaker		GM	GH	SM
Insert				
Advantages		1st. recommendation for carbon steel and alloy steel, 1st. recommendation for cast iron.	1st. recommendation for interrupted machining and hard materials. Cutting edge strength oriented design.	Suitable for sticky materials such as stainless steel and low carbon steel
		Good balance of sharp cutting and cutting edge strength	Middle to high feed rates of steel machining, GM Chipbreaker alternative	Sharp cutting, prevents chattering. For low to medium feed rates of steel.
Outer edge	Chipbreaker Cross-section			
	Chips from Outer edge			
Inner edge	Chipbreaker Cross-section			
	Chips from Inner edge			
Workpiece Material		S50C	S50C	SUS304

Indication of tool life of Magic Drill

How to judge tool life	Indication of judging tool life
Judgement of tool condition and insert wear	When an insert is new the holder is slightly bent to the side during cutting. (Therefore, the cutting diameter is slightly bigger during cutting). Once cutting is finished, the holder will return back to normal size. No tool marks will appear on the finished surface. (Although this depends on workpiece and cutting condition: during external machining slight tool mark might appear.)
	When an insert is at the end of its tool life, Gradually the external corner part gets worn out, the holder does not bend slightly outwards - it starts to bend inwards. After the cutting is finished, the holder returns to the normal position. When taking off a holder under this condition the cutting edge of the insert creates external tool marks on the finished surface of the workpiece.
Checking cutting diameter	When cutting diameter is measured, suddenly it shows small diameter. In this case, a worn out insert can be the cause.
Checking the surface on the exit side	If insert wear progresses, the burrs of penetrated hole entrance becomes bigger. This is a clear indication that the tool must be exchanged.
Variation of cutting noise	Light cutting noise at the beginning turns to brady noise which contains vibration noise.
Variation of vibration	As the end of tool life is getting closer, there is more vibration and the cutting noise changes. However, when machining smaller diameters these factors are difficult to detect.



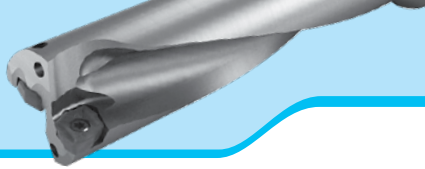

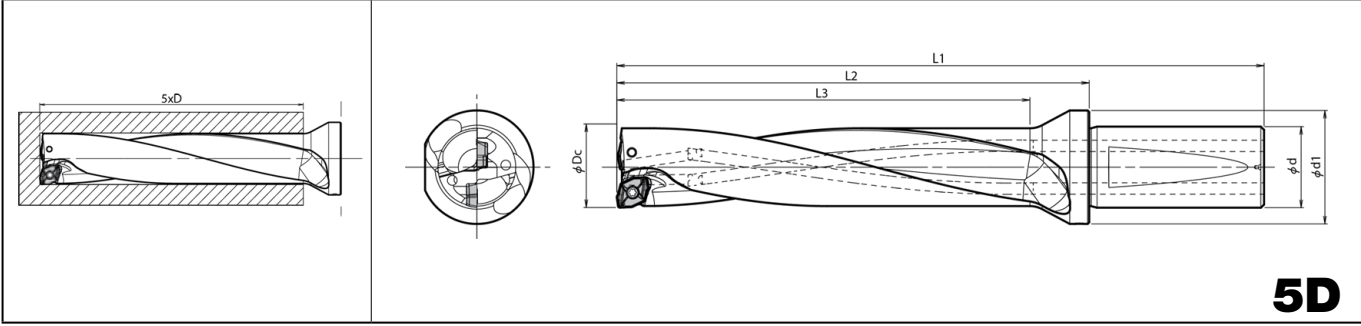

DRX (Drilling Depth : 5 x D) Inch Diameter



● Toolholder Dimensions

Description	Stock	No. of insert	Dimension (mm)							Max. Offset (Radial) (mm)	Spare Parts		Applicable Insert ● Page 25
			ØDc	L1	L2	L3	Ød	Ød1	Insert Screw		Wrench		
													
S075 -DRX0562-5-04	○	2	0.562	5.34	3.65	2.81	0.75	1.06	+0.012	SB-2042TRG	DTM-6	ZXMT040203ss	
S100 -DRX0625-5-05	○	2	0.625	6.18	4.05	3.13	1.00	1.26	+0.028	SB-2045TR	DTM-6	ZXMT05T203ss	
-DRX0656-5-05	○		0.656	6.33	4.20	3.28			+0.020				
-DRX0688-5-05	○		0.688	6.49	4.37	3.44			+0.012				
-DRX0750-5-06	○	2	0.750	6.72	4.59	3.75	1.00	1.26	+0.031	SB-2250TR	DTM-7	ZXMT06T204ss	
-DRX0812-5-06	○		0.812	7.03	4.90	4.06			+0.016				
-DRX0875-5-07	○	2	0.875	7.32	5.20	4.38	1.00	1.38	+0.043	SB-2570TR	DTM-8	ZXMT070305ss	
-DRX0906-5-07	○		0.906	7.48	5.36	4.53			+0.035				
-DRX0938-5-07	○		0.938	7.64	5.51	4.69			+0.028				
-DRX0984-5-07	○		0.984	7.87	5.74	4.92			+0.016				
-DRX1000-5-07	○		1.000	7.95	5.82	5.00			+0.012				

- When offset machining, reduce feed rate to .002ipr or less
- See ● Page 77 for Adjustable Sleeve SHE.

● : Stock Standard
○ : World Express
Recommended Cutting Conditions ● Page 35

Drilling Magic Drill DRX

■ DRX (Drilling Depth : 2 x D) Metric Diameter

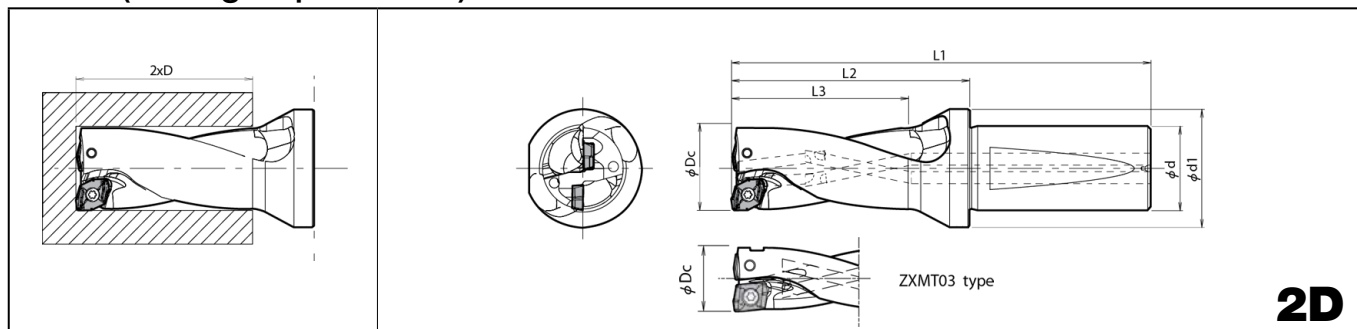

● Toolholder Dimensions

Description	Stock	No. of insert	Dimension (mm)						Max. Offset (Radial) (mm)	Spare Parts		Applicable Insert ● Page 25		
			ØDc	L1	L2	L3	Ød	Ød1		Insert Screw	Wrench			
S20 -DRX120M-2-03	○	2	12	88	45	24	20	27	+0.5	SB-2042TRG	DTM-6	ZXMT030203ss-E (External) ZXMT030203GM-I (Internal)		
-DRX125M-2-03	○		12.5	89	46	25							+0.4	
-DRX130M-2-03	○		13	90	47	26								+0.3
S20 -DRX135M-2-04	○	2	13.5	91	48	27	20	27	+0.5	SB-2042TRG	DTM-6	ZXMT040203ss		
-DRX140M-2-04	○		14	92	49	28							+0.4	
-DRX145M-2-04	○		14.5	93	50	29								+0.3
-DRX150M-2-04	○		15	94	51	30							+0.2	
S25 -DRX155M-2-05	○	2	15.5	109	55	31	25	32	+0.8	SB-2045TR	DTM-6	ZXMT05T203ss		
-DRX160M-2-05	○		16	110	56	32							+0.7	
-DRX165M-2-05	○		16.5	111	57	33								+0.5
-DRX170M-2-05	○		17	112	58	34							+0.4	
-DRX175M-2-05	○		17.5	113	59	35								+0.3
-DRX180M-2-05	○		18	114	60	36							+0.2	
-DRX185M-2-06	○	2	18.5	112	58	37	25	32	+0.9	SB-2250TR	DTM-7	ZXMT06T204ss		
-DRX190M-2-06	○		19	113	59	38							+0.8	
-DRX195M-2-06	○		19.5	114	60	39								+0.7
-DRX200M-2-06	○		20	115	61	40							+0.5	
-DRX205M-2-06	○		20.5	116	62	41								+0.4
-DRX210M-2-06	○		21	117	63	42							+0.3	
-DRX215M-2-06	○		21.5	118	64	43								+0.2
-DRX220M-2-07	○		22	119	65	44							+1.2	
-DRX225M-2-07	○		22.5	120	66	45								+1.0
-DRX230M-2-07	○		23	121	67	46								
-DRX235M-2-07	○	23.5	122	68	47	+0.8								
-DRX240M-2-07	○	24	123	69	48		+0.7							
-DRX245M-2-07	○	24.5	124	70	49	+0.5								
-DRX250M-2-07	○	25	125	71	50		+0.4							
-DRX255M-2-07	○	25.5	126	72	51	+0.3								
-DRX260M-2-07	○	26	127	73	52		+0.2							
S32 -DRX270M-2-09	○	2	27	136	77	54	32	42	+1.6	SB-3080TR	DTM-10	ZXMT09T306ss		
-DRX280M-2-09	○		28	138	79	56							+1.3	
-DRX290M-2-09	○		29	140	81	58								+1.1
-DRX300M-2-09	○		30	142	83	60							+0.8	
-DRX310M-2-09	○		31	144	85	62								+0.6
S40 -DRX320M-2-11	○	2	32	169	100	64	40	55	+2.2	SB-4085TR	DTM-15	ZXMT11T306ss		
-DRX330M-2-11	○		33	171	102	66							+1.9	
-DRX340M-2-11	○		34	173	104	68								+1.7
-DRX350M-2-11	○		35	175	106	70							+1.4	
-DRX360M-2-11	○		36	177	108	72								+1.2
-DRX370M-2-11	○		37	179	110	74							+0.9	
-DRX380M-2-11	○		38	181	112	76								+0.7

● When offset machining, reduce feed rate to .003ipr or less
 ● See ● Page 77 for Adjustable Sleeve SHE.

● : Stock Standard
 ○ : World Express



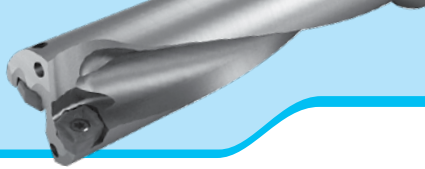

● Toolholder Dimensions

Description	Stock	No. of insert	Dimension (mm)					Max. Offset (Radial) (mm)	Spare Parts		Applicable Insert ● Page 25	
			ØDc	L1	L2	L3	Ød		Ød1	Insert Screw		Wrench
S40 -DRX390M-2-14 -DRX400M-2-14 -DRX410M-2-14 -DRX420M-2-14 -DRX430M-2-14 -DRX440M-2-14 -DRX450M-2-14 -DRX460M-2-14 -DRX470M-2-14	○	2	39	179	110	78	40	55	+2.8	SB-5090TR	DT-20	ZXMT140408ss
	○		40	181	112	80			+2.5			
	○		41	183	114	82			+2.3			
	○		42	185	116	84			+2.0			
	○		43	187	118	86			+1.8			
	○		44	189	120	88			+1.5			
	○		45	191	122	90			+1.3			
	○		46	193	124	92			+1.0			
	○		47	195	126	94			+0.8			
S40 -DRX480M-2-17 -DRX490M-2-17 -DRX500M-2-17 -DRX510M-2-17 -DRX520M-2-17 -DRX530M-2-17 -DRX540M-2-17 -DRX550M-2-17 -DRX560M-2-17 -DRX570M-2-17 -DRX580M-2-17 -DRX590M-2-17 -DRX600M-2-17	○	2	48	194	125	96	40	60	+3.8	SB-60120TR	DT-25	ZXMT170608ss
	○		49	196	127	98			+3.5			
	○		50	198	129	100			+3.3			
	○		51	200	131	102			+3.0			
	○		52	202	133	104			+2.8			
	○		53	204	135	106			+2.5			
	○		54	206	137	108		+2.3				
	○		55	208	139	110		+2.0				
	○		56	210	141	112		+1.8				
	○		57	212	143	114		+1.5				
	○		58	214	145	116		+1.3				
	○		59	216	147	118		+1.0				
	○		60	218	149	120		+0.8				

● When offset machining, reduce feed rate to .003ipr or less

● See ● Page 77 for Adjustable Sleeve SHE.

● : Stock Standard

○ : World Express

Recommended Cutting Conditions ● Page 35

● Cutting Tolerance (2D Type)

Dc	Cutting Tolerance (mm)	Dc	Cutting Tolerance (mm)	Dc	Cutting Tolerance (mm)
Ø12~Ø26	+0.20	Ø27~Ø38	+0.25	Ø39~Ø60	+0.30
	-0.10		-0.15		-0.20

* Listed tolerance is guideline numbers.

These guideline numbers may be variable depending on machines, workpieces, clamping conditions and cutting conditions.

● Magic Drill (DRX) Hole Bottom Shape (Available for 2xD, 3xD, 4xD and 5xD type) (mm)

ØDc	A	B	C	ØDc	A	B	C	ØDc	A	B	C			
12.0	1.8	4.2	0.5	24.5	3.2	9.1	0.8	39.0	5.8	13.7	1.5			
12.5		4.5		25.0		9.3		40.0		14.2				
13.0		4.7		25.5		9.6		41.0		14.7				
13.5	2	4.8	0.5	26.0	3.9	9.8	1.0	42.0	7.1	15.2	1.6			
14.0		5.0		26.5		9.4		43.0		15.7				
14.5		5.3		27.0		9.6		44.0		16.2				
15.0		5.5		27.5		9.9		45.0		16.7				
15.5		5.8		28.0		10.1		46.0		17.2				
16.0		6.0		28.5		10.4		47.0		17.7				
16.5	2.4	6.3	0.6	29.0	4.7	10.6	1.1	48.0	7.1	16.9	1.7			
17.0		6.5		29.5		10.9		49.0		17.4				
17.5		6.8		30.0		11.1		50.0		17.9				
18.0		7.0		30.5		11.4		51.0		18.4				
18.5		6.9		31.0		11.6		52.0		18.9				
19.0		7.1		31.5		11.9		53.0		19.4				
19.5	3.2	7.4	0.7	32.0	4.7	11.3	1.2	54.0	7.1	19.9	2.0			
20.0		7.6		33.0		11.8		55.0		20.4				
20.5		7.9		34.0		12.3		56.0		20.9				
21.0		8.1		35.0		12.8		57.0		21.4				
21.5		8.4		36.0		13.3		58.0		21.9				
22.0		7.8		37.0		13.8		59.0		22.4				
22.5	3.2	8.1	0.8	38.0	4.7	14.3	1.3	60.0	7.1	22.9	2.1			
23.0		8.3												
23.5		8.6												
24.0	8.8													

Chart above is for 2xD, 3xD, 4xD, and 5xD drills.
 * Figure above are nominal sizes.
 (Varies from -0.004" to +0.004" depending on work material and cutting conditions)



■ DRX (Drilling Depth : 3 x D) Metric Diameter

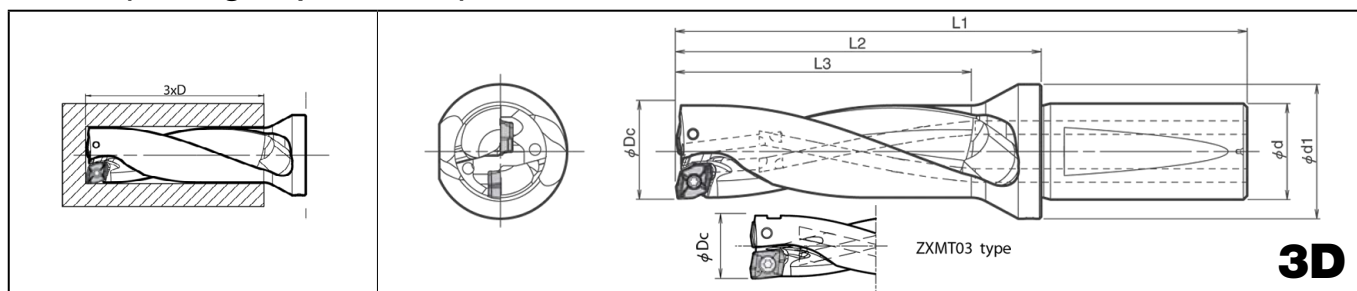

● Toolholder Dimensions

Description	Stock	No. of insert	Dimension (mm)					Max. Offset (Radial) (mm)	Spare Parts		Applicable Insert ● Page 25		
			ØDc	L1	L2	L3	Ød		Ød1	Insert Screw		Wrench	
S20 -DRX120M-3-03	○	2	12	100	57	36	20	27	+0.5	SB-2042TRG	DTM-6	ZXMT030203ss-E (External) ZXMT030203GM-I (Internal)	
-DRX125M-3-03	○		12.5	102	59	37.5							+0.4
-DRX130M-3-03	○		13	103	60	39							+0.3
S20 -DRX135M-3-04	○	2	13.5	105	62	40.5	20	27	+0.5	SB-2042TRG	DTM-6	ZXMT040203○○	
-DRX140M-3-04	○		14	106	63	42							+0.4
-DRX145M-3-04	○		14.5	108	65	43.5							+0.3
-DRX150M-3-04	○		15	109	66	45							+0.2
S25 -DRX155M-3-05	○	2	15.5	124	70	46.5	25	32	+0.8	SB-2045TR	DTM-6	ZXMT05T203○○	
-DRX160M-3-05	○		16	126	71	48							+0.7
-DRX165M-3-05	○		16.5	127	73	49.5							+0.5
-DRX170M-3-05	○		17	129	74	51							+0.4
-DRX175M-3-05	○		17.5	130	76	52.5							+0.3
-DRX180M-3-05	○		18	132	77	54							+0.2
-DRX185M-3-06	○	2	18.5	131	77	55.5	25	32	+0.9	SB-2250TR	DTM-7	ZXMT06T204○○	
-DRX190M-3-06	○		19	132	78	57							+0.8
-DRX195M-3-06	○		19.5	134	80	58.5							+0.7
-DRX200M-3-06	○		20	135	81	60							+0.5
-DRX205M-3-06	○		20.5	137	83	61.5							+0.4
-DRX210M-3-06	○		21	138	84	63							+0.3
-DRX215M-3-06	○	2	21.5	140	86	64.5	25	35	+0.2	SB-2570TR	DTM-8	ZXMT070305○○	
-DRX220M-3-07	○		22	141	86	66							+1.2
-DRX225M-3-07	○		22.5	142	88	67.5							+1.0
-DRX230M-3-07	○		23	144	89	69							+0.9
-DRX235M-3-07	○		23.5	145	91	70.5							+0.8
-DRX240M-3-07	○		24	147	92	72							+0.7
-DRX245M-3-07	○		24.5	148	94	73.5							+0.5
-DRX250M-3-07	○		25	150	95	75							+0.4
-DRX255M-3-07	○		25.5	151	97	76.5							+0.3
-DRX260M-3-07	○		26	153	98	78							+0.2
S32 -DRX265M-3-09	○	2	26.5	161	102	79.5	32	42	+1.7	SB-3080TR	DTM-10	ZXMT09T306○○	
-DRX270M-3-09	○		27	163	103	81							+1.6
-DRX275M-3-09	○		27.5	164	105	82.5							+1.5
-DRX280M-3-09	○		28	166	106	84							+1.3
-DRX285M-3-09	○		28.5	167	108	85.5							+1.2
-DRX290M-3-09	○		29	169	109	87							+1.1
-DRX295M-3-09	○		2	29.5	170	111	88.5	45	+1.1	SB-3080TR	DTM-10	ZXMT09T306○○	
-DRX300M-3-09	○			30	172	112	90						+0.8
-DRX305M-3-09	○			30.5	173	114	91.5						+0.7
-DRX310M-3-09	○			31	175	115	93						+0.6
-DRX315M-3-09	○			31.5	176	117	94.5						+0.5
-DRX320M-3-11	○			2	32	201	132						96
-DRX330M-3-11	○	33	204		135	99	+1.9						
-DRX340M-3-11	○	34	207		138	102	+1.7						
-DRX350M-3-11	○	35	210		141	105	+1.4						
-DRX360M-3-11	○	36	213		144	108	+1.2						
-DRX370M-3-11	○	37	216		147	111	+0.9						
-DRX380M-3-11	○	38	219		150	114	+0.7						



● When offset machining, reduce feed rate to .003ipr or less
 ● See ● Page 77 for Adjustable Sleeve SHE.

● : Stock Standard
 ○ : World Express

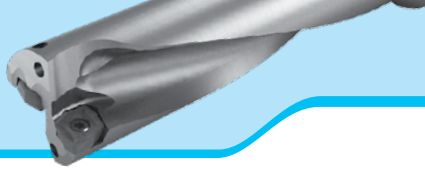



● Toolholder Dimensions

Description	Stock	No. of insert	Dimension (mm)					Max. Offset (Radial) (mm)	Spare Parts		Applicable Insert ● Page 25	
			ØDc	L1	L2	L3	Ød		Ød1	Insert Screw		Wrench
												
S40 -DRX390M-3-14 -DRX400M-3-14 -DRX410M-3-14 -DRX420M-3-14 -DRX430M-3-14 -DRX440M-3-14 -DRX450M-3-14 -DRX460M-3-14 -DRX470M-3-14	○	2	39	218	149	117	40	55	+2.8	SB-5090TR	DT-20	ZXMT140408ss
	○		40	221	152	120			+2.5			
	○		41	224	155	123			+2.3			
	○		42	227	158	126			+2.0			
	○		43	230	161	129			+1.8			
	○		44	233	164	132		+1.5	60			
	○		45	236	167	135		+1.3				
	○		46	239	170	138		+1.0				
	○		47	242	173	141		+0.8				
S40 -DRX480M-3-17 -DRX490M-3-17 -DRX500M-3-17 -DRX510M-3-17 -DRX520M-3-17 -DRX530M-3-17 -DRX540M-3-17 -DRX550M-3-17 -DRX560M-3-17 -DRX570M-3-17 -DRX580M-3-17 -DRX590M-3-17 -DRX600M-3-17	○	2	48	242	173	144	40	60	+3.8	SB-60120TR	DT-25	ZXMT170608ss
	○		49	245	176	147			+3.5			
	○		50	248	179	150			+3.3			
	○		51	251	182	153			+3.0			
	○		52	254	185	156			+2.8			
	○		53	257	188	159			+2.5			
	○		54	260	191	162		+2.3	65			
	○		55	263	194	165		+2.0				
	○		56	266	197	168		+1.8				
	○		57	269	200	171		+1.5				
	○		58	272	203	174		+1.3				
	○		59	275	206	177		+1.0				
	○		60	278	209	180		+0.8				

- When offset machining, reduce feed rate to .003ipr or less
- See [Page 77](#) for Adjustable Sleeve SHE.

- : Stock Standard
- : World Express

Recommended Cutting Conditions [Page 35](#)

● Cutting Tolerance (3D Type)

Dc	Cutting Tolerance (mm)
Ø12~Ø26	+0.20
	-0.10
Ø26.5~Ø38	+0.25
	-0.15
Ø39~Ø60	+0.30
	-0.20

* Listed tolerance is guideline numbers.
These guideline numbers may be variable depending on machines, workpieces, clamping conditions and cutting conditions.



Magic Drill DRX

Drilling

■ DRX (Drilling Depth : 4 x D) Metric Diameter

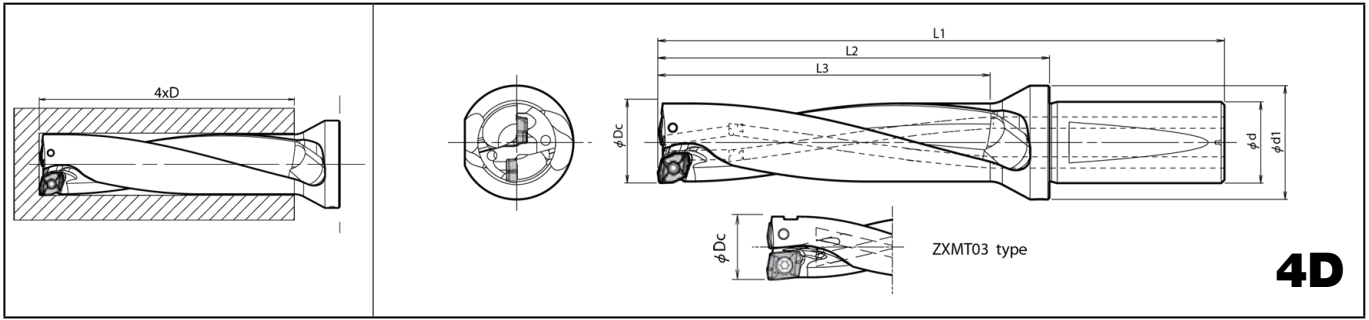

● Toolholder Dimensions

Description	Stock	No. of insert	Dimension (mm)					Max. Offset (Radial) (mm)	Spare Parts		Applicable Insert ● Page 25		
			ØDc	L1	L2	L3	Ød		Ød1	Insert Screw		Wrench	
S20 -DRX120M-4-03	○	2	12	112	69	48	20	27	+0.5	SB-2042TRG	DTM-6	ZXMT030203○○-E (External) ZXMT030203GM-I (Internal)	
-DRX125M-4-03	○		12.5	114	71	50							+0.4
-DRX130M-4-03	○		13	116	73	52							
S20 -DRX135M-4-04	○	2	13.5	118	75	54	20	27	+0.5	SB-2042TRG	DTM-6	ZXMT040203○○	
-DRX140M-4-04	○		14	120	77	56							+0.4
-DRX145M-4-04	○		14.5	122	79	58							
-DRX150M-4-04	○		15	124	81	60							+0.2
S25 -DRX155M-4-05	○	2	15.5	140	86	62	25	32	+0.8	SB-2045TR	DTM-6	ZXMT05T203○○	
-DRX160M-4-05	○		16	142	87	64							+0.7
-DRX165M-4-05	○		16.5	144	90	66							
-DRX170M-4-05	○		17	146	91	68							+0.4
-DRX175M-4-05	○		17.5	148	94	70							
-DRX180M-4-05	○		18	150	95	72							+0.2
-DRX185M-4-06	○	2	18.5	149	95	74	25	32	+0.9	SB-2250TR	DTM-7	ZXMT06T204○○	
-DRX190M-4-06	○		19	151	97	76							+0.8
-DRX195M-4-06	○		19.5	153	99	78							
-DRX200M-4-06	○		20	155	101	80							+0.5
-DRX205M-4-06	○		20.5	157	103	82							
-DRX210M-4-06	○		21	159	105	84							+0.3
-DRX215M-4-06	○		21.5	161	107	86							
-DRX220M-4-07	○		22	163	108	88							+1.2
-DRX225M-4-07	○		22.5	165	111	90							
-DRX230M-4-07	○		23	167	112	92							+0.9
-DRX235M-4-07	○	23.5	169	115	94	+0.8							
-DRX240M-4-07	○	24	171	116	96		+0.7						
-DRX245M-4-07	○	24.5	173	119	98	+0.5							
-DRX250M-4-07	○	25	175	120	100		+0.4						
-DRX255M-4-07	○	25.5	177	123	102	+0.3							
-DRX260M-4-07	○	26	179	124	104		+0.2						
S32 -DRX270M-4-09	○	2	27	190	130	108	32	42	+1.6	SB-3080TR	DTM-10	ZXMT09T306○○	
-DRX280M-4-09	○		28	194	134	112							+1.3
-DRX290M-4-09	○		29	198	138	116							
-DRX300M-4-09	○		30	202	142	120							+0.8
-DRX310M-4-09	○		31	206	146	124							
S40 -DRX320M-4-11	○	2	32	223	154	128	40	50	+2.2	SB-4085TR	DTM-15	ZXMT11T306○○	
-DRX330M-4-11	○		33	227	158	132							+1.9
-DRX340M-4-11	○		34	231	162	136							
-DRX350M-4-11	○		35	235	166	140							+1.4
-DRX360M-4-11	○		36	239	170	144							
-DRX370M-4-11	○		37	243	174	148							+0.9
-DRX380M-4-11	○		38	247	178	152							



● When offset machining, reduce feed rate to .002ipr or less
 ● See ● Page 77 for Adjustable Sleeve SHE.

● : Stock Standard
 ○ : World Express

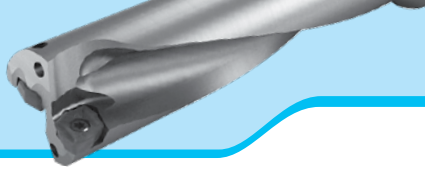



● Toolholder Dimensions

Description	Stock	No. of insert	Dimension (mm)					Max. Offset (Radial) (mm)	Spare Parts		Applicable Insert ● Page 25	
			ØDc	L1	L2	L3	Ød		Ød1	Insert Screw		Wrench
												
S40 -DRX390M-4-14 -DRX400M-4-14 -DRX410M-4-14 -DRX420M-4-14 -DRX430M-4-14 -DRX440M-4-14 -DRX450M-4-14 -DRX460M-4-14 -DRX470M-4-14	○	2	39	257	188	156	40	55	+2.8	SB-5090TR	DT-20	ZXMT140408○○
	○		40	261	192	160			+2.5			
	○		41	265	196	164			+2.3			
	○		42	269	200	168			+2.0			
	○		43	273	204	172			+1.8			
	○		44	277	208	176			+1.5			
	○		45	281	212	180			+1.3			
	○		46	285	216	184			+1.0			
	○		47	289	220	188			+0.8			
	S50 -DRX480M-4-17 -DRX490M-4-17 -DRX500M-4-17 -DRX510M-4-17 -DRX520M-4-17 -DRX530M-4-17 -DRX540M-4-17 -DRX550M-4-17 -DRX560M-4-17 -DRX570M-4-17 -DRX580M-4-17 -DRX590M-4-17 -DRX600M-4-17		○	2	48	290			221			
○		49	294		225	196	+3.5					
○		50	298		229	200	+3.3					
○		51	302		233	204	+3.0					
○		52	306		237	208	+2.8					
○		53	310		241	212	+2.5					
○		54	314		245	216	+2.3					
○		55	318		249	220	+2.0					
○		65	56		322	253	224	+1.8				
			57		326	257	228	+1.5				
			58		330	261	232	+1.3				
			59		334	265	236	+1.0				
			60		338	269	240	+0.8				

- When offset machining, reduce feed rate to .002ipr or less
- See ● **Page 77** for Adjustable Sleeve SHE.

- : Stock Standard
- : World Express

Recommended Cutting Conditions ● **Page 35**

● DRX Cutting Tolerance (3D Type)

Dc	Cutting Tolerance (mm)
Ø12~Ø26	+0.25
	-0.10
Ø27~Ø38	+0.30
	-0.15
Ø39~Ø60	+0.35
	-0.20

* Listed tolerance is guideline numbers.
These guideline numbers may be variable depending on machines, workpieces, clamping conditions and cutting conditions.

● DRX Cutting Tolerance (5D Type)

Dc	Cutting Tolerance (mm)	Dc	Cutting Tolerance (mm)	Dc	Cutting Tolerance (mm)
Ø14~Ø26	+0.30	Ø27~Ø38	+0.35	Ø39~Ø60	+0.40
	-0.10		-0.15		-0.20

* Listed tolerance is guideline numbers.
These guideline numbers may be variable depending on machines, workpieces, clamping conditions and cutting conditions.





Magic Drill DRX

Drilling

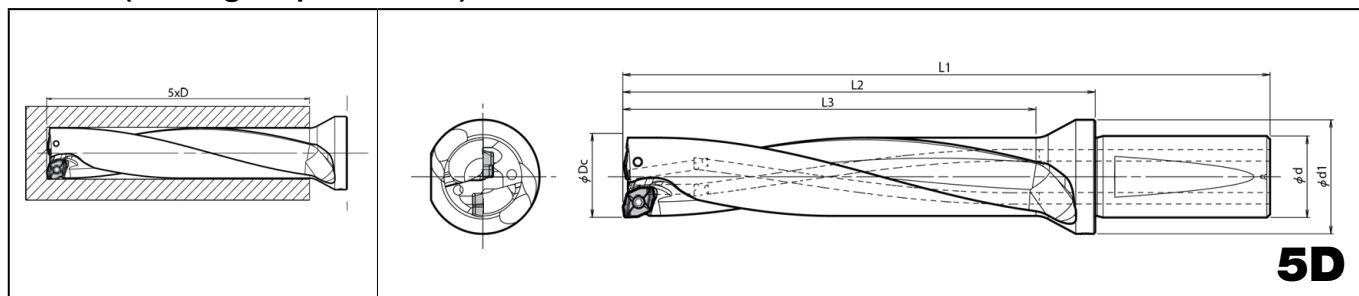
■ DRX (Drilling Depth : 5 x D) Metric Diameter



● Toolholder Dimensions

Description	Stock	No. of Insert	Dimension (mm)						Max. Offset (Radial) (mm)	Spare Parts		Applicable Insert ● Page 25
			ØDc	L1	L2	L3	Ød	Ød1		Insert Screw	Wrench	
												
S20 -DRX140M-5-04	○	2	14	134	91	70	20	27	+0.4	SB-2042TRG	DTM-6	ZXMT040203ss
-DRX150M-5-04	○		15	139	96	75						
S25 -DRX160M-5-05	○	2	16	158	103	80	25	32	+0.7	SB-2045TR	DTM-6	ZXMT05T203ss
-DRX170M-5-05	○		17	163	108	85						
-DRX180M-5-05	○	2	18	168	113	90	25	32	+0.2	SB-2250TR	DTM-7	ZXMT06T204ss
-DRX190M-5-06	○		19	170	116	95						
-DRX200M-5-06	○	2	20	175	121	100	25	32	+0.5	SB-2570TR	DTM-8	ZXMT070305ss
-DRX210M-5-06	○		21	180	126	105						
-DRX220M-5-07	○	2	22	185	130	110	25	32	+1.2	SB-3080TR	DTM-10	ZXMT09T306ss
-DRX230M-5-07	○		23	190	135	115						
-DRX240M-5-07	○	2	24	195	140	120	25	32	+0.7	SB-4085TR	DTM-15	ZXMT11T306ss
-DRX250M-5-07	○		25	200	145	125						
-DRX260M-5-07	○	2	26	205	150	130	25	32	+0.2	SB-5090TR	DT-20	ZXMT140408ss
S32 -DRX270M-5-09	○		27	217	157	135						
-DRX280M-5-09	○	2	28	222	162	140	32	42	+1.3	SB-60120TR	DT-25	ZXMT170608ss
-DRX290M-5-09	○		29	227	167	145						
-DRX300M-5-09	○	2	30	232	172	150	32	45	+0.8	SB-60120TR	DT-25	ZXMT170608ss
-DRX310M-5-09	○		31	237	177	155						
S40 -DRX320M-5-11	○	2	32	255	186	160	40	50	+2.2	SB-60120TR	DT-25	ZXMT170608ss
-DRX330M-5-11	○		33	260	191	165						
-DRX340M-5-11	○	2	34	265	196	170	40	50	+1.7	SB-60120TR	DT-25	ZXMT170608ss
-DRX350M-5-11	○		35	270	201	175						
-DRX360M-5-11	○	2	36	275	206	180	40	50	+1.2	SB-60120TR	DT-25	ZXMT170608ss
-DRX370M-5-11	○		37	280	211	185						
-DRX380M-5-11	○	2	38	285	216	190	40	50	+0.7	SB-60120TR	DT-25	ZXMT170608ss
-DRX390M-5-14	○		39	296	227	195						
-DRX400M-5-14	○	2	40	301	232	200	40	55	+2.5	SB-60120TR	DT-25	ZXMT170608ss
-DRX410M-5-14	○		41	306	237	205						
-DRX420M-5-14	○	2	42	311	242	210	40	55	+2.0	SB-60120TR	DT-25	ZXMT170608ss
-DRX430M-5-14	○		43	316	247	215						
-DRX440M-5-14	○	2	44	321	252	220	40	60	+1.5	SB-60120TR	DT-25	ZXMT170608ss
-DRX450M-5-14	○		45	326	257	225						
-DRX460M-5-14	○	2	46	331	262	230	40	60	+1.0	SB-60120TR	DT-25	ZXMT170608ss
-DRX470M-5-14	○		47	336	267	235						
S50 -DRX480M-5-17	○	2	48	338	269	240	50	60	+3.8	SB-60120TR	DT-25	ZXMT170608ss
-DRX490M-5-17	○		49	343	274	245						
-DRX500M-5-17	○	2	50	348	279	250	50	60	+3.3	SB-60120TR	DT-25	ZXMT170608ss
-DRX510M-5-17	○		51	353	284	255						
-DRX520M-5-17	○	2	52	358	289	260	50	60	+2.8	SB-60120TR	DT-25	ZXMT170608ss
-DRX530M-5-17	○		53	363	294	265						
-DRX540M-5-17	○	2	54	368	299	270	50	65	+2.3	SB-60120TR	DT-25	ZXMT170608ss
-DRX550M-5-17	○		55	373	304	275						
-DRX560M-5-17	○	2	56	378	309	280	50	65	+1.8	SB-60120TR	DT-25	ZXMT170608ss
-DRX570M-5-17	○		57	383	314	285						
-DRX580M-5-17	○	2	58	388	319	290	50	65	+1.3	SB-60120TR	DT-25	ZXMT170608ss
-DRX590M-5-17	○		59	393	324	295						
-DRX600M-5-17	○	2	60	398	329	300	50	65	+0.8	SB-60120TR	DT-25	ZXMT170608ss

● When offset machining, reduce feed rate to .002ipr or less
 ● See ● Page 77 for Adjustable Sleeve SHE.

● : Stock Standard
 ○ : World Express



Magic Drill DRX

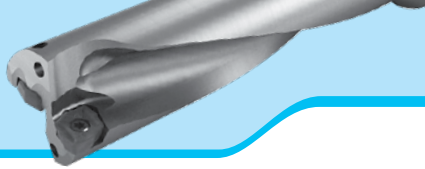

■ Magic Drill DRX Recommended Cutting Conditions (Coolant)

Workpiece Material	Recommended Cutting Speed (SFM)				Cutting Dia. ØDc (inch)	Type (Drilling Depth)									
	PVD Coated		Carbide			2D~3D			4D			5D			
	PR1230	PR1225	PR1210	GW15		Feed Rate (ipr)									
	GM	GH	SM	GM		GM	GH	SM	GM	GH	SM	GM	GH	SM	
Low Carbon Steel	☆	★			Ø 0.432 ~ Ø 0.591	.0024 ~ .0039	.0024 ~ .0039	.0016 ~ .0039	.0020 ~ .0031	.0020 ~ .0031	.0016 ~ .0031	.0016 ~ .0028	.0016 ~ .0028	.0016 ~ .0031	
					Ø 0.630 ~ Ø 0.709	.0024 ~ .0047	.0024 ~ .0047	.0024 ~ .0047	.0020 ~ .0039	.0020 ~ .0039	.0020 ~ .0039	.0020 ~ .0031	.0020 ~ .0031	.0020 ~ .0039	.0020 ~ .0039
					Ø 0.748 ~ Ø 1.024	.0031 ~ .0055	.0031 ~ .0055	.0024 ~ .0055	.0024 ~ .0047	.0031 ~ .0047	.0020 ~ .0047	.0024 ~ .0039	.0024 ~ .0039	.0020 ~ .0047	.0020 ~ .0047
					Ø 1.063 ~ Ø 2.362	.0031 ~ .0055	.0031 ~ .0055	.0024 ~ .0055	.0024 ~ .0047	.0031 ~ .0047	.0020 ~ .0047	.0024 ~ .0039	.0024 ~ .0039	.0020 ~ .0047	.0020 ~ .0047
Carbon Steel	★	☆			Ø 0.432 ~ Ø 0.591	.0016 ~ .0055	.0016 ~ .0055	.0016 ~ .0039	.0016 ~ .0039	.0016 ~ .0039	.0016 ~ .0031	.0016 ~ .0031	.0016 ~ .0031	.0016 ~ .0031	
					Ø 0.630 ~ Ø 0.709	.0024 ~ .0063	.0024 ~ .0063	.0024 ~ .0047	.0020 ~ .0047	.0020 ~ .0047	.0020 ~ .0039	.0020 ~ .0039	.0020 ~ .0039	.0020 ~ .0039	
					Ø 0.748 ~ Ø 1.024	.0031 ~ .0079	.0031 ~ .0079	.0024 ~ .0055	.0028 ~ .0063	.0028 ~ .0063	.0020 ~ .0047	.0024 ~ .0047	.0024 ~ .0047	.0020 ~ .0047	.0020 ~ .0047
					Ø 1.063 ~ Ø 2.362	.0031 ~ .0079	.0031 ~ .0079	.0024 ~ .0055	.0028 ~ .0063	.0028 ~ .0063	.0020 ~ .0047	.0024 ~ .0047	.0024 ~ .0047	.0020 ~ .0047	.0020 ~ .0047
Alloy Steel	★	☆			Ø 0.432 ~ Ø 0.591	.0016 ~ .0055	.0016 ~ .0055	.0016 ~ .0039	.0016 ~ .0039	.0016 ~ .0039	.0016 ~ .0031	.0016 ~ .0031	.0016 ~ .0031	.0016 ~ .0031	
					Ø 0.630 ~ Ø 0.709	.0024 ~ .0063	.0024 ~ .0063	.0024 ~ .0047	.0020 ~ .0047	.0020 ~ .0047	.0020 ~ .0039	.0020 ~ .0039	.0020 ~ .0039	.0020 ~ .0039	
					Ø 0.748 ~ Ø 1.024	.0031 ~ .0079	.0031 ~ .0079	.0024 ~ .0055	.0028 ~ .0063	.0028 ~ .0063	.0020 ~ .0047	.0024 ~ .0047	.0024 ~ .0047	.0020 ~ .0047	.0020 ~ .0047
					Ø 1.063 ~ Ø 2.362	.0031 ~ .0079	.0031 ~ .0079	.0024 ~ .0055	.0028 ~ .0063	.0028 ~ .0063	.0020 ~ .0047	.0024 ~ .0047	.0024 ~ .0047	.0020 ~ .0047	.0020 ~ .0047
Tool Steel	★	☆			Ø 0.432 ~ Ø 0.591	.0016 ~ .0031	.0016 ~ .0031	.0016 ~ .0031	.0016 ~ .0028	.0016 ~ .0028	.0016 ~ .0028	.0016 ~ .0024	.0016 ~ .0024	.0016 ~ .0028	
					Ø 0.630 ~ Ø 0.709	.0024 ~ .0047	.0024 ~ .0047	.0024 ~ .0039	.0020 ~ .0039	.0020 ~ .0039	.0020 ~ .0031	.0016 ~ .0031	.0016 ~ .0031	.0020 ~ .0031	
					Ø 0.748 ~ Ø 1.024	.0031 ~ .0059	.0031 ~ .0059	.0024 ~ .0047	.0024 ~ .0047	.0024 ~ .0047	.0024 ~ .0039	.0020 ~ .0039	.0020 ~ .0039	.0024 ~ .0039	.0024 ~ .0039
					Ø 1.063 ~ Ø 2.362	.0031 ~ .0059	.0031 ~ .0059	.0024 ~ .0047	.0024 ~ .0047	.0024 ~ .0047	.0024 ~ .0039	.0020 ~ .0039	.0020 ~ .0039	.0024 ~ .0039	.0024 ~ .0039
Stainless Steel	☆	★			Ø 0.432 ~ Ø 0.591	.0024 ~ .0039	.0024 ~ .0039	.0016 ~ .0039	.0020 ~ .0031	.0020 ~ .0031	.0016 ~ .0031	.0016 ~ .0028	.0016 ~ .0031	.0016 ~ .0031	
					Ø 0.630 ~ Ø 0.709	.0024 ~ .0039	.0024 ~ .0039	.0024 ~ .0047	.0020 ~ .0031	.0020 ~ .0031	.0020 ~ .0043	.0016 ~ .0028	.0016 ~ .0028	.0020 ~ .0043	
					Ø 0.748 ~ Ø 1.024	.0031 ~ .0047	.0031 ~ .0047	.0024 ~ .0055	.0028 ~ .0039	.0028 ~ .0039	.0024 ~ .0047	.0028 ~ .0039	.0028 ~ .0039	.0024 ~ .0047	.0024 ~ .0047
					Ø 1.063 ~ Ø 2.362	.0031 ~ .0047	.0031 ~ .0047	.0024 ~ .0055	.0028 ~ .0039	.0028 ~ .0039	.0024 ~ .0047	.0028 ~ .0039	.0028 ~ .0039	.0024 ~ .0047	.0024 ~ .0047
Gray Cast Iron			★	330 ~ 500	Ø 0.432 ~ Ø 0.591	.0031 ~ .0055	~	~	.0024 ~ .0047	~	~	.0016 ~ .0039	~	~	
					Ø 0.630 ~ Ø 0.709	.0031 ~ .0071	~	~	.0031 ~ .0063	~	~	.0024 ~ .0047	~	~	
					Ø 0.748 ~ Ø 1.024	.0031 ~ .0079	~	~	.0031 ~ .0071	~	~	.0024 ~ .0055	~	~	
					Ø 1.063 ~ Ø 2.362	.0031 ~ .0079	~	~	.0031 ~ .0071	~	~	.0024 ~ .0055	~	~	
Nodular Cast Iron (Ductile)			★	270 ~ 400	Ø 0.432 ~ Ø 0.591	.0031 ~ .0047	~	~	.0024 ~ .0039	~	~	.0016 ~ .0031	~	~	
					Ø 0.630 ~ Ø 0.709	.0031 ~ .0063	~	~	.0031 ~ .0055	~	~	.0024 ~ .0039	~	~	
					Ø 0.748 ~ Ø 1.024	.0031 ~ .0071	~	~	.0031 ~ .0063	~	~	.0024 ~ .0047	~	~	
					Ø 1.063 ~ Ø 2.362	.0031 ~ .0071	~	~	.0031 ~ .0063	~	~	.0024 ~ .0047	~	~	
Non-Ferrous Metal			★	660 ~ 1980	Ø 0.432 ~ Ø 0.591	~	~	.0024 ~ .0047	~	~	.0020 ~ .0039	~	~	.0016 ~ .0031	
					Ø 0.630 ~ Ø 0.709	~	~	.0031 ~ .0055	~	~	.0024 ~ .0047	~	~	.0020 ~ .0039	
					Ø 0.748 ~ Ø 1.024	~	~	.0031 ~ .0063	~	~	.0024 ~ .0055	~	~	.0020 ~ .0047	
					Ø 1.063 ~ Ø 2.362	~	~	.0031 ~ .0079	~	~	.0031 ~ .0063	~	~	.0028 ~ .0055	
Titanium Alloy			★	140 ~ 240	Ø 0.432 ~ Ø 0.591	~	~	.0020 ~ .0031	~	~	.0016 ~ .0028	~	~	.0016 ~ .0024	
					Ø 0.630 ~ Ø 0.709	~	~	.0020 ~ .0031	~	~	.0016 ~ .0028	~	~	.0016 ~ .0024	
					Ø 0.748 ~ Ø 1.024	~	~	.0024 ~ .0039	~	~	.0024 ~ .0031	~	~	.0020 ~ .0028	
					Ø 1.063 ~ Ø 2.362	~	~	.0024 ~ .0039	~	~	.0024 ~ .0031	~	~	.0020 ~ .0028	

• Apply sufficient amount of coolant

★ : 1st Recommendation ☆ : 2nd Recommendation

■ Cutting Conditions by Application

Application	Plain Surface	Slant Surface	Half Clindrical	Hole Expansion	Concave Surface	Pre-drilled Surface	Stacked Plates
Workpiece Shape							
DRX	Cutting Speed (SFM)	400	400	400	400	See Coremaster Coredrill ➡ Page 61	See Holeshot Drill ➡ Page 53
	Feed Rate (ipr)	.004	.002	.002	.002		
Coolant	Yes	Yes	Yes	Yes	Yes	Yes	-

Drilling Magic Drill DRX

Recommended Chipbreakers (ZXMT)

Workpiece Material	Insert Chipbreaker	ZXMT type											
		GM				GH				SM			
	Cutting Depth	2D	3D	4D	5D	2D	3D	4D	5D	2D	3D	4D	5D
Low-carbon Steel		☆	☆	☆	☆					★	★	★	★
Carbon Steel		★	★	★	☆	☆	☆	☆	☆	☆	☆	☆	★
Alloy Steel		★	★	★	☆	☆	☆	☆	☆	☆	☆	☆	★
Mold Steel		☆	☆	☆	☆	★	★	★	★				
Stainless Steel										★	★	★	★
Cast Iron		★	★	★	★								
Aluminum Alloys										★	★	★	★
Brass										★	★	★	★
Titanium Alloys										★	★	★	★

★ : 1st Recommendation ☆ : 2nd Recommendation

How to select ZXMT03

ZXMT03 type (Cutting Dia : $\phi 12 \sim \phi 13$)

- For outer edge, please select "-E" insert from three different chipbreakers for each application.
- For inner edge, please select "-I" insert (GM chipbreaker only).

• Outer edge



ZXMT030203OO-E



GM-E GH-E SM-E

• Inner Edge



ZXMT030203GM-I















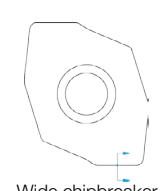

GM-I

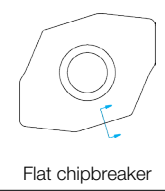
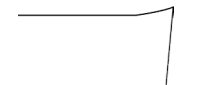

Magic Drill DRX

Drilling

Features of the Magic Drill DRX Chipbreakers

Chipbreaker			GM	GH	SM
Insert					
Advantages			1st. recommendation for carbon steel and alloy steel, 1st. recommendation for cast iron.	1st. recommendation for interrupted machining and hard materials. Cutting edge strength oriented design.	Suitable for sticky materials such as stainless steel and low carbon steel
			Good balance of sharp cutting and cutting edge strength.	Middle to high feed rates of steel machining, GM Chipbreaker alternative.	Sharp cutting, prevents chattering. For low to medium feed rates of steel.
Outer edge	 Wide chipbreaker	Cross-section			
		Chips from Outer edge			
Inner edge	 Flat chipbreaker	Cross-section			
		Chips from Inner edge			
Workpiece Materials			C50 (S50C)	C50 (S50C)	X5CrNi18 10 (SUS304)

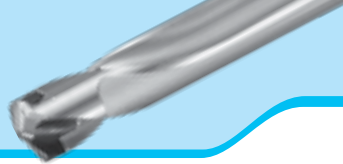

Magic Drill DRC

Machining diameters $\varnothing 7.94\text{-}\varnothing 20.99$ mm ($\varnothing .3125\text{-}\varnothing .8264$ in)

Machining depths 3D,5D,8D

Straight Shank DRC SS-DRC



Flanged Shank DRC SF-DRC



Straight Shank DRC
with Chamfering attachment



Please refer to [Page 43](#) and [Page 44](#) for details on the chamfering attachment

High efficiency

High feed rate

High reliability

High quality

Four unique characteristics of the DRC Magic Drill improve productivity and reduce costs through high speed and high feed rate machining.

1. Self-Clamping design

- The clamp rigidity and resistance of the DRC Magic Drill's self-clamping method has significantly improved with the new design analysis and material technology.
- Easy replacement is possible on the machine.

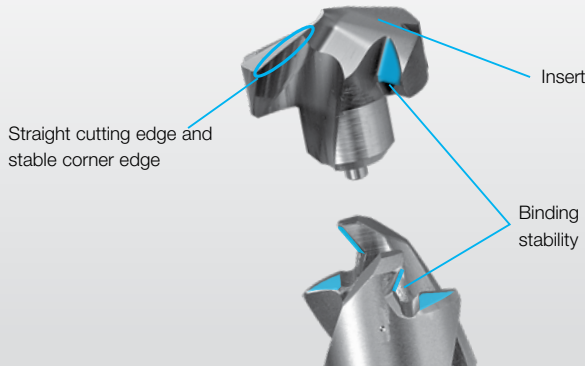

2. Self-Centering design

- The S-curve top shape geometry of the insert known as the "Self-Centering design" enables smooth drilling, lowers cutting forces and produces a high quality surface finish.

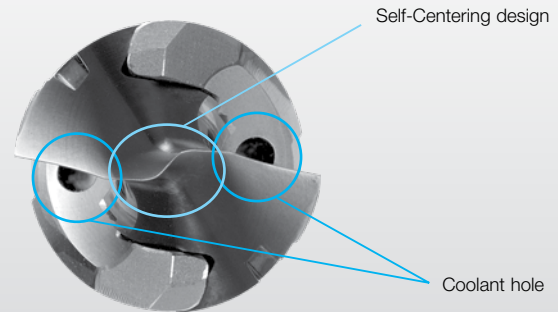

3. Multiple Helical Angle Flute design

- Provides superior drill body stiffness and chip evacuation.



4. Direct Cooling design

- The coolant is fed directly into the inserts cutting face, cooling the top of the drill and preventing chip adhesion, which allows for quick and smooth chip evacuation.

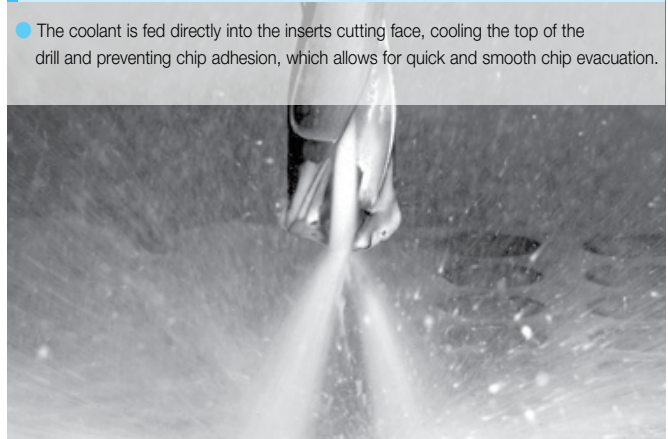

Insert Identification System for the Magic Drill DRC

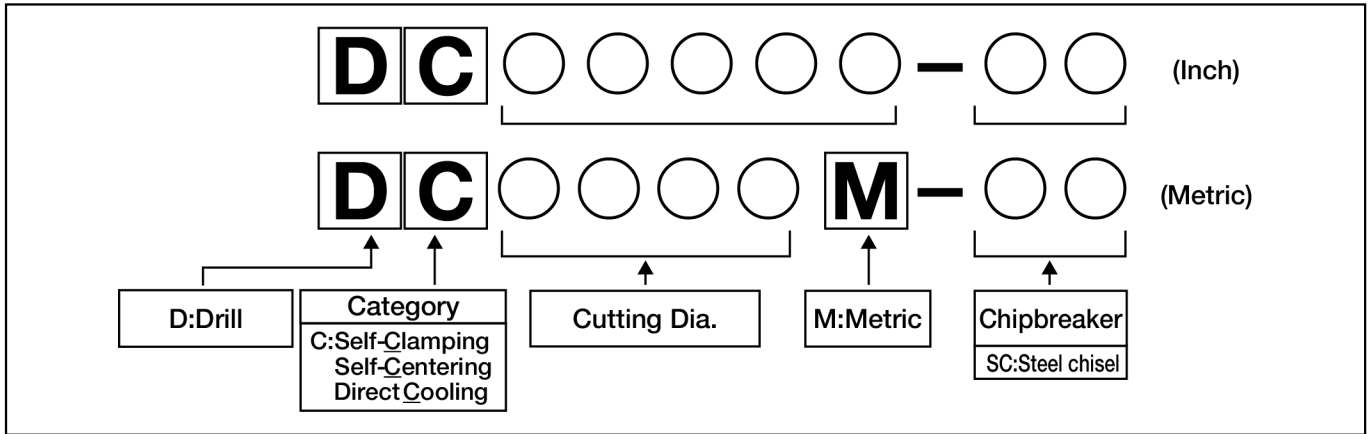

● Drilling Inserts for DRC

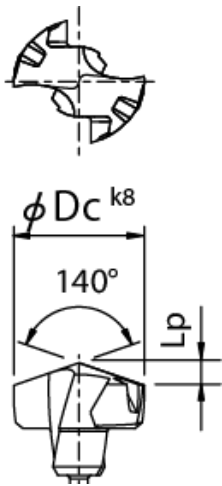
Insert	Description (ISO)	Dimensions (inch)			PVD Coated PR0315	Applicable Toolholder ● Page 41-46																				
		ØDc (inch)	ØDc (mm)	Lp (inch)																						
  <p>k8 tolerance</p> <table border="1"> <thead> <tr> <th>ØDc</th> <th>k8(inch)</th> </tr> </thead> <tbody> <tr> <td>.3125</td> <td>+0.000866</td> </tr> <tr> <td>∓</td> <td>0</td> </tr> <tr> <td>.3937</td> <td></td> </tr> <tr> <td>.3976</td> <td>+0.001063</td> </tr> <tr> <td>∓</td> <td>0</td> </tr> <tr> <td>.7087</td> <td></td> </tr> <tr> <td>.7126</td> <td>+0.001299</td> </tr> <tr> <td>∓</td> <td>0</td> </tr> <tr> <td>.8264</td> <td></td> </tr> </tbody> </table> <p>k8 is the dimension tolerance of the insert. It is not the dimension tolerance of the cutting diameter.</p>	ØDc	k8(inch)	.3125	+0.000866	∓	0	.3937		.3976	+0.001063	∓	0	.7087		.7126	+0.001299	∓	0	.8264		DC0794M-SC	.3125	7.94	.057	○	SS10-DRC080M-○ SF12-DRC080M-○
	ØDc	k8(inch)																								
	.3125	+0.000866																								
	∓	0																								
	.3937																									
	.3976	+0.001063																								
	∓	0																								
	.7087																									
	.7126	+0.001299																								
	∓	0																								
	.8264																									
	DC0800M-SC	.3150	8.00	.057	○																					
	DC0810M-SC	.3189	8.10	.058	○																					
	DC0820M-SC	.3230	8.20	.059	○																					
	DC0830M-SC	.3268	8.30	.059	○	SS10-DRC085M-○ SF12-DRC085M-○																				
	DC0840M-SC	.3307	8.40	.060	○																					
	DC0850M-SC	.3346	8.50	.061	○																					
	DC0860M-SC	.3386	8.60	.062	○																					
	DC0870M-SC	.3425	8.70	.062	○	SS10-DRC090M-○ SF12-DRC090M-○																				
	DC0880M-SC	.3465	8.80	.063	○																					
DC0890M-SC	.3504	8.90	.064	○																						
DC0900M-SC	.3543	9.00	.064	○																						
DC0910M-SC	.3583	9.10	.065	○	SS10-DRC095M-○ SF12-DRC095M-○																					
DC0920M-SC	.3622	9.20	.066	○																						
DC0930M-SC	.3661	9.30	.067	○																						
DC0940M-SC	.3701	9.40	.067	○																						
DC0950M-SC	.3740	9.50	.068	○	SS12-DRC100M-○ SF16-DRC100M-○																					
DC0960M-SC	.3780	9.60	.069	○																						
DC0970M-SC	.3819	9.70	.069	○																						
DC0980M-SC	.3858	9.80	.070	○																						
DC0990M-SC	.3898	9.90	.071	○	SS12-DRC105M-○ SF16-DRC105M-○																					
DC1000M-SC	.3937	10.00	.072	○																						
DC1010M-SC	.3976	10.10	.072	○																						
DC1020M-SC	.4016	10.20	.073	○																						
DC1030M-SC	.4055	10.30	.074	○	SS12-DRC110M-○ SF16-DRC110M-○																					
DC1040M-SC	.4094	10.40	.074	○																						
DC1050M-SC	.4134	10.50	.075	○																						
DC1060M-SC	.4173	10.60	.076	○																						
DC1070M-SC	.4213	10.70	.077	○	SS12-DRC115M-○ SF16-DRC115M-○																					
DC1080M-SC	.4252	10.80	.077	○																						
DC1090M-SC	.4291	10.90	.078	○																						
DC1100M-SC	.4331	11.00	.079	○																						
DC1110M-SC	.4370	11.10	.079	○	SS12-DRC115M-○ SF16-DRC115M-○																					
DC1120M-SC	.4409	11.20	.080	○																						
DC1130M-SC	.4449	11.30	.081	○																						
DC1140M-SC	.4488	11.40	.082	○																						
DC1150M-SC	.4528	11.50	.082	○	SS12-DRC115M-○ SF16-DRC115M-○																					
DC1160M-SC	.4567	11.60	.083	○																						
DC1170M-SC	.4606	11.70	.084	○																						
DC1180M-SC	.4646	11.80	.085	○																						
DC1190M-SC	.4685	11.90	.085	○																						

DC inserts are sold in 1 piece boxes.

● : Stock Standard
○ : World Express



Magic Drill DRC

Drilling

Magic Drill DRC

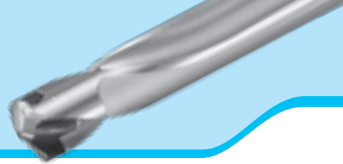

● Drilling Inserts for DRC

Insert	Description (ISO)	Dimensions (inch)			PVD Coated	Applicable Toolholder ● Page 41-46
		ØDc (inch)	ØDc (mm)	Lp (inch)	PR0315	
	DC1200M-SC	.4724	12.00	.086	○	SS14-DRC120M-○ SF16-DRC120M-○
	DC1210M-SC	.4764	12.10	.087	○	
	DC1220M-SC	.4803	12.20	.087	○	
	DC1230M-SC	.4843	12.30	.088	○	
	DC1240M-SC	.4882	12.40	.089	○	
	DC1250M-SC	.4921	12.50	.090	○	
	DC1260M-SC	.4961	12.60	.090	○	
	DC1270M-SC	.5000	12.70	.091	○	
	DC1280M-SC	.5039	12.80	.092	○	
	DC1290M-SC	.5080	12.90	.092	○	
	DC1300M-SC	.5118	13.00	.093	○	
	DC1310M-SC	.5156	13.10	.094	○	
	DC1320M-SC	.5197	13.20	.095	○	
	DC1330M-SC	.5236	13.30	.095	○	
	DC1340M-SC	.5276	13.40	.096	○	
	DC1350M-SC	.5315	13.50	.097	○	
	DC1360M-SC	.5354	13.60	.097	○	
	DC1370M-SC	.5394	13.70	.098	○	
	DC1380M-SC	.5433	13.80	.099	○	
	DC1390M-SC	.5471	13.90	.100	○	
	DC1400M-SC	.5512	14.00	.100	○	
	DC1410M-SC	.5551	14.10	.101	○	
	DC1420M-SC	.5591	14.20	.102	○	
	DC1430M-SC	.5630	14.30	.102	○	
	DC1440M-SC	.5669	14.40	.103	○	
	DC1450M-SC	.5709	14.50	.104	○	
	DC1460M-SC	.5748	14.60	.105	○	
	DC1470M-SC	.5787	14.70	.105	○	
	DC1480M-SC	.5827	14.80	.106	○	
	DC1490M-SC	.5866	14.90	.107	○	
	DC1500M-SC	.5906	15.00	.107	○	
	DC1510M-SC	.5945	15.10	.108	○	
	DC1520M-SC	.5984	15.20	.109	○	
	DC1530M-SC	.6024	15.30	.110	○	
	DC1540M-SC	.6063	15.40	.110	○	
	DC1550M-SC	.6102	15.50	.111	○	
	DC1560M-SC	.6142	15.60	.112	○	
	DC1570M-SC	.6181	15.70	.112	○	
	DC1580M-SC	.6220	15.80	.113	○	
	DC1600M-SC	.6300	16.00	.115	○	
DC1610M-SC	.6339	16.10	.115	○		
DC1620M-SC	.6378	16.20	.116	○		
DC1630M-SC	.6417	16.30	.117	○		
DC1640M-SC	.6457	16.40	.117	○		
DC1650M-SC	.6496	16.50	.118	○		
DC1660M-SC	.6535	16.60	.119	○		
DC1670M-SC	.6575	16.70	.120	○		
DC1680M-SC	.6614	16.80	.120	○		
DC1690M-SC	.6654	16.90	.121	○		
DC1700M-SC	.6692	17.00	.122	○		
DC1710M-SC	.6732	17.10	.122	○		
DC1720M-SC	.6772	17.20	.123	○		
DC1730M-SC	.6811	17.30	.124	○		
DC1740M-SC	.6850	17.40	.125	○		
DC1750M-SC	.6890	17.50	.125	○		
DC1760M-SC	.6929	17.60	.126	○		
DC1770M-SC	.6969	17.70	.127	○		
DC1780M-SC	.7008	17.80	.127	○		
DC1790M-SC	.7047	17.90	.128	○		

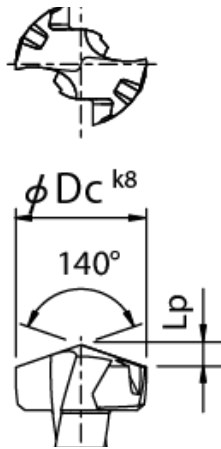

k8 tolerance

ØDc	k8(inch)
.3125	+0.000866
∩	0
.3937	
.3976	+0.001063
∩	0
.7087	
.7126	+0.001299
∩	0
.8264	

k8 is the dimension tolerance of the insert.
It is not the dimension tolerance of the cutting diameter.

DC inserts are sold in 1 piece boxes.

● : Stock Standard
○ : World Express

Drilling
Magic Drill DRC

● Drilling Inserts for DRC

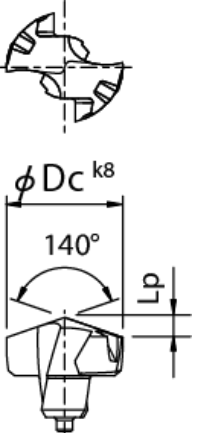
Insert	Description (ISO)	Dimensions (inch)			PVD Coated	Applicable Toolholder ● Page 41-46																				
		ØDc (inch)	ØDc (mm)	Lp (inch)	PR0315																					
  <table border="1" data-bbox="397 1060 609 1270"> <caption>k8 tolerance</caption> <thead> <tr> <th>ØDc</th> <th>k8(inch)</th> </tr> </thead> <tbody> <tr> <td>.3125</td> <td>+0.000866</td> </tr> <tr> <td>∓</td> <td>0</td> </tr> <tr> <td>.3937</td> <td>0</td> </tr> <tr> <td>.3976</td> <td>+0.001063</td> </tr> <tr> <td>∓</td> <td>0</td> </tr> <tr> <td>.7087</td> <td>0</td> </tr> <tr> <td>.7126</td> <td>+0.001299</td> </tr> <tr> <td>∓</td> <td>0</td> </tr> <tr> <td>.8264</td> <td>0</td> </tr> </tbody> </table> <p data-bbox="397 1281 609 1344">k8 is the dimension tolerance of the insert. It is not the dimension tolerance of the cutting diameter.</p>	ØDc	k8(inch)	.3125	+0.000866	∓	0	.3937	0	.3976	+0.001063	∓	0	.7087	0	.7126	+0.001299	∓	0	.8264	0	DC1800M-SC	.7087	18.00	.129	○	SS20-DRC180M-○ SF25-DRC180M-○
	ØDc	k8(inch)																								
	.3125	+0.000866																								
	∓	0																								
	.3937	0																								
	.3976	+0.001063																								
	∓	0																								
	.7087	0																								
	.7126	+0.001299																								
	∓	0																								
	.8264	0																								
	DC1810M-SC	.7126	18.10	.130	○																					
	DC1820M-SC	.7165	18.20	.130	○																					
	DC1830M-SC	.7205	18.30	.131	○																					
	DC1840M-SC	.7244	18.40	.132	○																					
	DC1850M-SC	.7283	18.50	.132	○																					
	DC1860M-SC	.7323	18.60	.133	○																					
	DC1870M-SC	.7344	18.65	.134	○																					
	DC1880M-SC	.7402	18.80	.135	○																					
	DC1890M-SC	.7441	18.90	.135	○																					
	DC1900M-SC	.7480	19.00	.136	○	SS20-DRC190M-○ SF25-DRC190M-○																				
	DC1910M-SC	.7520	19.10	.137	○																					
	DC1920M-SC	.7559	19.20	.137	○																					
	DC1930M-SC	.7598	19.30	.138	○																					
	DC1940M-SC	.7638	19.40	.139	○																					
DC1950M-SC	.7677	19.50	.140	○																						
DC1960M-SC	.7717	19.60	.140	○																						
DC1970M-SC	.7756	19.70	.141	○																						
DC1980M-SC	.7795	19.80	.142	○																						
DC1990M-SC	.7835	19.90	.143	○																						
DC2000M-SC	.7874	20.00	.143	○	SS25-DRC200M-○ SF25-DRC200M-○																					
DC2010M-SC	.7913	20.10	.144	○																						
DC2020M-SC	.7953	20.20	.145	○																						
DC2030M-SC	.7992	20.30	.145	○																						
DC2040M-SC	.8031	20.40	.146	○																						
DC2050M-SC	.8071	20.50	.147	○																						
DC2060M-SC	.8110	20.60	.148	○																						
DC2070M-SC	.8150	20.70	.148	○																						
DC2080M-SC	.8189	20.80	.149	○																						
DC2090M-SC	.8228	20.90	.150	○																						
DC2099M-SC	.8264	20.99	.150	○																						
DC2100M-SC	0.8268	21.00	3.82	○	SS25-DRC210M-○																					
DC2150M-SC	0.8465	21.50	3.91	○	SF25-DRC210M-○																					
DC2200M-SC	0.8661	22.00	4.00	○	SS25-DRC220M-○																					
DC2250M-SC	0.8858	22.50	4.09	○	SF25-DRC220M-○																					
DC2300M-SC	0.9055	23.00	4.18	○	SS25-DRC230M-○																					
DC2350M-SC	0.9252	23.50	4.27	○	SF25-DRC230M-○																					
DC2400M-SC	0.9449	24.00	4.37	○	SS25-DRC240M-○																					
DC2450M-SC	0.9646	24.50	4.46	○	SF25-DRC240M-○																					
DC2500M-SC	0.9843	25.00	4.55	○	SS32-DRC250M-○																					
DC2550M-SC	1.0039	25.50	4.64	○	SF25-DRC250M-○																					

DC inserts are sold in 1 piece boxes.

● : Stock Standard
○ : World Express

● Insert grade PR0315

PR0315 is a tough super micro grain carbide grade with TiAlN coating, providing excellent wear resistance and fracture resistance. It enables stable machining of carbon steel, alloy steel and cast iron.



Magic Drill DRC

Drilling

Toolholder Identification System

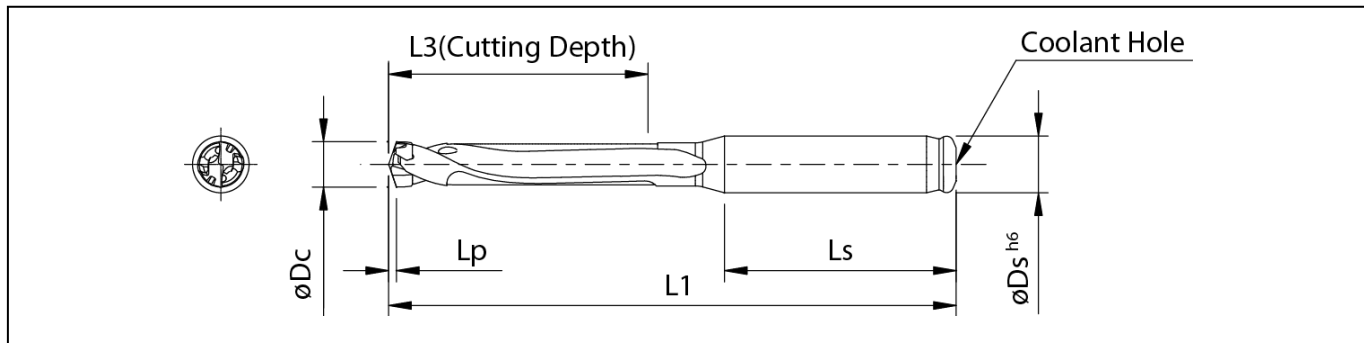
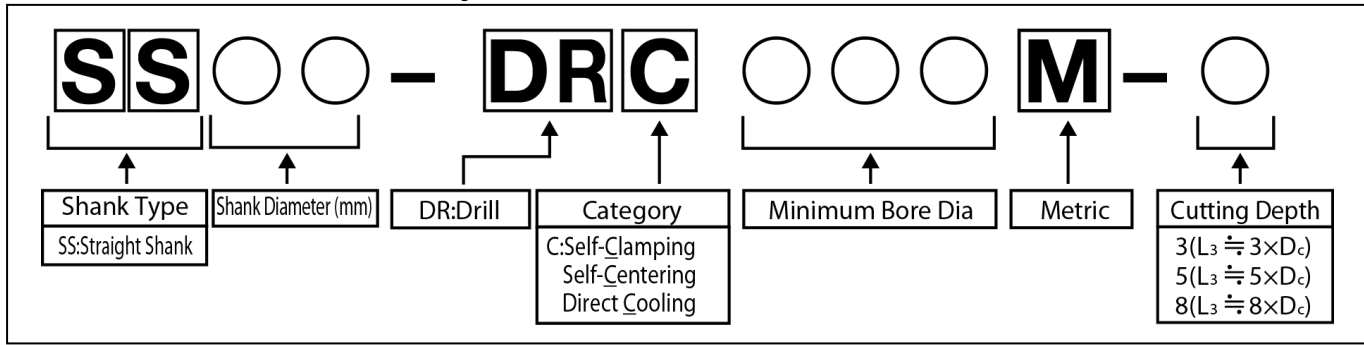

• Lp indicates distance from drill point to corner edge [See 39-41](#)

SS-DRC (Cutting Depth : 3xD)

Toolholder Dimensions

Description (ISO)	Stock	ØDc Applicable Insert Dia.(mm)		Dimensions(mm)				Spare Parts Wrench Page 47	Applicable Insert (ANSI) Page 38-40	Applicable Chamfering Holder and Insert Description	
		min.	max.	ØDs (h6)	L1	L3	Ls			Holder Page 43	Insert Page 44
SS10-DRC080M-3	○	7.94	8.49	10	79	25.5	40	WDR8 (WDR17)	DC0794M-SC-DC0840M-SC	S20-CH10	CT08T2-45A
SS10-DRC085M-3	○	8.50	8.99		81	27.0			DC0850M-SC-DC0890M-SC		
SS10-DRC090M-3	○	9.00	9.49		83	28.5			DC0900M-SC-DC0940M-SC		
SS10-DRC095M-3	○	9.50	9.99		85	30.0			DC0950M-SC-DC0990M-SC		
SS12-DRC100M-3	○	10.00	10.49	12	92	31.5	45	WDR10 (WDR17)	DC1000M-SC-DC1040M-SC	S32-CH12	CT12T3-45A
SS12-DRC105M-3	○	10.50	10.99		94	33.0			DC1050M-SC-DC1090M-SC		
SS12-DRC110M-3	○	11.00	11.49		96	34.5			DC1100M-SC-DC1140M-SC		
SS12-DRC115M-3	○	11.50	11.99		98	36.0			DC1150M-SC-DC1190M-SC		
SS14-DRC120M-3	○	12.00	12.49	14	101	37.5	48	WDR12 (WDR17)	DC1200M-SC-DC1240M-SC	S32-CH14	CT12T3-45A
SS14-DRC125M-3	○	12.50	12.99		103	39.0			DC1250M-SC-DC1290M-SC		
SS14-DRC130M-3	○	13.00	13.49		105	40.5			DC1300M-SC-DC1340M-SC		
SS14-DRC135M-3	○	13.50	13.99		107	42.0			DC1350M-SC-DC1390M-SC		
SS16-DRC140M-3	○	14.00	14.49	16	112	43.5	51	WDR14 (WDR17)	DC1400M-SC-DC1440M-SC	S32-CH16	CT12T3-45A
SS16-DRC145M-3	○	14.50	14.99		114	45.0			DC1450M-SC-DC1490M-SC		
SS16-DRC150M-3	○	15.00	15.99		118	48.0			DC1500M-SC-DC1580M-SC		
SS18-DRC160M-3	○	16.00	16.99		122	51.0			DC1600M-SC-DC1690M-SC		
SS18-DRC170M-3	○	17.00	17.99	18	127	54.0	49	WDR17	DC1700M-SC-DC1790M-SC	S32-CH18	CT12T3-45A
SS20-DRC180M-3	○	18.00	18.99	20	133	57.0	51		DC1800M-SC-DC1890M-SC		
SS20-DRC190M-3	○	19.00	19.99		137	60.0			DC1900M-SC-DC1990M-SC		
SS25-DRC200M-3	○	20.00	20.99	25	147	63.0	56		DC2000M-SC-DC2099M-SC		
SS25-DRC210M-3	○	21.00	21.99		151	66.0		DC2100M-SC-DC2150M-SC			
SS25-DRC220M-3	○	22.00	22.99		156	69.0		DC2200M-SC-DC2250M-SC			
SS25-DRC230M-3	○	23.00	23.99		160	72.0		DC2300M-SC-DC2350M-SC			
SS25-DRC240M-3	○	24.00	24.99		164	75.0		DC2400M-SC-DC2450M-SC			
SS32-DRC250M-3	○	25.00	25.50		32	172		78.0	60	DC2500M-SC-DC2550M-SC	

Recommended Cutting Conditions [Page 47](#)

● : Stock Standard
○ : World Express



SS-DRC (Cutting Depth : 5xD)

Description	Stock	ØDc Applicable Insert Dia.(inch)		Dimensions(mm)				Spare Parts	Applicable Insert (ANSI) Page 38-40	Applicable Chamfering Holder and Insert Description	
		min.	max.	ØDs (h6)	L1	L3	Ls	Wrench Page 47		Holder	Insert
										Page 43	Page 44
SS10-DRC080M-5	○	7.94	8.49	10	97	42.5	40	WDRC8 (WDRC17)	DC0794M-SC~DC0840M-SC	S20-CH10	CT08T2-45A
SS10-DRC085M-5	○	8.50	8.99		100	45.0			DC0850M-SC~DC0890M-SC		
SS10-DRC090M-5	○	9.00	9.49		103	47.5			DC0900M-SC~DC0940M-SC		
SS10-DRC095M-5	○	9.50	9.99		107	50.0			DC0950M-SC~DC0990M-SC		
SS12-DRC100M-5	○	10.00	10.49	12	115	52.5	45	WDRC10 (WDRC17)	DC1000M-SC~DC1040M-SC	S32-CH12	CT12T3-45A
SS12-DRC105M-5	○	10.50	10.99		118	55.0			DC1050M-SC~DC1090M-SC		
SS12-DRC110M-5	○	11.00	11.49		121	57.5			DC1100M-SC~DC1140M-SC		
SS12-DRC115M-5	○	11.50	11.99	124	60.0	DC1150M-SC~DC1190M-SC	48	WDRC12 (WDRC17)	DC1200M-SC~DC1240M-SC	S32-CH14	CT12T3-45A
SS14-DRC120M-5	○	12.00	12.49	14	127	62.5			DC1250M-SC~DC1290M-SC		
SS14-DRC125M-5	○	12.50	12.99		130	65.0			DC1300M-SC~DC1340M-SC		
SS14-DRC130M-5	○	13.00	13.49		133	67.5			DC1350M-SC~DC1390M-SC		
SS14-DRC135M-5	○	13.50	13.99	137	70.0	DC1400M-SC~DC1440M-SC	49	WDRC14 (WDRC17)	DC1450M-SC~DC1490M-SC	S32-CH16	CT12T3-45A
SS16-DRC140M-5	○	14.00	14.49	16	143	72.5			DC1500M-SC~DC1580M-SC		
SS16-DRC145M-5	○	14.50	14.99		146	75.0			DC1600M-SC~DC1690M-SC		
SS16-DRC150M-5	○	15.00	15.99	18	152	80.0	51	WDRC17	DC1700M-SC~DC1790M-SC	S32-CH18	CT12T3-45A
SS18-DRC160M-5	○	16.00	16.99		158	85.0			DC1800M-SC~DC1890M-SC		
SS18-DRC170M-5	○	17.00	17.99	165	90.0	DC1900M-SC~DC1990M-SC	56	WDRC17	DC2000M-SC~DC2099M-SC	-	-
SS20-DRC180M-5	○	18.00	18.99	20	173	95.0			DC2100M-SC~DC2150M-SC		
SS20-DRC190M-5	○	19.00	19.99		179	100.0			DC2200M-SC~DC2250M-SC		
SS25-DRC200M-5	○	20.00	20.99	25	191	105.0	60	WDRC17	DC2300M-SC~DC2350M-SC	-	-
SS25-DRC210M-5	○	21.00	21.99		198	110.0			DC2400M-SC~DC2450M-SC		
SS25-DRC220M-5	○	22.00	22.99		204	115.0			DC2500M-SC~DC2550M-SC		
SS25-DRC230M-5	○	23.00	23.99		210	120.0					
SS25-DRC240M-5	○	24.00	24.99		216	125.0					
SS25-DRC250M-5	○	25.00	25.50	227	130.0						

SS-DRC (Cutting Depth : 8xD)

Description	Stock	ØDc Applicable Insert Dia.(inch)		Dimensions(mm)				Spare Parts	Applicable Insert (ANSI) Page 38-40	Applicable Chamfering Holder and Insert Description	
		min.	max.	ØDs (h6)	L1	L3	Ls	Wrench Page 47		Holder	Insert
										Page 43	Page 44
SS10-DRC080M-8	○	7.94	8.49	10	122.5	68	40	WDRC8 (WDRC17)	DC0794M-SC~DC0840M-SC	S20-CH10	CT08T2-45A
SS10-DRC085M-8	○	8.50	8.99		127.0	72			DC0850M-SC~DC0890M-SC		
SS10-DRC090M-8	○	9.00	9.49		131.5	76			DC0900M-SC~DC0940M-SC		
SS10-DRC095M-8	○	9.50	9.99		137.0	80			DC0950M-SC~DC0990M-SC		
SS12-DRC100M-8	○	10.00	10.49	12	146.5	84	45	WDRC10 (WDRC17)	DC1000M-SC~DC1040M-SC	S32-CH12	CT12T3-45A
SS12-DRC105M-8	○	10.50	10.99		151.0	88			DC1050M-SC~DC1090M-SC		
SS12-DRC110M-8	○	11.00	11.49		155.5	92			DC1100M-SC~DC1140M-SC		
SS12-DRC115M-8	○	11.50	11.99	160.0	96	DC1150M-SC~DC1190M-SC	48	WDRC12 (WDRC17)	DC1200M-SC~DC1240M-SC	S32-CH14	CT12T3-45A
SS14-DRC120M-8	○	12.00	12.49	14	164.5	100			DC1250M-SC~DC1290M-SC		
SS14-DRC125M-8	○	12.50	12.99		169.0	104			DC1300M-SC~DC1340M-SC		
SS14-DRC130M-8	○	13.00	13.49		173.5	108			DC1350M-SC~DC1390M-SC		
SS14-DRC135M-8	○	13.50	13.99	179.0	112	DC1400M-SC~DC1440M-SC	49	WDRC14 (WDRC17)	DC1450M-SC~DC1490M-SC	S32-CH16	CT12T3-45A
SS16-DRC140M-8	○	14.00	14.49	16	186.5	116			DC1500M-SC~DC1580M-SC		
SS16-DRC145M-8	○	14.50	14.99		191.0	120			DC1600M-SC~DC1690M-SC		
SS16-DRC150M-8	○	15.00	15.99	18	200.0	128	51	WDRC17	DC1700M-SC~DC1790M-SC	S32-CH18	CT12T3-45A
SS18-DRC160M-8	○	16.00	16.99		209.0	136			DC1800M-SC~DC1890M-SC		
SS18-DRC170M-8	○	17.00	17.99	219.0	144	DC1900M-SC~DC1990M-SC	56	WDRC17	DC2000M-SC~DC2099M-SC	-	-
SS20-DRC180M-8	○	18.00	18.99	20	230.0	152			DC2100M-SC~DC2150M-SC		
SS20-DRC190M-8	○	19.00	19.99		239.0	160			DC2200M-SC~DC2250M-SC		
SS25-DRC200M-8	○	20.00	20.99	25	254.0	168	60	WDRC17	DC2300M-SC~DC2350M-SC	-	-
SS25-DRC210M-8	○	21.00	21.99		264.0	176			DC2400M-SC~DC2450M-SC		
SS25-DRC220M-8	○	22.00	22.99		273.0	184			DC2500M-SC~DC2550M-SC		
SS25-DRC230M-8	○	23.00	23.99		282.0	192					
SS25-DRC240M-8	○	24.00	24.99		291.0	200					
SS32-DRC250M-8	○	25.00	25.50	32	305.0	208	60	WDRC17	DC2500M-SC~DC2550M-SC		

Recommended Cutting Conditions Page 47

● : Stock Standard
○ : World Express

Chamfering Attachment

- Drilling and chamfering simultaneously

By using the chamfering attachment, the SS-DRC can perform drilling and chamfering in one set up.

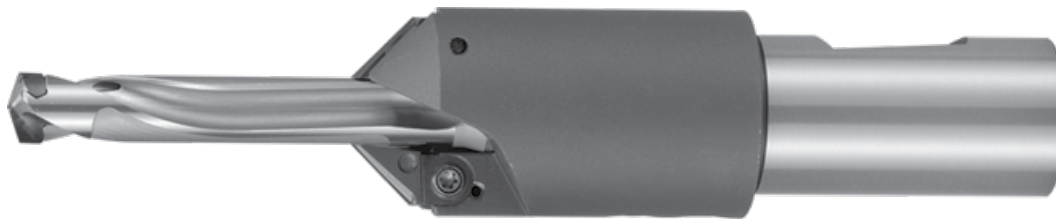

- Toolholder

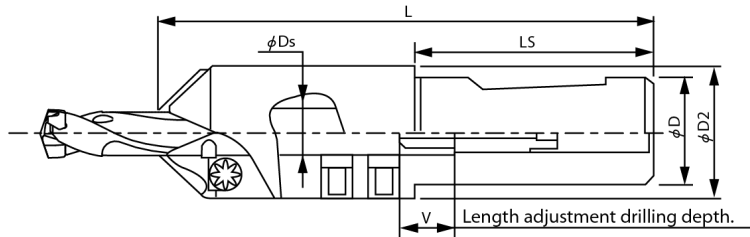

Description	stock	Applicable Drill Dia.Ds	Dimensions(mm)					Applicable Insert
			ϕD	ϕD_2	L	L_S	V	
S20-CH10	○	10	20	29	122	52	17	CT08T2-45A
S32-CH12	○	12	32	38	133	62	21	CT12T3-45A
S32-CH14	○	14		40	137		16	
S32-CH16	○	16		42	141		19	
S32-CH18	○	18		47	144		15	

- Drilling and chamfering depths

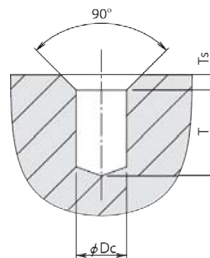

● : Stock Standard
○ : World Express

Cutting Dia.(inch)		Drilling depth(inch)						Chamfering dimension(inch)		Applicable Toolholder
ϕD_c		T(3xD)		T(5xD)		T(8xD)		T_s		
min	max	min	max	min	max	min	max	T_s 100	T_s max	
.3125	.3343	0.433	0.748	0.827	1.457	1.850	2.480	.0984	.1969	S20-CH10
.3346	.3539	0.472	0.827	0.945	1.575	2.008	2.638			
.3543	.3736	0.472	0.906	1.063	1.693	2.205	2.835			
.3740	.3933	0.512	0.984	1.220	1.850	2.402	3.031	.1378	.2756	S32-CH12
.3937	.4130	0.512	1.024	1.102	1.929	2.362	3.189			
.4134	.4327	0.551	1.102	1.220	2.047	2.520	3.346			
.4331	.4524	0.551	1.181	1.339	2.165	2.717	3.543	.1575	.3150	S32-CH14
.4528	.4720	0.591	1.260	1.457	2.283	2.874	3.701			
.4724	.4917	0.591	1.181	1.614	2.205	3.110	3.701			
.4921	.5114	0.669	1.260	1.732	2.323	3.268	3.780	.1575	.3150	S32-CH16
.5118	.5311	0.748	1.339	1.850	2.441	3.465	4.055			
.5315	.5508	0.827	1.417	2.008	2.598	3.661	4.252			
.5512	.5705	0.748	1.457	1.969	2.677	3.701	4.409	.1575	.3150	S32-CH18
.5709	.5902	0.827	1.535	2.087	2.795	3.858	4.567			
.5906	.6295	0.984	1.693	2.323	3.031	4.213	4.921			
.6300	.6689	1.181	1.732	2.598	3.150	4.606	5.157	.1575	.3150	S32-CH18
.6692	.7083	1.378	1.929	2.874	3.425	5.000	5.551			

T_s 100 : Max chamfering dimension at the full feed.
 T_s max : Max chamfering dimension at a 50% feed reduction.

● Applicable Chamfering Insert

Shape		Description	Dimensions (mm)		PVD Coated	Applicable Toolholder
			W1	T	PR0315	
		CT08T2-45A	8	2.83	○	S20-CH10
		CT12T3-45A	12	3.98	○	S32-CH12 ~ S32-CH18

● : Stock Standard
○ : World Express

● Method to use DRC chamfering attachment

1. Drilling depth adjustment

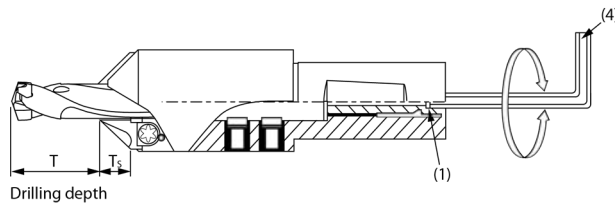

- Insert drill into chamfering attachment.
- Next, temporarily attach the chamfering insert A.
- Turn the adjusting screw (1) with the hexagon wrench (4) to set the drilling depth T.

2. Drill location check

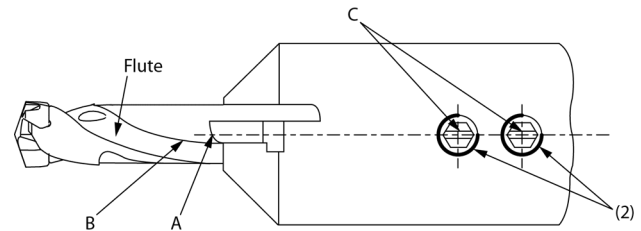

- Rotate the drill so that the lower end of the chamfering insert A is aligned with the body clearance B of the drill.
- Set it so that slot C and the drill fitting screws (2) are lined up as shown in the figure above.

3. Fix the drill

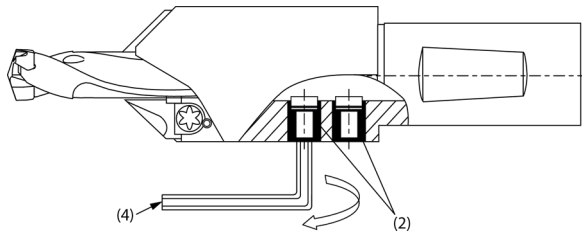

- Tighten the drill fitting screws (2) with the hexagon wrench (4). (In the case of using a torque wrench, then please refer to the table below.)

4. Installation of the chamfering insert

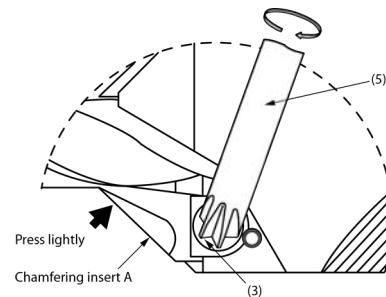

- Press the chamfering insert A lightly into the drill and tighten the insert mounting screw (3) with wrench (5).

Chamfering Attachment	Torque [Nm]	Adjusting Screw	Drill Fitting Screw	Insert Mounting Screw	Hexagon Wrench	Wrench
S20-CH10	10	AJ-6X38	FS-10	MT-3	LW-3	DT-9
S32-CH12	15	AJ-8X44-9.5	FS-12	MT-4		LW-3
S32-CH14	20	AJ-10X46	FS-14			
S32-CH16	30		FS-16			
S32-CH18	45		FS-18			



Toolholder Identification System

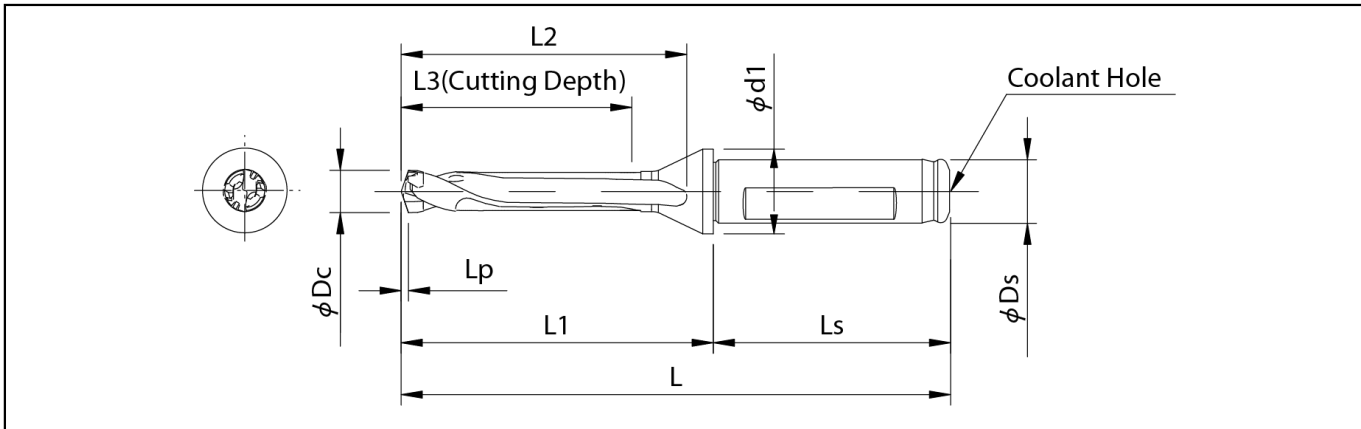
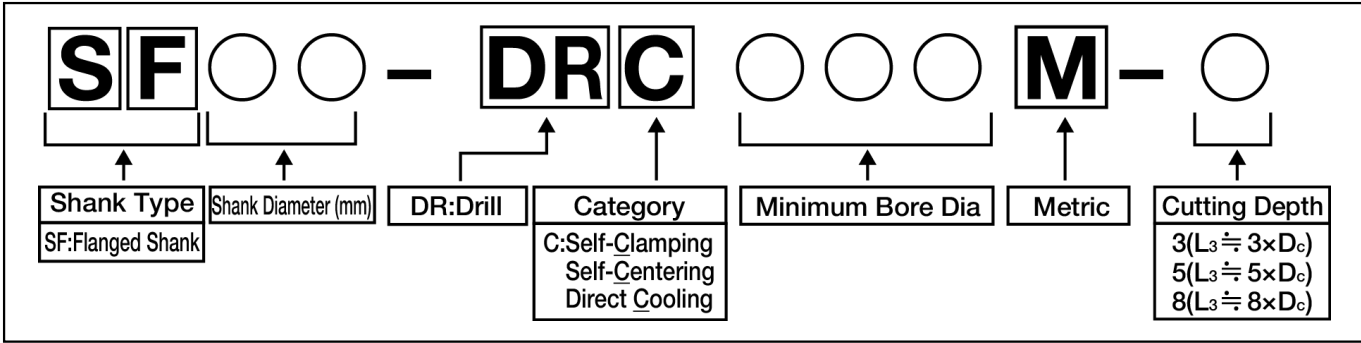

• L_p indicates distance from drill point to corner edge [See 38-40](#)

SF-DRC (Cutting Depth : 3xD)

Toolholder Dimensions

Description (ISO)	Stock	ØDc Applicable Insert Dia.(inch)		Dimensions(mm)						Spare Parts	Applicable Insert (ANSI)	
		min.	max.	ØDs (h6)	L	L1	L2	L3	Ls			Ød1
SF12-DRC080M-3	○	7.94	8.49	12	86	41	35	26	45	16	WDR8 (WDR17)	DC03125-SC~DC03307-SC
SF12-DRC085M-3	○	8.50	8.99		88	43	37	27				DC03346-SC~DC03504-SC
SF12-DRC090M-3	○	9.00	9.49		90	45	39	29				DC03543-SC~DC03701-SC
SF12-DRC095M-3	○	9.50	9.99		92	47	41	30				DC03740-SC~DC03898-SC
SF16-DRC100M-3	○	10.00	10.49	16	97	49	43	32	48	20	WDR10 (WDR17)	DC03937-SC~DC04094-SC
SF16-DRC105M-3	○	10.50	10.99		99	51	45	33				DC04134-SC~DC04291-SC
SF16-DRC110M-3	○	11.00	11.49		101	53	47	35				DC04331-SC~DC04488-SC
SF16-DRC115M-3	○	11.50	11.99		103	55	49	36				DC04528-SC~DC04685-SC
SF16-DRC120M-3	○	12.00	12.49		106	58	52	38			DC04724-SC~DC04882-SC	
SF16-DRC125M-3	○	12.50	12.99		108	60	54	39			DC04921-SC~DC05080-SC	
SF16-DRC130M-3	○	13.00	13.49		110	62	56	41			DC05118-SC~DC05276-SC	
SF16-DRC135M-3	○	13.50	13.99		112	64	58	42			DC05315-SC~DC05471-SC	
SF16-DRC140M-3	○	14.00	14.49	20	114	66	60	44	50	25	WDR14 (WDR17)	DC05512-SC~DC05669-SC
SF16-DRC145M-3	○	14.50	14.99		116	68	62	45				DC05709-SC~DC05866-SC
SF20-DRC150M-3	○	15.00	15.99		122	72	66	48				DC05906-SC~DC06220-SC
SF20-DRC160M-3	○	16.00	16.99		126	76	70	51				DC06300-SC~DC06654-SC
SF20-DRC170M-3	○	17.00	17.99	25	131	81	75	54	56	32	WDR17	DC06692-SC~DC07047-SC
SF25-DRC180M-3	○	18.00	18.99		141	85	79	57				DC07087-SC~DC07441-SC
SF25-DRC190M-3	○	19.00	19.99		145	89	83	60				DC07480-SC~DC07835-SC
SF25-DRC200M-3	○	20.00	20.99		149	93	87	63				DC07874-SC~DC08264-SC

Recommended Cutting Conditions [Page 47](#)

● : Stock Standard
○ : World Express

SF-DRC (Cutting Depth : 5xD)

● Toolholder Dimensions

Description	stock	ØDc Applicable Insert Dia.(inch)		Dimensions(mm)						Spare Parts	Applicable Insert (ANSI) ● Page 38-40				
		min.	max.	ØDs (h6)	L	L1	L2	L3	Ls	Ød1		Wrench ● Page 47			
SF12-DRC080M-5	○	7.94	8.49	12	104	59	53	43	45	16	WDR8 (WDR17)	DC03125-SC~DC03307-SC			
SF12-DRC085M-5	○	8.50	8.99		107	62	56	45				DC03346-SC~DC03504-SC			
SF12-DRC090M-5	○	9.00	9.49		110	65	59	48				DC03543-SC~DC03701-SC			
SF12-DRC095M-5	○	9.50	9.99		114	69	63	50				DC03740-SC~DC03898-SC			
SF16-DRC100M-5	○	10.00	10.49	16	120	72	66	53	48	20	WDR10 (WDR17)	DC03937-SC~DC04094-SC			
SF16-DRC105M-5	○	10.50	10.99		123	75	69	55				DC04134-SC~DC04291-SC			
SF16-DRC110M-5	○	11.00	11.49		126	78	72	58				DC04331-SC~DC04488-SC			
SF16-DRC115M-5	○	11.50	11.99		129	81	75	60				DC04528-SC~DC04685-SC			
SF16-DRC120M-5	○	12.00	12.49		132	84	78	63			DC04724-SC~DC04882-SC				
SF16-DRC125M-5	○	12.50	12.99		135	87	81	65			DC04921-SC~DC05080-SC				
SF16-DRC130M-5	○	13.00	13.49		138	90	84	68			DC05118-SC~DC05276-SC				
SF16-DRC135M-5	○	13.50	13.99		142	94	88	70			DC05315-SC~DC05471-SC				
SF16-DRC140M-5	○	14.00	14.49		145	97	91	73			DC05512-SC~DC05669-SC				
SF16-DRC145M-5	○	14.50	14.99		148	100	94	75			DC05709-SC~DC05866-SC				
SF20-DRC150M-5	○	15.00	15.99		20	156	106	100			80	50	25	WDR14 (WDR17)	DC05906-SC~DC06220-SC
SF20-DRC160M-5	○	16.00	16.99			162	112	106			85				DC06300-SC~DC06654-SC
SF20-DRC170M-5	○	17.00	17.99	169		119	113	90	DC06692-SC~DC07047-SC						
SF25-DRC180M-5	○	18.00	18.99	25	181	125	119	95	56	32	WDR17	DC07087-SC~DC07441-SC			
SF25-DRC190M-5	○	19.00	19.99		187	131	125	100				DC07480-SC~DC07835-SC			
SF25-DRC200M-5	○	20.00	20.99		193	137	131	105				DC07874-SC~DC08264-SC			

Recommended Cutting Conditions ● Page 47

● : Stock Standard
○ : World Express

SF-DRC (Cutting Depth : 8xD)

● Toolholder Dimensions

Description	stock	ØDc Applicable Insert Dia.(inch)		Dimensions(mm)						Spare Parts	Applicable Insert (ANSI) ● Page 38-40				
		min.	max.	ØDs (h6)	L	L1	L2	L3	Ls	Ød1		Wrench ● Page 47			
SF12-DRC080M-8	○	7.94	8.49	12	129	84	79	68	45	16	WDR8 (WDR17)	DC03125-SC~DC03307-SC			
SF12-DRC085M-8	○	8.50	8.99		134	89	83	72				DC03346-SC~DC03504-SC			
SF12-DRC090M-8	○	9.00	9.49		138	93	88	76				DC03543-SC~DC03701-SC			
SF12-DRC095M-8	○	9.50	9.99		144	99	93	80				DC03740-SC~DC03898-SC			
SF16-DRC100M-8	○	10.00	10.49	16	151	103	97	84	48	20	WDR10 (WDR17)	DC03937-SC~DC04094-SC			
SF16-DRC105M-8	○	10.50	10.99		156	108	102	88				DC04134-SC~DC04291-SC			
SF16-DRC110M-8	○	11.00	11.49		160	112	107	92				DC04331-SC~DC04488-SC			
SF16-DRC115M-8	○	11.50	11.99		165	117	111	96				DC04528-SC~DC04685-SC			
SF16-DRC120M-8	○	12.00	12.49		169	121	116	100			DC04724-SC~DC04882-SC				
SF16-DRC125M-8	○	12.50	12.99		174	126	120	104			DC04921-SC~DC05080-SC				
SF16-DRC130M-8	○	13.00	13.49		178	130	124	108			DC05118-SC~DC05276-SC				
SF16-DRC135M-8	○	13.50	13.99		184	136	130	112			DC05315-SC~DC05471-SC				
SF16-DRC140M-8	○	14.00	14.49		188	140	134	116			DC05512-SC~DC05669-SC				
SF16-DRC145M-8	○	14.50	14.99		193	145	139	120			DC05709-SC~DC05866-SC				
SF20-DRC150M-8	○	15.00	15.99		20	204	154	148			128	50	25	WDR14 (WDR17)	DC05906-SC~DC06220-SC
SF20-DRC160M-8	○	16.00	16.99			213	163	157			136				DC06300-SC~DC06654-SC
SF20-DRC170M-8	○	17.00	17.99	223		173	167	144	DC06692-SC~DC07047-SC						
SF25-DRC180M-8	○	18.00	18.99	25	238	182	176	152	56	32	WDR17	DC07087-SC~DC07441-SC			
SF25-DRC190M-8	○	19.00	19.99		247	191	185	160				DC07480-SC~DC07835-SC			
SF25-DRC200M-8	○	20.00	20.99		256	200	194	168				DC07874-SC~DC08264-SC			

Recommended Cutting Conditions ● Page 47

● : Stock Standard
○ : World Express



Magic Drill DRC

Drilling

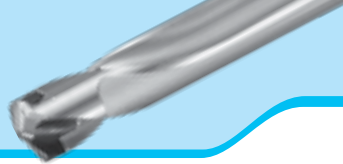

Recommended Cutting Conditions

Workpiece Material		Hardness (HB)	Cutting Condition		Cutting Dia. ØDc(inch)						
			Cutting Speed Vc(SFM)	Spindle Revolution (min ⁻¹)	Ø0.315	Ø0.3937	Ø0.4724	Ø0.5512	Ø0.6300	Ø0.7087	Ø0.7874
Low Carbon Steel	1010-1025	125	400 - 600	Spindle Revolution(min ⁻¹)	4,780 - 7,170	3,820 - 5,730	3,180 - 4,780	2,730 - 4,090	2,390 - 3,580	2,120 - 3,180	1,910 - 2,870
				Feed Rate(ipr)	.0043 - .0079	.0051 - .0094	.0055 - .0110	.0067 - .0125	.0075 - .0138	.0091 - .0150	.0098 - .0161
Carbon Steel	1030-1060 (Annealed)	190	330 - 500	Spindle Revolution(min ⁻¹)	3,980 - 5,970	3,180 - 4,780	2,650 - 3,980	2,270 - 3,410	1,990 - 2,990	1,770 - 2,650	1,590 - 2,390
				Feed Rate(ipr)	.0051 - .0094	.0059 - .0114	.0067 - .0130	.0075 - .0142	.0087 - .0161	.0098 - .0181	.0110 - .0189
	1030-1060 (Heat treated)	250	260 - 400	Spindle Revolution(min ⁻¹)	3,180 - 4,780	2,550 - 3,820	2,120 - 3,180	1,820 - 2,730	1,590 - 2,390	1,420 - 2,120	1,270 - 1,910
				Feed Rate(ipr)	.0051 - .0083	.0059 - .0098	.0071 - .0122	.0083 - .0154	.0091 - .0177	.0098 - .0209	.0110 - .0240
		300	170 - 250	Spindle Revolution(min ⁻¹)	1,990 - 2,990	1,590 - 2,390	1,330 - 1,990	1,140 - 1,710	1,000 - 1,490	880 - 1,330	800 - 1,190
				Feed Rate(ipr)	.0043 - .0075	.0047 - .0091	.0063 - .0110	.0083 - .0126	.0091 - .0138	.0098 - .0161	.0110 - .0161
Alloy Steel	4137, 5132 (Annealed)	180	230 - 310	Spindle Revolution(min ⁻¹)	2,790 - 3,780	2,230 - 3,030	1,860 - 2,520	1,590 - 2,160	1,390 - 1,890	1,240 - 1,680	1,110 - 1,510
				Feed Rate(ipr)	.0059 - .0110	.0063 - .0138	.0083 - .0146	.0091 - .0181	.0098 - .0181	.0098 - .0201	.0118 - .0201
	4137, 5132 (Heat treated)	275	230 - 310	Spindle Revolution(min ⁻¹)	2,790 - 3,780	2,230 - 3,030	1,860 - 2,520	1,590 - 2,160	1,390 - 1,890	1,240 - 1,680	1,110 - 1,510
				Feed Rate(ipr)	.0043 - .0083	.0055 - .0098	.0075 - .0118	.0083 - .0130	.0091 - .0146	.0110 - .0169	.0110 - .0181
		300	200 - 300	Spindle Revolution(min ⁻¹)	2,390 - 3,580	1,910 - 2,870	1,590 - 2,390	1,360 - 2,050	1,190 - 1,790	1,060 - 1,590	960 - 1,430
				Feed Rate(ipr)	.0043 - .0075	.0047 - .0091	.0063 - .0102	.0071 - .0122	.0083 - .0130	.0091 - .0142	.0098 - .0150
		350	170 - 250	Spindle Revolution(min ⁻¹)	1,990 - 2,990	1,590 - 2,390	1,330 - 1,990	1,140 - 1,710	1,000 - 1,490	880 - 1,330	800 - 1,190
				Feed Rate(ipr)	.0043 - .0079	.0047 - .0091	.0063 - .0098	.0067 - .0114	.0071 - .0126	.0079 - .0142	.0091 - .0150
Stainless Steel	304 316	220	200 - 260	Spindle Revolution(min ⁻¹)	2,390 - 3,180	1,910 - 2,550	1,590 - 2,120	1,360 - 1,820	1,190 - 1,590	1,060 - 1,420	960 - 1,270
				Feed Rate(ipr)	.0043 - .0075	.0047 - .0091	.0063 - .0102	.0071 - .0122	.0083 - .0130	.0091 - .0142	.0098 - .0150
	S17400	300	170 - 230	Spindle Revolution(min ⁻¹)	1,990 - 2,790	1,590 - 2,230	1,330 - 1,860	1,140 - 1,590	1,000 - 1,390	880 - 1,240	800 - 1,110
				Feed Rate(ipr)	.0043 - .0079	.0047 - .0091	.0063 - .0098	.0067 - .0114	.0071 - .0126	.0079 - .0142	.0091 - .0150
Gray Cast Iron	No.30-35	180	400 - 560	Spindle Revolution(min ⁻¹)	4,780 - 6,770	3,820 - 5,410	3,180 - 4,510	2,730 - 3,870	2,390 - 3,380	2,120 - 3,010	1,910 - 2,710
				Feed Rate(ipr)	.0067 - .0126	.0079 - .0146	.0091 - .0169	.0106 - .0189	.0118 - .0217	.0130 - .0240	.0130 - .0240
	No.45-60	260	300 - 400	Spindle Revolution(min ⁻¹)	3,580 - 4,780	2,870 - 3,820	2,390 - 3,180	2,050 - 2,730	1,790 - 2,390	1,590 - 2,120	1,430 - 1,910
				Feed Rate(ipr)	.0055 - .0098	.0063 - .0122	.0075 - .0138	.0091 - .0165	.0102 - .0185	.0110 - .0209	.0118 - .0228
Nodular Cast Iron	60-40-18-70-50-05	160	200 - 300	Spindle Revolution(min ⁻¹)	2,390 - 3,580	1,910 - 2,870	1,590 - 2,390	1,360 - 2,050	1,190 - 1,790	1,060 - 1,590	960 - 1,430
				Feed Rate(ipr)	.0055 - .0098	.0063 - .0118	.0075 - .0138	.0087 - .0157	.0094 - .0177	.0110 - .0201	.0110 - .0220
	80-60-03-120-90-02	250	130 - 210	Spindle Revolution(min ⁻¹)	1,590 - 2,590	1,270 - 2,070	1,060 - 1,730	910 - 1,480	800 - 1,290	710 - 1,150	640 - 1,040
				Feed Rate(ipr)	.0039 - .0075	.0047 - .0087	.0055 - .0098	.0063 - .0122	.0075 - .0138	.0091 - .0201	.0098 - .0209

Wrench for Installing Inserts

Shape		Description	Dimension(inch)			Remarks
			A	B	C	
		WDCR8	1.69	1.30	Ø0.402	
		WDCR10			Ø0.480	
		WDCR12			Ø0.559	
		WDCR14			Ø0.677	
		WDCR17	3.03	2.05	-	<ul style="list-style-type: none"> •WDCR17(Multiple type wrench) has four insert entry points. If using an insert ranging from DC06692-SC to DC08264-SC, use the entry point printed as Ø0.6692"~Ø0.8264". •WDCR17 can be used instead of WDCR8~14 wrench.

Method to change DRC Type Magic Drill Inserts

How to Attach Inserts



- 1) Fix drill holder on arbor. For insert exchange, fix arbor on the machine or set on tool presetter.
- 2) Remove dust using air blower.



- 3) Install insert onto holder.
(Use gloves to protect your hand from any danger.)



- 4) Turn lightly in a clockwise direction.
(Use gloves to protect your hand from any danger.)



- 5) Align the wrench properly with the insert.



- 6) Make sure the wrench is aligned with the wrench slots on the insert.



(Improper alignment shown)



Slot for wrench



- 7) Turn the wrench in a slow clockwise direction.
- 8) Completed.

How to Detach Inserts



- 1) Remove dust from insert using air blower.
- 2) Align the wrench properly with the insert.



- 3) Make sure the wrench is aligned with the wrench slots on the insert.



- 4) Turn the wrench in a counterclockwise direction.

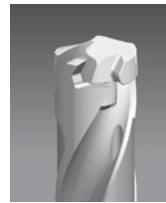

- 5) Once lock is released, insert can be turned by fingers.
(Use gloves to protect your hand from any danger.)

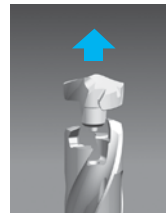

- 6) Remove insert.
(Use gloves to protect your hand from any danger.)



Coolant

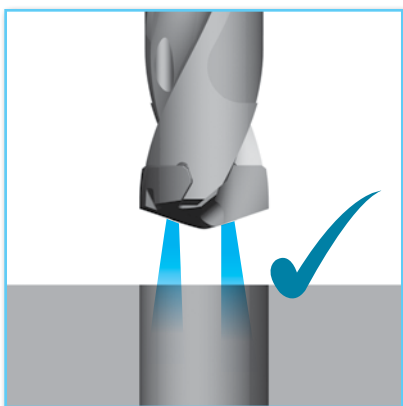

- 1) Internal coolant is recommended.

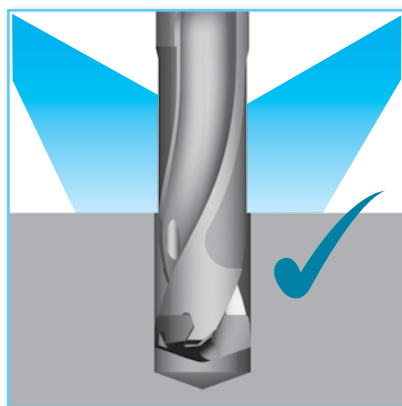

- 2) In case of external coolant
Cutting depth must be 3xD or less.

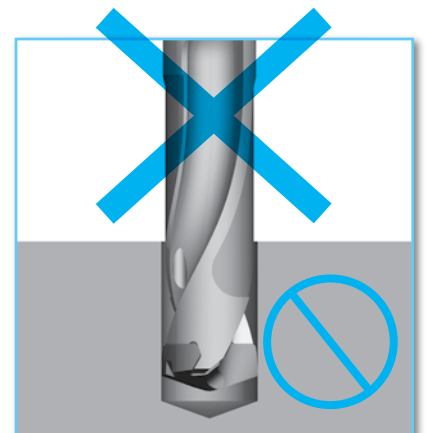

- 3) Dry cutting is not recommended.

Magic Drill DRC

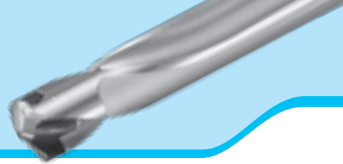

Precautions for Use

Core Deviation

1) If drill is stationary

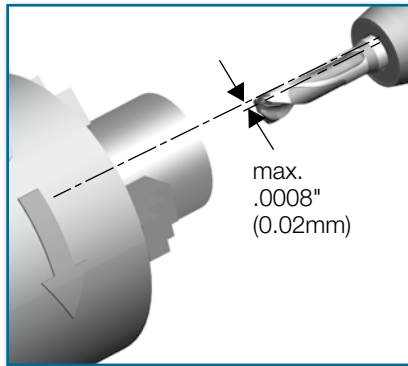

The max runout between the drill and spindle should not exceed 0.0008.

2) If drill is rotating

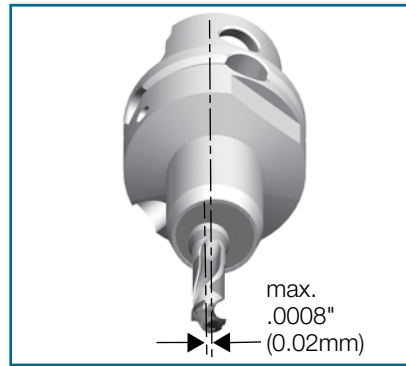

The max runout allowable on the drill is 0.0008



Magic Drill DRC

Drilling

Applicable Workpieces

Application	Workpiece Shape	Caution for machining
Flat Face		<ol style="list-style-type: none"> Due to good chip control, peck drilling is not necessary for soft steel like 1015. When machining 304, for hole depths of more than 2.5D, utilize the step machining process. In order to have smooth chip removal, we recommend internal coolant.
Stacked Plates		<ol style="list-style-type: none"> Fix stacked plates securely to ensure they do not slip while machining.
Hole Expansion		<ol style="list-style-type: none"> If the overlap amount is less than $1/3 \times D$, machining is possible.
Concave Surface		<ol style="list-style-type: none"> When machining concave holes set the feed rates at half or less than continuous hole machining.
Pipe Material		<ol style="list-style-type: none"> Hole machining above the centerline of the pipe is possible. Do not machine on curved surface areas.

Not Recommended Workpieces

Application	Workpiece Shape
Slanted Surface	

Application	Workpiece Shape
Half Cylindrical	

Application	Workpiece Shape
Cored Hole	



Reference Charts

<Cutting Condition>

Heat treated steel (Hardness 240HB) $V_c=80\text{m/min}$, Wet

● Power required

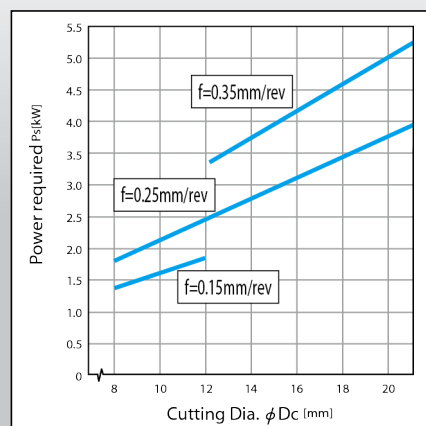

● Thrust force

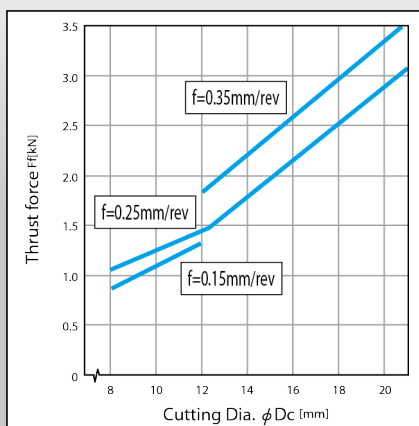

● Torque

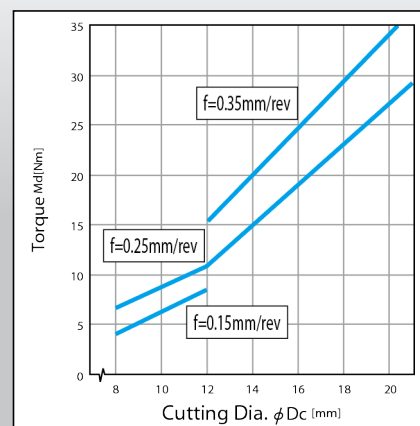

Case Studies

1049	
<ul style="list-style-type: none"> Flange $V_c=97\text{m/min}$ ($n=2,490\text{min}^{-1}$) $H=32\text{mm}$ $f=0.3\text{mm/rev}$ ($V_f=747\text{mm/min}$) Wet(Internal Coolant) DC1250M-SC (PR0315) 	
SS14-DRC120M-3	3,000holes/insert
Competitor A	1,800holes/drill
<p>Compared to competitor's drill A, MagicDrill DRC type has reduced burr and reduced more than 10% of the power required. Tool life has also improved greatly.</p> <p style="text-align: right;">Customer Evaluation</p>	

4140	
<ul style="list-style-type: none"> Housing $V_c=83\text{m/min}$ ($n=2,400\text{min}^{-1}$) $H=32\text{mm}$ $f=0.24\text{mm/rev}$ ($V_f=576\text{mm/min}$) Wet(Internal Coolant) DC1100M-SC(PR0315) 	
SS12-DRC110M-3	more than 2,400holes/insert
Competitor B	2,000holes/drill
<p>Compared to competitor's solid drill B, MagicDrill DRC type has greatly reduced preparation time with its easy insert replacement feature. Also, the costs of spare tools for re-grinding has been reduced, and tool life has improved.</p> <p style="text-align: right;">Customer Evaluation</p>	

Q&A

Q-1 Is re-grinding available?

A-1 We don't recommend it. Grinding of edge nose chisel is not possible.

Q-2 How large would the cutting hole be to the insert diameter (φDc)?

A-2 When drilling 4137, the hole diameter will be about 0.020 to 0.040 larger than the insert diameter.



Magic Drill DRS



Magic Drill DRS

Drilling

- 10mm diameter drilling with an indexable insert
- Inner & outer edges on one insert makes replacement easy
- Small chips with good chip evacuation
- High-speed stable machining for high efficiency
- Productivity improvement and significant cost reduction
- Possible to drill into a slant face without pre-drilling

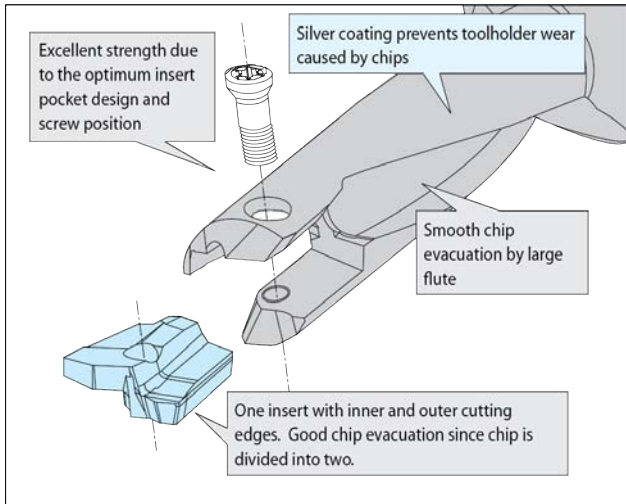

■ Magic Drill DRS Insert

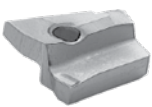
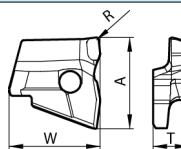
Shape	Description	Dimensions (inch)					Insert Grade Coated Carbide		
		A	T	Ød	W	R	PR1230	PR1210	PR660
 	DS 100	0.346	0.138	-	0.354	0.008	●	●	●
	105	0.366	0.146	-	0.382	0.008	●	●	●
	110	0.386	0.154	-	0.394	0.008	●	●	●
	115	0.402	0.161	-	0.406	0.008	●	●	●
	120	0.425	0.169	-	0.429	0.010	●	●	●

Insert Grade Features ● Page 1

● : Stock Standard
○ : World Express

DRS Drills

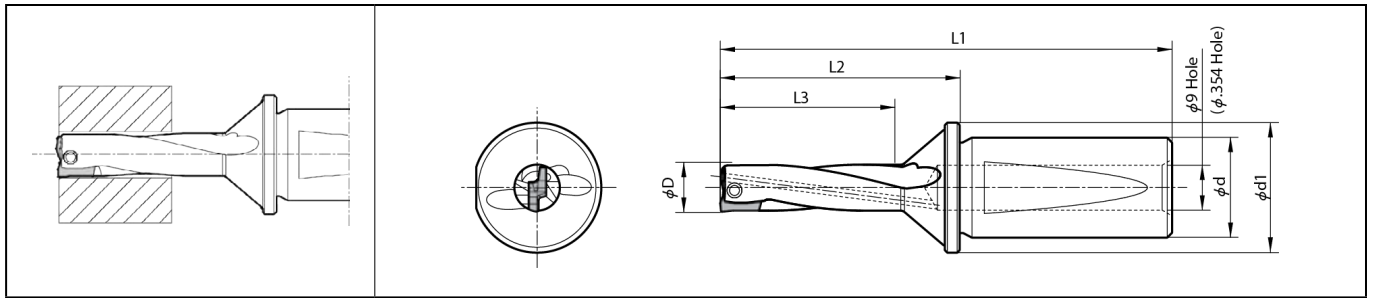

Toolholder Dimensions

Description	Stock	No. of Insert	Unit	Dimension					Max. Offset (Radial)	Spare Parts			Applicable Inserts ➔ Page 51	
				ØD	L1	L2	L3	Ød		Ød1	Insert Screw	Wrench		
S75 -DRS10035	●	1	inch	0.394 (10.0mm)	3.602	1.909	1.378	0.75	1.023	+0.008	SB-2080TR	FT-6	-	DS100
-DRS10537	●	1		0.413 (10.5mm)	3.657	1.964	1.457	0.75	1.023	+0.008				DS105
-DRS11038	●	1		0.433 (11.0mm)	3.759	2.066	1.516	0.75	1.023	+0.008				DS110
-DRS11540	●	1		0.453 (11.5mm)	3.828	2.135	1.594	0.75	1.023	+0.008	SB-2290TR	-	DT-7	DS115
-DRS12042	●	1		0.472 (12.0mm)	3.898	2.205	1.654	0.75	1.023	+0.008	SB-25100TR			DS120
-DRS12544	●	1		0.492 (12.5mm)	3.967	2.274	1.732	0.75	1.023	+0.008	SB-25100TR	-	DT-7	DS120
S20 -DRS10035	○	1	mm	10.0	92	49	35.0	20	26	+0.2	SB-2080TR	FT-6	-	DS100
-DRS10235	○	1		10.2	92	49	35.0	20	26	+0.2				DS105
-DRS10336	○	1		10.3	92	49	36.0	20	26	+0.2				DS110
-DRS10537	○	1		10.5	93	50	37.0	20	26	+0.2	SB-2290TR	-	DT-7	DS115
-DRS11038	○	1		11.0	96	53	38.5	20	26	+0.2	SB-25100TR			DS120
-DRS11540	○	1		11.5	97	54	40.5	20	26	+0.2	SB-25100TR	-	DT-7	DS120
-DRS12042	○	1		12.0	99	56	42.0	20	26	+0.2	SB-25100TR	-	DT-7	DS120
-DRS12544	○	1		12.5	101	58	44.0	20	26	+0.2	SB-25100TR	-	DT-7	DS120

● : Stock Standard
○ : World Express

DRS Recommended Cutting Conditions

Workpiece Material	Recommended Grade (sfm)			Feed Rate (ipr)
	MEGACOAT		PVD Coated Carbide	
	PR1230	PR1210	PR660	
Low Carbon Steel	★ 270~330	-	☆ 270~330	.0024
Carbon Steel	★ 270~330	-	☆ 270~330	.003~.004
Alloy Steel	★ 270	-	☆ 270	.0016~.0024
Mold Steel	★ 270	-	☆ 270	.0016~.0024
Stainless Steel (Austenitic related)	★ 230~270	-	☆ 230~270	.002~.0024
Gray Cast Iron	-	★ 80~100	-	.003~.004

- Apply a sufficient amount of coolant.
- If cutting speed is decreased too much from above condition, chip evacuation will deteriorate.
If the feed rate is increased too much from above condition, inner edge chip evacuation will deteriorate.
If the feed rate is decreased too much from above condition, outer edge chip evacuation will deteriorate.
- If chips become long and are entangled with the tool when low carbon steel cutting, increase the cutting speed to 400-500 SFM.
If this doesn't solve the problem, try peck feeding.
[How to peck feed]
(1)Cut .04-.08 in (2)Return .004 in (3)Repeat (1)and (2)

Small Dia. Magic Drill (DRS) • Hole Bottom Shape (inch)

ØD	A	B	C
0.394	0.087	0.110	0.008
0.402	0.087	0.114	0.008
0.406	0.091	0.114	0.008
0.413	0.091	0.118	0.008
0.433	0.094	0.122	0.008
0.453	0.098	0.126	0.008
0.472	0.110	0.126	0.012
0.492	0.114	0.130	0.016

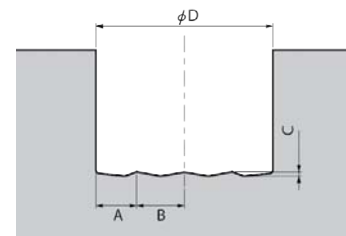

Holeshot Drills



Magic Drill DR

Drilling

- Drilling diameters from 0.688" to 4.000"
- Flute designs optimized for maximum rigidity and good chip evacuation
- WCMX inserts available in new MEGACOAT Grade PR1230

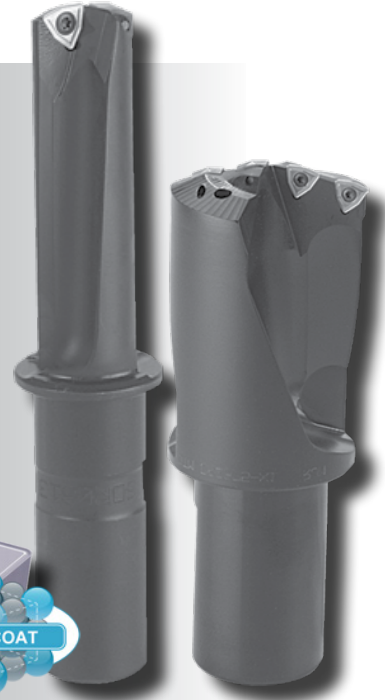

Patented Swept Back Design



- Enables drilling of stacked plates and welded assemblies
- Reduces slug formation
- Provides excellent chip control

● Holeshot Drill (DR) Inserts

Insert	Description	Dimension (inch)				Angle (°)	Insert Grade							Ref. Page for Toolholder		
		A	T	Ød	rε		α	Cermet		MEGACOAT	PVD Coated Carbide				Carbide	
								TN60	PVD Cermet		PR1230	PR660	PR830		PR905	PR915
	WCMX 040204-M1A	1/4	0.094	0.110	1/64	7°		●	●		●	●	●	●	●	Page 54-59
	050308-M1	5/16	1/8	0.125	1/32		●	●	●	●	●	●	●	●		
	050308-M1A	5/16	1/8	0.125	1/32		●	●	●	●	●	●	●	●		
	06T308-M1	3/8	5/32	0.146	1/32		●	●	●	●	●	●	●	●		
	06T308-M1A	3/8	5/32	0.146	1/32		●	●	●	●	●	●	●	●		

Insert Grade Features Page 2

● : Stock Standard
○ : World Express

● WCMX...M1 : General purpose drilling insert; First choice for Med-High Carbon Steel, Tool Steels, and Cast Iron; also available for General purpose drilling in Stainless Steel. Tougher edge than M1A chipbreaker.

● WCMX...M1A: First choice for Low-carbon Steel, Aluminum, and other "sticky" materials. Freer cutting than M1 chipbreaker.

Holeshoot Drills

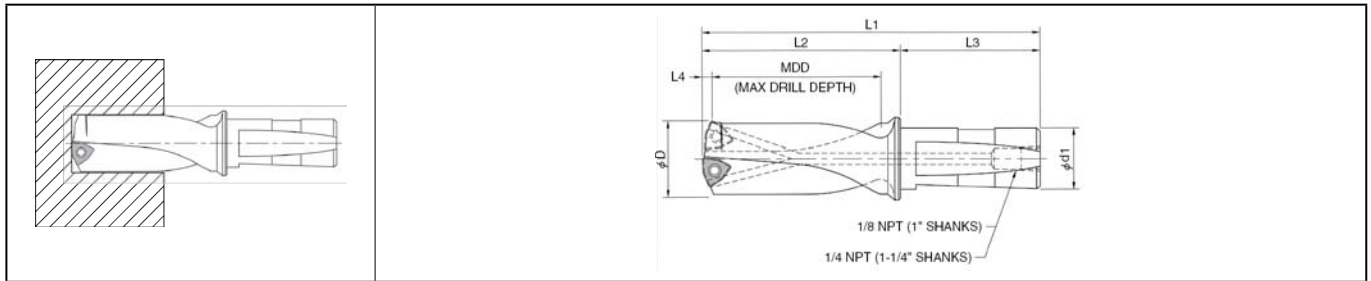

● Toolholder Dimensions

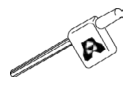
Description	Stock	No. of Insert	Dimension (inch)						Spare Parts		Applicable Inserts ● Page 53		
			ØD	Ød1	MDD	L1	L2	L3	L4	Clamp Screw 		Wrench 	
DR -0688-X3N	●	2	.688	.750	2.06	4.87	2.84	2.03	.090	SCR01	T7	WCMX 040204-M1A	
-0709-X3N	●		.709 (18mm)	.750	2.13	5.04	3.01						.092
-0719-X3N	●		.719	.750	2.15	5.00	2.97						.093
-0750-X3N	●		.750	.750	2.25	5.13	3.10						.102
-0781-X3N	●		.781	.750	2.34	5.26	3.23						.106
-0787-X3N	●		.787 (20mm)	.750	2.36	5.29	3.26						.106
-0813-X3N	●		.813	.750	2.44	5.39	3.36						.110
-0827-X3N	●		.827 (21mm)	.750	2.48	5.41	3.38						.112
-0844-X3N	●		.844	.750	2.53	5.52	3.49						.114
DR -0866-X3N	●	2	.866 (22mm)	1.000	2.60	5.80	3.52	2.28	.130	SCR03	T9	WCMX 050308-M1(A)	
-0875	●		.875	1.000	1.75	4.78	2.50						.131
-0875-X3N	●		.875	1.000	2.63	5.79	3.51						.131
-0906	●		.906 (23mm)	1.000	1.75	4.78	2.50						.135
-0906-X3N	●		.906 (23mm)	1.000	2.71	5.88	3.60						.135
-0937	●		.937	1.000	1.75	4.78	2.50						.139
-0937-X3N	●		.937	1.000	2.81	5.98	3.70						.139
-0945	●		.945 (24mm)	1.000	1.75	4.78	2.50						.140
-0945-X3N	●		.945	1.000	2.83	6.04	3.76						.140
-0969	●		.969	1.000	1.75	4.78	2.50						.143
DR -0969-X3N	●	2	.969	1.000	2.91	6.08	3.80	2.28	.143	SCR03	T9	WCMX 050308-M1(A)	
-0984	●		.984 (25mm)	1.000	1.75	4.78	2.50						.145
-0984-X3N	●		.984 (25mm)	1.000	2.95	6.17	3.89						.145
-1000	●		1.000	1.000	1.75	4.78	2.50						.147
-1000-X3N	●		1.000	1.000	3.00	6.18	3.90						.147
-1024	●		1.024 (26mm)	1.000	1.75	4.78	2.50						.150
-1024-X3N	●		1.024 (26mm)	1.000	3.07	6.29	4.01						.150
-1031	●		1.031	1.000	2.13	5.16	2.88						.151
-1031-X3N	●		1.031	1.000	3.09	6.27	3.99						.151
-1062	●		1.062 (27mm)	1.000	2.13	5.16	2.88						.155

Recommended Cutting Conditions ● Page 60



● : Stock Standard
○ : World Express

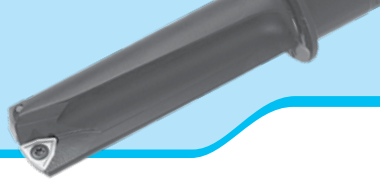

Holeshot Drill DR





● Toolholder Dimensions

Description	Stock	No. of Insert	Dimension (inch)						Spare Parts		Applicable Inserts ● Page 53		
			ØD	Ød1	MDD	L1	L2	L3	L4	Clamp Screw		Wrench	
													
DR -1062-X3N	●	2	1.062 (27mm)	1.000	3.18	6.37	4.09	2.28	.155	SCR03	T9	WCMX 050308-M1(A)	
-1094	●		1.094	1.000	2.13	5.16	2.88						.159
-1094-X3N	●		1.094	1.000	3.28	6.47	4.19						.159
-1102	●		1.102 (28mm)	1.000	2.13	5.16	2.88						.160
-1102-X3N	●		1.102 (28mm)	1.000	3.31	6.53	4.25						.160
-1125	●		1.125	1.000	2.13	5.16	2.88						.163
-1125-X3N	●		1.125	1.000	3.37	6.56	4.28						.163
-1142	●		1.142 (29mm)	1.000	2.13	5.16	2.88						.165
-1142-X3N	●		1.142 (29mm)	1.000	3.43	6.66	4.38						.165
-1156	●		1.156	1.000	2.13	5.16	2.88						.167
-1156-X3N	●		1.156	1.000	3.47	6.67	4.39						.167
DR -1181	●		2	1.181 (30mm)	1.000	2.13	5.16						2.88
-1181-X3N	●	1.181 (30mm)		1.000	3.54	6.78	4.50	.169					
-1187	●	1.187		1.000	2.13	5.16	2.88	.169					
-1187-X3N	●	1.187		1.250	3.56	6.76	4.48	.169					
-1219	●	1.219		1.000	2.50	5.53	3.25	.173					
-1219-X3N	●	1.219		1.250	3.66	6.86	4.58	.173					
-1250	●	1.250		1.000	2.50	5.53	3.25	.177					
-1250-X3N	●	1.250		1.250	3.75	6.96	4.68	.177					
-1260	●	1.260 (32mm)		1.000	2.50	5.53	3.25	.179					
-1260-X3N	●	1.260 (32mm)		1.250	3.78	7.03	4.75	.179					
DR -1281	●	2	1.281	1.000	2.50	5.53	3.25	2.28	.181	SCR30	T10	WCMX 06T308-M1(A)	
-1281-X3N	●		1.281	1.250	3.84	7.05	4.77						.181
-1299	●		1.299 (33mm)	1.000	2.50	5.53	3.25						.184
-1299-X3N	●		1.299 (33mm)	1.250	3.90	7.15	4.87						.184
-1312	●		1.312	1.000	2.50	5.53	3.25						.185
-1312-X3N	●		1.312	1.250	3.94	7.16	4.88						.185
-1339	●		1.339 (34mm)	1.000	2.50	5.53	3.25						.189
-1339-X3N	●		1.339 (34mm)	1.250	4.02	7.27	4.99						.189
-1344	●		1.344	1.000	2.50	5.53	3.25						.190
-1344-X3N	●		1.344	1.250	4.03	7.25	4.97						.190
-1375	●	1.375	1.000	2.50	5.53	3.25	.193						
DR -1375-X3N	●	2	1.375	1.250	4.12	7.34	5.06	2.28	.193	SCR30	T10	WCMX 06T308-M1(A)	
-1406	●		1.406	1.000	2.75	5.78	3.50						.197
-1406-X3N	●		1.406	1.250	4.22	7.45	5.17						.197
-1417	●		1.417 (36mm)	1.000	2.75	5.78	3.50						.199
-1417-X3N	●		1.417 (36mm)	1.250	4.25	7.52	5.24						.199
-1437	●		1.437	1.000	2.75	5.78	3.50						.196
-1437-X3N	●		1.437	1.250	4.31	7.54	5.26						.196
-1457	●		1.457 (37mm)	1.000	2.75	5.78	3.50						.199
-1457-X3N	●		1.457 (37mm)	1.250	4.37	7.64	5.36						.199
-1469	●		1.469	1.000	2.75	5.78	3.50						.200
-1469-X3N	●	1.469	1.250	4.40	7.63	5.35	.200						

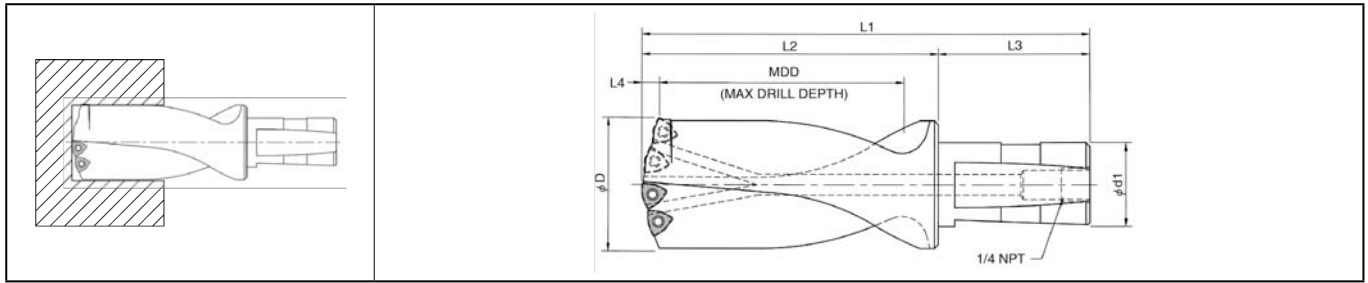
Holeshoot Drills



● Toolholder Dimensions



Description	Stock	No. of Insert	Dimension (inch)						Spare Parts		Applicable Inserts ● Page 53	
			ØD	Ød1	MDD	L1	L2	L3	L4	Clamp Screw 		Wrench 
DR -1496	●	2	1.496 (38mm)	1.000	2.75	5.78	3.50		.204	SCR30	T10	WCMX 06T308-M1(A)
-1496-X3N	●		1.496 (38mm)	1.250	4.49	7.76	5.48		.204			
-1500	●		1.500	1.000	2.75	5.78	3.50		.204			
-1500-X3N	●		1.500	1.250	4.50	7.73	5.45		.204			
-1531	●		1.531	1.250	2.88	6.16	3.88	2.28	.208			
-1531-X3N	●		1.531	1.250	4.59	8.08	5.80		.208			
-1535-X3N	●		1.535 (39mm)	1.250	4.61	8.08	5.80		.209			
-1562	●		1.562	1.250	2.88	6.16	3.88		.212			
-1562-X3N	●	1.562	1.250	4.68	8.17	5.89		.212				
DR -1575	●	3	1.575 (40mm)	1.250	2.88	6.16	3.88	2.28	.208	SCR03	T9	WCMX 050308-M1(A)
-1575-X3N	●		1.575 (40mm)	1.500	4.72	8.61	5.92	2.69	.208			
-1594	●		1.594	1.250	2.88	6.16	3.88	2.28	.210			
-1594-X3N	●		1.594	1.500	4.78	8.68	5.99	2.69	.210			
-1614	●		1.614 (41mm)	1.250	2.88	6.16	3.88	2.28	.212			
-1614-X3N	●		1.614 (41mm)	1.500	4.84	8.73	6.04	2.69	.212			
1625	●		1.625	1.250	2.88	6.16	3.88	2.28	.214			
1625-X3N	●		1.625	1.500	4.87	8.77	6.08	2.69	.214			
-1656	●		1.656	1.250	2.88	6.16	3.88	2.28	.218			
-1656-X3N	●		1.656	1.500	4.96	8.87	6.18	2.69	.218			
-1687	●		1.687	1.250	2.88	6.16	3.88	2.28	.221			
-1687-X3N	●		1.687	1.500	5.06	8.97	6.28	2.69	.221			
-1693	●		1.693 (43mm)	1.250	2.88	6.16	3.88	2.28	.222			
-1693-X3N	●		1.693 (43mm)	1.500	5.08	8.97	6.28	2.69	.222			
-1719	●		1.719	1.250	3.00	6.41	4.13	2.28	.225			
-1719-X3N	●		1.719	1.500	5.15	9.20	6.51	2.69	.225			
-1732	●	1.732 (44mm)	1.250	3.00	6.41	4.13	2.28	.224				
DR -1732-X3N	●	1.732 (44mm)	1.500	5.20	9.29	6.60	2.69	.224				
-1750	●	1.750	1.250	3.00	6.41	4.13	2.28	.225				
-1750-X3N	●	1.750	1.500	5.25	9.30	6.61	2.69	.225				
-1772	●	1.772 (45mm)	1.250	3.00	6.41	4.13	2.28	.231				
-1772-3XN	●	1.772 (45mm)	1.500	5.31	9.42	6.73	2.69	.231				
-1781	●	1.781	1.250	3.00	6.41	4.13	2.28	.223				
-1781-X3N	●	1.781	1.500	5.34	9.38	6.69	2.69	.223				
-1812	●	1.812	1.250	3.00	6.41	4.13	2.28	.230				
-1812-X3N	●	1.812	1.500	5.43	9.48	6.79	2.69	.230				
-1844	●	1.844	1.250	3.38	6.78	4.50	2.28	.233				
-1844-X3N	●	1.844	1.500	5.53	9.58	6.89	2.69	.233				
-1850	●	1.850 (47mm)	1.250	3.38	6.78	4.50	2.28	.233				
-1850-X3N	●	1.850 (47mm)	1.500	5.55	9.66	6.97	2.69	.233				

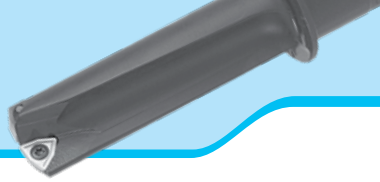

Holeshot Drill DR



● Toolholder Dimensions

Description	Stock	No. of Insert	Dimension (inch)							Spare Parts		Applicable Inserts ● Page 53
			ØD	Ød1	MDD	L1	L2	L3	L4	Clamp Screw	Wrench	
												
DR -1875	●	4	1.875	1.250	3.38	6.78	4.50	2.28	.240	SCR03	T9	WCMX 050308-M1(A)
-1875-X3N	●		1.875	1.500	5.62	9.68	6.99	2.69	.240			
-1906	●		1.906	1.250	3.38	6.78	4.50	2.28	.254			
-1906-X3N	●		1.906	1.500	5.72	9.79	7.10	2.69	.254			
-1929	●		1.929 (49mm)	1.250	3.38	6.78	4.50	2.28	.259			
-1929-X3N	●		1.929 (49mm)	1.500	5.79	9.92	7.23	2.69	.259			
-1937	●		1.937	1.250	3.38	6.78	4.50	2.28	.259			
-1937-X3N	●		1.937	1.500	5.81	9.89	7.20	2.69	.259			
-1969	●		1.969 (50mm)	1.250	3.38	6.78	4.50	2.28	.260			
-1969-X3N	●		1.969 (50mm)	1.500	5.91	9.99	7.30	2.69	.260			
-2000-X1	●		2.000	1.250	2.13	6.06	3.38	2.28	.267			
-2000	●		2.000	1.250	3.38	6.78	4.50	2.28	.267			
-2000-X3N	●		2.000	1.500	6.00	10.09	7.40	2.69	.267			
-2008	●		2.008 (51mm)	1.250	3.38	6.78	4.50	2.28	.267			
-2008-X3N	●		2.008 (51mm)	1.500	6.02	10.16	7.47	2.69	.267			
-2031-X1	●		2.031	1.500	2.13	6.06	3.38	2.69	.268			
-2031	●	2.031	1.500	3.50	7.44	4.75	2.69	.268				
-2031-X3N	●	2.031	1.500	6.09	10.30	7.61	2.69	.268				
DR -2047	●	4	2.047 (52mm)	1.500	3.50	7.44	4.75	2.69	.259	SCR30	T10	WCMX 06T308-M1(A)
-2047-X3N	●		2.047 (52mm)	2.000	6.14	10.91	7.66	3.25	.259			
-2062-X1	●		2.062	1.500	2.13	6.06	3.38	2.69	.260			
-2062	●		2.062	1.500	3.50	7.44	4.75	2.69	.260			
-2062-X3N	●		2.062	2.000	6.18	10.94	7.69	3.25	.260			
-2094-X1	●		2.094	1.500	2.13	6.06	3.38	2.69	.267			
-2094	●		2.094	1.500	3.50	7.44	4.75	2.69	.267			
-2094-X3N	●		2.094	2.000	6.28	11.05	7.80	3.25	.267			
-2125-X1	●		2.125 (54mm)	1.500	2.13	6.06	3.38	2.69	.266			
-2125	●		2.125 (54mm)	1.500	3.50	7.44	4.75	2.69	.266			
-2125-X3N	●		2.125	2.000	6.37	11.14	7.89	3.25	.266			
-2156-X1	●		2.156	1.500	2.31	6.25	3.56	2.69	.270			
-2156	●		2.156	1.500	3.88	7.81	5.13	2.69	.270			
-2156-X3N	●		2.156	2.000	6.47	11.24	7.99	3.25	.270			
-2165-X3N	●		2.165 (55mm)	2.000	6.50	11.28	8.03	3.25	.273			
-2187-X1	●		2.187	1.500	2.31	6.25	3.56	2.69	.273			
-2187	●	2.187	1.500	3.88	7.81	5.13	2.69	.273				

Recommended Cutting Conditions ● Page 60



● : Stock Standard
○ : World Express



Magic Drill DR

Drilling

■ Holeshot Drills

Description	Stock	No. of Insert	Dimension (inch)							Spare Parts		Applicable Inserts ● Page 53
			ØD	Ød1	MDD	L1	L2	L3	L4	Clamp Screw	Wrench	
												
DR -2187-X3N	●	4	2.187	2.000	6.56	11.33	8.08	3.25	.273	SCR30	T10	WCMX 06T308-M1(A)
-2205	●		2.205 (56mm)	1.500	3.88	7.81	5.13	2.69	.283			
-2205-X3N	●		2.205 (56mm)	2.000	6.61	11.41	8.16	3.25	.283			
-2219-X1	●		2.219	1.500	2.31	6.25	3.56	2.69	.277			
-2219	●		2.219	1.500	3.88	7.81	5.13	2.69	.277			
-2219-X3N	●		2.219	2.000	6.66	11.44	8.19	3.25	.277			
-2244	●		2.244 (57mm)	1.500	3.88	7.81	5.13	2.69	.281			
-2244-X3N	●		2.244 (57mm)	2.000	6.73	11.52	8.27	3.25	.281			
-2250-X1	●		2.250	1.500	2.31	6.25	3.56	2.69	.281			
-2250	●		2.250	1.500	3.88	7.81	5.13	2.69	.281			
DR -2250-X3N	●	4	2.250	2.000	6.75	11.53	8.28	3.25	.281	SCR30	T10	
-2281-X1	●		2.281	1.500	2.31	6.25	3.56	2.69	.283			
-2281	●		2.281	1.500	3.88	7.81	5.13	2.69	.283			
-2281-X3N	●		2.281	2.000	6.84	11.62	8.37	3.25	.283			
-2312-X1	●		2.312	1.500	2.31	6.25	3.56	2.69	.287			
-2312	●		2.312	1.500	3.88	7.81	5.13	2.69	.287			
-2312-X3N	●		2.312	2.000	6.93	11.72	8.47	3.25	.287			
-2323	●		2.323 (59mm)	1.500	3.88	7.81	5.13	2.69	.290			
-2344-X1	●		2.344	1.500	2.50	6.56	3.88	2.69	.289			
DR -2344	●		4	2.344	1.500	4.13	8.19	5.50	2.69			
-2344-X3N	●	2.344		2.000	7.03	11.95	8.70	3.25	.289			
-2362	●	2.362 (60mm)		1.500	4.13	8.19	5.50	2.69	.301			
-2362-X3N	●	2.362 (60mm)		2.000	7.09	12.02	8.77	3.25	.301			
-2375-X1	●	2.375		1.500	2.50	6.56	3.88	2.69	.298			
-2375	●	2.375		1.500	4.13	8.19	5.50	2.69	.298			
-2375-X3N	●	2.375		2.000	7.12	12.05	8.80	3.25	.298			
-2406-X1	●	2.406		1.500	2.50	6.56	3.88	2.69	.304			
-2406	●	2.406		1.500	4.13	8.19	5.50	2.69	.304			
-2406-X3N	●	2.406		2.000	7.22	12.15	8.90	3.25	.304			
DR -2437-X1	●	4	2.437	1.500	2.50	6.56	3.88	2.69	.309	SCR30	T10	
-2437	●		2.437	1.500	4.13	8.19	5.50	2.69	.309			
-2437-X3N	●		2.437	2.000	7.31	12.25	9.00	3.25	.309			
-2441	●		2.441 (62mm)	1.500	4.13	8.19	5.50	2.69	.309			
-2441-X3N	●		2.441 (62mm)	2.000	7.32	12.26	9.01	3.25	.309			
-2469-X1	●		2.469	1.500	2.50	6.56	3.88	2.69	.319			
-2469	●		2.469	1.500	4.13	8.19	5.50	2.69	.319			
-2469-X3N	●		2.469	2.000	7.41	12.36	9.11	3.25	.319			

Recommended Cutting Conditions ● Page 60

● : Stock Standard
○ : World Express





Magic Drill DR

Drilling

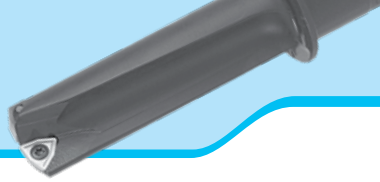
Holeshot Drill DR



■ Holeshot Drills

Description	Stock	No. of Insert	Dimension (inch)							Spare Parts		Applicable Inserts ● Page 53
			ØD	Ød1	MDD	L1	L2	L3	L4	Clamp Screw	Wrench	
												
DR -2480	●	4	2.480 (63mm)	1.500	4.13	8.19	5.50	2.69	.310	SCR30	T10	
-2480-X3N	●		2.480 (63mm)	2.000	7.44	12.38	9.13	3.25	.310			
-2500-X1	●		2.500	1.500	2.50	6.56	3.88	2.69	.329			
-2500	●		2.500	1.500	4.13	8.19	5.50	2.69	.329			
-2500-X3N	●		2.500	2.000	7.50	12.46	9.21		.329			
-2625-X1	●		2.625	2.000	2.75	7.50	4.25		.326			
-2625	●		2.625	2.000	6.50	11.25	8.00		.326			
-2750-X1	●		2.750	2.000	2.75	7.50	4.25	3.25	.340			
-2750	●		2.750	2.000	6.50	11.25	8.00		.340			
-2875-X1	●		2.875	2.000	3.00	7.75	4.50		.357			
-2875	●		2.875	2.000	6.50	11.25	8.00		.357			
DR -3000-X1	●		6	3.000	2.000	3.00	7.75	4.50				
-3000	●	3.000		2.000	6.50	11.25	8.00		.369			
-3125-X1	●	3.125		2.000	3.25	8.13	4.88		.393			
-3125	●	3.125		2.000	7.63	12.50	9.25		.393			
-3250-X1	●	3.250		2.000	3.25	8.13	4.88	3.25	.387			
-3250	●	3.250		2.000	7.63	12.50	9.25		.387			
-3375-X1	●	3.375		2.000	3.50	8.38	5.13		.393			
-3375	●	3.375		2.000	7.63	12.50	9.25		.393			
-3500-X1	●	3.500		2.000	3.50	8.38	5.13		.440			
DR -3500	●	6		3.500	2.000	7.63	12.50	9.25		.440	SCR30	T10
-3625-X1	●		3.625	2.000	3.75	8.75	5.50		.441			
-3625	●		3.625	2.000	7.94	12.67	9.42		.441			
-3750-X1	●		3.750	2.000	3.75	8.75	5.50		.459			
-3750	●		3.750	2.000	8.00	13.00	9.75	3.25	.459			
-3875-X1	●		3.875	2.000	4.00	9.38	6.13		.470			
-3875	●		3.875	2.000	8.44	13.44	10.19		.470			
-4000-X1	●		4.000	2.000	4.00	9.38	6.13		.482			
-4000	●		4.000	2.000	8.56	13.88	10.63		.482			

Recommended Cutting Conditions ● Page 60

● : Stock Standard
○ : World Express



Magic Drill DR

Drilling

Recommended Cutting Conditions : Holeshot Drill (DR)

Workpiece Material	Feed Rate (ipr)	Recommended Cutting Condition (Cutting Speed SFM)							Remarks
		Cermet	PVD Coated				MEGACOAT	Carbide	
		TN60	PR660	PR830	PR905	PR915	PR1230	KW10	
Low Carbon Steel	.0015-.0035	-	☆ 800~900	☆ 800~900	-	-	★ 800~900	-	Coolant
Carbon Steel	.005-.009	-	☆ 400~800	☆ 400~800	-	-	★ 400~800	-	
Alloy Steel	.004-.010	-	☆ 250~750	☆ 250~750	-	-	★ 250~750	-	
Tool Steel	.004-.010	-	☆ 250~750	☆ 250~750	-	-	★ 250~750	-	
Stainless Steel (Austenitic)	.0025-.006	-	☆ 200~600	☆ 200~600	-	-	★ 200~600	-	
Gray Cast Iron	.005-.011	-	-	-	★ 400~800	-	-	☆ 400~800	
Nodular Cast Iron (Ductile)	.004-.010	-	-	-	★ 300~500	-	-	☆ 300~500	
Non-ferrous Metal	.008-.010	☆ 1800~2000	-	-	-	-	-	★ 1800~2000	
Heat Resistant Alloy (Inconel 718)	.0010-.0015	-	-	☆ 75~150	-	☆ 100~150	★ 75~150	-	
Titanium Alloy	.0025-.0030	-	-	-	★ 100~210	★ 100~210	-	☆ 150~250	

★ : 1st Recommendation ☆ : 2nd Recommendation



Magic Drill DR

Drilling

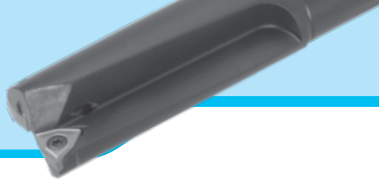

Coremaster Coredrills



Coremaster
Coredrill

Drilling

- Fast effective way to expand pre-existing holes
- Two effective flutes allow high feed rates for improved productivity
- WCMX inserts available in new MEGACOAT Grade PR1230
- Deeper drilling depths available in the XL Series



Coremaster Coredrill
Available in Both
FIXED POCKET
and
ADJUSTABLE CARTRIDGE

Adjustable cartridges can be adjusted 0.075" per side, providing 0.150" adjustment capability on diameter



● Coremaster Coredrill Inserts

Insert	Description	Dimension (inch)				Angle (°)	Insert Grade							Ref. Page for Toolholder	
		A	T	Ød	rε		1	Cermet		MEGACOAT	PVD Coated Carbide				Carbide
								TN60	PV90		PR1230	PR660	PR830		
	WCMX 050308-M1	5/16	1/8	0.125	1/32	7°	●	●	●	●	●	●	●	●	Page 62-63
	050308-M1A	5/16	1/8	0.125	1/32		●	●	●	●	●	●	●	●	
	06T308-M1	3/8	5/32	0.146	1/32		●	●	●	●	●	●	●	●	
	06T308-M1A	3/8	5/32	0.146	1/32		●	●	●	●	●	●	●	●	

Insert Grade Features Page 2



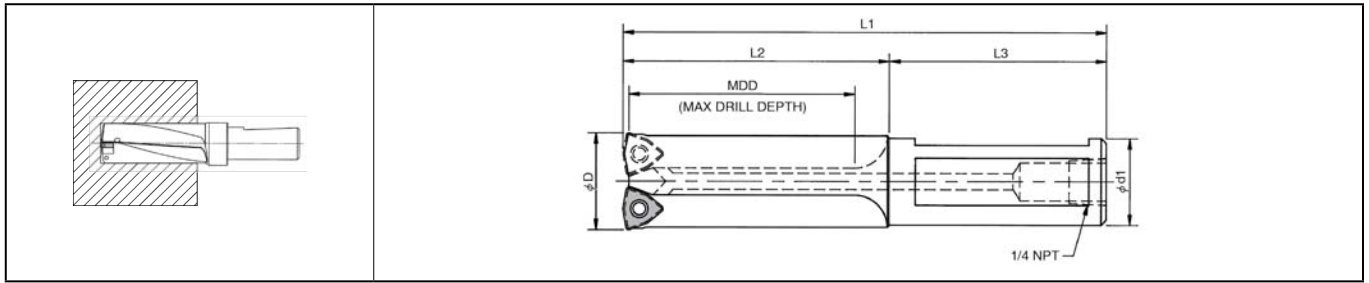

● : Stock Standard
○ : World Express

- WCMX...M1 : General purpose drilling insert; First choice for Med-High Carbon Steel, Tool Steels, and Cast Iron; also available for General purpose drilling in Stainless Steel. Tougher edge than M1A chipbreaker.
- WCMX...M1A: First choice for Low-carbon Steel, Aluminum, and other "sticky" materials. Freer cutting than M1 chipbreaker.

Coremaster Coredrills - Fixed Pocket

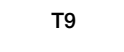

Toolholder Dimensions

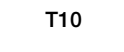
Description	Stock	No. of Insert	Dimension (inch)						Spare Parts		Applicable Inserts ● Page 61	
			ØD	Ød1	Ød2	MDD	L1	L2	L3	Clamp Screw 		Wrench 
CD -0825	●	2	0.825	1.000	-	1.750	4.750	2.250	2.500	SCR03 	T9 	WCMX 050308-M1(A)
-0865	●		0.865									
-0938	●		0.938									
-0990	●		0.990									
-1052	●		1.052									
-1115	●		1.115									
-1178	●		1.178									
-1240	●		1.240									
-1303	●	1.303	1.000	-	2.500	5.500	3.000	2.500	SCR30 	T10 	WCMX 06T308-M1(A)	







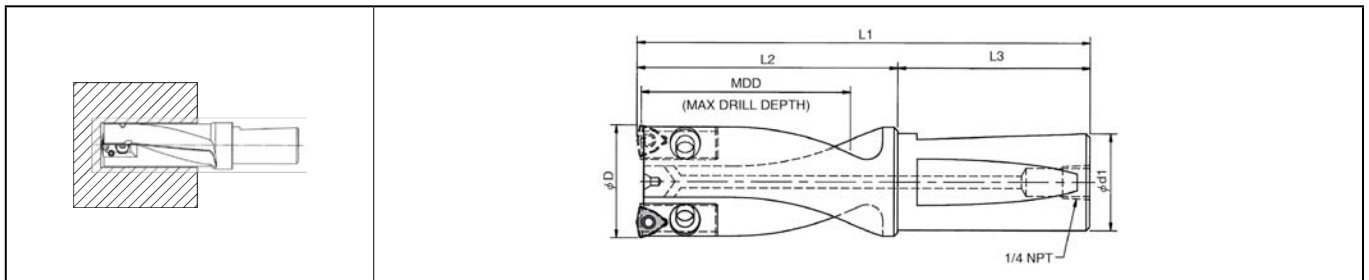







*Maximum material removal: WCMX 050308 – 5/16" per side, WCMX 06T308 – 3/8" per side.

Recommended Cutting Conditions ● Page 64

Coremaster Coredrills - Adjustable Cartridge



Toolholder Dimensions

Description	Stock	No. of Insert	Dimension (inch)						Spare Parts				Applicable Inserts ● Page 61
			ØD	Ød1	Ød2	MDD	L1	L2	L3	Clamp Screw 	Wrench 	Cartridge 	
CD -1360-C	●	2	1.36-1.46	1.250	-	2.750	6.250	3.500	2.750	SCR30 	T10 	02-03 	WCMX 06T308-M1(A)
-1460-C	●		1.46-1.56										
-1560-C	●		1.56-1.66										
-1660-C	●		1.66-1.76										
-1760-C	●		1.76-1.86	1.500	-	3.125	7.000	4.000	3.000	SCR30 	T10 	02-03 	01-01 
-1860-C	●		1.86-1.96										
-1960-C	●		1.96-2.06										
-2060-C	●		2.06-2.16										
-2160-C	●		2.16-2.26										
-2260-C	●		2.26-2.36										
-2360-C	●		2.36-2.46										
-2460-C	●		2.46-2.56										
-2560-C	●		2.56-2.66	-	-	-	-	-	-	SCR30 	T10 	02-03 	01-02 
-2660-C	●		2.66-2.76										
-2760-C	●		2.76-2.86										
-2860-C	●		2.86-2.96										
-2960-C	●		2.96-3.06										

Recommended Cutting Conditions ● Page 64

● : Stock Standard
○ : World Express



Coremaster
Coredrill

Drilling

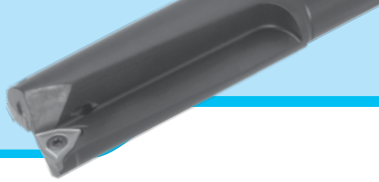

Coremaster Coredrill

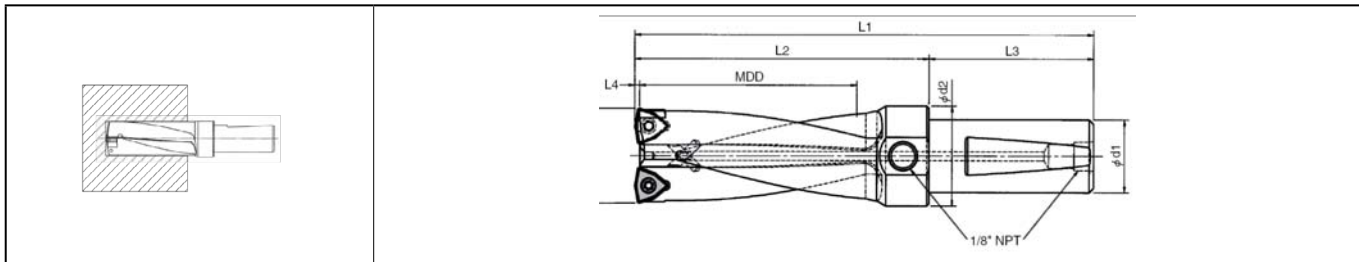

Coremaster Coredrills XL - Extended Length Fixed Pocket



Toolholder Dimensions

Description	Stock	No. of Insert	Dimension (inch)						Spare Parts		Applicable Inserts ● Page 61	
			ØD	Ød1	Ød2	MDD	L1	L2	L3	Clamp Screw		Wrench
												
CD -0825-XL	●	2	0.825	1.000	1.375	2.250	5.530	3.250	2.280	SCR03	T9	WCMX 050308-M1(A)
-0865-XL	●		0.865	1.000	1.375	2.250	5.530	3.250	2.280			
-0938-XL	●		0.938	1.000	1.375	2.500	5.780	3.500	2.280			
-0990-XL	●		0.990	1.000	1.375	2.500	5.780	3.500	2.280			
-1052-XL	●		1.052	1.000	1.375	2.500	5.780	3.500	2.280	SCR30	T10	WCMX 06T308-M1(A)
-1115-XL	●		1.115	1.000	1.375	3.000	6.280	4.000	2.280			
-1178-XL	●		1.178	1.000	1.375	3.000	6.280	4.000	2.280			
-1240-XL	●		1.240	1.000	1.375	3.000	6.280	4.000	2.280			
-1303-XL	●	1.303	1.000	1.375	3.000	6.280	4.000	2.280				



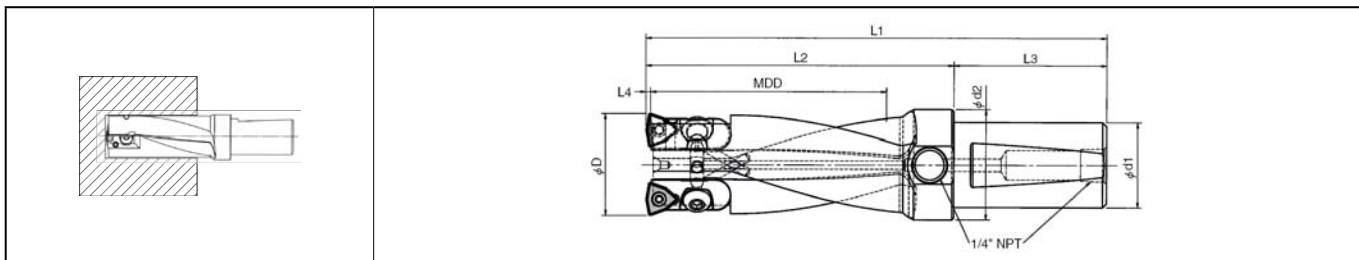

*Maximum material removal: WCMX 050308 – 5/16" per side, WCMX 06T308 – 3/8" per side.

Recommended Cutting Conditions ● Page 64

Coremaster Coredrills - Extended Length Adjustment Cartridge



Toolholder Dimensions

Description	Stock	No. of Insert	Dimension (inch)						Spare Parts				Applicable Inserts ● Page 61	
			ØD	Ød1	Ød2	MDD	L1	L2	L3	Clamp Screw	Wrench	Cartridge		Cartridge Screw
														
CD -1350-LC	●	2	1.35-1.50	1.250	1.63	3.500	6.780	4.500	2.280	SCR30	T10	02-03	01-01	WCMX 06T308-M1(A)
-1500-LC	●		1.50-1.65	1.250	1.63	3.500	6.780	4.500	2.280					
-1650-LC	●		1.65-1.80	1.500	1.88	4.500	8.190	5.500	2.690					
-1800-LC	●		1.80-1.95	1.500	1.88	4.500	8.190	5.500	2.690					
-1950-LC	●		1.95-2.10	1.500	N/A	4.500	8.190	5.500	2.690					
-2100-LC	●		2.10-2.25	1.500	N/A	4.500	8.190	5.500	2.690					
-2250-LC	●		2.25-2.40	2.000	2.38	5.500	9.750	6.500	3.250				01-02	
-2400-LC	●		2.40-2.55	2.000	N/A	5.500	9.750	6.500	3.250					
-2550-LC	●		2.55-2.70	2.000	N/A	5.500	9.750	6.500	3.250					
-2700-LC	●		2.70-2.85	2.000	N/A	6.000	10.250	7.000	3.250					
-2850-LC	●		2.85-3.00	2.000	N/A	6.000	10.250	7.000	3.250					
-3000-LC	●		3.00-3.15	2.000	N/A	6.000	10.250	7.000	3.250					

*Maximum material removal: WCMX 050308 – 5/16" per side, WCMX 06T308 – 3/8" per side.
Cartridges can be adjusted 0.075" per side, providing 0.150" adjustment capability on diameter.

● : Stock Standard
○ : World Express

Recommended Cutting Conditions ● Page 64



Recommended Cutting Conditions : Coremaster Coredrill (CD)

Workpiece Material	Feed Rate (ipr)	Recommended Cutting Condition (Cutting Speed SFM)							Remarks
		Cermet	PVD Coated				MEGACOAT	Carbide	
		TN60	PR660	PR830	PR905	PR915	PR1230	KW10	
Low Carbon Steel	.0015-.0035	-	☆ 800~900	☆ 800~900	-	-	★ 800~900	-	Coolant
Carbon Steel	.005-.009	-	☆ 400~800	☆ 400~800	-	-	★ 400~800	-	
Alloy Steel	.004-.010	-	☆ 250~750	☆ 250~750	-	-	★ 250~750	-	
Tool Steel	.004-.010	-	☆ 250~750	☆ 250~750	-	-	★ 250~750	-	
Stainless Steel (Austenitic)	.0025-.006	-	☆ 200~600	☆ 200~600	-	-	★ 200~600	-	
Gray Cast Iron	.005-.011	-	-	-	★ 400~800	-	-	☆ 400~800	
Nodular Cast Iron (Ductile)	.004-.010	-	-	-	★ 300~500	-	-	☆ 300~500	
Non-ferrous Metal	.008-.010	☆ 1800~2000	-	-	-	-	-	★ 1800~2000	
Heat Resistant Alloy (Inconel 718)	.0010-.0015	-	-	☆ 75~150	-	☆ 100~150	★ 75~150	-	
Titanium Alloy	.0025-.0030	-	-	-	★ 100~210	★ 100~210	-	☆ 150~250	

★ : 1st Recommendation ☆ : 2nd Recommendation



Coremaster
Coredrill

Drilling

Stinger Drills



Stinger Drills

Drilling

- Economical Alternative to the Magic Drill
- Perfect for Job Shop or Small Quantity Production
- Ideal for Low Horsepower Machines
- Cermet and Coated Carbide Inserts Available



● Stinger Drilling Inserts

Insert	Description	Dimension (inch)				Angle (°)		Insert Grade						Ref. Page for Toolholder
		A	T	Ød	rε	α	Cermet		CVD Coated Carbide		PVD Coated Carbide			
							TN60	PV90	CR9025	CA2325	PR660	PR830	KW10	
	TCMT 12122HP	5/32	1/16	0.087	1/32	7°	●	●		●	●	●		Page 66
	18152HP	7/32	3/32	0.094	1/32	7°	●	●		●	●	●		

Insert Grade Features [Page 2](#)

● : Stock Standard
○ : World Express

SDR

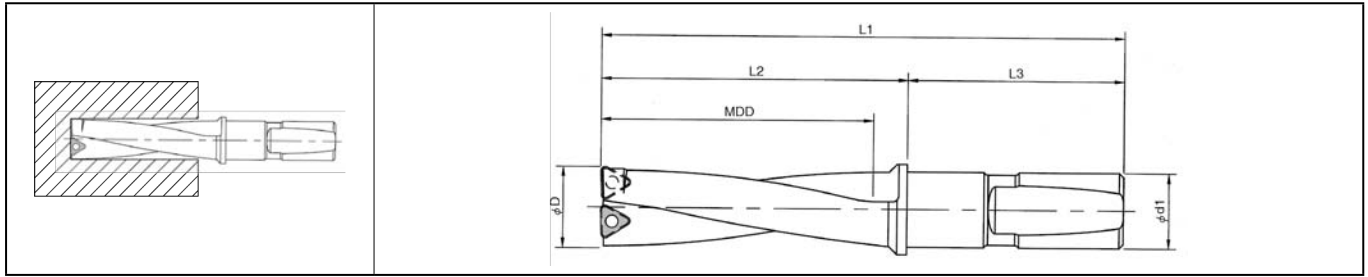

● Toolholder Dimensions

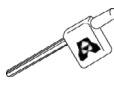
Description	Stock	No. of Insert	Dimension (inch)					Spare Parts		Applicable Inserts ● Page 65	
			ØD	Ød1	MDD	L1	L2	L3	Clamp Screw		Wrench
											
SDR -0484	●	2	0.484	0.500	1.45	3.45	1.95	1.50	SCR07	T6	TCMT 121122
-0492	●		0.492 (12.5mm)								
-0500	●		0.500								
-0512	●		0.512 (13mm)								
-0516	●		0.516								
-0531	●		0.531								
-0547	●		0.547								
-0551	●		0.551 (14mm)	0.500	1.63	3.63	2.13	1.50			
-0563	●		0.563								
-0578	●		0.578								
-0591	●		0.591 (15mm)								
-0594	●		0.594								
-0609	●		0.609								
-0625	●		0.625								
-0630	●	0.630 (16mm)	0.500	1.80	3.80	2.30	1.50				
SDR -0641	●	0.641									
-0656	●	0.656									
-0669	●	0.669 (17mm)									
-0672	●	0.672									
-0688	●	0.688									
-0703	●	0.703									
-0709	●	0.709 (18mm)	0.625	2.16	4.41	2.66	1.75				
SDR -0719	●	0.719									
-0734	●	0.734									
-0748	●	0.748 (19mm)									
-0750	●	0.750									
-0766	●	0.766									
-0781	●	0.781									
-0787	●	0.787 (20mm)	0.625	2.25	4.63	2.75	1.88				
-0797	●	0.797									
-0813	●	0.813									
-0828	●	0.828									
-0844	●	0.844	0.750	2.50	5.03	3.00	2.03	SCR-05	T7	TCMT 18152	
	●	0.750	2.66	5.19	3.16	2.03					
	●	0.844									

Recommended Cutting Conditions ● Page 97

● : Stock Standard
○ : World Express



Fine Micro Drills



Fine Micro Drills

Advantages

1. Kyocera's precise grinding technology produces high quality cutting edge with minimized variability
2. A tougher ultra-micro grain carbide substrate improved cutting edge stability and anti-breakage performance
3. Ultra-thin high performance coating layer (FS Coating) enables high efficient and long lasting drilling application.

"FS coating", FS stands for Fine Surface; it is Kyocera's unique coating technology which shows great performance in sharpness and chip flow due to its excellent smooth surface with low friction coefficient and superior wear resistance

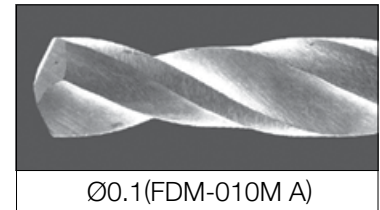
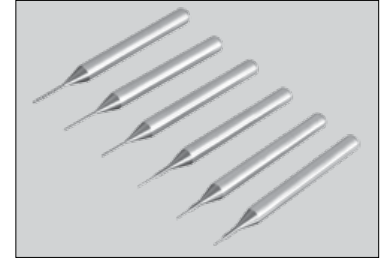

Machining Quality

	Cutting edge condition		Edge burr condition		Cutting conditions Work piece material: SUS304 (t=0.5mm) Drilling diameter: 0.3mm FDM030 (FSA) Cutting speed : Vc=10m/min n=10,600min ⁻¹ Feed Rate: f =0.001mm/rev Coolant Drilling Depth: 0.5mm Step Depth: 0.025mm No. of Holes: 200
	Fine Micro Drill	Competitor A (coated product)	Fine Micro Drill	Competitor A (coated product)	
Post-machining condition	Wear	Fracture Wear	Small Burrs	Large Burrs	

Cutting edge quality comparison

Web thickness variation comparison

(Drilling diameter ϕ 0.3)

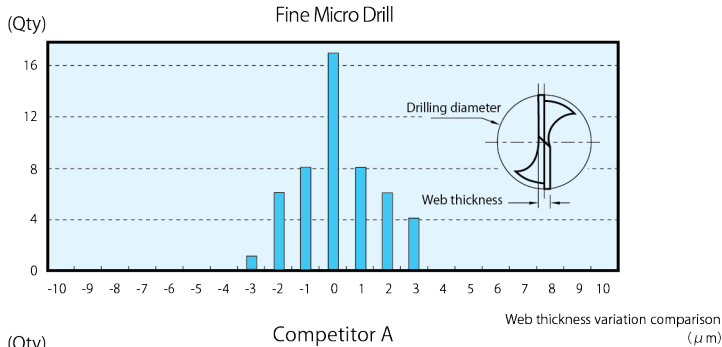

Center height variation comparison

(Drilling diameter ϕ 0.3)

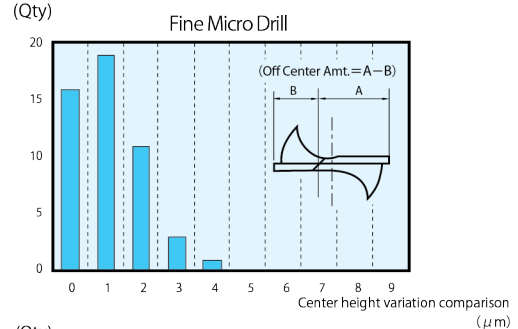

FDM-M (ShankØ3, Coated Product)

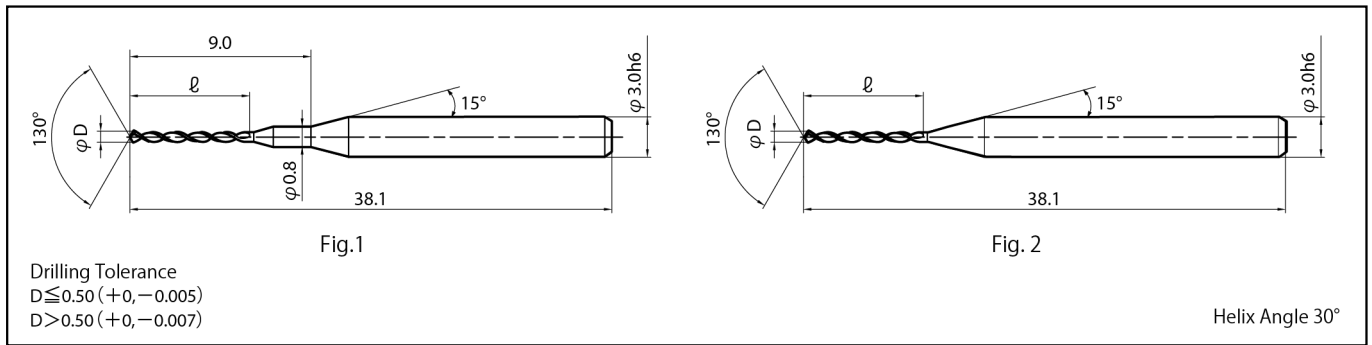

Description	Dimension (mm)		Fig.	Stock
	Drill Dia.	Cutting Edge Length		Coating
	D	ℓ		FSA
FDM-010M(1)	0.10	1.3	Fig.1	○
FDM-011M(1)	0.11			
FDM-012M(1)	0.12	1.5		
FDM-013M(1)	0.13			
FDM-014M(1)	0.14	1.7		
FDM-015M(1)	0.15			
FDM-016M(1)	0.16	1.9		
FDM-017M(1)	0.17			
FDM-018M(1)	0.18	2.2		
FDM-019M(1)	0.19			
FDM-020M(1)	0.20	2.4		
FDM-021M(1)	0.21			
FDM-022M(1)	0.22	2.7		
FDM-023M(1)	0.23			
FDM-024M(1)	0.24	2.9		
FDM-025M(1)	0.25			
FDM-026M(1)	0.26	3.1		
FDM-027M(1)	0.27			
FDM-028M(1)	0.28	3.3		
FDM-029M(1)	0.29			
FDM-030M(1)	0.30	5.0		
FDM-031M(1)	0.31			

Description	Dimension (mm)		Fig.	Stock
	Drill Dia.	Cutting Edge Length		Coating
	D	ℓ		FSA
FDM-032M(1)	0.32	5.0	Fig.1	○
FDM-033M(1)	0.33			
FDM-034M(1)	0.34			
FDM-035M(1)	0.35	6.0		
FDM-036M(1)	0.36			
FDM-037M(1)	0.37			
FDM-038M(1)	0.38	6.0		
FDM-039M(1)	0.39			
FDM-040M(1)	0.40		7.0	
FDM-041M(1)	0.41			
FDM-042M(1)	0.42			
FDM-043M(1)	0.43			
FDM-044M(1)	0.44			
FDM-045M(1)	0.45			
FDM-046M(1)	0.46			
FDM-047M(1)	0.47			
FDM-048M(1)	0.48			
FDM-049M(1)	0.49			
FDM-050M(1)	0.50	8.0		
FDM-060M(1)	0.60			
FDM-070M(1)	0.70			
FDM-080M(1)	0.80			
FDM-090M(1)	0.90			
FDM-100M(1)	1.00			
FDM-110M(1)	1.10			
FDM-120M(1)	1.20			
FDM-130M(1)	1.30			
FDM-140M(1)	1.40			
FDM-150M(1)	1.50			
FDM-160M(1)	1.60			
FDM-170M(1)	1.70			
FDM-180M(1)	1.80			
FDM-190M(1)	1.90			
FDM-200M(1)	2.00			
FDM-210M(1)	2.10			
FDM-220M(1)	2.20			
FDM-230M(1)	2.30			
FDM-240M(1)	2.40			
FDM-250M(1)	2.50			
FDM-260M(1)	2.60			
FDM-270M(1)	2.70			
FDM-280M(1)	2.80			
FDM-290M(1)	2.90			
FDM-300M(1)	3.00			
FDM-310M(1)	3.10			
FDM-320M(1)	3.20			
FDM-330M(1)	3.30			
FDM-340M(1)	3.40			
FDM-350M(1)	3.50			
FDM-360M(1)	3.60			
FDM-370M(1)	3.70			
FDM-380M(1)	3.80			
FDM-390M(1)	3.90			
FDM-400M(1)	4.00			
FDM-410M(1)	4.10			
FDM-420M(1)	4.20			
FDM-430M(1)	4.30			
FDM-440M(1)	4.40			
FDM-450M(1)	4.50			
FDM-460M(1)	4.60			
FDM-470M(1)	4.70			
FDM-480M(1)	4.80			
FDM-490M(1)	4.90			
FDM-500M(1)	5.00			
FDM-510M(1)	5.10			
FDM-520M(1)	5.20			
FDM-530M(1)	5.30			
FDM-540M(1)	5.40			
FDM-550M(1)	5.50			
FDM-560M(1)	5.60			
FDM-570M(1)	5.70			
FDM-580M(1)	5.80			
FDM-590M(1)	5.90			
FDM-600M(1)	6.00			
FDM-610M(1)	6.10			
FDM-620M(1)	6.20			
FDM-630M(1)	6.30			
FDM-640M(1)	6.40			
FDM-650M(1)	6.50			
FDM-660M(1)	6.60			
FDM-670M(1)	6.70			
FDM-680M(1)	6.80			
FDM-690M(1)	6.90			
FDM-700M(1)	7.00			
FDM-710M(1)	7.10			
FDM-720M(1)	7.20			
FDM-730M(1)	7.30			
FDM-740M(1)	7.40			
FDM-750M(1)	7.50			
FDM-760M(1)	7.60			
FDM-770M(1)	7.70			
FDM-780M(1)	7.80			
FDM-790M(1)	7.90			
FDM-800M(1)	8.00			
FDM-810M(1)	8.10			
FDM-820M(1)	8.20			
FDM-830M(1)	8.30			
FDM-840M(1)	8.40			
FDM-850M(1)	8.50			
FDM-860M(1)	8.60			
FDM-870M(1)	8.70			
FDM-880M(1)	8.80			
FDM-890M(1)	8.90			
FDM-900M(1)	9.00			
FDM-910M(1)	9.10			
FDM-920M(1)	9.20			
FDM-930M(1)	9.30			
FDM-940M(1)	9.40			
FDM-950M(1)	9.50			
FDM-960M(1)	9.60			
FDM-970M(1)	9.70			
FDM-980M(1)	9.80			
FDM-990M(1)	9.90			
FDM-1000M(1)	10.00			

How to Read Product Description

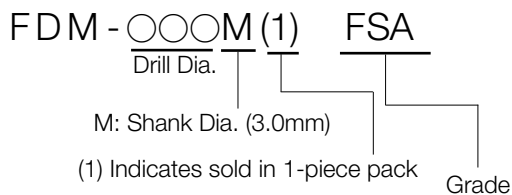

● : Stock Standard
 ○ : World Express

Items with (1) are sold in 1-piece packs

Fine Micro-Drills

FDM-M (Shank $\varnothing 3$, Non-Coated)

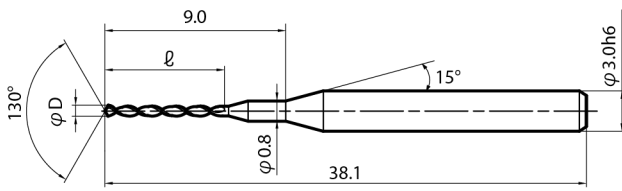

Fig.1

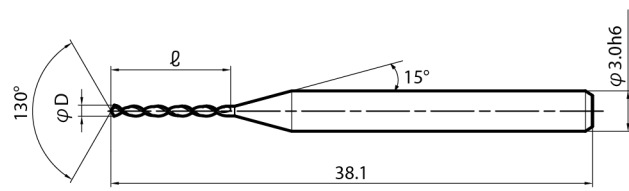

Fig.2

Helix Angle 30°

Drilling Tolerance
 $D \leq 0.50 (+0, -0.005)$
 $D > 0.50 (+0, -0.007)$

Description	Dimension (mm)		Fig.	Stock	
	Drill Dia.	Cutting Edge Length		Non Coating	
	D	ℓ		A	
FDM-010M(1)	0.10	1.3	Fig.1	○	
FDM-011M(1)	0.11			○	
FDM-012M(1)	0.12	1.5		○	
FDM-013M(1)	0.13			○	
FDM-014M(1)	0.14	1.7		○	
FDM-015M(1)	0.15			○	
FDM-016M(1)	0.16	1.9		○	
FDM-017M(1)	0.17			○	
FDM-018M(1)	0.18	2.2		○	
FDM-019M(1)	0.19			○	
FDM-020M(1)	0.20	2.4		○	
FDM-021M(1)	0.21			○	
FDM-022M(1)	0.22	2.7		○	
FDM-023M(1)	0.23			○	
FDM-024M(1)	0.24	2.9		○	
FDM-025M(1)	0.25			○	
FDM-026M(1)	0.26	3.1		○	
FDM-027M(1)	0.27			○	
FDM-028M(1)	0.28	3.3	○		
FDM-029M(1)	0.29		○		
FDM-030M(1)	0.30	5.0	○		
FDM-031M(1)	0.31		○		

Description	Dimension (mm)		Fig.	Stock	
	Drill Dia.	Cutting Edge Length		Non Coating	
	D	ℓ		A	
FDM-032M(1)	0.32	5.0	Fig.1	○	
FDM-033M(1)	0.33			○	
FDM-034M(1)	0.34			○	
FDM-035M(1)	0.35			○	
FDM-036M(1)	0.36	6.0	Fig.2	○	
FDM-037M(1)	0.37			○	
FDM-038M(1)	0.38	6.0		○	
FDM-039M(1)	0.39			○	
FDM-040M(1)	0.40	7.0	○		
FDM-041M(1)	0.41		○		
FDM-042M(1)	0.42		○		
FDM-043M(1)	0.43		○		
FDM-044M(1)	0.44		○		
FDM-045M(1)	0.45		○		
FDM-046M(1)	0.46		○		
FDM-047M(1)	0.47		○		
FDM-048M(1)	0.48	8.0	○		
FDM-049M(1)	0.49		○		
FDM-050M(1)	0.50	10.0	○		
FDM-060M(1)	0.60		○		
FDM-070M(1)	0.70		○		
FDM-080M(1)	0.80	○			

How to Read Product Description

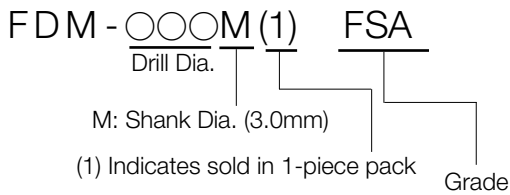

Items with (1) are sold in 1-piece packs

FDM-M (Shank Ø3.175, Non-Coated)

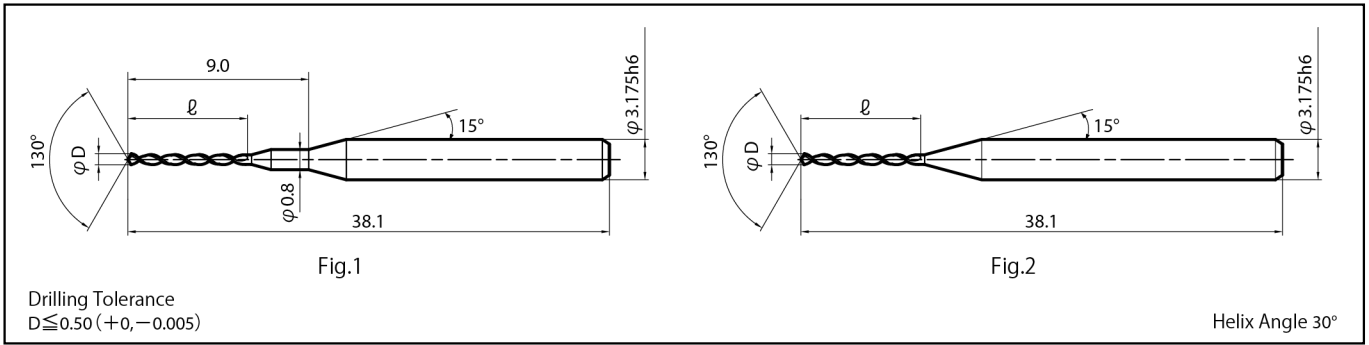

Description	Dimension (mm)		Fig.	Stock
	Drill Dia.	Cutting Edge Length		Coating
	D	ℓ		FSA
FDM-010	0.10	1.3	Fig.1	○
FDM-011	0.11			
FDM-012	0.12			
FDM-013	0.13	1.5		
FDM-014	0.14			
FDM-015	0.15	1.7		
FDM-016	0.16			
FDM-017	0.17	1.9		
FDM-018	0.18			
FDM-019	0.19	2.2		
FDM-020	0.20			
FDM-021	0.21	2.4		
FDM-022	0.22			
FDM-023	0.23	2.7		
FDM-024	0.24			
FDM-025	0.25	2.9		
FDM-026	0.26			
FDM-027	0.27	3.1		
FDM-028	0.28			
FDM-029	0.29	3.3		
FDM-030	0.30			
FDM-031	0.31	5.0		

Description	Dimension (mm)		Fig.	Stock	
	Drill Dia.	Cutting Edge Length		Coating	
	D	ℓ		FSA	
FDM-032	0.32	5.0	Fig.1	○	
FDM-033	0.33				
FDM-034	0.34				
FDM-035	0.35				
FDM-036	0.36	6.0			
FDM-037	0.37				
FDM-038	0.38	6.0			
FDM-039	0.39				
FDM-040	0.40	7.0		Fig.2	○
FDM-041	0.41				
FDM-042	0.42				
FDM-043	0.43				
FDM-044	0.44				
FDM-045	0.45				
FDM-046	0.46				
FDM-047	0.47				
FDM-048	0.48				
FDM-049	0.49				
FDM-050	0.50				

How to Read Product Descriptions (Drills are sold in 10-pc packs or 1-pc packs)

10-piece packs	FDM - ○○○○ <u>FSA</u> Drill Dia. Grade No indication means item sold in 10-piece pack
1-piece packs	FDM - ○○○○ (1) <u>FSA</u> Drill Dia. (1) Grade Indicates 1-piece pack



Recommended Drilling Condition

Custom order

Available for custom order

- ① Drilling diameter (Ø0.1~0.8mm)
- ② Diameter tolerance
- ③ Cutting edge length
- ④ Shank diameter Ø3.0/Ø3.175
- ⑤ Coating: FSA/A

Quick delivery for minor modification such as changing edge length.

Contact us for other modification request for tip angle, helix angle and others.

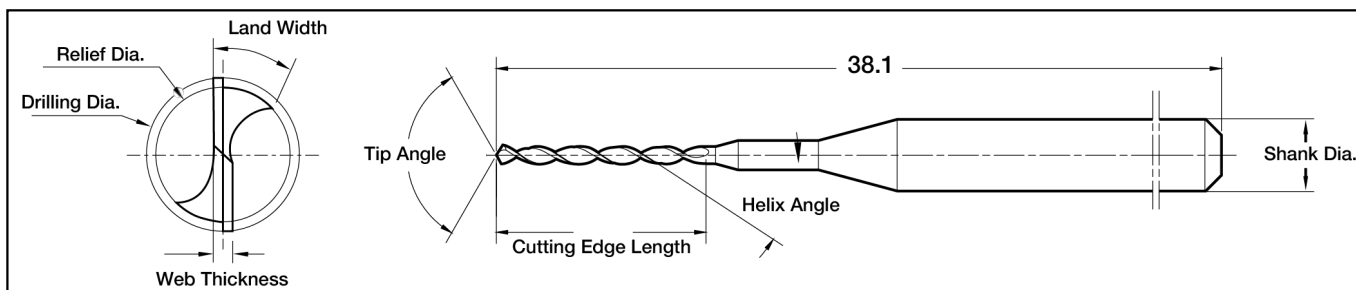

Recommended Drilling Conditions

(mm)	Carbon steel, alloy steel		Stainless Steel		Cast Iron		Aluminum, Alloy Steel	
	(m/min)	(mm/rev)	(m/min)	(mm/rev)	(m/min)	(mm/rev)	(m/min)	(mm/rev)
0.10~0.19	2~6	0.0005~0.002	2~6	0.0003~0.001	2~10	0.0005~0.003	4~15	0.0005~0.003
0.20~0.29	4~10	0.001~0.004	4~10	0.0005~0.002	5~15	0.001~0.005	10~20	0.001~0.005
0.30~0.50	6~15	0.002~0.010	6~10	0.001~0.005	10~20	0.004~0.015	15~30	0.004~0.015
0.60~0.80	8~24	0.004~0.015	8~15	0.002~0.007	10~30	0.005~0.020	20~45	0.005~0.020

Notes:

- Above conditions varies depending on work piece hardness and machine conditions
- Use coolant, water-insoluble recommended.
- Use higher precision chuck and minimize overhang length
- Recommend step feeding in case drilling 3 times or more depth of drill diameter
- Recommend depth per step is 10% to 50% of drill diameter, Take shorter step for deeper depth.



Fine Micro Drills

Drilling

Case Studies

NAK55		SK3		SUS316L	
<ul style="list-style-type: none"> • Plate • $n=16,000\text{min}^{-1}$ • $H=1\text{mm}$ • $V_f=22\text{mm}/\text{min}$ • Coolant • FDM-010M(A) ($\varnothing 0.10\text{mm}$) 		<ul style="list-style-type: none"> • Gage • $n=10,000\text{min}^{-1}$ • $H=3.5\text{mm}$ • $V_f=100\text{mm}/\text{min}$ • Coolant • FDM-036M(FSA) ($\varnothing 0.36\text{mm}$) 		<ul style="list-style-type: none"> • Plate • $n=8,000\text{min}^{-1}$ • $H=2.7\text{mm}$ • $V_f=45\text{mm}/\text{min}$ • Coolant • XFDM-040(FSA) ($\varnothing 0.40\text{mm}$) 	
Fine Micro Drill 600 holes / piece	600 Holes	Fine Micro Drill 5,200 holes /piece	5,200 Holes	Fine Micro Drill 2,400 holes / piece	2,400 Holes
Competitor B (Coating) 200 holes/pc broken	200 Holes(broken)	Competitor C (coating product) 4,000 holes / piece	4,000 Holes	Competitor D (coated High speed steel) 300 holes /piece	300 Holes
<ul style="list-style-type: none"> • Competitor B broken after 200holes • Fine Micro Drill (Non -Coat) process 3 times more compare to competitor B 		<ul style="list-style-type: none"> • Fine Micro Drill increased 30 % longer tool life compare to competitor C 		<ul style="list-style-type: none"> • Fine Micro Drill has 8 times longer tool life compare to competitor D 	



Counterbores



Counterbores

Drilling

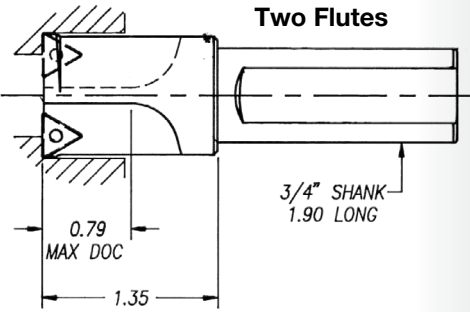
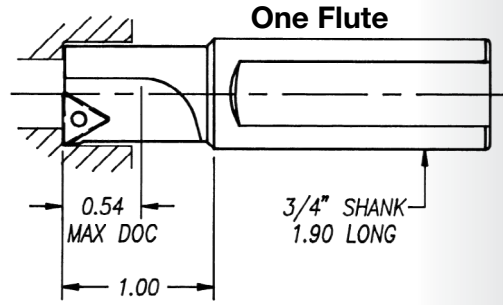

For Socket Head Cap Screw
 Sizes 1/4" to 3/4"
 and
 6mm to 16mm

Counterbore Inserts

Shape	Description (ANSI)	Description (ISO)	Dimension (inch)				Angle (°)	Insert Grade							
			A	T	Ød	rε		Cermet		CVD Coated			PVD Coated		Carbide
								TN6010	TN60	PV7010	PV90	CA2335	CA5515	CA5525	CA5535
		TCMT 18151HP TCMT 090204HP	7/32	3/32	0.094	1/64	7°	●	●	●			●	●	
		TCMT 18151HQ TCMT 090204HQ	7/32	3/32	0.098	1/64	7°	●	○	●					

Insert Grade Features [Page 2](#)

● : Stock Standard
 ○ : World Express

SHCS-CB

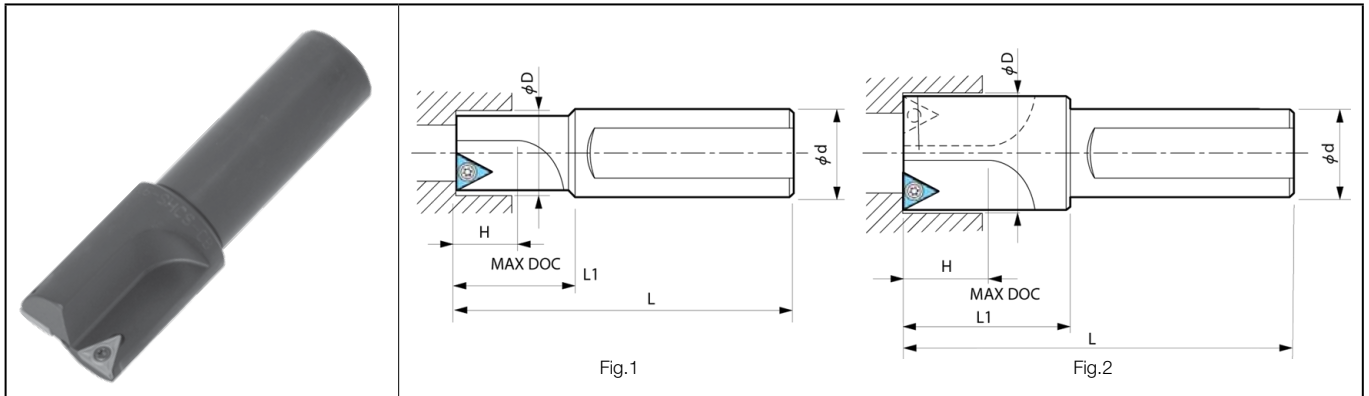

Counterbores

● Toolholder Dimensions

Description	Stock	No. of Insert	Unit	Dimension (inch)						Shape	Spare Parts		Applicable Inserts ● Page 73
				SHCS Size	ØD	Ød	L	L1	H max D.O.C.		Clamp Screw	Wrench	
1/4-SHCS-CB	●	1	inch	1/4	0.422	0.750	2.9	1	0.54	Fig. 1	SCR-05	FT-7	TCMT 18151
5/16-SHCS-CB	●			5/16	0.515								
3/8-SHCS-CB	●			3/8	0.609								
7/16-SHCS-CB	●			7/16	0.703								
1/2-SHCS-CB	●			1/2	0.797								
5/8-SHCS-CB	●	2	inch	5/8	1.000	0.750	3.25	1.35	0.79	Fig. 2	SCR-05	FT-7	TCMT 18151
3/4-SHCS-CB	●			3/4	1.187								
M6-SHCS-CB	●	1	mm	M6	0.440	0.750	2.9	1	0.54	Fig. 1	SCR-05	FT-7	TCMT 18151
M8-SHCS-CB	●			M8	0.558								
M10-SHCS-CB	●			M10	0.676								
M12-SHCS-CB	●			M12	0.755								
M16-SHCS-CB	●			M16	1.00								

Note: Maximum material removal per side is 1/4"

● : Stock Standard
○ : World Express

Drilling



Countersinks



Countersinks

CS-82-177

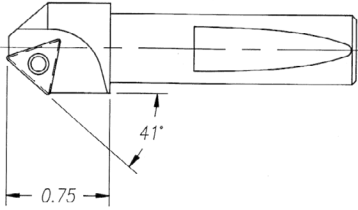

CS-82-362

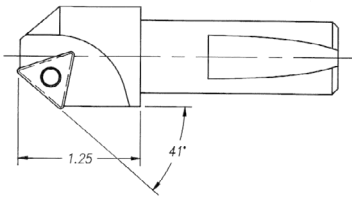

CS-82-612

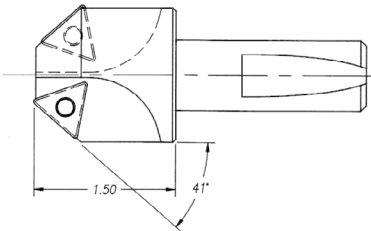

For Flat Head Cap
Screw Sizes #10 to 3/4"



Drilling

Countersink Inserts

Shape	Description (ANSI)	Dimension (inch)				Angle (°)	Insert Grade					
		A	T	Ød	rε		Cermet	PVD Cermet	CVD Coated	PVD Coated	Carbide	
							TN60	PV7010	PV90	CA2335	PR830	PR930
	TCMT 2151HQ	1/4	3/32	0.110	1/64	7°	●		●	●	●	●
	3252HQ				1/32		●		●	●	●	●

Insert Grade Features [Page 2](#)

● : Stock Standard
○ : World Express

CS

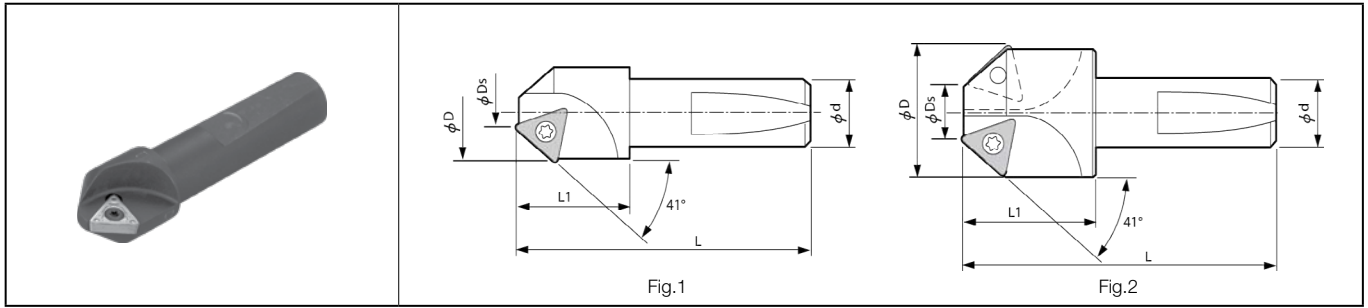

● Toolholder Dimensions

Description	Stock	No. of Insert	Dimension (inch)					Rake Angle (°)		Shape	FHCS Size	Spare Parts		Applicable Inserts ● Page 75
			ØD	ØDs	Ød	L	L1	A.R.	R.R.			Clamp Screw	Wrench	
CS 82-177	●	1	0.673	0.177	0.500	2.530	0.750	0°	0°	Fig.1	#10, 1/4", 5/16"	SCR-01	FT-7	TCMT2151
82-362	●	1	1.073	0.362	0.750	3.280	1.250				3/8", 7/16", 1/2"	SCR-02	FT-15	TCMT3252
82-612	●	2	1.464	0.612	0.750	3.530	1.500	0°	0°	Fig.2	5/8", 3/4"			

● : Stock Standard
○ : World Express



Adjustable Sleeves

ASL / SHE for Magic Drill DRZ & DRX

Diameter Adjustment / Center Height Adjustment

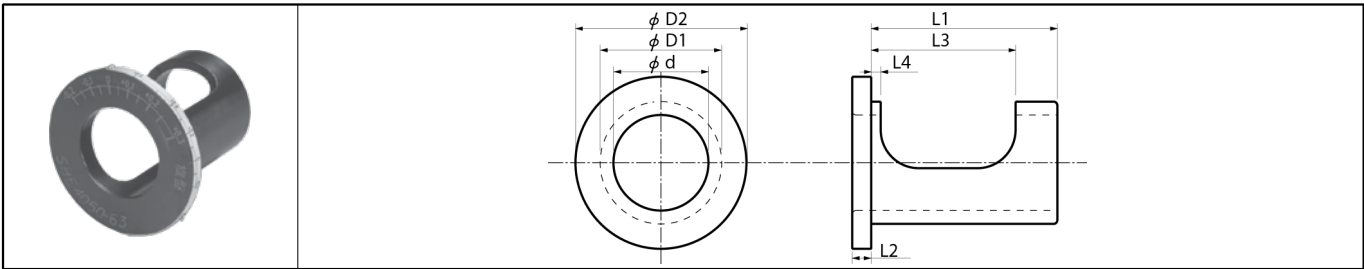

Sleeve Dimensions (Use ASL for inch sizes, SHE for metric sizes)

Description	Stock	Unit	Dimension						Dia. Adjustment Range	Center Height Adjustment Range	
			ϕd	$\phi D1$	$\phi D2$	L1	L2	L3			L4
ASL 75100-175 100125-212 125150-238	○	inch	0.75	1.00	1.614	1.750	0.157	1.417	0.118	+ 0.016 ~ - 0.008	+0.008 ~ -0.006
			1.00	1.25	1.929	2.125	0.236	1.496	0.098	+ 0.016 ~ - 0.008	+0.008 ~ -0.006
			1.25	1.50	2.283	2.375	0.236	1.693	0.098	+ 0.016 ~ - 0.008	+0.008 ~ -0.006
SHE 2025-43 2532-48 3240-53 4050-63	○	mm	20	25	41	43	4	36	3.0	+0.4~-0.2	+0.2~-0.15
			25	32	49	48	6	38	2.5	+0.4~-0.2	+0.2~-0.15
			32	40	58	53	6	43	2.5	+0.4~-0.2	+0.2~-0.15
			40	50	74	63	6	49	3.0	+0.4~-0.2	+0.3~-0.2

• Dia. adjustment range refers to the cutting diameter.

• ASL and SHE are only to be used with the Magic Drill (DRX, DRZ-type). Not recommended for the small dia. Magic Drill (DRS-type) because the adjustment range is too large.

1. Diameter Adjustment –For Machining Center–

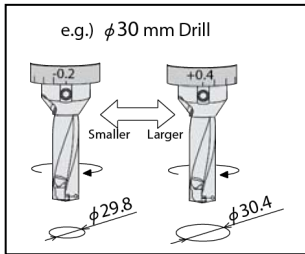

• Diameter Adjustment Range (ASL=inch)

Shank Dia.	Cutting Dia.	Range
.75	.512~.610	+0.016~-0.008
1.00	.625~1.260	
1.25	1.299~2.00	

• Diameter Adjustment Range (SHE=mm) (DRZ)

Shank Dia.	Cutting Dia.	Range
$\phi 20$	$\phi 13\sim 15.5$	+0.4~-0.2
$\phi 25$	$\phi 16\sim 26.5$	
$\phi 32$	$\phi 27\sim 40$	
$\phi 40$	$\phi 33\sim 65$	

• Diameter Adjustment Range (SHE=mm) (DRX)

Shank Dia.	Cutting Dia.	Range
$\phi 20$	$\phi 13.5\sim 15$	+0.4~-0.2
$\phi 25$	$\phi 15.5\sim 26$	
$\phi 32$	$\phi 26.5\sim 31.5$	
$\phi 40$	$\phi 32\sim 60$	

2. Center Height Adjustment –For Lathe Operation–

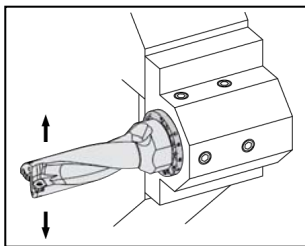

• Center Height Adjustment Range (ASL=inch)

Shank Dia.	Cutting Dia.	Range
.75	.512~.610	+0.008~-0.006
1.00	.625~1.260	
1.25	1.299~2.00	

• Center Height Adjustment Range (SHE=mm) (DRZ)

Shank Dia.	Cutting Dia.	Range
$\phi 20$	$\phi 13\sim 15.5$	+0.2~-0.15
$\phi 25$	$\phi 16\sim 26.5$	
$\phi 32$	$\phi 27\sim 40$	
$\phi 40$	$\phi 33\sim 65$	

• Center Height Adjustment Range (SHE=mm) (DRX)

Shank Dia.	Cutting Dia.	Range
$\phi 20$	$\phi 13.5\sim 15$	+0.2~-0.15
$\phi 25$	$\phi 15.5\sim 26$	
$\phi 32$	$\phi 26.5\sim 31.5$	
$\phi 40$	$\phi 32\sim 60$	

SHEM for Magic Drill DRS

Diameter Adjustment

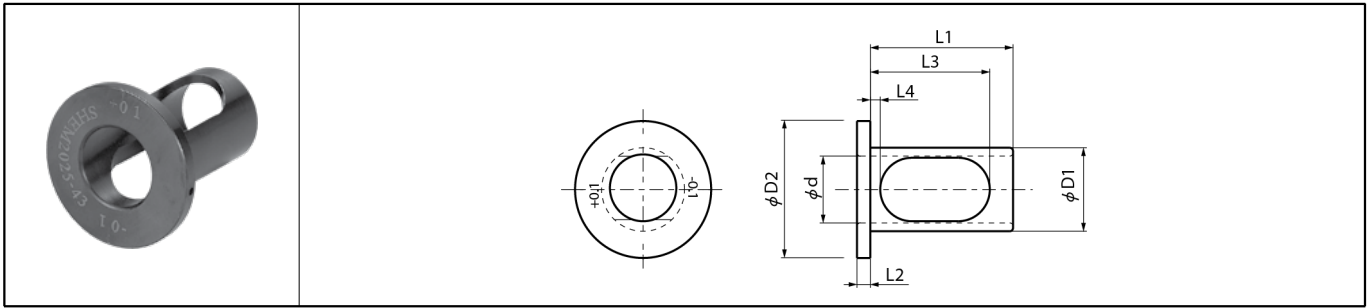

Sleeve Dimensions

Description	Stock	Dimension							Dia. Adjustment Range (mm)
		Ød	ØD1	ØD2	L1	L2	L3	L4	
SHEM 2025-43	○	20	25	41	43	4	36	3.0	+0.1, -0.1
2032-43	○	20	32	49	43	6	36	2.5	+0.1, -0.1

• Dia. Adjustment Range adjusts the cutting diameter.

How to Use

- SHEM is designed for only the Small Diameter Magic Drill.
 - SHEM is for cutting diameter adjustment only. (up to +0.1mm or -0.1mm)
 - SHEM is not for center height adjustment like conventional adjustable sleeve (SHE-type).
 - Apply SHEM when adjusting the cutting diameter for pre-drilling before threading.
- ① Set the outer edge horizontally: 90° to the marking line on the sleeve (Fig.1)
 - ② To adjust to a larger diameter, align the +0.1 mark on the sleeve with the flat on the drill shank. To adjust to a smaller diameter, align the -0.1 mark on the sleeve with the flat on the drill shank.
 - ③ Tighten the bottom screw firmly which is directly touching the drill. Slightly tighten the upper screw which is directly touching the sleeve.

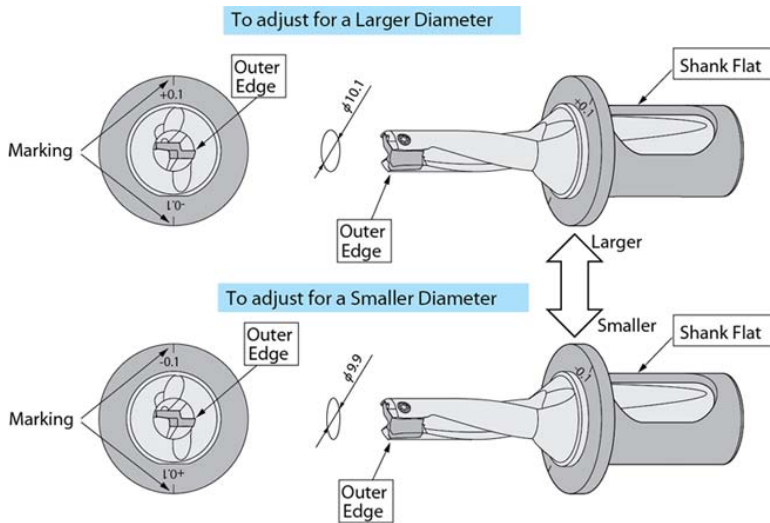

Fig.1 Diameter Adjustment Method (e.g.) φ10 Drill

Caution: Not for use with Collet Chuck type Arbor

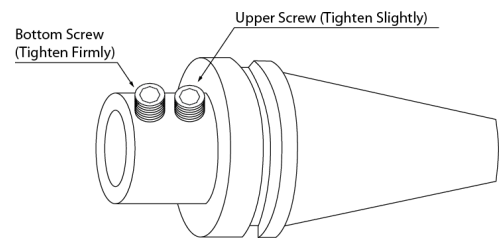

Fig. 2



Adjustable Sleeves

Drilling

Customized Drills

Several customization options available for your specific drilling applications



Customized Drills
Drilling

Add Multiple Counterbores, Countersinks, or Chamfer Inserts



Custom Diameters and Lengths Available



Custom Shanks Available

- CAT
- ABS
- BT
- HSK
- Metric
- Special Diameters & Lengths



Customized Drill Ordering Procedure

To request a quote for a custom drill, please follow the steps below:

1. Photocopy and fill out the Special Tool Design Worksheet on adjacent page.
2. Fax the completed form along with any necessary prints and drawings to the Kyocera Quotations Department at 828-692-1344.
3. Contact the Kyocera Quotations Department at 800-823-7284 with any questions regarding the custom drill quotation procedure.

Kyocera Industrial Ceramics Corp.
Cutting Tool Division
Ph: 800-823-7284
Fax: 828-692-1344
Email: kyoceracuttingtools@kyocera.com
www.kyocera.com/cuttingtools

SPECIAL TOOL DESIGN WORKSHEET

DATE: _____

CUSTOMER INFORMATION

Company Name: _____

Phone: _____

Contact: _____

Fax: _____

Address: _____

Email: _____

City, State, Zip: _____

Kyocera Distributor Name: _____

PART INFORMATION

Part Number or Description: _____

Material: _____

Hardness (Rc): _____

Current problem or objective: _____

MACHINE INFORMATION

Machine being toolled: _____

Machine condition, age: _____

Spindle Hp: _____

Max RPM: _____

Max IPM: _____

Circle one of each: Horizontal or vertical spindle? Stationary or rotating tooling?

TOOL INFORMATION

Describe the tool (drill, mill, combo tool?) _____

Quantity to quote: _____

Shank size/description: _____

Right or left hand cutting: _____

Thru coolant? (and inlet type/location): _____

Size or weight restrictions (if applicable): _____

Prints and Drawings

Finished part

Raw stock or casting

Fixturing

Special inserts, hardware, etc.

Process sheet

Existing tooling

Supplied information should include:

Tolerance requirements, raw stock tolerances

Surface finish requirements (witness lines ok?)

Depth(s) of cut

Fillets, inside corner radii (insert nose radii)

Allowable overtravel on thru cuts

Amount of finish stock to leave

■ Technical Information Contents

The technical section of this catalog is intended to provide sufficient basic information to apply indexable cutting tools, specifically Kyocera products. The majority of requests for technical support that Kyocera receives are for speeds and feeds. If you need technical help beyond what is contained in this section, contact our technical staff at 800-823-7284.

Drilling Basics 82

Magic Drill DRZ 83

DRZ	Set-up	83-84
DRZ	Recommended Cutting Conditions	85
DRZ	Hole Bottom Shape	86
DRZ	Case Studies	87

Magic Drill DRX 88

DRX	Chipbreaker Selection	88
DRX	Recommended Cutting Conditions	89
DRX	Hole Bottom Shape	90
DRX	Cutting Conditions by Application	90

Magic Drill DRC 91

DRC	Recommended Cutting Conditions	91
DRC	Insert Installion	92
DRC	Applicable Workpieces	93
DRC	Case Studies	94

Holeshot Drill DR 95

DR	Drill Applications	95
DR	Recommended Cutting Conditions	95

Other Recommended Cutting Conditions 96

CD	Recommended Cutting Conditions	96
DRS	Recommended Cutting Conditions	96
SDR	Recommended Cutting Conditions	97

Drilling & Core Drilling Basic Formulas 98

Drilling Troubleshooting 99





■ Drilling Basics

Proper drilling involves proper machine setup, coolant delivery, insert selection, and a basic understanding of the drilling process. Indexable drills are not the same as twist drills in application or performance.

BASIC DRILLING

Drilling a hole from solid stock is a tough job for a variety of reasons. Chip and heat evacuation are tough, the actual cutting action is hidden from view, and the surface footage varies from the programmed speed at the outer cutting edge to zero at the center of the tool. A drill doesn't actually cut at the center, it pushes the material out of the way. Cutting forces are high and other factors such as coolant delivery and machine alignment can combine to cause a drill to deflect and cut off-size, or fail catastrophically.

MACHINE SETUP

This is an important consideration when using indexable drills. In drilling, shorter is always better. Use the shortest drill and the shortest adapter possible. This will always improve performance. The machine spindle and bearings should be in good condition, and the fixturing must be adequate and rigid.

In lathes, **alignment is crucial**. The tool must run within 0.003" TIR to the spindle, or insert failure could occur. **If the center insert continually chips, check the alignment**. Chuck jaws should be in good condition as well and provide adequate clamping pressure. The workpiece should not extend from the chuck excessively either.

COOLANT DELIVERY

Coolant thru-the-spindle should be used wherever possible. Coolant improves tool life by lubricating the cut and removing heat and chips from the work area. Chip evacuation is very important when drilling.

INDEXABLE VS. TWIST DRILLS

Indexable drills are very different than twist drills. Replaceable inserts eliminate drill regrinding. Because of higher surface footages, indexable drills generally out-feed twist drills.

DRILLS VS. CORE DRILLS

Kyocera drills are designed to put holes in solid material. Kyocera core drills are used to open a pre-existing hole. Core drills, because of their design, can attain two times the feed rate of insert drills. As a result, core drills provide an excellent means of enlarging an existing hole.

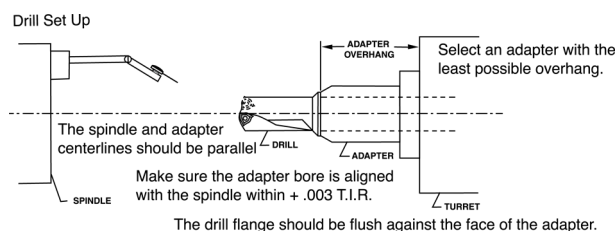
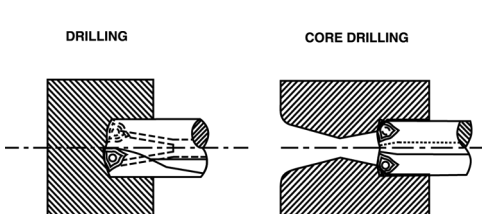

APPLICATION CONSIDERATIONS

Feed and Speeds

Proper cutting speeds and feeds are obviously important considerations. The recommended cutting feed and speeds shown in this section are starting points derived through testing in our Tech Center and in the field. Adjustments are frequently required for optimum results based on specific application configurations. Call your local Kyocera Sales Engineer for assistance as necessary.

Rigid Setups

No tool will perform at maximum potential in a poor setup. Workpieces must be held securely and in accurate alignment (.XXX or less for non-DRC drills and .XXXX for DRC drills).

Tombstones must be mounted properly, and workholding must be adequate. Worn jaws can introduce chatter, and possibly mislocate parts, or even release parts during the cut. The machine itself must be in good condition, and **tool gage lengths should be as short as possible**. Shorter gage lengths result in higher feed capabilities with less deflection and chatter, and longer insert life.

Machine Horsepower vs. Spindle Horsepower

There can be a great difference between the spindle motor rating (machine horsepower) and the horsepower at the tool tip (spindle horsepower). Typically, spindle horsepower is around 75% of rated horsepower. As a good rule of thumb, drills require approximately 5hp per inch of diameter when cutting steel. The machine's power curve should be referenced to determine the power available at various speeds in order to determine capability.

Magic Drill Set-Up for Lathes

■ Installation

- ① The top face of the outer insert should be parallel to the X-axis to allow for offset cutting.
- ② It is recommended to set the outer insert as shown in Fig. 1 with the outer insert facing the operator. (It is also possible to use it by setting 180° reverse position.) In case of the lathe with two turrets, when installing the drill to the lower turret, the outer insert should be set so as to face the operator. (It is also possible to use it by setting at 180° reverse position)

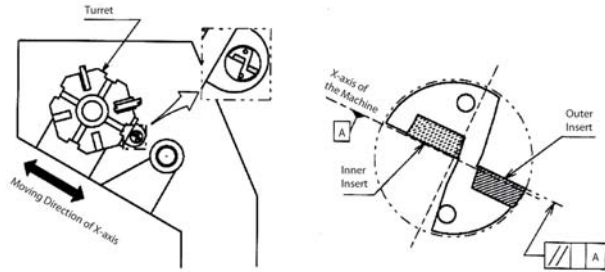

Fig.1 Installation to the Turning Lathe

■ Cutting Diameter Adjustment

1. Cutting Diameter Adjustment

- ① Cutting diameter is adjusted by moving the tool in the X-axis direction. The moving direction of the X-axis movement depends on the position of the toolholder.
- ② For making the hole diameter larger, slide the tool along the X-axis toward the outer insert side. (Fig. 2, Fig. 3) For making the hole diameter smaller, slide the tool along the X-axis in the opposite direction. (This movement of the axis is called "Offset") However, be sure not to make the hole diameter smaller than the drill diameter by 0.2mm (.008") or more. Otherwise, the toolholder will interfere with the drilled hole. (Fig. 4) e.g.) when using $\varnothing 20$ ($\varnothing .787$ ") drill, the hole diameter must not be smaller than 19.8mm (.780") .

2. Offset Limit of the Cutting Diameter

For the maximum limit of the cutting diameter, refer to "Max. Offset (Radial)" in the Toolholder Dimension table. (The figure in the table shows how much it is possible the offset the drill in the radial direction.) e.g.) In case of using $\varnothing 20$ ($\varnothing .787$ ") drill, it is possible to make a hole up to $\varnothing 2$ ($\varnothing .827$ ") 1 since "Max. Offset (Radial)" is +0.5mm (.02") .

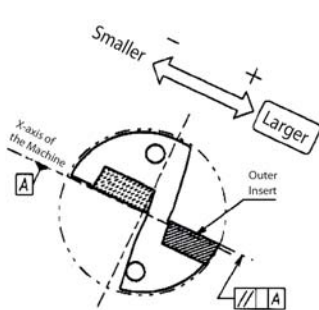

Fig. 2 Outer Insert Facing Up

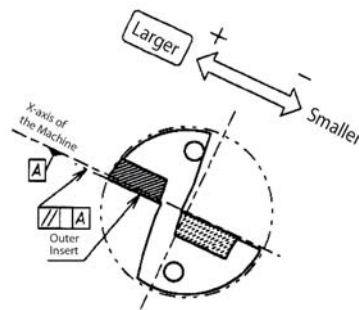
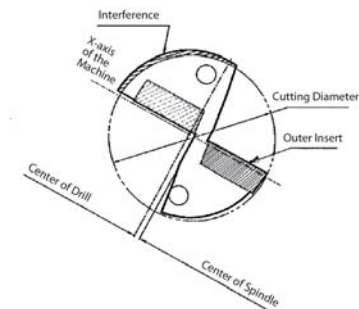

Fig. 3 Outer Insert Facing Down



■ Center Height Adjustment

1. Center Height of the Inner Insert

When installing inner insert as shown in Fig. 1, it will be set around 0.2mm (.008") below the Center line of the Spindle. (Fig. 5) This is the normal position of the center height and the inner insert is designed to be set at this position. However, in case that the turret of the lathe is out of alignment, sometimes the inner insert may be above, or excessively below the center. For stable machining, it is essential to check the center height of the inner insert carefully.

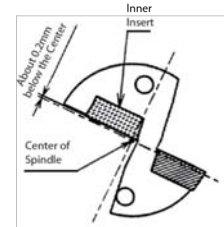

Fig. 5 Front View of the Drill

2. How to Check the Center Height of Inner Insert

For checking the center height of the inner insert, see the core which remains at the center of the drilled hole. (Fig. 6) If the center height is in the normal condition, a core of about 0.5mm (.02") in diameter will remain after machining.

In the following case, it is necessary to adjust the center height.

- No core remains
- Core diameter is more than 1mm (.04")

For test cutting to check the center height, drill a shallow hole about 10mm (.40") in depth at low feed rate of less than 0.1mm/rev (.004ipr) .

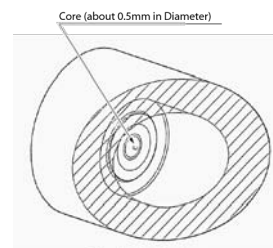

Fig. 6 Center Core



3. Center Height Adjustment

a) No Core or Cores with Small Diameter

This occurs when the inner insert is on or above the center.
In this case, adjustment is necessary since insert breakage is likely at the center of the drill. (Fig. 7)

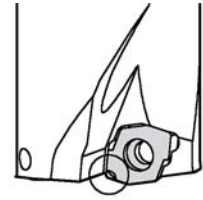

Fig. 7 Insert Breakage near the Center of Drill

Adjustments

① Install the drill rotated at the 180°. Most problems will be solved by this method.

② If the core diameter becomes too large after the above adjustment, install the drill rotating 90° counter-clockwise as shown in Fig.9 (outer insert is positioned lower) and adjust the center height by moving the tool in the X-axis direction.

(However, this makes it impossible to adjust the cutting diameter.)

Caution: In case of installing the drill in the opposite direction (outer insert is positioned upper), the cutting diameter will become smaller, which may cause the drill body to interfere with the drilled hole.

The fundamental solution is to readjust the center position of the turret itself.

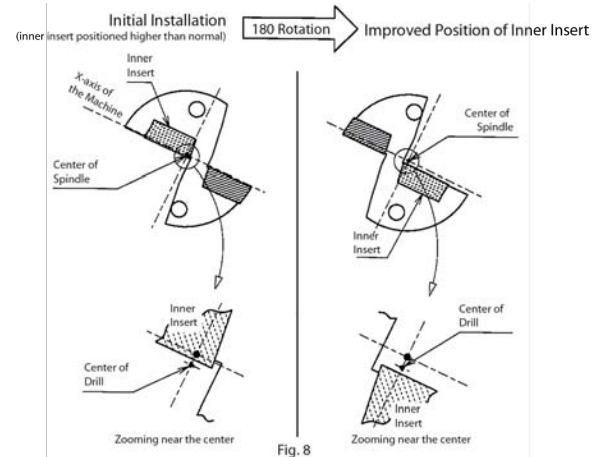

Fig. 8

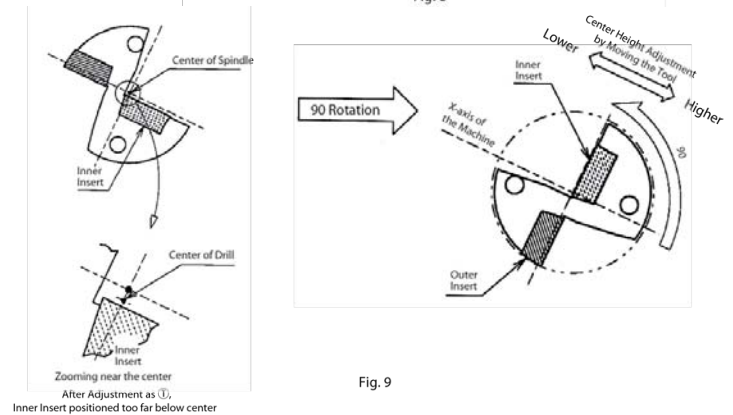

Fig. 9

b) Core with Excessively Large Diameter (More than 1mm/.04")

This occurs when the inner insert is excessively below the center.
This condition causes poor chip evacuation and on adjustment is required.

Adjustments

Install the drill rotating 90° counter-clockwise as shown in Fig.10 (outer insert is positioned upper), and adjust the center height by moving the tool in the X-axis direction.

(However, this makes it impossible to adjust the cutting diameter.)

Caution: When installing the drill in the opposite direction (outer insert is positioned lower), the cutting diameter will become smaller, which may cause the drill body to interfere with the drilled hole.

The fundamental solution is to readjust the center position of the turret itself.

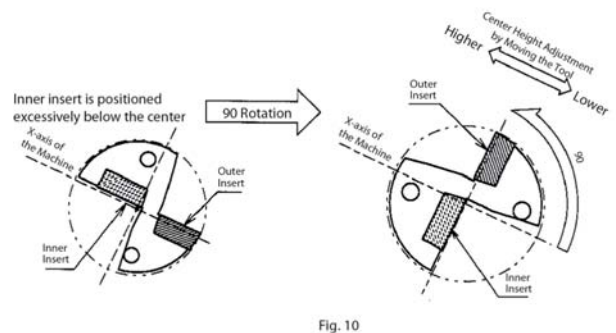

Fig. 10



Technical Information

■ Magic Drill (DRZ) Recommended Cutting Conditions (Coolant)







Workpiece Material	Recommended Grade (Vc sfm)										Cutting Diameter ØD (inch)	Holder Type (Cutting Depth)			
	MEGACOAT			PVD Coated Carbide						Carbide		2D	3D	4D	5D
	PR1230	PR1225	PR1210	PR660	PR830	PR915	PR1025	PR930	PR905	KW10					
	Standard	Standard	Standard	Standard	Standard	Standard	Standard	Standard	Standard	Standard					
SP SU	SP SU		SP SU	SP		SP SU	SP		SP						
											f (ipr)				
Low-Carbon Steel											Ø0.512~Ø0.610	0.023~0.004	0.023~0.004	0.016~0.003	-
											Ø0.630~Ø1.024	0.003~0.006	0.003~0.006	0.023~0.047	-
											Ø1.063~Ø1.968	0.003~0.007	0.003~0.007	0.023~0.047	0.002~0.0035
											Ø1.969~	0.003~0.007	0.003~0.007	0.038~0.047	0.002~0.0035
Carbon Steel											Ø0.512~Ø0.610	0.023~0.004	0.023~0.004	0.016~0.003	-
											Ø0.630~Ø1.024	0.003~0.006	0.003~0.006	0.023~0.047	-
											Ø1.063~Ø1.968	0.003~0.007	0.003~0.006	0.023~0.047	0.002~0.0035
											Ø1.969~	0.003~0.007	0.003~0.006	0.023~0.047	-
Alloy Steel											Ø0.512~Ø0.610	0.023~0.004	0.023~0.004	0.016~0.003	-
											Ø0.630~Ø1.024	0.003~0.006	0.003~0.006	0.023~0.047	-
											Ø1.063~Ø1.968	0.003~0.007	0.003~0.006	0.023~0.047	0.002~0.0035
											Ø1.969~	0.003~0.007	0.003~0.006	0.023~0.047	-
Tool Steel											Ø0.512~Ø0.610	0.016~0.003	0.016~0.003	0.023~0.003	-
											Ø0.630~Ø1.024	0.003~0.0047	0.023~0.004	0.023~0.003	-
											Ø1.063~Ø1.968	0.003~0.006	0.023~0.047	0.023~0.004	0.04~0.07
											Ø1.969~	0.003~0.006	0.023~0.047	0.023~0.004	-
Stainless Steel											Ø0.512~Ø0.610	0.016~0.003	0.016~0.003	0.0012~0.002	-
											Ø0.630~Ø1.024	0.023~0.004	0.023~0.004	0.016~0.003	-
											Ø1.063~Ø1.968	0.023~0.004	0.023~0.047	0.016~0.004	0.04~0.07
											Ø1.969~	0.23~0.047	0.023~0.047	0.016~0.004	-
Gray Cast Iron											Ø0.512~Ø0.610	0.003~0.004	0.003~0.004	0.003~0.047	-
											Ø0.630~Ø1.024	0.004~0.006	0.004~0.006	0.003~0.0047	-
											Ø1.063~Ø1.968	0.004~0.008	0.004~0.007	0.003~0.006	0.023~0.004
											Ø1.969~	0.004~0.008	0.004~0.007	0.003~0.006	-
Nodular Cast Iron											Ø0.512~Ø0.610	0.003~0.0047	0.003~0.004	0.003~0.047	-
											Ø0.630~Ø1.024	0.004~0.007	0.004~0.007	0.003~0.0047	-
											Ø1.063~Ø1.968	0.004~0.008	0.004~0.007	0.003~0.006	0.023~0.004
											Ø1.969~	0.004~0.008	0.004~0.007	0.003~0.006	-
Non-Ferrous Metals											Ø0.512~Ø0.610	0.0023~0.0047	0.0023~0.004	0.0016~0.003	-
											Ø0.630~Ø1.024	0.003~0.007	0.003~0.006	0.0023~0.0047	-
											Ø1.063~Ø1.968	0.003~0.008	0.003~0.007	0.0023~0.0047	0.002~0.004
											Ø1.969~	0.003~0.008	0.003~0.007	0.0023~0.0047	-
Titanium Alloys											Ø0.512~Ø0.610	0.002~0.0023	0.002~0.0023	0.002~0.0023	-
											Ø0.630~Ø1.024	0.002~0.0028	0.002~0.0028	0.002~0.0028	-
											Ø1.063~Ø1.968	0.003~0.047	0.003~0.047	0.003~0.047	0.0016~0.002
											Ø1.969~	0.003~0.047	0.003~0.047	0.003~0.047	-

• Apply sufficient amount of coolant

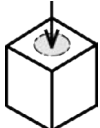
★ : 1st Recommendation ☆ : 2nd Recommendation

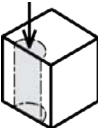
◆ Cutting Conditions by Application

(Work Material : 1050)

Application	Plain Surface	Slant Surface	Half Cylindrical	Hole Expansion	Concave Surface	Pre-drilled Surface	Stacked Plates
Workpiece Shape							
DRS	SFM	270	270	Not Recommended	Not Recommended	270	
	f (ipr)	0.003	0.0016	Not Recommended	Not Recommended	Concave Part 0.0016 Continuous Part 0.003	
DRZ	SFM	400	400	400	400	400	
	f (ipr)	0.004	0.002	0.002	0.002	Concave Part 0.002 Continuous Part 0.004	
Coolant	Yes	Yes	Yes	Yes	Yes	-	-



Technical Information

Drilling

■ Magic Drill (DRZ) Hole Bottom Shape (For 2xD, 3xD, and 4xD)

◆ Inch Size (inch)

ØD	A	B	C	ØD	A	B	C	ØD	A	B	C
0.512	0.083	0.173	0.016	0.846	0.122	0.301	0.024	1.299	0.224	0.425	0.031
0.531		0.183	0.016	0.866		0.311	0.024	1.339		0.445	0.031
0.551		0.193	0.016	0.886		0.321	0.024	1.378		0.465	0.031
0.571		0.203	0.016	0.906		0.331	0.024	1.417		0.484	0.031
0.591		0.213	0.020	0.925		0.341	0.024	1.457		0.504	0.031
0.610		0.222	0.020	0.945		0.350	0.028	1.496		0.524	0.035
0.630	0.106	0.209	0.024	0.965	0.157	0.360	0.028	1.535	0.256	0.543	0.035
0.650		0.219	0.024	0.984		0.370	0.028	1.575		0.563	0.035
0.669		0.228	0.024	1.004		0.380	0.028	1.614		0.551	0.039
0.689		0.238	0.024	1.024		0.390	0.028	1.654		0.571	0.039
0.709		0.248	0.024	1.043		0.400	0.028	1.693		0.591	0.039
0.728		0.258	0.028	1.063		0.374	0.028	1.732		0.610	0.039
0.748	0.268	0.028	1.083	0.384	0.028	1.772	0.630	0.039			
0.768	0.278	0.028	1.102	0.394	0.028	1.811	0.650	0.039			
0.787	0.287	0.028	1.122	0.404	0.028	1.850	0.669	0.039			
0.807	0.297	0.028	1.142	0.413	0.028	1.890	0.689	0.043			
0.827	0.307	0.031	1.161	0.423	0.028	1.929	0.709	0.043			
* Figures in chart are nominal sizes. (Varies from -0.004" to +0.004" depending on work material and cutting conditions)				1.181	0.433	0.028	1.969	0.728	0.043		
				1.201	0.443	0.028	2.008	0.748	0.043		
				1.220	0.453	0.031	2.047	0.768	0.043		
				1.240	0.463	0.031	2.087	0.787	0.043		
				1.260	0.472	0.031	2.126	0.728	0.047		
				1.280	0.482	0.031	2.165	0.748	0.047		
				2.205	0.335	0.768	0.047				
				2.244		0.787	0.047				
				2.283		0.807	0.047				
				2.323		0.827	0.047				
2.363	0.847	0.047									

◆ Metric Size (mm)

ØD	A	B	C	ØD	A	B	C	ØD	A	B	C
13.0	2.1	4.4	0.4	21.5	3.1	7.7	0.6	33.0	5.7	10.8	0.8
13.5		4.7	0.4	22.0		7.9	0.6	34.0		11.3	0.8
14.0		4.9	0.4	22.5		8.2	0.6	35.0		11.8	0.8
14.5		5.2	0.4	23.0		8.4	0.6	36.0		12.3	0.8
15.0		5.4	0.5	23.5		8.7	0.6	37.0		12.8	0.8
15.5		5.7	0.5	24.0		8.9	0.7	38.0		13.3	0.9
16.0	2.7	5.3	0.6	24.5	9.2	0.7	39.0	13.8	0.9		
16.5		5.6	0.6	25.0	9.4	0.7	40.0	14.3	0.9		
17.0		5.8	0.6	25.5	9.7	0.7	41.0	14.0	1.0		
17.5		6.1	0.6	26.0	9.9	0.7	42.0	14.5	1.0		
18.0		6.3	0.6	26.5	10.2	0.7	43.0	15.0	1.0		
18.5		6.6	0.7	27.0	9.5	0.7	44.0	15.5	1.0		
19.0	4.0	6.8	0.7	27.5	9.8	0.7	45.0	16.0	1.0		
19.5		7.1	0.7	28.0	10.0	0.7	46.0	16.5	1.0		
20.0		7.3	0.7	28.5	10.3	0.7	47.0	17.0	1.0		
20.5		7.6	0.7	29.0	10.5	0.7	48.0	17.5	1.1		
21.0		7.8	0.8	29.5	10.8	0.7	49.0	18.0	1.1		
30.0		11.0	0.7	50.0	18.5	1.1					
30.5	11.3	0.7	51.0	19.0	1.1						
31.0	11.5	0.8	52.0	19.5	1.1						
31.5	11.8	0.8	53.0	20.0	1.1						
32.0	12.0	0.8	54.0	18.5	1.2						
32.5	12.3	0.8	55.0	19.0	1.2						
56.0	8.5	19.5	1.2								
57.0		20.0	1.2								
58.0		20.5	1.2								
59.0		21.0	1.2								
60.0		21.5	1.2								

* Figures in chart are nominal sizes.
(Varies from -0.1mm to +0.1mm depending on work material and cutting conditions)

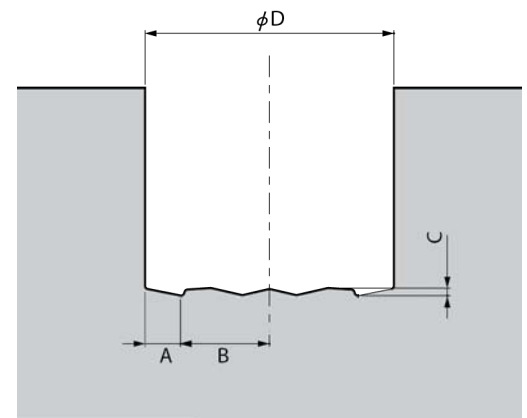

Technical Information

■ Magic Drill (DRZ) Case Studies



Technical Information

Drilling

1025		
Flange v=600 sfm d=0.79" (through hole) f=0.004 ipr Wet S32-DRZ2266-08 ZCMT080304 (PR660)		
Magic Drill	Tool Life	1750 pcs/edge
	Efficiency	123%
Competitor A	Tool Life	900 pcs/edge
	Efficiency	100%

1045		
Housing v=500 sfm d=3.94" (through hole) f=0.005 ipr Wet S40-DRZ50150-15 ZCMT150408 (PR660)		
Magic Drill	Tool Life	60 pcs/edge
	Efficiency	109%
Competitor B	Tool Life	10 pcs/edge
	Efficiency	100%

80-55-06		
Bearing Box v=260 sfm d=1.1" f=0.010 ipr Wet S25-DRZ2678-08 ZCMT080304 (PR905)		
Magic Drill	Tool Life	600 holes/edge
	Efficiency	333%
Competitor C	Tool Life	300 holes/edge
	Efficiency	100%

1042		
Block v=425 sfm d=0.63" f=0.005 ipr Wet S25-DRZ1854-06 ZCMT06T204 (PR660)		
Magic Drill	Tool Life	Over 432 holes/edge
	Efficiency	178%
Competitor D	Tool Life	432 holes/edge
	Efficiency	100%

■ Magic Drill (DRX) Recommended Chipbreakers (ZXMT)

Workpiece Material	Insert	ZXMT type											
	Chipbreaker	GM				GH				SM			
	Cutting Depth	2D	3D	4D	5D	2D	3D	4D	5D	2D	3D	4D	5D
Low-carbon Steel		☆	☆	☆	☆					★	★	★	★
Carbon Steel		★	★	★	☆	☆	☆	☆	☆	☆	☆	☆	★
Alloy Steel		★	★	★	☆	☆	☆	☆	☆	☆	☆	☆	★
Mold Steel		☆	☆	☆	☆	★	★	★	★				
Stainless Steel										★	★	★	★
Cast Iron		★	★	★	★								
Aluminum Alloys										★	★	★	★
Brass										★	★	★	★
Titanium Alloys										★	★	★	★

★ : 1st Recommendation ☆ : 2nd Recommendation

■ How to select ZXMT03

ZXMT03 type (Cutting Dia : $\phi 12 \sim \phi 13$)

- 1) For outer edge, please select "-E" insert from three different chipbreakers for each application.
- 2) For inner edge, please select "-I" insert (GM chipbreaker only).

•Outer edge



ZXMT030203OO-E



GM-E GH-E SM-E

•Inner Edge



ZXMT030203GM-I













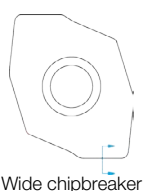
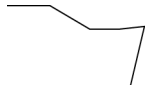
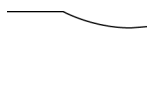

GM-I

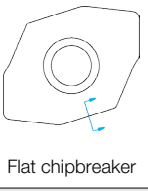

Technical
Information

Drilling

■ Features of the Magic Drill (DRX) Chipbreakers

Chipbreaker			GM	GH	SM
Insert					
Advantages			1st. recommendation for carbon steel and alloy steel, 1st. recommendation for cast iron.	1st. recommendation for interrupted machining and hard materials. Cutting edge strength oriented design.	Suitable for sticky materials such as stainless steel and low carbon steel
			Good balance of sharp cutting and cutting edge strength	Middle to high feed rates of steel machining, GM Chipbreaker alternative	Sharp cutting, prevents chattering. For low to medium feed rates of steel.
Outer edge		Cross-section			
	Wide chipbreaker	Chips from Outer edge			
Inner edge		Cross-section			
	Flat chipbreaker	Chips from Inner edge			
Workpiece Materials			C50 (S50C)	C50 (S50C)	X5CrNi18 10 (SUS304)

Technical Information

■ Magic Drill (DRX) Recommended Cutting Conditions (Coolant)

Workpiece Material	Recommended Cutting Speed (SFM)				Cutting Dia. ØDc (inch)	Type (Drilling Depth)										
	PVD Coated		Carbide			2D~3D			4D			5D				
	PR1230	PR1225	PR1210	GW15		Feed Rate (ipr)										
	GM GH	SM	GM	SM		GM	GH	SM	GM	GH	SM	GM	GH	SM		
Low Carbon Steel	☆ 400 ~ 800	★ 400 ~ 800			Ø 0.432 ~ Ø 0.591	.0024 ~ .0039	.0024 ~ .0039	.0016 ~ .0039	.0020 ~ .0031	.0020 ~ .0031	.0016 ~ .0031	.0016 ~ .0028	.0016 ~ .0028	.0016 ~ .0031		
					Ø 0.630 ~ Ø 0.709	.0024 ~ .0047	.0024 ~ .0047	.0024 ~ .0047	.0020 ~ .0039	.0020 ~ .0039	.0020 ~ .0039	.0020 ~ .0031	.0020 ~ .0031	.0020 ~ .0039	.0020 ~ .0039	
					Ø 0.748 ~ Ø 1.024	.0031 ~ .0055	.0031 ~ .0055	.0024 ~ .0055	.0024 ~ .0047	.0031 ~ .0047	.0020 ~ .0047	.0024 ~ .0039	.0024 ~ .0039	.0020 ~ .0047	.0020 ~ .0047	
					Ø 1.063 ~ Ø 2.362	.0031 ~ .0055	.0031 ~ .0055	.0024 ~ .0055	.0024 ~ .0047	.0031 ~ .0047	.0020 ~ .0047	.0024 ~ .0039	.0024 ~ .0039	.0020 ~ .0047	.0020 ~ .0047	
Carbon Steel	★ 330 ~ 600	☆ 330 ~ 600			Ø 0.432 ~ Ø 0.591	.0016 ~ .0055	.0016 ~ .0055	.0016 ~ .0039	.0016 ~ .0039	.0016 ~ .0039	.0016 ~ .0031	.0016 ~ .0031	.0016 ~ .0031	.0016 ~ .0031		
					Ø 0.630 ~ Ø 0.709	.0024 ~ .0063	.0024 ~ .0063	.0024 ~ .0047	.0020 ~ .0047	.0020 ~ .0047	.0020 ~ .0039	.0020 ~ .0039	.0020 ~ .0039	.0020 ~ .0039		
					Ø 0.748 ~ Ø 1.024	.0031 ~ .0079	.0031 ~ .0079	.0024 ~ .0055	.0028 ~ .0063	.0028 ~ .0063	.0020 ~ .0047	.0024 ~ .0047	.0024 ~ .0047	.0020 ~ .0047	.0020 ~ .0047	
					Ø 1.063 ~ Ø 2.362	.0031 ~ .0079	.0031 ~ .0079	.0024 ~ .0055	.0028 ~ .0063	.0028 ~ .0063	.0020 ~ .0047	.0024 ~ .0047	.0024 ~ .0047	.0020 ~ .0047	.0020 ~ .0047	
Alloy Steel	★ 330 ~ 530	☆ 330 ~ 530			Ø 0.432 ~ Ø 0.591	.0016 ~ .0055	.0016 ~ .0055	.0016 ~ .0039	.0016 ~ .0039	.0016 ~ .0039	.0016 ~ .0031	.0016 ~ .0031	.0016 ~ .0031	.0016 ~ .0031		
					Ø 0.630 ~ Ø 0.709	.0024 ~ .0063	.0024 ~ .0063	.0024 ~ .0047	.0020 ~ .0047	.0020 ~ .0047	.0020 ~ .0039	.0020 ~ .0039	.0020 ~ .0039	.0020 ~ .0039		
					Ø 0.748 ~ Ø 1.024	.0031 ~ .0079	.0031 ~ .0079	.0024 ~ .0055	.0028 ~ .0063	.0028 ~ .0063	.0020 ~ .0047	.0024 ~ .0047	.0024 ~ .0047	.0020 ~ .0047	.0020 ~ .0047	
					Ø 1.063 ~ Ø 2.362	.0031 ~ .0079	.0031 ~ .0079	.0024 ~ .0055	.0028 ~ .0063	.0028 ~ .0063	.0020 ~ .0047	.0024 ~ .0047	.0024 ~ .0047	.0020 ~ .0047	.0020 ~ .0047	
Tool Steel	★ 270 ~ 500	☆ 270 ~ 500			Ø 0.432 ~ Ø 0.591	.0016 ~ .0031	.0016 ~ .0031	.0016 ~ .0031	.0016 ~ .0028	.0016 ~ .0028	.0016 ~ .0028	.0016 ~ .0024	.0016 ~ .0024	.0016 ~ .0028		
					Ø 0.630 ~ Ø 0.709	.0024 ~ .0047	.0024 ~ .0047	.0024 ~ .0039	.0020 ~ .0039	.0020 ~ .0039	.0020 ~ .0031	.0016 ~ .0031	.0016 ~ .0031	.0020 ~ .0031	.0020 ~ .0031	
					Ø 0.748 ~ Ø 1.024	.0031 ~ .0059	.0031 ~ .0059	.0024 ~ .0047	.0024 ~ .0047	.0024 ~ .0047	.0024 ~ .0039	.0020 ~ .0039	.0020 ~ .0039	.0020 ~ .0039	.0024 ~ .0039	.0024 ~ .0039
					Ø 1.063 ~ Ø 2.362	.0031 ~ .0059	.0031 ~ .0059	.0024 ~ .0047	.0024 ~ .0047	.0024 ~ .0047	.0024 ~ .0039	.0020 ~ .0039	.0020 ~ .0039	.0020 ~ .0039	.0024 ~ .0039	.0024 ~ .0039
Stainless Steel	☆ 240 ~ 470	★ 240 ~ 470			Ø 0.432 ~ Ø 0.591	.0024 ~ .0039	.0024 ~ .0039	.0016 ~ .0039	.0020 ~ .0031	.0020 ~ .0031	.0016 ~ .0031	.0016 ~ .0028	.0016 ~ .0031	.0016 ~ .0031		
					Ø 0.630 ~ Ø 0.709	.0024 ~ .0039	.0024 ~ .0039	.0024 ~ .0047	.0020 ~ .0031	.0020 ~ .0031	.0020 ~ .0043	.0016 ~ .0028	.0016 ~ .0028	.0020 ~ .0043	.0020 ~ .0043	
					Ø 0.748 ~ Ø 1.024	.0031 ~ .0047	.0031 ~ .0047	.0024 ~ .0055	.0028 ~ .0039	.0028 ~ .0039	.0024 ~ .0047	.0028 ~ .0039	.0028 ~ .0039	.0024 ~ .0047	.0024 ~ .0047	
					Ø 1.063 ~ Ø 2.362	.0031 ~ .0047	.0031 ~ .0047	.0024 ~ .0055	.0028 ~ .0039	.0028 ~ .0039	.0024 ~ .0047	.0028 ~ .0039	.0028 ~ .0039	.0024 ~ .0047	.0024 ~ .0047	
Gray Cast Iron			★ 330 ~ 500		Ø 0.432 ~ Ø 0.591	.0031 ~ .0055	-	-	.0024 ~ .0047	-	-	.0016 ~ .0039	-	-		
					Ø 0.630 ~ Ø 0.709	.0031 ~ .0071	-	-	.0031 ~ .0063	-	-	.0024 ~ .0047	-	-		
					Ø 0.748 ~ Ø 1.024	.0031 ~ .0079	-	-	.0031 ~ .0071	-	-	.0024 ~ .0055	-	-		
					Ø 1.063 ~ Ø 2.362	.0031 ~ .0079	-	-	.0031 ~ .0071	-	-	.0024 ~ .0055	-	-		
Nodular Cast Iron (Ductile)			★ 270 ~ 400		Ø 0.432 ~ Ø 0.591	.0031 ~ .0047	-	-	.0024 ~ .0039	-	-	.0016 ~ .0031	-	-		
					Ø 0.630 ~ Ø 0.709	.0031 ~ .0063	-	-	.0031 ~ .0055	-	-	.0024 ~ .0039	-	-		
					Ø 0.748 ~ Ø 1.024	.0031 ~ .0071	-	-	.0031 ~ .0063	-	-	.0024 ~ .0047	-	-		
					Ø 1.063 ~ Ø 2.362	.0031 ~ .0071	-	-	.0031 ~ .0063	-	-	.0024 ~ .0047	-	-		
Non-Ferrous Metal			★ 660 ~ 1980		Ø 0.432 ~ Ø 0.591	-	-	.0024 ~ .0047	-	-	.0020 ~ .0039	-	-	.0016 ~ .0031		
					Ø 0.630 ~ Ø 0.709	-	-	.0031 ~ .0055	-	-	.0024 ~ .0047	-	-	.0020 ~ .0039		
					Ø 0.748 ~ Ø 1.024	-	-	.0031 ~ .0063	-	-	.0024 ~ .0055	-	-	.0020 ~ .0047		
					Ø 1.063 ~ Ø 2.362	-	-	.0031 ~ .0079	-	-	.0031 ~ .0063	-	-	.0028 ~ .0055		
Titanium Alloy			★ 140 ~ 240		Ø 0.432 ~ Ø 0.591	-	-	.0020 ~ .0031	-	-	.0016 ~ .0028	-	-	.0016 ~ .0024		
					Ø 0.630 ~ Ø 0.709	-	-	.0020 ~ .0031	-	-	.0016 ~ .0028	-	-	.0016 ~ .0024		
					Ø 0.748 ~ Ø 1.024	-	-	.0024 ~ .0039	-	-	.0024 ~ .0031	-	-	.0020 ~ .0028		
					Ø 1.063 ~ Ø 2.362	-	-	.0024 ~ .0039	-	-	.0024 ~ .0031	-	-	.0020 ~ .0028		

• Apply sufficient amount of coolant

★ : 1st Recommendation ☆ : 2nd Recommendation



Technical Information

Drilling

DRX Hole Bottom Shape

● Magic Drill (DRX) Hole Bottom Shape (Available for 2xD, 3xD, 4xD and 5xD type) (mm)

ØDc	A	B	C	ØDc	A	B	C	ØDc	A	B	C		
12.0	1.8	4.2	0.5	24.5	3.2	9.1	0.8	39.0	5.8	13.7	1.5		
12.5		4.5		25.0		9.3		40.0		14.2			
13.0		4.7		25.5		9.6		41.0		14.7			
13.5		4.8		26.0		9.8		42.0		15.2			
14.0	2	5.0	0.5	26.5	3.9	9.4	1.0	43.0		15.7			
14.5		5.3		27.0		9.6		44.0		16.2			
15.0		5.5		27.5		9.9		45.0		16.7			
15.5		5.8		28.0		10.1		46.0		17.2			
16.0		6.0		28.5		10.4		47.0		17.7			
16.5		6.3		29.0		10.6		48.0		16.9			
17.0		6.5		29.5		10.9		49.0		17.4			
17.5		6.8		30.0		11.1		50.0		17.9			
18.0	2.4	7.0	0.6	30.5	4.7	11.4	1.1	51.0	18.4				
18.5		6.9		31.0		11.6		52.0	18.9				
19.0		7.1		31.5		11.9		53.0	19.4				
19.5		7.4		32.0		11.3		54.0	19.9				
20.0		7.6		33.0		11.8		55.0	20.4				
20.5		7.9		34.0		12.3		56.0	20.9				
21.0		8.1		35.0		12.8		57.0	21.4				
21.5		8.4		36.0		13.3		58.0	21.9				
22.0		3.2		7.8		0.8		37.0	4.7	13.8	1.2	59.0	22.4
22.5				8.1				38.0		14.3		60.0	22.9
23.0	8.3												
23.5	8.6												
24.0	8.8												

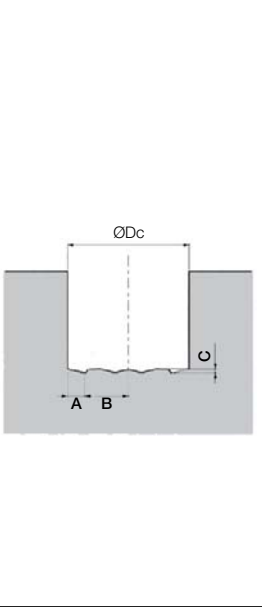









Chart above is for 2xD, 3xD, 4xD, and 5xD drills.
 * Figure above is nominal sizes.
 (Varies from -0.004" to +0.004" depending on work material and cutting conditions)

DRX Cutting Conditions by Application

Application	Plain Surface	Slant Surface	Half Clindrical	Hole Expansion	Concave Surface	Pre-drilled Surface	Stacked Plates
Workpiece Shape							
DRX	Cutting Speed (SFM)	400	400	400	400	See Coremaster Coredrill ➔ Page 62	See Holeshoot Drill ➔ Page 54
	Feed Rate(ipr)	.004	.002	.002	.002		
Coolant	Yes	Yes	Yes	Yes	Yes	Yes	-



Technical Information

Drilling





Technical Information

Drilling

■ Magic Drill (DRC) Recommended Cutting Conditions

Workpiece Material		Hardness (HB)	Cutting Condition		Cutting Dia. ØDc(inch)						
			Cutting Speed Vc(SFM)	Spindle Revolution (min ⁻¹) Feed Rate (ipr)	Ø0.315	Ø0.3937	Ø0.4724	Ø0.5512	Ø0.6300	Ø0.7087	Ø0.7874
Low Carbon Steel	1010~1025	125	400 - 600	Spindle Revolution(min ⁻¹)	4,780 - 7,170	3,820 - 5,730	3,180 - 4,780	2,730 - 4,090	2,390 - 3,580	2,120 - 3,180	1,910 - 2,870
				Feed Rate(ipr)	.0043 - .0079	.0051 - .0094	.0055 - .0110	.0067 - .0125	.0075 - .0138	.0091 - .0150	.0098 - .0161
Carbon Steel	1030~1060 (Annealed)	190	330 - 500	Spindle Revolution(min ⁻¹)	3,980 - 5,970	3,180 - 4,780	2,650 - 3,980	2,270 - 3,410	1,990 - 2,990	1,770 - 2,650	1,590 - 2,390
				Feed Rate(ipr)	.0051 - .0094	.0059 - .0114	.0067 - .0130	.0075 - .0142	.0087 - .0161	.0098 - .0181	.0110 - .0189
	1030~1060 (Heat treated)	250	260 - 400	Spindle Revolution(min ⁻¹)	3,180 - 4,780	2,550 - 3,820	2,120 - 3,180	1,820 - 2,730	1,590 - 2,390	1,420 - 2,120	1,270 - 1,910
				Feed Rate(ipr)	.0051 - .0083	.0059 - .0098	.0071 - .0122	.0083 - .0154	.0091 - .0177	.0098 - .0209	.0110 - .0240
		300	170 - 250	Spindle Revolution(min ⁻¹)	1,990 - 2,990	1,590 - 2,390	1,330 - 1,990	1,140 - 1,710	1,000 - 1,490	880 - 1,330	800 - 1,190
				Feed Rate(ipr)	.0043 - .0075	.0047 - .0091	.0063 - .0110	.0083 - .0126	.0091 - .0138	.0098 - .0161	.0110 - .0161
Alloy Steel	4137, 5132 (Annealed)	180	230 - 310	Spindle Revolution(min ⁻¹)	2,790 - 3,780	2,230 - 3,030	1,860 - 2,520	1,590 - 2,160	1,390 - 1,890	1,240 - 1,680	1,110 - 1,510
				Feed Rate(ipr)	.0059 - .0110	.0063 - .0138	.0083 - .0146	.0091 - .0181	.0098 - .0181	.0098 - .0201	.0118 - .0201
	4137, 5132 (Heat treated)	275	230 - 310	Spindle Revolution(min ⁻¹)	2,790 - 3,780	2,230 - 3,030	1,860 - 2,520	1,590 - 2,160	1,390 - 1,890	1,240 - 1,680	1,110 - 1,510
				Feed Rate(ipr)	.0043 - .0083	.0055 - .0098	.0075 - .0118	.0083 - .0130	.0091 - .0146	.0110 - .0169	.0110 - .0181
		300	200 - 300	Spindle Revolution(min ⁻¹)	2,390 - 3,580	1,910 - 2,870	1,590 - 2,390	1,360 - 2,050	1,190 - 1,790	1,060 - 1,590	960 - 1,430
				Feed Rate(ipr)	.0043 - .0075	.0047 - .0091	.0063 - .0102	.0071 - .0122	.0083 - .0130	.0091 - .0142	.0098 - .0150
	350	170 - 250	Spindle Revolution(min ⁻¹)	1,990 - 2,990	1,590 - 2,390	1,330 - 1,990	1,140 - 1,710	1,000 - 1,490	880 - 1,330	800 - 1,190	
			Feed Rate(ipr)	.0043 - .0079	.0047 - .0091	.0063 - .0098	.0067 - .0114	.0071 - .0126	.0079 - .0142	.0091 - .0150	
Stainless Steel	304 316	220	200 - 260	Spindle Revolution(min ⁻¹)	2,390 - 3,180	1,910 - 2,550	1,590 - 2,120	1,360 - 1,820	1,190 - 1,590	1,060 - 1,420	960 - 1,270
				Feed Rate(ipr)	.0043 - .0075	.0047 - .0091	.0063 - .0102	.0071 - .0122	.0083 - .0130	.0091 - .0142	.0098 - .0150
	S17400	300	170 - 230	Spindle Revolution(min ⁻¹)	1,990 - 2,790	1,590 - 2,230	1,330 - 1,860	1,140 - 1,590	1,000 - 1,390	880 - 1,240	800 - 1,110
				Feed Rate(ipr)	.0043 - .0079	.0047 - .0091	.0063 - .0098	.0067 - .0114	.0071 - .0126	.0079 - .0142	.0091 - .0150
Gray Cast Iron	No.30~35	180	400 - 560	Spindle Revolution(min ⁻¹)	4,780 - 6,770	3,820 - 5,410	3,180 - 4,510	2,730 - 3,870	2,390 - 3,380	2,120 - 3,010	1,910 - 2,710
				Feed Rate(ipr)	.0067 - .0126	.0079 - .0146	.0091 - .0169	.0106 - .0189	.0118 - .0217	.0130 - .0240	.0130 - .0240
	No.45~60	260	300 - 400	Spindle Revolution(min ⁻¹)	3,580 - 4,780	2,870 - 3,820	2,390 - 3,180	2,050 - 2,730	1,790 - 2,390	1,590 - 2,120	1,430 - 1,910
				Feed Rate(ipr)	.0055 - .0098	.0063 - .0122	.0075 - .0138	.0091 - .0165	.0102 - .0185	.0110 - .0209	.0118 - .0228
Nodular Cast Iron	60-40-18-70-50-05	160	200 - 300	Spindle Revolution(min ⁻¹)	2,390 - 3,580	1,910 - 2,870	1,590 - 2,390	1,360 - 2,050	1,190 - 1,790	1,060 - 1,590	960 - 1,430
				Feed Rate(ipr)	.0055 - .0098	.0063 - .0118	.0075 - .0138	.0087 - .0157	.0094 - .0177	.0110 - .0201	.0110 - .0220
	80-60-03-120-90-02	250	130 - 210	Spindle Revolution(min ⁻¹)	1,590 - 2,590	1,270 - 2,070	1,060 - 1,730	910 - 1,480	800 - 1,290	710 - 1,150	640 - 1,040
				Feed Rate(ipr)	.0039 - .0075	.0047 - .0087	.0055 - .0098	.0063 - .0122	.0075 - .0138	.0091 - .0201	.0098 - .0209

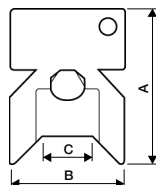
■ Wrench for Installing Inserts

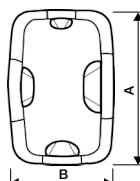
Shape		Description	Dimension (inch)			Remarks
			A	B	C	
		WDCR8	1.69	1.30	Ø0.402	 <p>Description is printed in this area.</p>
		WDCR10			Ø0.480	
		WDCR12			Ø0.559	
		WDCR14			Ø0.677	
		WDCR17	3.03	2.05	-	<ul style="list-style-type: none"> •WDCR17(Multiple type wrench) has four insert entry points. If using an insert ranging from DC06692-SC to DC08264-SC, use the entry point printed as Ø0.6692"~Ø0.8264". •WDCR17 can be used instead of WDCR8~14 wrench.

Method to change DRC Type Magic Drill Inserts

● How to Attach Inserts



- 1) Fix drill holder on arbor. For insert exchange, fix arbor on the machine or set on tool presetter.
- 2) Remove dust using air blower.



- 3) Install insert onto holder.
(Use gloves to protect your hand from any danger.)



- 4) Turn lightly in a clockwise direction.
(Use gloves to protect your hand from any danger.)



- 5) Align the wrench properly with the insert.



- 6) Make sure the wrench is aligned with the wrench slots on the insert.

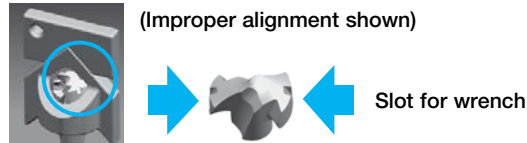

- 7) Turn the wrench in a slow clockwise direction.
- 8) Completed.

● How to Detach Inserts

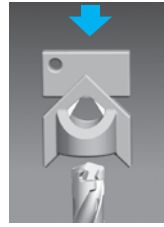

- 1) Remove dust from insert using air blower.
- 2) Align the wrench properly with the insert.



- 3) Make sure the wrench is aligned with the wrench slots on the insert.



- 4) Turn the wrench in a counterclockwise direction.

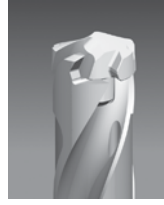

- 5) Once lock is released, insert can be turned by fingers.
(Use gloves to protect your hand from any danger.)

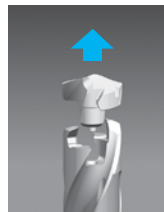

- 6) Remove insert.
(Use gloves to protect your hand from any danger.)

■ Coolant

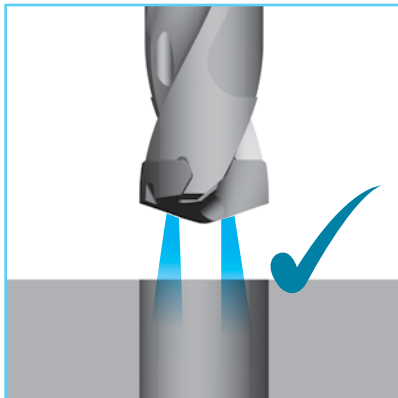

- 1) Internal coolant is recommended.



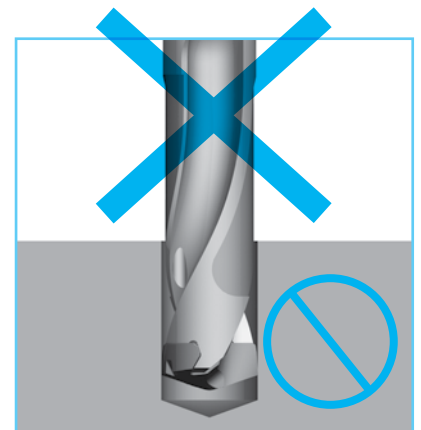

- 2) In case of external coolant
Cutting depth must be 3xD or less.



- 3) Dry cutting is not recommended.

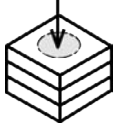
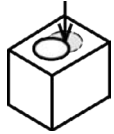

Applicable Workpieces

Application	Workpiece Shape	Caution for machining
Flat Face		<ol style="list-style-type: none"> 1. Due to good chip control, peck drilling is not necessary for soft steel like 1015. 2. When machining 304, for hole depths of more than 2.5D, utilize the step machining process. 3. In order to have smooth chip removal, we recommend internal coolant.
Stacked Plates		<ol style="list-style-type: none"> 1. Fix stacked plates securely to ensure they do not slip while machining.
Hole Expansion		<ol style="list-style-type: none"> 1. If the overlap amount is less than $1/3 \times D$, machining is possible.
Concave Surface		<ol style="list-style-type: none"> 1. When machining concave holes set the feed rates at half or less than continuous hole machining.
Pipe Material		<ol style="list-style-type: none"> 1. Hole machining above the centerline of the pipe is possible. 2. Do not machine on curved surface areas.

Precautions for Use

Core Deviation

1) If drill is stationary

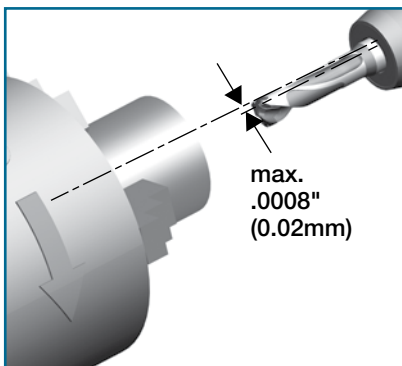

The max runout between the drill and spindle should not exceed 0.0008.

2) If drill is rotating

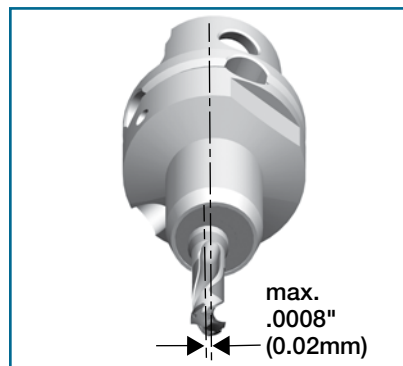

The max runout allowable on the drill is 0.0008

Not Recommended Workpieces

Application	Workpiece Shape
Slanted Surface	

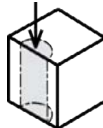
Application	Workpiece Shape
Half Cylindrical	

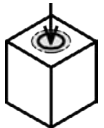
Application	Workpiece Shape
Cored Hole	





Case Studies

1049	
<ul style="list-style-type: none"> • Flange • $V_c=97\text{m/min}$ ($n=2,490\text{min}^{-1}$) • $H=32\text{mm}$ • $f=0.3\text{mm/rev}$ ($V_f=747\text{mm/min}$) • Wet (Internal Coolant) • DC1250M-SC (PR0315) 	
SS14-DRC120M-3	3,000holes/insert
Competitor A	1,800holes/drill
<p>Compared to competitor's drill A, MagicDrill DRC type has reduced burr and reduced more than 10% of the power required. Tool life has also improved greatly.</p>	

4140	
<ul style="list-style-type: none"> • Housing • $V_c=83\text{m/min}$ ($n=2,400\text{min}^{-1}$) • $H=32\text{mm}$ • $f=0.24\text{mm/rev}$ ($V_f=576\text{mm/min}$) • Wet (Internal Coolant) • DC1100M-SC (PR0315) 	
SS12-DRC110M-3	more than 2,400holes/insert
Competitor B	2,000holes/drill
<p>Compared to competitor's solid drill B, MagicDrill DRC type has greatly reduced preparation time with its easy insert replacement feature. Also, the costs of spare tools for re-grinding has been reduced, and tool life has improved.</p>	

Reference Charts

<Cutting Condition>

Heat treated steel (Hardness 240HB) $V_c=80\text{m/min}$, Wet

● Power required

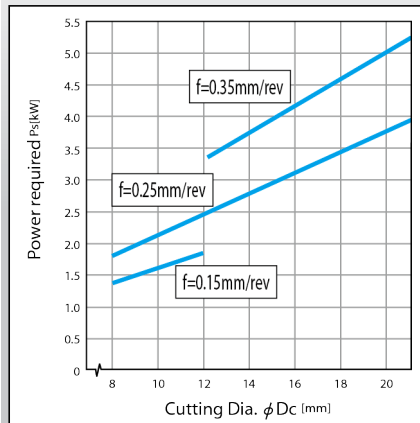

● Thrust force

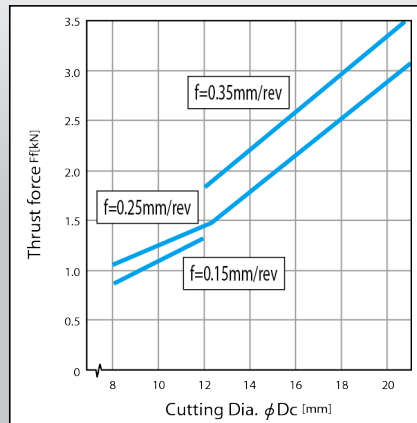

● Torque

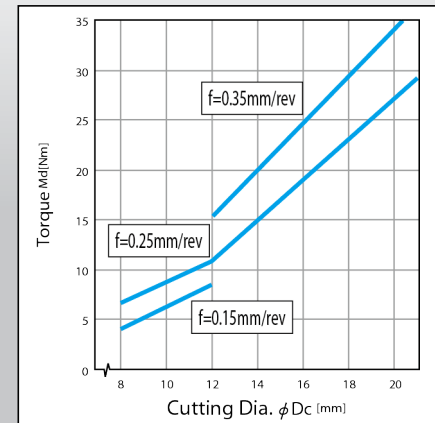

Q&A

Q-1 Is re-grinding available?

A-1 We don't recommend it. Grinding of edge nose chisel is not possible.

Q-2 How large would the cutting hole be to the insert diameter (ϕD_c)?

A-2 When drilling 4137, the hole diameter will be about 0.020 to 0.040 larger than the insert diameter.

■ Holeshot Drill (DR) Applications

DRILL APPLICATION HOLESHOT INDEXABLE DRILL

STATIONARY

For stationary (lathe) applications the drill should be mounted in a toolholder that is concentric within 0.003 TIR and parallel to the machine centerline. Flats on the shank should be precisely aligned so that the cutting edges are parallel to the x-axis, which will help chip flow.

A disc is normally produced as the drill breaks through the hole. Although the disc is usually minimal with HOLESHOT, adequate guarding should be provided for and in place.

HOLESHOT drills can be used to back bore an existing hole to a desired size. The drill can be offset by up to 0.015" for back boring.

ROTATING

Make certain the spindle is rigid with minimal runout. Since both machine and fixture rigidity are key factors, make sure the workpiece is fixed rigidly and secured. Mount drill for the least possible overhang and make sure the drill flange is flush against the face of the adapter.

Coolant - Chip removal and tool life are enhanced by feeding coolant through the drill. 30 P.S.I. minimum coolant pressure is recommended for horizontal applications. Vertical position requires a higher coolant pressure (40 to 60 P.S.I.) to flush chips properly.

Through the tool coolant is preferred for HOLESHOT drilling, but due to the unique flute design, coolant deficiencies can be overcome. Especially in smaller, lower horsepower machine tools, strong flood coolant can be utilized with excellent results. When flooding the cut, direct coolant directly into the drilling area.



■ Recommended Cutting Conditions : Holeshot Drill (DR)

Workpiece Material	Feed Rate (ipr)	Recommended Cutting Condition (Cutting Speed SFM)						Remarks	
		Cermet	PVD Coated				MEGACOAT		Carbide
		TN60	PR660	PR830	PR905	PR915	PR1230		KW10
Low Carbon Steel	.0015-.0035	-	☆ 800~900	☆ 800~900	-	-	★ 800~900	-	Coolant
Carbon Steel	.005-.009	-	☆ 400~800	☆ 400~800	-	-	★ 400~800	-	
Alloy Steel	.004-.010	-	☆ 250~750	☆ 250~750	-	-	★ 250~750	-	
Tool Steel	.004-.010	-	☆ 250~750	☆ 250~750	-	-	★ 250~750	-	
Stainless Steel (Austenitic)	.0025-.006	-	☆ 200~600	☆ 200~600	-	-	★ 200~600	-	
Gray Cast Iron	.005-.011	-	-	-	★ 400~800	-	-	☆ 400~800	
Nodular Cast Iron (Ductile)	.004-.010	-	-	-	★ 300~500	-	-	☆ 300~500	
Non-ferrous Metal	.008-.010	☆ 1800~2000	-	-	-	-	-	★ 1800~2000	
Heat Resistant Alloy (Inconel 718)	.0010-.0015	-	-	☆ 75~150	-	☆ 100~150	★ 75~150	-	
Titanium Alloy	.0025-.0030	-	-	-	★ 100~210	★ 100~210	-	☆ 150~250	

★ : 1st Recommendation ☆ : 2nd Recommendation



Recommended Cutting Conditions : Coremaster Coredrill (CD)

Workpiece Material	Feed Rate (ipr)	Recommended Cutting Condition (Cutting Speed SFM)							Remarks
		Cermet	PVD Coated				MEGACOAT	Carbide	
		TN60	PR660	PR830	PR905	PR915	PR1230	KW10	
Low Carbon Steel	.0015-.0035	-	☆ 800~900	☆ 800~900	-	-	★ 800~900	-	Coolant
Carbon Steel	.005-.009	-	☆ 400~800	☆ 400~800	-	-	★ 400~800	-	
Alloy Steel	.004-.010	-	☆ 250~750	☆ 250~750	-	-	★ 250~750	-	
Tool Steel	.004-.010	-	☆ 250~750	☆ 250~750	-	-	★ 250~750	-	
Stainless Steel (Austenitic)	.0025-.006	-	☆ 200~600	☆ 200~600	-	-	★ 200~600	-	
Gray Cast Iron	.005-.011	-	-	-	★ 400~800	-	-	☆ 400~800	
Nodular Cast Iron (Ductile)	.004-.010	-	-	-	★ 300~500	-	-	☆ 300~500	
Non-ferrous Metal	.008-.010	☆ 1800~2000	-	-	-	-	-	★ 1800~2000	
Heat Resistant Alloy (Inconel 718)	.0010-.0015	-	-	☆ 75~150	-	☆ 100~150	★ 75~150	-	
Titanium Alloy	.0025-.0030	-	-	-	★ 100~210	★ 100~210	-	☆ 150~250	

★ : 1st Recommendation ☆ : 2nd Recommendation

Recommended Cutting Conditions : Mini-Magic Drill (DRS)

Workpiece Material	Feed Rate (ipr)	Recommended Grade (sfm)		
		MEGACOAT		PVD Coated Carbide
		PR1230	PR1210	PR660
Low Carbon Steel	.0024	★ 270~330	-	☆ 270~330
Carbon Steel	.003~.004	★ 270~330	-	☆ 270~330
Alloy Steel	.0016~.0024	★ 270	-	☆ 270
Mold Steel	.0016~.0024	★ 270	-	☆ 270
Stainless Steel (Austenitic related)	.002~.0024	★ 230~270	-	☆ 230~270
Gray Cast Iron	.003~.004	-	★ 80~100	-

Technical Information

Recommended Cutting Conditions : Stinger Drill (SDR)

Material	Condition	Insert Grade*	SFM	FPT
Copper		TN60	900-2000	0.001-0.003
		KW10	800-1900	0.001-0.003
High Temp Alloys		PR830	75-125	0.0005-0.0008
Stainless Steel	17-4	PR830	450	0.0009-0.0012
	300 Series	CA2335	300-500	0.0012-0.0015
		PR830	400-600	0.0012-0.0015
	304	CA2335	300-600	0.0008-0.0012
		PR830	400-700	0.0008-0.0012
	400 Series	CA2335	400-600	0.0012-0.0015
PR830		500-700	0.0012-0.0015	
Steel, Low Carbon	Annealed	TN60	600-900	0.0012-0.0018
		PR830	500-700	0.0012-0.0018
	Carburized, 35-50 Rc	TN60	300-400	0.0012-0.0018
		PR830	250-350	0.0012-0.0018
Steel, Medium Carbon	17-32 Rc	TN60	500-700	0.0012-0.003
		PR830	400-600	0.0012-0.003
Titanium Alloys		KW10	150-250	0.0008-0.0012
Tool Steel	Annealed	TN60	350-450	0.001-0.0015
		TN60	150-250	0.0007-0.0012
4130, 4140, 4150	Annealed	TN60	500-700	0.0012-0.003
	35-50 Rc	PR830	400-600	0.0012-0.003
6150	Annealed	TN60	500-600	0.0012-0.0015
		PR830	400-600	0.0012-0.0015
Aluminum		TN60	1000+	0.002-0.006
		KW10	900-1800	0.002-0.006
Brass		TN60	900-1500	0.001-0.003
		KW10	800-1400	0.001-0.003
Bronze		TN60	500-900	0.001-0.003
		KW10	400-600	0.001-0.003
Cast Iron	Gray	TN60	500-900	0.001-0.003
		KW10	300-500	0.001-0.003
		CA2335	300-500	0.001-0.003
	Nodular (Ductile)	TN60	500-700	0.001-0.003
		KW10	300-500	0.001-0.003
		CA2335	350-450	0.001-0.0022
	Malleable	TN60	400-800	0.001-0.003
		KW10	300-500	0.001-0.003
		CA2335	300-500	0.001-0.003

*Unless noted, use the same grade insert in all pockets



Technical
Information

Drilling

■ Drilling & Core Drilling Basic Formulas

DRILLING

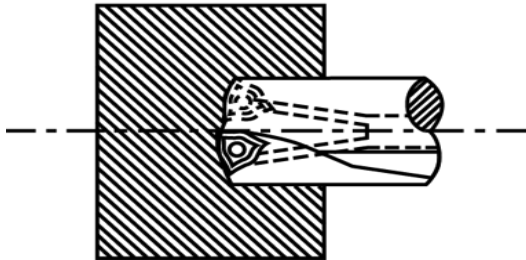

CORE DRILLING

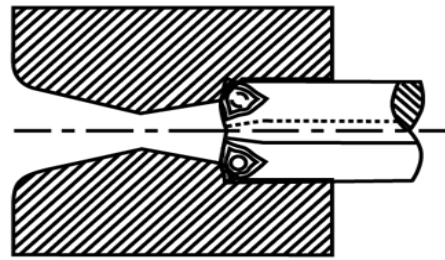

SURFACE SPEED PER MINUTE

$$\text{SFM} = 0.262 \times \text{DIA} \times \text{RPM}$$

REVOLUTIONS PER MINUTE

$$\text{RPM} = \frac{3.82 \times \text{SFM}}{\text{DIA}}$$

FEEDRATE (inches per minute)

$$\text{IPM} = \text{IPR} \times \text{RPM}$$

FEEDRATE (inches per revolution)

$$\text{IPR} = \text{IPT} \times \text{N}$$

METAL REMOVAL RATE (in³ per minute)

$$\text{DRILL: } Q = 3 \times \text{DIA} \times \text{IPR} \times \text{SFM}$$

$$\text{COREDRILL: } Q = 12 \times \text{DOC} \times \text{IPR} \times \text{SFM}$$

HORSEPOWER REQUIRED AT THE SPINDLE

$$\text{HPS} = Q \times \text{UHP}$$

HORSEPOWER REQUIRED AT THE MOTOR

$$\text{HPM} = \frac{\text{HPS}}{\text{EFF}}$$

TIME IN CUT

$$T = \frac{15.7 \times \text{DIA} \times \text{LOC}}{\text{SFM} \times \text{IPR}}$$

or

$$T = \frac{60 \times \text{LOC}}{\text{IPM}}$$



■ Definition of Terms

DIA = DIAMETER OF THE DRILL (INCHES)

DOC = DEPTH OF CUT (INCHES)

EFF = MACHINE EFFICIENCY

HPM = HORSEPOWER AT MOTOR

HPS = HORSEPOWER AT SPINDLE

IPM = FEEDRATE (INCHES PER MINUTE)

IPR = FEEDRATE (INCHES PER REVOLUTION)

IPT = CHIPLOAD (INCHES PER TOOTH)

LOC = LENGTH OF CUT (INCHES)

N = NUMBER OF EFFECTIVE FLUTES

N = 1 FOR DRILLS

N = 2 FOR COREDRILLS

Q = METAL REMOVAL RATE (CUBIC INCHES PER MINUTE)

RPM = REVOLUTIONS PER MINUTE

SFM = SURFACE SPEED (FEET PER MINUTE)

T = TIME (SECONDS)

UHP = UNIT HORSEPOWER (SEE TABLE BELOW)

UNIT HORSEPOWER FACTORS					
Material	Hardness (BHN)	UHP Factor (HP/in ³ /min)	Material	Hardness (BHN)	UHP Factor (HP/in ³ /min)
Aluminum	---	0.25	1050	225	0.80
Brass	---	0.25	4140	275	0.70
Copper	---	0.30	52100	225	0.67
Gray Cast Iron	200	0.33	6150	375	1.30
Nodular Iron	225	0.54	Cast Steel	225	0.62
Inconel 700	330	1.10	Stainless Steel	225	0.73
1020	165	0.58			

Technical Information

Drilling Troubleshooting



Technical Information

Drilling

Trouble	Trouble Item	Check Item		Grade Selection		Cutting Conditions		Tool Geometry			Setting			Machine			
		Measures	Change to Harder Grade	Change to Tougher Grade	Vc	f	Coolant Discharge Condition	Chipbreaker Review	Inner Edge's Center Height Check (Core Dia. Check)	Tool Rigidity Improvement (Short Type)	Workpiece / Tool Installation	Insert Installation	Offset Check (Lathe Operation Only)	Adjustable Sleeve Usage	Power, Rigidity		
																Higher (Larger) ↑ Lower (Smaller) ↓	Larger ↑ Smaller ↓
Edge Damage	Unusual Wear	Unsuitable Cutting Speed (too high)	●		● ↓												
		Unsuitable Cutting Speed (too low)		●	● ↑												
		Unsuitable Coolant Discharge						●									
		Poor Rigidity of Machine / Workpiece									●						●
		Small Hole Dia.											●	●			
	Inner Edge Cracking	Unsuitable Tool Grade	●														
		No core, Too Small Core								● ↑							
		Poor Rigidity of Machine / Workpiece									●	●					●
		Unstable Drilling Start					● ↓										
		High Hardness Workpiece	●			● ↓	● ↓										
		Clogged Chips				● ↑				● ↓							
	Outer Edge Cracking	Unstable Insert Installation										●					
		Poor Rigidity of Machine / Workpiece									●						●
		Unstable Drilling Start					● ↓										
		High Hardness Workpiece	●			● ↓	● ↓										
Poor Chip Control			●		● ↑												
Toolholder, Others	Scratches on Tool Body	Poor Rigidity of Machine / Workpiece								●						●	
		Inaccurate Tool Installment										●	●				
		Clogged Chips				● ↑	● ↓										
	Poor Hole Dia. Accuracy / Surface Finish	Unstable Drilling Start					● ↓										
		Poor Rigidity of Machine / Workpiece									●						●
		Poor Rigidity of Toolholder									●	●					
		Inaccurate Tool Installment											●	●			
		Clogged Chips				● ↑	● ↓			● ↓							
		Large Core Dia.								● ↓							
	Large Chattering / Vibration	Unstable Drilling Start					● ↓										
		Unsuitable Coolant Discharge						●									
	Long Chips	Unsuitable Cutting Conditions, Installation				● ↑	● ↓				●	●					●
		Unsuitable Cutting Conditions				● ↑											
	Machine Failure	Unsuitable Chipbreaker							●								
		Lack of Machine Power				● ↓	● ↓		●								●



ADVANCING PRODUCTIVITY

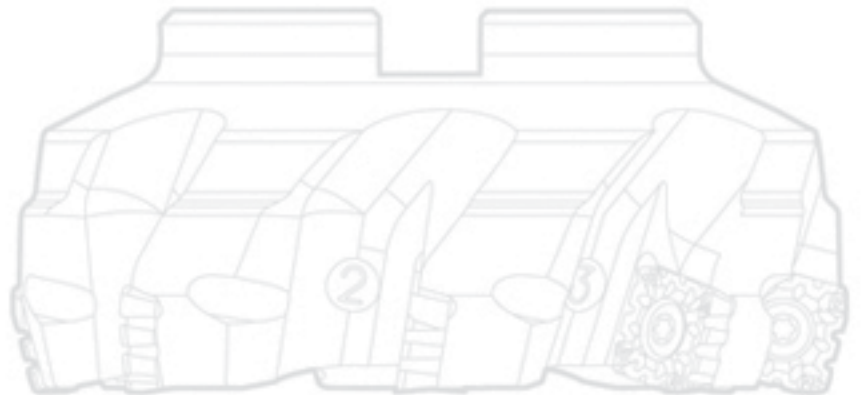

KYOCERA Industrial Ceramics Corporation

100 INDUSTRIAL PARK ROAD
HENDERSONVILLE, NC 28792 USA

PHONE: 800-823-7284

WEBSITE: <http://www.kyocera.com/cuttingtools> 

DISTRIBUTOR WEBSITE: <http://mykicc.kyocera.com> 

EMAIL: cuttingtools@kyocera.com