



Aerospace

Tooling Solutions



Providing Optimal Tooling Solutions for Aerospace Machining

- Airframe
- Engines
- Components
- Composites
- Aluminum
- Titanium

AEROSPACE SOLUTIONS



Airframe

- Fuselage
- Flap Tracks
- Engine Pylons
- Wing Spars
- Leading Edges
- Trailing Edges
- Stringers

Engines

- Blades & Vanes
- Stators
- Blisks
- Fan Casings
- Spools
- Turbine Discs
- Combustion Casings
- Hubs

Components

- Landing Gear
- Floor Panels
- Interiors
- Ducting
- Wheels & Brakes
- Hydraulics & Pneumatics
- Bearing Housings

AIRFRAME



- 1 Fuselage
- 2 Flap Track
- 3 Engine Pylon
- 4 Wing Spar
- 5 Leading Edge
- 6 Trailing Edge
- 7 Stringers

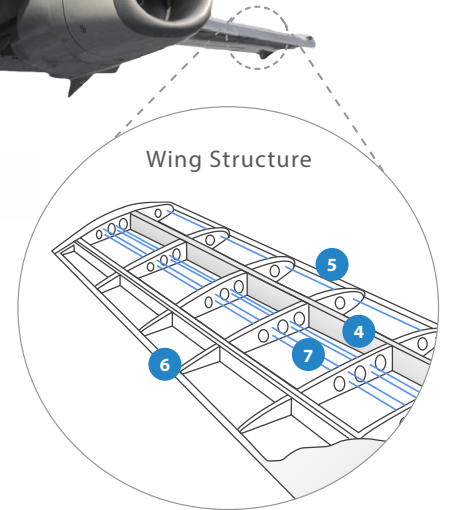

FUSELAGE

MACHINING CHALLENGE:

Small diameter drilling and milling can be a challenge in composite materials, where tools can become dull quickly. This can lead to burring and other poor quality finishes.



KYOCERA'S TOOLING SOLUTION:

Our up cut and down cut diamond pattern router bits and micro drills provide excellent repeatability when machining CFRP, fiberglass, and composite materials without burrs, splintering, or fraying.

CVD and DLC diamond coatings are available as well as the up cut chipbreaker pattern router bits for finer part edge finishes.

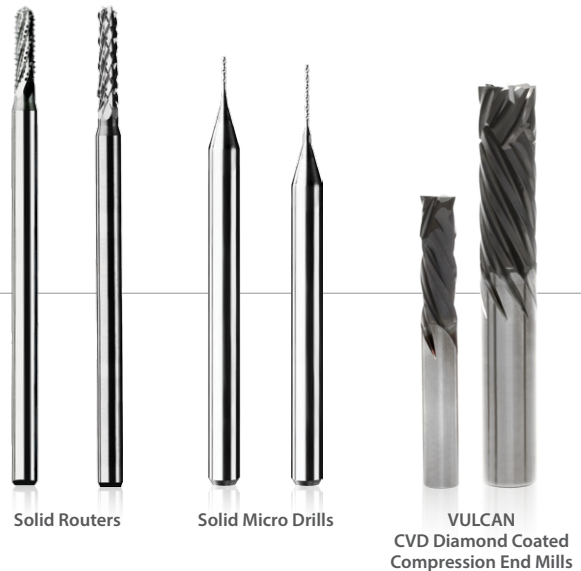

FLAP / SLAT TRACK

MACHINING CHALLENGE:

Pocket milling in difficult-to-cut materials, such as 15-5 PH or similar stainless steels. Chip evacuation is critical in order to prevent the potential re-cutting or pinching of the high-strength chips that have become trapped in the pockets.



KYOCERA'S TOOLING SOLUTION:

MFH-Raptor

High Feed Milling Cutters

MFH-Raptor Mini

Small Diameter End Mills for High Feed Machining

MEC

Ultra Hurricane End Mills & Face Mills

MFPN

Roughing and General Purpose Face Mill with 10 Usable Corners

MEWH

Helical End Mills

M-SIX (MFWN)

90° Double-Sided 6-Edge Milling Cutters



ENGINE PYLON

MACHINING CHALLENGE:

Rough milling of titanium, including heavy axial depths-of-cut in some slotting applications. Inserts with low cutting force designs can be employed in these applications to maximize metal removal.



KYOCERA'S TOOLING SOLUTION:

MFH-Raptor

High Feed Milling Cutters

MFH-Raptor Mini

Small Diameter End Mills for High Feed Machining

MEC

Ultra Hurricane End Mills & Face Mills

M-SIX (MFWN)

90° Double-Sided 6-Edge Milling Cutters

Grade PR1535

Grade for Titanium Alloy and Precipitation Hardened Stainless Steel



WING SPAR

MACHINING CHALLENGE:

Large Titanium parts require heavy stock removal. Cutters capable of high metal removal rates are required. Milling inserts with serrated edges can be utilized effectively in wing spar applications.

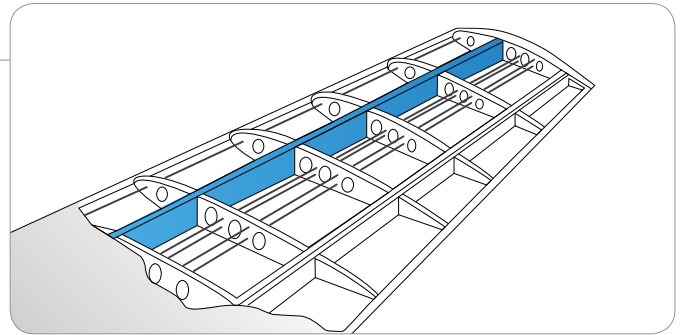

KYOCERA'S TOOLING SOLUTION:

MSR Monster Mill

Heavy Roughing Milling Cutter

MFH-Raptor

High Feed Milling Cutters

Grade PR1210

MEGACOAT Grade for Milling Titanium

Grade PR1535

MEGACOAT NANO Grade for Milling Titanium and Hardened Stainless Steel

Grade PR1510

MEGACOAT NANO Grade for Milling Titanium



MFH-Raptor



MSR

STRINGERS

MACHINING CHALLENGE:

Heavy stock removal on workpieces that are difficult to fixture. Milling tools capable of high metal removal rates while generating low cutting forces are preferred.

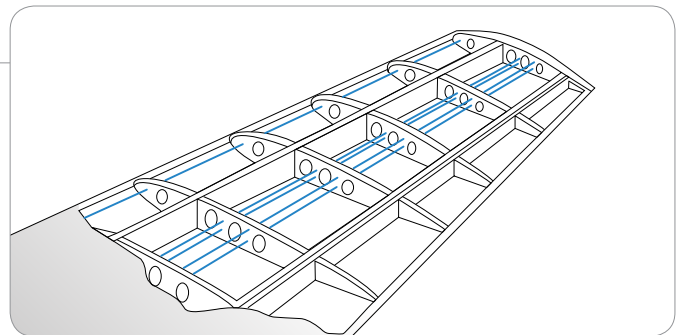

KYOCERA'S TOOLING SOLUTION:

MFH-Raptor

High Feed Milling Cutters

MEC

Ultra Hurricane End Mills & Face Mills

M-SIX (MFWN)

90° Double-Sided 6-Edge Milling Cutters

M-FOUR (MEW)

90° Double-Sided 4-Edge Milling Cutters



MEC



M-SIX
(MFWN)



M-FOUR
(MEW)



MFH-Raptor

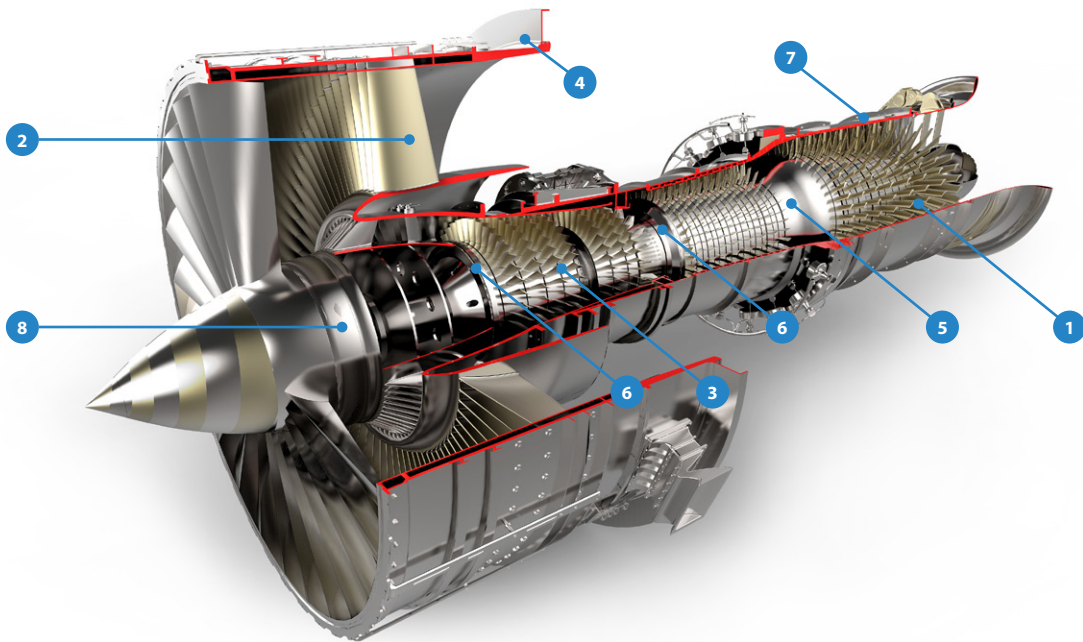

- 1 Blades & Vanes
- 2 Stators
- 3 Blisks
- 4 Fan Casing
- 5 Spools
- 6 Turbine Disc
- 7 Combustion Casing
- 8 Hub

BLADES & VANES

MACHINING CHALLENGE:

Thin cross sections create the challenge of chatter, especially when combined with limited work holding configurations. Cutters generating low cutting forces are required.



KYOCERA'S TOOLING SOLUTION:

RAD-6 (MRX)

Single-sided 6-Edge Radius (*Button*) Cutter

Grade CA6535

for Heat Resistant Alloys

RNG / RPG

Radius Inserts



RAD-6 (MRX)



CA6535



RNG



RPG

BLISKS & STATORS

MACHINING CHALLENGE:

Proper tooling is required to maximize the efficiency offered by advanced programming techniques. Variable helix end mills can be used effectively in these applications. Custom engineered solutions can also be used to improve efficiency.

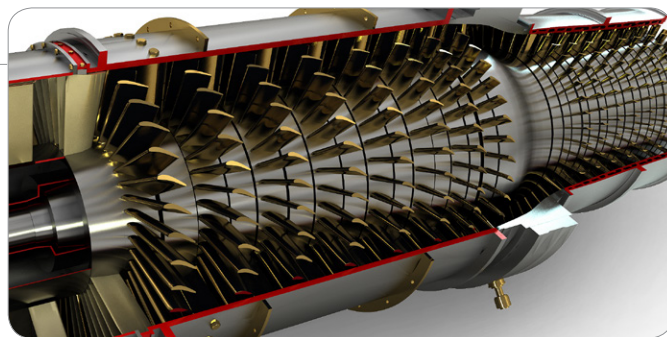

KYOCERA'S TOOLING SOLUTION:

APOLLO (AP4 & AP5)

Solid Carbide 4 Flute Variable Helix Solid End Mills

Engineered Solutions

Custom Engineered Tooling Solutions with Your Specifications

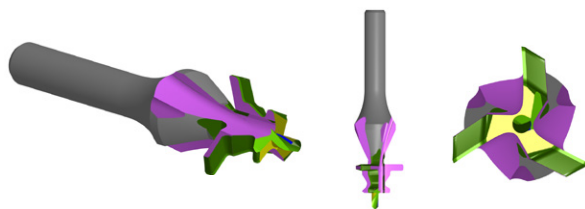

Custom Engineered
Tooling Solutions



Variable Helix APOLLO
End Mills

FAN CASING

MACHINING CHALLENGE:

The combination of component shape and material make the casing a challenging component to machine. Thin walls create work-holding obstacles that can lead to chatter when excessive tool pressure is present. The casing is traditionally manufactured from Titanium alloys, which present an inherent challenge for increased heat at the cutting edge and potential for edge build-up.

KYOCERA'S TOOLING SOLUTION:

RCMT43

Inserts

KGD Grooving

with GDM inserts

Grade PR1535

Grade for Titanium Alloy and Precipitation Hardened Stainless Steel



Grade GW15

Carbide for Heat Resistant Alloys

Grade PR13-Series

PVD Coated Carbide for Heat Resistant Alloys

Grade PR1515

PVD Coated Carbide for Heat Resistant Alloys

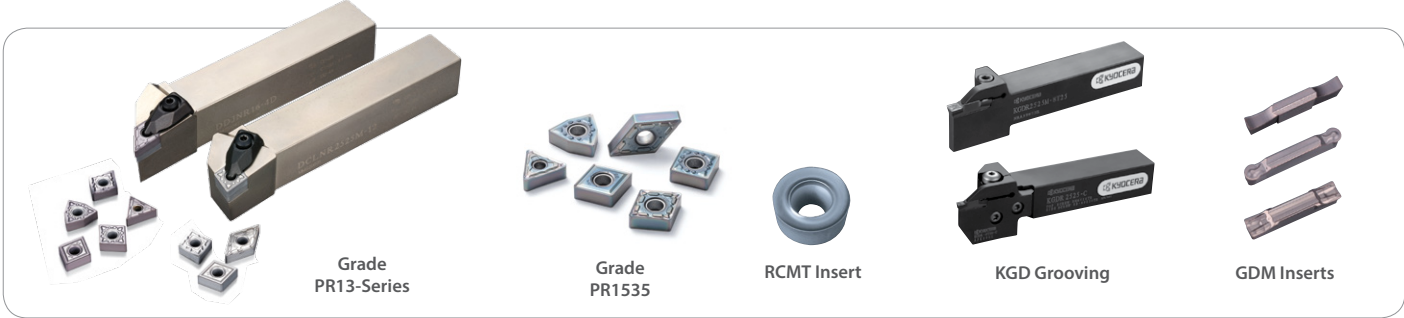

SPOOL

MACHINING CHALLENGE:

The jet engine spool is comprised of complex contours that require a high surface finish quality across the entire length of the OD and ID of this titanium part in order to pass ultrasonic inspections.

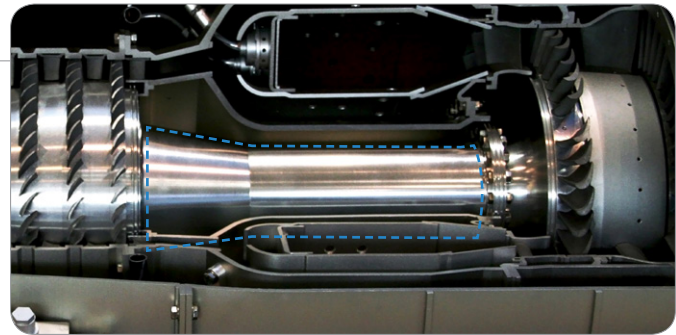

KYOCERA'S TOOLING SOLUTION:

RCGX

Inserts

RCMT

Inserts

KS6030 / KS6040 / KXW1

SiAlON Ceramic Grades for Heat Resistant Alloys

KGD Grooving System

with Full Radius Inserts

Grade PR1215 / PR1535

PVD PR1215 for Steel and PR1535 for Titanium, and Other HRAs

Grade GW15 / PR1515

Carbide and PVD Coated Carbide for Heat Resistant Alloys

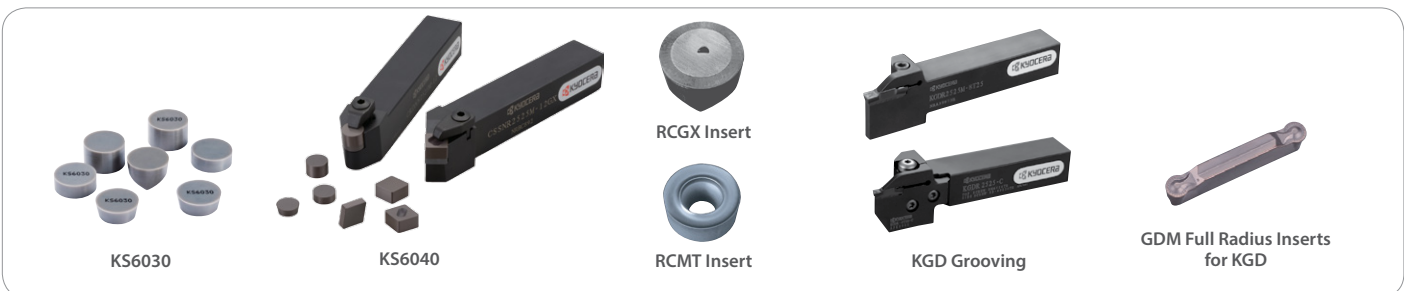

TURBINE DISC

MACHINING CHALLENGE:

Plunging/facing applications become more challenging in heat-resistant alloys such as René, INCONEL®, WASPALOY®, and others. Inserts with good chipping and notch resistance are required.

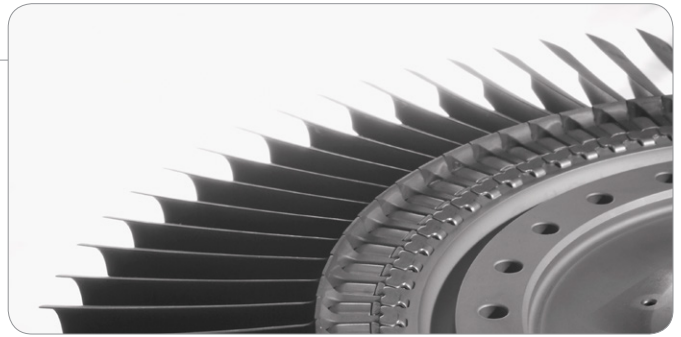

KYOCERA'S TOOLING SOLUTION:

Round Insert Geometries

RCMT, RCGX, and RNG inserts offer optimum chip thinning benefits

Grade KXW1

Whisker Ceramic for Nickel-based High-temp Alloys

Grade KS6040

SiAlON Ceramic for Heat Resistant Alloys

Cera-Notch Grooving

with KCGP inserts

KGD Grooving

with GDM inserts

Grade PR1215 / PR1535 / PR1515 / GW15 / KW10

Carbide and PVD Coated Carbide for Steel, Titanium, and Other HRAs



COMBUSTION CASING

MACHINING CHALLENGE:

Difficult materials, including René alloys, INCONEL® 718, WASPALOY®, Titanium, and the nickel-based Alloys. Similar to challenges presented by fan casings, with addition of nickel-based alloys; workholding rigidity and tool pressure continue to be major machining factors.

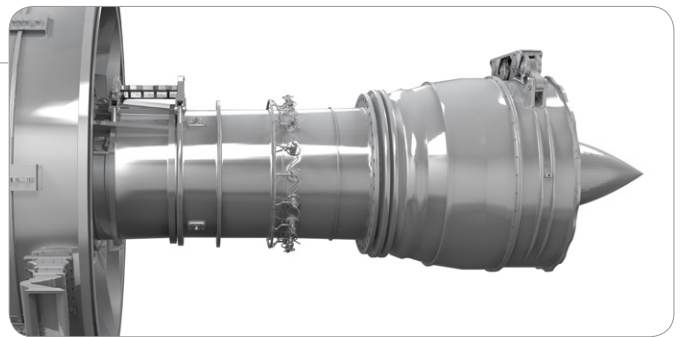

KYOCERA'S TOOLING SOLUTION:

APOLLO (AP4 & AP5)

Solid Carbide 4 Flute Variable Helix Solid End Mills

TITAN-AX

Reinforced Shank Solid End Mills with AX High Performance Coating

RNG / Grade KS6040

RNG Inserts with Grade KS6040 for Roughing

RAD-6 (MRX)

Single-sided 6-Edge Radius Cutter

RCMT Inserts

Round Insert Geometries



LANDING GEAR

MACHINING CHALLENGE:

In the hardened state, 300M high-strength alloy steel presents the challenge of size control (holding diameter sizes over length of the part). Cutting tools with high wear resistance are necessary to prevent size variations or taper over the full length of cut.



KYOCERA'S TOOLING SOLUTION:

CA5-Series

CVD Coated Carbide Grades for Steel Machining

TN620 / PV720

Cermet and MEGACOAT Cermet for Steel Machining

A65 / PT600M

Ceramic Grades for Semi-Roughing to Finishing Hardened Materials

KBN-Series

MEGACOAT CBN Grades for Hardened Materials



CA5-Series

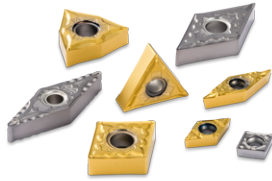

TN620 / PV720

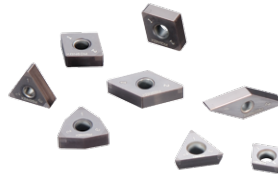

KBN05M



A65 / PT600M

FLOOR PANELS

MACHINING CHALLENGE:

Honeycomb materials are utilized for their high strength to weight ratios. Thin walled cross sections of aluminum must be carefully machined to prevent tearing or compressing the material.



KYOCERA'S TOOLING SOLUTION:

Solid Carbide Routers

for CFRP, Fiberglass, Honeycomb, and Composites

Solid Carbide End Mills

General Purpose Milling

Solid Carbide Drills

Micro and Deep Hole Drilling



Solid Drills



Solid End Mills



Solid Routers

WHEELS & BRAKES

MACHINING CHALLENGE:

The wheels and braking systems are under a massive amount of strain during the braking process. These applications require a high surface finish quality involving complicated profiles inside the bore and thin walled sections. Size control is a challenge and cutting tools with high wear resistance are necessary to prevent size variations or taper over the full length of cut.

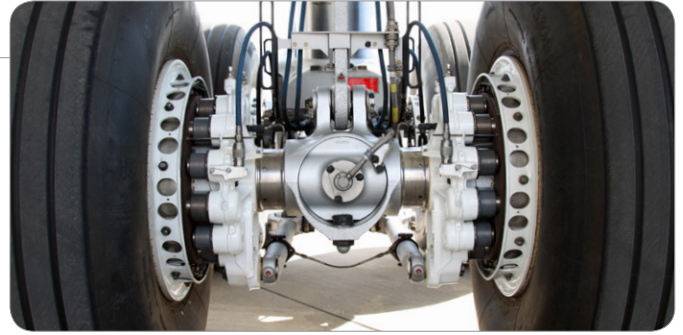

KYOCERA'S TOOLING SOLUTION:

CA5-Series

CVD Coated Carbide Grades for Steel Machining

TN620 / PV720

Cermet and MEGACOAT Cermet for Steel Machining

Ceramic A65 / PT600M

Grades for Semi-Roughing to Finishing Hardened Materials

KBN-Series

MEGACOAT CBN Grades for Hardened Materials



CA5-Series

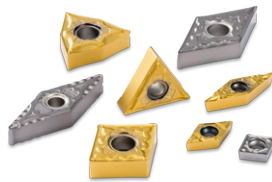

TN620 / PV720

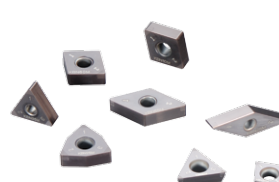

KBN05M



A65 / PT600M

HYDRAULICS & PNEUMATICS

MACHINING CHALLENGE:

Bar fed lathes require tools with sharp cutting edges and low cutting forces. Heavy depths-of-cut and low feed rates are common. A comprehensive line-up of small tools can offset these challenges and custom engineered micro bars can be utilized effectively in small internal bores.

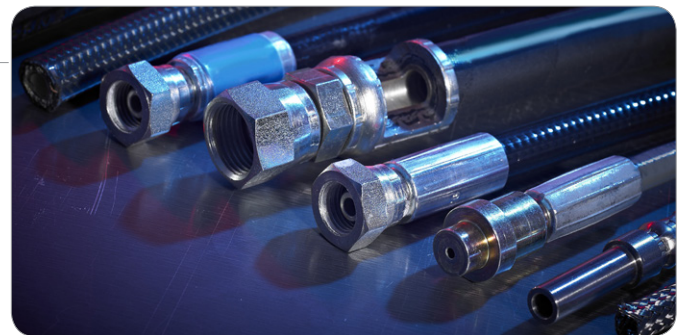

KYOCERA'S TOOLING SOLUTION:

KW10

Grade for Aluminum

CA65-Series

Grades for Stainless Steel

PR13-Series / PR12-Series

Grades for Stainless Steels and Heat-Resistant Alloys

GDM

Grooving and Cut-Off Inserts

TKN

Cut-Off Inserts

EZ Bar

Easy Adjustment Boring Bar

Specials

Solid Boring Bars



Grade
CA65-Series



Grade
PR13-Series

TKN Inserts



GDM Inserts

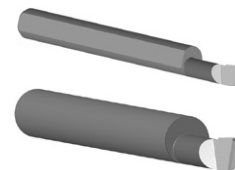

Special Solid
Boring Bars



EZ Bars

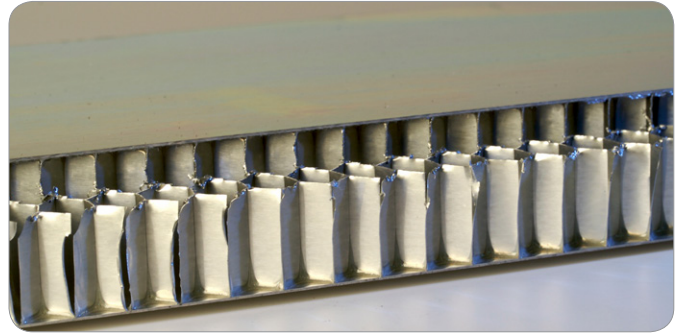
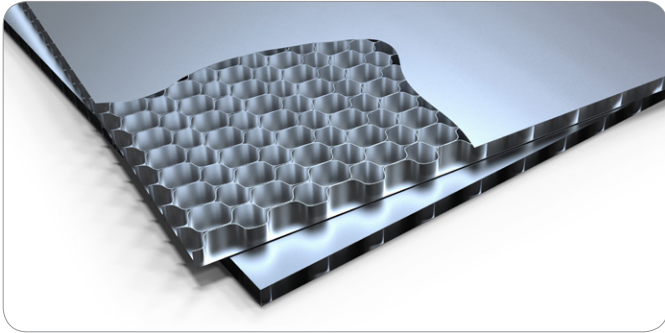
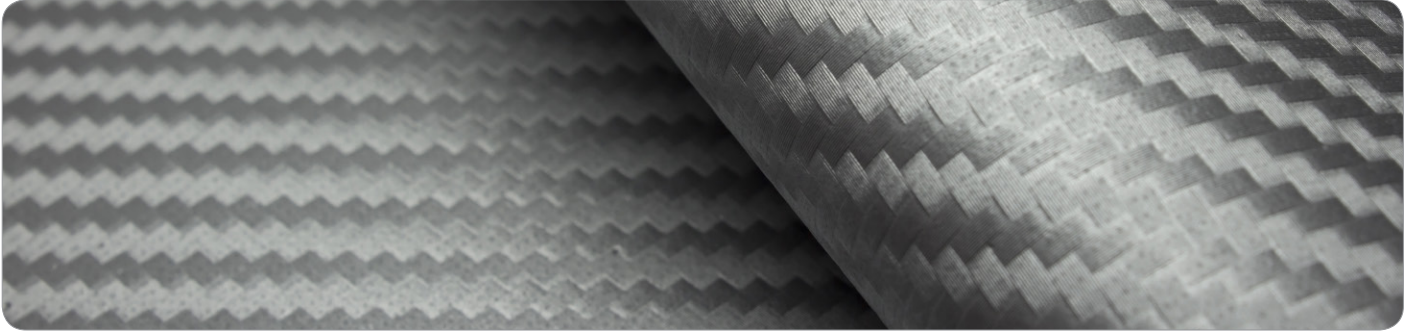

COMPOSITE MACHINING

MACHINING CHALLENGE:

Laminate materials can tear easily and machinability can vary based on the composition of the individual layers as well as the full laminate itself. Tooling with sharp cutting edges and abrasive wear resistance are critical for the effective machining of this special class of materials.

KYOCERA'S TOOLING SOLUTION:

MEC

Ultra Hurricane End Mills & Face Mills

Grade KPD001

Super Micro-Grain PCD

Solid Carbide Routers

for CFRP, Fiberglass, and Composites

VULCAN Compression End Mills

for CFRP, AFRP, Fiberglass, Carbon, Graphite, Plastic, Machinable Ceramic, and Machinable Glass



KYOCERA Precision Tools

102 Industrial Park Road
Hendersonville, NC 28792
Customer Service | 800.823.7284 - Option 1
Technical Support | 800.823.7284 - Option 2



Official Website | www.kyoceraprecisiontools.com
Distributor Website | mykpti.kyocera.com
Email | cuttingtools@kyocera.com