



2015 CATALOG



- Help
- Sling Protection
- Specials
- Web Slings
- Hull Savers
- Tufflex
- Wire Rope
- LiftAlloy Chain
- Mesh
- Load Huggers
- Hoist Rings
- Hoists
- Custom Devices

## TABLE OF CONTENTS

Help	<b>HELP</b> ..... <b>3-13</b>	<b>WIRE ROPE and SLINGS</b> ..... <b>73-95</b>
Sling Protection	Introduction ..... 3	Wire Rope and Sling Basics, Environment ..... 74
Specials	Sling Inspections ..... 4	How to Order Wire Rope Slings ..... 75
Web Slings	Engineering ..... 5	<i>Permaloc</i> Wire Rope Slings ..... 76
Savers	Sling Selection ..... 6	<i>Permaloc</i> Bridle Slings ..... 77
Tufflex	General OSHA & Manufacturer Requirements ..... 7	Grommets and Endless Slings ..... 78
Wire Rope	Choker Hitch Angles ..... 11	<i>E - Z Flex</i> Cable Laid Slings ..... 79
Chain	Effect of Angles ..... 12	Hand Spliced Slings ..... 82
Mesh	Lifting Application Worksheet ..... 13	Multi-Part Slings ..... 83
Huggers	<b>SLING PROTECTION</b> ..... <b>14-19</b>	Threaded Studs ..... 85
Rings	<b>SPECIALS</b> ..... <b>20-26</b>	Swaged Socket Assemblies ..... 86
Hoists	RFID Tagging ..... 20	Winch Lines, Hoist Lines and Buttons ..... 87
Custom Devices	Drum Handling Slings ..... 21	Wire Rope ..... 88
	Gas Bottle Web Cradles ..... 22	Cable & Components ..... 89
	<i>Tow-All</i> Vehicle Straps ..... 23	Sling Attachments, Hooks, etc. .... 91
	Bucket, Cooler & Trash Barrel Slings ..... 25	Inspection Criteria for <i>Wire Rope Slings</i> ..... 93
	<i>Hose Halters</i> ..... 26	Wire Rope Sling Weights ..... 94
	<b>WEB SLINGS</b> ..... <b>27-52</b>	<b>LIFTALLOY CHAIN SLINGS</b> ..... <b>97-110</b>
	Why <i>Lift-All</i> Web Slings ..... 28	Chain Sling Basics, How to Order ..... 98
	Web Selector ..... 29	Capacity Chart ..... 99
	Standard Web Sling Types ..... 30	Single and Double Slings ..... 100
	Web Sling Eye Treatments ..... 31	Triple, Quad and Basket ..... 101
	Environmental Considerations ..... 32	Adjustable and Endless ..... 102
	How To Order Web Slings ..... 33	<i>Adjust-A-Link</i> ..... 103
	Web Sling Hardware ..... 34	Hooks, Master Links, Chain, etc. .... 104
	<i>Tuff-Edge</i> II and <i>Webmaster</i> 1600 ..... 36	Inspection Criteria for Chain ..... 109
	<i>Dura-Web</i> Nylon Slings ..... 41	<b>ROUGHNECK MESH SLINGS</b> ..... <b>111-116</b>
	<i>Webmaster</i> 1200 ..... 42	Wire Mesh Slings ..... 112
	<i>Reverse Eye Slings</i> ..... 43	Chain Mesh Slings ..... 114
	<i>Tuff-Edge</i> II Hardware / <i>Bridle Slings</i> ..... 44	Inspection Criteria for <i>Chain Mesh Slings</i> ..... 116
	Wide-Lift Slings ..... 46	<b>LOAD HUGGER CARGO CONTROL</b> ..... <b>117-125</b>
	Stone Handling Slings ..... 47	<i>Load Hugger</i> Basics ..... 118
	<i>Inspection Criteria for Web Slings</i> ..... 48	Web Selection ..... 119
	<i>Web Sling Weights</i> ..... 50	Ratchet Assemblies ..... 120
	<b>HULL SAVER BOAT SLINGS</b> ..... <b>53-56</b>	Wear Pads and Corner Protectors ..... 123
	<b>TUFLEX ROUNDSLINGS</b> ..... <b>57-72</b>	Winch Straps, Winches & Bars ..... 124
	What is a <i>Tufflex</i> Roundslings? ..... 58	E-Track and Van Interior Assemblies, Chain and Load Binders ..... 125
	How to Order ..... 59	<b>HOIST RINGS</b> ..... <b>126-128</b>
	Using <i>Tufflex</i> Roundslings ..... 60	<b>HOISTS</b> ..... <b>129-132</b>
	Direct Connect Hooks ..... 61	Hand Chain Hoists ..... 129
	Endless ..... 62	Lever Pullers ..... 131
	Eye & Eye ..... 63	<b>LIFTING BEAMS and CUSTOM DEVICES</b> ... <b>133-138</b>
	Braided ..... 64	Basics, How to Order ..... 134
	<i>Keyflex</i> ..... 66	Custom Spreader Beams ..... 135
	Steelflex Stage Slings ..... 68	Custom Alloy S and J Hooks ..... 136
	Wide Lift <i>Tufflex</i> ..... 69	Standard Alloy S and J Hooks ..... 137
	Bridles ..... 70	Custom Coil and Pallet Lifters ..... 138
	Inspection Criteria for <i>Tufflex</i> ..... 71	<b>CONVERSION and WEIGHT TABLES</b> ..... <b>139</b>

## DEFINITION

### **⚠ WARNING**

as used throughout this catalog, serves to alert users to potentially hazardous situations which often occur in the use of these products. Failure to read, understand and follow the accompanying instructions on how to avoid these situations could result in death or serious injury.

## HOW TO USE THIS CATALOG

If this is your first venture into slings, we suggest you read "Help" pages 3 through 12 to learn about the different types of slings and general safety rules. When you move on to the section containing your sling type, specific information regarding that type is located there.

If you know the type of sling you need, locate the section by looking for the colored page tab.

Specific ordering instructions are shown in each section of the catalog.

Note: All Dimensions and Specifications are Subject to Change Without Notice. Hardware dimensions are nominal and may vary depending on source. If dimensions are critical to your application, please specify your requirements.

## INTRODUCING LIFT-ALL®

### Company Profile

Started in 1964, *Lift-All* has grown to be the largest sling manufacturer in North America with over 250 employees working in five manufacturing locations around the United States. Corporate headquarters and the largest facility are located in Landisville, Pennsylvania. Manufacturing facilities and warehouses are strategically located throughout the U.S. Sales representatives cover the entire U.S., Canada and Mexico.

Sound engineering principles, and a serious concern for safety have been the standard by which innovative lifting products have been produced by *Lift-All* for over 50 years.

### Lift-All's Mission Statement

Our mission is to be the trusted name in quality lifting and securement products and services by dedicating ourselves to customer satisfaction while providing exceptional value. Our long term success will be accomplished by a skilled workforce, committed to the principles of teamwork, integrity and performance.

### Disclaimer of Warranties and Limitation of Liability

Seller warrants that its goods are free from defects in materials and workmanship. Accordingly, Seller's liability is limited to replacing without charge or refunding the purchase price, or making fair allowance for any noncompliance with any specifications or any defects in materials or workmanship in its products existing at the time of delivery. Seller requires written notice and the return of the product to establish any claim. SELLER MAKES NO OTHER WARRANTY OF ANY KIND WHATSOEVER, EXPRESS OR IMPLIED, AND ALL IMPLIED WARRANTIES OR MERCHANTABILITY OR FITNESS FOR A PARTICULAR PURPOSE WHICH EXCEED THE ABOVE OBLIGATION ARE HEREBY DISCLAIMED BY SELLER AND EXCLUDED. Seller will not be liable for any consequential damages, loss or expense arising in connection with the use or inability whatever, regardless of whether damage, loss, or expense results from any act or failure to act by Seller, whether negligent or willful, or from any other reason.

Throughout this catalog trade names are shown in italic type.

All trade names are the property of *Lift-All* unless specifically identified by footnote as the property of another company.

© 2014 *Lift-All* This publication may not be copied, in any form, without express written permission from *Lift-All*.

## Why Lift-All?

### Lift-All Promotes User Safety

- Safety Seminars and Sling Inspections are available to all sling users.
- *Lift-All* quality assurance procedures produce consistently superior products.
- Warning, inspection and operating practices information is supplied with every order.
- By manufacturing all types of slings, *Lift-All* will, without prejudice, recommend the best sling for the application.
- Traceability of all slings through serial numbers.

### Lift-All Saves You Time

- *Lift-All* is the only source that can manufacture all of your sling needs.
- Our engineering staff can design the slings or lifting devices needed for special lifting applications.
- Local manufacturing and warehousing from five U.S. locations assures prompt delivery.
- *Lift-All* trained distributors are well qualified to assist the user in sling selection and application decisions.

### Lift-All Saves You Money

- Our combination of uncompromising product quality, service and technology makes *Lift-All* your best choice in long term value.

## SLING INSPECTION SERVICES

OSHA regulations require that all chain slings receive a thorough inspection at least once per year by a competent person. You now have the opportunity to have a thorough, documented inspection performed by a factory trained *Lift-All* representative. Chain slings, wire rope slings, web slings, roundslings and wire mesh slings all can be inspected in one survey by a representative from the only company that makes them all - *Lift-All*.

### The Inspection Procedure

Each sling is individually recorded and reported by location, serial number (if available), size, type, reach and condition.

If desired, we will affix a warning to those slings found to be damaged.

A Sling Survey Report will be printed and submitted to you for your records, showing the above information along with any recommendations we may have for improving your sling life and lifting safety.

If you wish to repair or replace any of the damaged slings, we will provide cost estimates to do so.

Sling Inspections not only help to insure safe lifting equipment but also increase employee awareness of sling safety, creating a safer workplace for all.

To inquire about or arrange for your Sling Inspection, please call our directed toll free phone number (800) 909-1964.

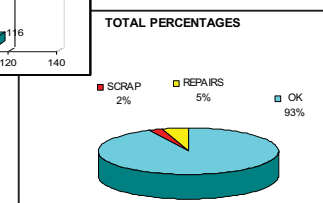
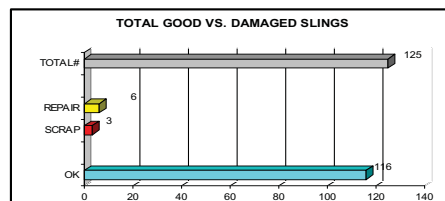
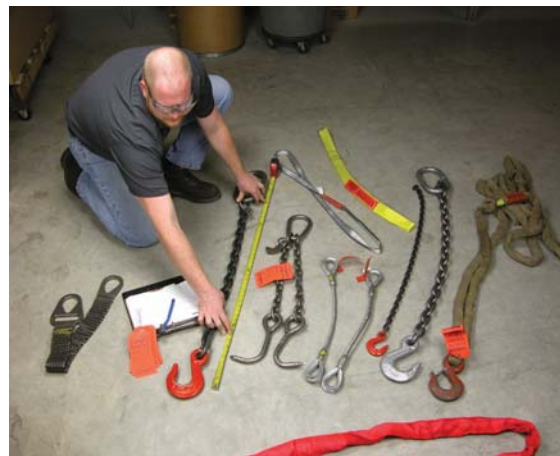

## QUALITY AND ENGINEERING SERVICES

### Quality Standards

*Lift-All* insures top quality products through a Quality Program, based predominately on Military Specification MIL-I-45208, which includes:

1. Detailed specifications for each product.
2. Testing of raw material prior to product manufacturing.
3. Product testing in conformance with industry standards.
4. Proof testing as required (certificates available).
5. Final inspection of products prior to shipment.

*Lift-All* is dedicated to manufacturing and developing products for material handling that meet or exceed current industry and government requirements, including OSHA and ASME B30.9 for lifting slings. *Lift-All* products conform to the following:

Product Type	Standard /Specification
Cargo Securement	US DOT, FMCSA 393.102, WSTDA
Chain Slings	OSHA 1910.184, ASME B30.9, NACM
Hoists	ASME B30.16, B30.21
Roundslings	ASME B30.9, WSTDA
Webbing Slings	OSHA 1910.184, ASME B30.9, WSTDA
Wire Mesh Slings	OSHA 1910.184, ASME B30.9
Wire Rope Slings	OSHA 1910.184, ASME B30.9

### Engineering Services

Fee based engineering services are available for lifting applications or custom product design and review. Contact *Lift-All* for details on this program.

## SAFETY IN LIFTING

### Safety Video Available



"Safety In Lifting", a 22 minute presentation is available in DVD format in both English and Spanish. It covers all types of slings: Web, Roundslings, Wire Rope, Chain and Wire Mesh. The Video suggests the best type of sling for common lifting applications, shows safe lifting procedures (in accordance with OSHA and ASME B30.9 guidelines), the proper inspection, care and maintenance of the various sling types, and more. Your in-plant training and safety program may be just a bit easier with some help from *Lift-All*.

### Safety Seminar

*Lift-All* representatives are available to present a "Safety in Lifting" seminar at your location, improving your employees knowledge of slings in general and answering specific questions about your applications.



For details about the Video and/or "Safety in Lifting" Seminars call:  
*Lift-All* at 1-800-909-1964.

## SLING SELECTION

### Which Type of Sling Should I Choose?

#### General Use of Different Types of Slings

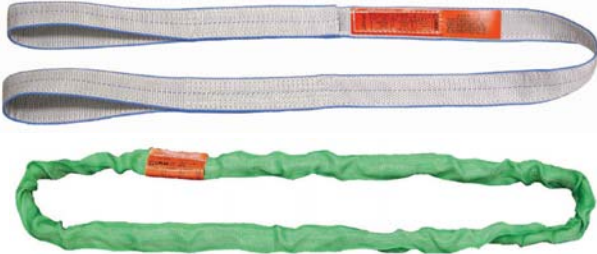

**Synthetic Slings** - Both Web Slings and Roundslings are used where loads must be protected from damage. The weight and flexibility of synthetic slings reduce fatigue and strain on riggers. *Tuflex* Roundslings, with their color coded capacities, and ease of use and inspection, are rapidly gaining in popularity.



**Wire Rope Slings** - The most common and lowest cost per ton of lift of all slings. Used in the construction industry and other industries where heavy loads and rugged conditions exist.



**Chain Slings** - Alloy chain slings combine superior strength, ease of handling and durability. The combination of heavy loads, elevated working temperatures and severe lift conditions usually dictate that an alloy chain sling be used. Typical chain sling applications are found in steel mills, foundries, and heavy machining operations requiring repetitive lifts.



**Mesh Slings: Wire and Chain** - These slings excel in lifting objects that are hot or have sharp edges, such as bar stock or plate steel. Mesh slings greatly enhance load balancing due to their wide load bearing surface. Machine shops and steel warehouses typically have good applications for mesh slings.



## GENERAL OSHA AND MANUFACTURER REQUIREMENTS FOR ALL SLINGS

### **▲ WARNING**

Read Definition on page 3

### Safe Operating Practices

1. **Sling users must be trained** in operating practices, including sling selection, use, inspection, rigging practices, cautions to personnel, and effects of environment.
2. **Inspect sling at least daily** and remove from service if damaged.
3. **Protect sling from being cut or damaged** by corners, protrusions, or from contact with edges that are not well rounded.
4. **Use sling properly.** Do not exceed a sling's rated capacities and always consider how the sling angle affects the amount of tension on the sling.
5. **Stand clear of load.** Do not stand on, under or near a load, and be alert to dangers from falling and moving loads, and the potential for snagging.
6. **Maintain and store sling properly.** Sling should be protected from mechanical, chemical and environmental damage.

### 1. Training

#### Sling Users must be Trained and Knowledgeable

Sling users must be knowledgeable about the safe and proper use of slings and be aware of their responsibilities as outlined in all applicable standards and regulations.

ASME B30.9 states: "*Sling users shall be trained in the selection, inspection, cautions to personnel, effects of the environment and rigging practices.*"

OSHA Sling Regulation 29 CFR 1910.184 states that a *qualified person* is one: "*who, by possession of a recognized degree or certificate of professional standing in an applicable field, or who, by extensive knowledge, training, and experience, has successfully demonstrated the ability to solve or resolve problems relating to the subject matter and work.*"

If you are unsure whether you are properly trained and knowledgeable, or if you are unsure of what the standards and regulations require of you, ask your employer for information and/or training – **DO NOT** use web slings if you are unsure of what you are doing. Lack of skill, knowledge or care can result in severe **INJURY** or **DEATH** to you and others.

### 2. Inspections

*Inspections. Each day before being used, the sling and all fastenings and attachments shall be inspected for damage or defects by a competent person designated by the employer. Additional inspections shall be performed during sling use, where service conditions warrant. Damaged or defective slings shall be immediately removed from service.*  
(OSHA Wording)

### Inspection Frequency

**Initial Inspection** - Each new sling must be inspected by a designated person to help ensure that the correct sling has been received, is undamaged, and meets applicable requirements for its intended use.

**Frequent Inspection** - The sling must be inspected by a designated person before each day or shift in **Normal** service conditions, or before each use in applications where a rapid rate of sling wear or other degradation may exist. (**Severe** service conditions).

**Periodic Inspection** - Every sling must be inspected "periodically". The designated person should be someone other than the person performing the frequent inspection.

The frequency of periodic inspections should be based on the sling's actual or expected use, severity of service, and experience gained during the inspection of other slings used in similar circumstances, but must not exceed a one year interval. General guidelines for the frequency of periodic inspections are:

- Normal service—yearly
- Severe service—monthly to quarterly
- Special service—as recommended

A written record of the most recent periodic inspection must be maintained. (See WSTDA WS-1 for definitions of service conditions.)

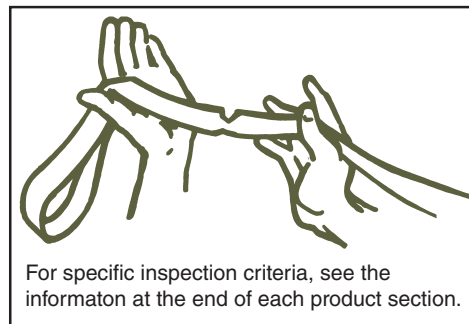

The Safety Bulletin that accompanies each sling must be read and understood by all sling users. See sling abuse illustrations in their respective section of this catalog. Damaged slings should never be used, but in some instances, it is possible to repair slings, proof test and return them to service. Damaged components and sections of chain or wire mesh can be replaced. Hooks, links and other components that are in good condition can be salvaged from a damaged web or round sling, rewedded, proof tested by *Lift-All* and returned to service.

## GENERAL OSHA AND MANUFACTURER REQUIREMENTS FOR ALL SLINGS

### 3. Protect Slings

#### **WARNING**

Read Definition on page 3

*Slings shall be padded or protected from the sharp edges of their loads.*  
 (OSHA Wording)

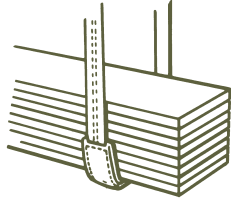

The cutting of synthetic slings is the main cause of sling failure; usually caused by a sharp or small diameter load edge against the sling. Proper protection must be used to avoid cutting. (See Sling Protection Section page 14).

Punctures & Abrasions seriously degrade sling strength. Rough load surfaces and dragging slings on the ground will damage all slings, steel or synthetic. Use proper padding between slings and rough loads. Never drag slings on ground or concrete floors.

#### Sling Protection

A qualified person must select materials and methods that adequately protect slings from edges or surfaces. Sleeves, wear pads, corner protectors, or other softeners are examples of materials commonly used as protection devices. However, **No protective device is "cut proof"**.

Some protection devices provide abrasion resistance, but offer virtually no protection against cuts. Several "test" lifts, done in a non-consequence setting, may be necessary to determine the suitability of each protection device. After each "test" lift, inspect **all** slings and protection devices for damage.

Foreign Matter - Material such as metal chips and heavy grit can damage slings, both internally and externally. Avoid contact with foreign matter whenever possible.

### 4. Use Slings Properly

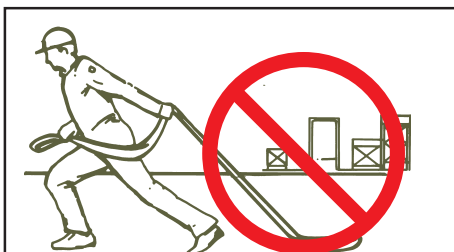

- Slings shall not be dragged on floor.

*Improper Loading - Shock Loading, unbalanced loading, overloading and inadequate consideration for the effect of angle factors can adversely affect safety. Make sure the load weight is within the rated capacity of the sling(s) being used for both type of hitch and angle of lift.*

(OSHA Wording)

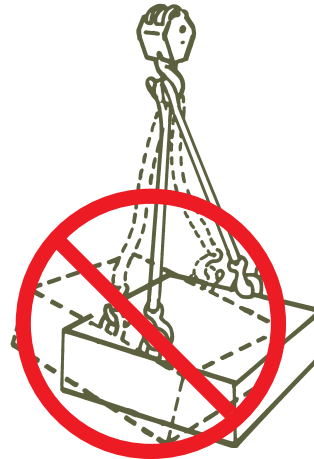

- Do not shock load. Jerking the load could overload the sling and cause it to fail.

- Lift must be stable with respect to the center of gravity - balanced.

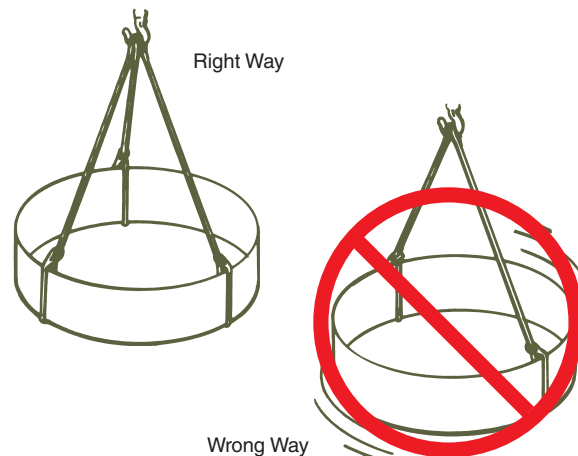



**GENERAL OSHA AND MANUFACTURER REQUIREMENTS FOR ALL SLINGS**

**⚠ WARNING**

Read Definition on page 3

*Slings used in a basket hitch shall have the loads balanced to prevent slippage.*  
(OSHA Wording)

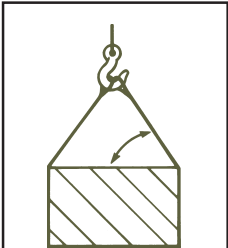



- Angle of lift must be considered in all lifts. See page 12.

Temperature - Avoid loads and environments where temperatures exceed the limits of the slings being used. All slings can be damaged by excessive heat, including heat from welding torches and weld spatter.

Chemical Environment - Slings exposed to certain chemicals or the vapors of these chemicals can lose some or all of their strength. When using slings in a chemical environment, contact *Lift-All* to assure sling compatibility.

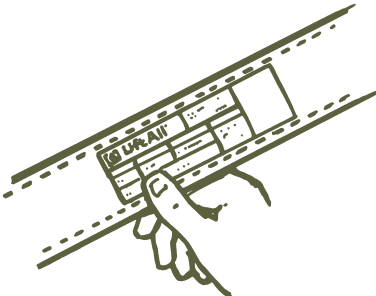
*Slings shall not be loaded in excess of their rated capacities.*  
(OSHA Wording)



- Rated capacities (Working Load Limits) must be shown by markings or tags attached to all slings.

- Temperature and chemical environment must be considered (see specific sling types for data).

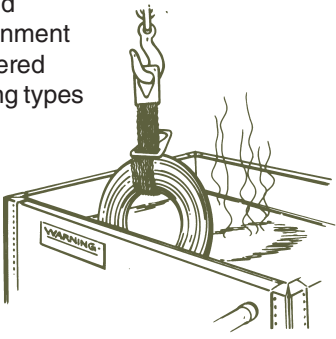

Right Way      Wrong Way

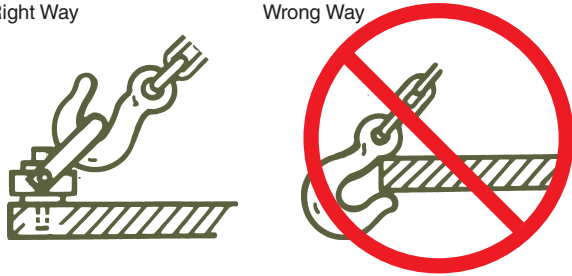

- Do not point load hooks - center load in base of hook.

*Slings shall be securely attached to their loads.*  
(OSHA Wording)

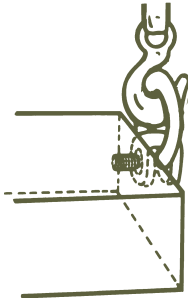

## GENERAL OSHA AND MANUFACTURER REQUIREMENTS FOR ALL

### ▲ WARNING

Read Definition on page 3

*Slings shall not be shortened with knots or bolts or other makeshift devices.*  
(OSHA Wording)



*Sling legs shall not be kinked.*  
(OSHA Wording)



*A sling shall not be pulled from under a load when the load is resting on the sling.*  
(OSHA Wording)

Right Way



Wrong Way

- Before a load is lifted, a place should be prepared where it is to be put down. Lumber can be used to allow space to remove the sling and prevent shifting of the load.

### 5. Stand Clear of the Load

*Hands or fingers shall not be placed between the sling and its load while the sling is being tightened around the load.*  
(OSHA Wording)

Wrong Way

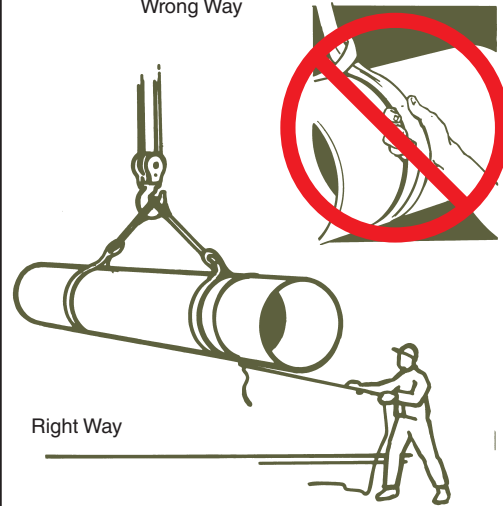

Right Way

- After lifting, the load should not be pushed or guided by employees hands directly on the load. Ropes or "tag lines" should be attached for this purpose.

*Suspended loads shall be kept clear of all obstructions.*  
*All employees shall be kept clear of loads about to be lifted and of suspended loads.*  
(OSHA Wording)

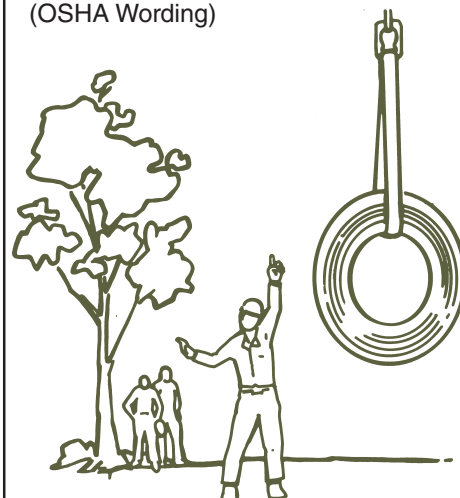

## GENERAL OSHA AND MANUFACTURER REQUIREMENTS FOR ALL

**⚠ WARNING**

Read Definition on page 3

### 6. Maintain and Store Sling Properly

Attempt to keep slings clean and free of dirt, grime and foreign materials.

When not in use, slings should be stored in an area free from environmental or mechanical sources of damage, such as: weld spatter, splinters from grinding or machining, or sources of UV, heat, or chemical exposure, etc.

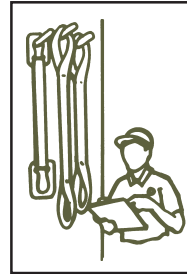

- Slings shall be stored in cool, dark, dry areas, preferably on racks.

Additional Factors to consider when handling loads

- Integrity of the attachment points
- Structural stability of the load
- Loose parts that could fall from load
- Power lines in the area
- Secure a clear load path and avoid any contact with objects that would impede load movement
- Tag lines can often be attached to the load and be used to aid in controlling load position

### Choker Hitch Angles

When a choke hitch is used, and the angle of choke is less than 120 degrees, the sling choker hitch capacity decreases. To determine the actual sling capacity at a given angle of choke, multiply the sling capacity rating (for a choker hitch) by the appropriate reduction factor determined from the tables below.

Adjusted choker hitch capacity = Choker Hitch Capacity x Reduction Factor

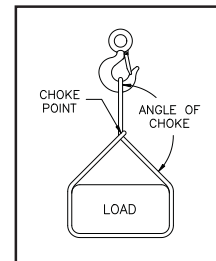

Reduction in rated capacity as a function of angle of choke

Synthetic Slings		
Angle of Choke		Factor
> or =	<	
120	180	1.00
105	120	.82
90	105	.71
60	90	.58
0	60	.50

Wire Rope Slings		
Angle of Choke		Factor
> or =	<	
120	180	1.00
90	120	.87
60	90	.74
30	60	.62
0	30	.49

Sling capacity decreases as choke angle decreases.

*Lift-All* is dedicated to manufacturing and developing products for material handling that meet or exceed current industry and government requirements (OSHA and ASME B30.9). Ultimately, the life and strength of any sling depends on those who inspect, use and maintain it.

The ASME B30.9 Sling Safety Standard can be obtained from:  
 ASME Customer Service  
 Phone: 800-843-2763  
[www.asme.org](http://www.asme.org)

Occupational Safety and Health Administration (OSHA) "Industrial Slings" Regulations are published by the Office of the Federal Register, National Archives and Records Administration - Part 29 1910.184  
[www.osha.gov](http://www.osha.gov)

### Effect of Angle of Lift on a Sling's Rated Capacity

**▲ WARNING** Read Definition on page 3

Using slings at an angle **can become deadly** if that angle is not taken into consideration when selecting the sling to be used. The tension on each leg of the sling is increased as the angle of lift, from horizontal, decreases. It is most desirable for a sling to have a larger angle of lift, approaching 90°. Lifts with angles of less than 30° from horizontal are not recommended. If you can measure the angle of lift or the length and height of the sling as rigged, you can determine the properly rated sling for your lift.

#### INCREASED TENSION

##### What capacity sling do I need?

1. Determine the weight that the sling will be lifting [LW].
2. Calculate the Tension Factor [TF].
  - a. Using the angle from horizontal, read across the angle chart to the corresponding number of Tension Factor column.
  - OR -
  - b. Divide sling length\* [L] by sling height\* [H].
3. Lifting Weight [LW] x the Tension Factor [TF] = Minimum Sling Rating for the type of hitch that will be used.

\* Measured from a common horizontal plane to the hoisting hook.

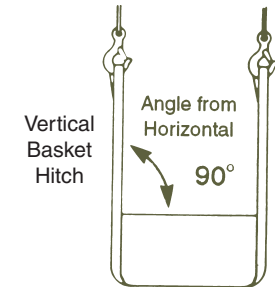
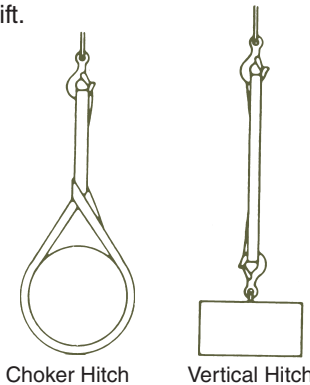

#### REDUCED CAPACITY

##### What would be the rating of each sling rigged at this angle?

1. Calculate the Reduction Factor [RF].
  - a. Using the angle from horizontal, read across the Angle Chart to the corresponding number of the Reduction Factor column.
  - OR -
  - b. Divide sling height\* [H] by sling length\* [L].
2. Reduction Factor [RF] x the sling's rated capacity for the type hitch that will be used = Sling's Reduced Rating.

\* Measured from a common horizontal plane to the hoisting hook.

#### Effect of Angle Chart

Tension Factor (TF)	Angle From Horizontal	Reduction Factor (RF)
1.000	90°	1.000
1.004	85°	0.996
1.015	80°	0.985
1.035	75°	0.966
1.064	70°	0.940
1.104	65°	0.906
1.155	60°	0.866
1.221	55°	0.819
1.305	50°	0.766
1.414	45°	0.707
1.555	40°	0.643
1.742	35°	0.574
2.000	30°	0.500

Sling capacity decreases as the angle from horizontal decreases. Sling angles of less than 30° are not recommended.

#### Increased Tension

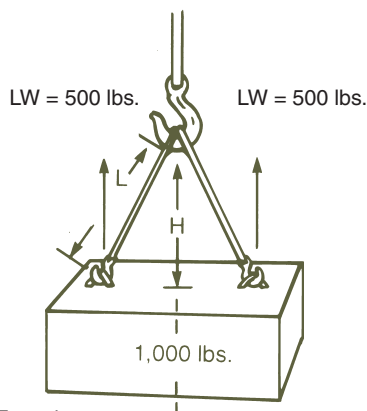

Example:  
 Load weight = 1,000 lbs.  
 Rigging - 2 slings in vertical hitch  
 Lifting Weight (LW) per sling = 500 lbs.  
 Measured Length (L) = 10 ft.  
 Measured Height (H) = 5 ft.  
 Tension Factor (TF) = 10 (L) ÷ 5 (H) = 2.0  
 Minimum Vertical Rated Capacity required for this lift = 500 (LW) x 2.0 (TF) = 1000 lbs. per sling

#### Reduced Capacity

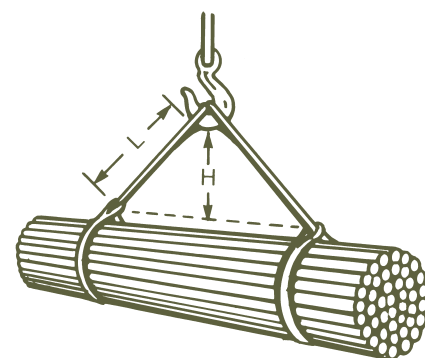

Example:  
 Vertical Choker rating of each sling = 6,000 lbs.  
 Measured Length (L) = 6 ft.  
 Measured Height (H) = 4 ft.  
 Reduction Factor (RF) = 4 (H) ÷ 6 (L) = .667  
 Reduced sling rating in this configuration = .667 (RF) x 6,000 lbs. = 4,000 lbs. of lifting capacity per sling

# Lifting Application Worksheet

Please fill in as much information as possible in order to aid in selecting the proper lifting equipment

Distributor \_\_\_\_\_  
Date: \_\_\_\_\_  
Contact Name: \_\_\_\_\_  
Telephone: \_\_\_\_\_  
Fax: \_\_\_\_\_

### Description of the load being lifted

What is the load: \_\_\_\_\_  
\_\_\_\_\_  
Size of the load:  
Weight: \_\_\_\_\_  
Width: \_\_\_\_\_  
Height: \_\_\_\_\_  
Length: \_\_\_\_\_  
Diameter: \_\_\_\_\_  
Other Notes: \_\_\_\_\_  
\_\_\_\_\_

### Lifting Conditions

Overhead Height Clearance: \_\_\_\_\_  
(From top of load)  
Operating Temperature:  
 Room  Other \_\_\_\_\_ °F  
Other Notes: \_\_\_\_\_  
\_\_\_\_\_  
If exposed to chemicals:  
Chemical: \_\_\_\_\_  
Conc: \_\_\_\_\_ %  
Temperature:  Room  Other \_\_\_\_\_ °F

Attach drawing of load and intended rigging configuration with dimensions.

### Lifting Operation

Lift and Transport  Pull / Drag Load Only  
 Lift and Turn  Lift Load Only  
 Other Notes: \_\_\_\_\_  
\_\_\_\_\_

### Lifting equipment being used (excluding slings)

Check the following equipment that performs the lift:  
 A single hook/hoist/crane. Hook sizes used: \_\_\_\_\_  
 Two hooks/hoists/cranes. Hook sizes used: \_\_\_\_\_  
 Fork-lift. Width/thickness of the forks: \_\_\_\_\_  
Distance between the inside edges of the forks:  
\_\_\_\_\_ in.  
Is a lifting beam to be used?  Yes  No  
If Yes: Beam Span: \_\_\_\_\_ ft. \_\_\_\_\_ in.  
Is it adjustable?  Yes  No  
Is a new beam needed?  Yes  No  
Other Notes: \_\_\_\_\_  
\_\_\_\_\_

### Rigging Configuration

Number of pick-up points: \_\_\_\_\_  
Connection point information:  
 Ring/Eye/Shackle  
Size: \_\_\_\_\_ ID: \_\_\_\_\_" OD: \_\_\_\_\_" THK: \_\_\_\_\_"  
 Wrapped around the load  
 Trunnion/Pin Diameter: \_\_\_\_\_"  
Is center of gravity an equal distance from all pick-up points?  Yes  No  
Sling/legs attached to the load in a:  
 Vertical Hitch  Choker Hitch  
 Basket Hitch  Other \_\_\_\_\_  
 Double Wrap Basket Hitch  
 Double Wrap Choker Hitch  
 Is edge protection needed?  
Other Notes: \_\_\_\_\_  
\_\_\_\_\_

The number one cause of synthetic sling failure is cutting. **Sling Shield Edge Protectors** prevent synthetic slings from being cut by load edges, when used within the recommended load limits. Low weight, high strength extruded aluminum body provides a full 1" radius to protect your slings from even the sharpest of load edges.

Stop replacing your synthetic slings and wear pads due to cutting.  
Use the new Lift-All **Sling Shields**.



**Features:**

- Aluminum bar with 1" radius supports basket or choker sling tensions of up to 25,000 lbs. per inch of sling width
- Polycarbonate end restraints help keep slings on bar when lifting at angles
- Magnet keeps **Sling Shield** in place on steel loads while rigging the lift
- Velcro® straps help keep sling in position prior to lift

**Benefits:**

- Improves Safety – Eliminates dropped loads caused by load edges cutting the sling
- Saves Time – Magnet and Velcro® straps greatly reduce rigging time
- Saves Money – No cut slings or wear pads means fewer replacement purchases



Lift-All Part #	SS Inside Width (In.)	SS Overall Length (In.)	SS Weight (Lbs.)	Widest Web Sling (In.)	Largest Appropriate Tuflex Size		Largest Appropriate KeyFlex Size	
					Single Leg	Double Leg	Single Leg	Double Leg
SS14	4.50	7.50	2.7	4	EN360	EN120	KEN80K	KEN15K
SS16	6.75	10.00	3.2	6	EN1000	EN240	KEN100K	KEN40K
SS112	12.75	16.00	4.8	12	EN1000	EN1000	KEN100K	KEN100K

**LOAD RATINGS**

The load rating of **Sling Shields** is **25,000 lbs.** of sling tension per inch of sling width using a basket or choker hitch. This rating is reduced when lifting at side pull angles of less than 70°. Do not exceed listed sling tensions. Prevent **Sling Shield** from sliding when using at an angle. Do not use at side pull angles less than 45°. See Safety Bulletin for more detailed information.

Side Pull Angle	Basket/Choker Rating (Lbs.)*
65°	17,500
60°	15,000
55°	13,000
50°	11,000
45°	8,000

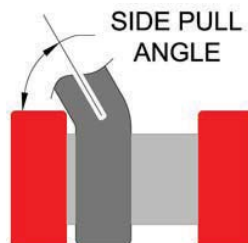

\* Ultimate rating regardless of width. Lifting in a vertical hitch reduces these ratings by half.

Velcro® is a registered trademark of Velcro Industries B.V.

## EDGE DEFENDER™

Pat. Pending

**Edge Defender** pads are our best synthetic product for protecting slings from being cut by load edges and protecting load edges from being marred due to lifting equipment. Protect your loads and your slings now by using the new Lift-All **Edge Defender!**

Sling Protection



### Features:

- Three layers of webbing sewn together with Kevlar® thread
- A layer of orange vinyl is sandwiched between the first and second layer to aid inspection
- Synthetic material is flexible under load
- Velcro® straps help keep sling in position prior to lift

### Benefits:

- Improves Safety – Thick pad sewn with Kevlar® thread gives excellent cut resistant protection to the sling
- Saves Time – Velcro® straps help to keep pad positioned on the sling to reduce rigging time
- Saves Money – This longer lasting pad protects slings better, extends sling life and reduces replacement purchases



Standard Pad Widths & Maximum Appropriate Sling Sizes				Part Numbers for Standard <i>Edge Defender</i> Lengths				
Pad Width (In.)	Max. Web Sling Width (In.)	Max. Tuflex Size	Max. KeyFlex Size	12 In.	18 In.	24 In.	30 In.	36 In.
				3	2	EN30	NA	ED3X12IN
4	3	EN60	NA	ED4X12IN	ED4X18IN	ED4X24IN	ED4X30IN	ED4X36IN
6	4	EN150	KEN20K	ED6X12IN	ED6X18IN	ED6X24IN	ED6X30IN	ED6X36IN
8	6	EN240	KEN50K	ED8X12IN	ED8X18IN	ED8X24IN	ED8X30IN	ED8X36IN
10	8	EN600	KEN90K	ED10X12IN	ED10X18IN	ED10X24IN	ED10X30IN	ED10X36IN

Velcro® is a registered trademark of Velcro Industries B.V.  
Kevlar® is a registered trademark of E.I. du Pont de Nemours and Company

## WEAR PADS

### The Importance of Wear Pads

Wear Pads can help protect slings against cutting and abrasion. The number one cause of synthetic sling failure is cutting. When slings are cut, property damage and personal injury or death can result. Wear pads can help to reduce this problem by acting as a buffer between the load edge and the sling. When used with steel slings, wear pads help protect both sling and load from damage along points of contact.

Always protect slings from being cut or damaged by corners, edges and protrusions using protection sufficient for each application.

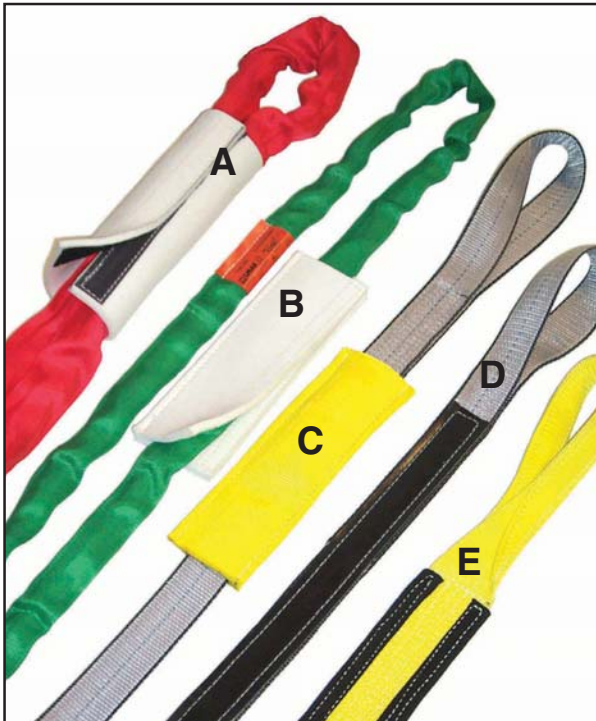

- A - Tubular Quick Sleeve using Pukka Pad Material
- B - Flat Quick Sleeve using Pukka Pad Material
- C - Flat Sewn Sleeve using Webmaster 1600
- D - Sewn-On Wear Pad using PVC
- E - Edgeguard using texturized nylon

### Features, Advantages and Benefits

Promotes Safety

- Helps avoid sling cutting that can cause property damage, personal injury or death.

Saves Money

- Helps protect both sling and load from damage
- Increases sling life

### Primary Causes of Cutting - How to avoid

- Edges - Edges do not need to be "sharp" to cause sling failure. Increase radius of all edges in contact with slings
- Movement - restrict sling movement against edges
- Pressure - reduce by using wider or additional slings

### **WARNING**

Wear pads may not prevent cutting or other sling damage. To avoid severe personal injury or death, keep all personnel clear of loads about to be lifted and suspended loads.

### Safe Operating Practices

A qualified person must select materials and methods that adequately protect the slings from damage. *Lift-All* recommends that, prior to making a lift, the load be raised slightly, then lowered so that the slings and wear pads can be inspected for damage. If there is evidence of cutting, the lift should be tested again using different pad materials and/or methods.

**Do not ignore warning signs of misuse. Cut marks detected during any sling inspection serve as a clear signal that sling protection must be added or improved.**

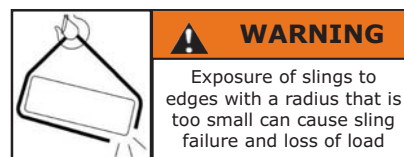



## WEAR PAD STYLES

<b>SLEEVE TYPE</b> Preferred for slings that are used in a variety of lifting situations. Easily repositioned along sling body to accommodate loads of various sizes. Sleeve allows sling to adjust to lift without movement against load edge.			
A	Tubular Quick Sleeve	Use with: <i>Tuflex</i> Roundslings Chain and Wire Rope Slings Available materials: All (except PVC)	High strength <i>Velcro</i> * for secure positioning, tubular design gives maximum useable surface and maximum pad life.
B	Flat Quick Sleeve	Use with: All Slings Available materials: All (except PVC)	<i>Velcro</i> * allows easy installation and removal. Friction keeps sleeve in place when rigging.
C	Flat Sewn Sleeve	Use with: All Slings Available materials: All (except PVC)	Preferred for long term use on single sling. May be repositioned as needed along sling length. May require factory installation on slings with hardware and on single leg <i>Tuflex</i> .
Poly Pads		Use with: Web Slings (Limited range of sizes) Available materials: PVC	Slides easily along sling length for convenient sling protection. Must be installed at factory for web slings with hardware.
<b>SEWN-ON TYPE</b> For use on web slings where repetitive lifting situations subject known areas of the sling to cutting and/or abrasion. Eliminates the need to position pad before each lift.			
D	Sewn-On Wear Pad	Use with: Web Slings Only Available materials: All except Ballistic nylon	For sling protection at expected wear points. Can be sewn anywhere on the sling, be any length and be on one or both sides.
E	Edgeguard	Use with: Web Slings Only Available materials: Texturized nylon or light duty leather	Helps protect edges of sling. Both edges will be covered to the length and position required.

## WEAR PAD MATERIALS

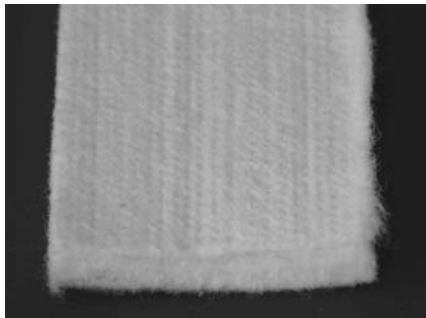

**Pukka-Pads (P) 5/16" Thick**  
 • A high density, polyester felt.

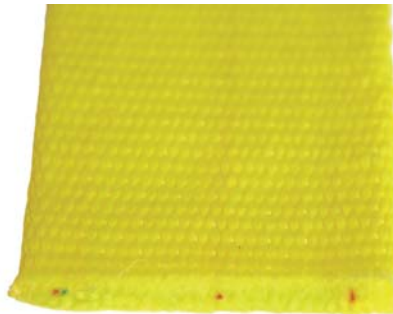

**Webmaster 1600 (N) 3/16" Thick**  
 • Heavy nylon sling webbing with red core warning yarns.



**Heavy Leather (HL) 5/32" Thick**  
 • Genuine top-grain cowhide (may require multiple pieces for longer lengths.)

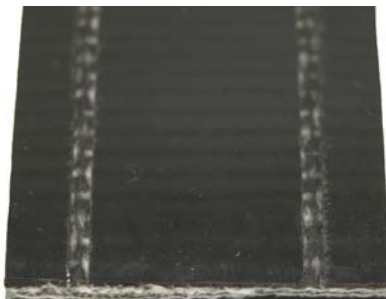

**PVC Belting (PVC) 1/8" Thick**  
 • Non-absorbent conveyor type belting.



**Texturized Nylon (TN) 3/32" Thick**  
 • A bulked nylon fiber is used to produce a thin webbing that has good abrasion resistance.



**Ballistic Nylon (BN) 1/16" Thick**  
 • A thin, 2-ply wear resistant fabric made of bulked nylon fiber, appropriate for wider sleeves and bundling applications.

\* Velcro® is a registered trademark of Velcro Industries B.V.

Sling Protection

## WEAR PADS

### Flat Quick Sleeves



Flat Quick Sleeve Widths and Largest Appropriate Slings <sup>1</sup>

Part No.	Sleeve Width <sup>2</sup> (in.)	Web Sling Width <sup>3</sup> (in.)	Tuflex				Keyflex		Wire Rope Sling Dia. (in.)	Chain Sling Size (in.)
			Single Leg	Double Leg	6-Part Braid	8-Part Braided	Single Leg	Double Leg		
3FQS	3	1						10K		7/16
4FQS	4	2	EN60	EE30				20K		3/4
5FQS	5	3	EN150	EE60				30K	10K	1 1/8
6FQS	6	4	EN180	EE120	B6E30			80K	20K	1 1/2
8FQS	8	6	EN360	EE240	B6E60	B8E30		125K	30K	2 1/4
10FQS	10	8	EN800	EE360	B6E120	B8E90		175K	80K	2 1/2
12FQS	12	10	EN1000	EE600	B6E180	B8E150		200K	125K	1

- Note: 1. Slings shown are the maximum recommended size for each sleeve width.  
 2. Width of sleeve depends on the material being used. This chart is based on using Pukka Pad material.  
 3. One or two ply only. For three or four ply, go to the next larger sleeve.

### Tubular Quick Sleeves

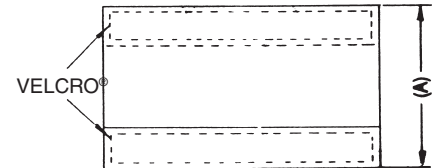

Tubular Quick Sleeve Widths and Largest Appropriate Slings <sup>1</sup>

Part No.	Open Sleeve Width (A) (in.)	Tuflex				Keyflex		Wire Rope Sling Dia. (in.)	Chain Sling Size (in.)
		Single Leg	Double Leg	6-Part Braid	8-Part Braid	Single Leg	Double Leg		
4TQS	4							1/4	
5TQS	5							1/2	
6TQS	6	EN60						7/8	7/32
8TQS	8	EN150	EE60					30K	1 1/2
10TQS	10	EN240	EE120	B6E60	B8E30			50K	15K
12TQS	12	EN360	EE180	B6E90	B8E60			80K	30K
14TQS	14	EN800	EE240		B8E90			125K	50K
16TQS	16	EN1000	EE360	B6E150	E8E120			175K	80K
18TQS	18		EE600	B6E240	B8E180			200K	100K
20TQS	20		EE800						125K
22TQS	22		EE1000	B6E360	B8E240				175K
24TQS	24								200K
26TQS	26			B6E600	B8E360				
30TQS	30			B6E800	B8E600				
34TQS	34			B6E1000	B8E800				

- Note: 1. Slings shown are the maximum recommended size for each sleeve width.  
 2. Tubular Pukka Pads not available under 10" open sleeve width.

### Edgeguard (Code EG)



Texturized Web

### Sewn-On Wear Pads (Code WP)



PVC

## WEAR PADS



Sling Protection

### Standard Sewn-Sleeves

Sewn-Sleeve Widths and Largest Appropriate Slings <sup>1</sup>

Part No.	Sleeve Width <sup>2</sup> (in.)	Web Sling Width <sup>3</sup> (in.)	Tuflex			Keyflex			Wire Rope Sling Dia (in.)	Chain Sling Size (in.)	
			Single Leg	Double Leg	6-Part Braid	8-Part Braid	Single Leg	Double Leg			
3SS	3	1	EN60						3/4	7/32	
4SS	4	2	EN150	EE60				15K	1 1/8	3/8	
5SS	5	3	EN240	EE120	B6E30			30K	1 1/2	1/2	
6SS	6	4	EN360	EE180	B6E60	B8E30		80K	15K	1 3/4	5/8
8SS	8	6	EN800	EE360	B6E120	B8E60		100K	40K	2 1/2	7/8
10SS	10	8	EN1000	EE600	B6E180	B8E150		175K	80K		1
12SS	12	10		EE1000	B6E240	B8E180		200K	125K		1 1/4

- Note:
- Slings shown are the maximum recommended size for each sleeve width.
  - Width of sleeve depends on the material being used. This chart is based on using Pukka Pad material.
  - One or two ply only. For three or four ply, go to the next larger sleeve.

### Poly Pads

Easily movable Poly Pads are made of tough, woven polyester fabric impregnated and coated with PVC. Easy to position on both web slings and tiedowns. Poly Pads are designed to give protection when lifting on load edges or abrasive loads.

Part No.	Poly Pad	Web Width (in.)
60115	3 1/2 x 12	1 - 2
60116	6 x 12	3 - 4



### How To Order

1. Choose code for width and style

TQS Tubular Quick Sleeve  
 FQS Flat Quick Sleeve  
 SS Flat Sewn Sleeve  
 WP Sewn-On Wear Pad  
 EG Edgeguard  
 \_\_\_\_\_ Poly Pad (Use Part No.)

2. Choose a Material

P 5/16" Heavy Duty Pukka-Pad  
 N Webmaster 1600 Nylon  
 HL Heavy Leather  
 TN Texturized Nylon  
 BN Ballistic Nylon (Tubular only)  
 PVC (Sewn-on Wear Pads only)

3. Length of Sleeve

(if sewn-on pad, describe position on sling)  
 \_\_\_\_\_ Feet

4. For Use On

\_\_\_\_\_ Web Sling - Code or Width  
 \_\_\_\_\_ Tuflex  \_\_\_\_\_ Single-Leg - Code \_\_\_\_\_  
 \_\_\_\_\_ Double-Leg - Code \_\_\_\_\_

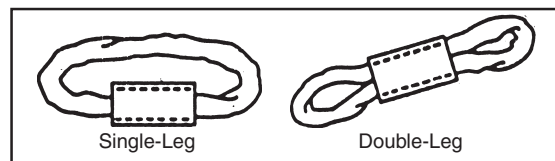

\_\_\_\_\_ Chain Sling Size \_\_\_\_\_ inches  
 \_\_\_\_\_ Wire Rope Sling - Dia. \_\_\_\_\_ inches

### **WARNING**

Wear pads may not prevent cutting or other sling damage. To avoid severe personal injury or death, keep all personnel clear of loads about to be lifted and suspended loads.

**RFID TAGGING**

**Lift-All** now offers a high frequency, passive RFID tagging service for new slings.

RFID chips allow end users with RFID software and readers to electronically track a slings history to assist with the maintenance, inspection, traceability and compliance of their slings.

The **synthetic slings** will have a 5/8" diameter, plastic coated, high frequency chip inserted underneath the standard *Tuff-Tag* I.D. tag. A marker tape with "RFID" printed on it will stick out from the *Tuff-Tag* to make its presence obvious.



Plastic Coated RFID Chip  
Part # RFIDW



**Wire rope and chain slings** are offered with a high frequency, RFID chip permanently set into a machined, teardrop shaped piece of steel, attached to the sling with a wire cable. Wire rope sling placement is between the Tuff-Tag and the swaged sleeve. Chain sling attachment is beside the I.D. tag on the connector link.

**Tag Information**

RF Protocol:	ISO15693 / ISO10443
Operating Frequency:	HF - 13.56 MHz
IC Type:	SLI Icode 1024 Bit
Memory Config.:	64 UID Bits (16 digits)
Functionality:	Read and Write
Security:	64 Bit Kill Access Password
Read Range:	Less than 1.0"
Quality Guarantee:	100%
IP Classification:	68



Steel Encased  
RFID Chip  
Part # RFIDS

## DRUM HANDLING SLINGS

*Lift-All* Drum Handling Slings provide an easy, inexpensive way to handle steel drums. Available in two styles to suit your needs for handling drums in the vertical or horizontal position.

### Vertical Drum Handling Slings

Easily lift standing drums for transport. Tilt suspended drums to pour from open top or spigot. For use with ribbed steel drums, the ratcheting belly band tightens securely below the first rib.

Lightweight version (**DSV601D**) uses 1" polyester sling webbing and is rated for 300 lb. loads.

Heavyweight sling (**DSV602D**) uses 2" polyester sling webbing and is rated at 850 lbs.

#### Promotes Safety

- A wear pad, sewn on one side of the lifting strap, helps to avoid cutting of the sling.
- Ratchet tightens securely.

#### Saves Time

- Free end of ratchet strap sewn to stay properly threaded.
- Vertical legs sewn to belly band to maintain proper position.



To Order, specify Part No. and drum diameter in inches. i.e.: **DSV602Dx24**  
(The standard 55 gal. drum has a 24" diameter.)



Note: If using in a chemical environment, contact *Lift-All* for sling material advice.

### Horizontal Drum Handling Slings

Ideal for the quick and easy moving of steel drums in the horizontal position.

Part No. **DSH601D** uses 1" polyester sling webbing and is rated at 1,500 lbs.

#### Promotes Safety

- Strong 1" polyester webbing pulls drum hooks securely into rims at both ends of the drum during lift.

#### Saves Time

- One sling fits multiple size drums.
- Easy to disconnect.
- Uses 1/2" oblong link at top for easy connection to hoist hook.

To Order, specify Part No. **DSH601D**.

## GAS BOTTLE WEB CRADLES

These specialty web slings make for easy and secure lifting of your gas bottle cylinders into position using cranes, hoists, forklifts, etc. Two standard versions are available. **GBS1N** slings automatically adjust to accommodate 9" Dia. x 50" H to 13" Dia. x 39" H bottles. **GBS2N** slings are designed for the convenient tandem lifting of one oxygen and one acetylene bottle as used in most welding operations. Each assembly is rated to lift 1,000 lbs.



Leather reinforced eyes for extended sling life.

Top assembly collar fits around standard valve caps to secure top of cylinder

Square rings connect bottom and top assemblies and allow for automatic adjustment

Six legs on bottom assembly surround and secure base of cylinder.

Abrasion resistant webbing lines both sides of legs at bottom for longer sling life.

2 ply leather base provides additional protection from abrasion and cutting



**GBS1N**



**GBS2N**

The GBS2N slings have the same construction features of the GBS1N slings, but have been designed specifically to lift one each of the standard size oxygen and acetylene bottles commonly used in welding operations.

## TOW-ALL VEHICLE STRAPS

**Vehicle Recovery Straps aid in** removing vehicles stranded in snow, mud, sand and ditches.

*Tow-Alls* stretch and elastic properties are important features that aid in the recovery of disabled vehicles.

### Tow-All Features, Advantages and Benefits

#### Promotes Safety

- No dangerous hooks or metal parts
- Elongates 5% at Towing Capacity to help absorb the energy of sudden loading

#### Saves Money

- Polyester/nylon material is easy on painted and plated surfaces

#### Saves Time

- Lightweight, flexible, easy to use and store

### ⚠ WARNING

Read Definitions on page 3

### Safe Operating Practices

- Do not use a damaged or defective strap - inspect before each use
- Do not exceed Towing Capacity
- Do not tie knots in strap
- Do not attach to bumpers
- Avoid dragging strap on ground
- Strap is permanently damaged when exposed to temperatures in excess of 200°F. Avoid muffler and hot exhaust systems.
- Stand clear of strap and vehicles when under load
- Always protect straps from being cut by corners and edges.
- Store in cool, dry and dark location

Note: Lift-All believes tow straps with metal end fittings are dangerous and, therefore, will not put metal hardware on *Tow-All* straps.

Specials

### WEB Tow-All VEHICLE RECOVERY STRAPS



Web *Tow-All* Vehicle Recovery Straps are made from strong durable *Tuff-Edge II* webbing with sewn eyes, lined with premium abrasion resistant webbing, on each end. The webbing is weather resistant and will not rot or mildew. It attaches quickly to vehicle frames or towing hooks.

Part No.	Ply	Web Width	Assembly Breaking Strength* (lbs.)	Towing Capacity (lbs.)
TS1802T	1	2	16,000	5,300
TS2802T	2	2	32,000	10,700
TS1803T	1	3	24,000	8,000
TS2803T	2	3	43,000	14,300
TS1804T	1	4	32,000	10,600
TS2804T	2	4	57,500	19,100
TS1806T	1	6	48,000	16,000
TS2806T	2	6	81,500	27,100

\* Assembly breaking strength when new.  
Do not exceed Towing Capacity

**TOW-ALL VEHICLE STRAPS**

**TUFLEX Tow-All VEHICLE RECOVERY STRAPS**

The heavy duty recovery straps!

In addition to the standard *Tow-All* features, **Tuflex Tow-Alls** are designed to prevent dangerous recoil if broken.

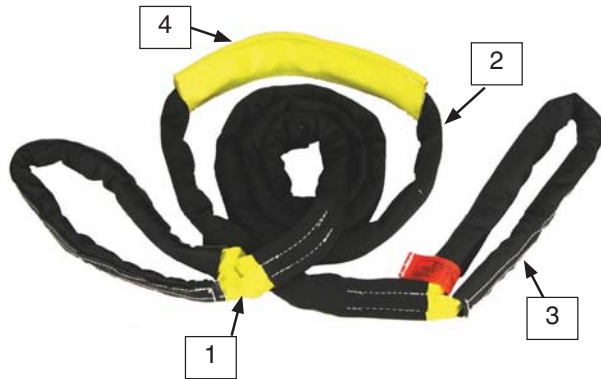

Our **Tuflex** version of the *Tow-All* straps offers the most rugged synthetic strap on the market. We start with our standard **Tuflex** roundsling (1) and add an additional jacket of texturized, abrasion resistant nylon (2) over the body of the sling, making it into an eye & eye style. The eyes are then covered with ballistic nylon webbing (3) for additional protection. An 18" long sliding sleeve wear pad (4) provides added protection against load edges.

**Inspection Criteria for Web *Tow-All* Straps**

Remove from service if any of the following are visible:

- Signs of melting, charring or chemical damage
- Cuts on the face or edge of webbing
- Holes, tears, snags or crushed web
- Signs of excessive abrasive wear
- Broken or worn threads in the stitch patterns
- Any other visible damage which causes doubt as to its strength

Refer to photographs of damaged webbing on pages 48 & 49.

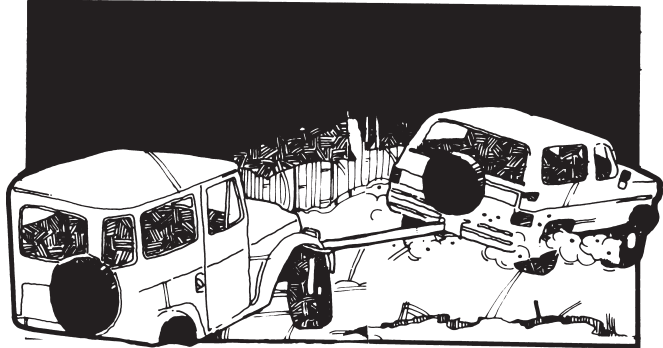

Part No.	Assembly Breaking Strength*	Towing Capacity (lbs.)
TSEN90	42,000	14,000
TSEN120	52,500	17,500
TSEN150	66,000	22,000
TSEN180	84,000	28,000
TSEN240	105,900	35,300
TSEN360	154,800	51,600
TSEN600	249,900	83,300
TSEN800	330,000	110,000
TSEN1000	450,000	150,000

\* Assembly breaking strength when new. Do not exceed Towing Capacity.

**Inspection Criteria for *Tuflex Tow-All* Straps**

Remove from service if any of the following are visible:

- Cuts to the covers that expose the internal core yarns
- Holes, snags, pulls or abrasion that exposes the internal core yarns
- Evidence of heat or chemical damage
- Knots
- Illegible or missing identification tag

Refer to photographs of damaged *Tuflex* roundslings on pages 71 & 72.



## BUCKET, COOLER & TRASH BARREL SLINGS

Help protect your workers from injury with these three new slings

### Bucket Sling



Lift-All **Bucket Slings** are designed to lift 5 gallon buckets filled with up to 200 pounds of material.

- Made from 1" wide yellow polyester sling webbing. Rated capacity – 500 lbs.
- Designed for buckets with an 11 inch diameter base.
- Two belly bands keep bucket secure
- Overall sling height is 28".

Part No. BS5  
Weight - 0.8 lbs.

Custom sizes also available.

### Cooler Sling



Lift-All **Cooler Slings** will adjust to lift 3, 5 or 10 gallon water coolers safely and securely to elevated work stations. Connect 2 or 3 together to save crane time.

- Made from 2" wide yellow polyester webbing. Rated capacity – 500 lbs.
- 3 lifting legs hold both cooler and lid securely.
- Buckles on the 2 belly bands allow for easy rigging, a snug fit and quick connection.
- Extra loop on bottom of sling allows for easy attachment of additional hook top cooler slings.
- Overall height - 44".

Hook top # CSH10 - 4.3 lbs.  
Eye top # CSE10 - 3.3 lbs.  
Custom sizes also available.

### Trash Barrel Sling



Lift-All **Trash Barrel Slings** are designed to lift 32 gallon plastic trash barrels. Use your forklift or overhead crane to make easy work of moving those heavy barrels.

- Made from 2" wide yellow polyester sling webbing. Rated capacity – 1,000 lbs.
- 4 lifting eyes are tapered and wrapped to help avoid abrasion, extend sling life.
- Overall height - 51".

Part No. TBS32  
Weight - 3 lbs.

Custom sizes also available.

**HOSE HALTERS™**

**Help protect your workers from injury and your equipment from damage**

To reduce damage to equipment and injury to personnel when hoses accidentally disconnect while under pressure, be sure to use the new Lift-All **Hose Halters™**. Suitable for use on pneumatic, water and hydraulic hoses, these easy to install straps are made from strong, flexible nylon webbing. Slide the rubber grommets (2) to keep choked eyes snug on the hose. The available standard lengths will accommodate hoses with inside diameters from 1/4" up to 6". Meets both OSHA and Canada OHS requirements for restraining devices on hose connections.

Specials

Available in Four Different Strengths

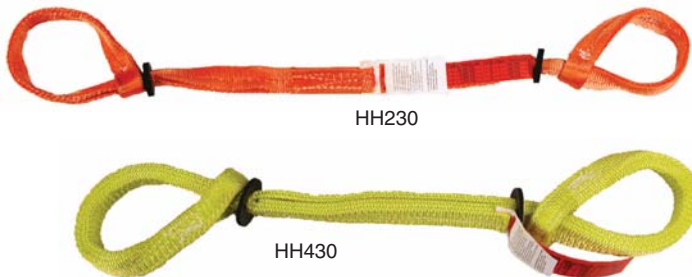
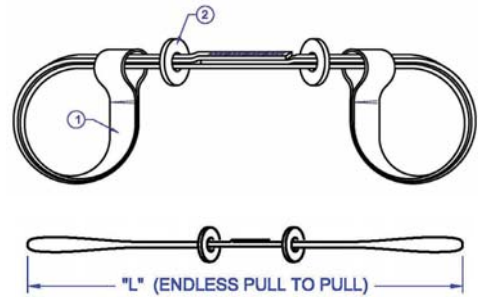

**OSHA 1926.603(a)(10)** states: Safety chains, or equivalent means, shall be provided for each hose connection to prevent the line from thrashing around in case the coupling becomes disconnected.

Part #	Length (L)	Recommended for Use on the Following Hose Inside Diameters							
		1/4"	1/2"	3/4"	1"	2"	3"	4"	6"
HH130	30"	26,000	6,500	2,900	1,650	400	-	-	-
HH140	40"	-	-	-	1,650	400	175	100	-
HH230	30"	52,000	13,000	5,800	3,300	750	-	-	-
HH244	44"	-	-	-	3,300	750	350	200	-
HH264	64"	-	-	-	-	750	350	200	90
HH330	30"	-	29,000	13,000	7,300	1,800	-	-	-
HH344	44"	-	-	-	7,300	1,800	820	460	-
HH364	64"	-	-	-	-	1,800	820	460	200
HH430	30"	-	37,000	16,000	9,400	2,300	-	-	-
HH444	44"	-	-	-	9,400	2,300	1,040	580	-
HH464	64"	-	-	-	-	2,300	1,040	580	260

# Web Slings



## WHY LIFT-ALL WEB SLINGS?

Lift-All web slings meet or exceed OSHA, ASME B30.9 and WSTDA standards and regulations.

All of the sling webbing contained in this catalog is recommended for general purpose lifting. Military webbing, sometimes designated as "Mil-Spec", has not been designed for, nor do we recommend it, for general lifting applications.

### What is the Difference?

Refer to Mil-Spec Webbing Diagram

- Mil-Spec webbing does not have red core yarn warning system.
- Mil-Spec webbing supports the entire load with exposed surface yarns. *Lift-All* sling webbing uses a combination of internal, protected yarns and surface yarns.
- Damage to the surface of Mil-Spec webbing causes greater strength reduction of the webbing.

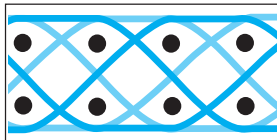

### Mil-Spec Webbing

- Combination binder/surface yarns cover each side and carry virtually all of the load.
- Transverse pick yarns inter-relate with binder/surface yarns.

Refer to *Lift-All* Sling Webbing Diagram

- Sling webbing, as shown, has its surface yarns connected from side to side, which not only protects the core yarns, but positions all surface and tensile yarns to work together to support the load.
- Wear or damage to Sling Webbing face yarns cause an immediate strength loss. This is why Sling Webbing has red core yarns to visually reveal damage and act as a basis for sling rejection.

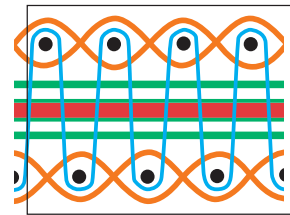

### Lift-All Sling Webbing

- Transverse pick yarns inter-relate with binder/surface yarns.
- Woven surface yarns cover each side and carry a portion of the load.
- Strip of longitudinal core yarns bears majority of load.
- Binder yarns secure the surface yarns to web core yarns.
- Red core warning yarns.

## Tuff-Tag and Safety Bulletin

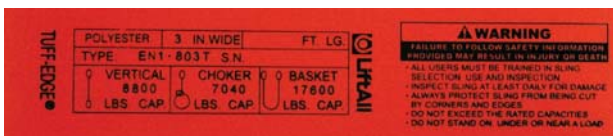

OSHA requires all web slings to show rated capacities and type of material. The *Lift-All Tuff-Tag* is made from an abrasion resistant polymer that will remain legible far longer than any leather or vinyl tags. In fact, *Tuff-Tags* will consistently outlast the useful life of slings.

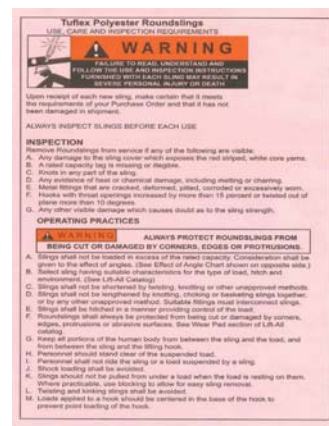

A Safety Bulletin is included with every web sling order from *Lift-All*. The bulletin lists inspection information and operating practices applying to synthetic web slings.

## LIFT-ALL WEB SELECTOR - QUICK COMPARISONS

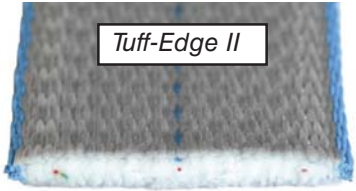
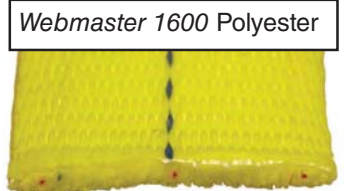
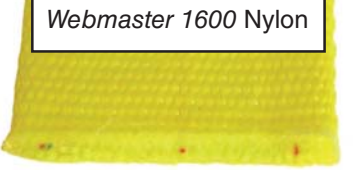
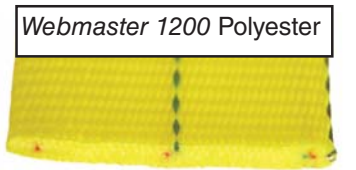
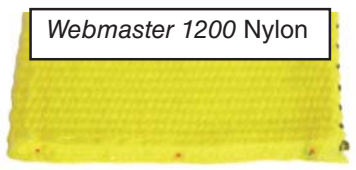
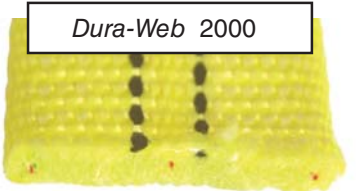
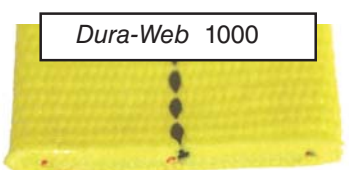
	Approx. Thickness	Single Ply Rated Capacity Per In. of Width	Available Material	Identify by:	Choose from:
 <b>Tuff-Edge II</b>	3/16"	1600 Lbs.	Polyester	Blue edge Blue center stripe Silver surface	Daily use under good to rugged lifting conditions. 2x edge cut resistance. Our best seller.*
 <b>Webmaster 1600 Polyester</b>	3/16"	1600 Lbs.	Polyester	Blue center stripe	Daily use under good to moderate lifting conditions. Polyester stretches less for better load control, reduced abrasion.*
 <b>Webmaster 1600 Nylon</b>	3/16"	1600 Lbs.	Nylon	No center stripe	Daily use under good to moderate lifting conditions. Nylon stretches more to help avoid shock loading.*
 <b>Webmaster 1200 Polyester</b>	1/8"	1200 Lbs.	Polyester	Blue center stripe Black yarn one edge	Less frequent use under good lifting conditions. Polyester stretches less for better load control, reduced abrasion.*
 <b>Webmaster 1200 Nylon</b>	1/8"	1200 Lbs.	Nylon	No center stripe- Black yarn one edge	Less frequent use under good lifting conditions. Nylon stretches more to help avoid shock loading.*
 <b>Dura-Web 2000</b>	5/16"	2000 Lbs.	Nylon	Two black center stripes	Heavy use under moderate to rugged lifting conditions. Abrasion resistant yarns cover entire surface.*
 <b>Dura-Web 1000</b>	3/16"	1000 Lbs.	Nylon	One black center stripe	Daily use under moderate lifting conditions. Abrasion resistant yarns cover entire surface.*

Web Slings

\*  **WARNING** Always protect synthetic slings from being cut by corners and edges. (See Page 14 for Sling Protection information)

## STANDARD WEB SLING TYPES

### Hardware Slings

*Unilink* and *Web-Trap* hardware can help to extend sling life by protecting the webbing from abrasion on rough crane hooks. Hardware can often be reused, lowering sling replacement costs.

**Type U (UU)** - Has the preferred and economical *Unilink* fitting on each end for use in a vertical, choker or basket hitch. *Unilinks* allow choking from either end to save time and vary wear points. See page 34.

**Type 1 (TC)** - Has a *Web-Trap* triangle and choker fitting on either end. Typical use is in a choker hitch. Can also be used in vertical and basket hitches.

**Type 2 (TT)** - Has a *Web-Trap* triangle on each end. Normally used in a basket hitch, but can also be used in a vertical hitch. They cannot be used as a choker.

### Eye Type

**Type 3 (EE)** - Flat Eye slings are very popular and can be used in all three types of hitches. They are easier to remove from beneath the load than sling Types 1, 2 and 4. Unless Type 4 is requested, Type 3 will be supplied as the standard EE sling.

**Type 4 (EE)** - Twisted Eye slings are similar to Type 3 except the eyes are turned 90° to form a better choker hitch. The eyes of a Type 4 nest better on the crane hook.

### Endless Type

**Type 5 (EN)** - Endless slings are versatile and the most economically priced. They can be used in all three types of hitches. The sling can be rotated to minimize wear. The sling legs can be spread for improved load balance.

### Reverse Eye Type

**Type 6 (RE)** - An endless sling with butted edges sewn together to double the sling width. They have reinforced eyes and wear pads on both sides of body and eyes for premium wear resistance.



Type U



Type 1

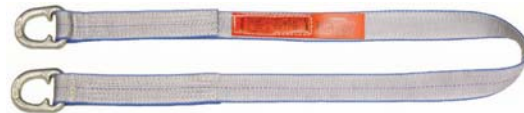

Type 2



Type 3



Type 4

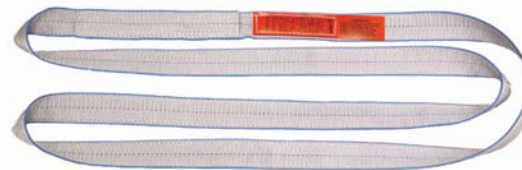

Type 5



Type 6

## WEB SLING EYE TREATMENTS

**Eye Wear Pads** - The eyes of web slings are often subjected to the harsh treatment of rough crane hooks. Specialty eye treatments are available to help reduce the wear in that area, thereby extending sling life. The following photos illustrate the more common eye treatments using wear resistant webbing in various forms. Should you want non-standard eye treatment on your eye & eye web slings, please specify using the terminology below.

### Type 3 - Flat Eyes



Standard Style



Lined Bearing Point



Fully Lined Eye



Wrapped Bearing Point



Fully Wrapped Eye

### Type 4 - Twisted Eyes



Textured nylon wear resistant webbing is standard for these eye treatments. Other pad materials are available (see page 14).

**Tapering Eyes** - As a standard practice, the eyes, or bearing points of sling Types 3 and 4 are tapered to accommodate a crane hook on slings that are 3" and wider. Untapered eyes are available upon request. Type 5 (Endless) slings are NOT tapered unless specified on order. Dura-Web 2000 slings are not tapered in any width.

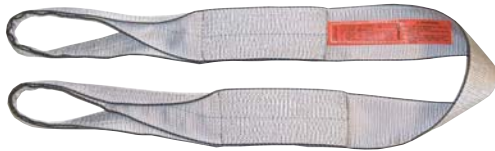

Type 3 - Flat Eyes

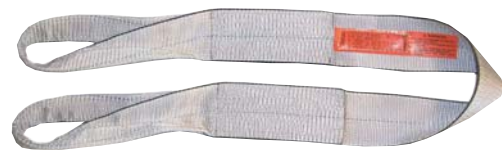

Type 4 - Twisted Eyes



Type 5 - Endless  
(Showing Taper)

Web Slings

## ENVIRONMENTAL CONSIDERATIONS & OUTDOOR USE

Web Slings

Exposure to sunlight, and other environmental factors such as dirt or gritty matter and cyclical changes in temperature and humidity, can result in an accelerated deterioration of web slings. The rate of this deterioration varies with the level of exposure and with the thickness of the sling material.

Visible indication of such environmental deterioration can include the following:

- Fading of webbing color
- Uneven or disoriented surface yarn of the webbing
- Shortening of the sling length
- Reduction in elasticity of the sling due to exposure to sunlight, often evident by accelerated abrasive damage to the surface yarns of the sling
- Breakage or damage to yarn fibers, often evident by a fuzzy appearance of the web
- Stiffening of the web, evident when web slings are exposed to outdoor conditions

### Anti-Abrasion Treatment

As a standard, *Lift-All* webbing is treated for abrasion. Natural, untreated webbing is available upon request.

Note: Heavy duty treatments are available as a supplement process for greater protection.

**Elasticity** - The stretch characteristics of web slings depends on the type of yarn and the web finish. Approximate stretch at RATED SLING CAPACITY is:

NYLON		POLYESTER	
Treated	10%	Treated	7%
Untreated	6%	Untreated	3%

Prior to sling selection and use, review and understand the "Help" section.

### Sling Length Tolerance for Web Slings

Sling Type	Tolerance *
1 Ply	± (1.5" + 1.5% of sling length)
2 Ply	± (2.0" + 2% of sling length)
3 & 4 Ply	± (3.0" + 3% of sling length)

\* For web sling widths wider than 6", add 1/2" to these values. For tighter tolerance or matched set length requirements, please consult with Customer Service.

### WARNING

Read Definition on page 3

### Sunlight / UV Exposure Service Life

Nylon and polyester web slings possess a limited useful outdoor service life due to the degradation caused by exposure to sunlight, or other measurable sources of UV radiation.

Lift-All web slings that are regularly exposed to outdoor conditions should be identified with the date they are placed into service, and should be proof tested to twice their rated capacity every six months.

Lift-All nylon and polyester web slings shall be permanently removed from service when the cumulative outdoor exposure has reached these limits:

- 2 years for 1 ply and 2 ply web slings
- 3 years for 3 ply and 4 ply web slings

### Temperature

Nylon and polyester are seriously degraded at temperatures above 200°F.

### Chemical Environment Data

Many chemicals have an adverse effect on nylon and polyester. The Chemical chart below is a general guide only. For specific temperature, concentration and time factors, please consult *Lift-All* prior to purchasing or use.

CHEMICAL	OK / NO	
	NYLON	POLYESTER
Acids		*
Alcohols		
Aldehydes		
Alkalis		
Bleaching Agents		
Dry Cleaning Solvents		
Ethers		
Halogenated Hydro-Carbons		
Hydro-Carbons		
Ketones		
Oils Crude		
Oils Lubricating		
Soap & Detergents		
Water & Seawater		
Weak Alkalis		

\* Disintegrated by concentrated sulfuric acid.



## HOW TO ORDER

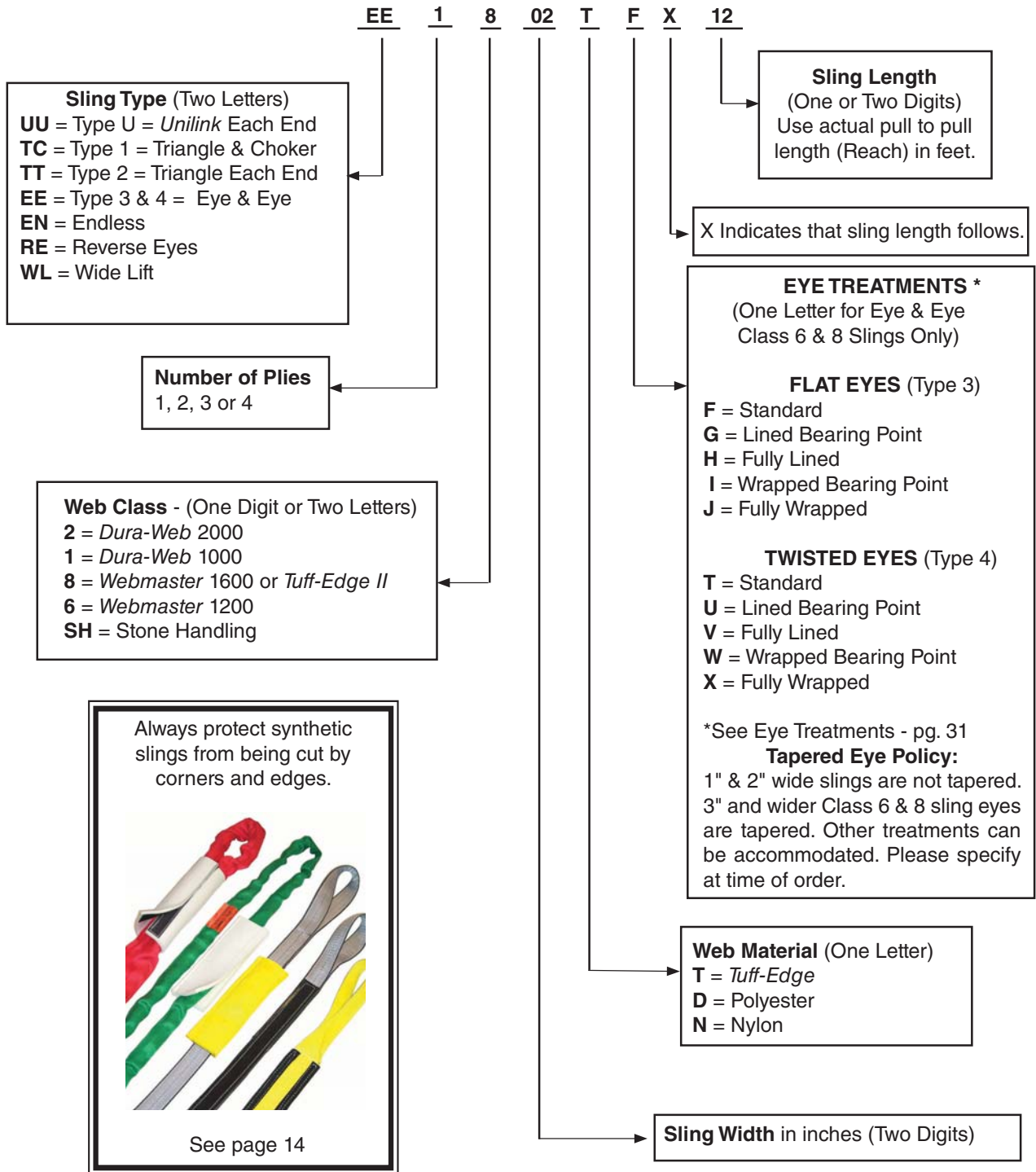

Web Slings

## WEB SLING HARDWARE

### Steel *Unilink* Web Sling Hardware Combination Triangle and Choker Fitting

This forged, high carbon steel fitting, functions as both a triangle and choker.

#### Features, Advantages and Benefits

##### Promotes Safety

- Forged steel for strength and reliability
- Smooth rounded profile helps protect sling, worker and load

##### Saves Money

- May be rewedded to reduce cost
- Powder coated finish for longer life
- *Unilinks* cost less than triangle/choker combinations

##### Saves Time

- Large Crane hook opening - speeds rigging
- Positive *Web-Trap* capture - no need to stop and reposition web
- Functions both as a triangle and a choker - choke with either end

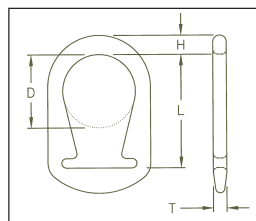

#### *Unilink* Codes And Specifications

Web Width (in.)	Part No.	Dimensions (in.)				Weight (lbs.)
		L	D	H	Thick	
2	SU2	3 11/16	2	11/16	9/16	1.1
3	SU3	5 1/16	3	7/8	5/8	2.4
4	SU4	6 3/16	4	1	3/4	4.0

Avoid contact of hardware with load edges.  
*Unilink* has the same rated capacities as TT or TC slings.

#### Forged Aluminum Triangles and Chokers

**▲ WARNING** Read Definition on page 3

Aluminum is severely degraded by alkali, caustic environments, acids and salt water.

Aluminum Triangles and Chokers are available but may only be used with single ply web slings within the rated capacities shown in the table. They should not be used with *Dura-Web* 2000 webbing.

Forged from aircraft aluminum, this tough alloy is stronger than mild steel. Aluminum has the advantages of being lightweight, non-sparking and does not rust.

Note: Aluminum triangles and chokers DO NOT offer the advantages of the *Web-Trap* feature. Aluminum fittings are not as durable and cost more than steel.

## WEB SLING HARDWARE

### Web-Trap Steel Sling Hardware - Triangles and Chokers

A significant improvement in triangle and choker design - featuring positive web capture. Webbing can slip to the side of ordinary fittings, not with *Web-Trap*. These fittings feature alloy steel for lighter sling weight and a powder coated finish to inhibit rust.

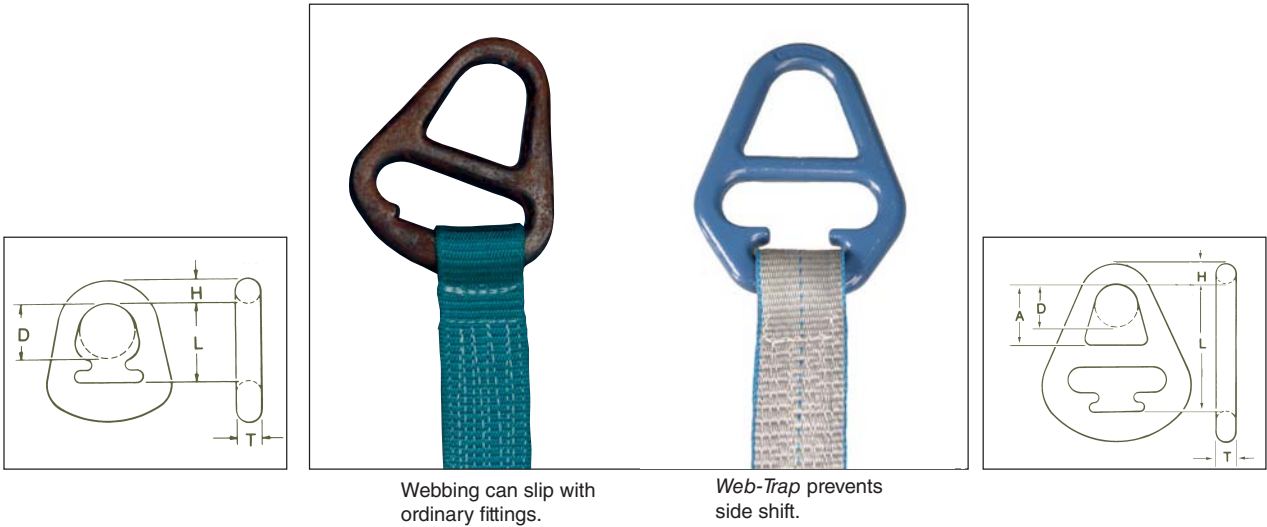

Webbing can slip with ordinary fittings.

Web-Trap prevents side shift.

Web Slings

### Alloy Steel - For One Or Two Ply Slings

Web-Trap Triangles							Web-Trap Chokers						
Web Width	Part No.	Dimensions (in.)				Weight (lbs.)	Part No.	Dimensions (in.)				Weight (lbs.)	
		L	D	T	H			L	A	D	T		H
*2"	ST-2	2 3/8	1 3/4	9/16	5/8	1.0	SC-2	5	2 7/16	1 3/4	9/16	11/16	1.9
*3"	ST-3	3 7/16	2	1/2	3/4	1.9	SC-3	6 1/4	3 3/8	2	1/2	3/4	3.6
*4"	ST-4	4 1/8	2 3/8	1/2	13/16	2.8	SC-4	7	4	2 3/8	1/2	13/16	5.1
6"	ST-6	5 9/16	3 1/8	3/4	1 1/16	6.3	SC-6	8 7/8	4 3/4	3 1/8	3/4	1 1/16	12

### Alloy Steel - For One Ply Slings

Web-Trap Triangles							Web-Trap Chokers						
Web Width	Part No.	Dimensions (in.)				Weight (lbs.)	Part No.	Dimensions (in.)				Weight (lbs.)	
		L	D	T	H			L	A	D	T		H
8"	ST1-8	6 1/2	4	1/2	1 1/4	8	SC1-8	11 1/4	7 1/2	4	1/2	1 7/16	16
10"	ST1-10	8 1/4	5	3/4	1 7/16	16	SC1-10	12 7/8	8 1/4	5	3/4	1 1/2	28
12"	ST1-12	8 3/4	5 1/2	3/4	1 3/4	20	SC1-12	14 1/2	10	5 1/2	3/4	1 3/4	40

### Alloy Steel - For Two Ply Slings

Web-Trap Triangles							Web-Trap Chokers						
Web Width	Part No.	Dimensions (in.)				Weight (lbs.)	Part No.	Dimensions (in.)				Weight (lbs.)	
		L	D	T	H			L	A	D	T		H
8"	ST2-8	6 1/2	4	3/4	1 1/4	12	SC2-8	11 1/4	7 1/2	4	3/4	1 7/16	25
10"	ST2-10	8 1/4	5	1	1 7/16	21	SC2-10	12 7/8	8 1/4	5	1	1 1/2	38
12"	ST2-12	8 3/4	5 1/2	1	1 3/4	27	SC2-12	14 1/2	10	5 1/2	1	1 3/4	54

\* Unlink is standard fitting - Triangle and chokers available on special order only.

# TUFF-EDGE<sup>®</sup> II

2X Stronger After Abrasion  
2X Better Edge Cut Resistance

## Tuff-Edge II Polyester Web Slings

You can expect longer sling life and lower overall costs when you switch to **Tuff-Edge II** slings. Resistance to the two properties that can rapidly degrade webbing, abrasion and edge cutting, is greatly improved with the use of our **Tuff-Edge II** webbing.

Using Federal Test Method 191A, **Tuff-Edge II** webbing was tested against standard yellow polyester webbing. After being subjected to the same number of hex bar abrasion cycles, the **Tuff-Edge II** webbing, with its' special silver treatment, achieved average break strengths that were twice that of the standard yellow webbing!

In a test developed specifically to measure edge cutting properties, the cut depth on the **Tuff-Edge II** webbing with special polymer edge yarns cut less than half the depth of the standard yellow polyester without the special edge yarns.

Although you should **always** pad and protect synthetic slings from load edges, normal wear and tear should be greatly reduced when using **Tuff-Edge II**, giving you greater sling life and reduced sling costs.



### Tuff-Edge II Features, Advantages and Benefits

#### Promotes Safety

- Red Core yarn warning system aids in the inspection process
- *Tuff-Tag* provides serial numbered identification for traceability
- Proven sling web construction

#### Saves Money

- Special polymer coated edge yarns improve edge cutting and abrasion to extend sling life
- Silver colored web treatment fights abrasion for additional sling life
- *Tuff-Tag* provides required OSHA information for the life of the sling, not just the life of the tag

#### Saves Time

- Easy identification - silver body, blue edges, blue center stripe

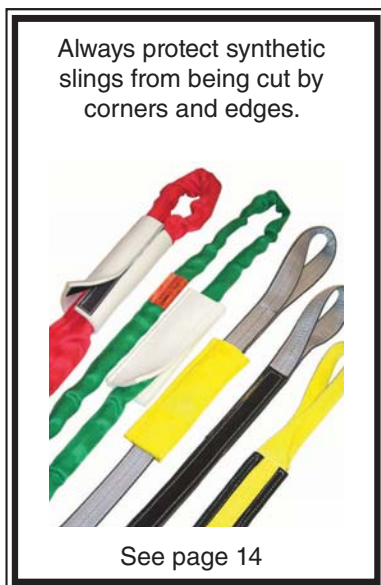

## TUFF-EDGE WORKS!

**WIRE ROPE & RIGGING CONSULTANTS**

Ship/Mail • 9428 Old Pacific Hwy  
Woodland, WA 98674

**CRANE & EQUIPMENT TRAINING**

Voice • (800) 727-6355 • (360) 225-1100  
Fax • (360) 225-1122  
www.wrrc.com • E-Mail • rig@wrrc.com

January 4, 2001

We have about 400 slings in use at our Crane & Rigging Training Center in Woodland, WA, along with a major assortment of rigging hardware from almost every major manufacturer in the U.S. In the training center, our participants rig and move loads which are 1 to 6 ton. Most of the loads are rigged with synthetic web slings and some roundslings. We have about 80 LiftAll slings on the property, which are used with our gantry and mobile cranes.

Our rigging takes a beating like everyone else's, even using wear pads on most lifts. Mr. Dave Pelkey, one of our Woodland based trainers helps instruct our students to inspect their slings on a use-by-use basis. As a result of the lift-by-lift, daily, monthly and annual inspections he discovered something that really surprised all of us.

Your Tuff-Edge web slings have an amazing ability to endure heavy usage where other web slings do not. Every training program we watch our students use the Tuff-Edge slings right along with other sling types in reasonably equal amounts. They seem to do a much better job resisting the common types of abrasion, crushing and surface nicking. We seem to be rejecting only 1 Tuff-Edge type sling for every 10 regular synthetic web slings.

Even though we instruct our students to use wear pads, it is not always feasible for every lift. Often slight damage occurs against a semi-smooth surface as a result of high p.s.i. and tightening during the lift. The Tuff-Edge slings seem to survive extremely well, when other slings made of standard nylon or polyester begin to show physical evidence of wear and tear.

Due to our independent place in the crane and rigging industry, we rarely make comments about the products manufactured for general use. In this case, I thought we should at least extend a compliment to the developers and designers of the Tuff-Edge sling. We intend on replacing our inventory with Tuff-Edge slings as the other brands wear out. It will be an excellent investment for us, with a great return. Keep up the good work!

Mike Parnell  
President

Charter Member

WRRC & CET are divisions of Industrial Training International, Inc.

ISO 9001 Certified

**THE OHIO BROACH & MACHINE COMPANY**  
35264 TOPPS INDUSTRIAL PARKWAY • WILLETTSBORO, OHIO 44094 • USA  
PHONE: 440.946.1040 • FAX: 440.946.0475 • email: sales@ohio-broach.com • http: www.ohio-broach.com

February 12, 2001

While looking over our current inspection report, it occurred to me that we really haven't been disposing of as many slings as we have in the past. Upon closer review, it appears that most of the slings that Ohio Broach has in service are your silver Tuff-Edge type.

A couple of years back when Ohio Broach started to replace the bad slings with your Tuff-Edge slings, the rejection rate during inspections of our nylon slings was at least in the +50% range. Since then the rejection rate has dropped dramatically. This past year it was as low as 18%.

Having our slings last longer has saved the company money and more importantly, it provides Ohio Broach with a safer work environment.

I would definitely recommend your Tuff-Edge product to anyone who uses nylon slings.

Thank you for your time and efforts that keep our work place safe.

Sincerely,

Neil Van De Motter

Production Control Manager

BROACHES • OHIO BROACHING MACHINES • BROACH SHARPENING • PRODUCTION BROACHING

## Webmaster 1600 Nylon and Polyester\* Slings The Traditional Standard for Heavy Duty Slings

This grade of synthetic web sling is popular because most users consider its' strength and service life to be a good buy.

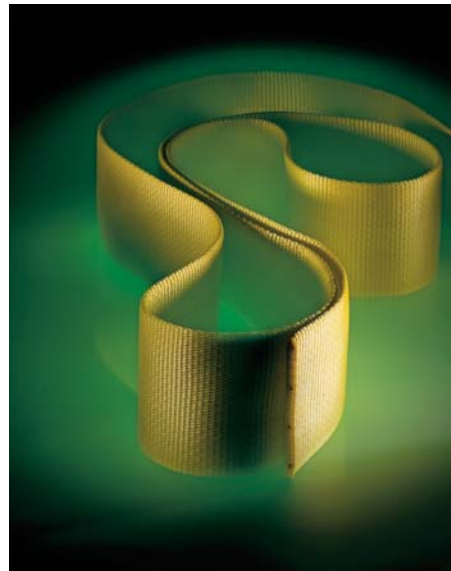

### Features, Advantages and Benefits

#### Promotes Safety

- Red core yarn warning system aids in the inspection process
- *Tuff-Tag* provides serial numbered identification for traceability
- Proven sling web construction

#### Saves Money

- Yellow treatment for abrasion resistance and extended sling life
- *Tuff-Tag* provides required OSHA information for the life of the sling, not just the life of the tag.

\* Note: Polyester web is identified by single blue surface stripe.

Web Slings

## TUFF-EDGE AND WEBMASTER 1600 POLYESTER SLINGS

### Type U Unilink Hardware Slings

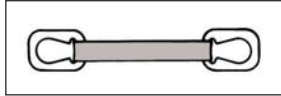

(Also available as Types 1 & 2 at same Rated Capacities)

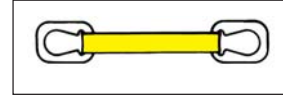

	Tuff-Edge II Part No.	Web Width (in.)	Rated Capacity (lbs.)*			Webmaster Part No. ***
			Vertical	Choker	V. Basket	
One Ply	UU1802T	2	3,200	2,500	6,400	UU1802D
	UU1803T	3	4,800	3,800	9,600	UU1803D
	UU1804T	4	6,400	5,000	12,800	UU1804D
Two Ply	UU2802T	2	6,400	5,000	12,800	UU2802D
	UU2803T	3	8,800	7,040	17,600	UU2803D
	UU2804T	4	11,500	9,200	23,000	UU2804D

### Type 1 (TC) and Type 2 (TT) Web-Trap Hardware Slings

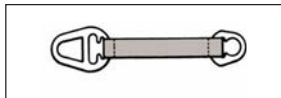

Type 1 (TC)

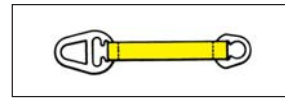

Type 1 (TC)

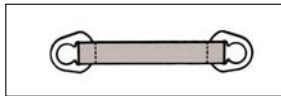

Type 2 (TT)

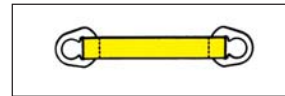

Type 2 (TT)

	Tuff-Edge II Part No.		Web Width (in.)	Rated Capacity (lbs.)*			Webmaster Part No. ***	
	Type 1	Type 2**		Vertical	Choker	V. Basket	Type 1	Type 2**
One Ply	TC1806T	TT1806T	6	9,600	7,700	19,200	TC1806D	TT1806D
	TC1808T	TT1808T	8	12,800	10,200	25,600	TC1808D	TT1808D
	TC1810T	TT1810T	10	16,000	12,800	32,000	TC1810D	TT1810D
	TC1812T	TT1812T	12	19,200	15,400	38,400	TC1812D	TT1812D
	TC1816T	TT1816T	16	25,500	20,400	51,000	TC1816D	TT1816D
	TC1816T	TT1816T	16	25,500	20,400	51,000	TC1816D	TT1816D
Two Ply	TC2806T	TT2806T	6	16,800	13,400	33,600	TC2806D	TT2806D
	TC2808T	TT2808T	8	22,400	17,900	44,800	TC2808D	TT2808D
	TC2810T	TT2810T	10	28,000	22,400	56,000	TC2810D	TT2810D
	TC2812T	TT2812T	12	33,600	26,800	67,200	TC2812D	TT2812D
	TC2816T	TT2816T	16	44,800	35,800	89,600	TC2816D	TT2816D
	TC2816T	TT2816T	16	44,800	35,800	89,600	TC2816D	TT2816D

Note:

2", 3" and 4" Hardware Slings feature *Unilink* fittings.

(See dimensions page 34.)

*Web-Trap* Triangles and Chokers are also available.

(See dimensions page 35.)

Three and four ply hardware slings and wider width hardware slings are available upon request.

\*\* Type 2 (TT) can not be used in a choker hitch.

\*\*\* Replace the "D" with an "N" to order nylon. (See "How to Order" on page 33.)



**WARNING**

Do not exceed rated capacities. Sling tension increases as the angle from horizontal decreases. Slings should not be used at angles of less than 30°. Refer to Effect of Angle chart page 12.

## TUFF-EDGE AND WEBMASTER 1600 POLYESTER SLINGS

### Eye and Eye Slings (Flat or Twisted)

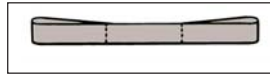

Type 3 (Flat Eye-F)

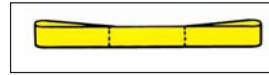

Type 3 (Flat Eye-F)

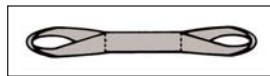

Type 4 (Twisted Eye-T)

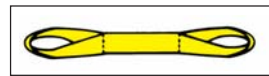

Type 4 (Twisted Eye-T)

	Tuff-Edge II Part No.	Web Width (in.)	Rated Capacity * (lbs.)			Webmaster Part No. ***
			Vertical	Choker	V. Basket	
One Ply	EE1801TF	1	1,600	1,280	3,200	EE1801DF
	EE1802TF	2	3,200	2,500	6,400	EE1802DF
	EE1803TF	3	4,800	3,800	9,600	EE1803DF
	EE1804TF	4	6,400	5,000	12,800	EE1804DF
	EE1806TF	6	9,600	7,700	19,200	EE1806DF
	EE1808TF	8	12,800	10,200	25,600	EE1808DF
Two Ply	EE1810TF	10	16,000	12,800	32,000	EE1810DF
	EE1812TF	12	19,200	15,400	38,400	EE1812DF
	EE2801TF	1	3,200	2,500	6,400	EE2801DF
	EE2802TF	2	6,400	5,000	12,800	EE2802DF
	EE2803TF	3	8,800	7,040	17,600	EE2803DF
	EE2804TF	4	11,500	9,200	23,000	EE2804DF
Three Ply	EE2806TF	6	16,500	13,200	33,000	EE2806DF
	EE2808TF	8	19,200	15,400	38,400	EE2808DF
	EE2810TF	10	22,400	17,900	44,800	EE2810DF
	EE2812TF	12	26,900	21,500	53,800	EE2812DF
	EE3801TF	1	4,100	3,300	8,200	EE3801DF
	EE3802TF	2	8,300	6,600	16,600	EE3802DF
Four Ply	EE3803TF	3	12,500	10,000	25,000	EE3803DF
	EE3804TF	4	16,000	12,800	32,000	EE3804DF
	EE3806TF	6	23,000	18,400	46,000	EE3806DF
	EE3808TF	8	30,700	24,500	61,400	EE3808DF
	EE3810TF	10	36,800	29,400	73,600	EE3810DF
	EE3812TF	12	44,000	35,200	88,000	EE3812DF
Four Ply	EE4801TF	1	5,000	4,000	10,000	EE4801DF
	EE4802TF	2	10,000	8,000	20,000	EE4802DF
	EE4803TF	3	14,900	11,900	29,800	EE4803DF
	EE4804TF	4	19,800	15,800	39,600	EE4804DF
	EE4806TF	6	29,800	23,800	59,600	EE4806DF
	EE4808TF	8	39,700	31,700	79,400	EE4808DF
	EE4810TF	10	49,600	39,600	99,200	EE4810DF
	EE4812TF	12	59,500	47,600	119,000	EE4812DF

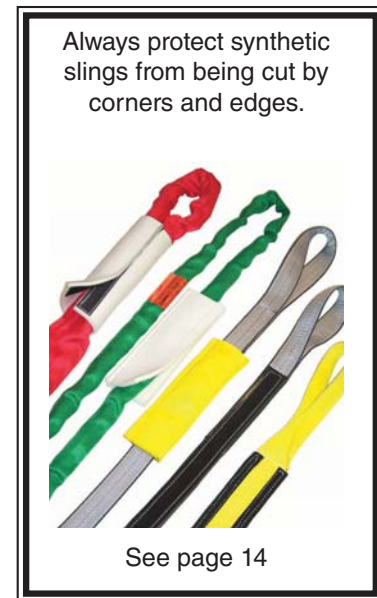

See page 14

**Note:**

Tapering - Types 3 and 4 slings are tapered at 3" and wider unless otherwise specified.

\*\*\* Replace the "D" with an "N" to order nylon. (See "How to Order" on page 33.)



Do not exceed rated capacities. Sling tension increases as the angle from horizontal decreases. Slings should not be used at angles of less than 30°. Refer to Effect of Angle chart page 12.

Web Slings

### Eye Length (Applies to all Web Slings)

Plies of Web	Sling Width (in.)							
	1	2	3	4	6	8	10	12
1	8 1/2	10	11	12	16	20	24	24
2	8 1/2	10	11	12	16	20	24	24
3	10	12	14	16	18	24	24	24
4	10	12	14	16	18	24	24	24

## TUFF-EDGE AND WEBMASTER 1600 POLYESTER SLINGS

### Endless Slings

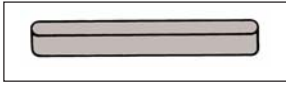

Type 5

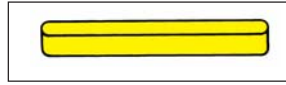

Type 5

	Tuff-Edge II Part No.	Web Width (in.)	Rated Capacity * (lbs.)			Webmaster Part No. ***
			Vertical	Choker	V. Basket	
One Ply	EN1801T	1	3,200	2,500	6,400	EN1801D
	EN1802T	2	6,400	5,000	12,800	EN1802D
	EN1803T	3	8,800	7,040	17,600	EN1803D
	EN1804T	4	11,500	9,200	23,000	EN1804D
	EN1806T	6	16,500	13,200	33,000	EN1806D
	EN1808T	8	19,200	15,400	38,400	EN1808D
Two Ply	EN1810T	10	22,400	17,900	44,800	EN1810D
	EN1812T	12	26,900	21,500	53,800	EN1812D
	EN2801T	1	6,200	4,900	12,400	EN2801D
	EN2802T	2	12,400	9,900	24,800	EN2802D
	EN2803T	3	16,300	13,000	32,600	EN2803D
	EN2804T	4	20,700	16,500	41,400	EN2804D
Three Ply	EN2806T	6	28,600	23,000	57,200	EN2806D
	EN2808T	8	30,700	24,500	61,400	EN2808D
	EN2810T	10	33,600	26,800	67,200	EN2810D
	EN2812T	12	37,600	30,000	75,200	EN2812D
	EN3801T	1	8,000	6,400	16,000	EN3801D
	EN3802T	2	16,000	12,800	32,000	EN3802D
Four Ply	EN3803T	3	21,500	17,200	43,000	EN3803D
	EN3804T	4	28,700	23,000	57,400	EN3804D
	EN3806T	6	40,700	32,500	81,400	EN3806D
	EN3808T	8	46,000	36,800	92,000	EN3808D
	EN3810T	10	51,500	41,200	103,000	EN3810D
	EN3812T	12	59,200	47,300	118,400	EN3812D
Four Ply	EN4801T	1	10,000	8,000	20,000	EN4801D
	EN4802T	2	19,800	15,800	39,600	EN4802D
	EN4803T	3	26,700	21,300	53,400	EN4803D
	EN4804T	4	35,600	28,400	71,200	EN4804D
	EN4806T	6	50,500	40,400	101,000	EN4806D
	EN4808T	8	57,600	46,000	115,200	EN4808D
Four Ply	EN4810T	10	67,200	53,700	134,400	EN4810D
	EN4812T	12	80,700	64,500	161,400	EN4812D



Note: Type 5 (Endless) slings are Not tapered unless specified.

\*\*\*Replace the "D" with an "N" to order nylon.

(See "How to Order" page 33)

**WARNING**

Do not exceed rated capacities. Sling tension increases as the angle from horizontal decreases. Slings should not be used at angles of less than 30°. Refer to Effect of Angle chart page 12.

**Tuflex is an Alternative ...**

For three and four ply slings wider than 6", *Tuflex* Roundslings should be seriously considered. *Tuflex* offers increased flexibility, ease of use and lower cost. (See page 62.)



## DURA-WEB NYLON SLINGS

### Best in Abrasion Resistance

Available in two strength classes, all *Dura-Web* slings feature premium abrasive resistant yarns covering all surfaces, for extended sling life and long term value.

### Dura-Web Features, Advantages and Benefits

Promotes Safety

- Red core yarn warning system aids in the inspection process
- Striped webbing helps identify proper capacity

- *Tuff-Tag* provides serial numbered identification for traceability

Saves Money

- Abrasion resistant fibers cover both faces and edges for greater sling life

- *Tuff-Tag* provides required OSHA information for the life of the sling, not just the life of the tag.

Saves Time

- Striped capacity for quick identification

Web Slings

### Dura-Web 2000 Capacity

Two Black stripes = 2,000 lbs. per inch of width (one ply only). 25% stronger than other webbing. The strongest abrasion resistant sling available.

Eyes of *Dura-Web* 2000 slings for Types 3-4-5 are not tapered in any width.

*Dura-Web* slings meet or exceed OSHA and ASME B30.9 requirements.



### Dura-Web 1000 Capacity

One Black Stripe = 1,000 lbs. per inch of width (one ply only). The only light duty web sling with an abrasive resistant surface. Wider bearing surface, per capacity, helps protect load surface.

*Dura-Web* slings meet or exceed OSHA and ASME B30.9 requirements.



	Part No.	Web Width (in.)	Rated Capacity (lbs.)*		
			Vertical	Choker	V. Basket
Type U					
One Ply	UU1202N	2	4,000	3,200	8,000
	UU1203N	3	6,000	4,800	12,000
	UU1204N	4	8,000	6,400	16,000
Two Ply	UU2202N	2	8,000	6,400	16,000
	UU2203N	3	10,800	8,600	21,600
	UU2204N	4	14,400	11,500	28,800
Type 3-F                      Type 4-T					
One Ply	EE1201NF	1	2,000	1,600	4,000
	EE1202NF	2	4,000	3,200	8,000
	EE1203NF	3	6,000	4,800	12,000
	EE1204NF	4	8,000	6,400	16,000
Two Ply	EE2201NF	1	4,000	3,200	8,000
	EE2202NF	2	8,000	6,400	16,000
	EE2203NF	3	10,800	8,600	21,600
	EE2204NF	4	14,400	11,500	28,800
Type 5					
One Ply	EN1201N	1	4,000	3,200	8,000
	EN1202N	2	8,000	6,400	16,000
	EN1203N	3	12,000	9,600	24,000
	EN1204N	4	16,000	12,800	32,000
Two Ply	EN2201N	1	7,800	6,200	15,600
	EN2202N	2	15,200	12,200	30,400
	EN2203N	3	20,400	16,300	40,800
	EN2204N	4	25,800	20,600	51,600

	Part No.	Web Width (in.)	Rated Capacity (lbs.)*		
			Vertical	Choker	V. Basket
Type U					
One Ply	UU1102N	2	2,000	1,600	4,000
Two Ply	UU2102N	2	4,000	3,200	8,000
Type 3-F                      Type 4-T					
One Ply	EE1101NF	1	1,000	800	2,000
	EE1102NF	2	2,000	1,600	4,000
Two Ply	EE2101NF	1	2,000	1,600	4,000
	EE2102NF	2	4,000	3,200	8,000
Type 5					
One Ply	EN1101N	1	2,000	1,600	4,000
	EN1102N	2	4,000	3,200	8,000
Two Ply	EN2101N	1	3,900	3,100	7,800
	EN2102N	2	7,600	6,100	15,200

\* **WARNING** Do not exceed rated capacities. Sling tension increases as the angle from horizontal decreases. Slings should not be used at angles of less than 30°.

## WEBMASTER 1200 SLINGS

### Webmaster 1200 Polyester Slings

Standard duty *Webmaster* 1200 is designed as an economical sling for less frequent use.

### Webmaster Features, Advantages and Benefits

Promotes Safety

- Red core yarn warning system aids in the inspection process
- Proven sling web construction
- *Tuff-Tag* provides serial numbered identification for traceability

Saves Money

- Wider bearing surface per capacity helps protect load surface
- Yellow treatment for abrasion resistance and extended sling life
- *Tuff-Tag* provides required OSHA information for the life of the sling, not just the life of the tag

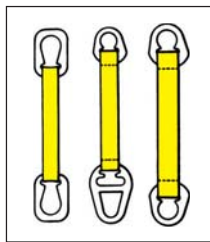

Types U, 1 and 2

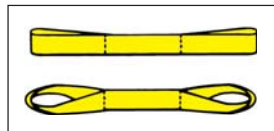

Types 3(F) and 4(T)

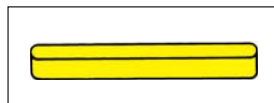

Type 5

Note:

Tapering - Types 3 and 4 slings are tapered at 3" and wider unless otherwise specified.

Type 5 (Endless) slings are NOT tapered unless specified.

### \* **WARNING**

Do not exceed rated capacities. Sling tension increases as the angle from horizontal decreases. Slings should not be used at angles of less than 30°. Refer to Effect of Angle chart page 12.

### Hardware Slings (TYPES U, 1 AND 2)

	Part No.	Rated Capacity (lbs.)*		
		Vertical	Choker	V. Basket
One Ply	UU1602D	2,400	1,900	4,800
	UU1603D	3,600	2,900	7,200
	UU1604D	4,800	3,800	9,600
	TC1606D	7,200	5,800	14,400
	TT1606D	7,200	NA	14,400
Two Ply	UU2602D	4,800	3,800	9,600
	UU2603D	6,600	5,280	13,200
	UU2604D	8,600	6,900	17,200
	TC2606D	12,600	10,100	25,200
	TT2606D	12,600	NA	25,200

### Eye and Eye Slings (TYPES 3 AND 4)

One Ply	EE1601DF	1,200	950	2,400
	EE1602DF	2,400	1,900	4,800
	EE1603DF	3,600	2,900	7,200
	EE1604DF	4,800	3,800	9,600
	EE1606DF	7,200	5,800	14,400
Two Ply	EE2601DF	2,400	1,900	4,800
	EE2602DF	4,800	3,800	9,600
	EE2603DF	6,600	5,280	13,200
	EE2604DF	8,600	6,900	17,200
	EE2606DF	12,300	9,840	24,600
Three Ply	EE3601DF	3,500	2,800	7,000
	EE3602DF	7,000	5,600	14,000
	EE3603DF	9,400	7,500	18,800
	EE3604DF	12,000	9,600	24,000
	EE3606DF	18,000	14,400	36,000
Four Ply	EE4601DF	4,200	3,400	8,400
	EE4602DF	8,000	6,400	16,000
	EE4603DF	12,000	9,600	24,000
	EE4604DF	16,000	12,800	32,000
	EE4606DF	23,500	18,800	47,000

### Endless Slings (TYPE 5)

One Ply	EN1601D	2,400	1,900	4,800
	EN1602D	4,800	3,800	9,600
	EN1603D	6,500	5,200	13,000
	EN1604D	8,600	6,900	17,200
	EN1606D	12,200	9,800	24,400
Two Ply	EN2601D	4,800	3,800	9,600
	EN2602D	9,600	7,700	19,200
	EN2603D	11,700	9,400	23,400
	EN2604D	15,500	12,400	31,000
	EN2606D	22,500	18,000	45,000
Three Ply	EN3601D	6,200	4,900	12,400
	EN3602D	12,500	10,000	25,000
	EN3603D	16,300	13,000	32,600
	EN3604D	20,600	16,400	41,200
	EN3606D	29,300	23,400	58,600
Four Ply	EN4601D	7,700	6,200	15,400
	EN4602D	15,500	12,400	31,000
	EN4603D	20,800	16,600	41,600
	EN4604D	26,600	21,200	53,200
	EN4606D	37,800	30,200	75,600

## REVERSE EYE SLINGS

### Reverse Eye (RE) Slings

The Best General Purpose Web Sling Available

The Reverse Eye Sling is a modified endless sling, reinforced and protected on all sides. The most rugged and versatile of all web slings. The *Lift-All* enhanced version incorporates premium wear resistant webbing for protection on ALL surfaces.

### Reverse Eye Features, Advantages and Benefits

Promotes Safety

- Superior choke hitch performance grips load securely
- Reinforced eyes augment strength
- Red core yarn warning system aids in the inspection process
- *Tuff-Tag* provides serial numbered identification for traceability

Saves Money

- Wear resistant web cover offers superior abrasion resistance and sling life
- Reversible eyes reduce wear and increase sling life
- Top grade slings using *Tuff-Edge* webbing are armored on all four sides resulting in the toughest web sling available

Saves Time

- Eyes nest well on crane hook for easy rigging
- Flat eye construction is available to facilitate removal from under loads

There are two grades of *Lift-All* Reverse Eye Slings: *Tuff-Edge* and *Webmaster* 1200.

The Reverse Eye Sling is Not Just an Endless Sling with Wear Pads.



Single Ply Endless with Reinforced Eyes  
 A. Extended web length makes 2 Ply eyes.  
 B. Reinforcing web piece sewn on to make 2 Ply eye.

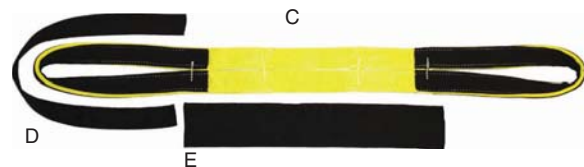

Added Wear Pads to Both Sides of Body and Eyes.  
 C. Single Ply Endless Sling with butted sides.  
 D. Texturized Wear Pads on both sides of eyes.  
 E. Texturized Wear Pads sewn on both sides of body.



Completed RE sling may be 1-2 or 3 ply endless sling with reinforcing webbing for each loop, and texturized wear pad on each side of eyes and sling body.

### Heavy Duty RE Slings - *Tuff-Edge*

### Standard Duty RE Slings - *Webmaster* 1200

	Part No.	Rated Capacity (lbs.)*			Sling Thickness (in.)	Sling Width (in.)	Eye Length (in.)	Part No.	Rated Capacity (lbs.)*			Sling Thickness (in.)
		Vertical	Choker	V. Basket					Vertical	Choker	V. Basket	
One Ply	RE1802T	4,500	3,600	9,000	5/16	2	9	RE1602N	3,600	2,900	7,200	1/4
	RE1804T	7,700	6,200	15,400	5/16	4	12	RE1604N	6,800	5,400	13,600	1/4
	RE1806T	11,000	8,800	22,000	5/16	6	15	RE1606N	8,000	6,400	16,000	1/4
Two Ply	RE2802T	6,500	5,200	13,000	1/2	2	9	RE2602N	5,200	4,200	10,400	3/8
	RE2804T	13,000	10,400	26,000	1/2	4	12	RE2604N	10,500	8,400	21,000	3/8
	RE2806T	20,000	16,000	40,000	1/2	6	15	RE2606N	14,400	11,500	28,800	3/8
Three Ply	RE3804T	16,400	13,100	32,800	11/16	4	14	RE3604N	14,000	11,200	28,000	1/2
	RE3806T	25,500	20,400	51,000	11/16	6	18	RE3606N	20,000	16,000	40,000	1/2

Reverse eye slings using *Webmaster* 1600 webbing are available on special order.

\* **WARNING** Do not exceed rated capacities. Sling tension increases as the angle from horizontal decreases. Slings should not be used at angles of less than 30°. Refer to Effect of Angle chart page 12.

## TUFF-EDGE II HARDWARE / BRIDLE SLINGS

### Hardware/Bridle Slings

Useful when fixed lifting points are available.

### Features, Advantages and Benefits

Web Slings

#### Promotes Safety

- *Tuff-Edge II* web material is standard - helps prevent sling damage
- Better load control and balance by using fixed fitting points and multiple legs
- Standard oblong links and hooks are forged from alloy steel for strength and reliability
- Red core yarn warning system aids in the inspection process
- Hardware avoids cutting and abrasion of sling at bearing points
- *Tuff-Tag* provides serial numbered identification for traceability
- Proven sling web construction

#### Saves Money

- Soft web sling legs protect load
- Endless type allows shifting of wear points
- *Tuff-Edge II* material extends sling life
- Sling hooks and links can be rewedded
- *Tuff-Tag* provides required OSHA information for the life of the sling, not just the life of the tag

#### Saves Time

- Lighter weight and easier to use than chain or wire rope
- Sling hooks quickly connect to loads having hoist rings or eye bolts

### How to Order

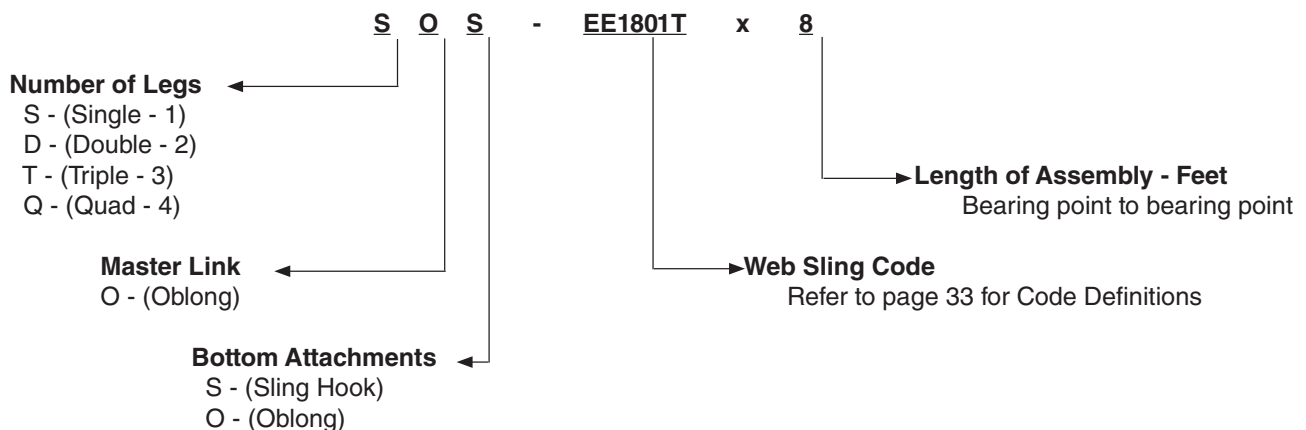

## TUFF-EDGE II HARDWARE / BRIDLE SLINGS

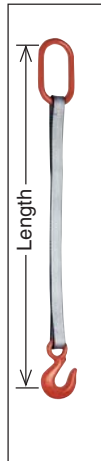

SOS  
Single Leg  
Oblong Link  
Sling Hook  
(EE1801T)

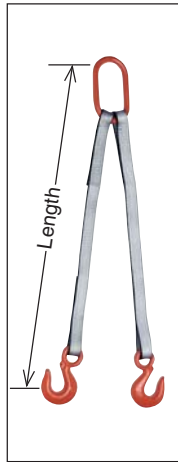

DOS  
Double Leg  
Oblong Link  
Sling Hook  
(EE1801T)

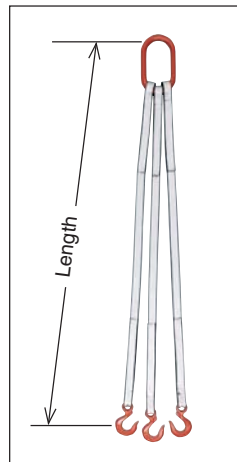

TOS  
Triple Leg  
Oblong Link  
Sling Hook  
(EE1801T)

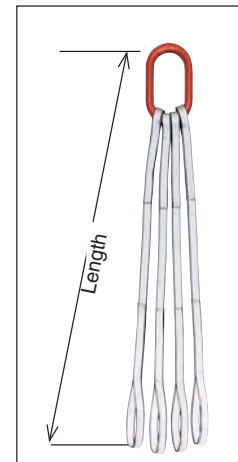

QOE  
Quad Leg  
Oblong Link  
(EE1801T)

Web Slings



### Hardware/Bridle Slings

Part No. For Web Sling Legs	Web Width (in.)	Web Plies	Number of Legs	Rated Capacity (lbs.)*				Alloy Sling Hook	Oblong Link
				Vertical	@ 60°	@ 45°	@ 30°	Size	Dia. (in.)
EE1801T	1	1	Single	1,600				1TA	1/2
	1	1	Double		2,700	2,200	1,600	1TA	1/2
	1	1	Triple		4,100	3,300	2,400	1TA	3/4
	1	1	Quad		5,500	4,500	3,200	1TA	1
EE2801T	1	2	Single	3,000				1 1/2TA	1/2
	1	2	Double		5,100	4,200	3,000	1 1/2TA	3/4
	1	2	Triple		7,700	6,300	4,500	1 1/2TA	3/4
	1	2	Quad		10,300	8,400	6,000	1 1/2TA	1
EE1802T	2	1	Single	3,000				1 1/2TA	1/2
	2	1	Double		5,100	4,200	3,000	1 1/2TA	3/4
	2	1	Triple		7,700	6,300	4,500	1 1/2TA	3/4
	2	1	Quad		10,300	8,400	6,000	1 1/2TA	1
EE2802T	2	2	Single	6,000				3TA	3/4
	2	2	Double		10,300	8,400	6,000	3TA	1
	2	2	Triple		15,500	12,700	9,000	3TA	1
	2	2	Quad		20,700	16,900	12,000	3TA	1 1/4

NOTE: Hardware capacities correspond to the appropriate sling capacities. See hardware dimension charts starting on page 91



### WARNING

Do not exceed rated capacities. Sling tension increases as the angle from horizontal decreases. Slings should not be used at angles of less than 30°. Refer to Effect of Angle chart page 12.

## WIDE-LIFT SLINGS

### Wide-Lift (WL) Slings

#### Wide Load Support and Balance

Lift-All Wide-Lift slings support the load over a wide area to offer better balance for large loads - whether heavy or light. Wide bearing area reduces marring of soft load surfaces. Stiffeners are used at the base of the eyes to deter the body webbing from folding down the middle. Wide-Lift slings are for use in basket hitch only. Standard web material is *Webmaster* 1600 nylon. Polyester is available upon request.

#### All Wide-Lift Slings offer these benefits:

Promotes Safety

- Red Core Yarn warning system aids in the inspection process
- *Tuff-Tag* provides serial numbered identification for traceability
- Proven sling web construction

Saves Money

- Wide bearing area reduces marring of soft load surfaces
- Yellow treatment for abrasion resistance and extended sling life
- *Tuff-Tag* provides required OSHA information for the life of the sling, not just the life of the tag



**Attached Eye Wide-Lift**



**Continuous Eye Wide-Lift**

**For Light, Bulky Loads** - Lifting eyes are attached to a single ply sling body. Available with One Ply eyes (WLA1) or Two Ply eyes (WLA2).

**For Heavy Loads** - Constructed from one endless sling with the two body lengths butted and joined side by side.

	Body Width (in.)	Part No.	Rated Capacity* (lbs.) Vertical Basket	Eye Length (in.)	Minimum Sling Length (in.)
<b>One Ply Eye</b>	6	WLA1806N	5,000	6	50
	8	WLA1808N	5,000	8	50
	10	WLA1810N	5,000	10	54
	12	WLA1812N	5,000	12	56
	16	WLA1816N	10,000	14	56
	20	WLA1820N	10,000	16	68
<b>Two Ply Eye</b>	24	WLA1824N	10,000	20	72
	6	WLA2806N	10,000	10	50
	8	WLA2808N	10,000	10	50
	10	WLA2810N	10,000	12	54
	12	WLA2812N	10,000	12	56
	16	WLA2816N	18,000	12	56
	20	WLA2820N	18,000	18	68
	24	WLA2824N	18,000	18	72
	30	WLA2830N	18,000	22	74
	36	WLA2836N	18,000	27	84
48	WLA2848N	18,000	36	102	

	Body Width (in.)	Part No.	Rated Capacity* (lbs.) Vertical Basket	Eye Length (in.)	Minimum Sling Length (in.)
<b>One Ply</b>	6	WL1806N	15,400	9	40
	8	WL1808N	20,400	12	45
	12	WL1812N	30,800	18	60
	16	WL1816N	38,000	24	72
	20	WL1820N	45,000	30	88
	24	WL1824N	52,000	36	100
<b>Two Ply</b>	30	WL1830N	45,000	45	120
	36	WL1836N	45,000	54	144
	6	WL2806N	28,600	9	40
	8	WL2808N	38,000	12	45
	12	WL2812N	57,200	18	60
	16	WL2816N	75,000	24	72
	20	WL2820N	90,000	30	88
	24	WL2824N	110,000	36	100
	30	WL2830N	90,000	45	120
	36	WL2836N	90,000	54	144

Note: Not recommended for use in a choker hitch. *Tuff-Edge II* may be used for the attached eyes. Custom slings with higher capacities are available. *Tuflex* slings are also available as Wide-Lift Slings. See page 69.

**WARNING**

Do not exceed rated capacities. Sling tension increases as the angle from horizontal decreases. Slings should not be used at angles of less than 30°. Refer to Effect of Angle chart page 12.

## STONE HANDLING SLINGS

### Stone Handling (SH) Slings

Special abrasion resistant 4-inch nylon webbing for handling stone, concrete and building panels.

*Lift-All* Stone Handling Slings feature a soft abrasion resistant wear pad woven onto the load side of the webbing, providing outstanding protection for both the sling and the polished stone surfaces.

Note: EE Sling - flat eye only - untapered 12" eye length.

### Features, Advantages and Benefits

#### Promotes Safety

- Red core yarn warning system aids in the inspection process
- *Tuff-Tag* provides serial numbered identification for traceability
- Proven sling web construction

#### Saves Money

- Heavy, soft yarns on load side to help protect the sling from abrasion
- White pile yarns prevent color transfer to load
- Two ply version results in an abrasion resistant face on both sides
- *Tuff-Tag* provides required OSHA information for the life of the sling, not just the life of the tag

#### Saves Time

- Two ply version with abrasion resistance on both sides, does not need orientation by rigger



Web Slings

	Part No.	Rated Capacity * (lbs.)		
		Vertical	Choker	V. Basket
One Ply	UU1SH4N	5,400	4,000	10,800
	EE1SH4N	5,400	4,000	10,800
	EN1SH4N	10,800	8,600	21,600
Two Ply	UU2SH4N	9,400	7,000	18,800
	EE2SH4N	9,400	7,000	18,800
	EN2SH4N	10,800	8,600	21,600

#### **WARNING**

Do not exceed rated capacities. Sling tension increases as the angle from horizontal decreases. Slings should not be used at angles of less than 30°. Refer to Effect of Angle chart page 12.

## INSPECTION CRITERIA FOR WEB SLINGS

The following photos illustrate some of the common damage that occurs to web slings, indicating that the sling should be taken out of service.

Web Slings

**THE DAMAGE: Surface and Edge Cuts** - It is important to realize that all of the fibers in web slings contribute to the strength of that sling. When there have been a significant number of fibers broken in a web sling, as shown here, that sling should be taken out of service.

**WHAT TO LOOK FOR: Broken fibers** of equal length indicate that the sling has been cut by an edge. **Red core warning yarns may or may not be visible with cuts and are not required to show before removing slings from service.**

**TO PREVENT:** Always protect synthetic slings from being cut by corners and edges by using wear pads or other devices.

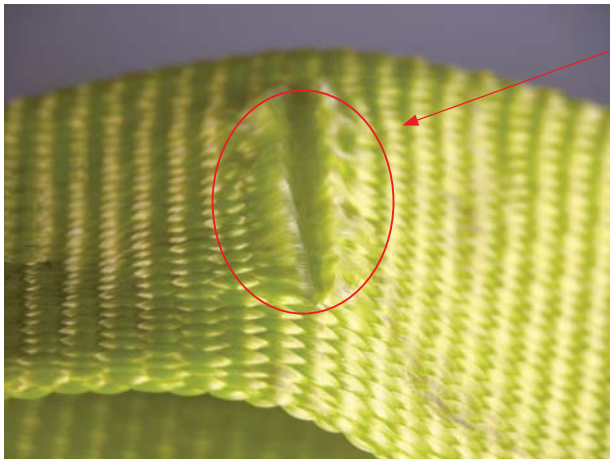
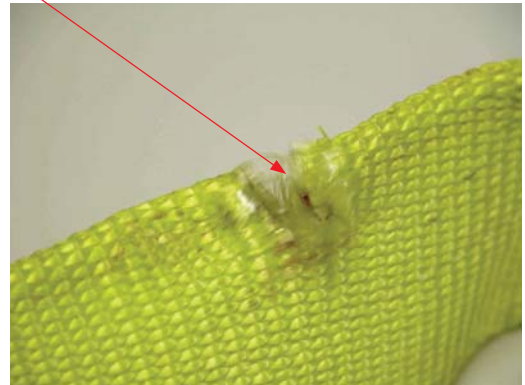
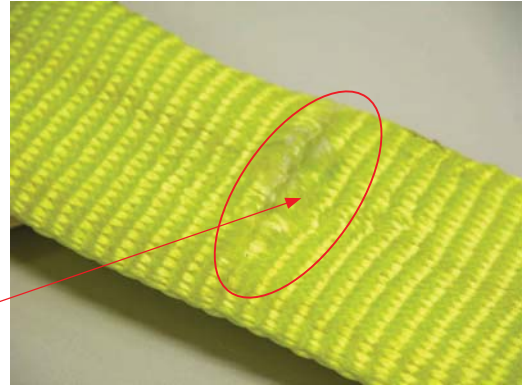

**THE DAMAGE: Holes/Snags/Pulls**

**WHAT TO LOOK FOR: Punctures or areas** where fibers stand out from the rest of the sling surface.

**TO PREVENT:** Avoid sling contact with protrusions, both during lifts and while transporting or storing.

**THE DAMAGE: Abrasion**

**WHAT TO LOOK FOR:** Areas of the sling that look and feel **fuzzy** indicate that the fibers have been broken by being subject to contact and movement against a rough surface. Affected areas are usually stained.

**TO PREVENT:** Never drag slings along the ground. Never pull slings from under loads that are resting on the sling. Use wear pads between slings and rough surface loads.

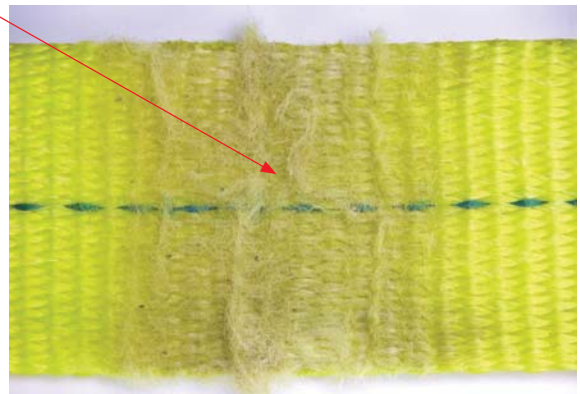
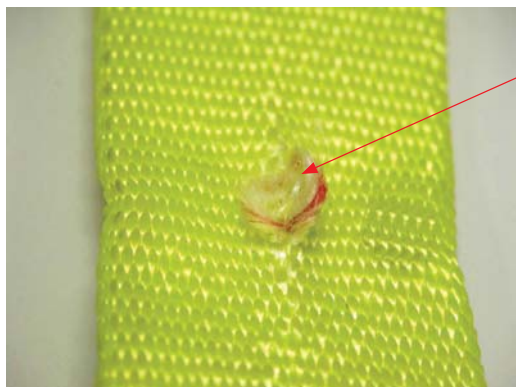



## INSPECTION CRITERIA FOR WEB SLINGS

### THE DAMAGE: **Heat/Chemical**

**WHAT TO LOOK FOR: Melted or charred fibers** anywhere along the sling. Heat and chemical damage can look similar and they both have the effect of damaging sling fibers and compromising the sling's strength. Look for discoloration and/or fibers that have been fused together and often feel hard or crunchy.

**TO PREVENT:** Never use nylon or polyester slings where they can be exposed to temperatures in excess of 200° F. Never use nylon or polyester slings in or around chemicals without confirming that the sling material is compatible with the chemicals being used.

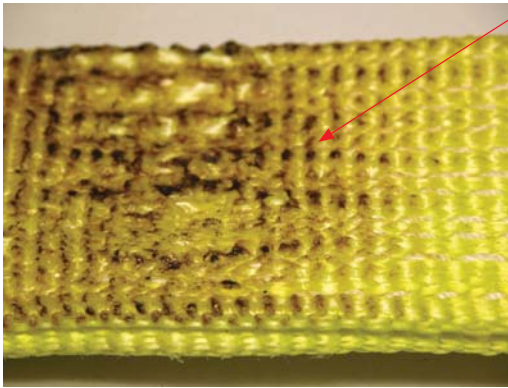

**THE DAMAGE: Broken/Worn Stitching** in the main stitch patterns of web slings has a direct adverse effect on the strength of a sling. The stitch patterns in web slings have been engineered to produce the most strength out of the webbing. If the stitching is not fully intact, the strength of the sling may be affected.

**WHAT TO LOOK FOR: Loose or broken threads** in the main stitch patterns.

**TO PREVENT:** Never pull slings from beneath loads where stitch patterns can get hung up or snagged. Never overload the slings or allow the load edge to directly contact the stitch pattern while lifting. Never place a sling eye over a hook or other attachment whose width/diameter exceeds 1/3 the eye length.

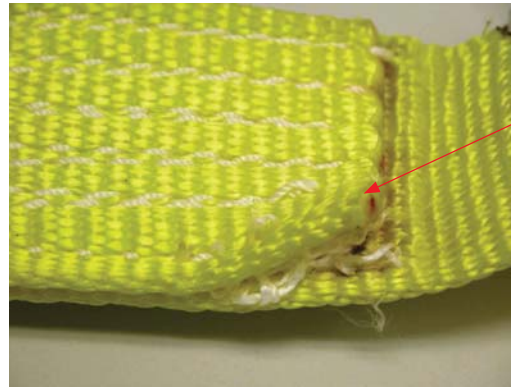

**THE DAMAGE: Knots** compromise the strength of all slings by not allowing all fibers to contribute to the lift as designed. Knots may reduce sling strength by up to 50%.

**WHAT TO LOOK FOR: Knots** are rather obvious problems as shown below.

**TO PREVENT:** Never tie knots in slings and never use slings that are knotted.

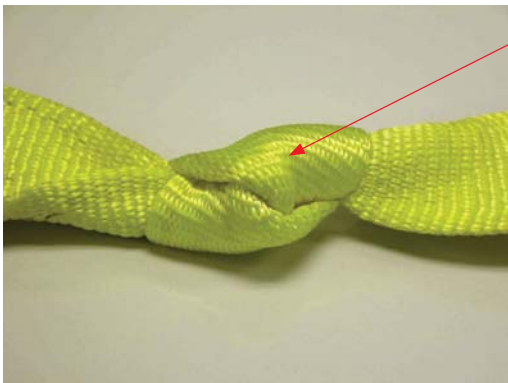

**THE DAMAGE: Illegible or Missing Tags**- The information provided by the sling tag is important for knowing what sling to use and how it will function.

**WHAT TO LOOK FOR:** If you cannot find or read all of the information on a sling tag, OSHA requires that the sling shall be taken out of service.

**TO PREVENT:** Never set loads down on top of slings or pull sling from beneath loads if there is any resistance. Load edges should never contact sling tags during the lift. Avoid paint or chemical contact with tags.

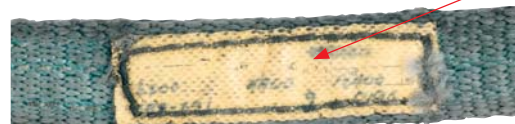

**Red Core Yarns** - are an **additional** aid to warn of dangerous sling damage. All standard *Lift-All* Web Slings have this warning feature. The red core yarns become exposed when the sling surface is cut or worn through the woven face yarns. When red yarns are visible, the sling should be removed from service immediately. For other inspection criteria see OSHA/Manufacturer regulations on pages 7 through 10.

## WEB SLING WEIGHTS (Approx.)\*



Web Slings



Type U (UU)

Part No.	Minimum Standard Length		Add'l. Ft.
	Ft.	Wt.** (lbs.)	Wt. (lbs.)

### Unilink Style

UU1802	3	2.7	0.12
UU1803	3	5.6	0.18
UU1804	4	9.2	0.24
UU2802	3	2.9	0.25
UU2803	3	5.8	0.38
UU2804	3	9.2	0.50

### Triangle & Choker Style



TC1802	3	3.5	0.12
TC1803	3	6.3	0.18
TC1804	4	9.0	0.24
TC1806	4	21	0.36
TC1808	5	27	0.48
TC1810	5	48	0.60
TC1812	6	65	0.72
TC2802	3	3.6	0.25
TC2803	3	6.5	0.38
TC2804	3	9.1	0.50
TC2806	4	21	0.76
TC2808	4	39	1.0
TC2810	5	63	1.3
TC2812	5	86	1.5

### Triangle & Triangle Style



TT1802	3	2.6	0.12
TT1803	3	4.6	0.18
TT1804	3	6.7	0.24
TT1806	4	15	0.36
TT1808	5	19	0.48
TT1810	5	36	0.60
TT1812	5	44	0.72
TT2802	3	2.7	0.25
TT2803	3	4.8	0.38
TT2804	3	7.0	0.50
TT2806	3	15	0.76
TT2808	4	28	1.0
TT2810	4	46	1.3
TT2812	5	60	1.5

\* Weights will vary. Published weights are average weights for *Webmaster* 1600 slings.

\*\* Approximate weight for the minimum standard length as shown.



## WEB SLING WEIGHTS (Approx.)\*



Type 3 (Flat Eye)



Type 4 (Twisted Eye)

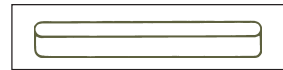

Type 5

### Eye & Eye Style

	Minimum Standard Length		Add'l. Ft. Wt. (lbs.)
	Ft.	Wt. ** (lbs.)	
EE1801	3	0.4	0.06
EE1802	4	0.9	0.12
EE1803	4	1.4	0.18
EE1804	4	1.9	0.24
EE1806	5	3.4	0.36
EE1808	6	5.3	0.48
EE1810	8	8.0	0.60
EE1812	8	9.8	0.72
EE2801	3	0.4	0.13
EE2802	3	0.9	0.25
EE2803	4	1.7	0.38
EE2804	4	2.3	0.50
EE2806	6	4.9	0.76
EE2808	6	6.5	1.0
EE2810	7	9.4	1.3
EE2812	8	13	1.5
EE3801	4	1.0	0.20
EE3802	4	2.1	0.40
EE3803	5	3.7	0.59
EE3804	5	5.0	0.79
EE3806	5	7.6	1.2
EE3808	7	13	1.6
EE3810	7	16	2.0
EE3812	7	20	2.4
EE4801	4	1.1	0.26
EE4802	4	2.2	0.53
EE4803	5	4.1	0.79
EE4804	5	5.5	1.1
EE4806	5	8.3	1.6
EE4808	7	15	2.1
EE4810	7	19	2.6
EE4812	7	23	3.2

### Endless Style

	Minimum Standard Length		Add'l. Ft. Wt. (lbs.)
	Ft.	Wt. ** (lbs.)	
EN1801	3	0.4	0.12
EN1802	3	0.8	0.24
EN1803	3	1.3	0.36
EN1804	3	1.7	0.48
EN1806	3	2.5	0.72
EN1808	3	3.4	0.96
EN1810	3	4.2	1.2
EN1812	3	5.0	1.4
EN2801	3	0.8	0.25
EN2802	3	1.6	0.50
EN2803	3	2.5	0.76
EN2804	3	3.3	1.0
EN2806	3	4.9	1.5
EN2808	3	6.6	2.0
EN2810	3	8.2	2.5
EN2812	3	9.9	3.0
EN3801	3	1.2	0.38
EN3802	3	2.4	0.76
EN3803	3	3.6	1.1
EN3804	3	4.8	1.5
EN3806	3	7.2	2.3
EN3808	3	9.6	3.0
EN3810	3	12	3.8
EN3812	3	14	4.5
EN4801	3	1.6	0.52
EN4802	3	3.2	1.0
EN4803	3	4.9	1.6
EN4804	3	6.5	2.1
EN4806	3	9.7	3.1
EN4808	3	13	4.2
EN4810	3	16	5.2
EN4812	3	19	6.2

\* Weights will vary. Published weights are average weights for Webmaster 1600 slings.

\*\* Approximate weight for the minimum standard length as shown.



## WEB SLING WEIGHTS (Approx.)\*

### Attached Eye Wide-Lift

Part No.	10 Ft. Sling Wt. (lbs.)	Add'l. Ft. Wt. (lbs.)
WLA1806	3.8	0.36
WLA1808	4.9	0.48
WLA1810	5.6	0.60
WLA1812	6.2	0.72
WLA1816	9.5	1.1
WLA1820	12	1.3
WLA1824	14	1.6
WLA2806	4.2	0.36
WLA2808	5.4	0.48
WLA2812	7.4	0.72
WLA2816	12	1.1
WLA2820	15	1.3
WLA2824	16	1.6
WLA2830	17	2.0
WLA2836	17	2.4
WLA2848	20	3.2

### Continuous Eye Wide-Lift

Part No.	10 Ft. Sling Wt. (lbs.)	Add'l. Ft. Wt. (lbs.)
WL1806	5.8	0.54
WL1808	7.1	0.66
WL1810	8.4	0.78
WL1812	9.7	0.90
WL1816	12	1.1
WL1820	15	1.4
WL1824	17	1.6
WL1830	23	2.2
WL1836	27	2.5
WL2806	9.4	0.9
WL2808	12	1.1
WL2812	17	1.6
WL2816	22	2.1
WL2820	27	2.6
WL2824	31	3.0
WL2830	41	4.0
WL2836	48	4.6

\* Weights will vary.  
Published weights are average weights using Webmaster 1600 webbing.

# Hull Saver Boat Slings



## LIFT-ALL HULL SAVER BOAT SLINGS

Polyester\*\* web slings designed especially for use with travel lifts to lower and retrieve large boats.

### Features, Advantages and Benefits

#### Promotes Safety

- *Tuff-Tag* provides required OSHA information for the life of the sling in a marine environment.
- *Lift-All* trained professionals are available for recommended seasonal inspection.
- Two ply *Hull Savers* are our standard for improved durability and UV resistance.

#### Saves Time

- Optional keel pad lead weights accelerate sinking to required lift depth.
- Quick disconnects are available to improve boat yard productivity.
- Extra eye offers versatility, reducing sling changing time and sling inventory.

#### Saves Money

- Low-stretch polyester webbing helps to avoid scuff damage to hulls.\*\*
- HS polymer treatment is available to greatly extend sling life by resisting abrasion and UV degradation.
- Optional chine & keel pads protect boat and increase sling life.
- Edgeguard wear resistant webbing available - helps protect sling from abrasion.

Hull Savers

Web Plies	Hull Saver Code	Width (in.)	1 Rated Capacity* (lbs.)	Optional Pull Pin Shackles			
				Shackle Code	W (in.)	L (in.)	Weight Each (lbs.)
Two Ply	HS2804	4	23,000	PPS-4	4	3.75	3.2
	HS2806	6	32,600	PPS-6	6	4.75	6.8
	HS2808	8	38,400	PPS-6HD	6	4.75	9.8
	HS2810	10	44,800	PPS-6HD	6	4.75	9.8
	HS2812	12	48,000/53,800 <sup>2</sup>	PPS-6HD <sup>2</sup>	6	4.75	9.8

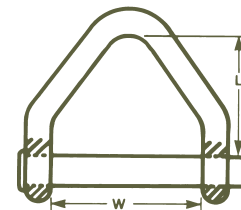

Pull Pin Shackles (Optional)

- Notes: 1. Capacity in lbs. is the rating of one sling in a vertical basket hitch.  
 2. Derate sling to 48,000 when used with 6" HD Shackle (PPS-6HD)

\*\* Note: Nylon webbing is available, but will stretch about 50% more than polyester and should not be used near acids. Polyester should not be used near caustics.

#### Custom Hull Savers

*Lift-All* will manufacture boat slings to fill your particular needs for width, length and capacity. Please call for quotations.



\* Do not exceed rated capacities. Sling capacity decreases as the angle from horizontal decreases. Slings should not be used at angles of less than 30°. Refer to Effect of Angle chart page 12.

## LIFT-ALL HULL SAVER BOAT SLINGS

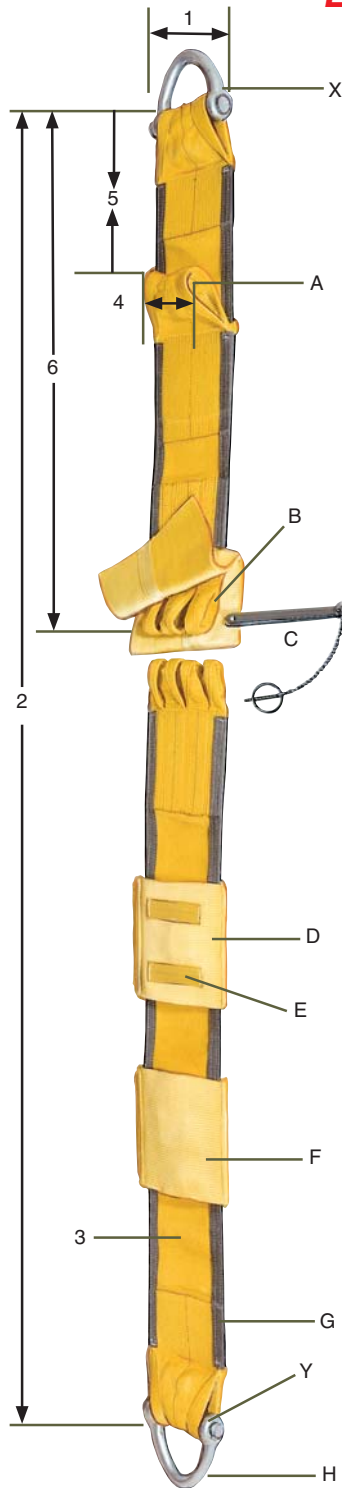

### STANDARD BOAT SLING MEASUREMENTS

1. Sling Width \_\_\_\_\_ in.
2. Sling Length \_\_\_\_\_ ft.
3. Two Ply
4. Width of eyes \_\_\_\_\_ in.

### SLING MATERIAL

Low stretch polyester webbing is standard because it helps to reduce chine marring. Nylon webbing is available, but will stretch about 50% more than polyester and should not be used near acids. HS Polymer Treatment extends sling life.

- POLYESTER - Natural or Treated (circle choice)
- NYLON - Natural or Treated (circle choice)

### BOAT SLING ACCESSORIES

A. Extra Eyes - for shortening sling to lift smaller craft. See Measurement #5

- Extra Eye #1 - Position \_\_\_\_\_ ft. from point X / Y (circle choice)
- Extra Eye #2 - Position \_\_\_\_\_ ft. from point X / Y (circle choice)
- Extra Eye #3 - Position \_\_\_\_\_ ft. from point X / Y (circle choice)

B.  Quick Disconnect With Flaps - Saves time needed to lower the lift for removing slings from the hooks. Available for 6" or wider only. Protective flap to cover pin is standard. See Measurement #6. Position \_\_\_\_\_ ft. from point X / Y.

C.  Quick Disconnect Pin - This reusable pin is necessary for Quick Disconnect operation. Pin is galvanized for corrosion resistance. GAC wire with retaining clip holds pin in place.

D. Keel Pad - Helps protect the sling from abrasion and cutting. Sliding sleeve style allows sling to adjust to center point without scraping along keel. Pad uses the same webbing as the sling. Standard length is 48".

- Sliding Style - Length \_\_\_\_\_ ft.
- Sewn-on Style - Length \_\_\_\_\_ ft. Starting \_\_\_\_\_ ft. from X / Y

E. Keel Pad Weights - Lead weights allow for speedy submersion of sling.

F. Chine Pads - Helps to protect boat chines and rub rails and the sling from abrasion damage. Sliding pad can be positioned to accommodate any size and style of boat. May be sewn to sling per your specification. Pad uses the same webbing as the sling. Standard length is 48".

- Sliding - Quantity \_\_\_\_\_ Length \_\_\_\_\_ ft.
- Sewn-on - Quantity \_\_\_\_\_ Length \_\_\_\_\_ ft. Starting \_\_\_\_\_ ft. from X / Y

G.  Edgeguard - Special wear resistant webbing applied to sling edges to help protect the sling from abrasion.

H. Pull Pin Shackles - Promotes sling life by protecting eyes of sling. Easier attachment of sling to lifting hook. Galvanized steel for corrosion resistance. Reusable.

- Quantity \_\_\_\_\_

## LIFT-ALL HULL SAVER BOAT SLINGS

### Safe Operating Practices

**⚠ WARNING** Read Definition on page 3

- Inspect slings prior to each use and do not use if damaged
- Never allow people to be aboard the boat while it is suspended by slings
- Never work under or near a boat suspended by slings
- Boats must be properly blocked and stabilized before removing slings
- *Hull Saver* Boat Slings are capacity rated for vertical basket lifts. Do not exceed rated capacities
- When lifting with extra eyes, direction of pull must always be away from center point of the original sling length

### Environmental Considerations

- Nylon and polyester are seriously degraded at temperatures above 200°F.
- Prolonged exposure to ultraviolet light adversely affects nylon and polyester. Slings become bleached and stiff when exposed to sunlight or arc welding
- Many acids, alkalis and chemicals have an adverse effect on nylon and polyester. See Chemical Environment Data chart on page 32.

### Inspection Criteria for *Hull Saver* Boat Slings

**⚠ WARNING** Read Definition on page 3

Remove from service if any of the following is visible:

- Sling is bleached or stiff due to sunlight exposure
- Capacity tag is missing or illegible
- Red core warning yarns are visible
- Sling shows signs of melting, charring or chemical damage
- End fittings are excessively pitted, corroded, distorted, cracked or broken
- Cuts on the face or edge of webbing
- Holes, tears, snags or crushed web
- Signs of excessive abrasive wear
- Broken or worn threads in the stitch patterns
- Any other visible damage which causes doubt as to its strength

Refer to photographs illustrating damaged webbing on pages 48-49.



# Tuflex Roundslings



## THE TUFLEX DIFFERENCE

All Lift-All slings meet or exceed OSHA and ASME B30.9 standards and regulations.

### What is a Tuflex Roundsling?

It is an endless synthetic sling made from a skein (continuous loop or hank) of polyester yarn covered by a double wall tubular jacket. The roundsling body can also be compared to sling webbing with the tubular jacket face yarns woven without binder yarns; this allows the core yarns to move independently within the jacket.

### Tufhide Jacket

Made from bulked nylon fibers, the double wall *Tufhide* jacket offers better abrasion resistance for our larger capacity *Tuflex* (EN360 and larger). In addition, *Tufhide* reduces the heat buildup that can damage other high capacity roundslings when used in a choker hitch.

### Tuflex Roundslings Features, Advantages and Benefits

#### Promotes Safety

- Light weight reduces fatigue and strain on riggers
- Synthetic materials won't cut hands
- Consistent matched lengths for better multiple sling load control
- No loss of strength from abrasion to cover
- *Tuff-Tag* provides serial numbered identification for traceability
- Low stretch (about 3% at rated capacity) - reduces sling and load abrasion - good for low headroom lifts

- Conforms to shape of load to grip securely
- Load bearing yarns protected from UV degradation
- Red striped white core yarns provide added visual warning of sling damage
- Color coding provides positive sling capacity information

#### Saves Money

- Double wall cover for greater sling life
- Soft cover won't scratch load surface
- Conforms to shape of load for reduced load damage
- Seamless - no sewn edges to rupture prematurely, requiring removal from service
- EN360 and larger *Tuflex* feature *Tufhide* wear resistant nylon jacket for extra sling life
- *Tuff-Tag* provides required OSHA information for the life of the sling, not just the life of the tag

#### Saves Time

- Color coded capacities for quick identification
- Light weight and pliable for easy rigging and storage
- Independent core yarns choke tightly, but release easily after use
- Easy to carry - high strength to weight ratio for easy transportation

### ⚠ WARNING

Follow temperature and chemical information found on page 32.

Always protect synthetic slings from being cut by corners and edges.



See page 14

## Construction Comparisons - Sling Webbing vs Tuflex

### Sling Webbing

- Transverse pick yarns inter-relate with binder yarns
- Woven surface yarns cover each side and carry a portion of the load
- Strip of longitudinal core yarns bears majority of load
- Binder yarns secure the surface yarns to web core yarns
- Red core warning yarns

### Tuflex

- Transverse pick yarns position surface yarns and protect core yarns
- Woven surface yarns also protect core yarns, carry no load
- Longitudinal core yarns carry 100% of load
- Red core warning yarns

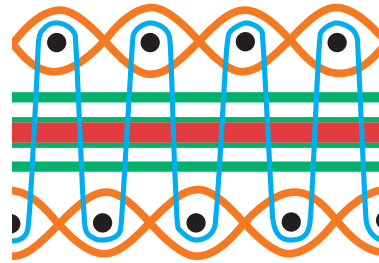

Sling Webbing (Side View)

Sling webbing, as graphically demonstrated, has its surface yarns connected from side to side, to not only protect the core yarns, but to position all surface and tensile yarns to work together to support the load. Wear or damage to Sling Webbing face yarns cause an immediate strength loss. This is why Sling Webbing has red core yarns to visually reveal damage and act as a basis for sling rejection.

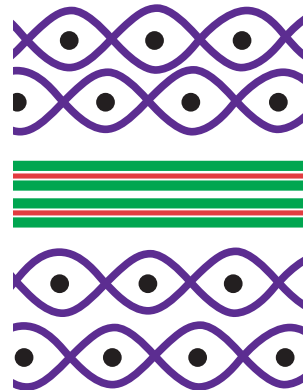

Tuflex (Side View)

Roundsling construction, as shown above, protects all load carrying core yarns from abrasion with an independent, woven jacket. Replacement is not necessary until the red striped white core yarns can be seen through holes in the jacket. When core yarns are visible, sling must be removed from service. Tuflex roundslings provide double wall protection for extended sling life.

Tuflex

## HOW TO ORDER

### Ordering Tuflex Polyester Roundslings

1. Specify sling Part No. found in the charts throughout the Tuflex section
2. Specify sling length in feet (bearing point to bearing point). Refer to footnotes under Tuflex tables for specific sling lengths and tolerances.

Prior to sling selection and use, review and understand the "Help" section pages 3 through 12.

Endless and Eye & Eye styles of Tuflex are made to a tolerance of  $\pm (1" + 1\%$  of the specified length) and can stretch 3% at rated capacity.

Braided Tuflex length tolerance is  $\pm (2" + 5\%$  of the ordered length) (sling at rest). At its rated capacity, braided Tuflex will stretch approximately 9%.

Note: Matched lengths of slings must be specified at time of order.

## USING TUFLEX ROUNDSLINGS

### Protect Sling from Damage

ALWAYS protect roundslings from being cut or damaged by corners, edges and protrusions using protection sufficient for each application.

Do not ignore warning signs of misuse. Cut marks detected during any sling inspection serve as a clear signal that sling protection must be added or improved.

### Exposure of slings to edges

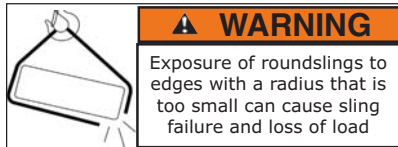

Edges do not need to be “sharp” to cause failure of the sling. The following table shows the minimum allowable edge radii suitable for contact with unprotected roundslings. Chamfering or cutting off edges is not an acceptable substitute for fully rounding the edges to the minimum radius. Slings can also be damaged from contact with edges or burrs at the sling connection.

Measure the edge radius. The radius is equal to the distance between points A and B.

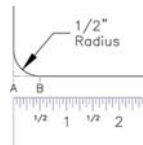

Minimum Edge Radii suitable for contact with unprotected polyester roundslings.

Vertical Rated Capacity (lbs.)	Minimum * Edge Radii	Sling Width At Load (in.)
	(in.)	
EN30	3/16	1
EN60	1/4	1 3/8
EN90	5/16	1 3/4
EN120	5/16	1 7/8
EN150	3/8	2
EN180	7/16	2 1/8
EN240	7/16	2 5/8
EN360	1/2	3 1/4
EN600	11/16	4
EN800	3/4	4 5/8
EN1000	7/8	5 1/4

\* For further information on minimum edge radii, contact Lift-All or see WSTDA RS-1.

### Sling Hardware and Connections

Connection surfaces must be smooth to avoid abrading or cutting roundslings. Roundslings can also be damaged or weakened by excessive compression between the sling and the connection points if the size of the attachment hardware or connection area is not large enough to avoid this damage. Select and use proper connection hardware that conforms to the size requirements listed for choker and vertical hitches, or for basket hitches in the charts below.

(Contact Lift-All, or see WSTDA RS-1 for information about how to calculate whether a smaller connection size is allowable when tension on a roundslings is less than its capacity)

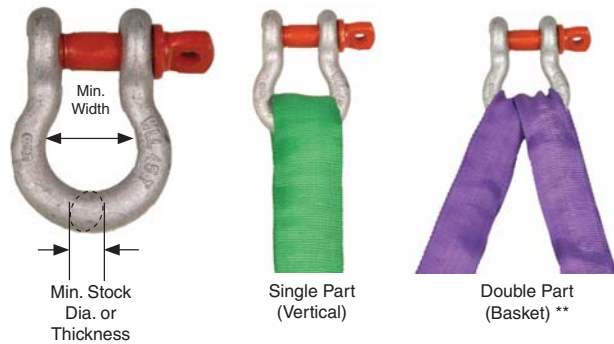

Minimum hardware dimensions suitable for use with roundslings.

Tuflex Size	Single Part		Double Part	
	Min. Stock Dia. (In.)	Min. Width (In.)	Min. Stock Dia. (In.)	Min. Width (In.)
EN30	7/16	1	9/16	1 3/8
EN60	5/8	1 3/8	7/8	1 7/8
EN90	3/4	1 3/4	1 1/16	2 3/8
EN120	7/8	1 7/8	1 1/4	2 1/2
EN150	1	2	1 3/8	2 7/8
EN180	1 1/8	2 1/8	1 5/8	3
EN240	1 3/16	2 5/8	1 5/8	3 3/4
EN360	1 1/2	3 1/4	2	4 1/2
EN600	2	4	2 3/4	5 5/8
EN800	2 1/8	4 5/8	3	6 1/2
EN1000	2 1/2	5 1/4	3 1/2	7 3/8

\*\* For hardware connected to the body of Eye & Eye Tuflex, use the Double Part columns.

## DIRECT CONNECT HOOKS™

**DC Hooks** are the quickest and easiest way to add hooks to *Tuflex* roundslings and web slings at your job site. No tools or extra parts needed. For *Tuflex*, just match the color coded hook to the same color *Tuflex* and you're ready to go. Rated capacities are the same for both the hook and the *Tuflex*.



### Features:

- Rugged – Both alloy steel hook and latch are forged for superior toughness.
- Color coded – Hook color matches *Tuflex* color for easy identification
- Web-Trap design keeps sling in place, ready to use
- Four hook sizes to match *Tuflex* sizes EN30 (Purple), EN60 (Green), EN90 (Yellow) and EN150 (Red)
- Can be used with 1" and 2" web slings (see chart below)

### Benefits:

- Improves Safety – Color coding to match *Tuflex* colors reduces chance of using wrong size hook
- Saves Time – Quick connections; no tools needed
- Saves Money – Adds versatility to your existing slings. No need to buy expensive hardware slings

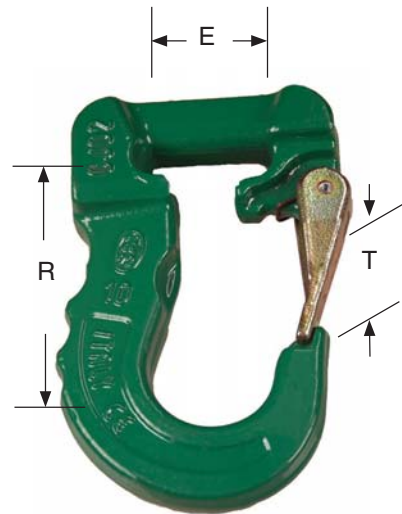

Lift-All Part #	Color	Rated Cap. (lbs.)	Tuflex	Web Slings		Weight (lbs.)	E (in.)	R (in.)	T (in.)
				Width	Plies				
DCH1	Purple	2,600	EN30	1	1	1.5	1 9/16	3 3/8	1
DCH2	Green	5,300	EN60	1	2	2.7	1 3/4	4	1 5/16
DCH3	Yellow	8,400	EN90	2	1 & 2	4.9	2 3/16	4 5/8	1 1/2
DCH4	Red	13,200	EN150	-	-	9.9	2 3/4	5 3/4	1 3/4

**TUFLEX ENDLESS ROUNDSLINGS**

**Tuflex Endless (EN)**  
**The Most Versatile Tuflex Roundslings**

**Features, Advantages and Benefits**

Maintains all the basic *Tuflex* features plus...

Promotes Safety

- Load stability and balance can be achieved by spreading sling legs.

Saves Money

- Wear points can be shifted to extend sling life
- The most flexible style of sling

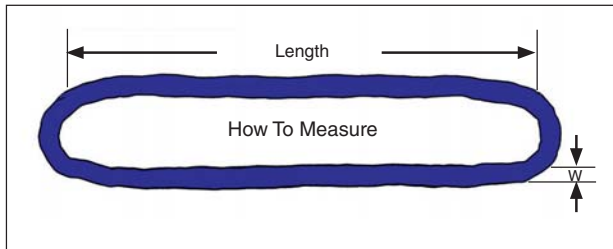

Part No.	Color	Rated Capacity (lbs.)*				Minimum Length (ft.)	Approximate Measurements			
		Vertical	Choker	Basket @ 90°	Basket @ 45°		Weight (lbs. / ft.)	Body Dia. Relaxed (in.)	(W) Width at Load (in.)	Minimum Hardware Dia. ** (in.)
EN30	Purple	2,600	2,100	5,200	3,600	1 1/2	.2	5/8	1	7/16
EN60	Green	5,300	4,200	10,600	7,400	1 1/2	.3	7/8	1 3/8	5/8
EN90	Yellow	8,400	6,700	16,800	11,800	3	.5	1 1/8	1 3/4	3/4
EN120	Tan	10,600	8,500	21,200	14,000	3	.6	1 1/8	1 7/8	7/8
EN150	Red	13,200	10,600	26,400	18,000	3	.8	1 3/8	2	1
EN180	White	16,800	13,400	33,600	23,000	3	.9	1 3/8	2 1/8	1 1/8
EN240	Blue	21,200	17,000	42,400	29,000	3	1.3	1 3/4	2 5/8	1 3/16
EN360	Grey	31,000	24,800	62,000	43,000	3	1.7	2 1/4	3 1/4	1 1/2
EN600	Brown	53,000	42,400	106,000	74,000	8	2.8	2 3/4	4	2
EN800	Olive	66,000	52,800	132,000	93,000	8	3.4	3 1/8	4 5/8	2 1/8
EN1000	Black	90,000	72,000	180,000	127,000	8	4.3	3 5/8	5 1/4	2 1/2

\* **⚠ WARNING** Do not exceed rated capacities. Sling capacity decreases as the angle from horizontal decreases. Slings should not be used at angles of less than 30°. Refer to Effect of Angle chart page 12.  
\*\* This is the smallest recommended connection hardware diameter to be used for a vertical hitch.

## TUFLEX EYE AND EYE

A More Rugged and Durable *Tuflex*

### The Eye and Eye Advantage

An additional jacket of texturized, abrasion resistant nylon covers the body of the standard *Tuflex*, forming two color coded lifting eyes.

Maintains all the basic *Tuflex* features plus ...

- Saves money by extending sling life where abrasion to sling body is a problem.

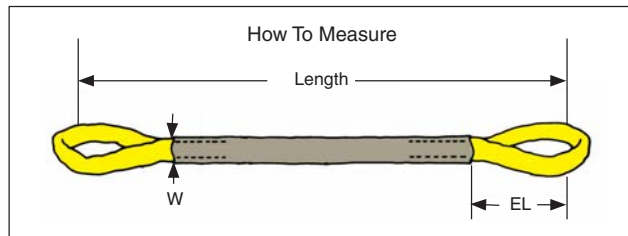

Tuflex

Part No.	Color of Eyes	Rated Capacity (lbs.)*				Minimum Length (ft.) +	Approximate Measurements			
		Vertical	Choker	Basket @ 90°	Basket @ 45°		Weight (lbs./ft.)	Body Width at Load (W) (in.)	Standard Eye Length (EL) (in.)	Minimum Hardware Dia. ** (in.)
EE30	Purple	2,600	2,100	5,200	3,600	4	.25	2 1/4	10	7/16
EE60	Green	5,300	4,200	10,600	7,400	4	.36	2 1/2	10	5/8
EE90	Yellow	8,400	6,700	16,800	11,800	4	.50	2 1/2	12	3/4
EE120	Tan	10,600	8,500	21,200	14,000	5	.60	3 1/2	12	7/8
EE150	Red	13,200	10,600	26,400	18,000	5	.84	3 1/2	14	1
EE180	White	16,800	13,400	33,600	23,000	7	.96	3 1/2	16	1 1/8
EE240	Blue	21,200	17,000	42,400	29,000	7	1.5	4 1/4	16	1 3/16
EE360	Grey	31,000	24,800	62,000	43,000	7	1.8	6	20	1 1/2
EE600	Brown	53,000	42,400	106,000	74,000	8	2.7	7	24	2
EE800	Olive	66,000	52,800	132,000	93,000	10	3.3	8	30	2 1/8
EE1000	Black	90,000	72,000	180,000	127,000	12	4.2	9	36	2 1/2

**⚠ WARNING**

Do not exceed rated capacities. Sling capacity decreases as the angle from horizontal decreases. Slings should not be used at angles of less than 30°. Refer to Effect of Angle chart page 12.

\*\* This is the smallest recommended connection hardware diameter to be used for a vertical hitch.

+ Shorter lengths available using reduced eye lengths.

## BRAIDED TUFLEX ROUNDSLINGS

For the ultimate in big loads - (up to 612,000 lbs. in a vertical basket)  
or for the security of multiple part sling lifting.

### Redundant Safety

Tuflex braids are made from three [6 part] or four [8 part] individual Tuflex. Should one of these component slings be damaged while in use, the remaining undamaged slings should be able to safely return the load to the ground.

### Braided Tuflex Features, Advantages and Benefits

Maintains all the basic Tuflex features plus ...

#### Promotes Safety

- Braided construction offers redundant safety
- User friendly compared to steel slings

#### Saves Money

- Large capacity slings are generally purchased for one major lift, then rarely used again. Braided Tuflex can be disassembled into component slings for general purpose lifting, if individual slings are correctly tagged.
- Can be returned for disassembly, inspection and retagging as individual slings.

#### Saves Time

- Easy to transport and hook-up

Tuflex

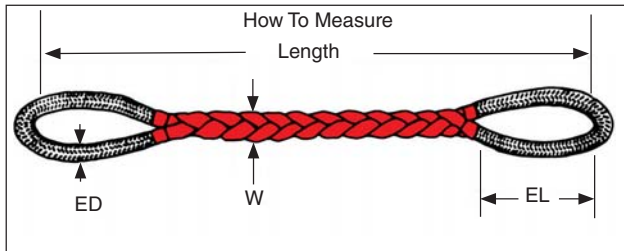

### 6 Part Flat Braid (B6E)

Part No.	Color	Rated Capacity (lbs.)*			Minimum Length (ft.) +	Approximate Measurements					
		Vertical	Choker	Basket		Weight (lbs./ft.)	Standard Eye Length (EL) (in.)	Width at Load (W) (in.)	Thickness at Load (in.)	Eye Dia. (ED) (in.)	Minimum Hardware Dia. ** (in.)
B6E30	Purple	6,700	5,300	13,400	4 1/2	.8	15	3 1/4	3/4	1 3/4	5/8
B6E60	Green	13,500	10,800	27,000	5	1.2	15	3 3/4	1 1/8	2	1
B6E90	Yellow	21,400	17,100	42,800	5 1/2	1.6	15	4 1/4	1 1/4	2	1 1/4
B6E120	Tan	27,000	21,600	54,000	5 1/2	2.0	15	4 1/2	1 5/16	2 1/4	1 3/8
B6E150	Red	33,600	26,800	67,200	6 1/2	2.7	20	5 1/4	1 3/4	2 1/2	1 1/2
B6E180	White	42,800	34,200	85,600	7	3.2	20	5 1/2	2	2 3/4	1 3/4
B6E240	Blue	54,000	43,200	108,000	9	4.4	20	6 5/8	2 1/4	3 1/2	1 3/4
B6E360	Grey	79,000	63,200	158,000	9 1/2	6.5	30	8 1/4	2 1/2	4 1/4	2 1/2
B6E600	Brown	135,100	108,000	270,200	10 1/2	9.7	30	11	2 3/4	5	3
B6E800	Olive	168,300	134,600	336,600	13	12.0	30	12	4	5 1/4	3 1/2
B6E1000	Black	229,500	183,600	459,000	14 1/2	15.6	31	13 1/2	4 1/2	5 3/4	4

### \* **WARNING**

Do not exceed rated capacities. Sling capacity decreases as the angle from horizontal decreases. Slings should not be used at angles of less than 30°. Refer to Effect of Angle chart page 12 .  
\*\* This is the smallest recommended connection hardware diameter to be used for a vertical hitch.  
+ Shorter lengths available using reduced eye lengths.



## BRAIDED TUFLEX ROUNDSLINGS



### Order Information

Ordering length should be based on sling at rest.

Braided *Tuflex* length tolerance is  $\pm (2" + 5\%$  of the ordered length) (sling at rest).

At its rated capacity, braided *Tuflex* will stretch approximately 9% and have a length variance of  $\pm 2\%$ .



Tuflex

### 8 Part Round Braid (B8E)

Part No.	Color	Rated Capacity (lbs.)*			Minimum Length (ft.) +	Approximate Measurements					
		Vertical	Choker	Basket		Weight (lbs./ft.)	Standard Eye Length (EL) (in.)	Width at Load (W) (in.)	Thickness at Load (in.)	Eye Dia. (ED) (in.)	Minimum Hardware Dia. ** (in.)
B8E30	Purple	8,800	7,100	17,600	4 1/2	1.1	15	3 1/2	1	1 3/4	3/4
B8E60	Green	18,000	14,400	36,000	5	1.5	15	4	1 3/8	2	1 1/8
B8E90	Yellow	28,500	22,800	57,000	5 1/2	2.2	15	4 3/4	1 5/8	2 1/2	1 1/2
B8E120	Tan	36,000	28,800	72,000	5 1/2	2.6	15	5	1 3/4	2 1/2	1 1/2
B8E150	Red	44,900	35,900	89,800	6 1/2	3.6	20	6	2 1/8	2 3/4	1 3/4
B8E180	White	57,100	45,600	114,200	7	4.1	20	6 1/4	2 1/2	3 1/4	2
B8E240	Blue	72,000	57,600	144,000	9	5.6	20	7 1/2	2 3/4	3 3/4	2
B8E360	Grey	105,400	84,300	210,800	9 1/2	8.3	30	9 1/2	3 1/4	4 1/2	2 1/2
B8E600	Brown	180,200	144,100	360,400	10 1/2	12.0	30	13	3 3/4	5 1/2	3 1/2
B8E800	Olive	224,400	179,500	448,800	13	16.0	30	13 1/2	4 1/2	6	4
B8E1000	Black	306,000	244,000	612,000	14 1/2	20.0	31	15 3/4	5 1/4	6 1/2	4 3/4

\* **WARNING** Do not exceed rated capacities. Sling capacity decreases as the angle from horizontal decreases. Slings should not be used at angles of less than 30°. Refer to Effect of Angle chart page 12.  
 \*\* This is the smallest recommended connection hardware diameter to be used for a vertical hitch.  
 + Shorter lengths available using reduced eye lengths.

## THE STRONGEST AND LIGHTEST SLINGS IN THE WORLD

Rigging injuries decrease when lighter, less cumbersome slings are used. Light, flexible **KeyFlex™** Roundslings help prevent injuries.

### Sling Weights per Capacities

On the average, **KeyFlex™** Roundslings are:

- 53% lighter than **Tuflex™** Roundslings,
- 82% lighter than Wire Rope Slings,
- 89% lighter than G80 Chain Slings

The chart at the right plots the weights of 20 ft. long slings at various capacities:

Sling Type	Vert. Rating	Weight
<b>KeyFlex™</b>	90,000 lbs.	42 lbs.
<b>Tuflex™</b>	90,000 lbs.	86 lbs.
Wire Rope	88,000 lbs.	357 lbs.
Chain	72,300 lbs.	358 lbs.

### KeyFlex™ Benefits:

- Lowest weight per capacity reduces risk of back and other injuries to riggers.
- Low stretch (1% at rated capacity) reduces elastic bounce for better load control – allows for use in most low headroom situations – reduces sling and load abrasion.
- Aramid load yarns allow sling use up to 350° F versus 200° F for other synthetics.
- Lightweight and compact size promotes speedier rigging, transport and storage when compared to any other type of sling.

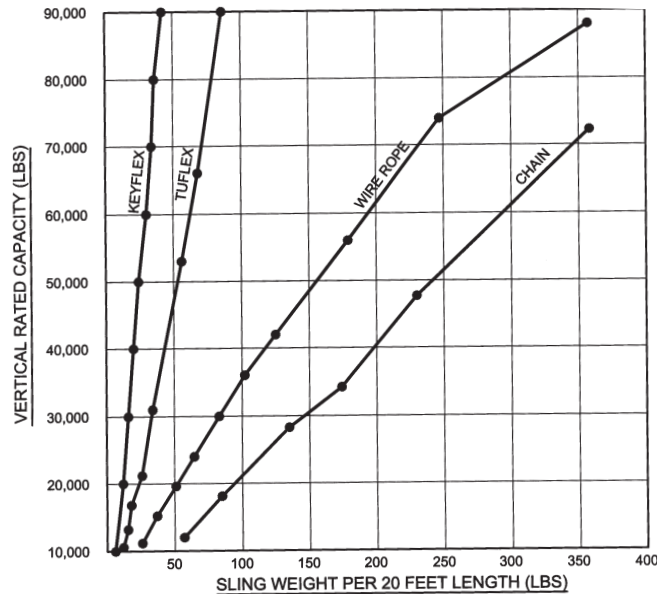

### KeyFlex™ Capacities and Measurements

Part No.	Rated Capacity (lbs.)*				Minimum Length (ft.)	Approximate Measurements			
	Vertical	Choker	Basket @ 90°	Basket @ 45°		Weight (lbs. / ft.)	Body Dia. Relaxed (in.)	Width at Load (in.)	Minimum Hardware Dia. (in.)
KEN10K	10,000	8,000	20,000	14,100	3	.3	1	1 9/16	11/16
KEN15K	15,000	12,000	30,000	21,000	3	.5	1 1/8	1 3/4	7/8
KEN20K	20,000	16,000	40,000	28,000	3	.6	1 1/4	2	1 1/16
KEN25K	25,000	20,000	50,000	35,000	3	.7	1 1/4	2 1/8	1 1/4
KEN30K	30,000	24,000	60,000	42,000	3	.8	1 3/8	2 1/8	1 7/16
KEN40K	40,000	32,000	80,000	56,000	3	1.0	1 3/4	2 3/4	1 1/2
KEN50K	50,000	40,000	100,000	70,000	5	1.3	1 7/8	2 7/8	1 3/4
KEN60K	60,000	48,000	120,000	84,000	8	1.7	2	3 1/8	2
KEN70K	70,000	56,000	140,000	98,000	8	1.9	2 1/8	3 1/4	2 3/16
KEN80K	80,000	64,000	160,000	113,000	8	2.1	2 1/4	3 1/2	2 3/8
KEN90K	90,000	72,000	180,000	127,000	8	2.4	2 1/2	3 7/8	2 3/8
KEN100K	100,000	80,000	200,000	141,000	8	2.6	2 3/4	4 1/4	2 1/2
KEN125K	125,000	100,000	250,000	176,000	8	3.0	3	4 7/8	2 5/8
KEN150K	150,000	120,000	300,000	210,000	8	3.5	3 1/4	5 1/4	2 7/8
KEN175K	175,000	140,000	350,000	240,000	8	4.8	3 1/2	5 3/4	3 1/8
KEN200K	200,000	160,000	400,000	280,000	8	5.3	3 3/4	6 1/8	3 3/8

Tuflex

## YOUR KEY TO LIFTING HEAVY LOADS USING THE LIGHTEST, MOST FLEXIBLE SLING AVAILABLE !

### KeyFlex™ Roundslings Share Most of the Benefits of Standard Tuflex™ Roundslings

#### Promote Safety

- Synthetic materials won't cut hands
- Consistent matched lengths for better multiple sling control
- No loss of strength from abrasion on double walled jacket
- *Tuff-Tag*™ provides serial numbered identification for traceability
- Conforms to shape of load to grip securely
- Load bearing yarns protected from UV degradation
- Contrasting color core yarns provide visual warning of sling damage  
(*KeyFlex*™ : Orange jacket, Gold Core Yarns)
- Endless style promotes load stability by spreading sling legs

#### Inspection Criteria

Remove from service when:

- Cuts to sling cover expose gold core yarns
- Holes, tears, snags or abrasion expose gold core yarns
- End fittings are pitted or corroded, cracked, distorted or broken
- The sling shows signs of melting, charring or chemical damage
- Capacity tag is illegible or missing
- Other visible damage that causes doubt as to strength of the sling

#### Environmental Considerations

- CHEMICAL - Do not use in a chemical environment without first contacting the Lift-All engineering department at 717-898-6615. Please provide specific chemical, concentration, temperature and time factors.
- TEMPERATURE – *KeyFlex*™ are approved for use up to 350° F.

#### Saves Time

- Independent core yarns choke tightly, but release easily after use

#### Saves Money

- Double wall cover for greater sling life
- Soft cover won't scratch load surface
- Conforms to shape of load to reduce load damage
- Seamless – no sewn edges to rupture prematurely, requiring removal from service
- *Tuffhide* wear resistant nylon jacket for extra sling life standard on KEN60K and larger sizes
- *Tuff-Tag* provides required OSHA information for life of the sling, not just the life of the tag
- Wear points can be shifted to extend sling life
- Endless version is the most versatile style of sling
- *KeyFlex*™ Roundslings with damaged covers may be returned to our factory for inspection and possible repair and proof test.

Tuflex

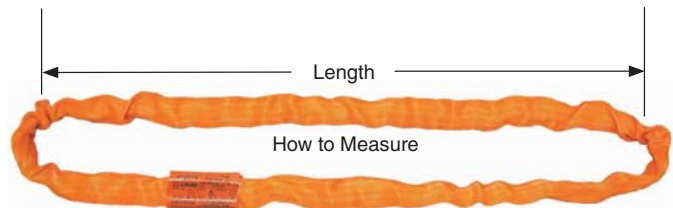

#### Ordering Information

Specify the sling code and length in feet (bearing point to bearing point).

*KeyFlex*™ are made to a tolerance of  $\pm(1" + 1\%$  of the specified length) and can stretch 1% at rated capacity.

*Note: Matched lengths of slings must be specified at time of order. Available in endless style only.*

#### WARNING

Always protect Roundslings from corners, edges or protrusions. Refer to wear pads section, page 14 for available protective devices.

## STEELFLEX ROUNDSLINGS

THE STEEL SLING  
WITH THE FABRIC FEEL

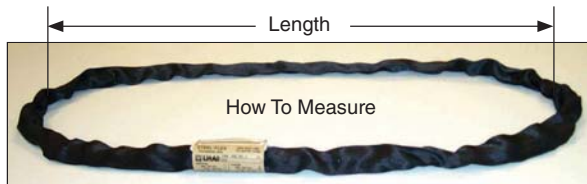
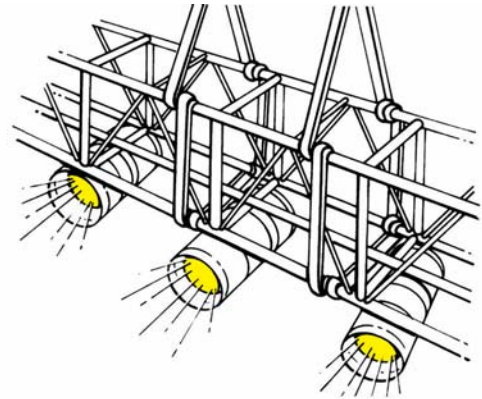

GACEN60

**400° F Temperature Rating**  
**NO Wire Rope Backup Needed**  
**Core Inspection Window Standard**

Designed for Suspension Applications where metal slings are required.

With the trend in stage rigging to require metal slings for all overhead suspension, the problem has been how to accomplish this in the most efficient and cost effective way. *STEELFLEX ROUNDSLINGS* are the answer to that problem!

The load-bearing member of *STEELFLEX ROUNDSLINGS* is made from steel Galvanized Aircraft Cable wound in an endless configuration. This wire core is encased in a black double-wall, polyester jacket. A unique inspection window allows for easy inspection of the core for broken wires and corrosion. The result is a highly flexible, easy to use sling that complies with all of the current rigging codes.

The benefits are many:

### Increased Safety

- Improved cut resistance
- Higher heat resistance
- Conforms to load to grip securely
- Window allows complete core inspection

### Saves Time

- No backup rigging required
- Fewer components to inventory and carry
- Superior flexibility makes rigging easy
- Tan colored Tuff-Tag confirms steel core

### Saves Money

- Gives you the slings you want to use (roundslings), without having to buy the slings you would be required to use (wire rope or chain)
- Lowers show to show freight costs



Inspection Window

## POLYESTER STAGE SLINGS - BLACK

These lightweight roundslings are ideal for easy and inconspicuous suspension of stage sound and lighting equipment. Black sleeve material helps sling blend into its surroundings. *Lift-All* Stage Slings maintain the basic *Tuflex* features, advantages and benefits except that the color coding of the slings is achieved by using a color coded identification *Tuff-Tag*. Double Wall sleeve material is standard.

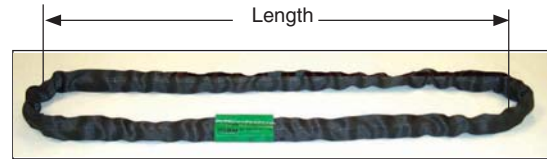

## STEELFLEX & POLYESTER STAGE SLING INFORMATION

	Part No.	Rated Capacity (lbs.)*			Minimum Length (ft.)	Approximate Measurements		
		Vertical	Choker	Basket		Weight (lbs. / ft.)	Body Dia. Relaxed (in.)	Width at Load (in.)
Polyester Stage Sling	BSEN30	2,600	2,100	5,200	1 1/2	.2	5/8	1 1/8
	BSEN60	5,300	4,200	10,600	1 1/2	.3	7/8	1 1/2
	BSEN90	8,400	6,700	16,800	3	.4	1 1/8	1 7/8
Steelflex	GACEN60	5,300	4,200	10,600	3**	.75	7/8	1 1/2

Tuflex

## WIDE-LIFT TUFLEX

### WIDE-LIFT TUFLEX

#### Wide Load Support and Balance

Wide-Lift *Tuflex* slings distribute the load over a wide area and offer better balance of larger loads - whether heavy or light.

#### Tuflex Wide-Lift Features, Advantages and Benefits

Maintains all the basic *Tuflex* features plus ...

Promotes Safety

- Wide body distributes load over wide area and offers better balance

Saves Money

- Bearing point of eyes can be shifted to prolong sling life
- Custom sizes available to fit your needs

Saves Time

- Standard eye length is 12" - making hook-up easy and fast
- Standard body width is 12" - making load balancing easier

Note:  
Wide-Lift slings should only be used in basket hitch

Consult factory for special requirements.



Code	Color of Eyes	Vertical Basket Hitch Rated Capacity* (lbs.)
WL30	Purple	5,200
WL60	Green	10,600
WL90	Yellow	16,800
WL120	Tan	21,200

**⚠ WARNING**

Do not exceed rated capacities. Sling capacity decreases as the angle from horizontal decreases.

Slings should not be used at angles of less than 30°.

Refer to Effect of Angle chart page 12.

\*\* Maximum length for Steelflex is 9 ft.

## TUFLEX HARDWARE / BRIDLE SLINGS

### Features, Benefits and Advantages

Promotes Safety

- Bridles provide better load control and balance
- Hardware avoids cutting and abrasion of sling at bearing points

Saves Money

- Reduced load damage - protected between pick-up point and crane hook

Saves Time

- Lighter weight and easier to use and store than wire rope or chain slings
- Sling hooks quickly connect to loads having hoist rings or eye bolts

### How to Order

Specify:

1. Number of legs -  
S (Single-1), D(Double-2), T(Triple-3), Q(Quad-4)
2. Master Link - O (Oblong)
3. Bottom Attachments - S (Sling Hook), O (Oblong)
4. *Tuflex* Code
5. Length of Assembly -Feet  
(Bearing point to bearing point)

Example:

DOSEN90 X 10' is a double leg bridle, oblong master link, with sling hooks attached to each *Tuflex* EN90. Assembly length is 10 ft.

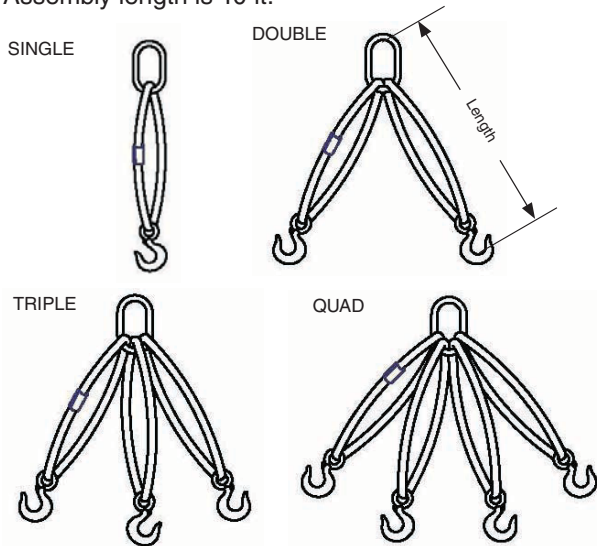

\*See hardware dimension charts on page 91.  
Use sling leg calculator to determine length @ [www.lift-all.com](http://www.lift-all.com)

Legs	Tuflex Size	Rated Capacity (lbs.) for the following hitches			Hardware*		
		Vertical	Choker	Basket	Hook	Masterlink Stock Dia. (in.)	
SINGLE	EN30	2,600	2,100	5,200	2TA	1/2	
	EN60	5,300	4,200	10,600	4.5TA	3/4	
	EN90	8,400	6,700	16,800	7TA	3/4	
	EN120	10,600	8,500	21,200	11TA	3/4	
	EN150	13,200	10,600	26,400	11TA	1	
	EN180	16,800	13,400	33,600	15TA	1 1/4	
	EN240	21,200	17,000	42,400	22TA	1 1/4	
	EN360	31,000	24,800	62,000	20TC	1 1/2	
	EN600	53,000	42,400	106,000	30TC	2	
	EN800	66,000	52,800	132,000	40TC	2 1/4	
EN1000	90,000	72,000	180,000	NA	2 1/2		
DOUBLE	One Leg @ 90°		All Legs @			Hook	Masterlink Stock Dia. (in.)
			60°	45°	30°		
	EN30	2,600	4,500	3,600	2,600	2TA	1/2
	EN60	5,300	9,100	7,400	5,300	4.5TA	3/4
	EN90	8,400	14,500	11,800	8,400	7TA	1
	EN120	10,600	18,300	14,900	10,600	11TA	1 1/4
	EN150	13,200	22,800	18,600	13,200	11TA	1 1/4
	EN180	16,800	29,100	23,700	16,800	15TA	1 1/2
	EN240	21,200	36,700	29,900	21,200	22TA	1 1/2
	EN360	31,000	53,700	43,800	31,000	20TC	2
EN600	53,000	91,800	74,900	53,000	30TC	2 1/2	
EN800	66,000	114,300	93,300	66,000	40TC	3	
EN1000	90,000	155,800	127,200	90,000	NA	3 1/4	
TRIPLE	EN30	2,600	6,700	5,500	3,900	2TA	3/4
	EN60	5,300	13,700	11,200	7,900	4.5TA	1
	EN90	8,400	21,800	17,800	12,600	7TA	1 1/4
	EN120	10,600	27,500	22,400	15,900	11TA	1 1/2
	EN150	13,200	34,200	27,900	19,800	11TA	1 1/2
	EN180	16,800	43,600	35,600	25,200	15TA	1 3/4
	EN240	21,200	55,000	44,900	31,800	22TA	2
	EN360	31,000	80,500	65,700	46,500	20TC	2 1/4
	EN600	53,000	137,600	112,400	75,900	30TC	2 3/4
	EN800	66,000	171,400	139,900	99,000	40TC	3 1/2
EN1000	90,000	233,800	190,800	135,000	NA	4 1/4	
QUAD	EN30	2,600	9,000	7,300	5,200	2TA	3/4
	EN60	5,300	18,300	14,900	10,600	4.5TA	1 1/4
	EN90	8,400	29,100	23,700	16,800	7TA	1 1/2
	EN120	10,600	36,700	29,900	21,200	11TA	1 1/2
	EN150	13,200	45,700	37,300	26,400	11TA	1 3/4
	EN180	16,800	58,200	47,500	33,600	15TA	2
	EN240	21,200	73,400	59,900	42,400	22TA	2 1/4
	EN360	31,000	107,300	87,600	62,000	20TC	2 3/4
	EN600	53,000	183,600	149,900	106,000	30TC	3 1/2
	EN800	66,000	228,600	186,600	132,000	40TC	4 1/4
EN1000	90,000	311,700	254,500	180,000	NA	4 3/4	

## INSPECTION CRITERIA FOR TUFLEX / KEYFLEX

The following photos illustrate some of the common damage that occurs and indicates that the sling must be taken out of service. For inspection frequency requirements, see page 7.

**THE DAMAGE:** Cuts to the cover exposing internal core yarns – When internal core yarns are visible, the amount of damage done to the core yarns and the sling strength can not be determined without breaking the sling. Therefore, the sling must be taken out of service.

**WHAT TO LOOK FOR:** Broken fibers of equal length indicate that the sling has been cut by an edge.

**TO PREVENT:** Always protect synthetic slings from being cut by corners and edges by using wear pads or other devices

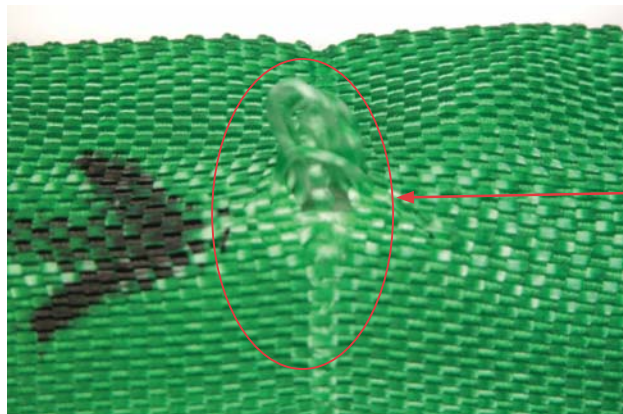
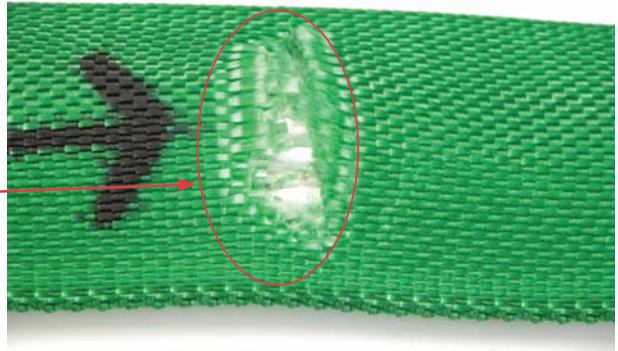

**THE DAMAGE:** Holes/Snags/Pulls exposing internal core yarns.

**WHAT TO LOOK FOR:** Punctures or areas where fibers stand out from the rest of the sling surface.

**TO PREVENT:** Avoid sling contact with protrusions, both during lifts and while transporting or storing.

**THE DAMAGE:** Abrasion exposing internal core yarns.

**WHAT TO LOOK FOR:** Areas of the sling that look and feel fuzzy indicate that the fibers have been broken by being subject to contact and movement against a rough surface. Affected areas are usually discolored.

**TO PREVENT:** Never drag slings along the ground. Never pull slings from under loads that are resting on the sling. Use wear pads between slings and rough surface loads.

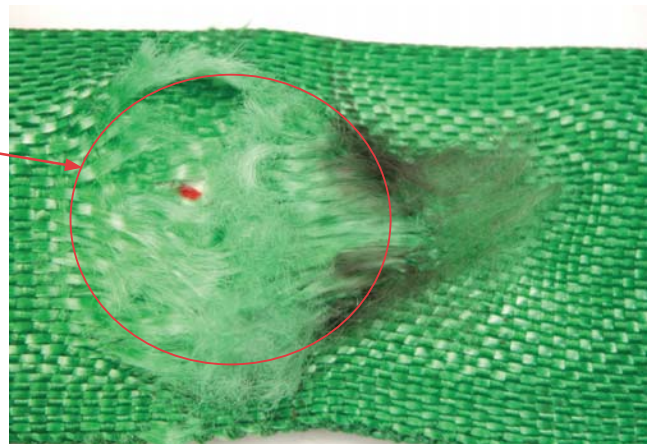

**INSPECTION CRITERIA FOR TUFLEX / KEYFLEX**

THE DAMAGE: Heat/Chemical

WHAT TO LOOK FOR: Melted or charred fibers anywhere along the sling. Heat and chemical damage can look similar and they both have the effect of damaging sling fibers and compromising the sling's strength. Look for discoloration and/or fibers that have been fused together and often feel hard or crunchy.

TO PREVENT: Never use *Tuflex* where they can be exposed to temperatures in excess of 200°F. Never use *Tuflex* in or around chemicals without confirming that the sling material is compatible with the chemicals being used. For elevated temperatures up to 350°F, ask about our *KeyFlex* roundslings.



THE DAMAGE: Illegible or Missing Tags –The information provided by the sling tag is important for knowing what sling to use and how it will function.

WHAT TO LOOK FOR: If you cannot find or read all of the information on a sling tag, the sling shall be taken out of service.

TO PREVENT: Never set loads down on top of slings or pull slings from beneath loads if there is any resistance. Load edges should never contact sling tags during the lift. Avoid paint or chemical contact with tags.



THE DAMAGE: Knots compromise the strength of all slings by not allowing all fibers to contribute to the lift as designed.

WHAT TO LOOK FOR: Knots are rather obvious problems as shown here.

TO PREVENT: Never tie knots in slings and never use slings that are knotted.



THE DAMAGE: Cuts to the cover NOT exposing internal core yarns –*Tuflex* roundslings all have a double walled jacket protecting the inner core yarns from damage. If damage (except for chemical or heat) appears only to the outer jacket and does not expose the inner core yarns, the sling may remain in service. To extend sling life, the sling may be returned to Lift-All for inspection and application of a patch to cover the damaged area.

WHAT TO LOOK FOR: Broken fibers of equal length indicate that the sling has been cut by an edge. In this case, the inner jacket remains intact.

TO PREVENT: Use wear pads between the sling and all edges that come in contact with the sling.

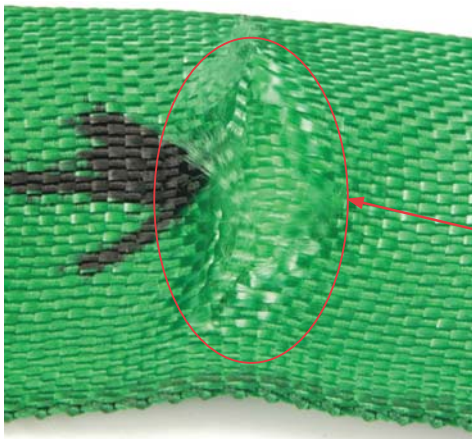

Tuflex



# Wire Rope & Slings

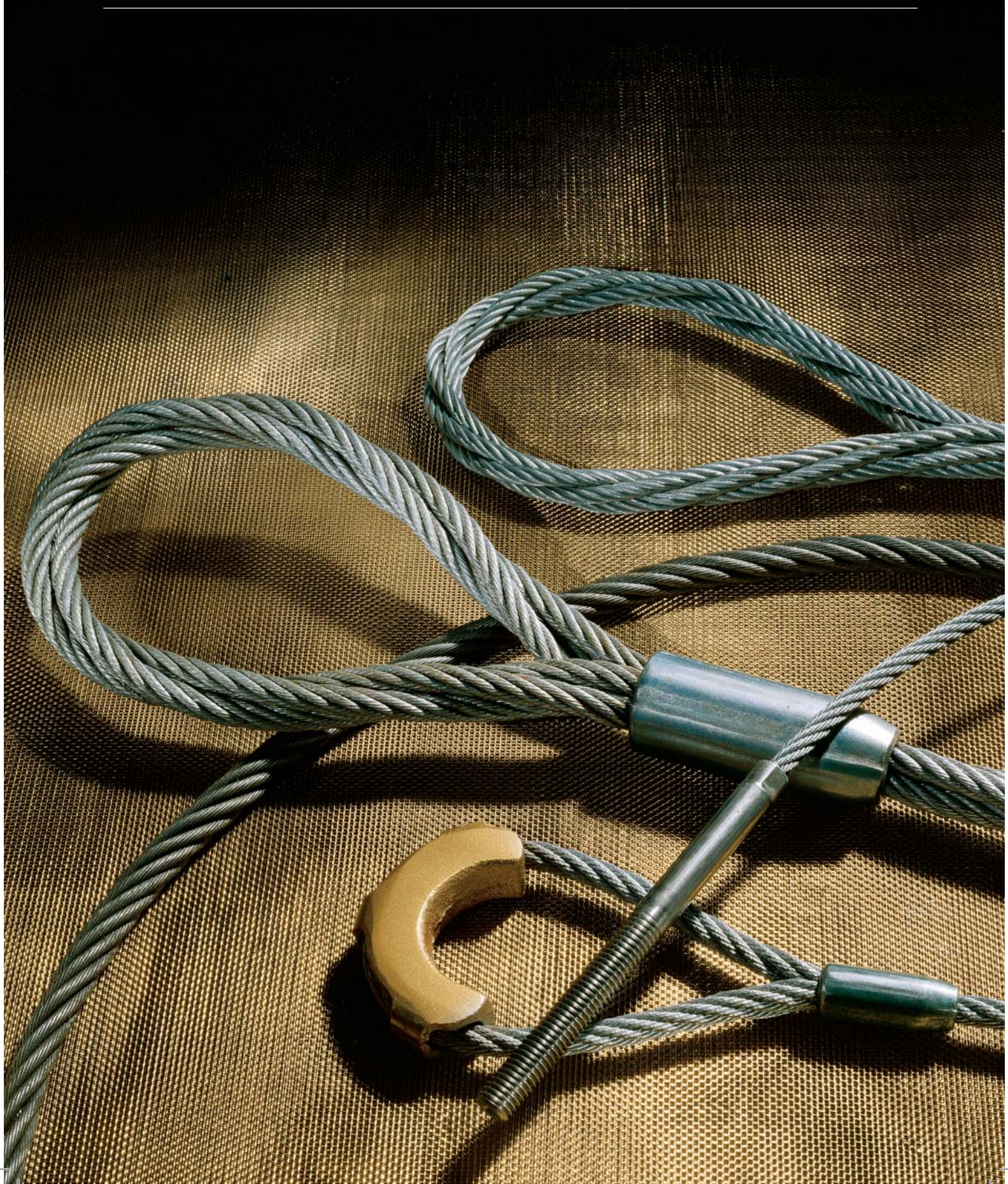

## WIRE ROPE AND SLING BASICS

Two major and opposing characteristics of wire rope slings are flexibility and resistance to abrasion. To a great extent, these traits are a direct function of the number of wires. Fewer wires means larger diameter wires, better abrasion resistance, and reduced flexibility. More wires result in decreased wire diameter, reduced abrasion resistance, increased flexibility and kink resistance.

The scale below shows the relative position of the sling constructions shown in this catalog as they pertain to abrasion resistance and flexibility.

EIP = Extra Improved Plow (Steel)  
FC = Fiber Core

### Wire Rope Construction

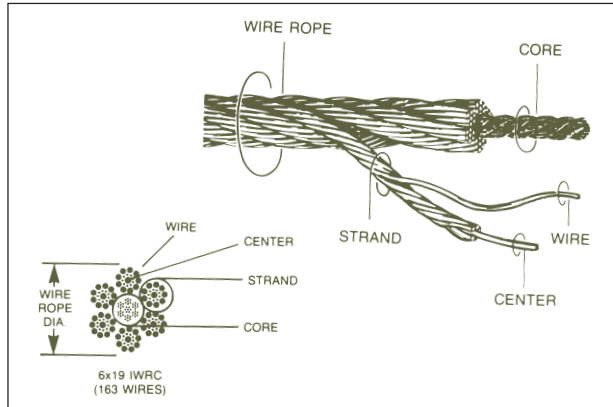

Wire Rope

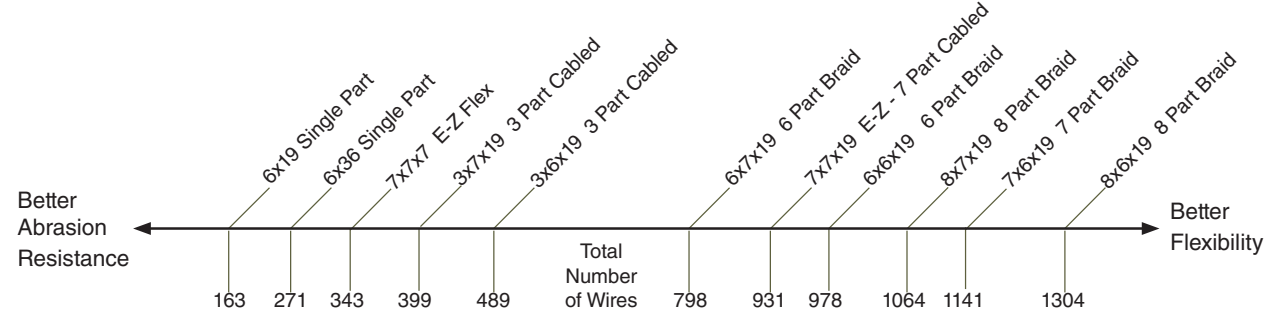

## WIRE ROPE SLINGS

### Features, Advantages and Benefits

Promotes Safety

- **Tuff-Tag** for capacity and serial numbered identification for traceability and compliance with **OSHA**.

Saves Money

- Least expensive, per capacity, of all steel slings.
- Use of EIP, IWRC rope gives 15% greater capacity than IP, IWRC ropes.

Saves Time

- Countless combinations of sling terminations - hooks, chokers and thimbles are available to fit specific lift requirements.

D/d - Basket Hitch Effect

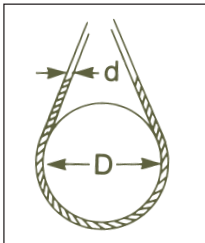

**⚠ WARNING**

Read Definition on page 3

Tests have shown that whenever a sling body is bent around a diameter, the strength of the sling is decreased. D/d ratio is the ratio of the diameter around which the sling is bent divided by the body diameter of the sling.

The capacities in this catalog are based on the minimum D/d ratios that appear below each of the capacity tables. For more severe bending conditions, contact *Lift-All* for revised capacities.

### Environmental Considerations

- Wire core wire rope (IWRC) must not be used at temperatures above 400°F.
- Fiber core wire rope (FC) must not be used at temperatures above 180°F.
- Fiber core ropes should not be subjected to degreasing solvents.

### Effect of Anchor Shackle Pin or Crane Hook on Sling Eye



**⚠ WARNING**

Read Definition on page 3

Damage to slings can occur if the wrong size pin or hook is used. The width of the pin or hook should never exceed the natural inside width of the eye.

The eye dimension for each type and size of sling are shown in the capacity tables of this catalog. If your pin or hook is large, request an oversized eye for the sling.

## HOW TO ORDER WIRE ROPE SLINGS

Prior to sling selection and use, review and understand the "Help" section pages 3 through 12.

We have developed the following wire rope sling code system to help you in ordering these products.

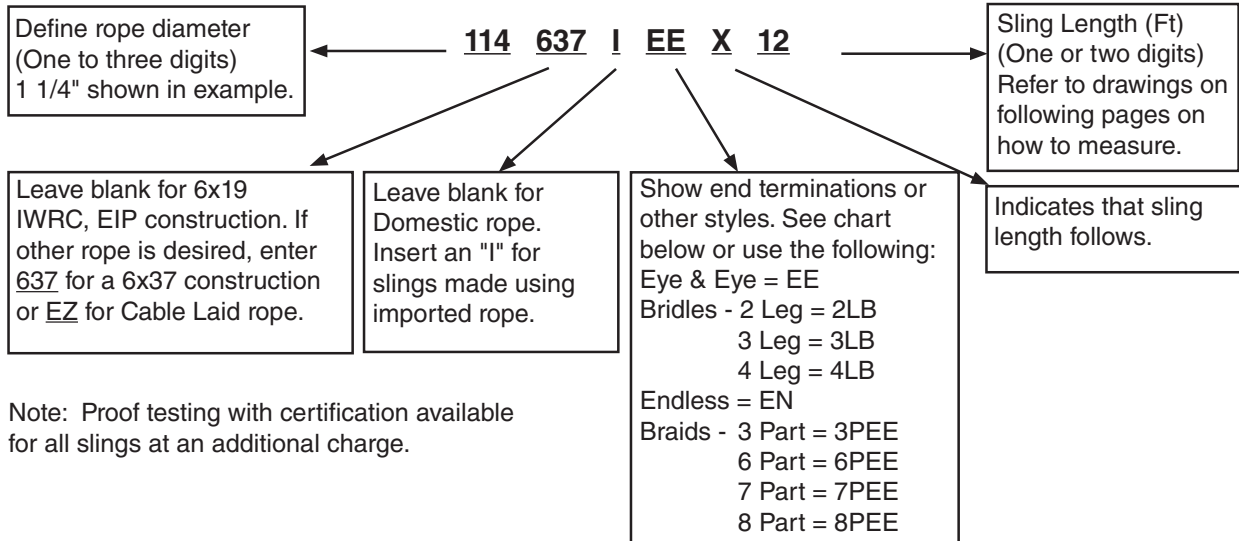

Note: Proof testing with certification available for all slings at an additional charge.

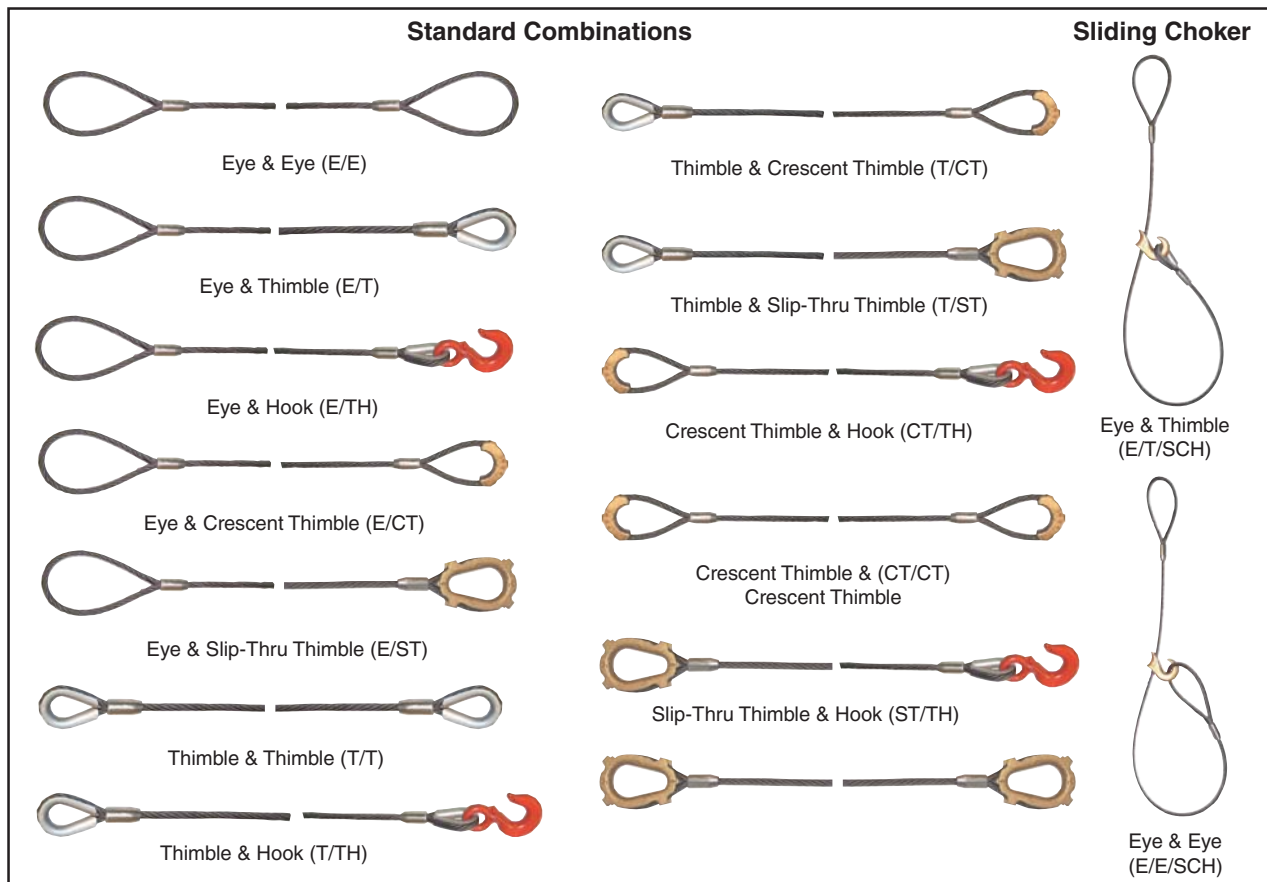

### Tolerances and Minimum Lengths

Refer to tables for tolerances and minimum lengths.

### Wire Rope Class

Standard rope classes are shown for each type and size of sling in the charts. Specific rope constructions are available upon request.

## PERMALOC WIRE ROPE SLINGS

Lift-All Permaloc Slings are made using the flemish splice technique to form the eyes. Unlike the simple return loop method that places 100% of its strength on the swaged sleeve, *Permaloc* slings have reserve strength should the sleeve become damaged in use.

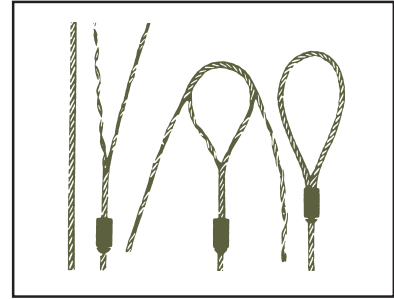

### Features, Advantages and Benefits

Maintains all the basic *Lift-All* wire rope sling features plus ...

Promotes Safety

- Reserve strength - integrity of eyes not solely dependent upon steel sleeves
- IWRC resists crushing better than FC ropes

Saves Money

- When specified, thimble eyes protect wire rope from wear for increased life
- Good abrasion resistance for longer life

**Permaloc With Single Part Body**

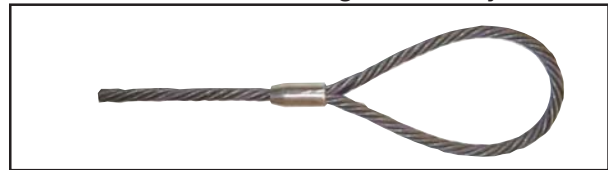

Mechanically swaged, flemish eye splice wire rope slings

### IWRC (Independent Wire Rope Core) Fiber core available at reduced capacities

Wire Rope

Wire Rope Class	Rope Dia. (in.)	EIP, IWRC			Min. Sling Length	Standard Eye Size (in.) W x L	Thimble Eye Size (in.) W x L	Eye Hook Cap. (tons)	Crescent Thimble Eye Size (in.) W x L	Slip Thru Thimble Eye Size (in.) W x L	Sliding Choker Hook (in.)
		Vertical	Choker	V. Basket							
	1/4	.65	.48	1.3	1' 6"	2 x 4	7/8 x 1 5/8	1	2 x 4	2 1/8 x 4 1/8	3/8
	5/16	1.0	.74	2.0	1' 9"	2 1/2 x 5	1 1/16 x 1 7/8	1	2 x 4	2 1/2 x 4 1/8	3/8
	3/8	1.4	1.1	2.9	2' 0"	3 x 6	1 1/8 x 2 1/8	1 1/2	2 x 4	2 1/2 x 4 1/8	3/8
	7/16	1.9	1.4	3.9	2' 3"	3 1/2 x 7	1 1/4 x 2 1/4	2	2 x 5	2 3/8 x 4 3/8	1/2
	1/2	2.5	1.9	5.1	2' 6"	4 x 8	1 1/2 x 2 3/4	3	2 1/4 x 6	2 3/8 x 4 3/8	1/2**
	9/16	3.2	2.4	6.4	2' 9"	4 1/2 x 9	1 1/2 x 2 3/4	4 1/2	2 1/4 x 7	2 3/8 x 4 3/8	5/8
	5/8	3.9	2.9	7.8	3' 0"	5 x 10	1 3/4 x 3 1/4	4 1/2	2 3/4 x 7	3 3/8 x 6 5/8	5/8**
	3/4	5.6	4.1	11	3' 6"	6 x 12	2 x 3 3/4	7	3 1/4 x 8 1/2	3 3/8 x 6 5/8	3/4**
	7/8	7.6	5.6	15	4' 0"	7 x 14	2 1/4 x 4 1/4	11	4 1/2 x 10	3 3/4 x 7 1/8	7/8
	1	9.8	7.2	20	4' 6"	8 x 16	2 1/2 x 4 1/2	11	4 1/2 x 11 1/2	3 3/4 x 7 1/8	1
	1 1/8	12	9.1	24	5' 0"	9 x 18	2 7/8 x 5 1/8	15	4 7/8 x 13	4 3/8 x 8 3/8	1 1/8
	1 1/4	15	11	30	5' 6"	10 x 20	3 1/2 x 6 1/2	15	5 1/2 x 14 1/2	4 3/8 x 8 3/8	1 1/4
	1 3/8	18	13	36	6' 0"	11 x 22	3 1/2 x 6 1/4	22	6 x 16	5 x 9 1/2	1 3/8
	1 1/2	21	16	42	7' 0"	12 x 24	3 1/2 x 6 1/4	22	6 x 17 1/2	5 x 9 1/2	1 1/2**
	1 3/4	28	21	57	8' 0"	14 x 28	4 1/2 x 9	30	7 x 20	6 3/4 x 11 3/4	-
	2	37	28	73	9' 0"	16 x 32	6 x 12	37	7 x 23 1/2	8 x 14 1/2	-
	2 1/4	44	35	89	10' 0"	18 x 36	7 x 14	45	8 1/2 x 26	8 x 15 1/2	-
2 1/2	54	42	109	11' 0"	20 x 40	-	-	8 1/2 x 29 1/2	-	-	

Note: Larger diameter slings available. Basket ratings are based on a minimum D/d of 25. See page 74.

1. 1 Ton = 2,000 lbs.

2. Minimum sling length when using standard eyes.

Note: **Length Tolerances** - Single Part Wire Rope Slings - Standard length tolerance is plus or minus two rope diameters, or plus or minus 0.5% of the sling length, whichever is greater.

\*\* See page 91 for reduced choker capacity when using these hook sizes.



Do not exceed rated capacities. Sling capacity decreases as the angle from horizontal decreases. Slings should not be used at angles of less than 30°. Refer to Effect of Angle chart page 12.

## PERMALOC BRIDLE SLINGS

### Features, Advantages and Benefits

Maintains all the basic *Lift-All* wire rope sling features plus ...

Promotes Safety

- Bridles provide better load control and balance
- Independent wire rope core resists crushing

Saves Money

- Alloy steel hooks and links assure long life
- Thimble eyes protect wire rope from wear for increased life
- Reduces load damage by using fixed points on load

Saves Time

- Easier rigging provided when hooking into fixed lifting points

Wire Rope

Permaloc Bridle Slings (With Single Part Body)				2-Leg Bridle				3-Leg Bridle				4-Leg Bridle			
				1 Rated Capacity (tons)*				1 Rated Capacity (tons)*				1 Rated Capacity (tons)*			
Rope Dia. (in.)	2 Min. Sling Length	Eye Hook Cap. (tons)	60°			Oblong Link Stock Dia.	60°			Oblong Link Stock Dia.	60°			Oblong Link Stock Dia.	
			45°	30°	45°		30°	45°	30°						
6 x 19 EIP, IWRC	1/4	1' 3"	1	1.1	.91	.65	1/2	1.7	1.4	.97	1/2	2.2	1.8	1.3	1/2
	5/16	1' 6"	1	1.7	1.4	1.0	1/2	2.6	2.1	1.5	1/2	3.5	2.8	2.0	3/4
	3/8	1' 8"	1 1/2	2.5	2.0	1.4	1/2	3.7	3.0	2.2	3/4	5.0	4.1	2.9	3/4
	7/16	1' 10"	2	3.4	2.7	1.9	3/4	5.0	4.1	2.9	3/4	6.7	5.5	3.9	1
	1/2	2'	3	4.4	3.6	2.5	3/4	6.6	5.4	3.8	1	8.8	7.1	5.1	1
	9/16	2' 2"	4 1/2	5.5	4.5	3.2	3/4	8.3	6.8	4.8	1	11	9.0	6.4	1 1/4
	5/8	2' 4"	4 1/2	6.8	5.5	3.9	1	10	8.3	5.9	1 1/4	14	11	7.8	1 1/2
	3/4	2' 9"	7	9.7	7.9	5.6	1 1/4	15	12	8.4	1 1/2	19	16	11	1 3/4
	7/8	3' 3"	11	13	11	7.6	1 1/4	20	16	11	1 1/2	26	21	15	2
	1	3' 6"	11	17	14	9.8	1 1/2	26	21	15	1 3/4	34	28	20	2 1/4
1 1/8	4'	15	21	17	12	1 1/2	31	26	18	1 3/4	42	34	24	2 3/4	
6x37 EIP, IWRC	1 1/4	4' 6"	15	26	21	15	1 3/4	38	31	22	2	51	42	30	2 3/4
	1 3/8	5'	22	31	25	18	1 3/4	46	38	27	2 1/4	-	-	-	-
	1 1/2	5' 6"	22	37	30	21	2	55	45	32	2 1/4	-	-	-	-
	1 3/4	6' 6"	30	49	40	28	2 1/4	-	-	-	-	-	-	-	-
	2	8'	37	63	52	37	2 3/4	-	-	-	-	-	-	-	-

Note: **Length Tolerances** - Single Part Wire Rope Slings - Standard length tolerance is plus or minus two rope diameters, or plus or minus 0.5% of the sling length, whichever is greater. The legs of bridle slings, or matched slings are normally held to within one rope diameter.

Other fittings and latches are available upon request.

1. 1 Ton = 2,000 lbs.
2. Minimum length based on thimble eye and eye hook.

**WARNING**

Do not exceed rated capacities. Sling capacity decreases as the angle from horizontal decreases. Slings should not be used at angles of less than 30°. Refer to Effect of Angle chart page 12.

## GROMMETS AND ENDLESS SLINGS

### Features, Advantages and Benefits

Maintains all the basic *Lift-All* wire rope sling features plus ...

Promotes Safety

- Load stability and balance can be achieved by spreading sling legs in a basket or choker hitch

Saves Money

- Wear points can be shifted to extend sling life
- The most versatile style of sling - fewer slings to inventory

Saves Time

- Ideal for turning loads
- More flexible than eye slings of comparable strength

### Grommets - Strand Laid, Hand Tucked

Made from one strand of EIP, 19 or 37 wire, hand laid and spliced to form a seven strand rope with no noticeable splice area. No sleeves to snag or get in the way.

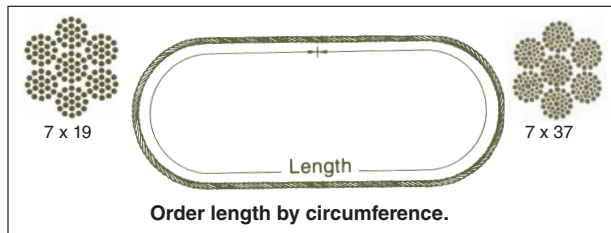

Rope Dia. (in.)	Rated Capacity (tons)*			Minimum Sling Length	Splice Length (in.)
	Vertical	Choker	Vertical Basket		
3/8	2.1	1.5	4.2	3' 0"	2 7/16
7/16	2.8	2.0	5.7	3' 6"	2 7/8
1/2	3.7	2.6	7.3	4' 0"	3 1/4
9/16	4.6	3.2	9.3	4' 6"	3 11/16
5/8	5.7	4.0	11	5' 0"	4 1/16
3/4	8.2	5.7	16	6' 0"	4 7/8
7/8	11	7.7	22	7' 0"	5 11/16
1	14	10	29	8' 0"	6 1/2

Vertical and Basket ratings are based on a minimum D/d of 5. See page 74.

### Endless - Mechanical Splice

Made from one 6 x 19 or 6 x 37 EIP, IWRC wire rope, mechanically joined with steel sleeves. Achieves higher capacities at a lower cost.

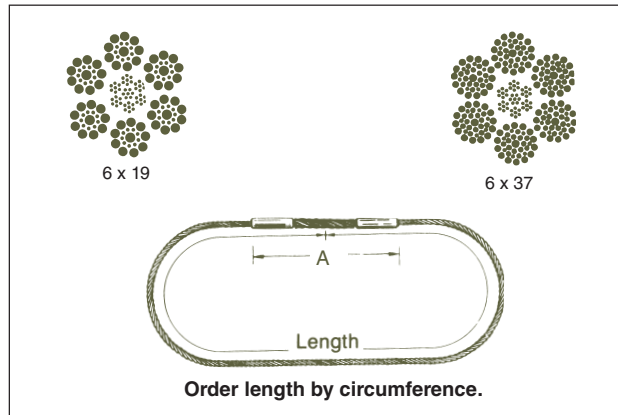

Rope Dia. (in.)	Rated Capacity (tons)*			Minimum Sling Length	Splice Length A (in.)
	Vertical	Choker	Vertical Basket		
1/4	1.0	.71	2.0	3' 0"	8
5/16	1.6	1.1	3.1	3' 0"	8
3/8	2.3	1.6	4.5	3' 0"	8
7/16	3.1	2.1	6.1	6' 0"	10
1/2	3.9	2.8	7.9	6' 0"	10
9/16	5.0	3.5	10	6' 0"	10
5/8	6.1	4.3	12	6' 0"	10
3/4	8.8	6.2	18	8' 0"	16
7/8	12	8.3	24	8' 0"	18
1	15	11	31	8' 0"	20

Note: 3 sleeves used on 3/4" and larger.

Vertical and Basket ratings are based on a minimum D/d of 5. See page 74.

**WARNING** Read Definition on page 3.

Do not lift with hook in splice area - sling damage may occur.

**WARNING**  
Do not exceed rated capacities. Sling capacity decreases as the angle from horizontal decreases. Slings should not be used at angles of less than 30°. Refer to Effect of Angle chart page 12.

## E-Z FLEX CABLE LAID SLINGS

E-Z Flex slings are made from a machine laid rope that consists of seven individual, galvanized ropes.

### Features, Advantages and Benefits

Maintains all the basic *Lift-All* wire rope sling features plus ...

Saves Money

- Superior flexibility - resists damage from kinking
- Galvanized coating for corrosion resistance and longer life

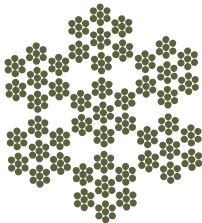

7 x 7 x 7

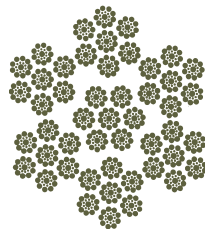

7 x 7 x 19

### Standard Combinations



Eye & Eye (E/E)



Eye & Thimble (E/T)



Eye & Hook (E/TH)



Eye & Crescent Thimble (E/CT)



Eye & Slip-Thru Thimble (E/ST)



Slip-Thru Thimble & Hook (ST/TH)



Slip-Thru Thimble & Slip-Thru Thimble (ST/ST)



Thimble & Thimble (T/T)

Wire Rope

	Rope Dia. (in.)	Rated Capacity (tons)*			** Min. Sling Length	Standard Eye Size (in.) W x L	Thimbled Eye Size (in.) W x L	Eye Hook Cap. (tons)	Crescent Thimble Eye Size (in.) W x L	Slip Thru Thimble Eye Size (in.) W x L	Sliding Choker Hook (in.)
		Vertical	Choker	Vertical Basket							
7 x 7 x 7	1/4	.50	.34	1.0	1' 6"	2 x 4	7/8 x 1 5/8	1	2 x 4	2 1/8 x 4 1/8	3/8
	3/8	1.1	.74	2.2	2' 0"	3 x 6	1 1/8 x 2 1/8	1 1/2	2 x 4	2 1/8 x 4 1/8	3/8
	1/2	1.9	1.3	3.7	2' 6"	4 x 8	1 1/2 x 2 3/4	2	2 1/4 x 6	2 3/8 x 4 3/8	1/2
	5/8	2.8	1.9	5.5	3' 0"	5 x 10	1 3/4 x 3 1/4	3	2 3/4 x 7	3 3/8 x 6 5/8	5/8
7 x 7 x 19	3/4	4.1	2.8	8.1	3' 6"	6 x 12	2 x 3 3/4	4 1/2	3 1/4 x 8 1/2	3 3/8 x 6 5/8	3/4
	7/8	5.4	3.7	11	4' 0"	7 x 14	2 1/4 x 4 1/4	7	4 1/2 x 10	3 3/4 x 7 1/8	7/8
	1	6.9	4.7	14	4' 6"	8 x 16	2 1/2 x 4 1/2	7	4 1/2 x 11 1/2	3 3/4 x 7 1/8	1
	1 1/8	8.3	5.8	17	5' 0"	9 x 18	2 7/8 x 5 1/8	11	4 7/8 x 13	4 3/8 x 8 3/8	1 1/8
	1 1/4	9.9	7.0	20	5' 6"	10 x 20	3 1/2 x 6 1/2	11	5 1/2 x 14 1/2	4 3/8 x 8 3/8	1 1/4
	1 1/2	13	9.1	26	7' 0"	12 x 24	3 1/2 x 6 1/4	15	6 x 17 1/2	5 x 9 1/2	1 1/2

\*\* Minimum sling length when using standard eyes.  
Basket ratings are based on a minimum D/d of 10. See page 74.  
Other fittings are available upon request.



Do not exceed rated capacities. Sling capacity decreases as the angle from horizontal decreases. Slings should not be used at angles of less than 30°. Refer to Effect of Angle chart page 12.

## E-Z FLEX TWO LEG BRIDLE SLINGS

### Features, Advantages and Benefits

Maintains all the basic *Lift-All* wire rope sling features plus ...

Promotes Safety

- Bridles provide better load control and balance

Saves Money

- Excellent flexibility - resists damage from kinking
- Galvanized coating for corrosion resistant longer life
- Alloy steel fittings assure long life

Saves Time

- Easier rigging provided when hooking into fixed lifting points
- Sliding choker hook speeds rigging of bundled materials

**▲ WARNING**

Read Definition on page 3.

Do not lift with hook in splice area - sling damage may occur.

### E-Z FLEX Two Leg Bridles

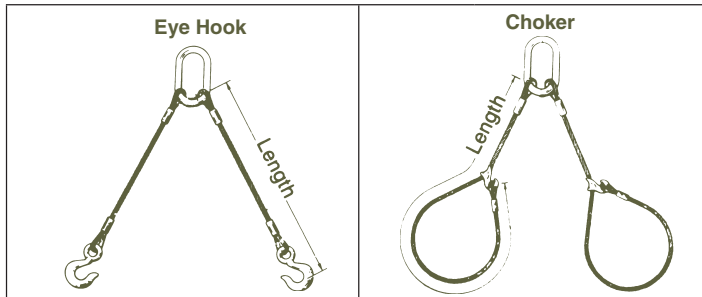

Rope Dia. (in.)	Rated Capacity (tons)*			Rated Capacity (tons)*			** Min. Sling Length	Oblong Link Stock Dia. (in.)	Eye Hook Cap. (tons)	Sliding Choker Hook (in.)	
	60°	45°	30°	60°	45°	30°					
7 x 7 x 7	1/4	.87	.71	.50	.60	.49	.34	1' 3"	1/2	1	3/8
	3/8	1.9	1.5	1.1	1.3	1.0	.74	1' 8"	1/2	1 1/2	3/8
	1/2	3.2	2.6	1.9	2.2	1.8	1.3	2' 0"	3/4	2	1/2
	5/8	4.8	3.9	2.8	3.3	2.7	1.9	2' 4"	1	3	5/8
7 x 7 x 19	3/4	7.0	5.8	4.1	4.8	3.9	2.8	2' 9"	1	4 1/2	3/4
	7/8	9.4	7.6	5.4	6.4	5.2	3.7	3' 3"	1	7	7/8
	1	12	9.7	6.9	8.2	6.7	4.7	3' 6"	1 1/4	7	1
	1 1/8	14	12	8.3	10	8.2	5.8	4' 0"	1 1/2	11	1 1/8
	1 1/4	17	14	9.9	12	9.8	7.0	4' 6"	1 1/2	11	1 1/4
1 1/2	22	18	13	15	13	9.1	5' 6"	2	15	1 1/2	

\*\* Minimum length based on thimble eye and eye hook.

**▲ WARNING**

Do not exceed rated capacities. Sling capacity decreases as the angle from horizontal decreases. Slings should not be used at angles of less than 30°. Refer to Effect of Angle chart page 10.

Wire Rope



## E-Z FLEX ENDLESS SLINGS

### Features, Advantages and Benefits

Maintains all the basic *Lift-All* wire rope sling features plus ...

#### Promotes Safety

- Load stability and balance achieved by spreading sling legs in basket and choker hitches

#### Saves Money

- Wear points can be shifted to extend sling life
- Smaller rope diameter per capacity increases flexibility

#### Saves Time

- Ideal for turning loads
- More flexible than eye slings of comparable strength

**⚠ WARNING** Read Definition on page 3

Do not lift with hook in splice area - sling damage may occur.

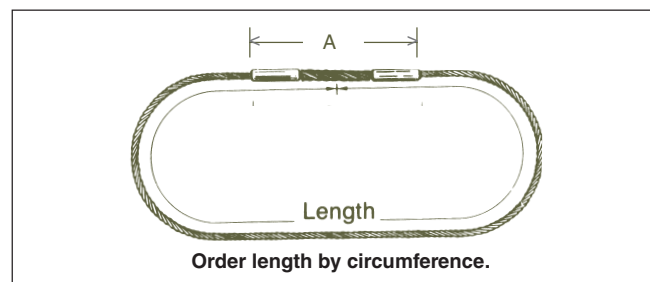

Note: 3 sleeves used on 3/4" and larger.

Wire Rope

### E-Z FLEX Endless Slings

	Rope Dia. (in.)	Rated Capacity (tons)*			Min. Sling Length	Splice Length A (in.)
		Vertical	Choker	Vertical Basket		
7 x 7 x 7	1/4	.83	.54	1.7	2' 3"	10
	3/8	1.8	1.2	3.6	3' 0"	10
	1/2	3.0	2.0	6.1	4' 0"	12
	5/8	4.6	3.0	9.1	5' 0"	12
7 x 7 x 19	3/4	6.7	4.3	13	6' 0"	18
	7/8	8.9	5.8	18	7' 0"	18
	1	11	7.3	23	8' 0"	20

Vertical and Basket ratings are based on a minimum D/d of 5. See page 74.

\* **⚠ WARNING** Do not exceed rated capacities. Sling capacity decreases as the angle from horizontal decreases. Slings should not be used at angles of less than 30°. Refer to Effect of Angle chart page 12.

## HIDDEN TUCK HAND SPLICED SLINGS

### Features, Advantages and Benefits

Maintains all the basic *Lift-All* wire rope sling features plus ...

Promotes Safety

- Hidden Tuck buries wire ends to avoid snags and injuries

Saves Time

- No steel sleeves to catch under load

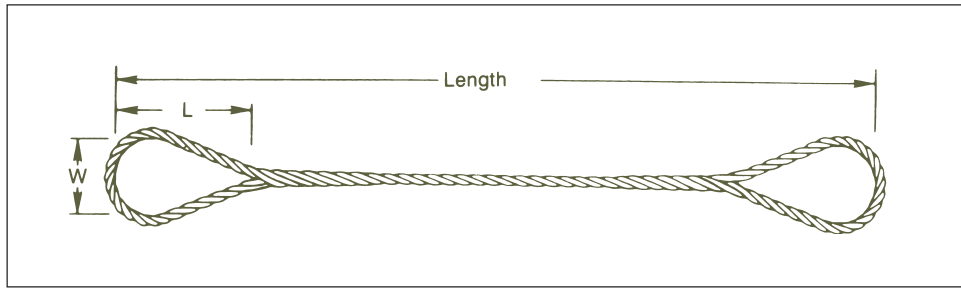

Wire Rope

### Fiber Core

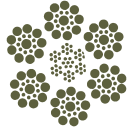
	Rope Dia. (in.)	EIP, FC			Min. Sling Length	Standard Eye Size (in.) W x L
		Rated Capacity (tons)*				
		Vertical	Choker	Vertical Basket		
 6 x 19 EIP, FC	1/4	.54	.42	1.1	2' 0"	3 x 6
	5/16	.83	.66	1.7	2' 3"	3 x 6
	3/8	1.2	.94	2.4	2' 6"	3 x 6
	7/16	1.6	1.3	3.2	2' 9"	3 1/2 x 7
	1/2	2.0	1.6	4.0	3' 0"	4 x 8
	9/16	2.5	2.1	5.0	3' 6"	4 1/2 x 9
	5/8	3.1	2.6	6.2	4' 0"	5 x 10
	3/4	4.3	3.7	8.6	4' 6"	6 x 12
	7/8	5.7	5.0	11	5' 6"	7 x 14
	1	7.4	6.4	15	6' 0"	8 x 16

Basket ratings are based on a minimum D/d of 15. See page 74.

### **WARNING**

Do not exceed rated capacities. Sling capacity decreases as the angle from horizontal decreases. Slings should not be used at angles of less than 30°. Refer to Effect of Angle chart page 12.

# Wire Rope & Slings

## MULTI - PART CABLED SLINGS

### Three Part Cabled

Constructed by hand cabling one rope to form a three part body with two part eyes.



3 x 7 x 19

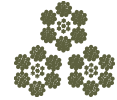

3 x 6 x 19

### 3 Part Cabled

#### Features, Advantages and Benefits

Maintains all the basic *Lift-All* wire rope sling features plus ...

#### Saves Money

- Good abrasion resistance increases useful life of sling
- Resists damage from kinking

#### Saves Time

- Flexible, easy to handle by rigger
- Small sleeve over component rope won't get in the way

	Component Rope Dia. (in.)	Sling Body Dia. (in.)	Rated Capacity (tons)*			Min. Sling Length	Standard Eye (in.) W x L	Crescent Thimble Eye Size (in.) W x L	Slip Thru Thimble Eye Size (in.) W x L
			Vertical	Choker	Vertical Basket				
7 x 19 GAC	3/16	3/8	1.2	.82	2.4	2' 0"	3 x 6	2 x 4	2 1/8 x 4 1/8
	1/4	1/2	1.9	1.3	3.9	2' 6"	4 x 8	2 1/4 x 4	2 3/8 x 4 3/8
	5/16	5/8	3.0	2.1	6.0	3' 0"	5 x 10	2 3/4 x 5	3 3/8 x 6 5/8
7 x 19 EIP, IWRC	3/8	3/4	4.3	2.9	8.6	3' 6"	6 x 12	3 1/4 x 6	3 3/8 x 6 5/8
	7/16	7/8	5.8	4.0	12	4' 0"	7 x 14	4 1/2 x 9	3 3/4 x 7 1/8
6 x 19 EIP, IWRC	1/2	1	7.6	5.2	15	4' 6"	8 x 16	4 1/2 x 9	3 3/4 x 7 1/8
	9/16	1 1/8	9.6	6.6	19	5' 0"	9 x 18	4 7/8 x 10	4 3/8 x 8 3/8
	5/8	1 1/4	12	8.0	23	5' 6"	10 x 20	5 1/2 x 11	4 3/8 x 8 3/8
	3/4	1 1/2	17	11	34	7' 0"	11 x 22	6 x 12	5 x 9 1/2

Basket ratings are based on a minimum D/d of 10 (using sling body dia.). See page 74.

### Seven Part Cabled

Constructed by hand cabling one rope to form a seven part body with four part eyes.

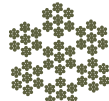

7 x 7 x 19

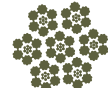

7 x 6 x 19

### 7 Part Cabled

#### Features, Advantages and Benefits

Maintains all the basic *Lift-All* wire rope sling features plus ....

#### Saves Money

- Resists damage from kinking

#### Saves Time

- Superior flexibility makes sling easy to rig and use
- Small sleeve over component rope won't get in the way

	Component Rope Dia. (in.)	Sling Body Dia. (in.)	Rated Capacity (tons)*			Min. Sling Length	Standard Eye (in.) W x L	Crescent Thimble Eye Size (in.) W x L	Slip Thru Thimble Eye Size (in.) W x L
			Vertical	Choker	Vertical Basket				
7 x 19 GAC	1/8	3/8	1.3	.91	2.6	2' 0"	3 x 6	2 x 4	2 1/8 x 4 1/8
	3/16	9/16	2.8	1.9	5.6	2' 6"	4 x 8	2 1/4 x 6	2 3/8 x 4 3/8
	1/4	3/4	4.7	3.2	9.3	3' 0"	5 x 10	2 3/4 x 7	3 3/8 x 6 5/8
	5/16	15/16	6.5	4.5	13	3' 6"	6 x 12	3 1/4 x 8 1/2	3 3/4 x 7 1/8
	3/8	1 1/8	9.6	6.6	19	4' 0"	7 1/2 x 15	4 1/2 x 10	3 3/4 x 7 1/8
6 x 19	7/16	1 5/16	14	9.3	27	4' 6"	9 x 18	4 7/8 x 13	4 3/8 x 8 3/8
	1/2	1 1/2	18	12	35	5' 0"	10 x 20	5 1/2 x 14 1/2	4 3/8 x 8 3/8

Basket ratings are based on a minimum D/d of 10 (using sling body dia.). See page 74.

\* **WARNING** Do not exceed rated capacities. Sling capacity decreases as the angle from horizontal decreases. Slings should not be used at angles of less than 30°. Refer to Effect of Angle chart page 12.

Wire Rope

## MULTI - PART BRAIDED SLINGS

### Six Part Flat Braid

Constructed by braiding one rope to form a six part flat body with web seized eyes.



6 Part Flat Braid

### Features, Advantages And Benefits

Maintains all the basic *Lift-All* wire rope sling features plus ...

Promotes Safety

- Wide bearing surface provides better load control and balance
- Resists rotation, improving load control

Saves Money

- Resists damage from kinking
- Reduces load damage by gripping load better

Saves Time

- Flexible - easy to rig

	Component Rope Dia. (in.)	Sling Body Dia. (in.)	Rated Capacity (tons)*			Min. Sling Length	Standard Eye (in.) W x L	Crescent Thimble Eye Size (in.) W x L	Slip Thru Thimble Eye Size (in.) W x L
			Vertical	Choker	Vertical Basket				
7 x 19 GAC	1/8	9/16 x 3/8	.84	.74	1.7	2' 0"	3 x 6	2 x 4	2 1/8 x 4 1/8
	3/16	13/16 x 1/2	1.8	1.5	3.5	3' 0"	4 x 8	2 1/4 x 7	2 3/8 x 4 3/8
	1/4	1 1/8 x 11/16	2.9	2.6	5.9	3' 6"	5 x 10	3 1/4 x 8 1/2	3 3/8 x 6 5/8
	5/16	1 3/8 x 7/8	4.1	3.6	8.2	4' 6"	6 x 12	4 1/2 x 11 1/2	3 3/8 x 6 5/8
	3/8	1 11/16 x 1	6.0	5.3	12	5' 0"	7 x 14	4 7/8 x 13	3 3/4 x 7 1/8
6 x 19	7/16	2 x 1 3/16	8.6	7.5	17	6' 0"	8 x 16	6 x 16	3 3/4 x 7 1/8
	1/2	2 1/4 x 1 5/16	11	9.8	22	6' 6"	9 x 18	6 x 17 1/2	4 3/8 x 8 3/8
	9/16	2 1/2 x 1 1/2	14	12	28	7' 0"	10 x 20	7 x 20	4 3/8 x 8 3/8
	5/8	2 13/16 x 1 11/16	17	15	35	8' 0"	11 x 22	7 x 23 1/2	5 x 9 1/2
	3/4	3 3/8 x 2	25	22	49	9' 0"	12 x 24	8 1/2 x 26	6 3/4 x 11 3/4

Basket ratings are based on a minimum D/d of 25 (using component rope). See page 74.

### Eight Part Round Braid

Constructed by braiding one rope to form an eight part round body with four part web seized eyes.



8 Part Round Braid

### Features, Advantages And Benefits

Maintains all the basic *Lift-All* wire rope sling features plus ...

Promotes Safety

- Resists rotation, for improved load control

Saves Money

- The most kink resistant sling available
- Greater flexibility for reduced load damage

Saves Time

- The most flexible sling available - easy to rig

	Component Rope Dia. (in.)	Sling Body Dia. (in.)	Rated Capacity (tons)*			Min. Sling Length	Standard Eye (in.) W x L	Crescent Thimble Eye Size (in.) W x L	Slip Thru Thimble Eye Size (in.) W x L
			Vertical	Choker	Vertical Basket				
7 x 19 GAC	1/8	9/16	1.1	1.0	2.2	2' 0"	3 x 6	2 x 4	2 1/8 x 4 1/8
	3/16	13/16	2.4	2.1	4.7	3' 0"	4 x 8	2 1/4 x 6	2 3/8 x 4 3/8
	1/4	1 1/8	3.9	3.4	7.8	3' 6"	5 x 10	3 1/4 x 8	3 3/8 x 6 5/8
	5/16	1 3/8	5.5	4.8	11	4' 6"	6 x 12	4 1/2 x 10	3 3/4 x 7 1/8
	3/8	1 11/16	8.1	7.1	16	5' 0"	7 x 14	4 5/8 x 12	3 3/4 x 7 1/8
6 x 19 EIP/WRC	7/16	2	11	10	23	6' 0"	8 x 16	5 1/2 x 14	4 3/8 x 8 3/8
	1/2	2 1/4	15	13	30	6' 6"	9 x 18	6 x 16	5 x 9 1/2
	9/16	2 1/2	19	16	38	7' 0"	10 x 20	6 1/2 x 18	5 x 9 1/2
	5/8	2 13/16	23	20	46	8' 0"	11 x 22	7 x 20	6 3/4 x 11 3/4
	3/4	3 3/8	33	29	66	9' 0"	12 x 24	8 x 24	8 x 14 1/2

Basket ratings are based on a minimum D/d of 25 (using component rope). See page 74.

**WARNING**

Do not exceed rated capacities. Sling capacity decreases as the angle from horizontal decreases. Slings should not be used at angles of less than 30°. Refer to Effect of Angle chart page 12.

## SWAGED THREADED STUDS

- Choice of studs made of specially selected carbon steel or stainless steel
- Custom OEM engineering available

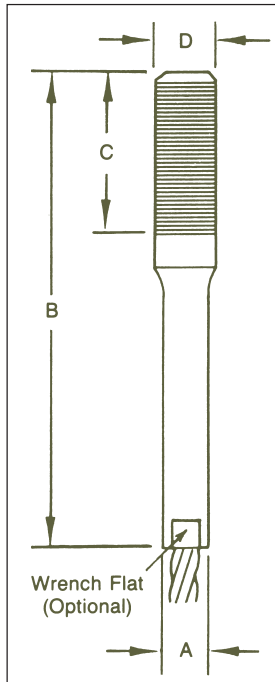

**Straight Threaded Studs**

Part No.	Rope Dia (in.)	Nominal Breaking Strength (tons)*	Dimensions (in.)				N.C. Thread #	N.F. Thread #
			A After Swage	B Approx.	C	D		
STS-8	1/4	3.4	7/16	4 1/16	1 1/2	1/2	13	20
STS-10	5/16	5.3	9/16	5 1/4	1 7/8	5/8	11	18
STS-12	3/8	7.6	5/8	6 1/4	2 1/4	3/4	10	16
STS-14	7/16	10.2	3/4	7 5/16	2 5/8	7/8	9	14
STS-16	1/2	13.3	7/8	8 1/4	3	1	8	14
STS-18	9/16	16.8	1	9 1/4	3 3/8	1 1/8	7	12
STS-20	5/8	20.6	1 1/8	10 1/8	3 3/4	1 1/4	7	12
STS-24	3/4	29.4	1 1/4	12 13/16	4 1/2	1 1/2	6	12
STS-28	7/8	39.5	1 1/2	14 9/16	5 1/4	1 3/4	5	12
STS-32	1	51.7	1 3/4	16 1/4	6	2	4 1/2	12
STS-36	1 1/8	65.0	2	18 1/4	6 3/4	2 1/4	4 1/2	12
STS-40	1 1/4	79.9	2 1/4	20 1/4	7 1/2	2 1/2	4	12

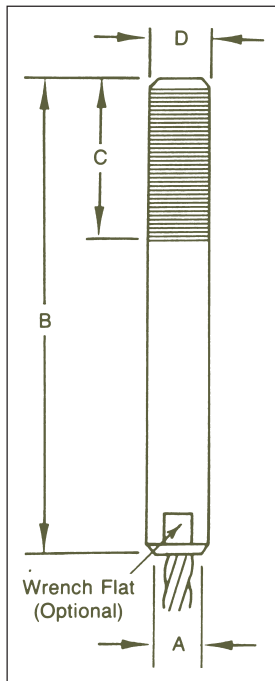

**Turned Threaded Studs**

Part No.	Rope Dia (in.)	Nominal Breaking Strength (tons)*	Dimensions (in.)				N.C. Thread #	N.F. Thread #
			A After Swage	B Approx.	C	D		
TTS-10	5/16	5.3	5/8	5 23/32	1 3/4	5/8	11	18
TTS-12	3/8	7.6	3/4	6 3/4	2	3/4	10	16
TTS-14	7/16	10.2	7/8	7 21/32	2 1/4	7/8	9	14
TTS-16	1/2	13.3	1	8 9/16	2 1/2	1	8	14
TTS-18	9/16	16.8	1 1/8	9 5/8	2 3/4	1 1/8	7	12
TTS-20	5/8	20.6	1 1/4	10 21/32	3 1/8	1 1/4	7	12
TTS-24	3/4	29.4	1 1/2	12 11/16	3 3/4	1 1/2	6	12
TTS-28	7/8	39.5	1 3/4	14 5/8	4 3/8	1 3/4	5	12
TTS-32	1	51.7	2	16 21/32	5	2	4 1/2	12
TTS-36	1 1/8	65.0	2 1/4	18 5/8	5 5/8	2 1/4	4 1/2	12
TTS-40	1 1/4	79.9	2 1/2	20 21/32	6 1/4	2 1/2	4	12
TTS-44	1 3/8	96.0	2 3/4	22 17/32	6 7/8	2 3/4	4	12
TTS-48	1 1/2	114	3	24 1/2	7 1/2	3	4	12

\* Nominal Breaking Strength based on 6 x 19 or 6 x 37 IWRC, EIP wire rope, with assembly used as a straight tension member.

## SWAGED SOCKET ASSEMBLIES

### Features, Advantages and Benefits

Promotes Safety

- Achieves 100% of nominal rope breaking strength
- All assemblies are proof tested before shipment to customer

Saves Money

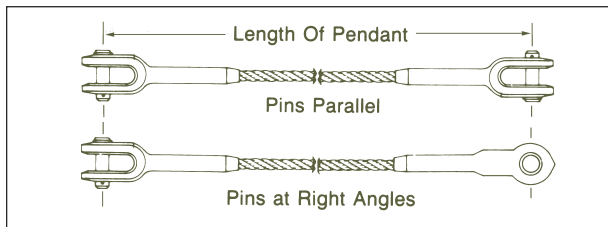

- Custom engineered assemblies are available for specific rigging needs

### Open Swaged Sockets

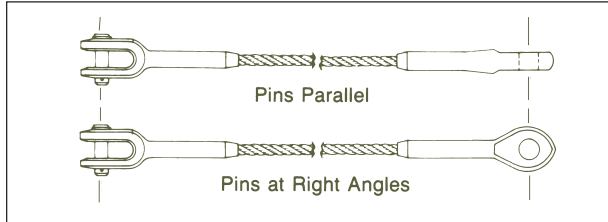

### Open and Closed Swaged Sockets





 Rope Diameter (in.)	Minimum Pendant Length	 Vertical Capacity (tons) *
1/4	11"	.68
5/16	1' 3"	1.1
3/8	1' 3"	1.5
7/16	1' 8"	2.0
1/2	1' 8"	2.7
9/16	2' 0"	3.4
5/8	2' 0"	4.1
3/4	2' 5"	5.9
7/8	2' 10"	8.0
1	3' 2"	10
1 1/8	3' 7"	13
1 1/4	4' 0"	16

\* Values given apply to 6 x 19 or 6 x 37 IWRC, EIP rope when pendants are used for slings. When used as Boom Suspension System or other applications, contact *Lift-All* for ratings.

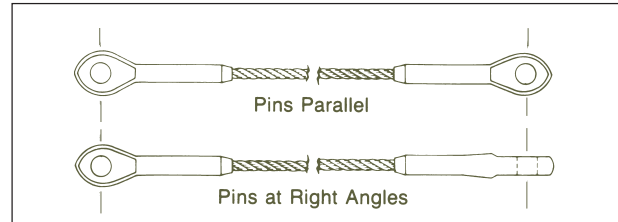
### Closed Swaged Sockets

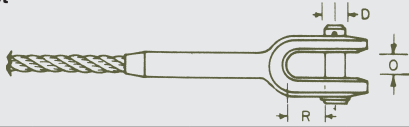

### Swage Socket Dimensions (Forged Steel)

 Rope Dia (in.)	Open Socket 				Closed Socket 		
	R (in.)	O (in.)	D (in.)	Weight (lbs.)	W (in.)	K (in.)	Weight (lbs.)
1/4	1 5/32	11/16	11/16	.52	3/4	1/2	.38
5/16	1 11/32	13/16	13/16	1.12	7/8	11/16	.77
3/8	1 11/32	13/16	13/16	1.25	7/8	11/16	.72
7/16	1 1/2	1	1	2.08	1 1/16	7/8	1.42
1/2	1 1/2	1	1	2.08	1 1/16	7/8	1.35
9/16	1 5/8	1 1/4	1 3/16	4.48	1 1/4	1 1/8	2.92
5/8	1 5/8	1 1/4	1 3/16	4.75	1 1/4	1 1/8	2.85
3/4	2	1 1/2	1 3/8	7.97	1 7/16	1 5/16	4.90
7/8	2 3/8	1 3/4	1 5/8	11.30	1 11/16	1 1/2	6.63
1	2 3/4	2	2	17.80	2 1/16	1 3/4	10.30
1 1/8	3 1/8	2 1/4	2 1/4	27.50	2 5/16	2	14.50
1 1/4	3 1/2	2 1/2	2 1/2	35.75	2 9/16	2 1/4	20.75

## WINCH LINES, HOIST LINES AND BUTTONS

### Winch and Hoist Line Cables

Lift-All winch and hoist lines are made using 6 x 19 Wire Core ropes for better resistance to abrasion and crushing. Available with carbon hooks for large throat openings or alloy hooks for longer life.

### Features, Advantages and Benefits

Promotes Safety

- *Permaloc* flemish eye splice for high strength efficiency
- Quality factory assembly avoids faulty termination

Saves Money

- Economical standard assemblies
- Heavy duty thimble in eye extends useful life

Saves Time

- No assembly time - ready to install
- Stainless steel latch keeps hook in proper place



Winch and Hoist Line Cables

### 6 x 19 Class-Bright (Uncoated)

Diameter (in.)	Breaking Strength
	IWRC
3/8	14,000 lbs.
7/16	19,000 lbs.
1/2	25,000 lbs.
9/16	32,000 lbs.
5/8	39,000 lbs.

### Swaged Steel Buttons

Swaged steel buttons are designed for use as end stops on drum winding equipment such as hoists and winches.

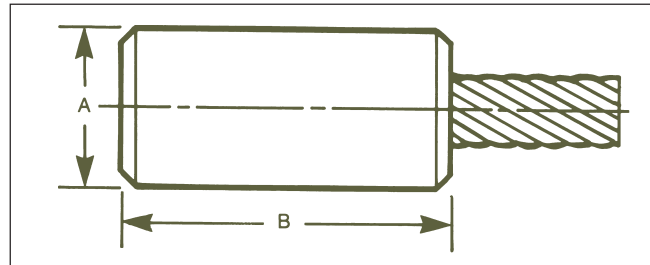

### After Swage Dimensions

Rope Diameter (approx. in.)	A	B
1/4	5/8	1 1/8
5/16	3/4	1 1/2
3/8	7/8	1 3/4
7/16	1	2
1/2	1 1/8	2 3/8
9/16	1 1/4	2 5/8
5/8	1 3/8	2 7/8
3/4	1 1/2	3 1/2
7/8	1 3/4	4 1/8
1	2	4 3/4
1 1/8	2 1/4	5 1/4
1 1/4	2 1/2	5 7/8
1 3/8	2 3/4	6 1/2
1 1/2	3	7 1/8

Non-Standard Buttons available.



Running lengths of cable with thimble eye ends available

## WIRE ROPE

### Wire Rope

These high quality wire ropes are available in cut lengths or by the reel.

#### 6 x 19 and 6 x 37 Class Wire Rope

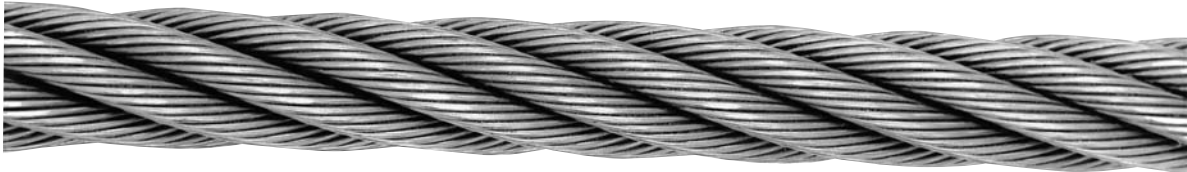

		Wire Core	
		Extra Improved Plow Steel (EIP) Higher Capacities	
<b>6 x 19 Class</b>			
Six Strand Ropes Having 9 to 26 Wires Per Strand Better Abrasion Resistance			
<b>6 x 37 Class</b>			
Six Strand Ropes Having 27 to 49 Wires Per Strand More Flexible			
Rope Diameter (in.)	Approx. Weight per Foot (lbs.)	Nominal Breaking Strength (tons)	
1/4	.12	3.40	
5/16	.18	5.27	
3/8	.26	7.55	
7/16	.35	10.2	
1/2	.46	13.3	
9/16	.59	16.8	
5/8	.72	20.6	
3/4	1.04	29.4	
7/8	1.42	39.8	
1	1.85	51.7	
1 1/8	2.34	65.0	
1 1/4	2.89	79.9	
1 3/8	3.50	96.0	
1 1/2	4.16	114	
1 5/8	4.88	132	
1 3/4	5.67	153	
1 7/8	6.50	174	
2	7.39	198	

Note: Specialty ropes are available upon request.

### Rotation Resistant Wire Rope

	Rope Dia. (in.)	Approx. Weight per Foot (lbs.)	Nominal Breaking Strength (tons)
	3/8	.25	6.15
	7/16	.35	8.33
	1/2	.45	10.8
	9/16	.58	13.6
	5/8	.71	16.8
	3/4	1.02	24.0
	7/8	1.39	32.5
	1	1.82	42.2
	1 1/8	2.3	53.1

The Nominal Breaking Strength of a wire rope should be considered the straight line pull with both rope ends fixed to prevent rotation, which will ACTUALLY BREAK a new, UNUSED, rope. The Nominal Breaking Strength of a rope should NEVER BE USED AS ITS WORKING LOAD.

To determine the working load of a wire rope, the MINIMUM or NOMINAL Breaking Strength MUST BE REDUCED by a DESIGN FACTOR. The design Factor will vary depending upon the type of machine and installation, and the work permitted. YOU must determine the applicable Design Factor for your use.

For example, a Design Factor of "5" means that the Minimum or Nominal Breaking Strength of the wire rope must be DIVIDED BY FIVE to determine the maximum load that can be applied to the rope system.

Design Factors have been established by OSHA, by ANSI, by ASME and similar government and industrial organizations.

No wire rope should ever be installed or used without full knowledge and consideration of the Design Factor for the application.

The above is based on the 'Wire Rope Safety Bulletin' published by the "WIRE ROPE TECHNICAL BOARD".



## CABLE & COMPONENTS



### Galvanized and Stainless Steel Cable

7 x 7	Cable Diameter (in.)	Wt./Reel (lbs.)	Standard Length (ft./Reel)	Nominal Break Strength (lbs.)	
				Galvanized Cable (GAC)	Stainless Steel Cable (SSAC) Type 304
	1/16	5	500	480	480
	3/32	9	500	920	920
	1/8	15	500	1,700	1,760

7 x 19	Cable Diameter (in.)	Wt./Reel (lbs.)	Standard Length (ft./Reel)	Galvanized Cable (GAC)	Stainless Steel Cable (SSAC) Type 304					
						3/32	9	500	1,000	920
						1/8	15	500	2,000	1,760
						5/32	12	250	2,800	2,400
						3/16	17	250	4,200	3,700
						1/4	25	250	7,000	6,400
						5/16	38	200	9,800	9,000
3/8	52	200	14,400	12,000						

### Galvanized Cable Coated with Clear Vinyl

Galvanized Cable Construction	Cable Diameter (in.)	Coated To: (in.)	Wt./Reel (lbs.)	Standard Length (ft./Reel)	Nominal Break Strength (lbs.)
7 x 7	1/16	3/32	7	500	480
	3/32	3/16	7	250	920
	1/8	3/16	10	250	1,700
7 x 19	1/8	3/16	10	250	2,000
	3/16	1/4	19	200	4,200
	1/4	5/16	28	200	7,000

### Heavy Duty Wire Rope Thimbles

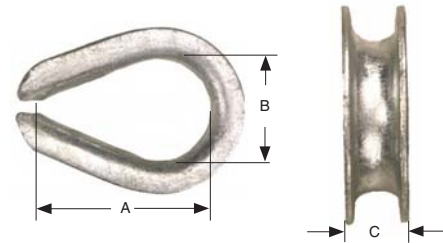

### Standard Wire Rope Thimbles

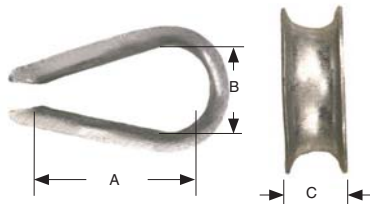

Rope Dia. (in.)	Dimensions (in.)			Quantity Per Bag	Weight Per Bag (lbs.)
	A	B	C		
1/8	1 5/16	11/16	1/4	100	4
3/16	1 5/16	11/16	5/16	100	4
1/4	1 5/16	11/16	3/8	100	4
5/16	1 1/2	13/16	7/16	80	3
3/8	1 5/8	15/16	1/2	80	4

Rope Dia. (in.)	Dimensions (in.)			Weight Per 100 Pieces (lbs.)
	A	B	C	
1/4	1 5/8	7/8	7/16	8
5/16	1 7/8	1 1/16	17/32	14
3/8	2 1/8	1 1/8	21/32	22
7/16	2 5/16	1 1/4	3/4	36
1/2	2 3/4	1 1/2	15/16	51
5/8	3 1/4	1 3/4	1 1/32	75
3/4	3 3/4	2	1 1/4	147
7/8	4 1/4	2 1/4	1 7/16	185
1	4 1/2	2 1/2	1 11/16	300
1 1/8	5 1/8	2 7/8	1 13/16	400
1 1/4	6 1/2	3 1/2	2 3/16	817
1 3/8 - 1 1/2	6 1/4	3 1/2	2 9/16	1,175
1 5/8	8	4	2 23/32	1,700
1 3/4	9	4 1/2	2 27/32	1,775
1 7/8 - 2	12	6	3 3/32	2,500
2 1/4	14	7	3 5/8	3,950

## CABLE & COMPONENTS

### Wire Rope Clips

The following instructions, supplied by the Wire Rope Technical Board, will result in an approximate 80% efficiency rating when the clips are applied as instructed, on GAC, SSAC, RRL or RLL, 6 x 19 class or 6 x 37 class, fiber core or IWRC, non-Seale type construction wire rope. If applied to vinyl coated ropes, vinyl must first be stripped from clip connection area.

#### How to Apply Clips

1. Turn back the specified amount of rope from the thimble. Apply the first clip one clip width from the dead end of the wire rope (U-bolt over dead end - live end rests in clip saddle). Tighten nuts evenly to recommended torque.
2. Apply the next clip as near to the loop as possible. Turn on nuts firmly but do not tighten.
3. Space additional clips, if required, equally between the first two. Tighten on nuts - take up rope slack - tighten all nuts evenly on all clips to recommended torque.
4. **NOTICE!** Apply the initial load and retighten nuts to the recommended torque. Rope will stretch and be reduced in diameter when loads are applied. Inspect periodically and retighten to recommended torque.



Right Way - For Maximum Rope Strength



Wrong Way - Clips Staggered



Wrong Way - Clips Reversed



#### **⚠ WARNING**

Failure to make a termination in accordance with aforementioned instructions, or failure to periodically check and retighten to the recommended torque, may result in death or serious injury.

### Drop Forged Wire Rope Clips

Rope Dia. (in.)	Minimum Number of Clips	Rope Turn-back (in.)	Torque (ft./lbs.)	Weight Per 100 Pieces (lbs.)
1/8	2	3 1/4	4 1/2	6
3/16	2	3 3/4	7 1/2	10
1/4	2	4 3/4	15	18
5/16	2	5 1/4	30	30
3/8	2	6 1/2	45	47
7/16	2	7	65	76
1/2	3	11 1/2	65	80
9/16	3	12	95	104
5/8	3	12	95	106
3/4	4	18	130	150
7/8	4	19	225	212
1	5	26	225	250
1 1/8	6	34	225	280
1 1/4	7	44	360	415
1 3/8	7	44	360	460
1 1/2	8	54	360	530

### Malleable Wire Rope Clips

Rope Dia. (in.)	Minimum Number of Clips	Rope Turn-back (in.)	Torque (ft./lbs.)	Quantity Per Bag	Weight Per Bag (lbs.)
1/8	3	5	3	200	10
3/16	3	6	5	150	12
1/4	3	7	15	100	12
5/16	3	8	15	100	15
3/8	3	10	30	50	11

Note: Malleable clips are not to be used for overhead lifting. Use in light duty, non-critical applications only.

## SLING ATTACHMENTS, HOOKS, ETC.

### Alloy Oblong Master Links

- Drop forged through 1", formed and welded in larger sizes.

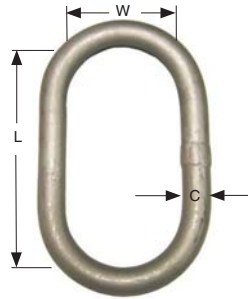

Rated Capacity*		Dimensions (in.)			Weight Each (lbs.)
Tons	Lbs.	C	L	W	
3.05	6,100	1/2	5	2 1/2	.9
6.6	13,200	3/4	6	3	2.5
11.2	22,400	1	8	4	5.8
16.2	32,400	1 1/4	8 3/4	4 3/8	9.2
24.5	49,000	1 1/2	10 1/2	5 1/4	16
36.7	73,400	1 3/4	12	6	25
44.4	88,800	2	14	7	37
62.6	125,200	2 1/4	16	8	54
93.9	187,800	2 3/4	16	9	85

### Sliding Choker Hooks

- Speeds rigging time of bundled loads.
- Reduces sling wear when used with thimbles. When using on multi-part slings, contact *Lift-All* for additional information.



Hook No. (Rope Dia.)	Rated Capacity* (tons)	Dimension (in.)	Weight (lbs.)
		H	
3/8	1.3	4 1/4	1.3
1/2	1.7	4 13/16	1.8
5/8	2.5	5 15/16	4
3/4	4.0	6 7/16	4.5
7/8 - 1	7.5	8 1/8	10
1 1/8 - 1 1/4	11.5	11 5/8	26
1 3/8 - 1 1/2	15	14 1/2	50

### Screw Pin Anchor Shackles

- Carbon Shackle, Alloy Pin
- Heat treated and tempered
- Hot dip galvanized

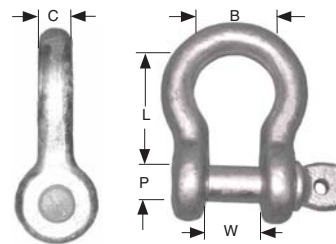

Note: This chart shows standard capacities and dimensions, but may vary depending on source of supply. Specify required capacity if critical.

Spec: RR-C-271F  
Type 4A, Grade A, Class 2

Shackle Size Dim. C (in.)	Rated Capacity* (tons)		Dimensions (in.)				Weight per 100 Pieces (lbs.)
	CM	Others	B	L	P	W	
3/16	1/2	1/3	5/8	7/8	1/4	3/8	6
1/4	3/4	1/2	13/16	1 1/8	5/16	15/32	12
5/16	1	3/4	7/8	1 1/4	3/8	17/32	20
3/8	1 1/2	1	1 1/16	1 7/16	7/16	21/32	30
7/16	2	1 1/2	1 1/4	1 11/16	1/2	23/32	50
1/2	3	2	1 7/16	1 15/16	5/8	13/16	75
5/8	4 1/2	3 1/4	1 3/4	2 13/32	3/4	1 1/16	130
3/4	6 1/2	4 3/4	2	2 27/32	7/8	1 1/4	225
7/8	8 1/2	6 1/2	2 5/16	3 5/16	1	1 7/16	350
1	10	8 1/2	2 9/16	3 3/4	1 1/8	1 11/16	500
1 1/8	12	9 1/2	2 15/16	4 1/4	1 1/4	1 13/16	700
1 1/4	14	12	3 1/4	4 11/16	1 3/8	2 1/32	950
1 3/8	17	13 1/2	3 1/2	5 1/4	1 1/2	2 1/4	1250
1 1/2	20	17	3 3/4	5 3/4	1 5/8	2 3/8	1720
1 5/8	24	24	4 3/8	6 1/4	1 3/4	2 5/8	2350
1 3/4	30	25	5	7	2	2 7/8	2770
2	35	35	5 3/4	7 3/4	2 1/4	3 1/4	3900

### ⚠ WARNING

Do not exceed rated capacities. Sling capacity decreases as the angle from horizontal decreases. Slings should not be used at angles of less than 30°. Refer to Effect of Angle chart page 12. Rated Capacity Design Factor 5:1.

## SLING ATTACHMENTS, HOOKS, ETC.

### Rigging Eye Hooks

- Drop forged alloy steel
- Lightweight hooks for heavy duty lifting

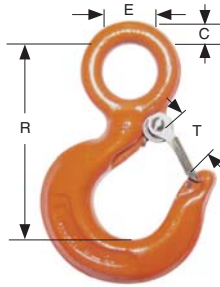

### Latchlok Eye Hooks

- Heavy duty latch with lock prevents accidental opening
- Drop forged alloy steel

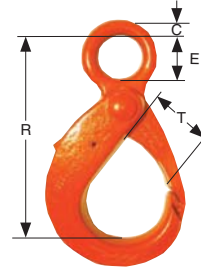

	Rated Capacity		Dimension (in.)				Weight Each (lbs.)
	Tons	Lbs.	C	E	R	T	
Alloy	1	2,000	3/8	3/4	3 1/8	15/16	.63
	1 1/2	3,000	7/16	7/8	3 21/32	31/32	.85
	2	4,000	1/2	1 1/8	4 3/32	1 1/16	1.4
	3	6,000	5/8	1 1/4	4 21/32	1 3/16	1.9
	4 1/2	9,000	3/4	1 9/16	5 25/32	1 1/2	3.7
	7	14,000	15/16	2	7 5/16	1 25/32	7.3
	11	22,000	1 1/8	2 7/16	9 1/32	2 3/8	15
	15	30,000	1 1/4	2 27/32	10 7/32	2 1/2	22
Carbon	20	40,000	1 3/4	3 1/2	14 1/16	4	60
	30	60,000	2 3/16	4 15/16	20 1/8	4 3/4	148
	40	80,000	2 17/32	5	23 23/32	5 3/4	227

Rated Capacity		Dimensions (in.)				Weight Each (lbs.)
Tons	Lbs.	C	E	R	T	
1.7	3,400	7/16	1 3/32	5 3/8	1 5/8	2.1
3.5	7,000	19/32	1 3/8	6 21/32	1 9/32	3.9
6.0	12,000	25/32	1 9/16	8 25/32	2 29/32	8.8
9.0	18,000	1 1/32	2	10 11/32	3 3/16	14

### Swivel Latchlok Hooks With Bushings

- Hook swivels beneath the eye
- Heavy duty latch with lock prevents accidental opening
- Drop forged alloy steel

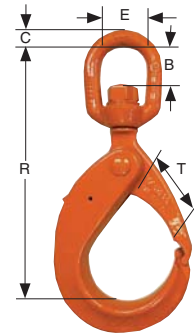

Carbon hooks available.



Stainless steel latch available.

### Swivel Rigging Eye Hooks

- Hook swivels beneath eye
- Drop forged alloy steel

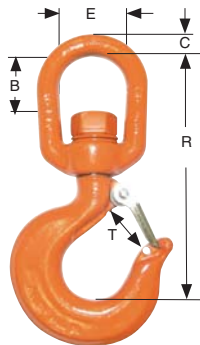

Rated Capacity		Dimensions (in.)					Weight Each (lbs.)
Tons	Lbs.	B	C	E	R	T	
1.7	3,400	1 11/32	5/8	1 1/2	7 5/32	1 5/8	3.5
3.5	7,000	1 5/8	3/4	1 3/4	8 23/32	2 1/4	4.8
6.0	12,000	1 3/4	15/16	2	11 3/16	2 29/32	10.6
9.0	18,000	2 3/8	1	2 3/4	13 13/32	3 3/16	17.0

### Sorting Hooks

- Drop forged alloy steel, for maximum strength and toughness.

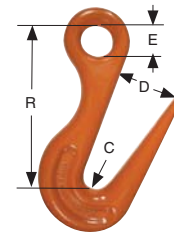

Rated Capacity		Dimensions (in.)					Weight Each (lbs.)
Tons	Lbs.	B	C	E	R	T	
1	2,000	1 1/8	3/8	1 1/4	4 5/8	15/16	1.1
1 1/2	3,000	1 3/8	1/2	1 1/2	5 7/16	31/32	1.6
2	4,000	1 21/32	5/8	1 3/4	6 1/4	1 1/16	2.5
3	6,000	1 21/32	11/16	1 3/4	6 1/2	1 5/32	3.2
5	10,000	1 25/32	3/4	2	7 17/32	1 13/32	5.4
7	14,000	2 3/8	1	2 3/4	9 21/32	1 11/16	10.6

Dimensions (in.)				Weight (lbs.)
C (Rad.)	D	E	R	
5/8	2 13/16	1 7/16	7 11/32	6.8

Working load limit at tip - 2 ton.  
Working load limit at bottom - 7 1/2 ton.

### ⚠ WARNING

Do not exceed rated capacities. Sling capacity decreases as the angle from horizontal decreases. Slings should not be used at angles of less than 30°. Refer to Effect of Angle chart page 12. Rated Capacity Design Factor 5:1.

# Wire Rope & Slings

## INSPECTION CRITERIA FOR WIRE ROPE SLINGS

### CAUTION

Do not inspect a sling by passing bare hands over the wire rope.

Remove slings from service when:

- Capacity information is missing or illegible;
- End attachments, including hooks, are cracked, deformed or obviously worn;
- Hook throat opening is increased more than 15%;
- Hook is twisted out of plane by more than 10%.

#### THE DAMAGE: Broken Wires

WHAT TO LOOK FOR: The individual wires that make up the strands in a wire rope can break for various reasons including fatigue and overload. Wire rope slings must be taken out of service when you find 10 or more broken wires in one rope lay or 5 or more broken wires in one strand of one rope lay.

TO PREVENT: Avoid pulling rope across edges or protrusions.



#### THE DAMAGE: Wear

WHAT TO LOOK FOR: Flat areas on the individual wires. When wires have lost one third or more of their original diameter, the sling must be taken out of service.

TO PREVENT: Do not drag sling on the ground and do not drag loads over slings. Pad high wear areas.

#### THE DAMAGE: Corrosion / Heat Damage

WHAT TO LOOK FOR: Absence of lubrication and discoloration of rope.

TO PREVENT: Hang slings for storage away from moisture. Do not use wire core slings above 400° F or fiber core slings above 180° F.

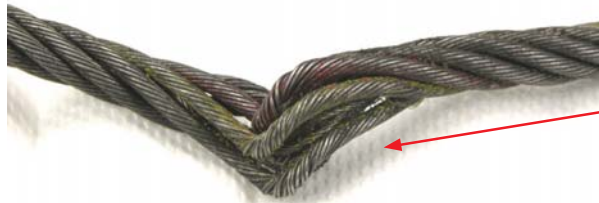

#### THE DAMAGE: Kinking, Bird Caging

WHAT TO LOOK FOR: Bent strands of wire or strands standing out from their regular position in the body of the sling.

TO PREVENT: Protect rope from sharp edges of load by pads or other means. Do not shock load slings.

#### THE DAMAGE: Crushing

WHAT TO LOOK FOR: A section of rope that is flattened, where the cross section is no longer round.

TO PREVENT: Never allow loads to be set on top of slings.



Note: OSHA now requires wire rope slings to have "permanently affixed and legible identification markings"

For inspection frequency, refer to page 7.







## SLING WEIGHTS (Approx.)



To estimate sling weights, multiply length x Per Foot Weight and add Zero Base Weight plus any additional fittings' weights.



Wire Rope

 Rope Dia. (in.)	*Zero Base Weight (lbs.)	 Per Foot Weight (lbs.)	 Thimbled Eye Wt. Ea. (lbs.)	 Alloy Eye Hook Wt. Ea. (lbs.)	 Crescent Thimble Wt. Ea. (lbs.)	 Slip Thru Thimble Wt. Ea. (lbs.)	 Sliding Choker Hook Wt. Ea. (lbs.)
1/4	.31	.12	.08	.63	.50	1.3	1.3
5/16	.47	.18	.14	.63	.50	1.3	1.3
3/8	.73	.26	.22	.85	.50	1.3	1.3
7/16	1.3	.35	.36	1.4	.50	1.5	1.9
1/2	1.7	.46	.51	1.9	.75	1.5	1.9
9/16	3.1	.59	.51	3.7	.75	1.5	1.9
5/8	3.5	.72	.75	3.7	1.2	3.4	4.0
3/4	5.7	1.0	1.5	7.3	2.0	3.4	4.5
7/8	8.9	1.4	1.9	15	3.3	5.6	10
1	13	1.9	3.0	15	3.8	5.6	10
1 1/8	18	2.3	4.0	22	5.0	8.6	26
1 1/4	25	2.9	8.2	22	6.8	8.6	26
1 3/8	32	3.5	12	38	8.0	10	50
1 1/2	41	4.2	12	38	8.0	10	50
1 3/4	65	5.7	18	60	17	18	
2	99	7.4	25	105	22	53	
2 1/4	169	9.4	40	148	39	70	
2 1/2	278	12	-	-	39	126	

\* Zero Base Weight accounts for the additional rope and sleeves required to form two standard eyes.



## SLING WEIGHTS (Approx.)

To estimate sling weights, multiply length x Per Foot Weight and add Zero Base Weight.

2-Leg Bridle

3-Leg Bridle

4-Leg Bridle

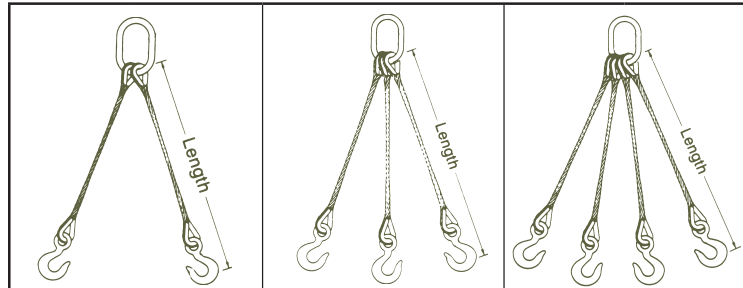

Rope Dia. (in.)	*Zero Base Weight (lbs.)	Per Foot Weight (2 Legs)	*Zero Base Weight (lbs.)	Per Foot Weight (lbs.) (3 Legs)	*Zero Base Weight (lbs.)	Per Foot Weight (lbs.) (4 Legs)
1/4	2.8	.23	2.8	.35	4.7	.46
5/16	3.2	.36	5.7	.54	6.9	.72
3/8	5.8	.52	7.5	.78	12	1.0
7/16	8.1	.70	14	1.0	17	1.4
1/2	10	.92	17	1.4	26	1.8
9/16	20	1.2	27	1.8	39	2.4
5/8	21	1.4	34	2.2	42	2.9
3/4	38	2.1	60	3.1	85	4.2
7/8	58	2.8	89	4.3	121	5.7
1	76	3.7	114	5.6	171	7.4
1 1/8	108	4.7	163	7.0	250	9.4
1 1/4	131	5.8	210	8.7	296	12
1 3/8	197	7.0	320	11		
1 1/2	230	8.3	350	13		
1 3/4	380	11				
2	550	15				

\* Zero Base Weight includes Oblong Link, Thimbled Eyes and Sling Hooks

### Acknowledgement

Lift-All wire rope slings and rated capacities comply with all OSHA, ASME B30.9, and Wire Rope Technical Board publications. Portions of this section of the catalog were taken from the Wire Rope Sling User's Manual with the permission of the Wire Rope Technical Board and the American Iron and Steel Institute.

A large yellow industrial crane is positioned in a high-ceilinged factory. It is lifting a heavy, dark-colored cylindrical object using a complex rig of black cables and yellow lifting beams. The crane's hook is connected to a red and yellow device, which is attached to three thick black cables. These cables are connected to yellow lifting beams that are attached to the object. The background shows the steel structure of the factory and other yellow beams.

See our Lifting Beams, Coil Lifters, Clamps and other Lifting Devices on our web site: [www.lift-all.com](http://www.lift-all.com)



# LiftAlloy Chain Slings

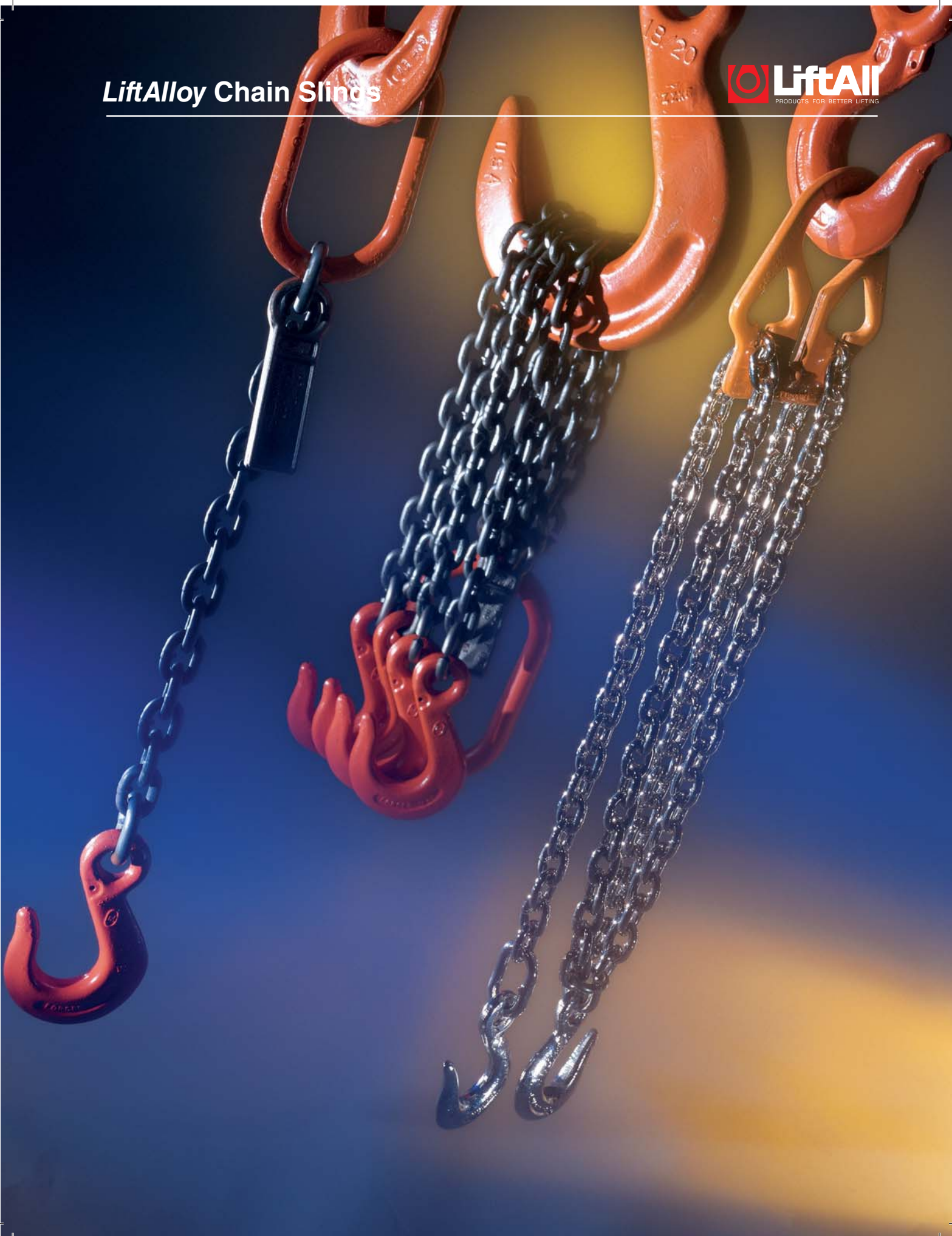

## LiftAlloy CHAIN SLING BASICS

Lift-All chain slings meet or exceed all OSHA, ASME B30.9 and NACM standards and regulations.

LiftAlloy chain slings, available in Grade 80 for 7/8"-1 1/4" and Grade 100 for 7/32"-3/4", are recommended for rugged industrial applications in harsh environments where flexibility, abrasion resistance and long life are required. OSHA required annual inspections can be performed by Lift-All trained personnel.

### Use of Chain Under Heat Conditions

When the chain itself is heated to temperatures shown below, the Working Load Limit (Rated Capacity) should be reduced as indicated.

Temperature of Chain (°F)	Reduction of Working Load Limit While at Temperature		Permanent Reduction of Working Load Limit After Exposure to Temperature	
	Grade 80	Grade 100	Grade 80	Grade 100
Below -40	Do Not Use	Do Not Use	None	None
Below -20	None	Do Not Use	None	None
400	10%	15%	None	None
500	15%	25%	None	5%
600	20%	30%	5%	15%
700	30%	40%	10%	20%
800	40%	50%	15%	25%
900	50%	60%	20%	30%
1000	60%	70%	25%	35%
Over 1000	REMOVE FROM SERVICE			

Consult Lift-All about galvanized chain

Consult Lift-All about chain to be used in pickling operations

### Features, Advantages and Benefits

#### Promotes Safety

- Permanent steel capacity tag is serialized for identification
- Welded slings offer the security of tamper proof assemblies

#### Saves Money

- Alloy Steel construction assures long life
- Can be repaired, proof tested and recertified by Lift-All

#### Saves Time

- Easy to inspect for damage
- Stores easily

LiftAlloy Chain

## HOW TO ORDER CHAIN SLINGS

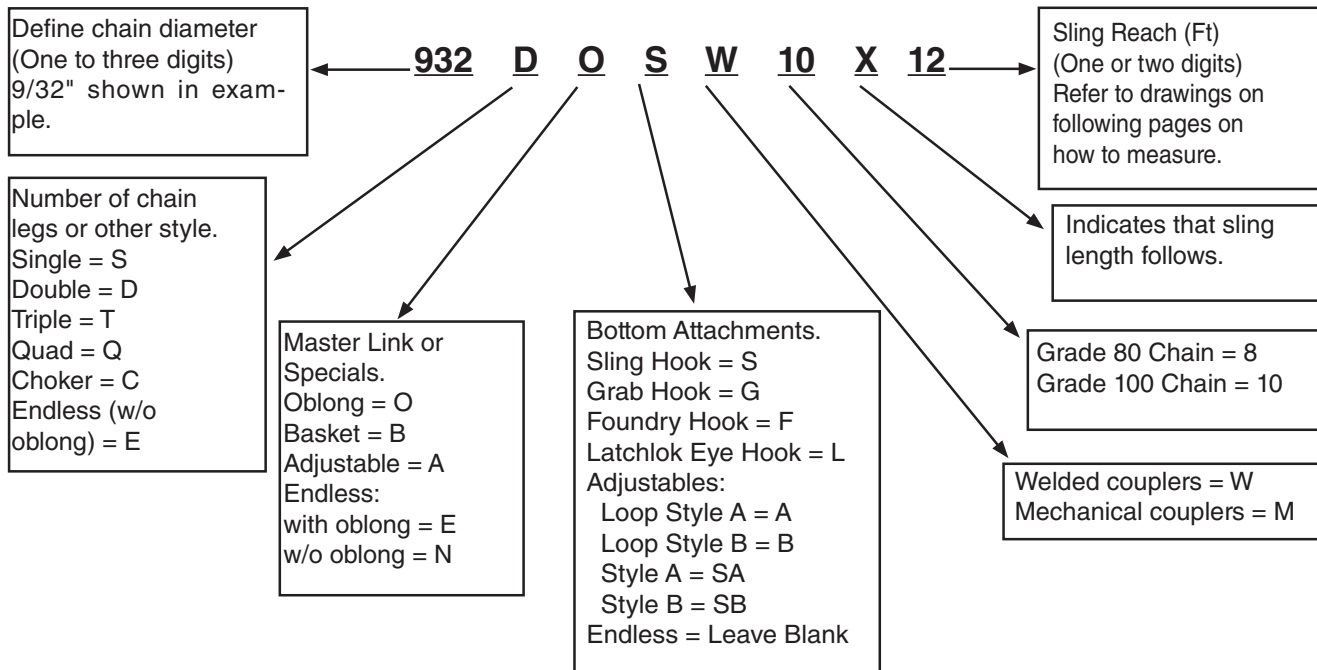

## LiftAlloy CHAIN SLING BASICS

### LiftAlloy Grade 100

- Available in sizes 7/32" - 3/4"
- Higher capacity per chain size can be used as an increased safety factor
- Higher capacity may allow use of smaller diameter chain for your lifts, reducing sling weight and cost
- Extreme abrasion resistance - more durable
- Powder coated orange attachments for corrosion resistance

### LiftAlloy Grade 80

- Available in sizes 7/8" - 1 1/4"
- Greater temperature tolerance

### All LiftAlloy Slings

- Meet or exceed all OSHA, ASTM and NACM standards
- Welded or mechanically assembled

### Chain Wear Allowance

Determine wear by measuring cross section at link ends. If worn to less than the minimum thickness allowable, chain should be removed from service.

Chain Size (in.)	Minimum Allowable Thickness - A (in.)
7/32 (.218)	.189
9/32 (.281)	.239
3/8 (.375)	.342
1/2 (.500)	.443
5/8 (.625)	.546
3/4 (.750)	.687
7/8 (.875)	.750
1 (1.00)	.887
1 1/4 (1.250)	1.091

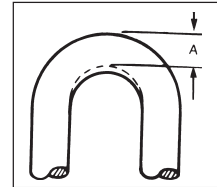

Minimum thickness based on OSHA recommendations.

### Rated Capacity For LiftAlloy Chain Slings

Size of Chain			90°	60°	45°	30°	60°	45°	30°	Nominal Dimensions (in.)		Approx. No. of Links per ft.	Approx. Weight per 100 ft. (lbs.)
			Single Chain @ 90° (lbs.)	Double Chain Slings * (lbs.)			Triple & Quad Chain Slings * (lbs.) **			Inside Length	Inside Width		
Grade	(in.)	(mm)											
100	7/32	5.5	2,700	4,700	3,800	2,700	7,000	5,700	4,000	.676	.312	17.8	44
100	9/32	7.0	4,300	7,400	6,100	4,300	11,200	9,100	6,400	0.883	.395	13.6	73
100	3/8	10.0	8,800	15,200	12,400	8,800	22,900	18,700	13,200	1.247	.574	9.6	144
100	1/2	13.0	15,000	26,000	21,200	15,000	39,000	31,800	22,500	1.559	.734	7.7	246
100	5/8	16.0	22,600	39,100	32,000	22,600	58,700	47,900	33,900	1.916	.855	6.3	370
100	3/4	20.0	35,300	61,100	49,900	35,300	91,700	74,900	53,000	2.397	1.070	5.0	580
80	7/8	22.0	34,200	59,200	48,400	34,200	88,900	72,500	51,300	2.250	1.137	5.3	776
80	1	26.0	47,700	82,600	67,400	47,700	123,900	101,200	71,500	2.664	1.348	4.5	995
80	1 1/4	32.0	72,300	125,200	102,200	72,300	187,800	153,400	108,400	3.250	1.656	3.7	1,571

\* **WARNING** Do not exceed rated capacities. Sling capacity decreases as the angle from horizontal decreases. Slings should not be used at angles of less than 30°. Refer to chain chart this page and Effect of Angle chart page 12.

\*\* A quad branch chain sling, especially when used on a load of rigid structure, is usually not sustaining the load evenly distributed on each of its four branches. The maximum working load limits are therefore set at the same values as for triple branch chain slings of equal quality and size and used with branches at same angle of inclination.

## LiftAlloy SINGLE CHAIN SLINGS

Grade	Chain Size (in.)	<sup>1</sup> Rated Capacity* (lbs.)	Approx. Weight 5 foot Reach Type SOS (lbs.)
100	7/32	2,700	4
100	9/32	4,300	5
100	3/8	8,800	10
100	1/2	15,000	18
100	5/8	22,600	27
100	3/4	35,300	44
80	7/8	34,200	58
80	1	47,700	79
80	1 1/4	72,300	121

Note: 1. Also referred to as "Working Load Limit"

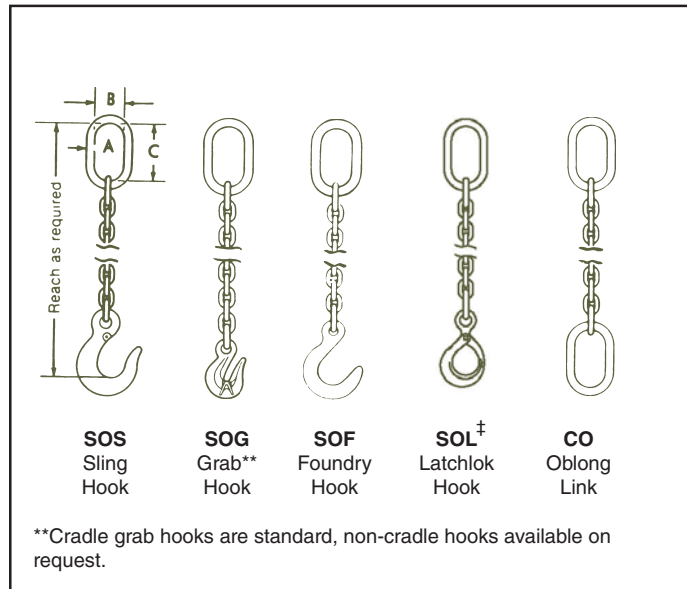

## LiftAlloy DOUBLE CHAIN SLINGS

Grade	Chain Size (in.)	<sup>1</sup> Rated Capacity* @ 60° (lbs.)	Approx. Weight 5 foot Reach Type DOS (lbs.)
100	7/32	4,700	8
100	9/32	7,400	10
100	3/8	15,200	17
100	1/2	26,000	32
100	5/8	39,100	51
100	3/4	61,100	74
80	7/8	59,200	99
80	1	82,600	134
80	1 1/4	125,200	211

Note: 1. Also referred to as "Working Load Limit"

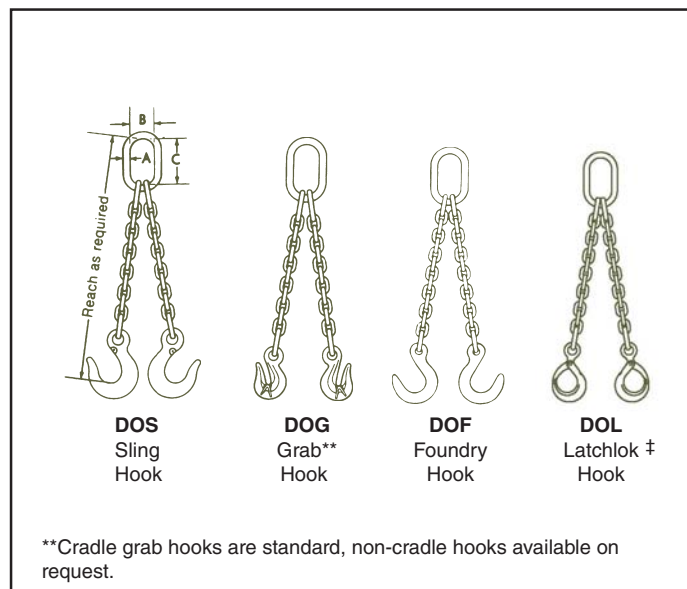

\* **WARNING** Do not exceed rated capacities. Sling capacity decreases as the angle from horizontal decreases. Slings should not be used at angles of less than 30°. Refer to chain chart page 99 and Effect of Angle chart page 12.

‡ Not available in Grade 100.

## LiftAlloy TRIPLE AND QUAD CHAIN SLINGS

Grade	Chain Size (in.)	<sup>1</sup> Rated Capacity* @ 60° (lbs.) Grade 80	Approx. Weight 5 foot Reach Type TOS (lbs.)	Approx. Weight 5 foot Reach Type QOS (lbs.)
100	7/32	7,000	12	16
100	9/32	11,200	16	19
100	3/8	22,900	28	36
100	1/2	39,000	53	63
100	5/8	58,700	81	100
100	3/4	91,700	116	140
80	7/8	88,900	154	187
80	1	123,900	209	250
80	1 1/4	187,800	358	406

Note: 1. Also referred to as "Working Load Limit"

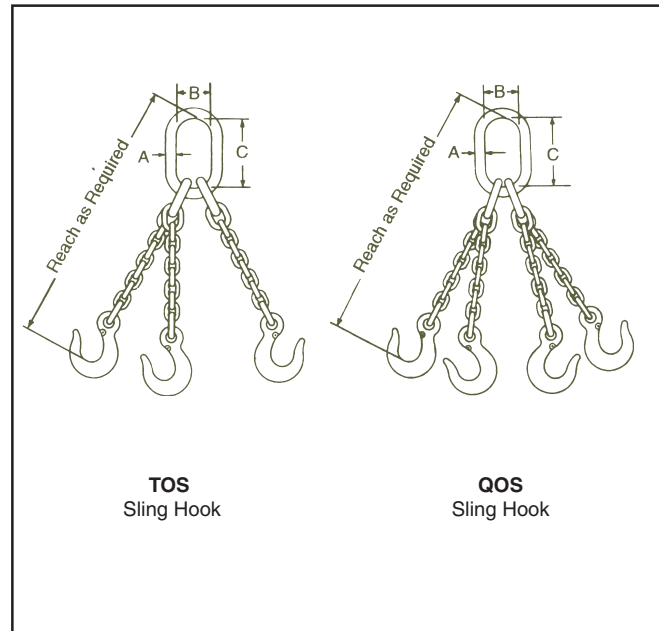

**TOS**  
Sling Hook

**QOS**  
Sling Hook

## LiftAlloy BASKET TYPE CHAIN SLINGS

Grade	Chain Size (in.)	<sup>1</sup> Rated Capacity* @ 60° (lbs.)	
		Single	Double
100	7/32	4,700	7,000
100	9/32	7,400	11,200
100	3/8	15,200	22,900
100	1/2	26,000	39,000
100	5/8	39,100	58,700
100	3/4	61,100	91,700
80	7/8	59,200	88,900
80	1	82,600	123,900
80	1 1/4	125,200	187,800

Note: 1. Also referred to as "Working Load Limit"

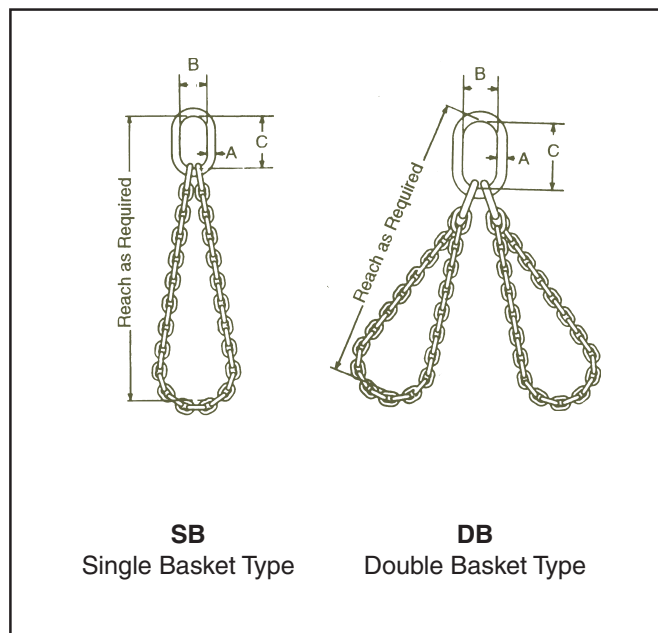

**SB**  
Single Basket Type

**DB**  
Double Basket Type

**⚠ WARNING**

Do not exceed rated capacities. Sling capacity decreases as the angle from horizontal decreases. Slings should not be used at angles of less than 30°. Refer to chain chart page 99 and Effect of Angle chart page 12.

## LiftAlloy ADJUSTABLE CHAIN SLINGS (Traditional Styles)

### LiftAlloy Adjustable Loop Chain Slings

Grade	Chain Size (in.)	'Rated Capacity* @ 60° (lbs.)	
		Single	Double
100	7/32	4,700	7,000
100	9/32	7,400	11,200
100	3/8	15,200	22,900
100	1/2	26,000	39,400
100	5/8	39,100	58,700
100	3/4	61,100	91,700
80	7/8	59,200	88,900
80	1	82,600	123,900
80	1 1/4	125,200	187,800

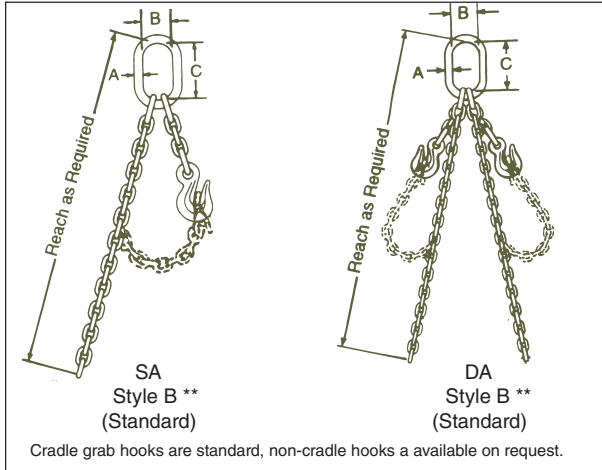

Slings shown here are the most popular of the traditional adjustable type slings. However, Lift-All's engineering staff can design whatever configuration is required to fit individual needs.

\*\* Style B, single and double adjustable slings are furnished with approximately one (1) foot of chain in short branches unless otherwise specified in the order. Style A, hook is attached to master link with a coupling link.

### LiftAlloy Adjustable Chain Slings

Grade	Chain Size (in.)	'Rated Capacity* (lbs.)	
		Single @ 90°	Double @ 60°
1000	7/32	2,700	4,700
100	9/32	4,300	7,400
100	3/8	8,800	15,200
100	1/2	15,000	26,000
100	5/8	22,600	39,100
100	3/4	35,300	61,100
80	7/8	34,200	59,200
80	1	47,700	82,600
80	1 1/4	72,300	125,200

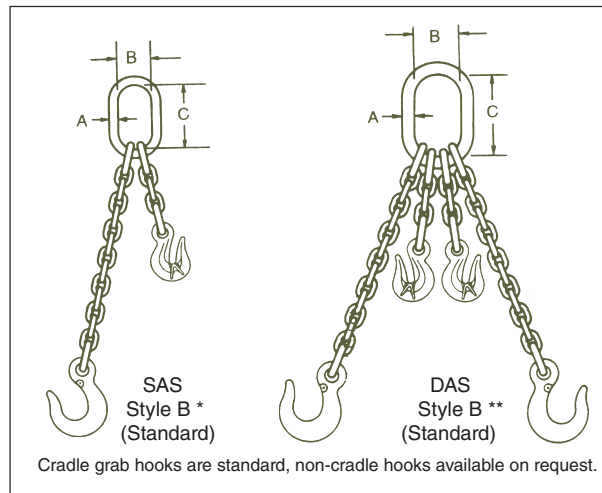

LiftAlloy Chain

## LiftAlloy ENDLESS BASKET CHAIN SLINGS

Grade	Chain Size (in.)	'Rated Capacity* (lbs.)	
		Single @ 90°	Double @ 60°
100	7/32	2,700	4,700
100	9/32	4,300	7,400
100	3/8	8,800	15,200
100	1/2	15,000	26,000
100	5/8	22,600	39,100
100	3/4	35,300	61,100
80	7/8	34,200	59,200
80	1	47,700	82,600
80	1 1/4	72,300	125,200

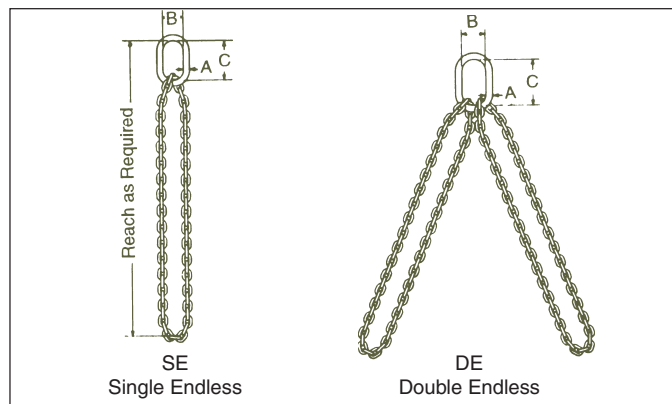

Note: 1. Also referred to as "Working Load Limit"

**⚠ WARNING**

Do not exceed rated capacities. Sling capacity decreases as the angle from horizontal decreases. Slings should not be used at angles of less than 30°. Refer to chain chart page 99 and Effect of Angle chart page 12.

## ADJUST-A-LINK GRADE 100 CHAIN SLINGS

The most easily adjustable and versatile chain sling is now stronger, too!  
Ideal for machine shop and maintenance departments varied requirements.

**New, Improved Master Control Plate \***

### Features, Advantages and Benefits

#### Promotes Safety

- Chain cannot be removed from the master control plate, assuring the capacity rating will not be compromised
- Alloy steel master control link for strength and reliability
- Each assembly serialized for traceability
- Complies with OSHA - proof tested and certified

#### Saves Money

- Grade 100 chain provides approximately 25% higher capacities than our previous *Adjust-A-Links* - replaces larger, more expensive slings
- New angled plate design reduces bending torque on chain and plate - reduces wear and extends sling life
- Wider top bearing surface reduces wear to both plate and crane hook
- Versatile - one sling does many jobs
- Using two *Adjust-A-Links* on the same crane hook eliminates the need for expensive triples and quads
- Heat treated alloy steel construction for long sling life
- Yellow powder coating on master plate and hooks prevents rust - extends sling life

#### Saves Time

- More compact plate design fits larger hooks for easier rigging
- Less bulky than typical double adjustable chain slings
- High visibility yellow fittings make assembly easy to spot
- Easily adjustable to accommodate a wide range of applications
- No time wasted searching for just the right sling



Never exceed rated capacities. Chain must be seated at the base of adjusting slot of the Master Control Link.

LiftAlloy Chain

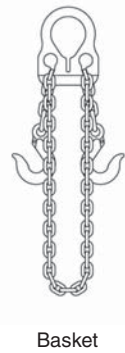
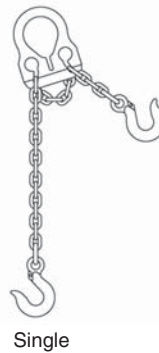
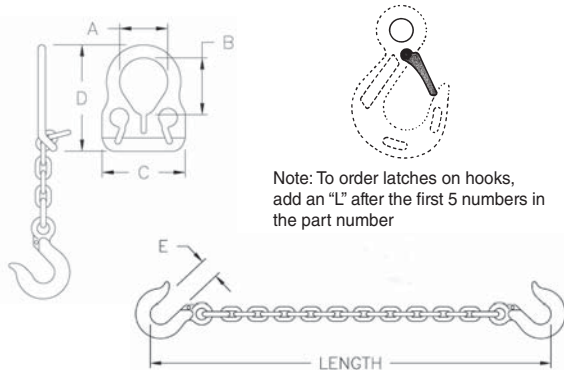

\* 1/2" size Master Link flame cut - not of new forged plate design - uses Grade 80 capacity ratings

Chain Size (in.)	'Rated Capacity * (lbs.)		Dimensions (in.)					6 ft. Length		10 ft. Length		14 ft. Length	
	Single @ 90°	Double @ 60°	Eye Width A	Eye Height B	Overall Width C	Overall Length D	Hook Opening E	Part No.	(lbs.)	Part No.	(lbs.)	Part No.	(lbs.)
7/32	2,700	4,700	2 3/16	2 11/16	3 15/16	5 1/8	15/16	30001G10	4.2	30002G10	6.2		
9/32	4,300	7,400	2 7/8	3 3/16	5 1/16	6 1/2	1 1/16	30003G10	7.5	30004G10	10.5		
3/8	8,800	15,200	3 3/4	4 1/8	6 3/4	8 11/16	1 9/16			30005G10	18.5	30006G10	24.5
1/2	12,000	20,800	4 3/8	4 3/8	9 3/4	12 3/4	2			30007	42	30008	52

\* **WARNING** Do not exceed rated capacities. Sling capacity decreases as the angle from horizontal decreases. Adjust-A-Link Slings should not be used at angles of less than 45°. Refer to chain chart page 99 and Effect of Angle chart page 12.

## HOOKS, MASTER LINKS, ETC.

### Cradle Grab Eye Hook / Code G

Grade	Chain Size (in.)	Rated Capacity* (lbs.)	Dimensions (in.)						Weight Each (lbs.)
			B	D	E	I	R	T	
100	7/32	2,700	1.19	1.75	.55	.92	2.20	.31	0.4
100	9/32	4,300	1.38	1.91	.63	1.06	2.57	.36	0.6
100	3/8	8,800	1.78	2.86	.78	1.38	3.28	.47	1.4
100	1/2	15,000	2.28	3.63	1.03	1.81	4.22	.59	3.1
100	5/8	22,600	2.75	4.08	1.25	2.25	4.78	.75	4.4
100	3/4	35,300	3.50	5.23	1.50	2.88	6.67	.88	8.8
80	7/8	34,200	3.75	5.69	1.75	3.00	6.50	1.00	10
80	1	47,700	4.31	7.00	1.88	3.88	8.09	1.19	21
80	1 1/4	72,300	5.38	8.50	2.25	2.50	10.50	1.50	40

\*\* NOT cradle type

Note: Non-Cradle Grab Hooks are available upon request.

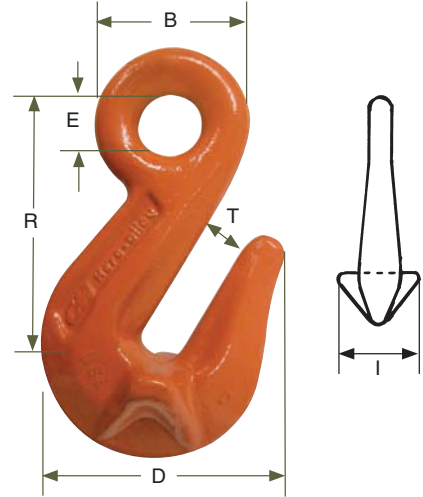

LiftAlloy Chain

### Foundry Hook / Code F

Grade	Chain Size (in.)	Rated Capacity* (lbs.)	Dimensions (in.)						Weight Each (lbs.)
			B	E	I	P	R	T	
100	9/32	4,300	1.56	.63	1.00	1.24	4.75	2.50	2.4
100	3/8	8,800	2.00	.75	1.27	1.50	5.75	3.00	4.5
100	1/2	15,000	2.50	1.00	1.50	1.75	6.88	3.50	7.1
100	5/8	22,600	3.00	1.25	1.81	2.03	8.06	4.00	12
100	3/4	35,300	3.50	1.50	2.20	2.56	9.25	4.50	20
80	7/8	34,200	4.00	1.75	2.25	2.78	10.38	5.00	26
80	1	47,700	4.50	2.13	2.59	3.03	11.56	5.50	37
80	1 1/4	72,300	5.13	2.38	3.17	3.81	12.88	6.00	58

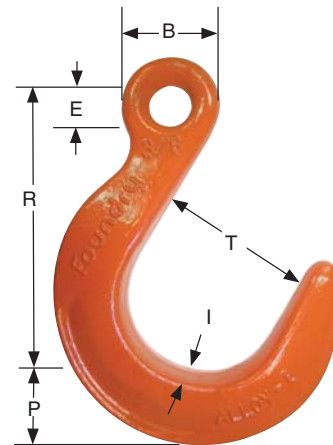

\* **WARNING**

Do not exceed rated capacities. Sling capacity decreases as the angle from horizontal decreases. Slings should not be used at angles of less than 30°. Refer to chain chart page 99 and Effect of Angle chart page 12.



## HOOKS, MASTER LINKS, ETC.

### Latchlok Eye Hooks / Code L

Grade 100

Chain Size (in.)	Rated Capacity* (lbs.)	Dimensions (in.)				Weight Each (lbs.)
		D	E	R	T	
9/32	4,300	3.77	1.09	5.37	1.64	2.1
3/8	8,800	4.74	1.36	6.65	2.27	3.9
1/2	15,000	6.26	1.55	8.77	2.91	8.8
5/8	22,600	7.37	2.00	10.35	3.20	14

Design factor @ 4:1

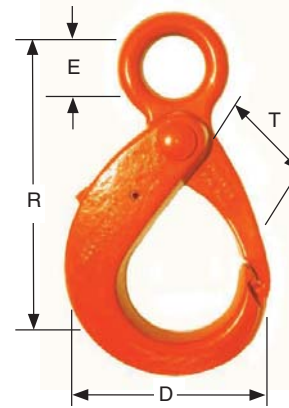

### Clevis Cradle Grab Hook / Code G

Grade 100

Chain Size (in.)	Rated Capacity* (lbs.)	Dimensions (in.)			Weight Each (lbs.)
		D	R	T	
9/32	4,300	2.18	1.86	0.38	0.6
3/8	8,800	2.71	2.47	0.47	1.3
1/2	15,000	3.65	3.04	0.60	2.1
5/8	22,600	4.5	3.75	0.77	4.2

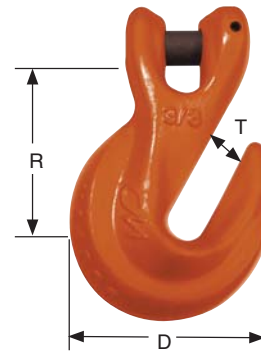

LiftAlloy Chain

### Clevis Sling Hook with Optional Latch / Code S

Grade 100

Chain Size (in.)	Rated Capacity* (lbs.)	Dimensions (in.)				Weight Each (lbs.)
		D	L	P	R	
9/32	4,300	3.53	0.83	1.11	3.75	1.2
3/8	8,800	4.54	1.06	1.51	4.58	2.2
1/2	15,000	5.48	1.38	1.61	5.59	4.2
5/8	22,600	6.20	1.69	1.92	6.44	6.6
3/4	35,300	7.06	2.09	2.08	7.50	11



## HOOKS, MASTER LINKS, ETC.

### Oblong Master Link / Code O

Link Size * (in.)			Type & Size of Chain Sling on which used				Weight Each (lbs.)
Diameter Material C	Inside Width W	Inside Length L	Single	Double	Triple	Quad	
13/32	1 1/2	3	7/32	7/32	-	-	0.3
1/2	2 1/2	5	9/32	9/32	7/32	7/32	0.9
3/4	3	6	3/8	3/8	9/32	9/32	2.5
1	4	8	1/2 or 5/8	1/2	3/8	3/8	5.8
1 1/4	4 3/8	8 3/4	3/4	5/8	1/2	1/2	9.2
1 1/2	5 1/4	10 1/2	7/8	3/4	5/8	5/8	16
1 3/4	6	12	1	7/8	3/4	3/4	25
2	7	14	1 1/4	1	7/8	7/8	37
2 1/4	8	16	-	1 1/4	1	1	54
2 3/4	9	16	-	-	1 1/4	1 1/4	85

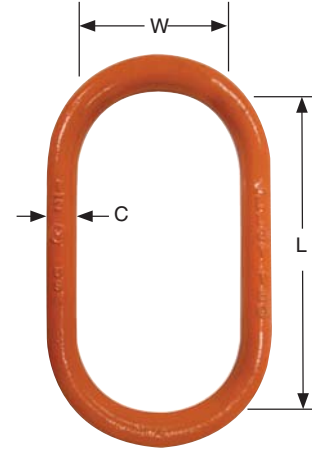

\* If sub-assemblies are used, inside dimensions may be reduced. Contact Lift-All if critical.

### Chain Sling Eye Hook with Optional Latch / Code S

Grade	Chain Size (in.)	Rated Capacity* (lbs.)	Dimensions (in.)							Weight Each (lbs.)
			D	E	I	L	P	R	T	
100	7/32	2,700	3.04	.75	.94	.83	.94	3.75	.97	0.7
100	9/32	4,300	3.50	.75	.73	1.06	1.05	3.75	1.19	1.1
100	3/8	8,800	4.33	.94	.95	1.31	1.28	4.78	1.44	1.9
100	1/2	15,000	5.50	1.13	1.17	1.63	1.66	5.69	1.78	4.5
100	5/8	22,600	6.34	1.31	1.44	1.75	2.19	6.50	2.03	7.3
100	3/4	35,300	7.83	1.50	1.69	2.19	2.51	7.81	2.50	11
80	7/8	34,200	8.59	1.69	1.94	2.38	2.84	8.75	2.78	18
80	1	47,700	9.59	1.88	2.14	2.88	3.09	9.88	3.13	23
80	1 1/4	72,300	11.56	2.31	2.62	3.41	3.89	11.50	3.88	36

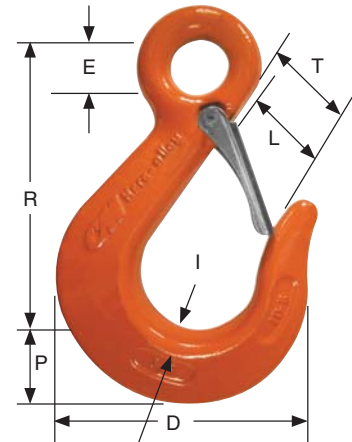

Note: When ordering, specify latch if desired.

LiftAlloy Chain

## HOOKS, MASTER LINKS, ETC.

### Mechanical Coupling Links

Grade	Chain Size (in.)	Rated Capacity* (lbs.)	Dimensions (in.)				Weight Each (lbs.)
			A	B	C	E	
100	7/32	2,700	.35	1.19	.69	.54	0.27
100	9/32	4,300	.41	1.94	.70	.59	0.27
100	3/8	8,800	.55	2.99	1.13	.93	0.87
100	1/2	15,000	.75	3.97	1.43	1.12	1.86
100	5/8	22,600	.87	4.50	1.70	1.35	3.14
100	3/4	35,200	1.07	5.36	2.09	1.54	5.80
80	7/8	34,200	1.05	5.13	1.80	1.92	6.30
80	1	47,700	1.25	6.00	2.31	2.37	8.95
80	1 1/4	72,300	1.53	6.81	2.17	2.70	16.40

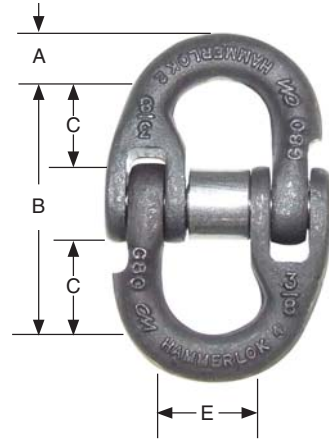

### Plate Hook

Chain Size (in.)	Rated Capacity* (lbs.)	Dimensions (in.)					Weight Each (lbs.)
		A	B	E	R	W	
9/32	4,200	2.00	1.75	1.00	3.68	2.50	2.8
3/8	7,400	2.63	3.00	1.12	6.38	2.75	5.7
1/2	13,000	3.50	4.00	1.50	7.37	3.50	13
5/8	20,400	4.38	5.00	1.88	9.25	5.00	27
3/4	30,000	5.18	6.00	2.25	10.88	5.75	42
7/8	40,000	6.00	7.00	2.63	13.68	6.00	65

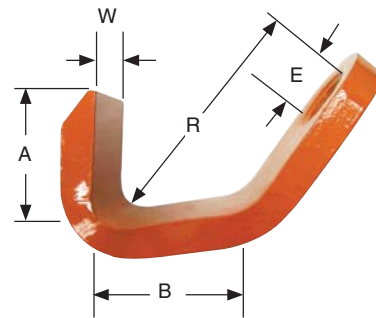

\* Ratings are per hook  
Do not use plate hooks at angles other than 60° from horizontal.  
Do not attempt to lift using only one plate hook.

### S Hook

Stock Dia. (in.)	Rated Capacity* (lbs.)	Dimensions (in.)				Weight Each (lbs.)
		A	B	F	R	
9/32	210	4 1/2	1 1/8	1 1/8	9/16	0.15
3/8	410	6	1 1/2	1 1/2	3/4	0.35
1/2	870	7 1/2	2	2	1	0.82
5/8	1,120	9	2 1/2	2 1/2	1 1/4	1.6
3/4	1,730	10 1/2	3	3	1 1/2	2.6
7/8	2,370	12	3 1/2	3 1/2	1 3/4	4.2
1	2,920	13	4	4	2	6.0
1 5/32	3,150	15	4 1/2	4 1/2	2 1/4	9.3
1 1/4	4,450	16	5	5	2 1/2	12
1 3/8	6,100	17	5 1/2	5 1/2	2 3/4	15
1 1/2	6,250	18	6	6	3	20

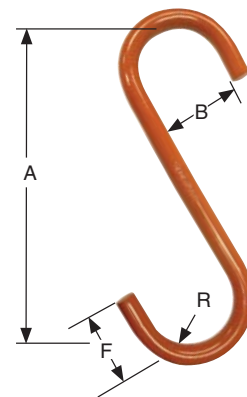

See page 136 for J-Hooks and Custom Engineered Lifting Devices.

**⚠ WARNING** Do not exceed rated capacities. Sling capacity decreases as the angle from horizontal decreases. Slings should not be used at angles of less than 30°. Refer to chain chart page 99 and Effect of Angle chart page 12.

## CHAIN



### LiftAlloy Welded Alloy Chain

- Primarily used for overhead lifting slings
- Proof tested
- Black finish on Grade 80
- Gray coating on Grade 100

### Welded Carbon Chain

- Grade 30 Proof Coil available as self colored, zinc plated or hot galvanized
- Grade 43 High Test available as bright finish, zinc plated or hot galvanized
- Grade 70 Binding (transport) is furnished with a gold finish as standard

LiftAlloy Chain

### Alloy Chain

Grade	Chain Size (in.)	Rated Capacity* (lbs.)	Weight Per CFT. (lbs.)
100	7/32	2,700	44
100	9/32	4,300	73
100	3/8	8,800	144
100	1/2	15,000	246
100	5/8	22,600	370
100	3/4	35,300	580
80	7/8	34,200	776
80	1	47,700	995
80	1 1/4	72,300	1571

### Carbon Chain

Chain Size (in.)	Grade 30		Grade 43		Grade 70	
	Rated Capacity* (lbs.)	Weight Per CFT. (lbs.)	Rated Capacity* (lbs.)	Weight Per CFT. (lbs.)	Rated Capacity* (lbs.)	Weight Per CFT. (lbs.)
3/16	800	38	-	-	-	-
1/4	1,300	66	2,600	71	3,150	74
5/16	1,900	98	3,900	98	4,700	100
3/8	2,650	144	5,400	144	6,600	156
1/2	4,500	278	9,200	278	11,300	259
5/8	6,900	422	13,000	422	-	-
3/4	10,600	628	20,200	606	-	-

Note: Grade 30 Proof Coil, Grade 43 High Test and Grade 70 Binding (transport) tiedown chain and their fittings are not recommended for lifting or hoisting per ASME B30.9.

**⚠ WARNING**

Do not exceed rated capacities. Sling capacity decreases as the angle from horizontal decreases. Slings should not be used at angles of less than 30°. Refer to chain chart page 99 and Effect of Angle chart page 12.

## INSPECTION CRITERIA FOR CHAIN

The following photos illustrate some of the common damage that occurs, indicating that the sling must be taken out of service.

\* For inspection frequency requirements, see page 7.

**THE DAMAGE: Stretched Chain Links** - Indicates the sling has been extremely overloaded or subjected to shock loading.

**WHAT TO LOOK FOR:** Lengthening of the links and narrowing of the link width. Links that do not hinge freely with adjacent links are stretched and must be taken out of service, however, stretch **can** occur without this indicator.

**TO PREVENT:** Avoid overloading and shock loading.

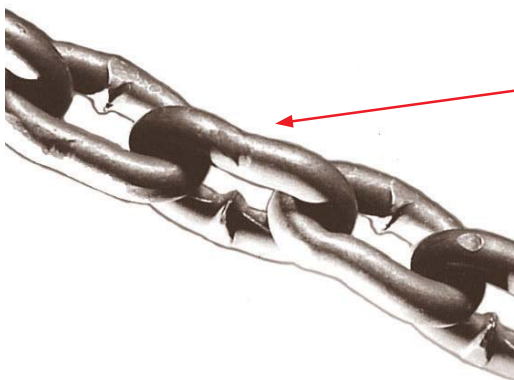

**THE DAMAGE: Bent Links**

**WHAT TO LOOK FOR:** Bending usually occurs in only one or two adjacent links. Links will have an irregular shape when compared to other links.

**TO PREVENT:** Bent links are usually the result of the chain going around the sharp edge of a load during a lift. Load edges must be padded to protect both chain and load.

**THE DAMAGE: Weld Spatter**

**WHAT TO LOOK FOR:** Metallic bumps on any link of chain.

**TO PREVENT:** The heat from weld spatter can adversely affect the strength of a chain link. Slings must be shielded from welding operations.

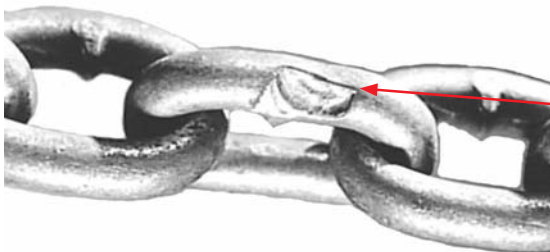

**THE DAMAGE: Gouged Links**

**WHAT TO LOOK FOR:** Indentations on an otherwise smooth link surface.

**TO PREVENT:** Gouging of links is usually caused by heavy loads being dragged over or dropped onto the chain. Protect sling from these situations.

## INSPECTION CRITERIA FOR CHAIN

### THE DAMAGE: Heat

WHAT TO LOOK FOR: Discolored areas of chain

TO PREVENT: High temperatures begin to affect alloy chain strength at 400°F. When using chain slings at elevated temperatures, refer to the Lift-All temperature chart for chain slings for working load reductions.

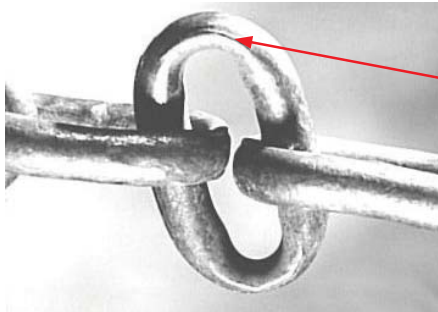
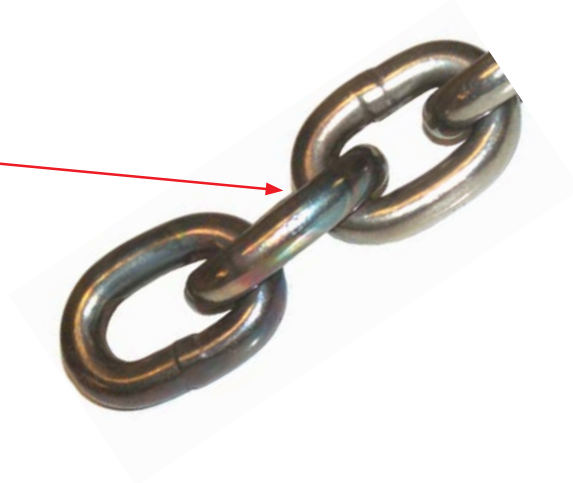

### THE DAMAGE: Worn Links

WHAT TO LOOK FOR: Excessive wear and a reduction of the material diameter, especially at the bearing points. Refer to Lift-All Wear Allowance Table for minimum allowable link thickness.

TO PREVENT: Wear is a natural result of sling use. Keeping load weights within the ratings of the slings being used will give the maximum sling wear life.

### THE DAMAGE: Bent/Worn/Cracked Hardware

WHAT TO LOOK FOR: Wear of hooks and other fittings usually occurs at the bearing points. Hooks bent more than 10° from the plane of the unbent hook. Hooks opened more than 15% of the normal throat opening.

TO PREVENT: Never point load hooks or lift with hardware on a load edge.



LiftAlloy Chain

# Roughneck Mesh Slings

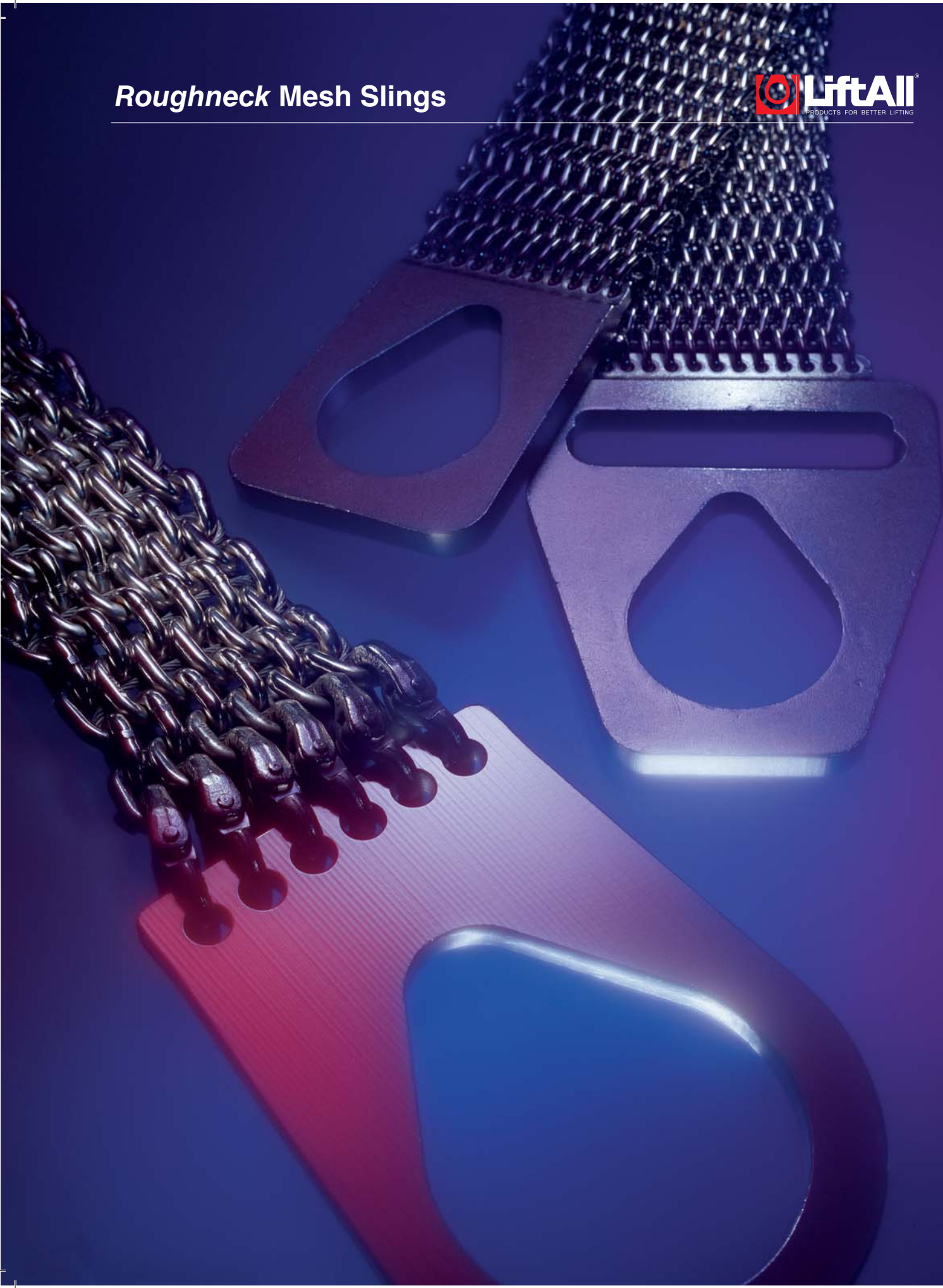

## Roughneck WIRE MESH SLINGS

### Specialty Slings with Particular Properties and Uses

Widely used in metalworking shops and steel warehouses where loads are abrasive, hot or tend to cut web

#### Features, Advantages and Benefits

- Promotes Safety
  - Steel construction resists abrasion and cutting
  - Each sling permanently stamped with capacity and serial number
  - Good flexibility - grips load's contours
  - Each sling proof tested and certified
- Saves Money
  - Grips load firmly without stretching - reduces load damage
  - Resists abrasion and cutting for greater sling life
  - Flexibility and low stretch reduce load damage
  - Wide bearing area distributes load to help avoid load damage
  - Repairable - thus very cost effective
  - Alloy steel end fittings - plated for long life
  - Wire mesh is galvanized - resists corrosion
- Saves Time
  - Width of mesh helps control and balance load
  - End fittings fit most large crane hooks

#### Roughneck Wire Mesh Sling Construction

**Standard Construction:** Alloy steel end fittings, zinc plated. Mesh is galvanized high tensile steel. 10 gage is standard, 12 gage is available upon request

**Optional Construction:** Stainless steel mesh is available for corrosive and hotter environments.

#### Inspection Criteria for Roughneck Wire Mesh Slings

Remove the sling from service if any of the following is visible: (See Page 116)

- A broken weld or brazed joint along the sling edge
- A broken wire in any part of the mesh
- Reduction in wire diameter of 25% due to abrasion or 15% due to corrosion
- Lack of flexibility due to distortion of the mesh
- Visible distortion or wear of either end fitting
- Cracked end fitting



#### Environmental Considerations

- Wire mesh slings shall not be used at temperatures above 550°F.
- Store in a clean, dry area to avoid corrosive action

Do not edge load. Full width of mesh must contact load.

#### WARNING

#### How to Order

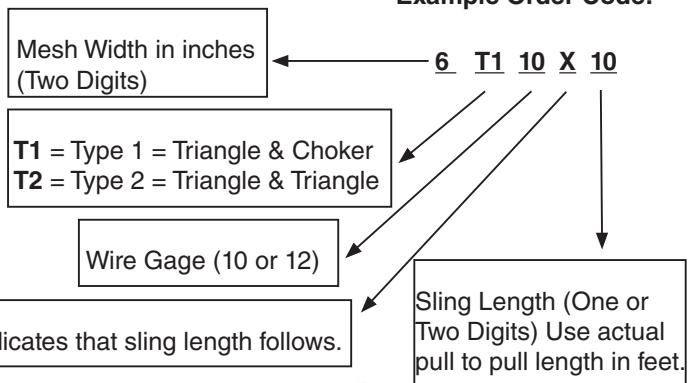

Wire Mesh Width (in.)	Rated Capacity (lbs.) *		
	Vertical	Choker	Basket
<b>10 Gage - Heavy Duty</b>			
2	2,300	2,300	4,600
3	3,500	3,500	7,000
4	4,800	4,800	9,600
6	7,200	7,200	14,400
8	9,600	9,600	19,200
10	12,000	12,000	24,000
12	14,400	14,400	28,800
14	16,800	16,800	33,600
16	19,200	19,200	38,400
18	21,600	21,600	43,200
20	24,000	24,000	48,000
<b>12 Gage - Medium Duty</b>			
2	1,600	1,600	3,200
3	2,400	2,400	4,800
4	3,200	3,200	6,400
6	4,800	4,800	9,600
8	6,400	6,400	12,800
10	8,000	8,000	16,000
12	9,600	9,600	19,200

NOTE: The choker fitting must not be positioned against a load edge or directly on the triangle fitting.

Do not exceed rated capacities. Sling capacity decreases as the angle from horizontal decreases. Slings should not be used at angles of less than 30°. Refer to Effect of Angle chart page 12.



# Roughneck Mesh Slings



## Roughneck WIRE MESH SLINGS

### Select The Proper Mesh 10 Gage - Heavy Duty

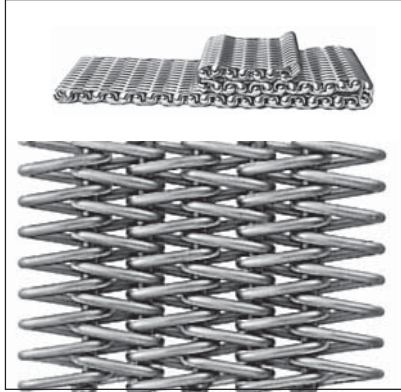

### 12 Gage - Medium Duty

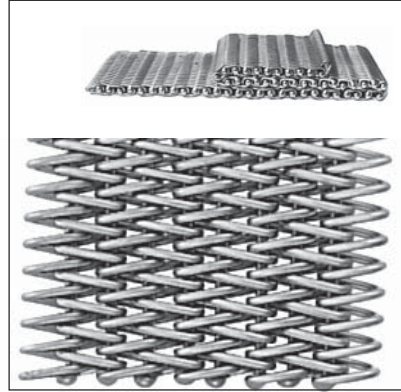

This single 4" wide mesh sling in a choker hitch at load center of gravity provides adequate stability for many structural steel loads.

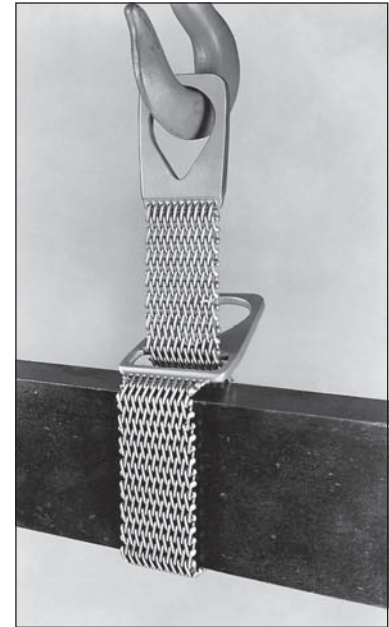

### Prompt Shipment or Repair Service by Experts

Wire mesh slings with normal usage will eventually need repair and parts replaced. This can be done for relatively small cost. *Lift-All* wire mesh slings that are repaired are guaranteed to meet or exceed original specifications. Five *Lift-All* factories are strategically located in the U. S. to insure prompt service. We repair all types and brands of mesh slings.

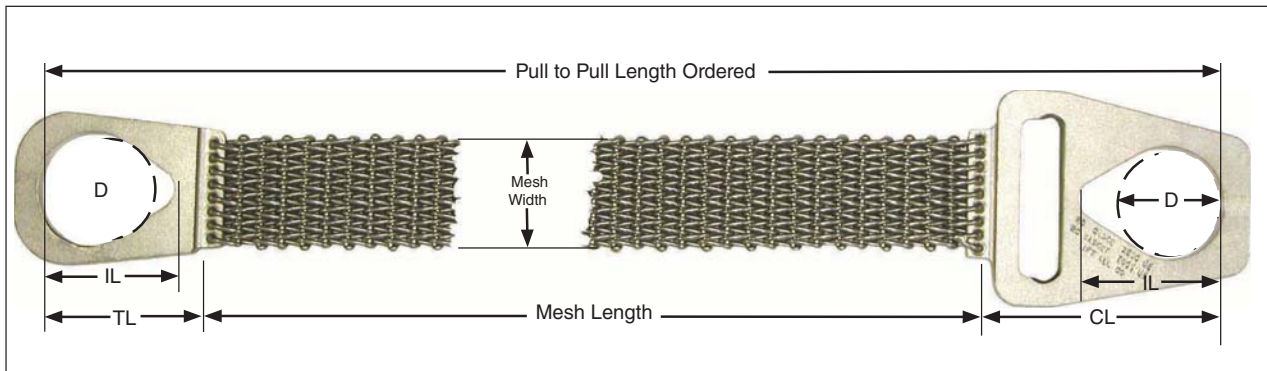

Nom. Mesh Width (in.)	Terminal Dimensions (in.)				Terminal Thickness (in.)		Approx. Weight (lbs.) of 3 ft. Type 1 Slings		Mesh Weight (Per ft. in lbs.)	
	MW	D	IL	TL	CL	10 GA	12 GA	10 GA	12 GA	10 GA
2	2	3	3 7/8	5 5/8	1/2	1/2	6	5	1.3	1.1
3	2 1/4	3 3/8	4 3/8	6 1/4	1/2	1/2	8	8	1.9	1.8
4	3	4	5	6 3/4	1/2	1/2	10	10	2.5	2.3
6	3 1/2	4 1/2	5 5/8	7 3/4	1/2	1/2	16	14	3.9	3.4
8	4 1/2	6	7 1/2	9	1/2	1/2	22	21	5.1	4.5
10	4 3/4	6 1/4	8	10 7/8	1/2	1/2	28	26	6.4	5.6
12	5	6 1/2	8 5/8	11 3/8	1/2	1/2	34	32	7.6	6.8
14	5	6 1/2	8 3/4	12 3/4	1/2	1/2	40	37	8.9	7.9
16	5 1/4	7	9 1/8	14 1/4	3/4	1/2	57	38	10	9.0
18	5 1/2	7 1/2	9 3/4	15 3/4	3/4	1/2	67	44	11	10
20	5 3/4	7 3/4	10 1/8	17	3/4	1/2	77	51	13	11

Mesh

## Roughneck CHAIN MESH SLINGS

Specialty Slings for rugged applications.

Widely used in metalworking shops, and stevedoring where abrasive conditions or hot environments damage and destroy synthetic slings.

### Features, Advantages and Benefits

Promotes Safety

- Each sling permanently stamped with capacity and serial number for traceability
- Steel construction resists abrasion and cutting
- Each sling proof tested and certified

Saves Time

- Width of mesh helps to balance and control loads
- End fittings fit most large crane hooks

Saves Money

- Alloy steel end fittings and Grade 100 Alloy chain resists abrasion and cutting for greater sling life
- Repairable - thus cost effective
- Low stretch and good flexibility reduces load damage
- Wide bearing area distributes load to help avoid load damage

### Inspection Criteria

#### for Roughneck Chain Mesh Slings

Remove sling from service if any of the following are visible:

- Wear, nicks, cracks, breaks, gouges, stretch, bends or weld spatter on chain or attachments
- Discoloration from excessive temperature
- Chain links and attachments won't hinge freely with adjacent links
- Visible distortion of either end fitting out of its plane
- Distortion or any collapse of eye width on either end fitting
- 15% reduction of original cross-sectional area of metal at any point of either end fitting
- Cracked end fitting

### How to Order

Example Order Code:

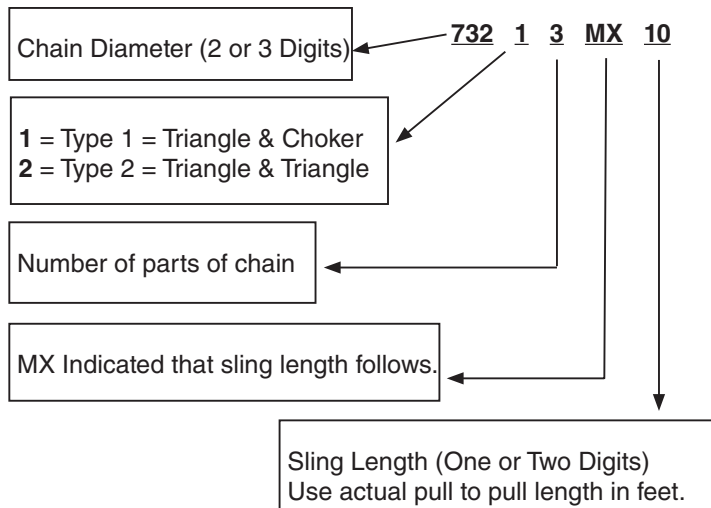

Chain Size (in.)	Parts of Chain	Sling Width (in.)	Rated Capacity (lbs.)*		
			Vertical	Choker	Basket
7/32	3	1 1/2	5,000	5,000	10,000
	4	2	6,700	6,700	13,400
	5	2 1/2	8,400	8,400	16,800
	6	3	10,000	10,000	20,000
9/32	3	2 1/8	8,400	8,400	16,800
	4	2 3/4	11,000	11,000	22,000
	5	3 3/8	14,000	14,000	28,000
	6	4	16,800	16,800	33,600
3/8	3	3 1/4	17,000	N/A	34,000
	4	4 3/8	22,700	N/A	45,400
	5	5 3/8	28,400	N/A	56,800
	6	6 1/2	34,000	N/A	68,000
1/2	2	3	19,200	N/A	38,400
	3	4 1/2	28,800	N/A	57,600
	4	6	38,400	N/A	76,800

### ⚠ WARNING

Do not exceed rated capacities. Sling capacity decreases as the angle from horizontal decreases. Slings should not be used at angles of less than 30°.

### Environmental Considerations

- Rated capacities of chain mesh are reduced at temperatures above 400°F. (See table page 98)
- Store in clean, dry area to avoid corrosive action

## Roughneck CHAIN MESH SLINGS

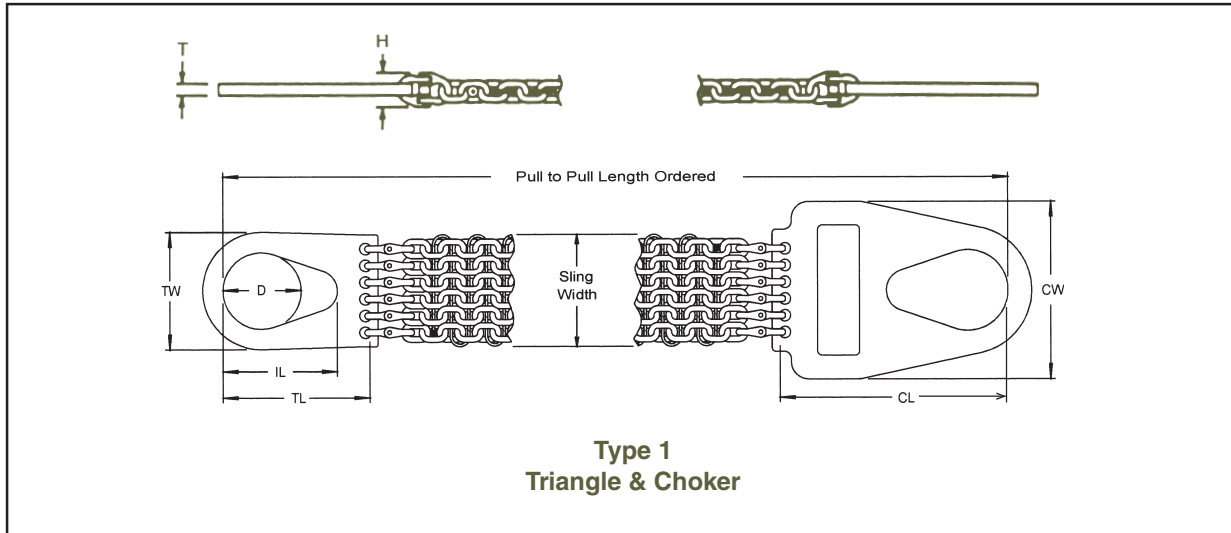

Chain Size (in.)	Parts of Chain	Sling Width (in.)	Terminal Dimensions (in.)								5 ft. Type 2 Weight (lbs.)	Weight per ft. (lbs.)
			D	IL	TL	TW	CL	CW	T	H		
7/32	3	1 1/2	2 3/4	4 1/8	6 3/4	4 3/4	9	7 1/8	3/8	1 1/4	10	1.3
	4	2	3	4 1/2	7 1/8	5	9 3/8	7 1/4	3/8	1 1/4	12	1.8
	5	2 1/2	3 1/2	5 1/4	8	5 1/2	10 1/8	7 3/4	3/8	1 1/4	14	2.2
	6	3	3 3/4	5 5/8	8 1/4	5 3/4	10 5/8	8 1/4	3/8	1 1/4	17	2.7
9/32	3	2 1/8	2 3/4	4 1/8	6 3/4	4 3/4	9	7 1/8	1/2	1 3/4	14	2.2
	4	2 3/4	3	4 1/2	7 1/8	5	9 3/8	7 1/4	1/2	1 3/4	18	3.0
	5	3 3/8	3 1/2	5 1/4	8	5 1/2	10 1/8	7 3/4	1/2	1 3/4	22	3.7
	6	4	3 3/4	5 5/8	8 1/4	5 3/4	10 5/8	8 1/4	1/2	1 3/4	26	4.5
3/8	3	3 1/4	3 1/2	5 1/4	6 7/8	5			3/4	2 1/4	30	4.4
	4	4 3/8	4 3/8	6 1/2	8 1/8	6 3/8			3/4	2 1/4	41	5.8
	5	5 3/8	4 3/8	6 1/2	8 3/8	7 3/8			3/4	2 1/4	55	7.3
	6	6 1/2	5 1/4	7 7/8	9 3/4	8 1/4			3/4	2 1/4	59	8.8
1/2	2	3	3 1/2	5 1/4	6 7/8	5			1	3 1/8	33	5.2
	3	4 1/2	4 3/8	6 1/2	8 3/8	6 3/8			1	3 1/8	50	7.7
	4	6	5 1/4	7 7/8	9 3/4	7 3/4			1	3 1/8	62	10

Note: Length tolerance  $\pm 2$  chain links so plane is maintained.

Mesh

## INSPECTION CRITERIA FOR WIRE MESH SLINGS

The following photos illustrate some of the common damage that occurs, indicating that the sling must be taken out of service.

For inspection frequency requirements, see page 7.

### THE DAMAGE: **Overloading / Uneven Loading**

**WHAT TO LOOK FOR:** Mesh does not lie flat, appears distorted and/or will not bend easily.

**TO PREVENT:** Do not load in excess of rated capacity. Load edges must be straight / flat and in contact with full width of mesh at bearing points.

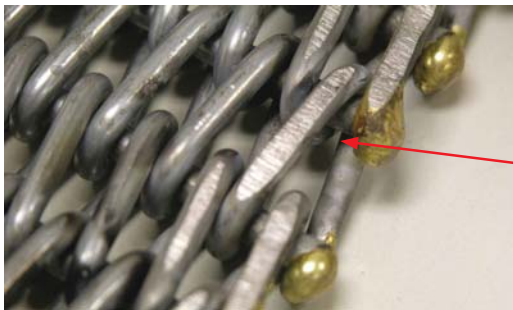

### THE DAMAGE: **Wear**

**WHAT TO LOOK FOR:** Flat areas on the individual wires. When wires have lost 25% or more of their original diameter, the sling must be taken out of service.

**TO PREVENT:** Do not drag sling on the ground and do not drag loads over slings. Pad high wear areas.

### THE DAMAGE: **Corrosion / Heat Damage**

**WHAT TO LOOK FOR:** Areas of discoloration. Remove slings with wire diameter reduction of 15% or more. Slings exposed to temperatures of 550° F or more must be removed from service.

**TO PREVENT:** Hang slings for storage away from moisture. Do not use mesh slings above 550° F. Consider using stainless steel mesh.



Mesh



### THE DAMAGE: **Broken Weld or Brazed Joint**

**WHAT TO LOOK FOR:** A cracked or separation of the wire at the edge or in the body of the mesh.

**TO PREVENT:** Do not side load mesh. Tension on sling must be distributed evenly across the entire width of the mesh.

### THE DAMAGE: **Distortion or Wear of End Fittings**

**WHAT TO LOOK FOR:** Fittings that do not lie flat or have obvious areas of wear.

**TO PREVENT:** Never lift with fitting against a load edge or set load directly onto sling. Reduce wear by keeping loads within the rated capacity of the sling.



# LOAD HUGGER® CARGO CONTROL

 **LiftAll**<sup>®</sup>  
PRODUCTS FOR BETTER LIFTING



## Load Hugger BASICS

Lift-All Load Hugger cargo control and load securement products are of the highest quality. They offer the van and flatbed operator a wide variety of options to meet Department of Transportation and CVSA requirements.\*

### Features, Advantages and Benefits

#### Promotes Safety

- Flexible, conforms to and controls the load
- Ratchet assembly allows easy adjustment
- All hooks and chain assemblies equal or exceed strength of webbing
- Meet all DOT (Department of Transportation) and CVSA (Commercial Vehicle Safety Alliance) regulations.

#### Saves Money

- Soft and wide - does not damage costly cargo
- Large selection - choose the capacity that's right for the load carried

#### Saves Time

- Light weight, easy to handle
- Large selection of end fastenings, winches and ratchets make choosing and using the correct assembly easy

### Inspection Criteria

Remove from service if any of the following are visible:

- Cuts, holes, surface abrasion or crushed areas
- Burns or chemical damage
- Separation of load carrying stitch pattern
- Hardware, fittings or tensioning devices which are broken, bent, twisted, cracked, or have nicks and gouges
- Knotted webbing
- Splices or other makeshift repairs
- Damaged loop ends

See illustrations of damaged webbing on page 40 & 41; damaged chain and hooks on page 109 and 110.

### Definitions

**Working Load Limit:** The maximum load that may routinely be applied to an assembly or component in straight tension.

**Ultimate Strength:** The load at which an assembly or component will fail in testing.

Department of Transportation Regulations 393, 102(b) use Ultimate Breaking Strength to calculate the number of tiedown assemblies required to secure a load.

Lift-All publishes Ultimate Strength for this purpose only. For safety, we recommend that only Working Load Limits be used for your calculations.

### Environmental Considerations

- Nylon and polyester are seriously degraded at temperatures above 200° F.
- Prolonged exposure to Ultraviolet light adversely affects nylon and polyester. Tie down straps become bleached and stiff when exposed to sunlight or arc welding.
- Many acids, alkalis and chemicals have an adverse effect on nylon and polyester. See chart on page 24.

### Safe Operating Practices

- Inspect tie down straps and all hardware when load is first being secured.
- Re-tighten tie downs periodically during run.
- Never use *Load Huggers* for anything other than securing cargo. Do not use for lifting loads or towing vehicles.
- Load should be securely blocked and stabilized before tensioning the straps.
- Never exceed rated capacities.
- Use caution when tossing straps and chain anchor assemblies over a load.
- Check installation of portable winches - ratchet pawl must be at top of toothed wheel and bolts tight against the rub rail.
- Weld-on winches should not be cracked.
- Corner protectors and wear pads must be used to protect *Load Huggers* from edges and abrasion.
- All hardware must be in line with direction of pull to achieve full strength.

\* CVSA - Commercial Vehicle Safety Alliance  
Phone: 202-775-1623 Fax: 202-775-1624  
www.cvsa.org

## WEB SELECTION

Two **styles** of webbing are available for our 2"-4" ratchet assemblies and winch straps:  
**Standard yellow** and **Hi-Vis Tuff-Edge**.

Two **strength classes** are available for 2" assemblies: **Single Stripe** and **Double Stripe**.

### Standard Polyester Tiedown Webbing

This webbing offers exceptional value for everyday use.

### Hi-Vis Tuff-Edge Polyester Tiedown Webbing

The brightness of our new **Hi-Vis Tuff-Edge** tiedowns makes them more visible, easier to locate and harder to lose.

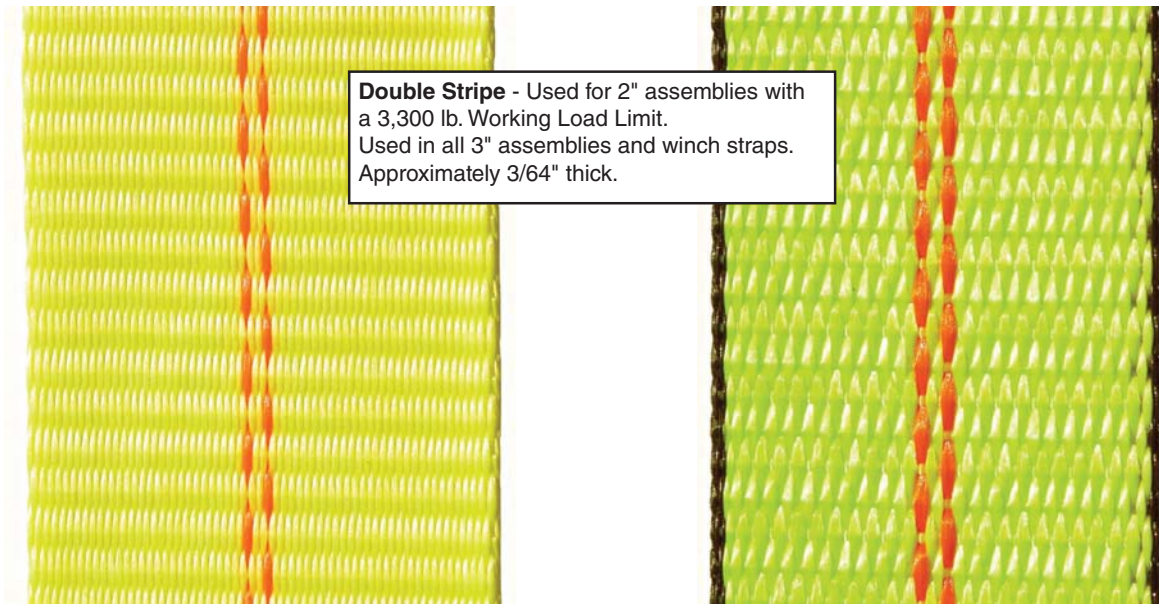
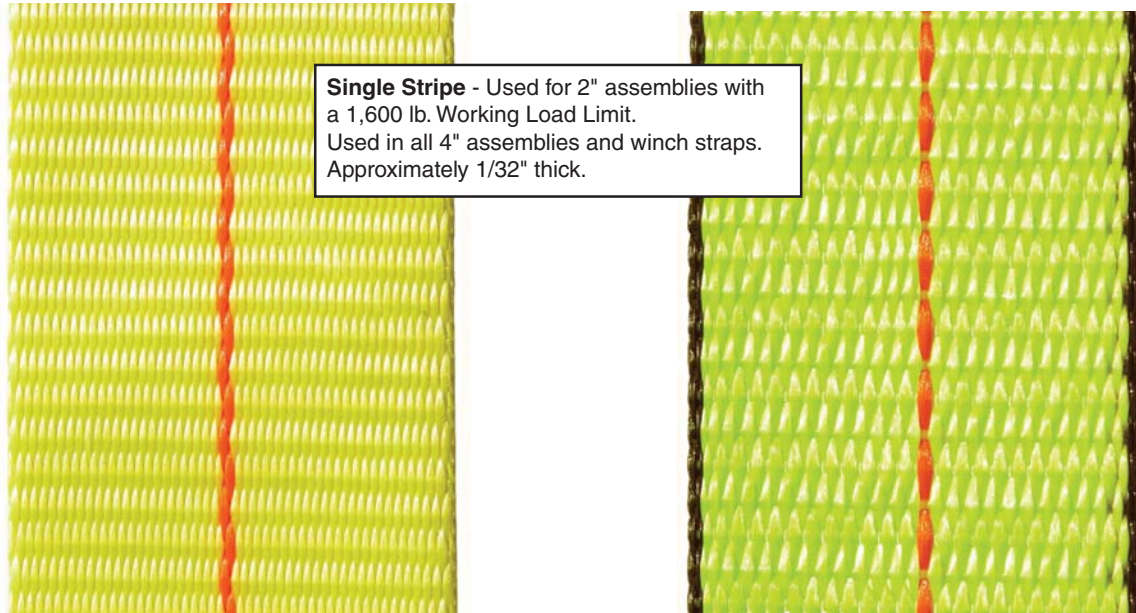

## RATCHET ASSEMBLIES

**Type A Assemblies** One piece (endless) assembly for use without end fittings. Length measured from ratchet mandrel to end of webbing.



**Type B Assemblies** Two piece assemblies with one fixed length of webbing and one adjustable length of webbing. Numerous end fittings are available to handle any requirements. (See following pages)

**Series 1,000**

- 1" wide polyester webbing
- Ultimate strength - 2,100 lbs. \*
- Working Load Limit - 700 lbs. \*



**Series 5,000**

- 2" wide polyester webbing
- Ultimate strength - 5,000 lbs.
- Working Load Limit - 1,600 lbs.

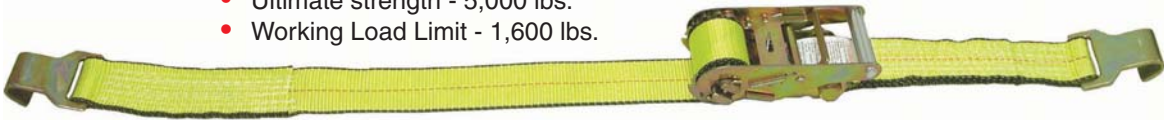

**Series 10,000**

- 2" wide polyester webbing
- Ultimate strength - 10,000 lbs.
- Working Load Limit - 3,300 lbs.

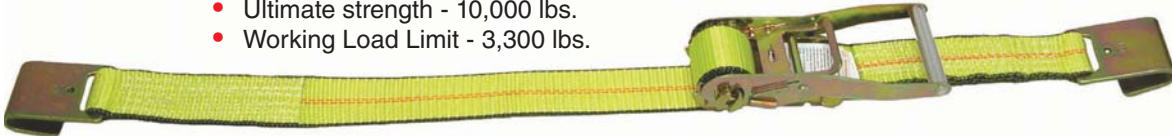

**Series 15,000**

- 3" or 4" wide polyester webbing
- Ultimate strength - 15,000 lbs.
- Working Load Limit - 5,000 lbs.



**Type B Measurement**

Fixed end is approximately 16" long for 2" assemblies and 18" long for 1", 3" and 4" assemblies. Chain Anchor adds another 14" to fixed end length.

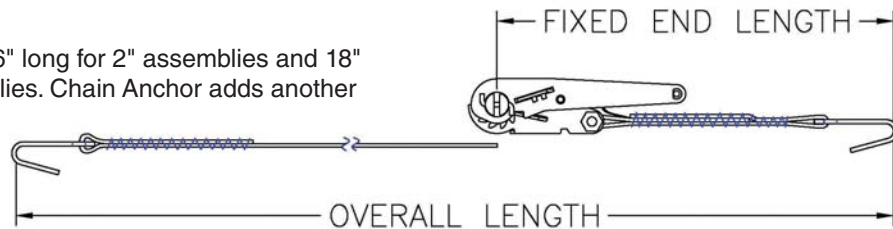

\* When using flat hooks in Series 1,000, ultimate strength is 1,000 lbs., working load limit is 330 lbs.



## 1" TIEDOWN ASSEMBLIES

Webbing Ultimate Strength * (lbs.) Working Load Limit (lbs.)	Series 1,000			
	1" Wide Polyester 2,100 with Ratchet** / 1,000 with Cam 700 with Ratchet** / 330 with Cam			
	Buckle	Part No. 10 Ft. Lgth.	Part No. 15 Ft. Lgth.	Weight (lbs.)
<b>Flat Hook **</b> 	Ratchet	60102	6A102	1.1
	Cam	60110	6A110	.7
<b>Stamped Snap Hook</b> 	Ratchet	60104	6A104	1.5
	Cam	60113	6A113	1.0
<b>U-Hook</b> 	Ratchet	60101	6A101	1.1
	Cam	60109	6A109	.7
<b>Hook &amp; Keeper</b> 	Ratchet	60105	6A105	1.5
	Cam	60114	6A114	1.1
<b>Open Hook (PE Coated or Zinc Plated)</b>  (PE Coated Hook shown)	Ratchet PE Hook	60103	6A103	1.7
	Ratchet ZP Hook	60106	6A106	1.6
	Cam PE Hook	60111	6A111	1.3
	Cam ZP Hook	60112	6A112	1.2
<b>Type A (Endless)</b>  (Series 1,000 Cam Buckle shown)	Ratchet	60107	6A107	.9
	Cam	60108	6A108	.5

Note: Because end terminations vary proportionally with size, check with Lift-All if critical dimensions are required. Non-standard lengths available upon request.





\* Ultimate strength of assembly when new.

\*\* Exception: When used with Flat Hooks, 1" Ratchet Assembly rating is 1,000 lbs. ULTIMATE STRENGTH and 330 lbs. WORKING LOAD LIMIT.



Our popular 1" Ratchet Tiedown with PE coated Open Hooks is available in 15 foot lengths in a 16 piece display box (Part No. 6A103B)

## RATCHET ASSEMBLIES

Webbing Ultimate Strength * Working Load Limit	Length	Series 5,000			Series 10,000		
		2" Wide Polyester 5,000 lbs. 1,600 lbs.			2" Wide Polyester 10,000 lbs. 3,300 lbs.		
		Standard Part No.	Tuff-Edge Part No.	Weight (lbs.)	Standard Part No.	Tuff-Edge Part No.	Weight (lbs.)
<b>Flat Hook</b>  (Series 10,000 shown)	27'	60501	TE60501	4.6	61001	TE61001	5.8
	30'	60502	TE60502	4.8	61002	TE61002	6.0
<b>Stamped Triangle</b>  (Series 5,000 shown)	27'	60503	TE60503	4.2	61003	TE61003	5.2
	30'	60504	TE60504	4.4	61004	TE61004	5.4
<b>Stamped Snap Hook</b>  (Series 10,000 shown)	27'	60505	TE60505	4.6	61005	TE61005	6.2
	30'	60506	TE60506	4.8	61006	TE61006	6.4
<b>Twisted Snap Hook</b>  (Series 10,000 shown)	27'	60507	TE60507	5.2	61007	TE61007	5.6
	30'	60508	TE60508	5.4	61008	TE61008	5.8
<b>Forged Snap Hook</b>  (Series 10,000 shown)	27'	60509	TE60509	5.8	61009	TE61009	6.4
	30'	60510	TE60510	6.0	61010	TE61010	6.6
<b>D-Ring</b> 	27'	60511	TE60511	4.2			
	30'	60512	TE60512	4.4			
<b>U-Hook</b> 	27'	60513	TE60513	4.6	26422	TE26422	5.8
	30'	60514	TE60514	4.8	26423	TE26423	6.0
<b>Hook &amp; Keeper</b> 	27'	60515	TE60515	4.8			
	30'	60516	TE60516	5.0			
<b>Chain Anchor</b> 	27'				61013	TE61013	13.0
	30'				61014	TE61014	13.2
<b>Type A (Endless)</b>  (Series 5,000 Ratchet Buckle shown)	27'	60517	TE60517	3.8	61011	TE61011	4.4
	30'	60518	TE60518	4.0	61012	TE61012	4.6

Load  
Huggers







Note: Because end terminations vary proportionally with size, check with *Lift-All* if critical dimensions are required. Non-standard lengths available upon request.

\* Ultimate strength of assembly when new.

**⚠ WARNING**

Always protect tiedowns from being cut by corners and edges.

## RATCHET ASSEMBLIES

Webbing Ultimate Strength * Working Load Limit	Length	Series 15,000					
		3" Wide Polyester 15,000 lbs. 5,000 lbs.			4" Wide Polyester 15,000 lbs. 5,000 lbs.		
		Standard Part No.	Tuff-Edge Part No.	Wt. (lbs.)	Standard Part No.	Tuff-Edge Part No.	Wt. (lbs.)
<b>Flat Hook</b> 	27'	20482	TE20482	12.8	26424	TE26424	13.6
	30'	20483	TE20483	13.2	26425	TE26425	14.0
<b>Forged Triangle</b> 	27'	20484	TE20484	14.0	26430	TE26430	14.8
	30'	20485	TE20485	14.4	26431	TE26431	15.2
<b>Chain Grab Hook</b> 	27'	20486	TE20486	13.4	26426	TE26426	14.2
	30'	20487	TE20487	13.8	26427	TE26427	14.6
<b>Chain Anchor Assembly</b> 	27'	20488	TE20488	16.8	26432	TE26432	17.6
	30'	20489	TE20489	17.2	26433	TE26433	18.0
<b>U-Hook</b> 	27'	20494	TE20494	13.0	26436	TE26436	13.8
	30'	20495	TE20495	13.2	26437	TE26437	14.2
<b>7 in. Sewn Eye</b> 	27'	20490	TE20490	11.0	26428	TE26428	11.8
	30'	20491	TE20491	11.4	26429	TE26429	12.2
<b>Type A (Endless)</b> 	27'	20492	TE20492	10.6	26434	TE26434	11.4
	30'	20493	TE20493	11.0	26435	TE26435	11.8

Load Huggers

## WEAR PADS AND CORNER PROTECTORS

### Sliding Sleeve

- Double walled tubular product
- Specify length when ordering
- Protects Load Hugger webbing from abrasion and helps resist cutting

### Ratchet Protector

A sewn fabric pad used to protect surface finish of cargo and ratchet mechanism. Specify with order.

### Corner Guard - Part #CG

A movable, rust-proof copolymer corner guard. Protects Load Hugger from sharp edges. Tough enough to be used with either chain or webbing. For other wear pad options, see pages 14-17 in the Wear Pad section.

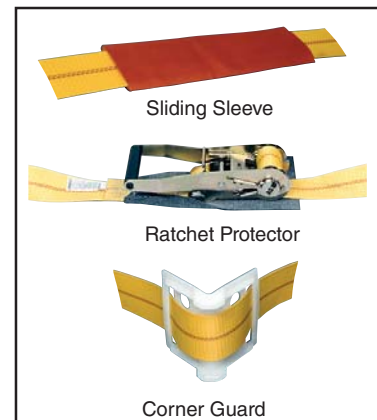

## WINCH STRAP ASSEMBLIES AND WINCHES

### Series 12,000, Load Huggers 3 & 4 inch Wide Polyester Winch Assemblies

- *Load Hugger Winch Straps* are made for securely mounted winches on flat bed trucks and trailers.
- Ultimate strength 15,000 lbs.
- Working load limit 5,000 lbs.
- Standard assemblies in 3" or 4" widths and 27' or 30' lengths
- Wear pads and corner protectors extend life of *Load Huggers* (see page 123)
- To order non-standards - specify width, length, and end fitting

Winches must be properly installed with ratchet pawl on top of toothed wheel to help prevent accidental disengagement.



**Standard Winch #61222**  
For 3" & 4" *Load Hugger*  
Winch Straps - 7.8 lbs.



**Portable Winch #61221**  
For 3" & 4" *Load Hugger*  
Winch Straps - 8.8 lbs.



**36" Winch Bar #61223**  
For use with 61221 and 61222 - 4.8 lbs.

End Fitting	Web Width (in.)	Assembly Length (ft.)	Standard Part No	Tuff-Edge Part No.	Assembly Weight (lbs.)
-------------	-----------------	-----------------------	------------------	--------------------	------------------------

#### Flat Hook



4	27	61201	TE61201	4.0
4	30	61202	TE61202	4.6
3	27	61203	TE61203	4.4
3	30	61204	TE61204	4.8

#### Forged Triangle



4	27	61205	TE61205	4.4
4	30	61206	TE61206	5.0
3	27	61207	TE61207	4.8
3	30	61208	TE61208	5.2

#### GrabHook



4	27	61209	TE61209	4.2
4	30	61210	TE61210	4.8
3	27	61211	TE61211	4.6
3	30	61212	TE61212	5.0

#### Chain Anchor



4	27	61213	TE61213	6.0
4	30	61214	TE61214	6.6
3	27	61215	TE61215	6.4
3	30	61216	TE61216	6.8

#### Sewn Eye



4	27	61217	TE61217	3.0
4	30	61218	TE61218	3.6
3	27	61219	TE61219	3.4
3	30	61220	TE61220	3.8

#### U-Hook



4	27	61225	TE61225	4.2
4	30	61226	TE61226	4.8
3	27	61227	TE61227	4.6
3	30	61228	TE61228	5.0

# LOAD HUGGER® CARGO CONTROL



## E - TRACK AND VAN INTERIOR ASSEMBLIES

To order non-standard interior van restraint assemblies specify:

- Overall length
- Fixed Length
- Cam buckle or ratchet buckle
- Spring loaded E-Track, 3 piece E-Track or any of the end fittings listed in Series 5,000 *Load Huggers* (page 108) may be attached
- Ultimate Assembly Strength: 2,500 lbs. with Cam Buckle  
3,000 lbs. with Ratchet
- Working load limit: 800 lbs. with Cam Buckle  
1,000 lbs. with Ratchet Buckle
- E-Track only works with E-Track fittings

Standard E-Track Straps	Standard Part No.	Tuff-Edge* Part No.	Wt. (lbs.)
2" x 12' Cam Buckle/Spring E Track Fittings - Yellow	60805	TE60805	1.6
2" x 16' Cam Buckle/Spring E Track Fittings - Gray	60806	TE60806	1.7
2" x 20' Cam Buckle/Spring E Track Fittings - Blue	60807	TE60807	1.8
2" x 12' Ratchet/Spring E Track Fittings - Yellow	60808	TE60808	2.0
2" x 16' Ratchet/Spring E Track Fittings - Gray	60809	TE60809	2.1
2" x 20' Ratchet/Spring E Track Fittings - Blue	60810	TE60810	2.2

\*Tuff-Edge web is yellow for all lengths.

Van interior restraint assemblies are only as strong as the anchor or track to which they are attached.



Cam Buckle and  
3 Piece E-Track Fitting



Spring Loaded E-Track Fitting (standard)



Tie Off Strap



Horizontal E-Track #60801  
12 Ga. Steel - Primed  
10 ft. Sections - 17 lbs.



Vertical E-Track #60802  
12 Ga. Steel - Primed  
10 ft. Sections - 17 lbs.

Note: E-Track can be cut into lengths suitable for UPS shipments.

## TIE DOWN CHAIN AND BINDERS



Tiedown Chain - Boomers (Grab hook each end)

Tiedown Chain - Boomers (Grab hook each end)	Standard Part No.	Wt. (lbs.)
5/16 x 20' G-70 Yellow Dichromate-Welded Hooks	16001	21.0
3/8 x 20' G-43 Self-colored-Welded Hooks	16002	32.0
5/16 x 20' G-70 Yellow Dichromate-Clevis Hooks	16005	21.0
3/8 x 20' G-43 Self-colored-Clevis Hooks	16006	32.0
Load Binders		
5/16 - 3/8 Lever Style	16004I	8.0
5/16 - 3/8 Ratchet Style	16003I	12.0



Load Binders

Load Huggers

## HOIST RINGS

### Hoist Rings Make Lifting Easy

Hoist rings provide the safest method of attaching pickup points to loads. Eye bolts, when lifted at an angle, tend to deform and fracture. Hoist rings are designed to eliminate this weakness.

### Features, Advantages and Benefits

#### Promotes Safety

- Magnetic particle or X-ray inspection of components - assures highest quality
- Predetermines proper hook-up - discourages unauthorized rigging methods
- Designed for lifting at angles - safer than rigid eye bolts
- Fixed lift points prevent load and sling from slipping
- Every hoist ring stamped with rated capacity

#### Saves Money

- Hooks and slings are not in contact with load - reduces load and sling damage
- Alloy steel material - increases strength, reduces wear
- Black oxide finish - resists corrosion
- Highest industry quality for durability and longest life

#### Saves Time

- Easy hook-up and disconnect of load
- Full swivel and pivot action of Side-Pull Hoist Rings allows turning and flipping without unhooking
- Easy to Inspect

### How To Order

Specify stock number.

### Safe Operating Practices

Read and understand instruction sheet supplied with each hoist ring prior to use.

- Do not use a damaged or defective hoist ring - inspect before each use
- Do not overload
- Full thread length must be engaged and torqued according to tables-periodic retorquing may be required.

Hoist ring ratings apply to use at any angle. Be sure that sling tension does not exceed the rating of the hoist ring. Refer to "Effect of Angle of Lift," page 12, to determine sling tension.

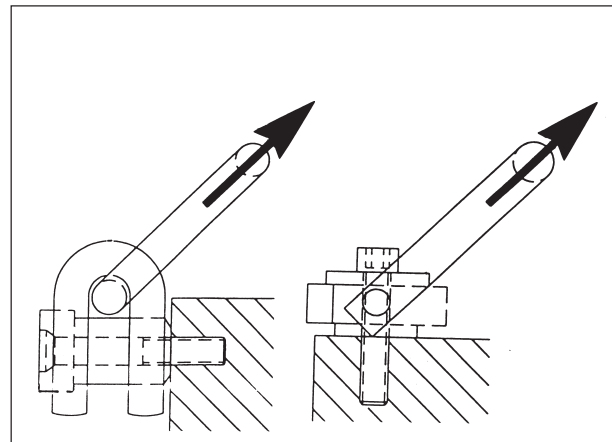
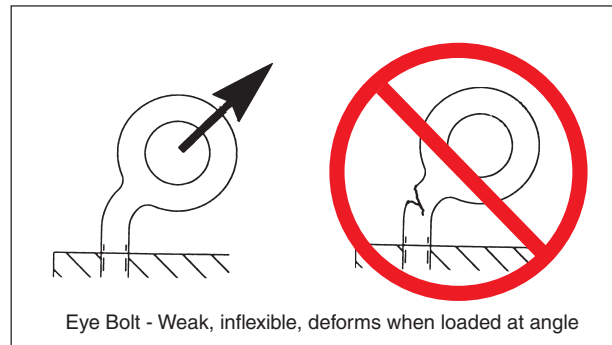

**Side - Pull Hoist Ring**

Strong, flexible, allows full 360° swiveling and pivoting.

**Center - Pull Hoist Ring**

Designed for top of load mounting. The industry standard.

# Hoist Rings



## HOIST RINGS

### Forged Center - Pull Hoist Rings

Forged Center Pull Hoist Ring features a solid center brace lift bail to eliminate the possibility of spreading the lift ring in misapplications. Forged hoist rings are ideal for OEM and industrial use.

- Full (over center) 360° swivel and 180° pivot action
- Capacities up to 30,000 lbs.
- 5:1 strength factor-alloy steel
- Available in 17-4PH Stainless Steel (up to 5,000lbs/2,150kgs)
- Made in U.S.A.
- Proof tested to 200% of Rated Load Capacity

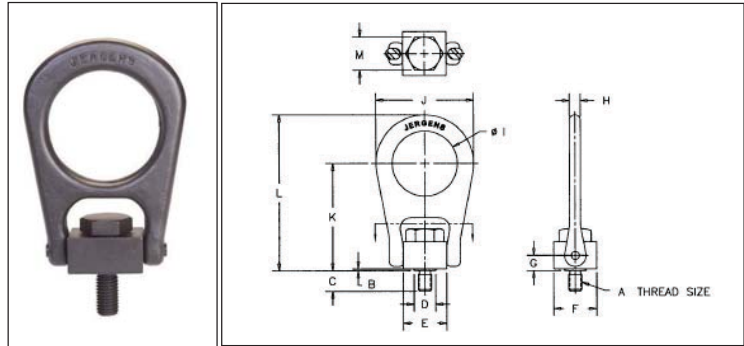

### Center-Pull Hoist Rings (Dimensions in inches)

Part Number	Load Capacity* (lbs.)	Thread Size A	B	C	D	E	F	G	H	I	J	K	L	M	Torque** (ft. lbs.)	Weight (lbs.)
23906	800	5/16-18	3/64	15/32	1/2	1	1	11/32	1/4	1 1/2	2 1/4	2 15/32	3 19/32	3/4	7	0.6
23907	800	5/16-18	3/64	5/8	1/2	1	1	11/32	1/4	1 1/2	2 1/4	2 15/32	3 19/32	3/4	7	0.6
23908	1,000	3/8-16	3/64	9/16	1/2	1	1	11/32	1/4	1 1/2	2 1/4	2 15/32	3 19/32	3/4	12	0.6
23909	1,000	3/8-16	3/64	3/4	1/2	1	1	11/32	1/4	1 1/2	2 1/4	2 15/32	3 19/32	3/4	12	0.6
23910	2,500	1/2-13	1/16	11/16	1	2	1 1/2	9/16	3/4	3	4 7/16	4	6 3/8	1 1/4	28	3.6
23911	2,500	1/2-13	1/16	1	1	2	1 1/2	9/16	3/4	3	4 7/16	4	6 3/8	1 1/4	28	3.6
23914	4,000	5/8-11	1/16	15/16	1	2	1 1/2	9/16	3/4	3	4 7/16	4	6 3/8	1 1/4	60	3.6
23915	4,000	5/8-11	1/16	1 1/4	1	2	1 1/2	9/16	3/4	3	4 7/16	4	6 3/8	1 1/4	60	3.6
23917	5,000	3/4-10	1/16	1 1/8	1	2	1 1/2	9/16	3/4	3	4 7/16	4	6 3/8	1 1/4	100	3.6
23918	5,000	3/4-10	1/16	1 1/2	1	2	1 1/2	9/16	3/4	3	4 7/16	4	6 3/8	1 1/4	100	3.6
23926	10,000	1-8	1/16	1 1/2	1 7/8	3 25/32	3	1 1/16	1 1/4	3 19/32	5 13/16	8 5/32	9 21/32	2 1/2	230	15.7
23927	10,000	1-8	1/16	2	1 7/8	3 25/32	3	1 1/16	1 1/4	3 19/32	5 13/16	8 5/32	9 21/32	2 1/2	230	15.9
23929	15,000	1 1/4-7	1/16	1 7/8	1 7/8	3 25/32	3	1 1/16	1 1/4	3 19/32	5 13/16	8 5/32	9 21/32	2 1/2	470	16.0
23930	15,000	1 1/4-7	1/16	2 1/2	1 7/8	3 25/32	3	1 1/16	1 1/4	3 19/32	5 13/16	8 5/32	9 21/32	2 1/2	470	16.2
23933	24,000	1 1/2-6	7/64	2 1/4	2 1/2	4 7/8	4 1/2	1 7/16	1 3/4	4 1/2	7 23/32	11 7/16	13 27/32	3 1/4	800	42.3
23934	24,000	1 1/2-6	7/64	3	2 1/2	4 7/8	4 1/2	1 7/16	1 3/4	4 1/2	7 23/32	11 7/16	13 27/32	3 1/4	800	42.7
23935	30,000	2-4 1/2	7/64	3	2 1/2	4 7/8	4 1/2	1 7/16	1 3/4	4 1/2	7 23/32	11 7/16	13 27/32	3 1/4	800	43.8
23936	30,000	2-4 1/2	7/64	4	2 1/2	4 7/8	4 1/2	1 7/16	1 3/4	4 1/2	7 23/32	11 7/16	13 27/32	3 1/4	800	44.7

### Metric Center-Pull Hoist Rings (Dimensions in millimeters)

Part Number	Load Capacity* (kgs.)	Thread Size A	B	C	D	E	F	G	H	I	J	K	L	M	Torque** (kg.m.)	Weight (kgs.)
23956	400	M8 x 1.25	1.2	12	12.7	25.4	25.4	8.7	6.3	38.1	57.2	62.7	91.3	19	10	0.27
23958	450	M10 x 1.50	1.2	15	12.7	25.4	25.4	8.7	6.3	38.1	57.2	62.7	91.3	19	17	0.27
23962	1,050	M12 x 1.75	1.6	18	25.4	50.8	38.1	14.3	19	76.2	112.7	101.6	161.9	32	37	1.64
23965	1,900	M16 x 2.0	1.6	24	25.4	50.8	38.1	14.3	19	76.2	112.7	101.6	161.9	32	80	1.64
23968	2,150	M20 x 2.5	1.6	30	25.4	50.8	38.1	14.3	19	76.2	112.7	101.6	161.9	32	134	1.7
23974	4,200	M24 x 3.0	1.6	35.7	47.6	96.0	76.2	27.0	31.7	91.3	147.6	207.2	245.3	63.5	305	7.1
23975	4,200	M24 x 3.0	1.6	47.6	47.6	96.0	76.2	27.0	31.7	91.3	147.6	207.2	245.3	63.5	305	7.2
23978	7,000	M30 x 3.5	1.6	44.8	47.6	96.0	76.2	27.0	31.7	91.3	147.6	207.2	245.3	63.5	590	7.3
23979	7,000	M30 x 3.5	1.6	60.0	47.6	96.0	76.2	27.0	31.7	91.3	147.6	207.2	245.3	63.5	590	7.4
23982	11,000	M36 x 4.0	2.8	53.6	63.5	123.8	114.3	36.5	44.5	114.3	196.1	290.5	351.6	82.55	960	19.1
23983	11,000	M36 x 4.0	2.8	71.4	63.5	123.8	114.3	36.5	44.5	114.3	196.1	290.5	351.6	82.55	960	19.3
23984	12,500	M42 x 4.5	2.8	62.7	63.5	123.8	114.3	36.5	44.5	114.3	196.1	290.5	351.6	82.55	980	19.4
23985	12,500	M42 x 4.5	2.8	83.3	63.5	123.8	114.3	36.5	44.5	114.3	196.1	290.5	351.6	82.55	980	19.6
23986	13,500	M48 x 5.0	2.8	71.4	63.5	123.8	114.3	36.5	44.5	114.3	196.1	290.5	351.6	82.55	980	19.7
23987	13,500	M48 x 5.0	2.8	95.3	63.5	123.8	114.3	36.5	44.5	114.3	196.1	290.5	351.6	82.55	980	20.0

\*\* Stated load capacity based on specific thread torques as shown in chart.

Hoist Rings

## HOIST RINGS

### Side - Pull Hoist Rings

This most versatile style of hoist ring is particularly suited for turning and flipping loads, but works equally well for top lifts. Used extensively in automotive stamping plants and injection molding operations for die changing.

- Full swivel & Pivot Action
- Alloy Steel, Black Oxide Finish
- Proof Tested to 200% of Rated Load Capacity

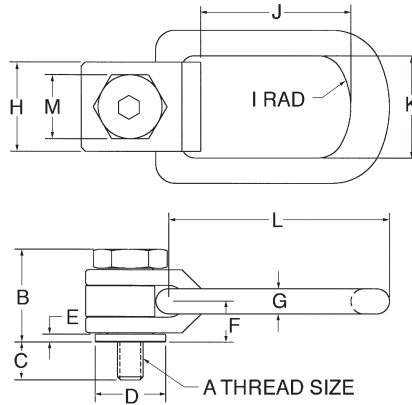

### Side-Pull Hoist Rings (Dimensions in inches)

Part No.	Load Capacity (lbs.)	Thread Size A	B	C	D	E	F	G	H	I	J	K	L	M	Torque** (ft.lbs.)	Hex Size	Weight (lbs.)
10253	650	5/16 - 18	1 9/32	15/32	13/16	1/8	9/16	5/16	1	1	1 1/4	1 3/4	3	3/4	4	-	.5
10254	800	3/8 - 16	1 9/32	5/8	13/16	1/8	9/16	5/16	1	1	1 1/4	1 3/4	3	3/4	5	-	.5
10255	1,800	1/2 - 13	1 7/8	3/4	1 3/8	5/32	13/16	1/2	1 3/4	1 1/2	2 3/8	2	4 5/16	1 1/4	15	1/4	2
10256	2,500	5/8 - 11	1 7/8	15/16	1 3/8	5/32	13/16	1/2	1 3/4	1 1/2	2 3/8	2	4 5/16	1 1/4	25	5/16	2
10257	4,100	3/4 - 10	2 5/16	1 1/8	1 7/8	1/4	1 1/32	5/8	2 1/4	2	2 1/4	2 5/8	5 11/16	1 3/4	50	3/8	4
10258	7,100	1 - 8	2 5/16	1 1/2	1 7/8	1/4	1 1/32	5/8	2 1/4	2	2 1/4	2 5/8	5 11/16	1 3/4	130	1/2	4.5
10259	14,000	1 1/4 - 7	4 9/16	1 7/8	3 1/4	23/64	1 21/32	1 1/16	3 3/4	3	2 1/8	4 3/8	8 13/16	3	150	3/4	24.5
10260	17,200	1 1/2 - 6	4 9/16	2 1/4	3 1/4	23/64	1 21/32	1 1/16	3 3/4	3	2 1/8	4 3/8	8 13/16	3	250	3/4	30
10261	29,000	2 - 4 1/2	4 9/16	3	3 1/4	23/64	1 21/32	1 1/16	3 3/4	3	2 15/16	4 3/8	8 13/16	3	300	3/4	26.5

### Metric Side-Pull Hoist Rings (Dimensions in millimeters)

Bushing is zinc plated silver.

Part No.	Load Capacity (kgs.)	Thread Size A	B	C	D	E	F	G	H	I	J	K	L	M	Torque** (kg.m.)	Hex Size	Weight (kgs.)
10262	325	M8 x1.25	33	16	21	3	14	8	25	25	52	44	76	19	.51	-	.25
10263	500	M10 x 1.5	33	20	21	3	14	8	25	25	52	44	76	19	1.1	-	.25
10264	725	M12 x 1.75	48	24	35	4	21	13	44	38	75	51	110	32	1.9	6	1
10265	1,400	M16 x 2.0	48	32	35	4	21	13	44	38	75	51	110	32	4.1	8	1
10266	2,290	M20 x 2.5	59	40	48	6	26	16	57	51	102	67	145	44	6.9	10	2
10267	3,050	M24 x 3	59	48	48	6	26	16	57	51	102	67	145	44	14	12	2
10268	4,850	M30 x 3.5	117	60	83	9	42	27	95	76	154	111	224	76	35	19	24.5
10269	7,500	M36 x 4	117	72	83	9	42	27	95	76	154	111	224	76	55	19	25
10270	8,700	M42 x 4.5	117	84	83	9	40	25	95	76	152	111	221	76	83	19	27.5
10271	10,000	M48 x 5	117	96	83	9	40	27	95	76	154	111	224	76	118	19	26

\* **WARNING** Do not exceed rated capacities. Be sure that sling tension does not exceed hoist ring capacity. Follow Instructions for Effect of Angle on page 12.

\*\* It is recommended that these torques be used when installing hoist rings.



## HURRICANE 360° HAND CHAIN HOIST



For the ultimate flexibility in a hand chain hoist, the CM Hurricane 360° is the choice for a wide range of applications. The patented hand chain cover rotates a full 360 degrees to allow loads to be lifted, pulled, or positioned from virtually any angle. In addition to providing maximum versatility, this unit offers a convenient way to maneuver loads without standing under the load. The Hurricane 360° allows workers to view hand chain hoists in a whole new light and provides a tool for addressing unique jobs in a broad range of environments.

### Trusted Reliability

- The braking power of our Weston-Style Braking System provides positive load control and reliable performance.
- Minimal maintenance and easy to disassemble with no special tools.

### Safety

- Standard Load Limiter for simple, automatic overload protection.

### Built to Last

- All internal gears and pinions are heat treated steel for high strength and long life.
- Precision 4-Pocket Liftwheel and Chain provides better chain fit and alignment which reduces wear and increases chain life.

### Rugged Toughness

- Powder Coated Finish for corrosion protection
- Alloy hardened Steel Load Chain assures high strength and long wear life.
- Meets ASME B30.16 and European CE Standard.
- Lifetime Warranty.

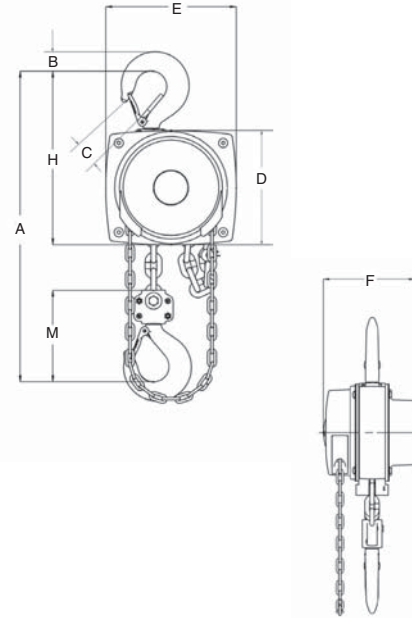

Product Code	Load Rating (tons)	Lift (ft.)	Net Wt. (lbs.)	Hand Chain Pull to Lift Rated Load (lbs.)	Hand Chain Overhauled to Lift Load One Foot (ft.)	Dimensions (in.)							
						A	B	C	D	E	F	H	M
12HCHX10	1/2	10	19.8	44	30	11 13/16	11/16	15/16	5 1/4	5 13/16	5 13/16	8 1/8	4 5/16
12HCHX15		15	21.0										
12HCHX20		20	23.4										
1HCHX10	1	10	28.7	54	49	13 3/16	7/8	1 1/8	6 1/8	6 7/8	6 5/8	9 1/2	4 15/16
1HCHX15		15	30.7										
1HCHX20		20	34.8										
2HCHX10	2	10	44.1	74	71	15 9/16	1 3/16	1 3/8	7 3/16	8	7 5/8	11 1/8	6 1/8
2HCHX15		15	47.6										
2HCHX20		20	54.7										
3HCHX10	3	10	61.7	92	87	20 1/2	1 1/2	1 9/16	8 11/16	9 13/16	8 5/8	13 3/16	7
3HCHX15		15	67.5										
3HCHX20		20	79.2										
5HCHX10	5	10	83.8	76	174	25 3/4	1 3/4	1 7/8	8 11/16	9 13/16	8 5/8	13 7/8	11 1/4
5HCHX15		15	95.4										
5HCHX20		20	118.6										
10HCHX10	10	10	156.6	102	261	32 1/2	2 11/16	2 11/16	8 11/16	15 1/16	8 5/8	17 3/16	15 13/16
10HCHX15		15	174.0										
10HCHX20		20	208.8										

## CM MANUAL CHAIN HOISTS

All CM Hoists come with hardened alloy load chain and fully enclosed brake and housing for long life. Swivel hooks make connection and turning of load easy.



### CYCLONE

Cyclone hoists are the premium grade manual chain hoists. Built for heavy duty use, these hoists are most often placed for permanent installation using the standard hook or mounting directly to a low headroom, plain or geared trolley.

- Cast aluminum body for strength
- Load Limiter - prevents hoist damage from excessive loads.
- Lifetime warranty against defects in workmanship and materials.
- Made in U.S.A.

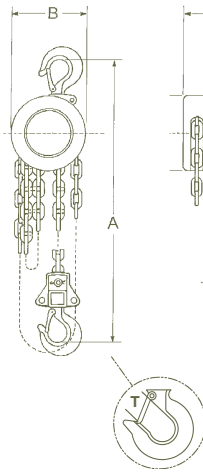

### SERIES 622

The Series 622 hoists are the economical choice in a quality manual chain hoist. Contractors favor the 622 because of its light weight and compact design.

- Stamped steel body for light-weight strength.
- Compact design for low head-room.
- One year warranty against defects in workmanship and materials.



Part No.	Std. Lengths (ft.)	Max. Cap. (tons)	Strands of Load Chain	Hand Chain		A (in.)	B (in.)	C (in.)	T (in.)	10 Ft. Net Wt. (lbs.)
				Pull (lbs.) <sup>1</sup>	Overhaul (ft.) <sup>2</sup>					
Cyclone										
14CHX10	10	1/4	1	23	22 1/2	12 7/8	10 7/8	7 3/8	1 11/32	40
12CHX10	10	1/2	1	46	22 1/2	12 7/8	10 7/8	7 3/8	1 11/32	40
1CHX10	10	1	1	69	30	14	10 7/8	7 3/8	1 1/8	43
112CHX10	10	1 1/2	1	80	40 1/2	17 5/16	10 7/8	9 7/8	1 5/16	70
2CHX10	10	2	1	83	52	17 5/16	10 7/8	9 7/8	1 5/16	70
3CHX10	10	3	2	85	81	21 1/2	12 1/4	9 7/8	1 5/8	103
4CHX10	10	4	2	88	104	21 1/2	12 1/4	9 7/8	1 5/8	103
5CHX10	10	5	3	75	156	24 1/2	14 1/2	9 7/8	1 5/8	138
6CHX10	10	6	3	90	156	25 1/2	14 1/2	9 7/8	1 3/4	142
8CHX10	10	8	4	89	208	35 1/2	17 1/2	9 7/8	2 5/16	248
10CHX10	10	10	5	95	260	35 1/2	17 1/2	9 7/8	2 5/16	251
Series 622*										
12CHIX_	10,15,20,30	1/2	1	45	32	10	4 11/16	4 3/16	3/4	18
1CHIX_	10,15,20,30	1	1	74	39	12	5 19/32	5 3/16	7/8	26
2CHIX_	10,15,20,30	2	1	70	77	17	8 5/16	6 19/32	1 1/16	61
3CHIX_	10,20	3	2	54	154	22	8 5/16	6 19/32	1 1/4	89
5CHIX_	10,20	5	2	88	154	24	8 5/16	6 19/32	1 11/16	91
10CHIX_	10	10	4	90	308	32	14 13/16	6 19/32	2 3/16	170

\* Add length after X to complete part number

<sup>1</sup> Pull required to lift rated load.

<sup>2</sup> Overhaul distance to lift load one foot.

## CM LEVER PULLERS

Lever Pullers are highly versatile tools that can be used to pull, lift, drag or stretch. All CM Lever Pullers use hardened alloy steel chain for long life and forged steel swivel hooks with latches for safety and ease of use.

### CM PULLER



Designed for heavy-duty construction and industrial applications. Fully enclosed lift wheel resists dirt and grit that can damage mechanism.

- Tough Aluminum alloy construction.
- Lifetime warranty against defects in workmanship and materials.
- Weatherproof
- Made in U.S.A.
- Low turning ratio results in quick chain movement

### SERIES 653



Designed for close quarter, standard duty commercial applications. Short handle with low pull requirement makes these units easy to operate.

- Impact resistant, stamped steel frame, gear case and cover for durability and light weight.
- Hardened steel, redundant load sharing gears.
- Double pawl arrangement for optimum load control.
- Two chain guide rollers for precise chain fit.
- 5 year warranty.
- Rubber handle grip for added operator comfort.
- Minimal maintenance with no special tools required.

### OPTIONAL OVERLOAD DEVICES FOR THE CM PULLERS

Two ways to protect your loads and lever pullers from overload damage are available as optional accessories to your CM PULLERS. Either device may be installed on your PULLER at time of order or ordered separately as a kit for simple installation on models already in use.

#### LOAD LIMITER

**(Not available on Series 653)**

Stops excessive lever force from being transmitted to the PULLER.



* Part No.	Std. Lengths (ft.)	Max. Cap. (tons)	Lever Pull (lbs.)	Min. Hook Distance (in.)	Lever Length (in.)	Hook Throat Opening (in.)	5 Ft. Net Wt (lbs.)
CM Puller							
34PX_	5, 10, 20	3/4	58	10 3/4	21 1/4	1 1/32	16
112PX_	5, 10, 20	1 1/2	89	14 1/4	21 1/4	1 1/8	26
3PX_	5, 10, 20	3	95	17	21 1/4	1 7/32	38
6PX5	5	6	96	21 3/8	21 1/4	1 3/4	73
Series 653							
34PIX_	5, 10, 15, 20	3/4	33	12 6/8	11	1 1/8	15
112PIX_	5, 10, 15, 20	1 1/2	51	14 13/16	16 1/4	1 1/4	27
3PIX_	5, 10	3	77	18 11/16	16 1/4	1 9/16	45

\* Add length after X to complete part number

#### LOAD SENTRY

**(Not available on Series 653)**

Deflection of the handle grip warns the user when excessive force is being applied to the lever handle.



**CM MINI-RATCHET LEVER HOISTS**

Mini-Ratchet Lever Hoists can lift up to 1,100 lbs. but are small enough to fit in your toolbox! These ratchet lever hoists are the most compact on the market. They perform just like our larger models, plus come with these great features:

**602MH**



550 LB.  
Capacity

**603MH**



1100 LB.  
Capacity

Designed for close quarter, standard duty commercial applications. Short handle with low pull requirement makes these units easy to operate.

- Plated load chain
- Weston style load brake
- Rubber hand grip for better comfort and control
- Lightweight design for easy transport and one-hand operation in confined space
- Forged hooks with latches are standard
- Impact resistant, all-steel frame, gear case and cover
- Hardened link-type alloy steel load chain for strength and long wear
- Free wheeling feature serves to quickly attach the load
- Your choice of either 5 ft. or 10 ft. lifts

Part No.	Length (ft.)	Capacity		Number of Chain Falls	Handle Length (in.)	Min. Distance Between Hooks (in.)	Lift w/ One Full Lever Turn (in.)	Handle Pull @ WLL (lbs.)	Net Wt. (lbs.)
		lbs.	kg.						
602MHX5	5	550	250	1	6.300	9.450	3.15	56	6.0
602MHX10	10	550	250	1	6.300	9.450	3.15	56	7.0
603MHX5	5	1100	500	1	6.375	11.125	1.57	78	7.0
603MHX10	10	1100	500	1	6.375	11.125	1.57	78	8.0



## BASIC INFORMATION

*Lift-All* can provide a unique engineered device for your production requirements. Our custom devices range from large capacity beams to control and balance unwieldy loads, to fork lift attachments or small “S” or “J” hooks.

### Features, Advantages and Benefits

#### Promotes Safety

- Specifically designed equipment makes each lift safer
- All equipment conforms to highest engineering standards and meets or exceeds government and industry regulations (ASME B30.20)
- Helps eliminate employee fatigue - raises morale and quality of work

#### Saves Money

- Productivity improves through efficiency when using properly designed lifting devices.
- Equipment can be designed to prevent costly load damage
- Rugged materials and construction provide long useful life

### Inspection Criteria for Lifting Devices

Visually inspect lifting device and slings prior to each lift. Have competent person record inspection a minimum of once a year.

Check the following and correct before use:

- Structural deformation, cracks, excessive wear
- Loose or missing guards, fasteners, covers, stops or name plates
- Inoperable mechanisms including automatic hold or release devices
- Loose bolts or fasteners
- Cracked or worn gears, pulleys, sheaves, sprockets, bearings and chains
- Excessive wear of friction pads, linkage or other mechanical parts
- Excessive wear of hoist hooking points and load support clevises or pins

### Safe Operating Practices

- Use only per ASME B30.20
- Check name plate to assure proper lifting capacity
- Lift a test load a sufficient distance to assure that the load is supported properly by the lifter and then inspect lifter for defects and deformation
- Instruct the operator in correct lifting practices including proper storage, load distribution, use of associated slings, temperature considerations, avoidance of obstructions, acceleration, side pulls and angle of lift. Read “Help” section, pages 3 through 12.
- Never lift over people and never ride the load
- For proper use of slings with lifting devices refer to ASME B30.9 and appropriate section of this catalog

### How to Order - The Easy Order System

1. Photocopy appropriate drawing from the following pages
2. Fill-in your specific data
3. Fax to *Lift-All* at 717-898-1215.

### Phone 1-800-909-1964

If we have questions, we will call you. Our engineering drawing will be faxed to you for approval and purchase order.

Prior to sling or lifting device selection and use, review and understand the “Help” section pages 3 through 12.



Required information:

Opening required for Overhead Hook: \_\_\_\_\_

A (Height) \_\_\_\_\_

B (Width) \_\_\_\_\_

C (Max.) \_\_\_\_\_

Capacity Required \_\_\_\_\_

Spread \_\_\_\_\_

Headroom \_\_\_\_\_

D (Optional) \_\_\_\_\_

If adjustable beam required, list quantity and spread for any additional pairs of holes, pins and hooks.

\_\_\_\_\_

\_\_\_\_\_

\_\_\_\_\_

\_\_\_\_\_

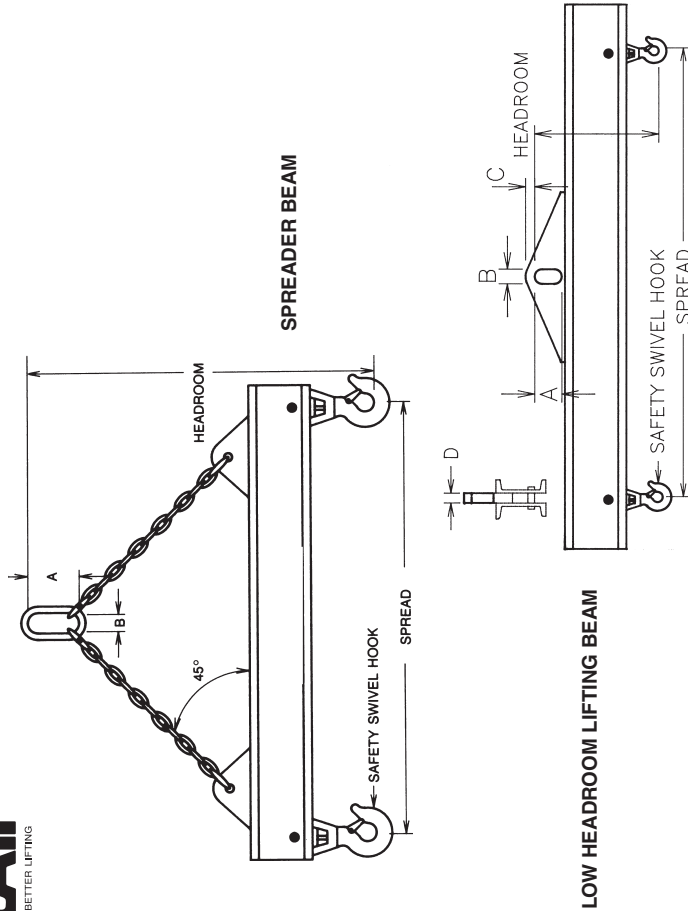

Quotation Needed By: \_\_\_\_\_ Date \_\_\_\_\_

Date \_\_\_\_\_ From \_\_\_\_\_ Person Requesting Quote \_\_\_\_\_

Distributor \_\_\_\_\_

Address \_\_\_\_\_

City \_\_\_\_\_ State \_\_\_\_\_ Zip \_\_\_\_\_

Phone ( ) \_\_\_\_\_ Fax ( ) \_\_\_\_\_

Lift-All Dwg. No. \_\_\_\_\_ Customer Dwg. No. \_\_\_\_\_

User Company \_\_\_\_\_ User Contact - Name - Phone \_\_\_\_\_

Purchase Order No. \_\_\_\_\_

Signature \_\_\_\_\_ Date \_\_\_\_\_

NOTE: Custom Engineered Products Cannot Be Returned

LB-1





## STANDARD J-HOOKS

Alloy steel hooks, welded, heat treated, shot blast finish, proof tested and certified.

### Foundry Sorting Hooks

Best for foundry and industrial general sorting operations.

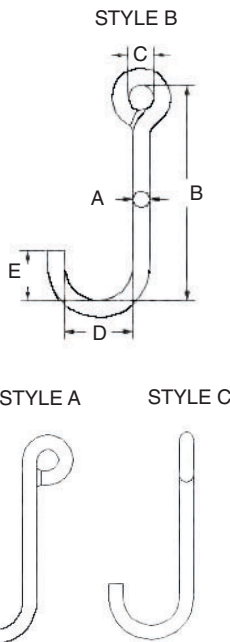
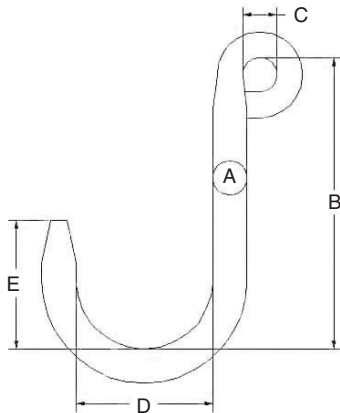

### Standard

Part No.	A	B	C	D	E	Chain Size Eye Fits Mech. Coupler	Rated Capacity * (lbs.)
FSA050	0.50	6.00	0.75	2.50	2.00	0.28	500
FSA063	0.63	8.50	0.75	3.50	3.25	0.28	800
FSA075	0.75	8.50	0.75	3.50	3.25	0.28	1300
FSA081	0.81	8.50	0.88	3.50	3.25	0.38	1600
FSA100	1.00	8.50	1.00	4.00	3.75	0.38	2500
FSA113	1.13	8.50	1.00	4.00	4.00	0.38	3500
FSA125	1.25	8.50	1.25	4.00	4.00	0.50	4500
FSA150	1.50	8.50	1.25	5.00	4.00	0.50	6000

### Short

Part No.	A	B	C	D	E	Chain Size Eye Fits Mech. Coupler	Rated Capacity * (lbs.)
FSA050S	0.50	6.00	0.75	3.00	3.00	0.28	450
FSA063S	0.63	6.00	0.75	3.00	3.00	0.28	900
FSA075S	0.75	6.00	0.75	3.00	3.00	0.28	1400
FSA088S	0.88	6.00	0.88	3.00	3.00	0.38	2000
FSA100S	1.00	6.00	1.00	3.00	3.00	0.38	3000
FSA113S	1.13	6.00	1.00	3.00	3.00	0.38	4000
FSA125S	1.25	6.00	1.25	3.00	3.00	0.50	5500

### Flat Tip Hooks

Part No.	Part No.	Part No.	A	B	C	D	E	Rated Capacity * (lbs.)
JAA031	JBA031	JCA031	0.31	5.00	0.75	1.25	0.88	250
JAA038	JBA038	JCA038	0.38	6.00	0.75	1.50	1.13	350
JAA050	JBA050	JCA050	0.50	8.00	0.75	2.00	1.50	650
JAA063	JBA063	JCA063	0.63	9.00	1.00	2.50	1.88	850
JAA075	JBA075	JCA075	0.75	10.00	1.00	3.00	2.25	1200
JAA088	JBA088	JCA088	0.88	12.00	1.00	3.50	2.63	1500
JAA100	JBA100	JCA100	1.00	14.00	1.25	4.00	3.00	2000
JAA113	JBA113	JCA113	1.13	15.00	1.25	4.50	3.37	2250
JAA125	JBA125	JCA125	1.25	16.00	1.50	5.00	3.75	2750
JAA138	JBA138	JCA138	1.38	17.00	1.50	5.50	4.13	3000
JAA150	JBA150	JCA150	1.50	18.00	2.00	6.00	4.50	3500
JAA175	JBA175	JCA175	1.75	20.00	2.50	7.00	5.25	4000
JAA200	JBA200	JCA200	2.00	24.00	3.00	8.00	6.00	5000

\* Rated Capacity based on bearing to bearing pull. Tip load capacity averages 30% of bearing to bearing rating.

**STANDARD COIL LIFTER**

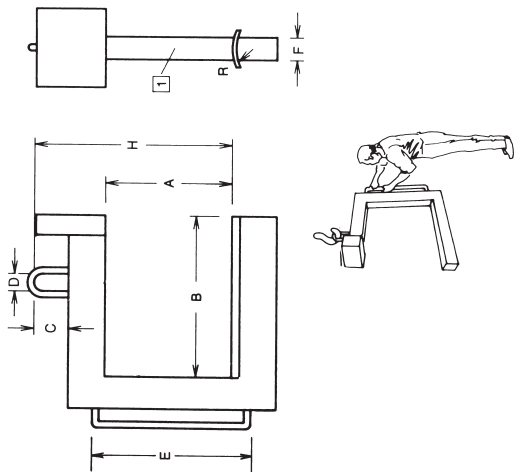

**STANDARD PALLET LIFTER**

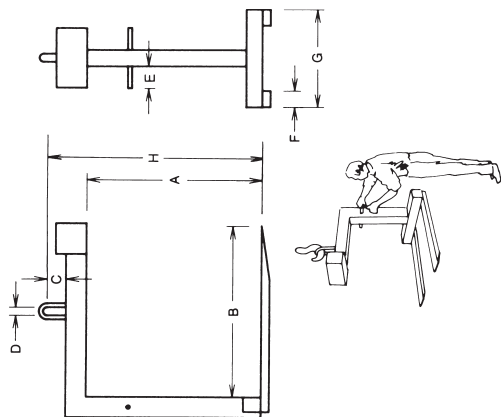

Required information:

Style Requested:  Coil Lifter  Pallet Lifter

Capacity \_\_\_\_\_

Minimum Coil I.D. \_\_\_\_\_

Maximum Coil O.D. \_\_\_\_\_

Maximum Coil Width \_\_\_\_\_

Size of Overhead Hook (Cap.) \_\_\_\_\_

A \_\_\_\_\_

B \_\_\_\_\_

C (Minimum) \_\_\_\_\_

D (Minimum) \_\_\_\_\_

E \_\_\_\_\_

F (Optional) \_\_\_\_\_

G \_\_\_\_\_

H (Optional) \_\_\_\_\_

R (Optional) \_\_\_\_\_

Back Stop Pad Yes  No

Special Instructions:

Quotation Needed By: \_\_\_\_\_ Date \_\_\_\_\_

Date \_\_\_\_\_ From \_\_\_\_\_ Person Requesting Quote \_\_\_\_\_

Distributor \_\_\_\_\_

Address \_\_\_\_\_

City \_\_\_\_\_ State \_\_\_\_\_ Zip \_\_\_\_\_

Phone ( ) \_\_\_\_\_ Fax ( ) \_\_\_\_\_

Lift-All Dwg. No. \_\_\_\_\_ Customer Dwg. No. \_\_\_\_\_

User Company \_\_\_\_\_ User Contact - Name - Phone \_\_\_\_\_

Purchase Order No. \_\_\_\_\_

Signature \_\_\_\_\_ Date \_\_\_\_\_

NOTE: Custom Engineered Products Cannot Be Returned

## CONVERSION AND WEIGHT TABLES

### Metric / English Conversions

#### Length

1 CM = .3937 In.  
 2.54 CM = 1 In.  
 .3048 M = 1 Ft.  
 1 M = 3.281 Ft.

#### Weight

.4536 Kg = 1 Lb.  
 1 Kg = 2.2046 Lbs.

#### Volume

.028 Cu. M = 1 Cu. Ft.  
 1 Cu. M = 35.314 Ft.  
 1 Cu. Ft. = 7.5 Gals.

### Weights of Various Materials and Liquids

Pounds / cu. ft.					
Aluminum	165	Earth - Dry	75	Rubber	94
Asphalt	81	Earth - Wet	100	Sand - Dry	105
Brass	524	Gasoline	45	Sand - Wet	120
Brick	120	Glass	162	Steel	490
Bronze	534	Iron Casting	470	Water	63
Cement - Loose	95	Lead	708	Zinc	437
Cement - Set	183	Lumber - Fir	32		
Coal	56	Lumber - Oak	62		
Concrete	150	Lumber - RR Ties	50		
Crushed Rock	95	Oil, Motor	58		
Diesel	52	Paper	60		

Pounds / sq. ft.	
Steel Plate	
1/8"	5
1/4"	10
1/2"	20
1"	40
Aluminum Plate	
1/8"	1.75
1/4"	3.50
Lumber	
3/4" Fir	2
3/4" Oak	4

Pounds / gal.	
Gasoline	6.0
Diesel	7.0
Water	8.3

### Decimal Equivalents

Fraction	Inches	Millimeters	Fraction	Inches	Millimeters
1/32	.0312	0.80	17/32	.5312	13.49
1/16	.0625	1.59	9/16	.5625	14.29
3/32	.0937	2.38	19/32	.5937	15.08
1/8	.125	3.18	5/8	.625	15.88
5/32	.1562	3.97	21/32	.6562	16.67
3/16	.1875	4.76	11/16	.6875	17.46
7/32	.2187	5.56	23/32	.7187	18.26
1/4	.250	6.35	3/4	.750	19.05
9/32	.2812	7.14	25/32	.7812	19.84
5/16	.3125	7.94	13/16	.8125	20.64
11/32	.3437	8.73	27/32	.8437	21.43
3/8	.375	9.53	7/8	.875	22.23
13/32	.4062	10.32	29/32	.9062	23.02
7/16	.4375	11.11	15/16	.9375	23.81
15/32	.4687	11.91	31/32	.9687	24.61
1/2	.500	12.70	1	1.0	25.40



**Manufacturing and Warehousing in:**

**Atlanta  
Chicago  
Houston  
Las Vegas**

**Headquarters, Customer Service & Manufacturing:**

**PO Box 27  
1909 McFarland Drive  
Landisville, PA 17538**

**800-909-1964**

**FAX: 717-898-1215**

**E-Mail: [lift-all@lift-all.com](mailto:lift-all@lift-all.com)**

**Customer Service: [customerservice@lift-all.com](mailto:customerservice@lift-all.com)**

**[www.lift-all.com](http://www.lift-all.com)**



Printed in U.S.A. CAT-2015 IS 15K



CATALOG 2015