



Lufkin®

- Power Tapes
- Surveying Tapes
- Rules
- Measuring Wheels

Ever since the first Lufkin® wood rule was produced in 1869, the Lufkin brand has been synonymous with high quality and unmatched accuracy. Today, Lufkin wood rules, power tapes, engineering and surveying tapes, specialty tapes and measuring wheels comprise one of the widest selections of measuring products available from any manufacturer.

Lufkin® Table of Contents

For over a century, Lufkin® tapes have been recognized as the standard for accuracy and high quality. Lufkin® steel tapes are manufactured to government standards traceable to the U.S. Department of Commerce, National Institute of Standards and Technology. Periodically, these standards are recalibrated with renewed certification by the N.I.S.T.

LUFKIN® TAPE CERTIFICATION AND ISO

Many end-users are registering for ISO certification. If they use measuring tapes as part of their production processes, it is advisable to establish procedures requiring the use of a certified tape as a master.

Lufkin® provides selected certified tapes in excess of 50' for standard charges (which include the purchase price of the tape). Short tapes are not calibrated, but are checked for accuracy. Lufkin's test procedures are traceable to the National Institute of Standards and Technology. Prices and available certified tapes are available from Cooper Hand Tools' Technical Services Department.

| Contents | Page No. |
|--|-----------|
| Short tapes | 63 - 71 |
| Pro Series, Series 2000 & 1000 power tapes | 63 - 65 |
| Hi-Viz® short tapes | 65 |
| Quikread short tapes | 66 |
| 800 Series, 700 Series and L500 Series power tapes | 67 - 68 |
| Short tape blades | 71 - 75 |
| Long steel tapes | 75 - 80 |
| Hi-Viz® long steel tapes | 77 - 79 |
| Long steel tape blades | 80 - 82 |
| Hi-Viz® fiber tapes | 83 - 84 |
| Fiber tape blades | 85 |
| Synthetic fiber tapes | 86 |
| Synthetic fiber tape blades | 86 |
| Oil gauging long tapes | 87 - 89 |
| Oil gauging long tape blades | 89 - 90 |
| Plumb bobs | 91 |
| Surveying long tapes | 92 - 94 |
| Surveying long tape blades | 95 - 96 |
| Pro Series Hi-Viz® surveying long tapes | 93 |
| Engineering / Surveying long tapes | 96 |
| Reels and replacement parts for reels and frames | 97 - 98 |
| Short and long tapes accessories | 98 - 99 |
| Folding wood rules | 99 - 102 |
| Flat rules | 102 - 104 |
| Measuring wheel products | 105 - 106 |
| Lufkin® numerical index | 107 - 108 |

Short tapes

Prefixes

| | |
|---------|-------------------|
| C- | Chrome Clad® |
| R- | Replacement Blade |
| W or Y- | Yellow Clad |

Suffixes

| | |
|------|--|
| ME- | Metric/English Graduations, millimeter numbering |
| CM- | Metric/centimeter numbering |
| CME- | Metric/English graduations, centimeter numbering |
| D- | English Graduated feet and decimal feet along one edge, feet and inches along other edge |
| X- | Graduated in feet, inches and tenths of inches |
| DM- | Graduated millimeters and feet, 10ths and 100ths |

Quad Hook®

- Patented four rivet design reduces strain and extends blade life
- Hardened end hook is tough and durable
- End hook durability test results show that the Quad Hook® significantly outlasts the competition
- Burr on inside edge of Quad Hook® grabs onto the workpiece
- Quad Hook® serrations allow use as a scribe
- Quad Hook® on 1" tapes only

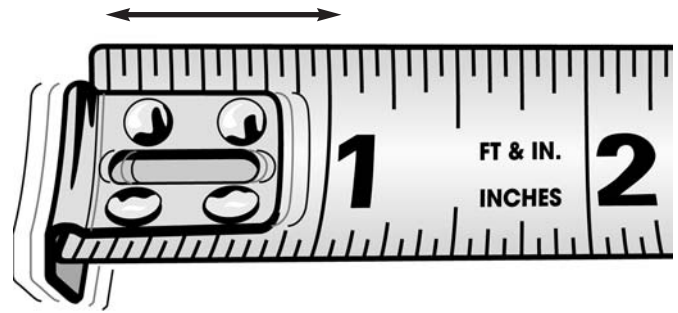

Short Tapes

- Blades are finished with an abrasive resistant coating for durability and long life
- Two color easy-to-read markings
- Self-adjusting end hooks
- Metric/English, English, Decimal, and Metric/Decimal
- Refills available on some models

PS3000 - Pro Series Power Return Tapes

- Ny-Clad® blade coating extends blade life 5 times longer than standard
- Patented end hook lasts 10 times longer than ordinary end hooks
- Non-slip toggle lock allows complete control of power tape blade
- Rubber cushion shell protects tape from impact and improves grip
- Compact size for comfort and easy storage
- Removable belt clip

**NEW
PRODUCT**



PS3435

Lufkin

| Cat. No. | UPC No. | Blade Size | | Blade Style | Pack Wt. | | Shelf Pack |
|-----------|--------------|------------|----------|-------------|----------|-----|------------|
| | | Width | Length | | lb | kg | |
| PS3435 | 037103194657 | 1" | 35' | A5 | 5.85 | 2.7 | 4 |
| PS3430 | 037103194596 | 1" | 30' | A5 | 5.9 | 2.7 | 4 |
| PS3425 | 037103194633 | 1" | 25' | A5 | 4.56 | 2.1 | 4 |
| PS3425D | 037103200389 | 1" | 25' | A4 | 4.56 | 2.1 | 4 |
| PS3048CME | 037103196910 | 1" | 26' (8m) | A13 | 4.56 | 2.1 | 4 |
| PS3316 | 037103194572 | 3/4" | 16' | A2 | 2.85 | 1.3 | 4 |
| PS3035CME | 037103196927 | 3/4" | 16' (5m) | A13 | 2.85 | 1.3 | 4 |
| PS3312 | 037103194589 | 3/4" | 12' | A2 | 2.5 | 1.1 | 4 |
| PS3034CME | 037103196934 | 3/4" | 13' (4m) | A13 | 2.5 | 1.1 | 4 |

Series 2000 Power Return Tapes



2125

- Case designed to fit perfectly in the hand
- Lightweight, high strength chrome finished case
- Fits easily into most tape holsters
- Bright yellow blade has clear easy-to-read numerals
- Toggle lock is positioned for convenient operation and holds the blade securely in any position
- Virtually unbreakable Quad Hook®; four rivets for extra strength (1" blade only)
- Cushioned blade return
- Removable belt clip
- All shelf pack power tapes on this page are carded

| Cat. No. | UPC No. | Blade Size | | Blade Style | Pack Wt. | | Shelf Pack | Replacement Blade | UPC No. |
|----------|--------------|------------|--------------------|-------------|----------|------|------------|-------------------|--------------|
| | | Width | Length | | lb | kg | | | |
| 2133 | 037103108580 | 1" | 33' | A5 | 8.00 | 3.63 | 6 | - | - |
| 2133D | 037103108524 | 1" | 33' Engineer's | A4 | 8.00 | 3.63 | 6 | - | - |
| 2410CME | 037103108517 | 1"(25mm) | 33'(10m) | A30 | 8.00 | 3.63 | 6 | - | - |
| 2130 | 037103442130 | 1" | 30' | A5 | 6.65 | 3.02 | 6 | RY430 | 037103459862 |
| 2049CME | 037103442901 | 1"(25mm) | 30'(9m) | A30 | 6.65 | 3.02 | 6 | - | - |
| 2125 | 037103441539 | 1" | 25' | A5 | 5.68 | 2.58 | 6 | RY425 | 037103457042 |
| 2048CME | 037103441829 | 1"(25mm) | 26'(8m) | A30 | 5.68 | 2.58 | 6 | - | - |
| 2325 | 037103442123 | 3/4" | 25' | A2 | 4.56 | 2.07 | 6 | RY325 | 037103452351 |
| 2325D | 037103013316 | 3/4" | 25' Engineer's | A4 | 4.56 | 2.07 | 6 | - | - |
| 2338CME | 037103013255 | 3/4"(19mm) | 26'(8m) | A13 | 4.56 | 2.07 | 6 | - | - |
| 2038ME | 037103104021 | 3/4"(19mm) | 26'(8m) | A12 | 4.56 | 2.07 | 6 | - | - |
| 2316 | 037103441737 | 3/4" | 16' | A2 | 3.14 | 1.42 | 6 | RW316 | 037103452337 |
| 2335ME | 037103013293 | 3/4"(19mm) | 16'(5m) | A12 | 3.14 | 1.42 | 6 | - | - |
| 2035CM | 037103057532 | 19mm | 5m | A9 | 3.14 | 1.42 | 6 | - | - |
| 2035CME | 037103441997 | 3/4"(19mm) | 16'(5m) | A13 | 3.14 | 1.42 | 6 | RY35CME | 037103461018 |
| 2312 | 037103441720 | 3/4" | 12' | A2 | 2.4 | 1.07 | 6 | - | - |
| 2312D | 037103013309 | 3/4" | 12' Engineer's | A4 | 2.4 | 1.07 | 6 | - | - |
| 2034CME | 037103003546 | 3/4"(19mm) | 13'(4m) | A13 | 2.6 | 1.18 | 6 | - | - |
| 2033CME | 037103104007 | 3/4"(19mm) | 10'(3m) | A13 | 2.38 | 1.08 | 6 | - | - |
| 2333ME | 037103013286 | 3/4"(19mm) | 10'(3m) | A12 | 2.2 | 1.0 | 6 | - | - |
| 2212 | 037103013231 | 1/2" | 12' | A1 | 1.9 | 0.85 | 6 | RY212 | 037103450388 |
| 2212X | 037103013477 | 1/2" | 12' Engineer's | A7 | 1.9 | 0.85 | 6 | - | - |
| 2212DX | 037103124920 | 1/2" | 12' Engineer's | A31 | 1.9 | 0.85 | 6 | - | - |
| 2024CME | 037103103994 | 1/2"(13mm) | 13'(4m) | A13 | 2.0 | 0.90 | 6 | - | - |
| 2210 | 037103013323 | 1/2" | 10' | A1 | 1.8 | 0.80 | 6 | RY210 | 037103450234 |
| 2210MEX | 037103097897 | 1/2"(13mm) | 10'(3m) Engineer's | A36 | 1.8 | 0.80 | 6 | - | - |
| 2223CME | 037103013224 | 1/2"(13mm) | 10'(3m) | A13 | 1.8 | 0.80 | 6 | - | - |

Series 1000 Power Return Tapes

- Hi-Viz® case - easy to find on the job
- Case designed to fit perfectly in the hand
- Lightweight, high strength case
- Fits easily into most tape holsters
- Bright yellow blade has clear easy-to-read numerals
- Toggle lock is positioned for convenient operation and holds the blade securely in any position
- Virtually unbreakable Quad Hook®; four rivets for extra strength (1" blade only)
- Cushioned blade return
- Removable belt clip
- All shelf pack power tapes on this page are carded



HV1430

| Cat. No. | UPC No. | Color | Blade Size | | Blade Style | Pack Wt. | | Shelf Pack | Replacement Blade | UPC No. |
|-----------|--------------|--------|------------|----------------------|-------------|----------|------|------------|-------------------|--------------|
| | | | Width | Length | | lb | kg | | | |
| HV1433 | 037103108494 | Orange | 1" | 33' | A5 | 8.00 | 3.63 | 6 | RXL33 | 037103459978 |
| HV1433DM | 037103108562 | Orange | 1"(25mm) | 33'(10m) Engineer's | A29 | 8.00 | 3.63 | 6 | - | - |
| HV1410CME | 037103108548 | Orange | 1"(25mm) | 33'(10m) | A30 | 8.00 | 3.63 | 6 | - | - |
| HV1049CME | 037103141552 | Orange | 1"(25mm) | 30'(9m) | A30 | 6.26 | 2.84 | 6 | - | - |
| HV1430 | 037103063342 | Orange | 1" | 30' | A5 | 6.26 | 2.84 | 6 | RY430 | 037103459862 |
| HV1425 | 037103039545 | Orange | 1" | 25' | A5 | 5.57 | 2.53 | 6 | RY425 | 037103457042 |
| HV1425D | 037103063359 | Orange | 1" | 25' Engineer's | A4 | 5.57 | 2.53 | 6 | - | - |
| HV1425ED | 037103142009 | Orange | 1" | 25' | A35 | 5.57 | 2.53 | 6 | - | - |
| HV1048CM | 037103105547 | Orange | 25mm | 8m | A9 | 5.57 | 2.53 | 6 | - | - |
| HV1048CME | 037103105554 | Orange | 1"(25mm) | 26'(8m) | A30 | 5.57 | 2.53 | 6 | - | - |
| HV1048DM | 037103085122 | Orange | 1"(25mm) | 25'(7.6m) Engineer's | A29 | 5.57 | 2.53 | 6 | - | - |
| HV1325 | 037103045881 | Orange | 3/4" | 25' | A2 | 4.40 | 2.00 | 6 | RY325 | 037103452351 |
| HV1038CME | 037103181046 | Orange | 3/4" | 26'(8m) | A30 | 4.40 | 2.00 | 6 | - | - |
| HV1325D | 037103063328 | Orange | 3/4" | 25' Engineer's | A4 | 4.40 | 2.00 | 6 | - | - |
| HV1316 | 037103045898 | Orange | 3/4" | 16' | A2 | 3.05 | 1.38 | 6 | RW316 | 037103452337 |
| HV1035CM | 037103089588 | Orange | 19mm | 5m | A9 | 3.05 | 1.38 | 6 | - | - |
| HV1035CME | 037103089595 | Orange | 3/4"(19mm) | 16'(5m) | A13 | 3.05 | 1.38 | 6 | RY35CME | 037103461018 |
| HV1312 | 037103045904 | Orange | 3/4" | 12' | A2 | 2.78 | 1.26 | 6 | R2312 | 037103060389 |
| HV1312D | 037103063335 | Orange | 3/4" | 12' Engineer's | A4 | 2.78 | 1.26 | 6 | - | - |
| HV1034CME | 037103141545 | Orange | 3/4"(19mm) | 13'(4m) | A13 | 2.78 | 1.26 | 6 | - | - |
| HV1034DM | 037103085139 | Orange | 3/4"(19mm) | 12'(3.7m) Engineer's | A29 | 2.78 | 1.26 | 6 | - | - |
| HV1012 | 037103063311 | Orange | 1/2" | 12' | A1 | 1.90 | 0.85 | 6 | RY212 | 037103450388 |
| HV1024CME | 037103141538 | Orange | 1/2"(13mm) | 13'(4m) | A13 | 1.90 | 0.85 | 6 | - | - |
| HV1010 | 037103063304 | Orange | 1/2" | 10' | A1 | 1.8 | 0.80 | 6 | RY210 | 037103450234 |
| HV1023CM | 037103089564 | Orange | 13mm | 3m | A9 | 1.8 | 0.80 | 6 | - | - |
| HV1023CME | 037103089571 | Orange | 1/2"(13mm) | 10'(3m) | A13 | 1.8 | 0.80 | 6 | RY23CME | 037103450241 |

Quikread® Power Return Tapes



QR1316

- Graduations printed in fractions and decimal equivalents to help you make quick readings
- Rounded blue case fits your hand for comfort
- Patented Lufkin Quad Hook® extends blade life by reducing blade breakage (1" only)
- Positive toggle lock holds blade securely at any length for accurate measurements
- Self-compensating end hook for inside and outside measurements
- Durable ABS case withstands rugged use on the job site
- Built in bumper reduces shock when blade is retracted, extending product life

| Cat. No. | UPC No. | Blade Size | | Blade Style | Pack Wt. | | Shelf Pack |
|----------|--------------|------------|--------|-------------|----------|------|------------|
| | | Width | Length | | lb | kg | |
| QR1312 | 037103169266 | 3/4" | 12' | A3 | 2.78 | 1.26 | 6 |
| QR1316 | 037103169259 | 3/4" | 16' | A3 | 3.05 | 1.38 | 6 |
| QR1425 | 037103152589 | 1" | 25' | A3 | 5.57 | 2.53 | 6 |

Power Return Tapes

Chrome and orange case



Y46CME

- Positive toggle lock holds blade securely at any length for accurate measurements
- Chrome or easy-to-find Hi-Viz® orange case finish available
- Self-compensating end hook for inside and outside measurements
- Patented Quad Hook® extends blade life by reducing blade breakage
- Built in bumper reduces shock when blade is retracted, extending product life

| Cat. No. | UPC No. | Blade Size | | Blade Style | Pack Wt. | | Shelf Pack |
|----------|--------------|------------|---------|-------------|----------|------|------------|
| | | Width | Length | | lb | kg | |
| HV420 | 037103104168 | 1" | 20' | A5 | 4.48 | 2.03 | 6 |
| HV46CME | 037103044990 | 1"(25mm) | 20'(6m) | A30 | 4.52 | 2.05 | 6 |
| Y420 | 037103104113 | 1" | 20' | A5 | 4.79 | 2.17 | 6 |
| Y46CME | 037103001047 | 1"(25mm) | 20'(6m) | A30 | 4.79 | 2.17 | 6 |
| HV116 | 037103039149 | 1" | 16' | A5 | 4.04 | 1.83 | 6 |

800 Series Xtra-wide Power Return Tapes

- 1-3/16" x 25' power return tape, orange case, cushion grip
- New blade design achieves 10' stand-out, make longer measurements
- Soft touch lock button for better feel and control
- Rubber cushion absorbs impact and improves grip
- Case designed to fit your hand
- Clearcoat blade protection - more durable markings
- 4-rivet reinforced end hook - increased strength for long blade life
- Non-slip slide lock for positive blade locking
- Easy on/off belt clip for fast attachment to belt



| Cat. No. | UPC No. | Blade Size | | Blade Style | Pack Wt. | | Shelf Pack |
|----------|--------------|------------|--------|-------------|----------|----|------------|
| | | Width | Length | | lb | kg | |
| XL8525 | 037103222923 | 1-3/16" | 25' | A5 | 4.4 | 2 | 8 |

700 Series Auto-lock

- Automatic blade lock holds the blade in extended position
- Recessed lock release to reduce chance of accidental retraction
- Non-slip co-molded rubber grip
- Durable clearcoat blade protection for longer blade life
- Steel reinforced end hook for longer service life
- Tough ABS case to stand up to the toughest work site



AL725

| Cat. No. | UPC No. | Blade Size | | Blade Style | Pack Wt. | | Shelf Pack |
|----------|--------------|------------|----------|-------------|----------|------|------------|
| | | Width | Length | | lb | kg | |
| AL725 | 037103214539 | 1" | 25' | A5 | 8.72 | 3.96 | 8 |
| AL748CME | 037103214546 | 1" | 26' (8m) | A13 | 8.72 | 3.96 | 8 |

700 Series Magnetic End Hook

- Magnetic end hook is a time-saver for framers, HVAC installers, and more
- Use for one-man measurements of steel framing and drop ceiling grids
- Powerful dual magnets can also serve as a pick-up tool
- Non-slip co-molded rubber grip
- Durable clearcoat blade protection for longer blade
- Steel reinforced end hook for longer service life
- Tough ABS case to stand up to the toughest work site



L725MAG

| Cat. No. | UPC No. | Blade Size | | Blade Style | Pack Wt. | | Shelf Pack |
|----------|--------------|------------|----------|-------------|----------|------|------------|
| | | Width | Length | | lb | kg | |
| L725MAG | 037103214560 | 1" | 25' | A5 | 8.72 | 3.96 | 8 |
| L748MAG | 037103214522 | 1" | 26' (8m) | A13 | 8.72 | 3.96 | 8 |

Lufkin

700 Series Auto-lock, Magnetic End Hook



- Automatic blade lock holds the blade in extended position
- Recessed lock release to reduce chance of accidental retraction
- Magnetic end hook is a time-saver for framers, HVAC installers, and more
- Powerful dual magnets can also serve as a pick-up tool
- Non-slip co-molded rubber grip
- Durable clearcoat blade protection for longer blade life
- Steel reinforced end hook for longer service life
- Tough ABS case to stand up to the toughest work site

| Cat. No. | UPC No. | Blade Size | | Blade Style | Pack Wt. | | Shelf Pack |
|----------|--------------|------------|--------|-------------|----------|----|------------|
| | | Width | Length | | lb | kg | |
| AL725MAG | 037103215666 | 1" | 25' | A5 | 4.4 | 2 | 4 |

L500 Series Power Return Tapes



- Lightweight, high strength, contour grip case fits comfortably in hand
- Hi-Viz® orange case - easy to find on the job
- Unique slide lock design allows for easy control of tape blade
- Wide base helps keep tape standing upright
- Removable belt clip
- Fits easily in most tape holsters
- Easy-to-read yellow clad blade (not replaceable)

L525

| Cat. No. | UPC No. | Blade Size | | Blade Style | Pack Wt. | | Shelf Pack |
|-----------|--------------|------------|----------|-------------|----------|-----|------------|
| | | Width | Length | | lb | kg | |
| L525 | 037103191069 | 1" | 25' | A5 | 4.90 | 2.2 | 6 |
| L525CME | 037103191090 | 1" | 26' (8m) | A13 | 4.90 | 2.2 | 6 |
| L516 | 037103191052 | 3/4" | 16' | A2 | 3.00 | 1.4 | 6 |
| L516CME | 037103191076 | 3/4" | 16' (5m) | A13 | 3.00 | 1.4 | 6 |
| L510 | 037103191045 | 1/2" | 10' | A1 | 1.80 | 0.8 | 6 |
| L510CME | 037103191083 | 1/2" | 10' (3m) | A13 | 1.80 | 0.8 | 6 |
| L525SCTMP | 037103207289 | 1" | 25' | A37 | 8.72 | 4.0 | 10 |
| QRL525MP | 037103195159 | 1" | 25' | A3 | 8.72 | 4.0 | 10 |

Mezurall™

- Chrome plated case (except for the Y8210 & Y8212 which have a black case)
- Yellow clad blade
- Available in widths of 1/2" and 3/4" and up to 12' in length
- Power retraction operation
- Belt clip



W928

| Cat. No. | UPC No. | Packed | Blade Size | | Blade Style | Pack Wt. | | Shelf Pack | Replacement Blade | UPC No. |
|----------|--------------|--------|------------|----------------|-------------|----------|-----|------------|-------------------|--------------|
| | | | Width | Length | | lb | kg | | | |
| W928 | 037103458728 | Carded | 1/2" | 8' | A1 | 1.25 | .56 | 6 | - | - |
| W9210 | 037103458735 | Carded | 1/2" | 10' | A1 | 1.5 | .67 | 6 | RY210 | 037103450234 |
| Y8210 | 037103457967 | Carded | 1/2" | 10' | A1 | 1.4 | .64 | 6 | - | - |
| W9212 | 037103458742 | Carded | 1/2" | 12' | A1 | 1.64 | .75 | 6 | RY212 | 037103450388 |
| W9312 | 037103458780 | Carded | 3/4" | 12' | A2 | 2.2 | 1.0 | 6 | RW312 | 037103452207 |
| W9312D | 037103458797 | Carded | 3/4" | 12' Engineer's | A4 | 2.2 | 1.0 | 6 | - | - |
| W9210ME | 037103458766 | Carded | 1/2"(13mm) | 10'(3m) | A11 | 1.5 | .67 | 6 | - | - |
| Y8212 | 037103457981 | Carded | 1/2" | 12' | A1 | 1.5 | .68 | 6 | RY212 | 037103127075 |

Mezurall™

- Ideal for industrial use
- Chrome plated case
- Hard chrome plated blade is tough and accurate
- Available in 1/2" width and 12' in length
- Power retraction operation

Chrome clad®



C9212

| Cat. No. | UPC No. | Blade Size | | Blade Style | Pack Wt. | | Shelf Pack |
|----------|--------------|------------|--------|-------------|----------|-----|------------|
| | | Width | Length | | lb | kg | |
| C9212X | 037103455574 | 1/2" | 12' | A6 | 1.45 | .66 | 6 |
| C9212 | 037103455567 | 1/2" | 12' | A8 | 1.45 | .66 | 6 |

Lufkin

Keyring Tape

- Strong key ring attached to chrome case
- Convenient for quick measurements
- Toggle lock is positioned for convenient operation
- Power retraction blade (not replaceable)
- Fits easily in pocket or purse

NEW PRODUCT



| Cat. No. | UPC No. | Blade Size | | Blade Style | Pack Wt. | | Shelf Pack |
|----------|--------------|------------|--------|-------------|----------|-----|------------|
| | | Width | Length | | lb | kg | |
| L503 | 037103195135 | 1/4" | 3' | A16 | 1.6 | 0.7 | 6 |

Pee Wee®



W6110

- Pocket size ideal for office or home
- High strength case, Yellow clad blade
- 1/4"/6mm wide blade is flexible; bold graduations on yellow background give quick accurate readings
- Power retraction operation
- W616BO is Hi-Viz® orange case; all other cases are black
- W618D blade is graduated 10ths and 100ths only, and black case only

| Cat. No. | UPC No. | Packed | Blade Size | | Blade Style | Pack Wt. | | Shelf Pack | Replacement Blade | UPC No. |
|----------|--------------|--------|------------|---------|-------------|----------|-----|------------|-------------------|---------|
| | | | Width | Length | | lb | kg | | | |
| Y613ME | 037103104106 | Carded | 1/4"(6mm) | 10'(3m) | A17 | .73 | .33 | 6 | - | - |
| W616 | 037103458575 | Carded | 1/4" | 6' | A16 | .55 | .25 | 6 | - | - |
| W6110 | 037103458544 | Carded | 1/4" | 10' | A16 | .77 | .35 | 6 | - | - |
| W616BO | 037103028624 | Carded | 1/4" | 6' | A16 | .55 | .25 | 6 | - | - |

Executive® Thinline



W606ME

- Convenient for office, briefcase, or pocket
- 6' easy-to-read blade
- Power retraction

| Cat. No. | UPC No. | Packed | Blade Size | | Blade Style | Pack Wt. | | Shelf Pack | Replacement Blade | UPC No. |
|----------|--------------|--------|------------|--------|-------------|----------|-----|------------|-------------------|---------|
| | | | Width | Length | | lb | kg | | | |
| W606 | 037103458551 | Boxed | 1/4" | 6' | A16 | .55 | .25 | 6 | - | - |
| W608 | 037103458568 | Boxed | 1/4" | 8' | A16 | .65 | .29 | 6 | - | - |
| W606ME | 037103458520 | Boxed | 1/4"(6mm) | 6'(2m) | A17 | .55 | .25 | 6 | - | - |

Executive® Diameter



W606P

- Designed for measuring diameters of pipe, cable, tire or any circular object
- Polished chrome case
- Zero falls in the same place on each side of the blade; conversion from diameter to circumference is made simply by turning the blade
- Model W606P shows diameter inches to 1/64ths; W606PD to 100ths, W606PM to millimeters
- Yellow clad blade
- Easy-to-read bold graduations on yellow background
- Spring action returns blade to case

| Cat. No. | UPC No. | Packed | Blade Size | | Blade Style | Pack Wt. | | Shelf Pack | Replacement Blade | UPC No. |
|----------|--------------|--------|------------|--------|-------------|----------|-----|------------|-------------------|--------------|
| | | | Width | Length | | lb | kg | | | |
| W606P | 037103458506 | Boxed | 1/4" | 6' | A18 | .55 | .25 | 6 | - | - |
| W606PD | 037103458513 | Boxed | 1/4" | 6' | A19 | .55 | .25 | 6 | RW06PD | 037103458605 |
| W606PM | 037103458537 | Boxed | 6mm | 2m | A20 | .55 | .25 | 6 | - | - |

Architect's Pocket Scale

- Yellow clad blade
- 1/4" yellow steel blade has jet black markings
- Manual or automatic return operation, but also features automatic blade return



| Cat. No. | UPC No. | Packed | Blade Size | | Blade Style | Pack Wt. | | Shelf Pack | Replacement Blade | UPC No. |
|----------|--------------|--------|------------|--------|-------------|----------|-----|------------|-------------------|---------|
| | | | Width | Length | | lb | kg | | | |
| W393 | 037103458483 | Boxed | 1/4" | 5' | A21 | 1.05 | .48 | 6 | - | - |

How to Change Short Tape Blades:

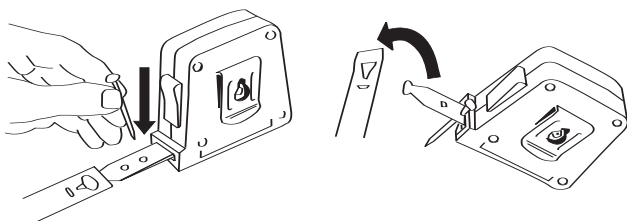

- 1) Pull old blade out past end until about 2" of bluish metal spring is exposed. Put a nail in round hole (A) in spring to hold it.
- 2) Note how old blade is attached, then remove it.
- 3) New blade is reverse wound, ready to attach to spring. With blade graduations up, turn spring sideways and insert from bottom into slot (B) in new blade. Twist spring and pull back until notches (C) lock at rear of slot (B).
- 4) Remove nail and return blade to case.

A1 Yellow Clad

- 1/2" width only
- Black and red markings one side only
- Graduated feet and inches to 1/16ths top edge
- Graduated inches to 1/16ths bottom edge, first 12 inches to 1/32nds
- Color blocks designate feet and 16" centers
- Instantaneous foot readings



A2 Yellow Clad

- 3/4" width only
- Black and red markings one side only
- Graduated feet and inches to 1/16ths top edge
- Graduated inches to 1/16ths bottom edge, first 12" to 1/32nds
- Color blocks designate feet and 16" centers
- Instantaneous foot readings

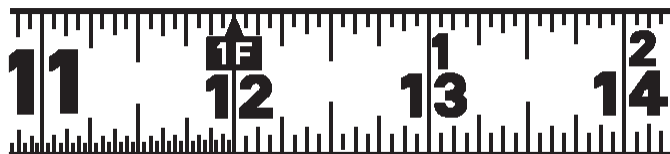

A3 Yellow Clad

- 3/4" and 1" widths
- Graduated feet and inches to 1/16ths top edge
- Vertical numbering
- Fractional and decimal equivalent marking

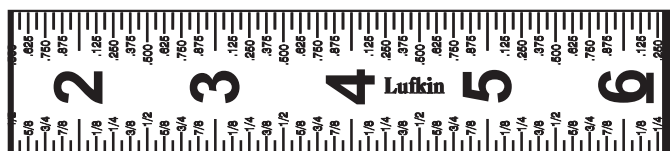

Lufkin

A4 Yellow Clad

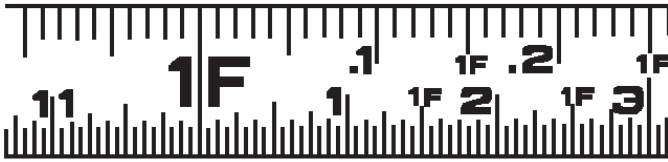

- 3/4" and 1" widths
- Graduated feet, 1/10ths and 1/100ths top edge; feet, inches and 1/16ths on bottom edge
- Instantaneous foot readings
- NOTE: 1" width has red and black markings; 3/4" has black markings only

A5 Yellow Clad



- 1-3/16" and 1" widths
- Black and red markings one side only
- Consecutive inches to 16ths
- Color blocks designate feet and 16" centers
- Truss marks every 19.2"
- Stud marks every 16"
- Instantaneous foot readings

A6 Chrome Clad®



- 1/2" width only
- Chrome Clad® blade
- Black markings one side only
- Graduated to 1/10ths of inches on both edges

A7 Yellow Clad



- 1/2" width only
- Black markings one side only
- Graduated to 1/10ths of inches on both edges with the first 6" on lower edge graduated to 1/50ths

A8 Chrome Clad®



- 1/2" width only
- Chrome Clad® blade
- Black markings one side only
- Graduated consecutive inches and 1/16ths on top and bottom edges

A9 Yellow Clad



- Available in 13mm, 19mm and 25mm widths
- Black and red markings one side only
- Both edges graduated to millimeters; numbered consecutive centimeters with larger red numbers at each decimeter

A11 Yellow Clad

- 1/2"/13mm width only
- Black and red markings one side only
- Upper edge graduated and numbered inches (no stud centers); lower edge to millimeters, numbered consecutive millimeters with red number at each decimeter



A12 Yellow Clad

- 3/4"/19mm width
- Black and red markings one side only
- Upper edge graduated and numbered inches (no stud centers); lower edge graduated in millimeters, numbered consecutive millimeters with red number at each decimeter
- Stud marks every 16" and 40cm

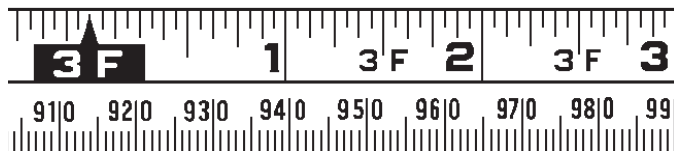

A13 Yellow Clad

- 1/2"/13mm and 3/4"/19mm widths
- Black and red markings one side only
- Metric one edge graduated to millimeters, numbered consecutive centimeters; English other edge to 1/16ths, continuous inches; feet and decimeters marked in red

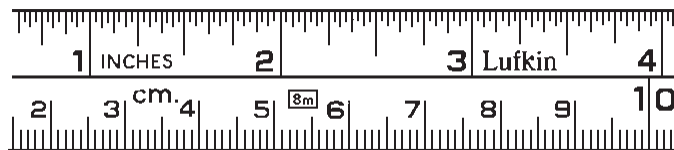

A16 Yellow Clad

- 1/4" width only
- Black markings one side only
- Consecutive inches to 1/16ths bottom edge, first 12" to 1/32nds; 16" centers designated by diamond; every 12th inch in red

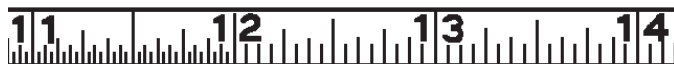

A17 Yellow Clad

- 1/4"/6mm width only
- Black markings one side only
- Upper edge graduated in inches to 1/16ths
- Lower edge graduated in millimeters, numbered in centimeters; 1 to 9 in each decimeter



A18 Yellow Clad

- 1/4" width only
- Black markings both sides
- Consecutive inches to 1/16ths, first 12" to 1/32nds on one side; diameter inches to 1/64ths other side; blank space ahead of zero

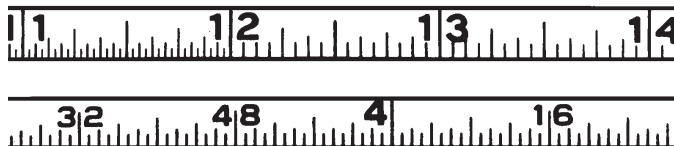

A19 Yellow Clad

- 1/4" width only
- Markings both sides
- Consecutive inches to 1/16ths, first 12" to 1/32nds on one side; diameter inches to 1/100ths other side; blank space ahead of zero



A20 Yellow Clad

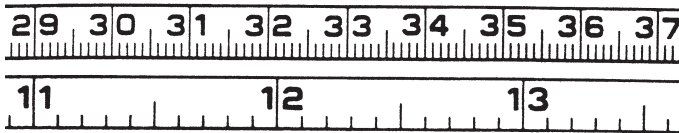

- 6mm width only
- Markings both sides
- Consecutive centimeters to millimeters one side; diameter to millimeters other side, numbered in centimeters

A21 Yellow Clad

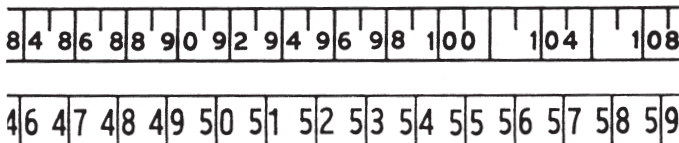

- 1/4" width only
- Black markings both sides
- One side marked 1/4th scale (1 to 240), other side has 1/8th scale (1 - 480)

A29 Yellow Clad

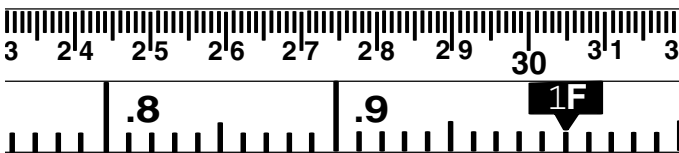

- 3/4"/19mm and 1"/25mm widths
- Black and red markings one side only
- Graduated millimeters on top edge and feet, 1/10ths and 1/100ths on bottom edge

A30 Yellow Clad

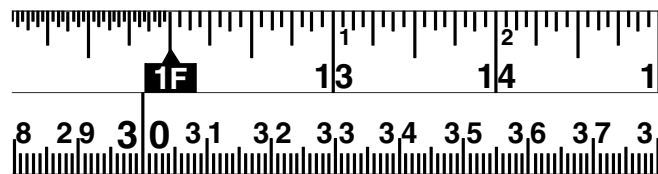

- 1"/25mm width only
- Markings one side only
- Metric one edge graduated to millimeters, numbered consecutive centimeters; English other edge to 1/16ths, first foot to 1/32nds, continuous inches plus consecutive inch marks within each foot from 1' mark. Truss marks every 19.2"

A31 Yellow Clad

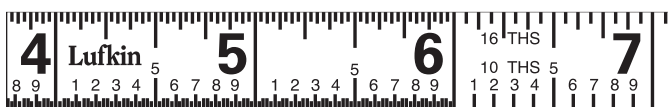

- 1/2" width only
- Yellow clad blade
- Black and red markings on one side only
- Graduated to 1/16ths on top edge, 1/10ths on bottom edge; first 6 inches graduated to 1/32nds on top edge, 1/50ths on bottom edge

A34 Yellow Clad

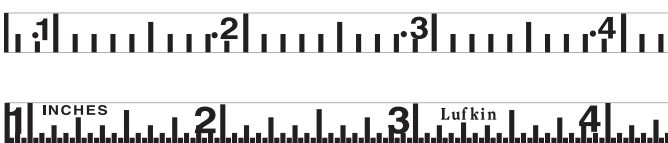

- 1/4" width only
- Yellow clad blade
- Graduated in 100ths of feet, numbered in 10ths of feet and feet

A35 Yellow Clad

- 1" width only
- Yellow clad blade
- Black and red markings one side only
- Graduated in feet, 1/10ths and 1/100ths of feet, numbered in feet and 10ths of feet

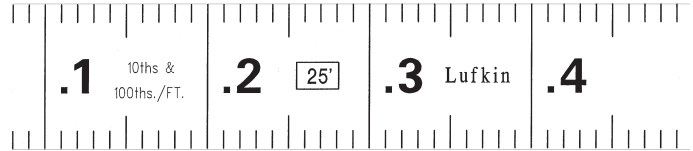

A36 Yellow Clad

- 1/2" width only
- Yellow clad blade
- Black and red markings one side only
- Top edge numbered every 10 millimeters with red print for every 100cm increment and graduations every millimeter. Bottom edge numbered in consecutive inches graduated in 10ths of an inch with first 12" graduated to 50ths and numbered in 10ths

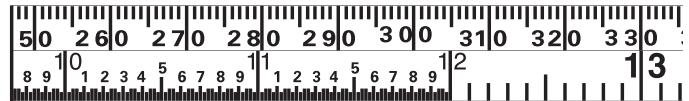

A37 Yellow Clad

- 1" width only
- Yellow clad blade
- Black and red markings one side only
- Top edge graduated to 16ths, and numbered in consecutive inches and fractional equivalents to eighths. The bottom edge with red print numbered at the mid-point of the measurement on the top edge

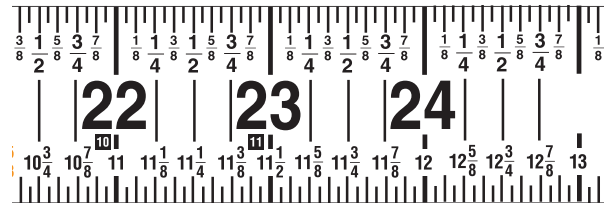

Long Tapes

Lufkin® tapes and rules are manufactured to comply with U.S. Government Specifications Board's requirements for accuracy. Our bench mark standards are certified by the N.I.S.T. Standard temperature for steel tapes is 68°F (20°C); coefficient of expansion for steel tapes is 0.00000645' per degree Fahrenheit/0.0000116' per degree Celsius. Standard tension for most long steel tapes, when fully supported throughout their entire length, is 10 lbs. Surveyor's tapes of heavy gauge steel when fully supported throughout their entire length is 10 lbs. up to 100', and 20 lbs. over 100' long. All Lufkin® steel tapes have a clear abrasive resistant protection to provide wear and corrosion resistance.

Long tapes

Prefixes

| | |
|---------|--------------------------|
| C- | Chrome Clad® |
| W or Y- | Yellow Clad |
| H- | Hook ring at zero |
| R- | Replacement blade |
| CD- | Chrome clad derrick |
| CN | Chrome Clad® and Nubian® |
| O- | Replacement blade |
| R- | Replacement blade |

Suffixes

| | |
|------|---|
| M- | Metric graduations |
| MM- | Metric graduations / millimeter numbering |
| MME- | Metric / English graduations |
| ME- | Metric / English graduations |
| D- | Feet / decimal feet graduations |
| DM- | Feet / decimal feet / Metric graduations |
| B- | Feet / decimal feet with add-on leader |
| C- | Consecutive inches to 1/16ths |
| CM- | Metric graduations / centimeter numbering |
| CME- | Metric / English graduations |
| CX- | Consecutive inches to 1/10ths of inches |

Anchor®



C213

- Rugged, vinyl-covered steel case
- Chrome Clad® blade
- Large easy-action winding drum and friction washers
- Nylon rollers guide the tape smoothly in and out of case

| Cat. No. | UPC No. | Packed | Blade Size | | Blade Style | Pack Wt. | | Shelf Pack | Replacement Blade | UPC No. |
|-------------|--------------|--------|------------|--------|-------------|----------|------|------------|-------------------|--------------|
| | | | Width | Length | | lb | kg | | | |
| C213 | 037103451408 | Boxed | 3/8" | 50' | B7 | 0.93 | 0.42 | 1 | -- | -- |
| C213C | 037103451514 | Boxed | 3/8" | 600" | B3 | 0.93 | 0.42 | 1 | - | - |
| C213CX | 037103451538 | Boxed | 3/8" | 600" | B4 | 0.93 | 0.42 | 1 | - | - |
| C213D | 037103451552 | Boxed | 3/8" | 50' | B5 | 0.93 | 0.42 | 1 | OC213D | 037103451569 |
| C216 | 037103451606 | Boxed | 3/8" | 100' | B7 | 1.64 | 0.74 | 1 | -- | -- |
| C21616THBLK | 037103451675 | Boxed | 3/8" | 100' | B2 | 1.64 | 0.74 | 1 | -- | -- |
| C216D | 037103451699 | Boxed | 3/8" | 100' | B5 | 1.64 | 0.74 | 1 | - | - |

Leader®

Lufkin



HC256

- Sturdy, rust-resistant steel case has a tough, black vinyl cover
- Chrome Clad® blade
- Jet-black markings are bonded to the steel and recessed below the hard chrome surface; highly resistant to wear, rust and heat
- Large easy action winding drum and friction washers
- Nylon roller guides the tape smoothly in and out of case
- Folding end hook ring

| Cat. No. | UPC No. | Packed | Blade Size | | Blade Style | Pack Wt. | | Shelf Pack | Replacement Blade | UPC No. |
|----------|--------------|--------|------------|--------|-------------|----------|------|------------|-------------------|---------|
| | | | Width | Length | | lb | kg | | | |
| HC253 | 037103452016 | Boxed | 3/8" | 50' | B7 | 0.93 | 0.42 | 1 | - | - |
| HC256 | 037103452061 | Boxed | 3/8" | 100' | B7 | 1.62 | 0.73 | 1 | - | - |

Challenge™

- Challenge™; Nubian® case, drum assembly and etched tape line are designed to perform for years
- Vinyl covered steel case
- Chrome Clad® blade
- Easy action winding drum and friction washers
- Nylon rollers guide the tape smoothly in and out of case
- “T” in the suffix of the number denotes a tree tape which is fitted with a special claw hook designed for anchoring in tree bark when measuring diameter; “P” in suffix denotes diameter



261PTH

| Cat. No. | UPC No. | Packed | Blade Size | | Blade Style | Pack Wt. | | Shelf Pack | Replacement Blade | UPC No. |
|----------|--------------|--------|------------|--------|-------------|----------|-----|------------|-------------------|--------------|
| | | | Width | Length | | lb | kg | | | |
| 261PTH | 037103451309 | Boxed | 3/8" | 33' | B11 | .70 | .32 | 1 | 0261PTH | 037103451293 |
| 263P | 037103452092 | Boxed | 3/8" | 50' | B11 | .93 | .42 | 1 | -- | -- |

Hi-Viz® Speedwinder®

- Impact-resistant, attractive, self-standing case
- Heavy duty yellow clad blade protected by an abrasion resistant coating; 0.008"/0.2mm thick
- New design extends, measures, rewinds in less time than conventional long steel tapes
- Easy-to-read bold black markings



Lufkin

| Cat. No. | UPC No. | Packed | Blade Size | | Blade Style | Pack Wt. | | Shelf Pack | Replacement Blade | UPC No. |
|----------|--------------|--------|------------|-----------------|-------------|----------|------|------------|-------------------|--------------|
| | | | Width | Length | | lb | kg | | | |
| HYT50 | 037103458155 | Boxed | 3/8" | 50' | B1 | 5.4 | 2.45 | 6 | - | - |
| HYT100 | 037103458162 | Boxed | 3/8" | 100' | B1 | 9.3 | 4.22 | 6 | - | - |
| HYT100D | 037103460196 | Boxed | 3/8" | 100' Engineer's | B5 | 9.3 | 4.22 | 6 | - | - |
| HYT15CME | 037103459411 | Boxed | 3/8"(10mm) | 50'(15m) | B14 | 5.4 | 2.45 | 6 | - | - |
| HYT30CME | 037103459428 | Boxed | 3/8"(10mm) | 100'(30m) | B14 | 9.3 | 4.22 | 6 | - | - |
| HYT50CME | 037103003461 | Boxed | 3/8"(10mm) | 164'(50m) | B14 | 9.8 | 4.45 | 6 | RHY50CME | 037103461476 |

Banner™



HW223

- Professional tradesman's quality
- Rugged, vinyl-covered steel case
- Yellow clad tape; .008"/0.2mm thick
- Large easy action winding drum and friction washers
- Nylon rollers guide the tape smoothly in and out of case
- Available in 3/8"/10mm width and up to 164'/50m length
- Bold graduations with black and red numbers for accurate measuring
- "H" prefix denotes product blade is fitted with a folding hook ring

| Cat. No. | UPC No. | Packed | Blade Size | | Blade Style | Pack Wt. | | Shelf Pack | Replacement Blade | UPC No. |
|----------|--------------|--------|------------|-----------|-------------|----------|------|------------|-------------------|---------|
| | | | Width | Length | | lb | kg | | | |
| HW223 | 037103458865 | Boxed | 3/8" | 50' | B1 | 5.8 | 2.63 | 6 | - | - |
| HW223D | 037103458902 | Boxed | 3/8" | 50' | B5 | .94 | .43 | 1 | - | - |
| HW223ME | 037103458889 | Boxed | 3/8"(10mm) | 50'(15m) | B9 | 5.8 | 2.63 | 6 | - | - |
| HW226 | 037103458940 | Boxed | 3/8" | 100' | B1 | 10.05 | 4.55 | 6 | - | - |
| HW226D | 037103458964 | Boxed | 3/8" | 100' | B5 | 1.67 | .76 | 1 | - | - |
| HW226ME | 037103458988 | Boxed | 3/8"(10mm) | 100'(30m) | B9 | 10.2 | 4.6 | 6 | - | - |
| HW227CME | 037103459039 | Boxed | 3/8"(10mm) | 164'(50m) | B8 | 2.51 | 1.14 | 1 | - | - |

Pro Series Long Steel Tape



- 3:1 gear ratio for fast blade retrieval
- Precise, easy to read black and red blade markings
- Premium steel blade resists kinks

| Cat. No. | UPC No. | Blade Size | | Blade Style | Pack Wt. | | Shelf Pack |
|----------|--------------|------------|--------|-------------|----------|-----|------------|
| | | Width | Length | | lb | kg | |
| PS100S | 037103201447 | 3/8" | 100' | B1 | 6.3 | 2.9 | 5 |

Home Shop

- Vinyl covered steel case
- Yellow clad blade
- .005" thick blade
- Large easy action winding drum with friction washers
- Fitted with a folding hook ring



HW100

| Cat. No. | UPC No. | Packed | Blade Size | | Blade Style | Pack Wt. | | Shelf Pack | Replacement Blade | UPC No. |
|----------|--------------|--------|------------|--------|-------------|----------|------|------------|-------------------|--------------|
| | | | Width | Length | | lb | kg | | | |
| HW50 | 037103458827 | Boxed | 3/8" | 50' | B1 | 4.65 | 2.07 | 6 | OY50 | 037103450715 |
| HW100 | 037103458841 | Boxed | 3/8" | 100' | B1 | 7.75 | 3.52 | 6 | OY100 | 037103451033 |

Hi-Viz® Universal Lightweight

- High impact Hi-Viz® orange polystyrene case
- Yellow clad blade .005"/0.13mm thick
- Easy wind nylon drum
- Easy-to-read black and red markings
- Hook ring is retained neatly in the contoured mouth of the case
- Removable belt clip
- All tapes are carded
- Metric-English tape measures have a 2-sided end hook for use with either scale



50

| Cat. No. | UPC No. | Color | Blade Size | | Blade Style | Pack Wt. | | Shelf Pack | Replacement Blade | UPC No. |
|----------|--------------|--------|------------|-----------|-------------|----------|-----|------------|-------------------|--------------|
| | | | Width | Length | | lb | kg | | | |
| 50 | 037103450685 | Orange | 3/8" | 50' | B1 | 3.4 | 1.5 | 6 | OY50 | 037103450715 |
| 100L | 037103451002 | Orange | 3/8" | 100' | B1 | 6.0 | 2.7 | 6 | OY100 | 037103451033 |
| HV15CME | 037103089632 | Orange | 3/8"(10mm) | 50'(15m) | B8 | 3.4 | 1.5 | 6 | RY15CME | 037103094995 |
| HV30CME | 037103089656 | Orange | 3/8"(10mm) | 100'(30m) | B8 | 6.0 | 2.7 | 6 | RY30CME | 037103095015 |

Artisan® Diameter and Tree Tapes



C120TP

- Rugged, vinyl-covered steel case
- Chrome Clad® and Nubian® blade
- .008" thick blade
- Large easy winding drum and friction washers
- Nylon rollers guide the tape smoothly in and out of case
- "T" in the suffix denotes a tree tape which is fitted with a special claw hook designed for anchoring in tree bark
- "P" in number suffix denotes diameter

| Cat. No. | UPC No. | Packed | Blade Size | | Blade Style | Pack Wt. | | Shelf Pack | Replacement Blade | UPC No. |
|----------|--------------|--------|------------|------------|-------------|----------|-----|------------|-------------------|--------------|
| | | | Width | Length | | lb | kg | | | |
| 120TP | 037103451101 | Boxed | 3/8" | 20' | B10 | .56 | .25 | 1 | - | - |
| C120TP | 037103451125 | Boxed | 3/8" | 20' | B10 | .56 | .25 | 1 | - | - |
| 120P | 037103451088 | Boxed | 3/8" | 240 Inches | B12 | .56 | .25 | 1 | O120P | 037103451095 |
| C106PM | 037103060273 | Boxed | 10mm | 6.5m | B15 | .56 | .25 | 1 | - | - |
| C106TPM | 037103060266 | Boxed | 10mm | 6.5m | B15 | .56 | .25 | 1 | RC106TPM | 037103079749 |

B1 Yellow Clad

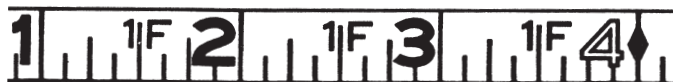

- 3/8" width only
- Yellow clad blade
- Black and red markings one side only
- Graduated feet and inches to 1/8ths with instantaneous readings; 16" centers indicated by a diamond

B2 Chrome Clad®



- 3/8" width only
- Chrome Clad® blade
- Black markings one side only
- Graduated feet and inches to 1/16ths with instantaneous readings

B3 Chrome Clad and Nubian®



- 3/8" width only
- Chrome Clad® and Nubian® blade
- Black markings one side only
- Graduated consecutive inches to 1/16ths

B4 Chrome Clad®

- 3/8" width only
- Chrome Clad® blade
- Black markings one side only
- Graduated consecutive inches to 1/10ths

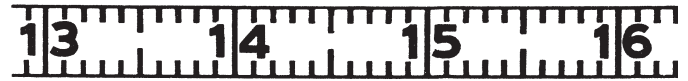

B5 Chrome Clad® and Yellow Clad

- 3/8" width only
- Chrome Clad® and yellow clad blade
- Black markings one side only
- Graduations feet to 1/10ths and 1/100ths



B7 Chrome Clad® and Nickel Clad

- 3/8" width only
- Chrome Clad®, nickel clad and yellow clad blade
- Black markings one side only
- Graduated feet and inches to 1/8ths with instantaneous readings; 16" centers indicated by diamond



B8 Yellow Clad

- 3/8" width only
- Yellow clad blade
- Black and red markings both sides
- Bottom side graduated millimeters, numbered in centimeters and meters
- Top side graduated feet and inches to 1/8ths with instantaneous readings; 16" centers indicated by a diamond

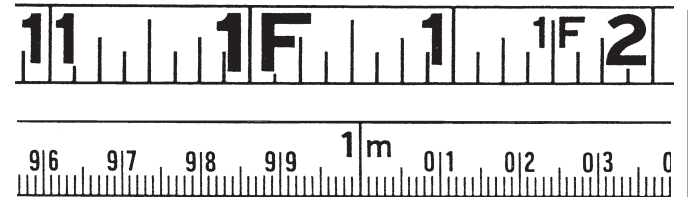

Lufkin

B9 Yellow Clad

- 3/8"/10mm width only
- Yellow clad blade
- Black and red markings both sides
- One side graduated feet and inches to 1/8ths with instantaneous readings; other side graduated in consecutive millimeters with instantaneous meter numbers at every 100mm



B10 Nubian® and Chrome Clad®

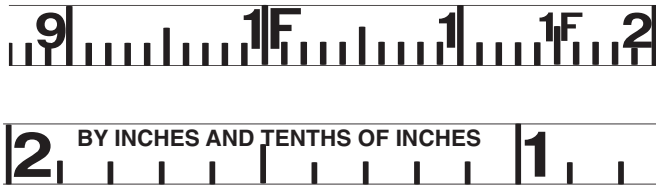

- 3/8" width only
- Nubian® and Chrome Clad® blade
- Markings both sides
- One side graduated 1/10ths and 1/100ths of feet; other side diameter feet and 1/10ths of inches

B11 Nubian®



- 3/8" width only
- Nubian® blade
- Markings both sides
- Graduated feet, inches and 1/8ths one side; other side graduated diameter feet and inches with an extra diameter inch subdivided to 64ths left hand

B12 Nubian®



- 3/8" width only
- Nubian® blade
- Markings both sides
- Graduated consecutive inches to 1/16ths one side; other side to diameter inches, with an extra diameter inch subdivided to 64ths left hand

B14 Yellow Clad and Chrome Clad®

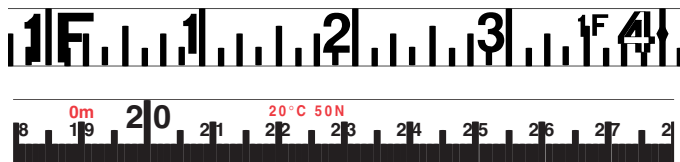

- 3/8" width
- Yellow clad and Chrome Clad® blade
- Black and red markings both sides
- Front side graduated in feet and inches to 1/8ths; back side in meters and millimeters numbered in centimeters

B15 Chrome Clad®

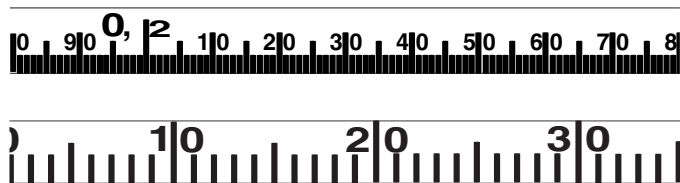

- 10mm width
- Yellow clad and Chrome Clad® blade
- Marked both sides
- One side meters, decimeters and millimeters; other side reads diameter from circumference to 2m of diameter in millimeters

General Information

- Designed for rugged field use by the surveyor, engineer or contractor
- More accurate than tolerances established by the National Bureau of Standards when fully supported with standard tension of 4.5lbs.
- Tape stretches 0.0011"/ foot per additional pound of tension over 4.5lbs.
- Durable, waterproof and able to withstand breakage and abrasion under extreme conditions
- Non-conductive construction material allows safe use around electrical hazards

Pro Series Fiberglass Tapes

- Super fast 3 to 1 ratio retrieval
- Heavy duty fiberglass blade, twice the stretch resistance of ordinary blade
- Bumper protected end hook
- Proven Lufkin quality
- Hi-Viz® orange case

**NEW
PRODUCT**



PS1708

| Cat. No. | UPC No. | Blade Size | | Blade Style | Pack Wt. | | Shelf Pack |
|----------|--------------|------------|--------|-------------|----------|-----|------------|
| | | Width | Length | | lb | kg | |
| PS1706 | 037103194732 | 1/2" | 100' | C10 | 2.4 | 1.1 | 2 |
| PS1708 | 037103194671 | 1/2" | 200' | C10 | 3 | 1.4 | 2 |
| PS1709 | 037103194688 | 1/2" | 300' | C10 | 4 | 1.8 | 2 |

Hi-Viz® Linear Reel

- Line does not collect dirt in case
- Lightweight open reel is easy to handle and rewind
- Hi-Viz® orange case



1703



1706

| Cat. No. | UPC No. | Packed | Blade Size | | Blade Style | Pack Wt. | | Shelf Pack | Replacement Blade | UPC No. |
|-----------|--------------|--------|------------|-----------|-------------|----------|------|------------|-------------------|--------------|
| | | | Width | Length | | lb | kg | | | |
| 1703 | 037103454621 | Carded | 1/2" | 50' | C1 | 0.75 | .34 | 1 | 0703L | 037103453532 |
| 1703D | 037103454638 | Carded | 1/2" | 50' | C2 | 0.75 | .34 | 1 | 0703D | 037103453556 |
| 1706 | 037103454645 | Carded | 1/2" | 100' | C1 | 1.2 | .54 | 1 | 0706L | 037103453570 |
| 1706D | 037103454652 | Carded | 1/2" | 100' | C2 | 1.2 | .54 | 1 | 0706D | 037103453594 |
| HY1715CME | 037103458254 | Carded | 1/2"(13mm) | 50'(15m) | C4 | .75 | .34 | 1 | - | - |
| HY1730CM | 037103458209 | Carded | 13mm | 30m | C3 | 1.2 | .54 | 1 | - | - |
| HY1730CME | 037103458261 | Carded | 1/2"(13mm) | 100'(30m) | C4 | 1.2 | .54 | 1 | - | - |
| HY1730DM | 037103127624 | Carded | 1/2"(13mm) | 100'(30m) | C7 | 6.00 | 2.72 | 6 | - | - |

Hi-Viz® Linear Reel



- Lightweight open reel is easy to handle and rewind; line does not collect dirt in case
- Hi-Viz® orange case

1707

| Cat. No. | UPC No. | Packed | Blade Size | | Blade Style | Pack Wt. | | Shelf Pack | Replacement Blade | UPC No. |
|-----------|--------------|--------|------------|-----------|-------------|----------|------|------------|-------------------|--------------|
| | | | Width | Length | | lb | kg | | | |
| 1707 | 037103454669 | Carded | 1/2" | 150' | C1 | 3.75 | 1.7 | 2 | 01707 | 037103454676 |
| 1707D | 037103454683 | Carded | 1/2" | 150' | C2 | 4.03 | 1.83 | 2 | 01707D | 037103454690 |
| HY1750CM | 037103458216 | Carded | 13mm | 50m | C3 | 4.15 | 1.88 | 2 | - | - |
| HY1750CME | 037103458278 | Carded | 1/2"(13mm) | 164'(50m) | C4 | 4.15 | 1.88 | 2 | - | - |
| 1708 | 037103460318 | Carded | 1/2" | 200' | C1 | 4.45 | 2.02 | 2 | - | - |
| 1708D | 037103460325 | Carded | 1/2" | 200' | C2 | 4.45 | 2.02 | 2 | 01708D | 037103460349 |
| HY1760CME | 037103127525 | Carded | 1/2"(13mm) | 200'(60m) | C4 | 4.23 | 1.92 | 2 | - | - |

Lufkin

Hi-Viz® Linear Reel



- Sturdy open case
- Long handle for fast and effortless rewinding
- Hi-Viz® orange case

1709

| Cat. No. | UPC No. | Packed | Blade Size | | Blade Style | Pack Wt. | | Shelf Pack | Replacement Blade | UPC No. |
|------------|--------------|--------|------------|------------|-------------|----------|------|------------|-------------------|---------|
| | | | Width | Length | | lb | kg | | | |
| 1709 | 037103460356 | Carded | 1/2" | 300' | C1 | 7.00 | 3.18 | 2 | - | - |
| 1709D | 037103460363 | Carded | 1/2" | 300' | C2 | 6.55 | 2.96 | 2 | - | - |
| HY17100CME | 037103127563 | Carded | 1/2"(13mm) | 328'(100m) | C4 | 7.38 | 3.35 | 2 | - | - |

C1 Yellow Clad

- 1/2" width only
- Yellow clad blade
- Black and red markings one side only
- Graduated feet and inches to 1/8ths; numbered with feet and instantaneous foot markings in red and inches in black



C2 Yellow Clad

- 1/2" width only
- Yellow clad blade
- Black and red markings one side only
- Graduated feet to 1/10ths and 1/100ths; numbered with feet in red and 1/10ths of feet in black



C3 Yellow Clad

- 13mm width only
- Yellow clad blade
- Black and red markings one side only
- Graduated millimeters, numbered at each centimeter with red instantaneous meter number



C4 Yellow Clad

- 1/2"/13mm width only
- Yellow clad blade
- Black and red markings on both sides
- Two-sided tapeline; top side in feet, inches, and 1/8ths, numbered at each foot with red instantaneous foot numbers; bottom side graduated in millimeters, numbered centimeters with red instantaneous meter number

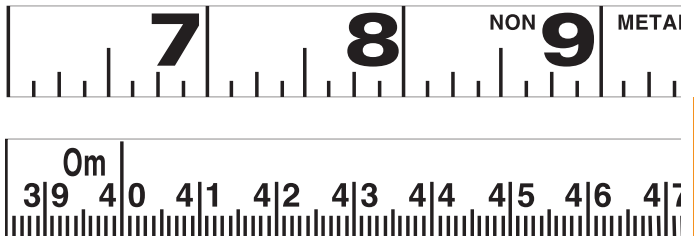

C7 Yellow Clad

- 1/2"/13mm width only
- Yellow clad blade
- Black and red markings on both sides
- Two-sided tapeline; bottom side in metric, graduated in millimeters, numbered in centimeters, with red instantaneous meter number; top side graduated feet to 1/10ths and 1/100ths, numbered with feet in red and 10ths of feet in black

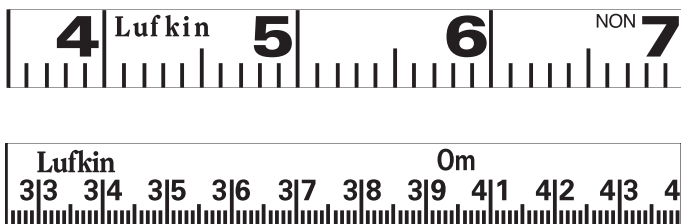

C10 Yellow Clad and White Clad

- 1/2" width only
- White on top, yellow on bottom
- Black and red markings both sides
- Two-sided tapeline; top side in feet and inches graduated to 8ths, numbered in inches and at each foot; bottom side graduated feet to 100ths of feet, and numbered in tenths of feet

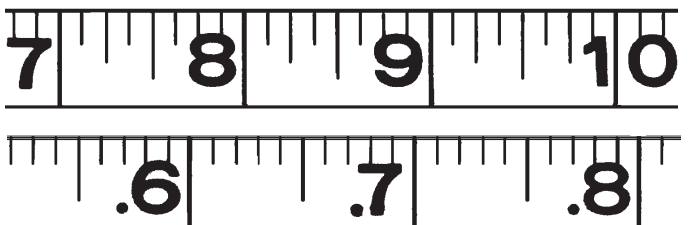

Hi line® Tapes



- Synthetic Fiber blade is non-conductive
- Steel case with vinyl covering
- 50 and 100ft, feet and tenths and 100ths of feet
- Ring or hook attached on end



HD403

| Cat. No. | UPC No. | Blade Size | | Blade Style | Pack Wt. | | Shelf Pack |
|----------|--------------|------------|--------|-------------|----------|-----|------------|
| | | Width | Length | | lb | kg | |
| HD403 | 037103202369 | 5/8" | 50' | C5 | 12.0 | 5.4 | 12 |
| HD403D | 037103202352 | 5/8" | 50' | C6 | 12.0 | 5.4 | 12 |
| HD406 | 037103202338 | 5/8" | 100' | C5 | 16.8 | 7.6 | 12 |
| HD406D | 037103202321 | 5/8" | 100' | C6 | 16.8 | 7.6 | 12 |
| HDH406 | 037103202376 | 5/8" | 100' | C5 | 16.8 | 7.6 | 12 |
| HDH406D | 037103202383 | 5/8" | 100' | C6 | 16.8 | 7.6 | 12 |

C5 White Clad



- White clad blade
- 5/8" width
- Black and red markings one side only
- Graduated feet and inches to 1/8ths, red feet numbers and black inch numbers

C6 White Clad

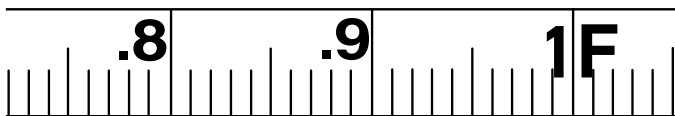

- White clad blade
- 5/8" width
- Black and red markings one side only
- Graduated feet to 1/10ths and 1/100ths, red feet numbers and black tenths of feet numbers

Oil Gauging

- Chrome Clad® for dark (heavy oils)
- Nubian® for light (clear oils)
- "Double Duty" oil gauging tapes with both Chrome Clad® and Nubian® (black) for dark (heavy) and light (clear) oils
- Made of heavy gauge 1/2" (13mm) x .012" (0.3mm) steel
- Snap-swivel hook on front end of tape for a plumb bob
- Two arm reels for short lengths; four arm reels for 30m/100' lengths
- Large drums and winding handles for quick and easy rewinding
- Handle folds over for storage and to lock line at extended position

Plumb Bobs are not supplied with tapes. The last part of the catalog number denotes the style of the bob the tape is made to accept. Lufkin Oil Gaging Tapes and Plumb Bobs are manufactured to comply with American Petroleum Institute (API) Standard 2545 and American Society for Testing & Materials (ASTM) Standard D 1085. These standards are the same and refer to the method of Gauging Petroleum and Petroleum Products.

1. Never gauge a tank during an electrical storm.
2. Ground yourself and your tools by touching the tank ladder before climbing the ladder. Do not wear gloves when grounding yourself. Gloves prevent proper grounding.
3. Ground yourself before opening the gauging hatch by touching the handrail or platform (without gloves on). During and after removal of the gauging cover, stand so that the gas will not be inhaled. Wear a gas mask if toxic gases are present.
4. Always maintain contact between the gauging tape and the edge of the hatch from the moment the gauge bob enters the hatch until the gauge bob is removed from the hatch.

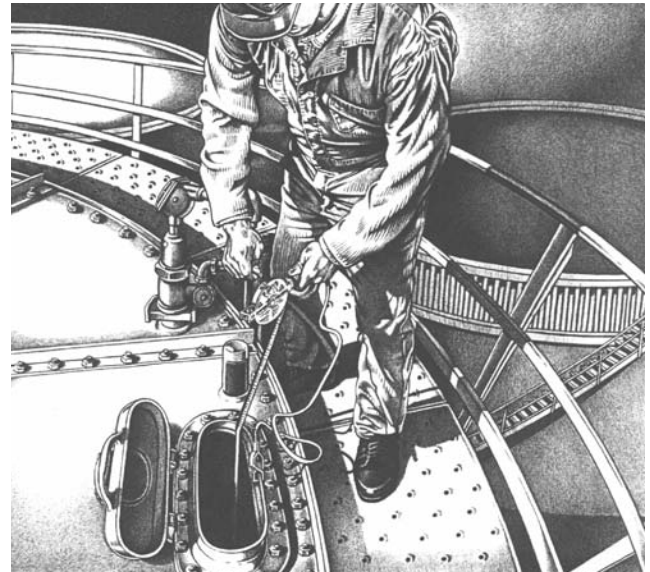

Atlas® Chrome Clad® / Nubian® Double Duty

- Black markings bonded to steel and recessed beneath multiple layers of nickel and chrome electroplating provides greater resistance to wear and corrosion
- All tapes read right to left
- Heavy-duty frame designed for years of rugged use
- All frames include a grounding strap
- Plumb bob must be ordered separately



Lufkin

| Cat. No. | Bob Cut | UPC No. | Packed | Blade Size | | Blade Style | Pack Wt. | | Shelf Pack | Replacement Blade | UPC No. |
|-----------------|---------|--------------|--------|------------|-----------|-------------|----------|------|------------|-------------------|--------------|
| | | | | Width | Length | | lb | kg | | | |
| CN129012SF590 | 590 | 037103459527 | Boxed | 1/2" | 18' | D1 | 1.25 | .57 | 1 | OCN129012SF590 | 037103459633 |
| CN1290SF590 | 590 | 037103459534 | Boxed | 1/2" | 25' | D1 | 1.51 | .68 | 1 | OCN1290SF590 | 037103459640 |
| CN1290SMEF590 | 590 | 037103001696 | Boxed | 1/2"(13mm) | 25'(8m) | D3 | 1.51 | .68 | 1 | - | - |
| CN1291SF590 | 590 | 037103459541 | Boxed | 1/2" | 33' | D1 | 1.65 | .75 | 1 | OCN1291SF590 | 037103459657 |
| CN1293SF58712 | 5871/2 | 037103459763 | Boxed | 1/2" | 50' | D1 | 2.07 | .94 | 1 | - | - |
| CN1293SF590 | 590 | 037103459558 | Boxed | 1/2" | 50' | D1 | 2.07 | .94 | 1 | OCN1293SF590 | 037103459664 |
| CN1293SDF590 | 590 | 037103459596 | Boxed | 1/2" | 50' | D2 | 2.07 | .94 | 1 | - | - |
| CN1293SMEF590 | 590 | 37103459602 | Boxed | 1/2"(13mm) | 50'(15m) | D3 | 2.07 | .94 | 1 | OCN1293SMEF590 | 037103459718 |
| CN1294SF58712 | 5871/2 | 037103459770 | Boxed | 1/2" | 66' | D1 | 2.38 | 1.08 | 1 | - | - |
| CN1294SF590 | 590 | 037103459565 | Boxed | 1/2" | 66' | D1 | 2.38 | 1.08 | 1 | OCN1294SF590 | 037103459671 |
| CN1294SMEF590 | 590 | 037103459619 | Boxed | 1/2"(13mm) | 66'(20m) | D3 | 2.38 | 1.08 | 1 | OCN1294SMEF590 | 037103459725 |
| CN1295SF590 | 590 | 037103459572 | Boxed | 1/2" | 75' | D1 | 2.57 | 1.17 | 1 | OCN1295SF590 | 037103459688 |
| CN1295SMEF58712 | 5871/2 | 037103440815 | Boxed | 1/2"(13mm) | 75'(23m) | D3 | 2.57 | 1.17 | 1 | - | - |
| CN1295SMEF590 | 590 | 037103122124 | Boxed | 1/2"(13mm) | 75'(23m) | D3 | 2.88 | 1.31 | 1 | OCN1295SME590 | 037103122117 |
| CN1296SF590 | 590 | 037103459589 | Boxed | 1/2" | 100' | D1 | 3.4 | 1.54 | 1 | OCN1296SF590 | 037103459695 |
| CN1296SMEF590 | 590 | 037103459626 | Boxed | 1/2"(13mm) | 100'(30m) | D3 | 3.46 | 1.57 | 1 | OCN1296SMEF590 | 037103459732 |
| CN1298SMEF590 | 590 | 037103104243 | Boxed | 1/2"(13mm) | 125'(38m) | D3 | 3.89 | 1.76 | 1 | - | - |

Atlas® Chrome Clad®



- Black markings bonded to steel and recessed beneath multiple layers of nickel and chrome electroplating provides greater resistance to wear and corrosion
- All tapes read right to left
- Heavy-duty frame designed for years of rugged use
- All frames include a grounding strap
- Plumb bob must be ordered separately

| Cat. No. | Bob Cut | UPC No. | Packed | Blade Size | | Blade Style | Pack Wt. | | Shelf Pack | Replacement Blade | UPC No. |
|---------------|---------|--------------|--------|------------|-----------|-------------|----------|------|------------|-------------------|--------------|
| | | | | Width | Length | | lb | kg | | | |
| C12901/2SF590 | 590 | 037103454065 | Boxed | 1/2" | 18' | D4 | 1.35 | .61 | 1 | OC12901 / 2SF590 | 037103454072 |
| C1290SF590 | 590 | 037103454102 | Boxed | 1/2" | 25' | D4 | 1.51 | .68 | 1 | OC1290SF590 | 037103454119 |
| C1291SF590 | 590 | 037103454140 | Boxed | 1/2" | 33' | D4 | 1.65 | .75 | 1 | OC1291SF590 | 037103454157 |
| C1293SF590 | 590 | 037103454256 | Boxed | 1/2" | 50' | D4 | 2.07 | .94 | 1 | OC1293SF590 | 037103454263 |
| C2910MME590GM | 590GM | 037103063373 | Boxed | 1/2"(13mm) | 33'(10m) | D6 | 1.65 | .75 | 1 | OC2910MME590GM | 037103046772 |
| C2915MME590GM | 590GM | 037103091406 | Boxed | 1/2"(13mm) | 50'(15m) | D6 | 2.07 | .94 | 1 | - | - |
| C2920MME590GM | 590GM | 037103003386 | Boxed | 1/2"(13mm) | 66'(20m) | D6 | 2.38 | 1.08 | 1 | - | - |
| C2930MME590GM | 590GM | 037103089236 | Boxed | 1/2"(13mm) | 100'(30m) | D6 | 3.45 | 1.56 | 1 | - | - |
| C2920MME150MM | 150MM | 037103047168 | Boxed | 1/2"(13mm) | 66'(20m) | D6 | 2.38 | 1.08 | 1 | - | - |

Atlas® Nubian®



- Ideal for gauging clear oils
- Etched background
- Blade protected by flowed-on epoxy coating
- Raised bright steel markings are clearly legible
- All tapes read right to left
- Heavy-duty frame designed for years of rugged use
- All frames include a grounding strap
- Plumb bob must be ordered separately

| Cat. No. | Bob Cut | UPC No. | Packed | Blade Size | | Blade Style | Pack Wt. | | Shelf Pack | Replacement Blade | UPC No. |
|-----------|---------|--------------|--------|------------|--------|-------------|----------|-----|------------|-------------------|--------------|
| | | | | Width | Length | | lb | kg | | | |
| 1290SF590 | 590 | 037103454089 | Boxed | 1/2" | 25' | D5 | 1.51 | .68 | 1 | O1290SF590 | 037103454096 |
| 1291SM590 | 590 | 037103441669 | Boxed | (13mm) | (10m) | D7 | 1.65 | .75 | 1 | - | - |
| 1293SF590 | 590 | 037103454201 | Boxed | 1/2" | 50' | D5 | 2.07 | .94 | 1 | O1293SF590 | 037103454218 |
| 1293SM590 | 590 | 037103441676 | Boxed | (13mm) | (15m) | D7 | 2.07 | .94 | 1 | - | - |

Atlas® Stainless Steel

- Designed for use in highly corrosive solutions
- Stainless steel blade resists corrosion
- Heavy-duty frame designed for years of rugged use
- All frames include a grounding strap
- Plumb bob must be ordered separately



| Cat. No. | Bob Cut | UPC No. | Packed | Blade Size Width | Blade Size Length | Blade Style | Pack Wt. lb | Pack Wt. kg | Shelf Pack | Replacement Blade | UPC No. |
|-----------|---------|--------------|--------|------------------|-------------------|-------------|-------------|-------------|------------|-------------------|--------------|
| S1291F590 | 590 | 037103440839 | Boxed | 1/2" | 33' | D4 | 1.65 | .75 | 1 | OS1291F590 | 037103440846 |
| S1293F590 | 590 | 037103456823 | Boxed | 1/2" | 50' | D4 | 1.73 | .78 | 1 | OS1293F590 | 037103454287 |

D1 Chrome Clad® and Nubian®

- 1/2" width only
- Markings one side only
- Graduated instantaneous feet and inches to 1/8ths



D2 Chrome Clad® and Nubian®

- 1/2" width only
- Markings one side only
- Graduated in feet to 1/10ths and 1/100ths of an inch; reads right to left



D3 Chrome Clad® and Nubian®

- 1/2"/13mm width only
- Markings both sides
- Graduated in millimeters on one side; other side instantaneous feet and inches to 1/8ths

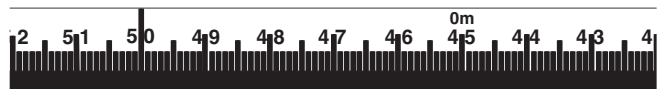

D4 Chrome Clad®, and Stainless Steel



- 1/2" width only
- Markings one side only
- Graduated feet and inches to 1/8ths; instantaneous foot readings

D5 Nubian®



- 1/2" width only
- Nubian® blade
- Markings one side only
- Graduated feet and inches to 1/8ths; instantaneous foot readings

D6 Chrome Clad®

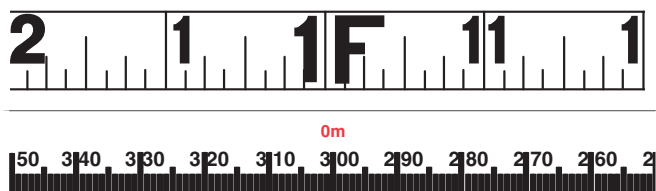

- 1/2"/13mm width
- Chrome Clad® blade
- Black and red markings on metric side
- Metric - graduated meters to millimeters; numbered right to left in meters and millimeters
- English side - graduated feet and inches to 1/8ths; numbered right to left

D7 Nubian®



- 1/2" width only
- Nubian® blade
- Graduated in meters; numbered in millimeters

Oil Gauging

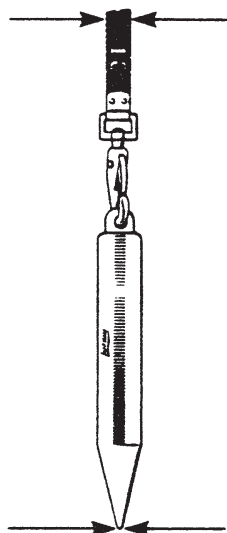

It takes more than a quality gauging tape, it takes a smart user. Every time you use a Lufkin oil gauging tape, follow proper grounding techniques. Ground your body. Ground your gear. And always use a grounding strap. Lufkin oil gauging tapes come complete with a grounding strap and an ESD handle, and are in full compliance with all current and proposed American Petroleum Institute standards. Achieve a solid ground every time. Use Lufkin oil gauging tapes, and follow proper grounding procedures.

How to Measure an Inage Plumb Bob

Tapes cut and fitted with the swivel snap to be used with the 588 and 590 plumb-bobs are known as inage gauging tapes. When the plumb bobs are assembled to the swivel snap the zero point is at the bottom of the plumb bob. When being used, the plumb bob and tape are lowered until the bob contacts the bottom of the tank. When the tape is reeled in, the liquid line is read on the tape line itself, thereby showing you the contents of the tank.

Inage Oil Gauging Plumb Bobs

- For use in heavy oils
- 20-ounce, except for 588 (6oz.)
- Cylindrical shaped
- Tapered point tip
- Solid brass or stainless steel bob

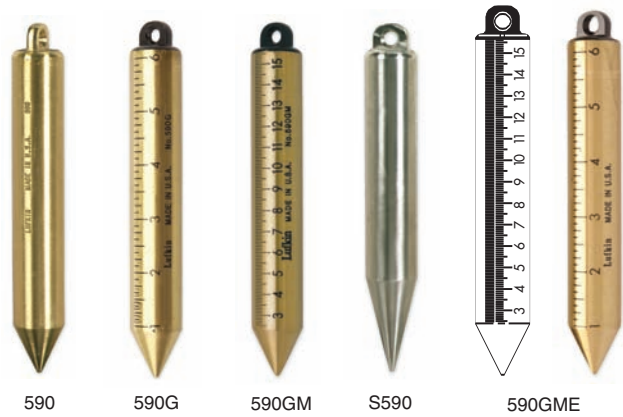

| Cat. No. | UPC No. | Description | Shelf Pack |
|----------|--------------|---|------------|
| 590 | 037103453204 | 20oz. solid brass inage Plumb bob cylindrical shape, 1" x 6 3/4" | 1 |
| 590G | 037103453235 | 20oz. solid brass bob; graduated in inches to 1/8ths, reading upward; blunt point | 1 |
| 590GM | 037103453242 | 20oz. solid brass bob; graduated millimeters with centimeters numbered | 1 |
| 590GME | 037103442895 | 20oz. solid brass bob; graduated in inches to 1/8ths, reading upward | 1 |
| S590 | 037103460134 | 20oz. cylindrical shape stainless steel bob, 1" x 6 3/4" | 1 |

How To Measure With an Outage Plumb Bob

Tapes which have the swivel snap fitted so as to accommodate the 5871/2 plumb bob are known as outage tapes. When the 5871/2 plumb bob is assembled to the tape line the zero point is at the intersection of the swivel snap and the plumb bob. When using outage gauging tapes the tape is lowered into the tank until the plumb bob just penetrates the liquid. The tape is then rewound and the liquid level is read right off the plumb bob. The reading on the plumb bob is added to the tape reading giving the total outage (how much liquid has been removed from the tank).

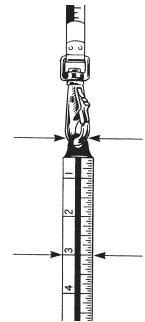

Lufkin

Outage Oil Gauging Plumb Bob

- 15oz., square shaped solid brass bob
- Eye milled from solid brass block (not removable)
- 3/4"/19mm square, 6"/152mm overall length
- Graduated in inches to 1/16ths, or metric top to bottom, zero falls inside top of hook eye

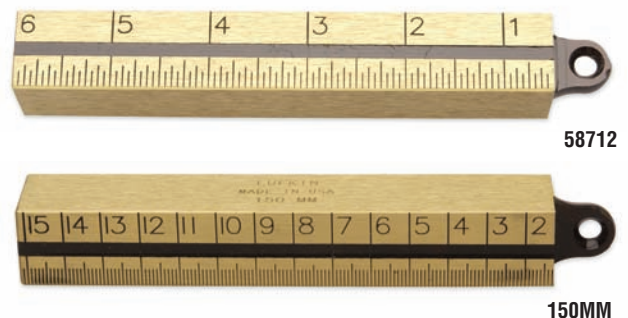

| Cat. No. | UPC No. | Description | Shelf Pack |
|----------|--------------|------------------------------------|------------|
| 58712 | 037103453181 | 15oz. solid brass outage plumb bob | 12 |
| 150MM | 037103105875 | 540g. brass outage plumb bob | 12 |

Steel Tape Line Accuracy

Lufkin® steel tapes are made to government standards. Our bench standards for the United States are certified accurate by the United States Department of Commerce, N.I.S.T. Tapes for Canada are made to Canadian government standards.

Temperature standard for steel tapes is 68°F, which equals 20°C. Coefficient of expansion of steel tapes is 0.00000645' per degree F; 0.0000116' per degree C. This amounts to 0.000645" or 0.00774" per degree F. on a 100' tape, and one-half as much on a 50' tape. As a figure that is reasonably accurate and also easy to handle, it is customary on very long runs of pipe to allow 1/10" per 100' for each 10° change.



The above illustration shows, for a 100' tape, the actual length variations of temperature within the range of 20° below to 120° above zero °F. The terminal graduation on the lower edge is at 68°, this being standard temperature. Standard tension for steel tapes 25 to 100' long (10 to 30m) supported entire length on a horizontal, flat surface, is 10 pounds (4.5 kg.); for all tapes over 100', 20lbs., (9kg.). For steel tapes suspended horizontally and supported only at ends, there can be no set or standard tension for accuracy because of weight and other variations.

The following listings are averages of many tests made by the N.I.S.T. of Lufkin® steel tapes supported throughout and supported ends only. These averages are taken from the experience of tests and should be used as a working basis only, and not to replace the test of any individual tape. All tape lengths are 100'.

| Width tape inches | Kind of tape | Tension of accuracy thru-out in lbs. | Supported ends only in lbs. |
|-------------------|------------------------------|--------------------------------------|-----------------------------|
| 1/4 | Chain tapes | 10 | 24 |
| 1/4 | Engineer's (.012") tapes | 10 | 18 |
| 1/4 | Engineer's Extra Heavy Tapes | 10 | 24 |
| 3/8 & 1/2 | Standard Weight Tapes | 10 | 18 |

NOTE: Temperature and tension need to be taken into account only on precise work. We recommend a government test of tapes to be used for such work or for use as master standard. The N.I.S.T. and Lufkin® have a charge for this test.

Lufkin

Derrick

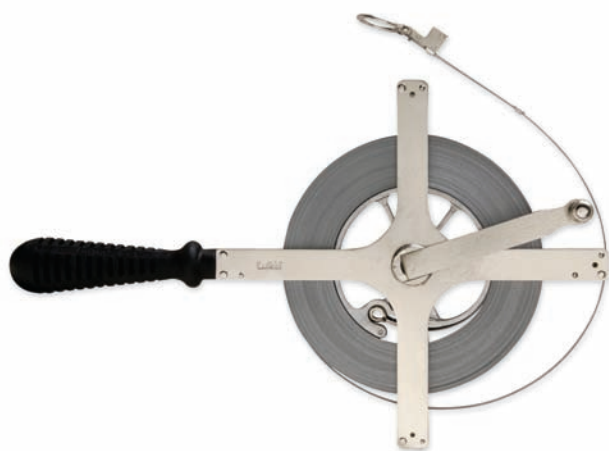

- Chrome Clad® blade
- Nominal blade thickness .019"
- Extra large winding drum provides rapid line recovery and permits tape line to be easily detached from reel
- Special hook ring with ribbed face at zero
- Leather thong is provided to use through eye at rear when tape is removed from reel

| Cat. No. | UPC no. 037103 | Packed | Blade Size | | Blade Style | Pack Wt. | | Shelf Pack | Repl. Blade | UPC No. 037103 | Repl. reel | UPC No. 037103 |
|-----------|----------------|--------|------------|-----------|-------------|----------|------|------------|-------------|----------------|------------|----------------|
| | | | Width | Length | | lb | kg | | | | | |
| C2276D | 454713 | Boxed | 1/4" | 100' | E1 | 2.87 | 1.3 | 1 | OC2276D | 454720 | - | - |
| C2276ME | 454737 | Boxed | 1/4"(6mm) | 100'(30m) | E2 | 2.87 | 1.3 | 1 | OC2276ME | 454744 | - | - |
| GD2730DMM | 063700 | Boxed | 6mm | 30m | E12 | 2.87 | 1.3 | 1 | OCD2730DMM | 063717 | - | - |
| CD2750MME | 063687 | Boxed | 1/4"(6mm) | 164'(50m) | E13 | 3.29 | 1.49 | 1 | - | - | 12200 | 450340 |

Pro Series Ny-Clad® Steel Tapes

- Durable nylon coating on blade resists wear under extreme conditions
- Super fast 3-to-1 blade retraction saves time in the field
- Hi-Viz® orange case is easy to find on the job site
- Steel blade will not stretch under normal use

**NEW
PRODUCT**



PS1808

| Cat. No. | UPC No. | Blade Size | | Blade Style | Pack Wt. | | Shelf Pack |
|----------|--------------|------------|--------|-------------|----------|-----|------------|
| | | Width | Length | | lb | kg | |
| PS1806 | 037103194695 | 1/2" | 100' | E4 | 8.4 | 3.8 | 4 |
| PS1806D | 037103194701 | 1/2" | 100' | E5 | 8.4 | 3.8 | 4 |
| PS1808 | 037103194718 | 1/2" | 200' | E4 | 6.8 | 3.1 | 2 |
| PS1808D | 037103194725 | 1/2" | 200' | E5 | 6.8 | 3.1 | 2 |
| PS1809D | 037103194664 | 1/2" | 300' | E5 | 6.8 | 3.1 | 2 |

Lufkin

Western®

- Chrome Clad® or Yellow clad blade
- Blade is 1/4"/6mm wide and 0.019"/0.5mm thick
- Blank space at each end
- Turning handle locks line at any position
- Reel is nickel-plated, 4-arm with rollers in each arm for smooth winding
- Oversize drum with long, one-piece winding handle for quick return of line
- Riveted clips for holding thongs
- A pair of 580T thongs and a 579 Engineer's conversion rule are furnished with each tape or replacement line
- To order reel No.12-150 specify C1676D
- Y1676D is yellow clad, thickness .016"

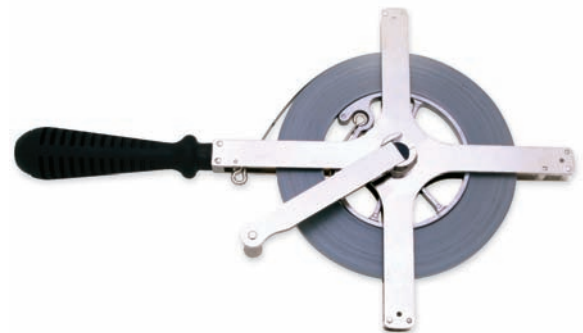

| Cat. No. | UPC no. | | Blade Size | | Blade Style | Pack Wt. | | Shelf Pack | Repl. Blade | UPC No. 037103 | Repl. reel | UPC No. 037103 |
|----------|---------|--------|------------|--------|-------------|----------|------|------------|-------------|----------------|----------------|------------------|
| | 037103 | Packed | Width | Length | | lb | kg | | | | | |
| C1676D | 454584 | Boxed | 1/4" | 100' | E1 | 2.83 | 1.28 | 1 | - | - | - | - |
| Y1676D | 459435 | Boxed | 1/4" | 100' | E1 | 2.50 | 1.13 | 1 | - | - | 11100 or 31100 | 450272 or 450517 |

Chrome Clad®



- Chrome Clad® blade 3/8"/10mm wide and .008"/.2mm thick
- Long, easy-action winding handle that locks line in any position
- Reel is nickel plated, 4-arm frame with rollers in each arm for smooth winding
- Instantaneous reading
- Zero falls at outer end of ring
- Reel available separately

| Cat. No. | UPC No. 037103 | Packed | Blade Size | | Blade Style | Pack Wt. | | Shelf Pack | Repl. Blade | UPC No. 037103 |
|----------|----------------|--------|------------|--------|-------------|----------|------|------------|-------------|----------------|
| | | | Width | Length | | lb | kg | | | |
| C1286 | 454003 | Boxed | 3/8" | 100' | E3 | 2.07 | .94 | 1 | - | - |
| C1286D | 454027 | Boxed | 3/8" | 100' | E1 | 2.07 | .94 | 1 | OC1286D | 454034 |
| C1288 | 454041 | Boxed | 3/8" | 200' | E3 | 3.34 | 1.52 | 1 | OC1288 | 454058 |
| C1288BLK | 124128 | Boxed | 3/8" | 200' | E3 | 3.34 | 1.52 | 1 | - | - |

Peerless

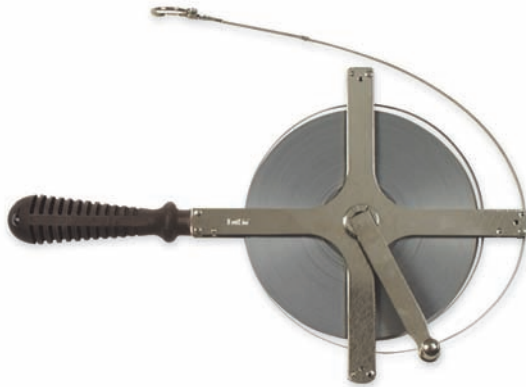

- Designed for engineers and surveyors who prefer a 4-arm reel
- Chrome Clad® or yellow clad blade
- Blade 1/4"/6mm wide and .016"/0.4mm thick
- Subdivided line removes easily from reel
- Long, easy-action winding handle that locks line in any position
- Reel is nickel plated, 4-arm frame with rollers in each arm for smooth winding
- Open design construction aids in drying line and clearing out dirt
- A pair of 580 finger rings and a 579 engineer's conversion rule are furnished with tape or replacement line
- Reel available separately

| Cat. No. | UPC No. 037103 | Packed | Blade Size | | Blade Style | Pack Wt. | | Shelf Pack | Repl. Blade | UPC No. 037103 | Repl. reel | UPC No. 037103 |
|----------|----------------|--------|------------|----------|-------------|----------|------|------------|-------------|----------------|----------------|------------------|
| | | | Width | Length | | lb | kg | | | | | |
| C1276 | 453822 | Boxed | 1/4" | 100' | E3 | 2.33 | 1.06 | 1 | OC1276 | 453839 | 11100 or 31100 | 450272 450517 |
| C1278 | 453860 | Boxed | 1/4" | 200' | E3 | 3.66 | 1.66 | 1 | OC1278 | 453877 | 11200 | 450289 |
| C1276D | 453846 | Boxed | 1/4" | 100' | E1 | 2.33 | 1.06 | 1 | OC1276D | 453853 | 11100 | 450272 |
| C1278D | 453884 | Boxed | 1/4" | 200' | E1 | 3.66 | 1.66 | 1 | OC1278D | 453891 | 11200 | 450289 |
| C2730MM | 060297 | Boxed | 6mm | 30m | E11 | 2.33 | 1.06 | 1 | - | - | 11100 | 450272 |
| C2730DMM | 060204 | Boxed | 1/4"/6mm | 100'/30m | E12 | 2.33 | 1.06 | 1 | OC2730DMM | 063755 | 11100 | 450272 |
| C2730MME | 060280 | Boxed | 1/4"/6mm | 100'/30m | E13 | 2.33 | 1.06 | 1 | - | - | 11100 | 450272 |
| - | - | - | 6mm | 50m | - | - | - | - | - | - | 11200 | 450289 |
| C2750DMM | 060181 | Boxed | 1/4"/6mm | 164'/50m | E12 | 3.29 | 1.49 | 1 | - | - | 11200 | 450289 |
| C2750MME | 001351 | Boxed | 1/4"/6mm | 164'/50m | E13 | 3.29 | 1.49 | 1 | - | - | 11200 | 450289 |
| Y1276 | 457790 | Boxed | 1/4" | 100' | E3 | 2.03 | .92 | 1 | - | - | 11100 or 31100 | 450272 450517 |
| Y1278 | 457837 | Boxed | 1/4" | 200' | E3 | 3.03 | 1.37 | 1 | RY1278 | 457851 | 11200 | 450289 |
| Y1279 | 457875 | Boxed | 1/4" | 300' | E3 | 4.02 | 1.82 | 1 | RY1279 | 457899 | - | - |
| Y1276D | 457806 | Boxed | 1/4" | 100' | E1 | 2.03 | .92 | 1 | RY1276D | 457820 | 11100 or 31100 | 450272 450517 |
| Y1278D | 457844 | Boxed | 1/4" | 200' | E1 | 3.03 | 1.37 | 1 | RY1278D | 457868 | 11200 | 450289 |
| Y1279D | 457882 | Boxed | 1/4" | 300' | E1 | 4.02 | 1.82 | 1 | - | - | - | - |

E1 Chrome-Clad® and Yellow Clad

- 1/4" and 3/8" widths
- Chrome Clad® and yellow clad blade
- Markings on one side only
- Graduated to feet, 1/10ths and 1/100ths with a blank space at last end



E2 Chrome Clad®

- 1/4"/6mm width only
- Chrome Clad® blade
- Markings on both sides
- Graduated millimeters one side
- Graduated feet, inches and 1/8ths other side

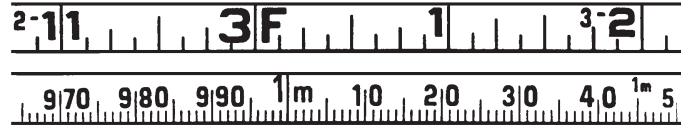

E3 Chrome Clad® and Yellow Clad

- 1/4" and 3/8" widths
- Chrome Clad® blade
- Yellow clad available in 1/4" only
- Black markings one side only
- Graduated feet and inches to 1/8ths with instantaneous readings
- 16" centers indicated by a diamond symbol on 3/8" width only

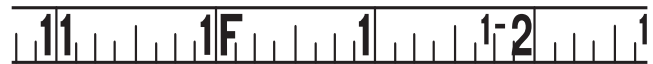

E4 Ny-Clad® Yellow

- 1/2" width only
- Nylon-clad yellow blade
- Black and red markings one side only
- Graduated feet and inches to 1/8ths with instantaneous readings
- Numbered with feet and instantaneous foot markings in red and inches in black



E5 Ny-Clad® Yellow

- 1/2" width only
- Nylon-clad yellow blade
- Black and red markings one side only
- Graduated feet to 1/10ths and 1/100ths
- Numbered with feet in red and 1/10ths in black



E11 Chrome Clad®

- 6mm width
- Black and red markings one side only
- Graduated meters to millimeters
- Red meter numbers and black millimeter numbers at each decimeter

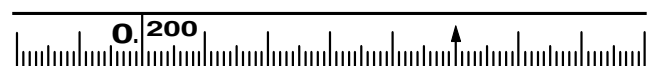

E12 Chrome Clad®

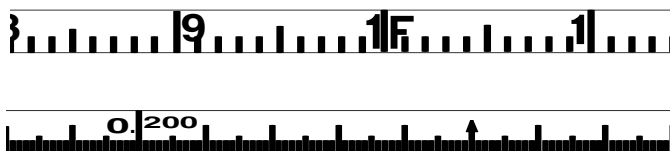

- 1/4" width
- Black and red markings one side; black markings other side
- Graduated meters to millimeters one side
- Red meter numbers and black millimeter numbers at each decimeter
- Graduated feet to 1/10ths and 1/100ths other side
- Numbered feet and 1/10ths black markings only

E13 Chrome Clad®

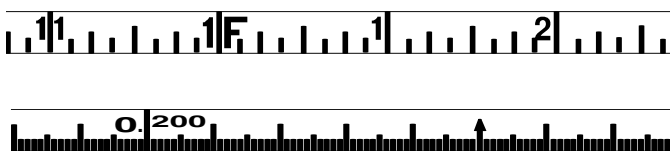

- 1/4" width
- Black and red markings both sides
- Graduated meters to millimeters one side
- Red meter numbers and black millimeter numbers at each decimeter
- Graduated feet and inches to 1/8ths other side with red feet numbers and black inch numbers

Engineering and Surveying Tapes

- Ideal for engineers and surveyors to precisely measure route surveys, highways and railways, mining and survey work
- Heavy gauge thick steel tape
- Raised markings against a hard chrome or black background
- Protected by abrasion resistant coating to provide long life under adverse conditions
- Heavy gauge clip ends on each tape and refill attach to reel or tensioning device
- Tapes include two leather thongs and a correction scale (Celsius for Metric tapes, Fahrenheit for English tapes)
- Different reel choices available for each style of tape
- Reel descriptions on pages 97 - 98
- Please order reels separately

Lufkin

Super Hi-Way® Nubian®

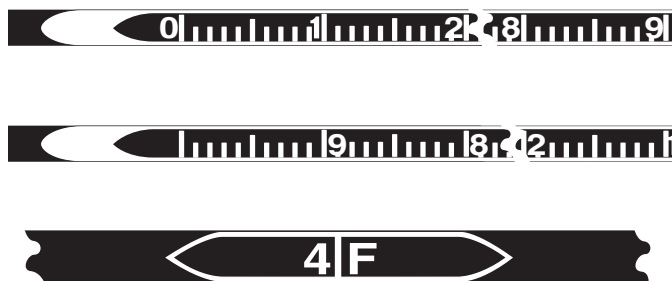

- Nominal thickness .017"
- Easy-to-read raised graduations
- Railroad half-gauge mark 2', 4 1/2" from zero except on metric tapes
- 09100B, 09200B and 09300B: Lines have a blank space at each end. Extra foot before zero is graduated right to left to 1/10ths and 1/100ths. Balance is marked every foot except last foot of each 100' length, which is in 100ths of feet

| Cat. No. | UPC No. | Packed | Blade Size | | Line wt. | | Shelf Pack | Reqd. Reel | UPC No. |
|----------|--------------|--------|------------|--------|----------|------|------------|------------|--------------|
| | | | Width | Length | lbkg | kg | | | |
| 09100B | 037103455437 | Boxed | 5/16" | 100' | 2.27 | 1.02 | 1 | 31100 | 037103450517 |
| 09200B | 037103455468 | Boxed | 5/16" | 200' | 3.93 | 1.78 | 1 | 31200 | 037103450531 |
| 09300B | 037103455598 | Boxed | 5/16" | 300' | 5.8 | 2.63 | 1 | 31300 | 037103450548 |

81 & 91 Series Reels

For 3/8"/10mm and 1/2"/13mm Widths - Chrome Clad® and Gauging Tapes

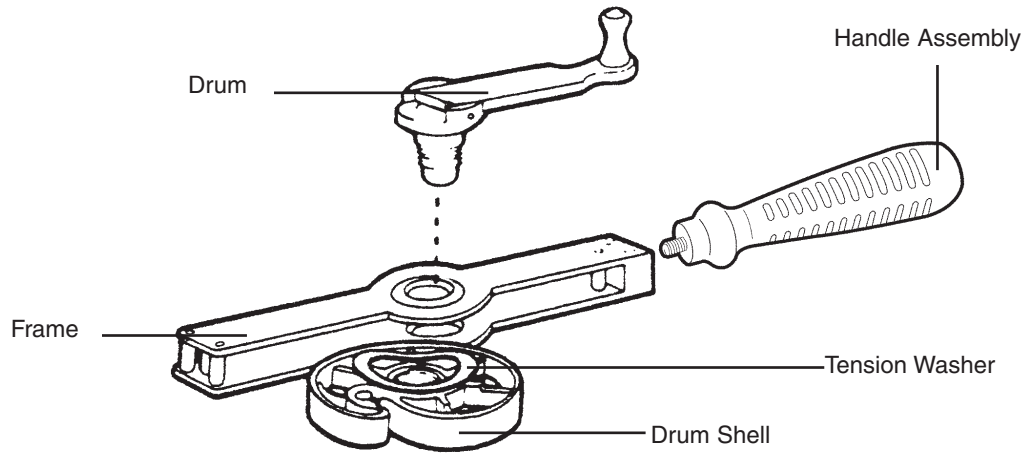

Not all replacement parts sold separately.

| Tape Width | Tape Length | Frame Type | Reel Cat.No. | Reel UPC 037103 | Pack Wt. | | Shelf Pack |
|------------|-------------|------------|---------------|-----------------|----------|-----|------------|
| | | | | | lb | kg | |
| 3/8" | 200' | 4 Arm | 81200L | 450920 | 1.35 | .62 | 1 |
| 1/2" | 50' | 2 Arm | 9150L | 450968 | 1.0 | .46 | 1 |
| 1/2" | 75' | 4 Arm | 9175 | 450975 | 1.30 | .60 | 1 |

31 Series Reel

For over 100' lengths

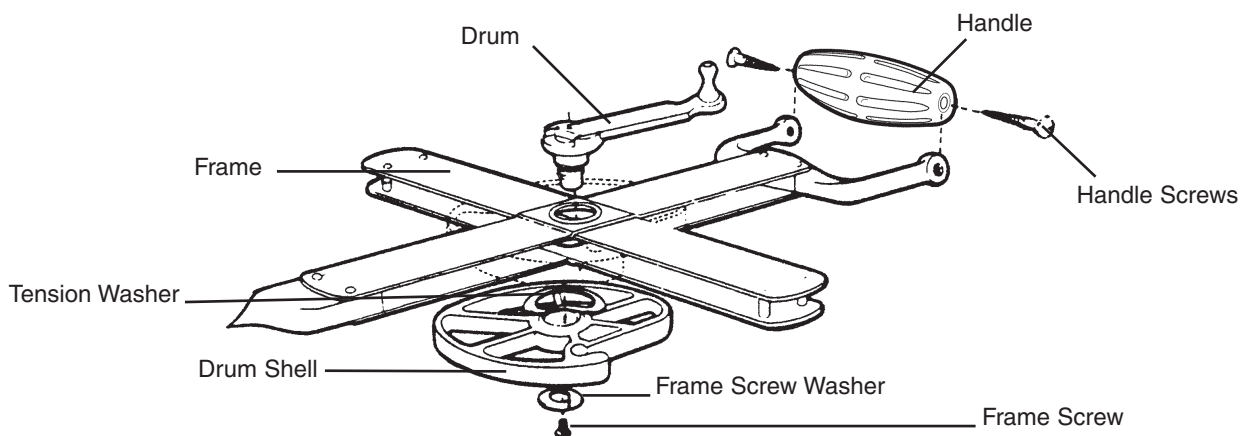

Not all replacement parts sold separately.

| Tape Width | Tape Length | Frame Type | Reel Cat.No. | Reel UPC 037103 | Pack Wt. | | Shelf Pack |
|------------|-------------|------------|--------------|-----------------|----------|-----|------------|
| | | | | | lb | kg | |
| 5/16" | 200' | 4 Arm | 31200 | 450531 | 3.3 | 1.5 | 1 |
| 5/16" | 300' | 4 Arm | 31300 | 450548 | 3.8 | 1.7 | 1 |

11 Series Reel

For 1/4"/6mm wide - 100' and 200' lengths.
Fits Peerless Chrome Clad® Tapes

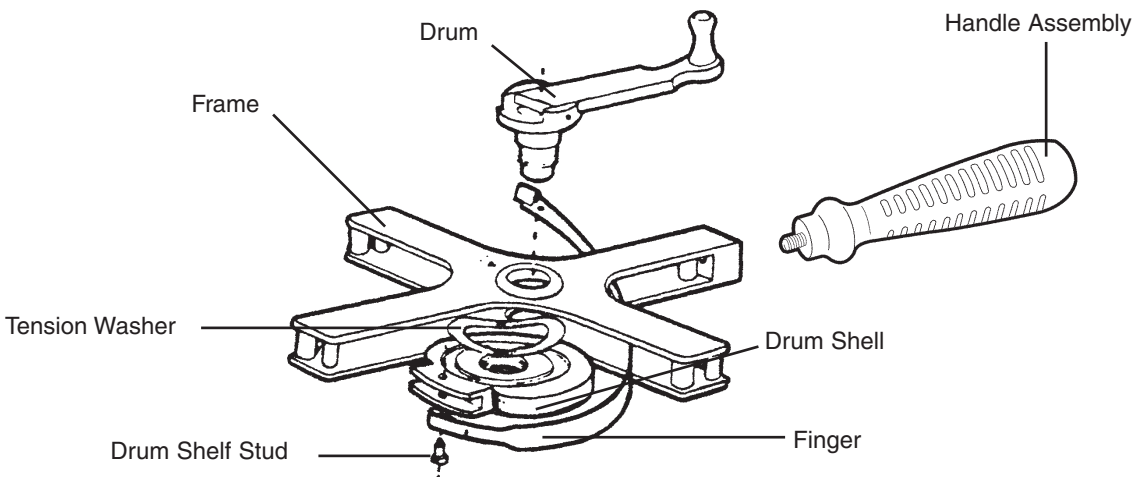

Not all replacement parts sold separately.

| Tape Width | Tape Length | Frame Type | Reel Cat. No. | Reel UPC 037103 | Pack Wt. | | Shelf Pack |
|------------|-------------|------------|---------------|-----------------|----------|-----|------------|
| | | | | | lb | kg | |
| 1/4" | 100' | 4 Arm | 11100 | 450272 | 1.25 | .58 | 1 |
| 1/4" | 200' | 4 Arm | 11200 | 450289 | 1.60 | .72 | 1 |

Detachable Hook



- Easily attaches and detaches from standard ring tape line to let one man take measurements unassisted
- Heavily nickel plated, zinc hook
- Serrated face grips firmly and releases easily
- On tapes measuring from outer end of ring, zero falls at inside of hook
- Can be used on lines 3/8"/10mm and wider such as Anchor® and Leader® chrome clad tapes and Banner metric tapes

| Cat. No. | UPC No. | Packed | Description | Shelf Pack |
|----------|--------------|--------|-----------------|------------|
| 552 | 037103452832 | Boxed | Detachable hook | 1 |

Tape Clamp Handle



- Used for quickly and positively gripping a steel tape at any point
- Applies light or heavy tension
- Clamp is applied and removed by simply operating the handle
- Used properly, it will not damage a tape in any way
- Made of chrome-plated zinc alloy

| Cat. No. | UPC No. | Packed | Description | Shelf Pack |
|----------|--------------|--------|-------------------|------------|
| 584 | 037103453143 | Boxed | Tape clamp handle | 1 |

Tape Tension Handles

- Use with steel tapes for extremely accurate measurements
- Tension handle attaches to one end of the tape and the proper tension is applied when the measurement is taken
- When measuring with an unsupported line, tension handle should be used to counteract the effect of sag
- Rustproof brass construction with black-filled etched graduations
- Graduations begin at snap end and are easy-to-read when tension is applied
- No. 586 - Capacity of 30lbs. by 1/2lbs. and 25kg by 25kg

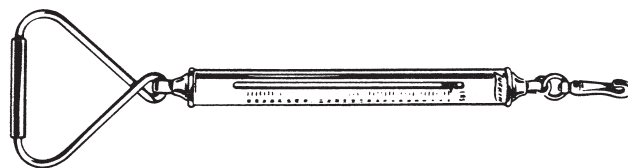

| Cat. No. | UPC No. | Packed | Description | Shelf Pack |
|----------|--------------|--------|----------------------|------------|
| 586 | 037103453150 | Boxed | Tape tension handles | 1 |

Red End® Series Folding Wood Rules

- First choice of carpenters and other professional craftsmen
- Bold red and black markings contrast sharply against white or yellow finish background
- Clear, abrasive-resistant coating protects markings
- Long wearing, riveted lock joints eliminate end play and retain accuracy
- Brass plated end clasps prevent wear

Red End® Extension Folding Wood Rule

- 6' and 8' wood rules available
- Graduated slide rule extends up to 6"
- Slide rule runs under friction in T-slot and stops at each end to prevent slide from falling out
- X46X has two 6" extension slides; an extension is ready for use on the first section
- HX46 has hook; zero falls at inside of hook, for distance measuring
- Marked both sides and both edges
- X46F has flat, inside markings; numbering begins on inside of rule
- Graduated to 1/16ths of an inch, 16" stud centers in red, regular outside markings

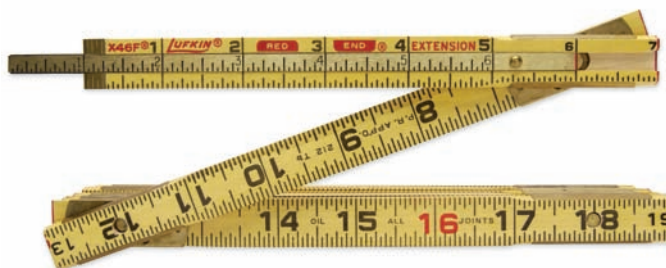

X46F

| Cat. No. | UPC No. | Packed | Blade Size | | Pack Wt. | | Shelf Pack |
|----------|--------------|--------|------------|--------|----------|------|------------|
| | | | Width | Length | lb | kg | |
| X46 | 037103450623 | Boxed | 5/8" | 6' | 2.27 | 1.03 | 6 |
| HX46 | 037103450654 | Boxed | 5/8" | 6' | 2.30 | 1.04 | 6 |
| X48 | 037103450661 | Boxed | 5/8" | 8' | 2.95 | 1.34 | 6 |
| X46F | 037103450630 | Boxed | 5/8" | 6' | 2.28 | 1.03 | 6 |
| X46X | 037103450647 | Boxed | 5/8" | 6' | 2.39 | 1.08 | 6 |

Red End® Folding Wood Rule



066

- Marked both sides, both edges
- Graduated to 1/16ths both edges; 16" stud centers marked in red
- Regular outside markings
- 066F has inside markings; numbering begins on inside of rule; measurement lies close to the work
- 062CME is marked both sides, reading left to right on both sides; rule is graduated in millimeters with centimeter and meter markings on metric side; English side is marked to 1/16ths

| Cat. No. | UPC No. | Packed | Blade Size | | Pack Wt. | | Shelf Pack |
|----------|--------------|--------|------------|--------|----------|------|------------|
| | | | Width | Length | lb | kg | |
| 066 | 037103450845 | Boxed | 5/8" | 6' | 2.2 | 1.00 | 6 |
| 066F | 037103450869 | Boxed | 5/8" | 6' | 2.2 | 1.00 | 6 |
| 068 | 037103450883 | Boxed | 5/8" | 8' | 2.35 | 1.07 | 6 |
| 068F | 037103450890 | Boxed | 5/8" | 8' | 2.35 | 1.07 | 6 |
| 062CME | 037103458407 | Boxed | 5/8" | 6' | 2.5 | 1.13 | 6 |

Red End® - Two Way® Folding Wood Rule



- For measuring left to right, right to left
- Marked both sides
- Graduated in feet, inches and 1/16ths on both sides and both edges
- Flat inside markings lie close to the work

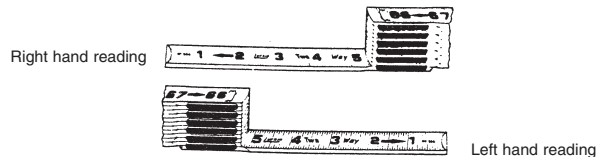

| Cat. No. | UPC No. | Packed | Blade Size | | Pack Wt. | | Shelf Pack |
|----------|--------------|--------|------------|--------|----------|------|------------|
| | | | Width | Length | lb | kg | |
| 966 | 037103453754 | Boxed | 5/8" | 6' | 2.20 | 1.00 | 6 |

Red End® Engineer's Folding Wood Rule

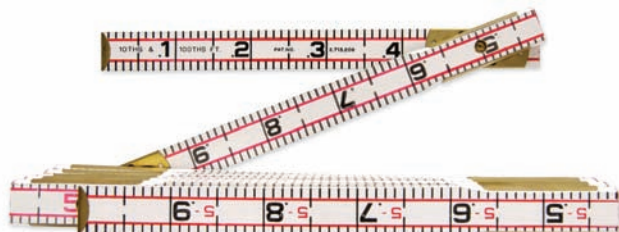

- 1066DM graduated in millimeters and feet, 1/10ths and 1/100ths
- 1066D graduated in feet, 1/10ths and 1/100ths of feet
- Red foot figures
- Regular outside markings in feet, inches and 1/16ths
- Decimal points on engineer's scale prevent reading errors

| Cat. No. | UPC No. | Packed | Blade Size | | Pack Wt. | | Shelf Pack |
|----------|--------------|--------|------------|----------|----------|------|------------|
| | | | Width | Length | lb | kg | |
| 1066D | 037103453761 | Boxed | 5/8"(16mm) | 6' | 2.27 | 1.03 | 6 |
| 1066DM | 037103085054 | Boxed | 5/8"(16mm) | 6.5'(2m) | 2.27 | 1.03 | 6 |

Red End® Plumber's Folding Wood Rule

- Used for working with 45° elbows to eliminate figuring and chance of error
- Graduated one side, in black, inches to 1/16ths both edges
- Other side in red, 45° scale inches to 1/16ths upper edge only
- Turning rule from black to red gives the corresponding 45° elbow measurement
- Example: Sketch at right shows 10" 45° offset; by turning rule at 10" graduation on standard inch side red graduation directly opposite indicates center-to-center fittings to be 14 1/8" Actual pipe length varies as allowances must be made for type of pipe and fitting used. All other size offsets are calculated in same manner. Where offset is longer than length of rule, add 45° scale measurement of extra distance to last scale on rule (101-13/16).

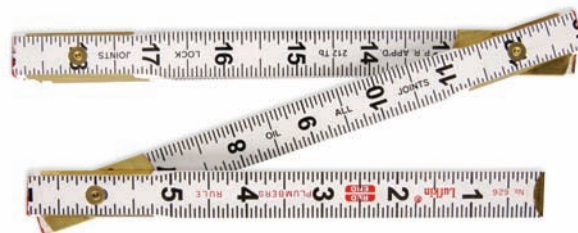
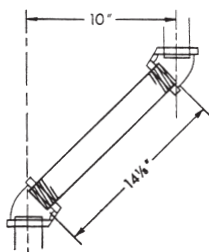

Allowance to be made according to fitting used

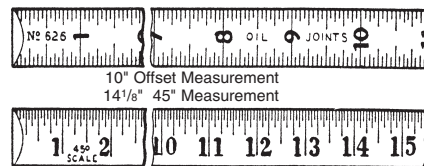

| Cat. No. | UPC No. | Packed | Blade Size | | Pack Wt. | | Shelf Pack |
|----------|--------------|--------|------------|--------|----------|------|------------|
| | | | Width | Length | lb | kg | |
| 626L | 037103453433 | Boxed | 5/8" | 6' | 2.2 | 1.00 | 6 |

Red End® Brick Mason's Folding Wood Rule

- Used by bricklayers
- Graduated vertical inches to 1/16ths, both edges
- Brick Mason's scale on inside, red course counters numbered consecutively
- Regular outside markings in black
- Using the Lufkin® "Red End" 636 Brick Mason's Rule is easy and fast. For instructions on the 656, see below.
- To take a measurement when mortar thickness is known: As an example, assume mortar thickness is 1/2" and the average thickness of brick is 2 1/4". Added they would give a 2 3/4" course. Simply place your thumbnail on the edge of the rule at 2 3/4", turn over to the other side, and your thumbnail will be on the scale 6 mark. This is the correct scale to use under the above conditions. The illustration at left shows how easy it is to check the wall as it is being laid. Correct readings from the top edge of bricks are at scale 6. This rule speeds up correct scaling when an open space is to be bricked. There is but one simple operation when only space is known. Just measure the space with the scale side of the rule to the closest scale mark. This will give you the correct scale to use. For instance, assume that a space 37" is to be bricked. Using the Brick Mason's scale side of the rule to measure, the 37" figure falls between scale 4 and scale 8. Checking both these scales, by the previously described thumbnail method, at the starting end of the rule, it is found that scale 4 is equal to 2 5/8" and scale 8 is equal to 2 7/8". If the brick to be used averages 2 1/2", scale 4 would allow 1/8" joint and scale 8 a 3/8" joint. The more

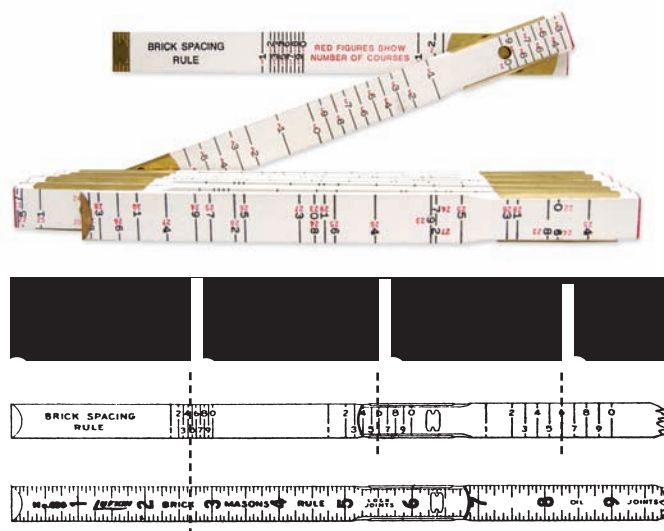

satisfactory of these two size joint thicknesses can be selected for the job. The brick industry is using more and more oversize brick (also referred to as "queen" or "king size" brick). The estimates are about 40% of the brick sold is oversize. These bricks have a height of 2 3/4" vs. 2 1/4" for the standard or modular brick. Due to the number of requests from brick masons, we now offer the new #656 brick mason wood rule. The #656 rule has brick spacings at 2 7/8ths and go to 3 1/2" in 1/16" increments. The brick spacings will be identified by black letters A through K. Letters are used to prevent confusion with spacings shown on #636. The #656 rule is painted yellow compared to white for the #636.

| Cat. No. | UPC No. | Packed | Blade Size | | Pack Wt. | | Shelf Pack |
|----------|--------------|--------|------------|--------|----------|------|------------|
| | | | Width | Length | lb | kg | |
| 636 | 037103453440 | Boxed | 5/8" | 6' | 2.27 | 1.03 | 6 |
| 656 | 037103441218 | Boxed | 5/8" | 6' | 2.27 | 1.03 | 6 |

Lufkin

Red End® Modular Spacing Folding Wood Rule

Designed for masonry work



- All sections have square ends
- Every joint opens on even number
- Inside marked with 6 scales in a 16" module. The scales are as follows: 2 courses in 16" space (for concrete blocks and glass blocks); 3 courses in 16" space (for facing tile); 4 courses in 16" space (for small facing tile and economy brick); 5 courses in 16" space (for engineered brick); 6 courses in 16" space (for Roman brick). Scales include mortar space and spacing for 6" and 12" blocks.
- Outside is graduated on both edges to 1/16ths
- The first end section is a short section which permits butting the rule on the first 16" module

| Cat. No. | UPC No. | Packed | Blade Size | | Pack Wt. | | Shelf Pack |
|----------|--------------|--------|------------|--------|----------|------|------------|
| | | | Width | Length | lb | kg | |
| 646L | 037103453457 | Boxed | 5/8" | 6' | 2.27 | 1.03 | 6 |

Doyle Log Scale

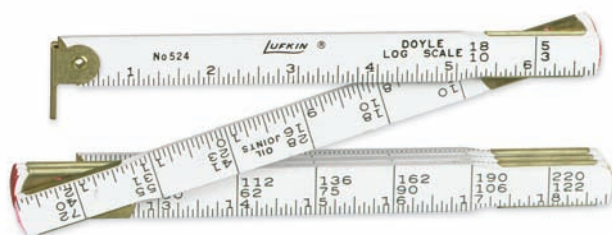

- Designed for estimating board feet in a cut log
- Graduated inches to 1/16ths lower edge
- Outside markings for 10 and 18' logs
- Inside markings for 12, 14 and 16' logs

| Cat. No. | UPC No. | Packed | Blade Size | | Pack Wt. | | Shelf Pack |
|----------|--------------|--------|------------|--------|----------|------|------------|
| | | | Width | Length | lb | kg | |
| 524 | 037103452825 | Boxed | 5/8" | 48" | 0.25 | 0.11 | 1 |

Steel Blacksmith's Rule



- 2', 3/4" wide, 1/32" thick, 1-fold, tempered steel rule
- Riveted joint has large side washer and a stop which bring rule to a firm stop when opened straight
- Legible, permanent, deeply etched black markings
- Lower edge on one side graduated to 1/16ths of an inch, upper edge on other side to 1/8ths, lower edge 75 circumference inches to 1/8ths for converting diameters directly to circumference measurements

| Cat. No. | UPC No. | Packed | Blade Size | | Pack Wt. | | Shelf Pack |
|----------|--------------|--------|------------|--------|----------|------|------------|
| | | | Width | Length | lb | kg | |
| 86 | 037103456601 | Boxed | 3/4" | 2' | 1.85 | 0.84 | 12 |

Lufkin

School Shop Steel Rules

- Used in school shops and industrial plants
- Medium weight, tempered steel rule
- Hole in one end for hanging
- Deeply-etched, permanent markings are black-filled for easy reading
- Large graduations, marked upper edge both sides, one side 1/8ths; other side 1/16ths
- Opposite measure from opposite ends



| Cat. No. | UPC No. | Packed | Thick | Blade Size | | Pack Wt. | | Shelf Pack |
|----------|--------------|--------|-------|------------|--------|----------|------|------------|
| | | | | Width | Length | lb | kg | |
| 6012IN | 037103450739 | Boxed | 1/32" | 3/4" | 12" | 0.43 | 0.20 | 6 |

One-piece Steel Rules

- Bold markings, deeply etched and permanent are black filled for easy reading; heavier than on machine-divided rules
- Large graduations, marked both sides, both edges
- Upper edge graduated in 1/8ths, lower edge in 1/16ths
- Opposite sides measure from opposite ends



| Cat. No. | UPC No. | Packed | Thick | Blade Size | | Pack Wt. | | Shelf Pack |
|----------|--------------|--------|-------|------------|--------|----------|------|------------|
| | | | | Width | Length | lb | kg | |
| 621FT | 037103450791 | Boxed | 1/16" | 1 1/4" | 1' | 6.00 | 2.72 | 20 |
| 622FT | 037103450807 | Boxed | 1/16" | 1 1/4" | 2' | 0.51 | 0.23 | 1 |
| 623FT | 037103450814 | Boxed | 1/16" | 1 1/4" | 3' | 0.76 | 0.34 | 1 |
| 624FT | 037103450821 | Boxed | 1/16" | 1 1/4" | 4' | 1.02 | 0.46 | 1 |
| 626FT | 037103450838 | Boxed | 1/16" | 1 1/4" | 6' | 1.5 | 0.68 | 1 |

Aluminum Yardstick

- Finest quality aluminum yardstick
- Lightweight, flexible, rustproof, tarnish-free and sharply defined yardstick
- Lies flat and has a hang-up hole for storage
- Easy-to-read markings on straight parallel edges
- Fine graduations one side only, both edges in inches to 1/16ths



| Cat. No. | UPC No. | Packed | Rule Size | | Pack Wt. | | Shelf Pack |
|----------|--------------|--------|-----------|--------|----------|------|------------|
| | | | Width | Length | lb | kg | |
| 1260 | 037103453808 | Boxed | 15/64" | 36" | 1.85 | 0.84 | 6 |

Metric-English Aluminum Meter Stick



- Useful for making the transition to the metric system
- Graduated on front side in inches to 1/16ths on upper edge and decimeters, centimeters and millimeters lower edge
- Other side shows table of equivalents and conversions

| Cat. No. | UPC No. | Packed | Rule Size | | Pack Wt. | | Shelf Pack |
|----------|--------------|--------|-----------|--------|----------|------|------------|
| | | | Width | Length | lb | kg | |
| 1261ME | 037103453815 | Boxed | 1"(27mm) | 1 m | 2.7 | 1.22 | 6 |

Tinner's Steel Circumference Rules



- Standard rule with tinner's and other sheet metalworkers
- Tempered medium-weight steel
- Hole in one end for hanging
- Markings are black for easy reading
- 953 model, one side upper edge marked inches to 1/16ths; lower edge marked up to 113 circumference inches to 1/8ths
- 954 model, one side upper edge marked inches to 1/16ths; lower edge marked up to 150 circumference inches to 1/8ths
- Reverse side of both models has formulas for calculating circumference, diameter, area, etc. and size tables for laying out measures and cans

| Cat. No. | UPC No. | Packed | Thick | Rule Size | | Pack Wt. | | Shelf Pack |
|----------|--------------|--------|-------|-----------|--------|----------|------|------------|
| | | | | Width | Length | lb | kg | |
| 953FT | 037103450982 | Boxed | 1/16" | 1 1/4" | 3' | 0.78 | 0.35 | 1 |
| 954FT | 037103450999 | Boxed | 1/16" | 1 1/4" | 4' | 1.04 | 0.47 | 1 |

Pro Series Measuring Wheels

**NEW
PRODUCT**

PSMW18

- Measure as fast as you can walk
- Wheel Brake and Reset at handle for convenient multiple measurements
- Wheel calibrated to counter - accurate for estimated measurements
- Large wheel model ideal for uneven terrain
- Also suitable for long indoor measurements
- Manufacturing plant layout, outdoor measurements on firm smooth surfaces
- Feet and Inches



PSMW38



PSMW18

PSMW38

- Measure as fast as you can walk
- Wheel calibrated to counter - accurate for estimated measurements
- Compact measuring wheel, convenient for quick estimates
- Ideal for real estate or homeowners
- Fits into standard size briefcase
- Feet & Inches

| Cat. No. | UPC No. | Packed | Description | Handle Length | | Pack Wt. | | Shelf Pack |
|----------|--------------|--------|--|---------------|----------|----------|-----|------------|
| | | | | Retracted | Extended | lb | kg | |
| PSMW18 | 037103195272 | Carded | Pro Series Measuring Wheel, Compact, 8ths | 21" | 42" | 8.2 | 3.7 | 6 |
| PSMW38 | 037103195289 | Carded | Pro Series Measuring Wheel, Contractor's, 8ths | 25" | 45.5" | 9.4 | 4.3 | 4 |

Lufkin

Measuring Wheels



MW18



MW38

All Wheels

- Measure as fast as you can walk
- For estimated measurements
- Measures curved, horizontal, and vertical surfaces - flexible for multiple uses
- Tough plastic parts and molded rubber tires resist corrosion
- Telescoping handles - adjustable height comfortable for most users

MW18

- Compact measuring wheel, convenient for quick estimates
- Ideal for real estate or homeowners
- Fits into standard size briefcase; telescoping handle reduces length to 17" for easy storage
- Dial indicator measures up to 999' 11" without resetting
- MW18M, meters and decimeters

MW38

- Large wheel model ideal for uneven terrain
- Also suitable for long indoor measurements such as manufacturing plant layout or outdoor measurements on firm and smooth surfaces
- Dial indicator measures up to 9,999' 11" without resetting (almost 2 miles)
- Retractable handle adjusts for comfortable measurements
- MW38M, meters and decimeters

| Cat. No. | UPC No. | Packed | Description | Handle Length | | Pack Wt. | | Shelf Pack |
|----------|--------------|--------|------------------------------------|---------------|----------|----------|-------|------------|
| | | | | Retracted | Extended | lb | kg | |
| MW18TP | 037103134844 | Carded | Executive Measuring Wheel, Feet | 17" | 26" | 6.5 | 14.33 | 6 |
| MW18M | 037103142061 | Carded | Executive Measuring Wheel, Metric | 17" | 26" | 6.5 | 14.33 | 6 |
| MW38TP | 037103134868 | Carded | Contractor Measuring Wheel, Feet | 30" | 41" | 13 | 28.66 | 3 |
| MW38M | 037103142078 | Carded | Contractor Measuring Wheel, Metric | 30" | 41" | 13 | 28.66 | 3 |

| Cat. No. | Page | Cat. No. | Page | Cat. No. | Page | Cat. No. | Page |
|-----------|------------|---------------|------------|-----------------|------|------------|------|
| 062CME | 100 | 2410CME | 64 | C216 | 76 | HV1048DM | 65 |
| 066 | 100 | 261PTH | 77 | C21616THBLK | 76 | HV1049CME | 65 |
| 066F | 100 | 263P | 77 | C216D | 76 | HV116 | 66 |
| 068 | 100 | 31100 | 93, 94, 96 | C2276D | 92 | HV1312 | 65 |
| 068F | 100 | 31200 | 96, 97 | C2276ME | 92 | HV1312D | 65 |
| 100L | 79 | 31300 | 96, 97 | C2730DMM | 94 | HV1316 | 65 |
| 1066D | 100 | 50 | 79 | C2730MM | 94 | HV1325 | 65 |
| 1066DM | 100 | 524 | 102 | C2730MME | 94 | HV1325D | 65 |
| 11100 | 93, 94, 98 | 552 | 98 | C2750DMM | 94 | HV1410CME | 65 |
| 11200 | 94, 98 | 584 | 98 | C2750MME | 94 | HV1425 | 65 |
| 120P | 80 | 586 | 99 | C2910MME590GM | 88 | HV1425D | 65 |
| 120TP | 80 | 58712 | 91 | C2915MME590GM | 88 | HV1425ED | 65 |
| 12200 | 92 | 590 | 91 | C2920MME150MM | 88 | HV1430 | 65 |
| 1260 | 103 | 590G | 91 | C2920MME590GM | 88 | HV1433 | 65 |
| 1261ME | 104 | 590GM | 91 | C2930MME590GM | 88 | HV1433DM | 65 |
| 1290SF590 | 88 | 590GME | 91 | C9212 | 69 | HV15CME | 79 |
| 1291SM590 | 88 | 6012IN | 103 | C9212X | 69 | HV30CME | 79 |
| 1293SF590 | 88 | 621FT | 103 | CD2730DMM | 92 | HV420 | 66 |
| 1293SM590 | 88 | 622FT | 103 | CD2750MME | 92 | HV46CME | 66 |
| 150MM | 91 | 623FT | 103 | CN129012SF590 | 87 | HW100 | 79 |
| 1703 | 83 | 624FT | 103 | CN1290SF590 | 87 | HW223 | 78 |
| 1703D | 83 | 626FT | 103 | CN1290SMEF590 | 87 | HW223D | 78 |
| 1706 | 83 | 626L | 101 | CN1291SF590 | 87 | HW223ME | 78 |
| 1706D | 83 | 636 | 101 | CN1293SDF590 | 87 | HW226 | 78 |
| 1707 | 84 | 646L | 102 | CN1293SF58712 | 87 | HW226D | 78 |
| 1707D | 84 | 656 | 101 | CN1293SF590 | 87 | HW226ME | 78 |
| 1708 | 84 | 81200L | 97 | CN1293SMEF590 | 87 | HW227CME | 78 |
| 1708D | 84 | 86 | 102 | CN1294SF58712 | 87 | HW50 | 79 |
| 1709 | 84 | 9150L | 97 | CN1294SF590 | 87 | HX46 | 99 |
| 1709D | 84 | 9175 | 97 | CN1294SMEF590 | 87 | HY17100CME | 84 |
| 2024CME | 64 | 953FT | 104 | CN1295SF590 | 87 | HY1715CME | 83 |
| 2033CME | 64 | 954FT | 104 | CN1295SMEF58712 | 87 | HY1730CM | 83 |
| 2034CME | 64 | 966 | 100 | CN1295SMEF590 | 87 | HY1730CME | 83 |
| 2035CM | 64 | AL725 | 67 | CN1296SF590 | 87 | HY1730DM | 83 |
| 2035CME | 64 | AL725MAG | 68 | CN1296SMEF590 | 87 | HY1750CM | 84 |
| 2038ME | 64 | AL748CME | 67 | CN1298SMEF590 | 87 | HY1750CME | 84 |
| 2048CME | 64 | C106PM | 80 | HC253 | 76 | HY1760CME | 84 |
| 2049CME | 64 | C106TPM | 80 | HC256 | 76 | HYT100 | 77 |
| 2125 | 64 | C120TP | 80 | HD403 | 86 | HYT100D | 77 |
| 2130 | 64 | C1276 | 94 | HD403D | 86 | HYT15CME | 77 |
| 2133 | 64 | C1276D | 94 | HD406 | 86 | HYT30CME | 77 |
| 2133D | 64 | C1278 | 94 | HD406D | 86 | HYT50 | 77 |
| 2210 | 64 | C1278D | 94 | HDH406 | 86 | HYT50CME | 77 |
| 2210MEX | 64 | C1286 | 94 | HDH406D | 86 | L503 | 69 |
| 2212 | 64 | C1286D | 94 | HV1010 | 65 | L510 | 68 |
| 2212DX | 64 | C1288 | 94 | HV1012 | 65 | L510CME | 68 |
| 2212X | 64 | C1288BLK | 94 | HV1023CM | 65 | L516 | 68 |
| 2223CME | 64 | C12901/2SF590 | 88 | HV1023CME | 65 | L516CME | 68 |
| 2312 | 64 | C1290SF590 | 88 | HV1024CME | 65 | L525 | 68 |
| 2312D | 64 | C1291SF590 | 88 | HV1034CME | 65 | L525CME | 68 |
| 2316 | 64 | C1293SF590 | 88 | HV1034DM | 65 | L525SCTMP | 68 |
| 2325 | 64 | C1676D | 93 | HV1035CM | 65 | L725MAG | 67 |
| 2325D | 64 | C213 | 76 | HV1035CME | 65 | L748MAG | 67 |
| 2333ME | 64 | C213C | 76 | HV1038CME | 65 | MW18M | 106 |
| 2335ME | 64 | C213CX | 76 | HV1048CM | 65 | MW18TP | 106 |
| 2338CME | 64 | C213D | 76 | HV1048CME | 65 | MW38M | 106 |

| Cat. No. | Page | Cat. No. | Page | Cat. No. | Page | Cat. No. | Page |
|------------------|------|-----------|------------|----------|------|----------|------|
| MW38TP | 106 | PS3035CME | 63 | X48 | 99 | | |
| O120P | 80 | PS3048CME | 63 | XL8525 | 67 | | |
| O1290SF590 | 88 | PS3312 | 63 | Y1276 | 94 | | |
| O1293SF590 | 88 | PS3316 | 63 | Y1276D | 94 | | |
| O1707 | 84 | PS3425 | 63 | Y1278 | 94 | | |
| O1707D | 84 | PS3425D | 63 | Y1278D | 94 | | |
| O1708D | 84 | PS3430 | 63 | Y1279 | 94 | | |
| O261PTH | 77 | PS3435 | 63 | Y1279D | 94 | | |
| O703D | 83 | PSMW18 | 105 | Y1676D | 93 | | |
| O703L | 83 | PSMW38 | 105 | Y420 | 66 | | |
| O706D | 83 | QR1312 | 66 | Y46CME | 66 | | |
| O706L | 83 | QR1316 | 66 | Y613ME | 70 | | |
| O9100B | 96 | QR1425 | 66 | Y8210 | 69 | | |
| O9200B | 96 | QRL525MP | 68 | Y8212 | 69 | | |
| O9300B | 96 | R2312 | 65 | | | | |
| OC1276 | 94 | RC106TPM | 80 | | | | |
| OC1276D | 94 | RHY50CME | 77 | | | | |
| OC1278 | 94 | RW06PD | 70 | | | | |
| OC1278D | 94 | RW312 | 69 | | | | |
| OC1286D | 94 | RW316 | 64, 65 | | | | |
| OC1288 | 94 | RXL33 | 65 | | | | |
| OC12901 / 2SF590 | 88 | RY1276D | 94 | | | | |
| OC1290SF590 | 88 | RY1278 | 94 | | | | |
| OC1291SF590 | 88 | RY1278D | 94 | | | | |
| OC1293SF590 | 88 | RY1279 | 94 | | | | |
| OC213D | 76 | RY15CME | 79 | | | | |
| OC2276D | 92 | RY210 | 64, 65, 69 | | | | |
| OC2276ME | 92 | RY212 | 64, 65, 69 | | | | |
| OC2730DMM | 94 | RY23CME | 65 | | | | |
| OC2910MME590GM | 88 | RY30CME | 79 | | | | |
| OCD2730DMM | 92 | RY325 | 64, 65 | | | | |
| OCN129012SF590 | 87 | RY35CME | 64, 65 | | | | |
| OCN1290SF590 | 87 | RY425 | 64, 65 | | | | |
| OCN1291SF590 | 87 | RY430 | 64, 65 | | | | |
| OCN1293SF590 | 87 | S1291F590 | 89 | | | | |
| OCN1293SMEF590 | 87 | S1293F590 | 89 | | | | |
| OCN1294SF590 | 87 | S590 | 91 | | | | |
| OCN1294SMEF590 | 87 | W393 | 71 | | | | |
| OCN1295SF590 | 87 | W606 | 70 | | | | |
| OCN1295SMEF590 | 87 | W606ME | 70 | | | | |
| OCN1296SF590 | 87 | W606P | 70 | | | | |
| OCN1296SMEF590 | 87 | W606PD | 70 | | | | |
| OS1291F590 | 89 | W606PM | 70 | | | | |
| OS1293F590 | 89 | W608 | 70 | | | | |
| OY100 | 79 | W6110 | 70 | | | | |
| OY50 | 79 | W616 | 70 | | | | |
| PS100S | 78 | W616BO | 70 | | | | |
| PS1706 | 83 | W9210 | 69 | | | | |
| PS1708 | 83 | W9210ME | 69 | | | | |
| PS1709 | 83 | W9212 | 69 | | | | |
| PS1806 | 93 | W928 | 69 | | | | |
| PS1806D | 93 | W9312 | 69 | | | | |
| PS1808 | 93 | W9312D | 69 | | | | |
| PS1808D | 93 | X46 | 99 | | | | |
| PS1809D | 93 | X46F | 99 | | | | |
| PS3034CME | 63 | X46X | 99 | | | | |