



SHRINK FIT

THE INDUSTRY'S HIGHEST QUALITY SHRINK FIT LINE

CATALOG



THE INDUSTRY'S HIGHEST QUALITY SHRINK FIT LINE

- **High Speed: shrinking from 2 to 7 seconds**
- **Flexible Range: shrinking from 2 to 40mm**

Remotely controlled

- Compatible with Start.2 & Fi-5B
- Shrink and Cooling unit linked and controlled by 1 pendant!



Auto shank size detection for ease of use

High Speed Cooling Unit!

Cools tools less than 2 minutes with standard shop air pressure!



Air cooling unit

Operating instructions

Inductor rotates 180° to allow easy removal of broken tools

Storage space for chuck holders

Cooling system **compatible with all cutting tool geometries** to optimize cooling time cycle (3° slope, 4.5° slope, cylindrical)

Start.2

220V - Standard
440V - Optional

UPGRADABILITY

Fi-5B

440V - Standard

Storage space for inductor and cooling stop rings

Shrink and unshrink any type of tools and cutters

- Steel, HSS, Carbide, Heavy Metal, Powdered Metal, Shrink Fit extensions and reductions, Tool Shank must have h6 tolerance

Removable electronics

- Compatible with Start.2 & Fi-5B
- Unique slide-out Control Module allows for easy access and repair



AFTER SALES-SERVICE



Scan here to see our Start.2 video!



Scan here to see our Fi-5B video!

Registered models – Registered patents
Subject to change without notice.

Don't hesitate to give us a call! Questions on the unit or applications? Let our trained sales engineers help you!



Phone: (847) 367-4800



Fax: (847) 367-4815



www.lyndexnikken.com

Live Chat is available through our website!



SPECIFICATIONS & EQUIPMENT

Functions	Start.2	Fi-5B
Specifications	PART NUMBER: SF-START2-UNIT	PART NUMBER: SF-FI5-UNIT
Automatic tool size detection within the range of each inductor ring	■	■
Rapid heating cycle prevents heat transfer damage to the cutting tool and toolholder	■	■
Self regulated heating cycle allows for safe operation	■	■
Automatic or manual shrinking cycle time	■	■
Shrinking $\emptyset 2$ to $\emptyset 40$ mm (.079" - 1.575") with the same inductor	■	■
Large 64mm (2.52") inductor diameter provides flexibility for small to large cutting tools	■	■
Remote control pendant for ergonomic operation	■	■
Unique slide out control module allows for easy access and repair	■	■
Inductor rotates 180 degrees for broken cutter removal	■	■
Cooling system for the electronic board to allow high-speed shrinking		■
Power supply 400-480V/14kW/50-60Hz/3 phase	■	■
Power supply 200-240V/14kW/50-60Hz/3 phase	■	
Equipment		
1 air cooling unit (70-90 PSI)	■	
2 air cooling units (70-90 PSI)	□	■
Shrinking of cutting diameters larger than shank diameters	□	□
Shrinking system for reductions	□	□
Back stop presetting unit	□	□
Storage space for chuck holders	■	■
Storage space for inductor stop rings and cooling stop rings	■	■
Storage space for cooling stop rings	□	

■ : Standard □ : Option



Back stop presetting to determine the tool gauge before shrinking

SHRINKING EQUIPMENT



START.2 SHRINK FIT UNIT

- The world's easiest shrink machine to operate.
- Provided with accessories for shrinking $\varnothing 2$ to $\varnothing 40$ (.079" - 1.575").
- Compact and Ergonomic Design.
- 1 cooling unit included, multiple cooling units can be connected.
- Shrink machine unit net weight - 41.9 lbs. (19 kg)



Storage Racks
(INCLUDED)

COOLING UNIT



- Rapid Cooling - Tapered internal design allows for even distribution of high pressure air.
- Provided with accessories for cooling $\varnothing 2$ to $\varnothing 40$ (.079" - 1.575").
- Compressed air supply: 70 to 90 psi.
- Equipped with a filter and a pressure-reducing gauge to regulate the pressure and the air flow.
- Weight: 11 lbs. (5 kg)

FI-5B SHRINK FIT UNIT

- **FI-5B - speed and safety in one**
- Speed** - multiple cooling units to support high quantity tool assembly
- Safety** - Guide Rail prevents operator from handling hot tools
- **The electronic board is cooled to allow high-speed shrinking.**
- Provided with accessories for shrinking & cooling $\varnothing 2$ to $\varnothing 40$ (.079"-1.575").
- **Dimensions:**
 - Length = 30.9" (785mm)
 - Depth = 19.29" (490mm)
 - Height = 33.66" (855mm)
- **Weight** (options excluded): 94.8 lbs. (43 kg)



PRESETTING UNIT (OPTIONAL)

- For length presetting
- For Fi-5B shrink fit unit only
- Accuracy: $\pm 0,050\text{mm}$
- Repeatability: $\pm 0,020\text{mm}$
- Capability: tool shank $\varnothing 6$ to $\varnothing 32$ (.25"-1.25")



START.2 SHRINK FIT AND ACCESSORIES INCLUDED ONLY \$9,950

INCLUDES:

SHRINK UNIT



COOLING UNIT



5 PIECE INDUCTION RING SET

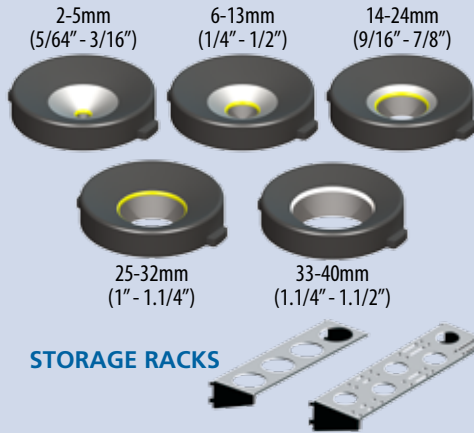

5 PIECE COOLING BRACKET SET

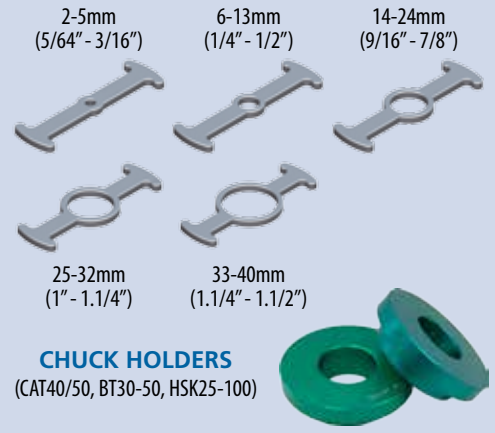

STORAGE RACKS

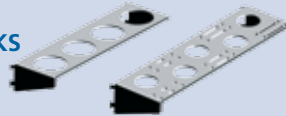

CHUCK HOLDERS

(CAT40/50, BT30-50, HSK25-100)

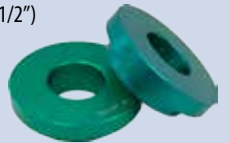

START.2 SHRINK FIT UNIT + 10 SHRINK FIT HOLDER PACKAGES AVAILABLE THROUGHOUT CATALOG

STANDARD FEATURES

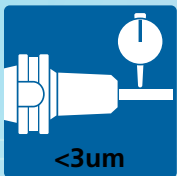

RUNOUT



COOLANT



BALANCE

OPTIONAL FEATURES

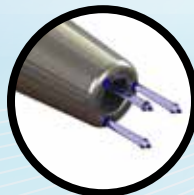

COOLANT PORTS

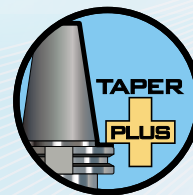

TAPER PLUS

CUSTOMIZE YOUR EQUIPMENT PACKAGE

ACCESSORIES

PART NUMBER

Start.2

Fi-5B

Pot/Chuck holder

For HSK 25 chuck	SF-POT-HSK25	<input type="checkbox"/>	<input type="checkbox"/>
For HSK 32 chuck	SF-POT-HSK32	<input type="checkbox"/>	<input type="checkbox"/>
For HSK 40 chuck	SF-POT-HSK40	<input type="checkbox"/>	<input type="checkbox"/>
For HSK 50 chuck	SF-POT-HSK50	<input type="checkbox"/>	<input type="checkbox"/>
For HSK 63 chuck	SF-POT-HSK63	<input type="checkbox"/>	<input type="checkbox"/>
For HSK 80 chuck	SF-POT-HSK80	<input type="checkbox"/>	<input type="checkbox"/>
For HSK 100 chuck	SF-POT-HSK100	<input type="checkbox"/>	<input type="checkbox"/>
For BT 30 chuck	SF-POT-#30	<input type="checkbox"/>	<input type="checkbox"/>
For CAT / BT 40 chuck	SF-POT-#40	<input type="checkbox"/>	<input type="checkbox"/>
For BT 45 chuck	SF-POT-#45	<input type="checkbox"/>	<input type="checkbox"/>
For CAT / BT 50 chuck	SF-POT-#50	<input type="checkbox"/>	<input type="checkbox"/>



Heating Ring

Ø 2 to Ø 5 (5/64" - 3/16")	SF-HEAT-RING-2-5	<input checked="" type="checkbox"/>	<input checked="" type="checkbox"/>
Ø 6 to Ø 13 (1/4" - 1/2")	SF-HEAT-RING-6-13	<input checked="" type="checkbox"/>	<input checked="" type="checkbox"/>
Ø 14 to Ø 24 (9/16" - 7/8")	SF-HEAT-RING-14-24	<input checked="" type="checkbox"/>	<input checked="" type="checkbox"/>
Ø 25 to Ø 32 (1" - 1 1/4")	SF-HEAT-RING-25-32	<input checked="" type="checkbox"/>	<input checked="" type="checkbox"/>
Ø 33 to Ø 40 (1 1/4" - 1 1/2")	SF-HEAT-RING-33-40	<input checked="" type="checkbox"/>	<input checked="" type="checkbox"/>



Split Heating Ring

Ø 2 to Ø 5 (5/64" - 3/16")	SF-HEAT-RING-2-5(SP)	<input type="checkbox"/>	<input type="checkbox"/>
Ø 6 to Ø 13 (1/4" - 1/2")	SF-HEAT-RING-6-13(SP)	<input type="checkbox"/>	<input type="checkbox"/>
Ø 14 to Ø 24 (9/16" - 7/8")	SF-HEAT-RING-14-24(SP)	<input type="checkbox"/>	<input type="checkbox"/>
Ø 25 to Ø 32 (1" - 1 1/4")	SF-HEAT-RING-25-32(SP)	<input type="checkbox"/>	<input type="checkbox"/>
Ø 33 to Ø 40 (1 1/4" - 1 1/2")	SF-HEAT-RING-33-40(SP)	<input type="checkbox"/>	<input type="checkbox"/>



Additional Cooling Unit

Cooling unit for Fi-5B			<input checked="" type="checkbox"/>
------------------------	--	--	-------------------------------------



Cooling Brackets

Ø 2 to Ø 5 (5/64" - 3/16")	SF-COOL-BRACKET-2-6	<input checked="" type="checkbox"/>	<input checked="" type="checkbox"/> x2
Ø 6 to Ø 13 (1/4" - 1/2")	SF-COOL-BRACKET-6-14	<input checked="" type="checkbox"/>	<input checked="" type="checkbox"/> x2
Ø 14 to Ø 24 (9/16" - 7/8")	SF-COOL-BRACKET-14-25	<input checked="" type="checkbox"/>	<input checked="" type="checkbox"/> x2
Ø 25 to Ø 32 (1" - 1 1/4")	SF-COOL-BRACKET-25-33	<input checked="" type="checkbox"/>	<input checked="" type="checkbox"/> x2
Ø 33 to Ø 40 (1 1/4" - 1 1/2")	SF-COOL-BRACKET-33-41	<input checked="" type="checkbox"/>	<input checked="" type="checkbox"/> x2



Shrinking with reductions

Set up fixture Reduction Sleeve	SF-REDUCTION-FIXTURE	<input type="checkbox"/>	<input type="checkbox"/>
---------------------------------	----------------------	--------------------------	--------------------------



Various accessories

Storage space for tools	SF-RACK-CUTTER		<input type="checkbox"/>
Storage space for chuck holders	SF-RACK-POT		<input type="checkbox"/>
Storage space for inductor & cooling stop rings	SF-RACK-HEAT-RING		<input type="checkbox"/>
Storage space for cooling stop rings	SF-RACK-COOL-STOP	<input type="checkbox"/>	
A pair of Kevlar gloves	SF-GLOVES	<input checked="" type="checkbox"/>	<input checked="" type="checkbox"/>
Plier for gripping small diameters	SF-PLIERS	<input type="checkbox"/>	<input type="checkbox"/>

■ : Standard

□ : Option

Start 2:
Choose any 2 Pots

Fi-5B:
Choose any 3 Pots

	PART NUMBER	Start.2	Fi-5B
Shrink Fit Cabinet			
Stainless Steel Trolley	SF-CABINET	<input type="checkbox"/>	
Inductor			
Replacement Inductor	SF-INDUCTOR	■	■
Electronic board			
Motherboard 380 / 480V	SF-MOTHER-BOARD-380	■	■
Motherboard 200 / 240 V	SF-MOTHER-BOARD	■	■
Remote control			
Remote control	SF-CONTROL	■	■

PRESETTING

	PART NUMBER	Start.2	Fi-5B
Presetting units			
Presetting unit by back-stop (Accessories : please contact us)	SF-PS-UNIT	<input type="checkbox"/>	
Presetting unit + 3 rods + ruler + indicator + one set of guides and guide holder	SF-PS-KIT		<input type="checkbox"/>
Accessories for presetting units			
Set of tools guides Ø 1/4" , 5/16" , 3/8" , 1/2" , 5/8" , 3/4"	SF-PS-TOOLGUIDE-KIT		■
Presetting guides holder	SF-PS-GUIDE-HOLDER		■
Presetting Clip Kit (19 sizes included in 1 kit)	SF-SPRING-CLIP-KIT		<input type="checkbox"/>
Adapter for BT30 presetting	SF-PS-BT30-ADAPTER		<input type="checkbox"/>
Adapter for CAT / BT40 presetting	SF-PS-CT/BT40-ADPTR		<input type="checkbox"/>
Adapter for BT45 presetting	SF-PS-CT/BT45-ADPTR		<input type="checkbox"/>
Adapter for CAT / BT50 presetting	SF-PS-CT/BT50-ADPTR		<input type="checkbox"/>
Tool guide Ø 1/4" *	SF-PS-GUIDE-6M-0250		■
Tool guide Ø 5/16" *	SF-PS-GUIDE-8M-0312		■
Tool guide Ø 3/8" *	SF-PS-GUIDE-10M-0375		■
Tool guide Ø 1/2" *	SF-PS-GUIDE-14M-0500		■
Tool guide Ø 5/8" *	SF-PS-GUIDE-16M-0625		■
Tool guide Ø 3/4" *	SF-PS-GUIDE-20M-0750		■
Tool guide Ø 1" *	SF-PS-GUIDE-25M-1000		<input type="checkbox"/>
Tool guide Ø 1 1/4" *	SF-PS-GUIDE-32M-1250		<input type="checkbox"/>
Compact rod	SF-PS-COMPACT-ROD		■
Standard & mold range rod	SF-PS-STD-ROD		■
Rod (length 160 mm)	SF-PS-STD-ROD-LONG		■
Ruler 300 mm	SF-PS-RULER		■
Dial indicator	SF-PS-DIAL		■

*Metric Available 6-32mm

Spring Clip Kit -19 sizes in 1 kit:
 MM - 3,4,5,6,8,10,12,16,20,25
 INCH- 1/8, 3/16, 1/4, 5/16, 3/8,
 1/2, 5/8, 3/4, 1.0

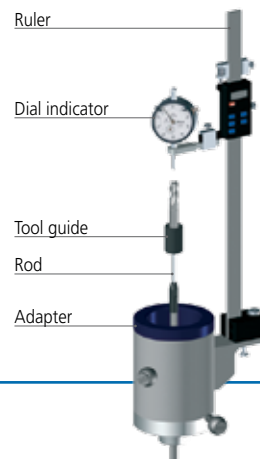

■ : Standard □ : Option ■ : Replacement part

BALANCING PRINCIPLES

The **static unbalance** (U, g.mm) results in a difference of position (e, mm) between the center of gravity and the axis of rotation of the tool-holder that generates a centrifugal force which has detrimental effect on the machine spindle and cutting tool.

$$U = e \times M \text{ tool-holder} \quad F = U \times \omega^2 \times 10^{-6} \quad (\omega : \text{rotation in rad/s})$$

The unbalance is compensated either by addition of weight or removal of weight.

The **dynamic unbalance** results in a difference of position between the main axis of inertia and the axis of rotation that generates vibrations. So, the defect can be corrected on two planes.

The standard ISO 1940 (rotors balancing) determines the **allowable unbalance** (U, g.mm) depending on class (G) and speed rotation (N, rpm) of the tool-holder

$$U = \frac{9549 \times G \times M \text{ tool-holder}}{N}$$

BALANCING ADVANTAGES

- Reduced **vibrations**.
- Improved **surface finish**.
- Improved **tool life**.
- Optimized **spindle stability**.

OUR BALANCING SOLUTION

Elco balances all tool holders in relation to their operational RPM and weight to work in conjunction with high RPM spindles.

As seen in the chart below, all tool holders are balanced within a tight allowable unbalance range:

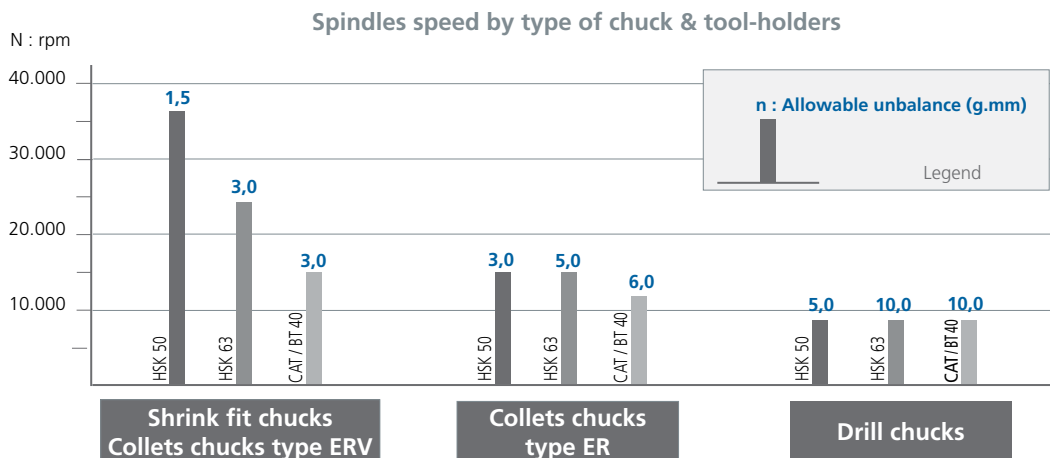

For all specific applications, a more precise balancing can be done on request.

TOOL-HOLDERS

10 - 37

CAT40 SHRINK FIT HOLDERS	10
CAT40 SHRINK FIT PACKAGES	13
CAT50 SHRINK FIT HOLDERS	14
CAT50 SHRINK FIT PACKAGES	17
BT30/40 SHRINK FIT HOLDERS	18
BT30/40 SHRINK FIT PACKAGES	21
BT50 SHRINK FIT HOLDERS	22
BT50 SHRINK FIT PACKAGES	25
HSK63A SHRINK FIT HOLDERS	26
HSK63A SHRINK FIT PACKAGES	29
HSK100A SHRINK FIT HOLDERS	30
HSK100A SHRINK FIT PACKAGES	33
HSK32/40/50E SHRINK FIT HOLDERS	34
HSK63/80F SHRINK FIT HOLDERS	35
SHRINK FIT EXTENSIONS	36
SHRINK FIT REDUCTIONS	37
ACCESSORIES	37

Standard: DIN Form B (Plugged)
 Material: H11 High Alloy Steel
 Hardness: 52 HRC tempered
 Runout: .00040" to .00012" at 3 X Diameter of Tool
 Balancing: <3g.mm at 20,000 RPM (CAT40)
 <10g.mm at 15,000 RPM (CAT50)
 Balanceable upon request
 Cooling: Center-thru or Flange Thru Coolant

Features: All shrink fit holders 6 mm (1/4") and above include a backup screw.
 Application: Compatible with h6 tolerance Steel, HSS, Carbide
 Accessories: **Compatible with Part# RE011 shrink fit reductions and shrink fit extensions (see pages 36-37). Replacement Backup Screw (see page 37).**

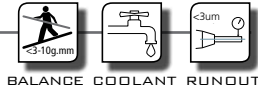

STANDARD TYPE

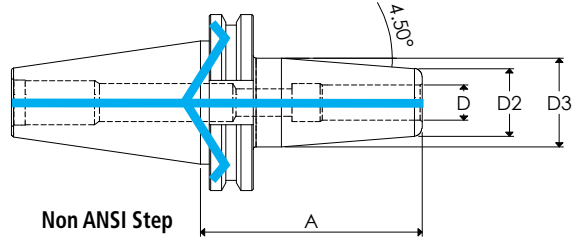

INCH

Part Number	D	A	D2	D3
CAT40-SF0125-3.15	1/8"	3.15"	0.39"	0.71"
CAT40-SF0187-3.15	3/16"	3.15"	0.39"	0.63"
CAT40-SF0250-3.15	1/4"	3.15"	0.83"	1.06"
CAT40-SF0375-3.15	3/8"	3.15"	0.94"	1.26"
CAT40-SF0500-3.15	1/2"	3.15"	0.94"	1.26"
CAT40-SF0625-3.15	5/8"	3.15"	1.06"	1.34"
CAT40-SF0750-3.15	3/4"	3.15"	1.30"	1.65"
CAT40-SF1000-3.94	1"	3.94"	1.73"	2.09"

METRIC

Part Number	D	A	D2	D3
CAT40-SF3-80	3mm	80	10	18
CAT40-SF6-80	6mm	80	21	27
CAT40-SF8-80	8mm	80	21	27
CAT40-SF10-80	10mm	80	24	32
CAT40-SF12-80	12mm	80	24	32
CAT40-SF16-80	16mm	80	27	34
CAT40-SF20-80	20mm	80	33	42
CAT40-SF25-100	25mm	100	44	53

EXTENDED TYPE

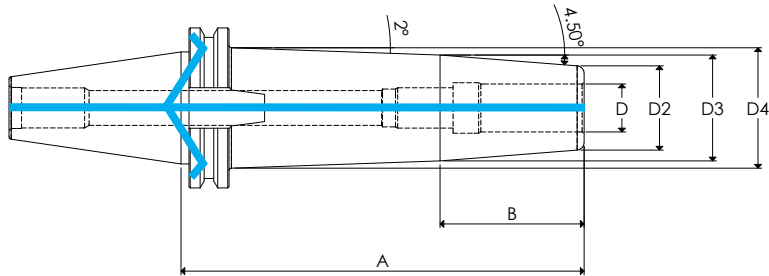

Part Number	D	A	D2	D3	D4	B
CAT40-SF0125-6.30	1/8"	6.30"	0.39"	0.63"	1.26"	1.50"
CAT40-SF0250-5.12	1/4"	5.12"	0.83"	1.06"	1.26"	1.50"
CAT40-SF0250-6.30	1/4"	6.30"	0.83"	1.06"	1.35"	1.50"
CAT40-SF0375-5.12	3/8"	5.12"	0.94"	1.26"	1.43"	2.00"
CAT40-SF0375-6.30	3/8"	6.30"	0.94"	1.26"	1.51"	2.00"
CAT40-SF0500-5.12	1/2"	5.12"	0.94"	1.26"	1.43"	2.00"
CAT40-SF0500-6.30	1/2"	6.30"	0.94"	1.26"	1.51"	2.00"
CAT40-SF0625-5.12	5/8"	5.12"	1.06"	1.34"	1.60"	1.75"
CAT40-SF0625-6.30	5/8"	6.30"	1.06"	1.34"	1.60"	1.75"
CAT40-SF0750-5.12	3/4"	5.12"	1.30"	1.65"	1.80"	2.25"
CAT40-SF0750-6.30	3/4"	6.30"	1.30"	1.65"	1.88"	2.25"
CAT40-SF1000-5.12	1"	5.12"	1.73"	2.09"	2.23"	2.25"
CAT40-SF1000-6.30	1"	6.30"	1.73"	2.09"	2.32"	2.25"

Part Number	D	A	D2	D3	D4	B
CAT40-SF3-160	3mm	160	10	19	34.18	38.12
CAT40-SF6-160	6mm	160	21	27	34.18	38.12
CAT40-SF8-160	8mm	160	21	27	34.18	38.12
CAT40-SF10-160	10mm	160	24	32	38.29	50.83
CAT40-SF12-160	12mm	160	24	32	38.29	50.83
CAT40-SF16-160	16mm	160	27	34	40.73	44.47
CAT40-SF20-160	20mm	160	33	42	47.85	57.38
CAT40-SF25-160	25mm	160	44	53	58.85	57.18



RUNOUT COOLANT BALANCE

COOLANT PORT OPTION

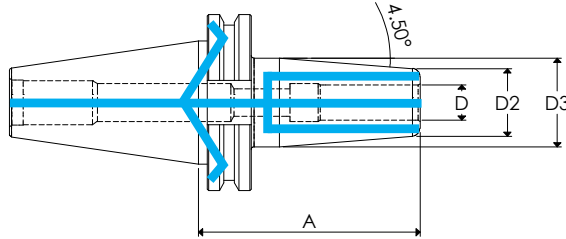

STANDARD TYPE



Part Number	D	A	D2	D3
CAT40-SF0250-3.15CP	1/4"	3.15"	0.83"	1.06"
CAT40-SF0375-3.15CP	3/8"	3.15"	0.94"	1.26"
CAT40-SF0500-3.15CP	1/2"	3.15"	0.94"	1.26"
CAT40-SF0625-3.15CP	5/8"	3.15"	1.06"	1.34"
CAT40-SF0750-3.15CP	3/4"	3.15"	1.30"	1.65"
CAT40-SF1000-3.94CP	1"	3.94"	1.73"	2.09"

METRIC

Part Number	D	A	D2	D3
CAT40-SF8-80CP	8mm	80	21	27
CAT40-SF10-80CP	10mm	80	24	32
CAT40-SF12-80CP	12mm	80	24	32
CAT40-SF16-80CP	16mm	80	27	34
CAT40-SF20-80CP	20mm	80	33	42
CAT40-SF25-100CP	25mm	100	44	53

INCH

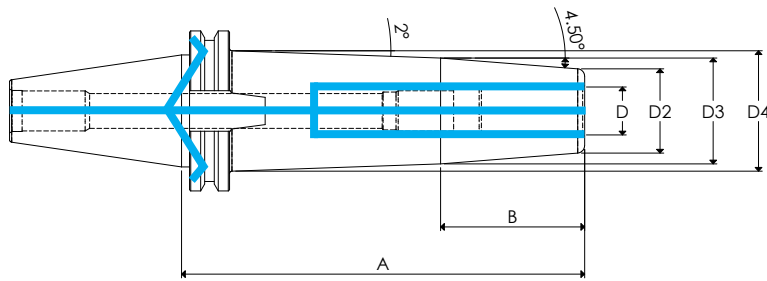

EXTENDED TYPE



Part Number	D	A	D2	D3	D4	B
CAT40-SF0250-5.12CP	1/4"	5.12"	0.83"	1.06"	1.26"	1.50"
CAT40-SF0250-6.30CP	1/4"	6.30"	0.83"	1.06"	1.35"	1.50"
CAT40-SF0375-5.12CP	3/8"	5.12"	0.94"	1.26"	1.43"	2.00"
CAT40-SF0375-6.30CP	3/8"	6.30"	0.94"	1.26"	1.51"	2.00"
CAT40-SF0500-5.12CP	1/2"	5.12"	0.94"	1.26"	1.43"	2.00"
CAT40-SF0500-6.30CP	1/2"	6.30"	0.94"	1.26"	1.51"	2.00"
CAT40-SF0625-5.12CP	5/8"	5.12"	1.06"	1.34"	1.60"	1.75"
CAT40-SF0625-6.30CP	5/8"	6.30"	1.06"	1.34"	1.60"	1.75"
CAT40-SF0750-5.12CP	3/4"	5.12"	1.30"	1.65"	1.80"	2.25"
CAT40-SF0750-6.30CP	3/4"	6.30"	1.30"	1.65"	1.88"	2.25"
CAT40-SF1000-5.12CP	1"	5.12"	1.73"	2.09"	2.23"	2.25"
CAT40-SF1000-6.30CP	1"	6.30"	1.73"	2.09"	2.32"	2.25"

Part Number	D	A	D2	D3	D4	B
CAT40-SF8-160CP	8mm	160	21	27	34.18	38.12
CAT40-SF10-160CP	10mm	160	24	32	38.29	50.83
CAT40-SF12-160CP	12mm	160	24	32	38.29	50.83
CAT40-SF16-160CP	16mm	160	27	34	40.73	44.47
CAT40-SF20-160CP	20mm	160	33	42	47.85	57.38
CAT40-SF25-160CP	25mm	160	44	53	58.85	57.18

Standard: DIN Form B (Plugged)
 Material: H11 High Alloy Steel
 Hardness: 52 HRC tempered
 Runout: .000040" to .00012" at 3 X Diameter of Tool
 Balancing: <3g.mm at 20,000 RPM (CAT40)
 <10g.mm at 15,000 RPM (CAT50)
 Cooling: Center-thru and Flange Thru Coolant (plugged)
 Face Coolant (CAT40 Standard and Extended only)

Features: All shrink fit holders 6 mm (1/4") and above include a backup screw.
 Application: Compatible with h6 tolerance Steel, HSS, Carbide
 Accessories: **Compatible with Part# RE011 shrink fit reductions and shrink fit extensions (see pages 36-37). Replacement Backup Screw (see page 37).**



RIGIDITY TYPE

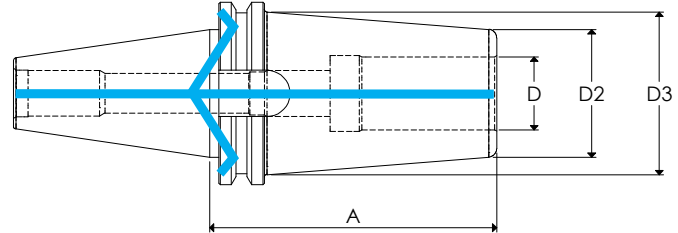

INCH

Part Number	D	A	D2	D3
CAT40-SF0250-2.56RT	1/4"	2.56"	0.79"	1.07"
CAT40-SF0375-2.56RT	3/8"	2.56"	0.94"	1.23"
CAT40-SF0500-2.56RT	1/2"	2.56"	1.06"	1.35"
CAT40-SF0625-2.76RT	5/8"	2.76"	1.30"	1.61"
CAT40-SF0750-2.76RT	3/4"	2.76"	1.30"	2.05"
CAT40-SF1000-2.76RT	1"	2.76"	1.73"	2.13"

*Backup screws not included or used for rigidity type

MOLD TYPE

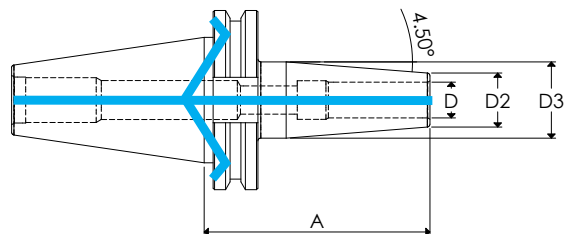

Part Number	D	A	D2	D3
CAT40-SF0125-3.15	1/8"	3.15"	0.39"	0.71"
CAT40-SF0125-6.30MT	1/8"	6.30"	0.35"	0.87"
CAT40-SF0250-3.15MT	1/4"	3.15"	0.39"	0.75"
CAT40-SF0250-6.30MT	1/4"	6.30"	0.39"	0.87"
CAT40-SF0375-3.15MT	3/8"	3.15"	0.47"	0.83"
CAT40-SF0375-6.30MT	3/8"	6.30"	0.47"	1.06"
CAT40-SF0500-3.15MT	1/2"	3.15"	0.63"	0.98"
CAT40-SF0500-6.30MT	1/2"	6.30"	0.63"	1.06"
CAT40-SF0625-3.15MT	5/8"	3.15"	0.63"	0.98"
CAT40-SF0625-6.30MT	5/8"	6.30"	0.63"	1.26"

Part Number	D	A	D2	D3
CAT40-SF3-80*	3mm	80	10	18
CAT40-SF3-160MT*	3mm	160	9	22
CAT40-SF6-80MT*	6mm	80	12	21
CAT40-SF6-160MT*	6mm	160	12	27
CAT40-SF8-80MT*	8mm	80	16	25
CAT40-SF8-160MT*	8mm	160	16	27
CAT40-SF10-80MT*	10mm	80	16	25
CAT40-SF10-160MT*	10mm	160	16	32
CAT40-SF12-80MT*	12mm	80	18	27
CAT40-SF12-160MT*	12mm	160	18	32
CAT40-SF16-80MT*	16mm	80	24	33
CAT40-SF16-160MT*	16mm	160	24	34

*Pricing on Request



SHRINK FIT PACKAGES



SHRINK FIT UNIT + 10 SHRINK FIT HOLDERS

INCLUDES:

SHRINK UNIT



COOLING UNIT



10 SHRINK FIT HOLDERS



FEATURES

- Shrink and unshrink any type of tools and cutters (HSS, Carbide, Heavy Metal, Powdered Metal, etc.)
- Shrink 2- 40mm (5/64"-1.1/2" inch) shank sizes with same unit
- Inductor coil auto size detection eliminates manual parameter setting
- Easy set up to shrink sizes by quickly changing induction rings
- 200-240V/3 Phase/14 kW power required, no transformer needed
- Unique slide-out Control Module allows One-Day Service

5 PIECE INDUCTION RING SET

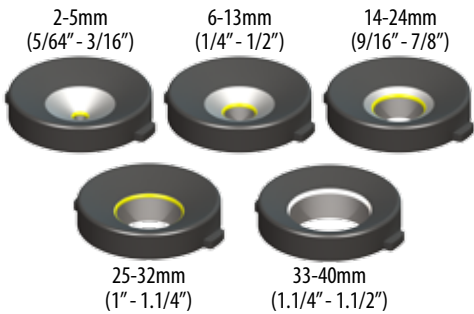

5 PIECE COOLING BRACKET SET

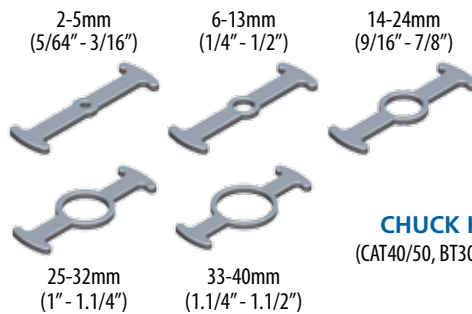

STORAGE RACKS



CHUCK HOLDERS

(CAT40/50, BT30-50, HSK25-100)



CHOOSE FROM THE TOOL PACKAGES BELOW:

STANDARD TYPE

INCH

Part Number
CAT40-SF0125-3.15
CAT40-SF0187-3.15
CAT40-SF0250-3.15
CAT40-SF0375-3.15
CAT40-SF0500-3.15
CAT40-SF0625-3.15
CAT40-SF0750-3.15
CAT40-SF1000-3.94

METRIC

Part Number
CAT40-SF3-80
CAT40-SF6-80
CAT40-SF8-80
CAT40-SF10-80
CAT40-SF12-80
CAT40-SF16-80
CAT40-SF20-80
CAT40-SF25-100

RIGIDITY TYPE

INCH

Part Number
CAT40-SF0250-2.56RT
CAT40-SF0375-2.56RT
CAT40-SF0500-2.56RT
CAT40-SF0625-2.76RT
CAT40-SF0750-2.76RT
CAT40-SF1000-2.76RT

MOLD TYPE

Part Number
CAT40-SF0125-3.15
CAT40-SF0250-3.15MT
CAT40-SF0375-3.15MT
CAT40-SF0500-3.15MT
CAT40-SF0625-3.15MT

Part Number
CAT40-SF3-80
CAT40-SF6-80MT
CAT40-SF8-80MT
CAT40-SF10-80MT
CAT40-SF12-80MT
CAT40-SF16-80MT



Scan here to see current package pricing.

Standard: DIN Form B (Plugged)
 Material: H11 High Alloy Steel
 Hardness: 52 HRC tempered
 Runout: .000040" to .00012" at 3 X Diameter of Tool
 Balancing: <3g.mm at 20,000 RPM (CAT40)
 <10g.mm at 15,000 RPM (CAT50)
 Cooling: Center-thru and Flange Thru Coolant (plugged)
 Face Coolant (CAT40 Standard and Extended only)

Features: All shrink fit holders 6 mm (1/4") and above include a backup screw.
 Application: Compatible with h6 tolerance Steel, HSS, Carbide
 Accessories: **Compatible with Part# RE011 shrink fit reductions and shrink fit extensions (see pages 36-37). Replacement Backup Screw (see page 37).**



STANDARD TYPE

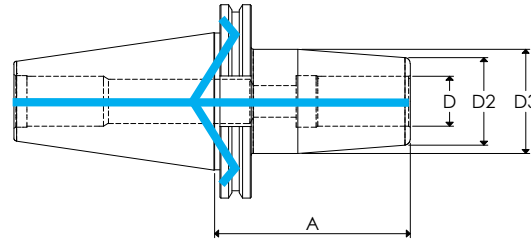

INCH

Part Number	D	A	D2	D3
CAT50-SF0125-3.15	1/8"	3.15"	0.39"	0.71"
CAT50-SF0250-3.15	1/4"	3.15"	0.83"	1.06"
CAT50-SF0375-3.15	3/8"	3.15"	0.94"	1.26"
CAT50-SF0500-3.15	1/2"	3.15"	0.94"	1.26"
CAT50-SF0625-3.15	5/8"	3.15"	1.06"	1.34"
CAT50-SF0750-3.15	3/4"	3.15"	1.30"	1.65"
CAT50-SF1000-3.94	1"	3.94"	1.73"	2.09"
CAT50-SF1250-3.94	1.1/4"	3.94"	1.73"	2.09"

METRIC

Part Number	D	A	D2	D3
CAT50-SF3-80	3mm	80	10	18
CAT50-SF6-80	6mm	80	21	27
CAT50-SF8-80	8mm	80	21	27
CAT50-SF10-80	10mm	80	24	32
CAT50-SF12-80	12mm	80	24	32
CAT50-SF16-80	16mm	80	27	34
CAT50-SF20-80	20mm	80	33	42
CAT50-SF25-100	25mm	100	44	53
CAT50-SF32-100	32mm	100	44	53

EXTENDED TYPE

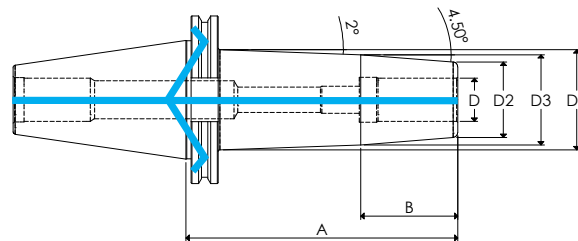

Part Number	D	A	D2	D3	D4	B
CAT50-SF0125-6.30	1/8"	6.30"	0.39"	0.71"	0.95"	2.00"
CAT50-SF0250-5.12	1/4"	5.12"	0.83"	1.06"	1.26"	1.50"
CAT50-SF0250-6.30	1/4"	6.30"	0.83"	1.06"	1.35"	1.50"
CAT50-SF0375-5.12	3/8"	5.12"	0.94"	1.26"	1.43"	2.00"
CAT50-SF0375-6.30	3/8"	6.30"	0.94"	1.26"	1.51"	2.00"
CAT50-SF0500-5.12	1/2"	5.12"	0.94"	1.26"	1.43"	2.00"
CAT50-SF0500-6.30	1/2"	6.30"	0.94"	1.26"	1.51"	2.00"
CAT50-SF0625-5.12	5/8"	5.12"	1.06"	1.34"	1.52"	1.75"
CAT50-SF0625-6.30	5/8"	6.30"	1.06"	1.34"	1.60"	1.75"
CAT50-SF0750-5.12	3/4"	5.12"	1.30"	1.65"	1.80"	2.25"
CAT50-SF0750-6.30	3/4"	6.30"	1.30"	1.65"	1.88"	2.25"
CAT50-SF1000-5.12	1"	5.12"	1.73"	2.09"	2.23"	2.25"
CAT50-SF1000-6.30	1"	6.30"	1.73"	2.09"	2.32"	2.25"
CAT50-SF1250-5.12	1.1/4"	5.12"	1.73"	2.09"	2.23"	2.25"
CAT50-SF1250-6.30	1.1/4"	6.30"	1.73"	2.09"	2.32"	2.25"

Part Number	D	A	D2	D3	D4	B
CAT50-SF3-160	3mm	160	10	30	34.18	38.12
CAT50-SF6-160	6mm	160	21	27	34.18	38.12
CAT50-SF8-160	8mm	160	21	38	34.18	38.12
CAT50-SF10-160	10mm	160	24	32	38.29	50.83
CAT50-SF12-160	12mm	160	24	32	38.29	50.83
CAT50-SF16-160	16mm	160	27	34	40.73	44.47
CAT50-SF20-160	20mm	160	33	42	47.85	57.18
CAT50-SF25-160	25mm	160	44	53	58.85	57.18
CAT50-SF32-160	32mm	160	44	53	58.85	57.18



RUNOUT COOLANT BALANCE

COOLANT PORT OPTION

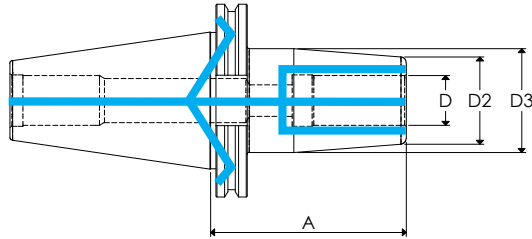

STANDARD TYPE



Part Number	D	A	D2	D3
CAT50-SF0250-3.15CP	1/4"	3.15"	0.83"	1.06"
CAT50-SF0375-3.15CP	3/8"	3.15"	0.94"	1.26"
CAT50-SF0500-3.15CP	1/2"	3.15"	0.94"	1.26"
CAT50-SF0625-3.15CP	5/8"	3.15"	1.06"	1.34"
CAT50-SF0750-3.15CP	3/4"	3.15"	1.30"	1.65"
CAT50-SF1000-3.94CP	1"	3.94"	1.73"	2.09"
CAT50-SF1250-3.94CP	1.1/4"	3.94"	1.73"	2.09"

METRIC

Part Number	D	A	D2	D3
CAT50-SF8-80CP	8mm	80	21	27
CAT50-SF10-80CP	10mm	80	24	32
CAT50-SF12-80CP	12mm	80	24	32
CAT50-SF16-80CP	16mm	80	27	34
CAT50-SF20-80CP	20mm	80	33	42
CAT50-SF25-100CP	25mm	100	44	53
CAT50-SF32-100CP	32mm	100	44	53

INCH

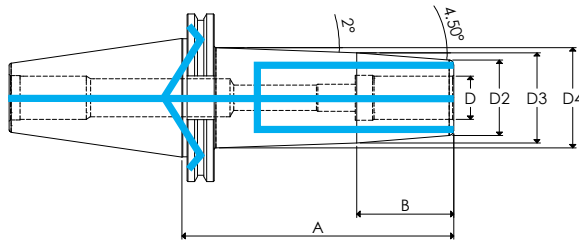

EXTENDED TYPE



Part Number	D	A	D2	D3	D4	B
CAT50-SF0250-5.12CP	1/4"	5.12"	0.83"	1.06"	1.26"	1.50"
CAT50-SF0250-6.30CP	1/4"	6.30"	0.83"	1.06"	1.35"	1.50"
CAT50-SF0375-5.12CP	3/8"	5.12"	0.94"	1.26"	1.43"	2.00"
CAT50-SF0375-6.30CP	3/8"	6.30"	0.94"	1.26"	1.51"	2.00"
CAT50-SF0500-5.12CP	1/2"	5.12"	0.94"	1.26"	1.43"	2.00"
CAT50-SF0500-6.30CP	1/2"	6.30"	0.94"	1.26"	1.51"	2.00"
CAT50-SF0625-5.12CP	5/8"	5.12"	1.06"	1.34"	1.52"	1.75"
CAT50-SF0625-6.30CP	5/8"	6.30"	1.06"	1.34"	1.60"	1.75"
CAT50-SF0750-5.12CP	3/4"	5.12"	1.30"	1.65"	1.80"	2.25"
CAT50-SF0750-6.30CP	3/4"	6.30"	1.30"	1.65"	1.88"	2.25"
CAT50-SF1000-5.12CP	1"	5.12"	1.73"	2.09"	2.23"	2.25"
CAT50-SF1000-6.30CP	1"	6.30"	1.73"	2.09"	2.32"	2.25"
CAT50-SF1250-5.12CP	1.1/4"	5.12"	1.73"	2.09"	2.23"	2.25"
CAT50-SF1250-6.30CP	1.1/4"	6.30"	1.73"	2.09"	2.32"	2.25"

Part Number	D	A	D2	D3	D4	B
CAT50-SF8-160CP	8mm	160	21	38	34.18	38.12
CAT50-SF10-160CP	10mm	160	24	32	38.29	50.83
CAT50-SF12-160CP	12mm	160	24	32	38.29	50.83
CAT50-SF16-160CP	16mm	160	27	34	40.73	44.47
CAT50-SF20-160CP	20mm	160	33	42	47.85	57.18
CAT50-SF25-160CP	25mm	160	44	53	58.85	57.18
CAT50-SF32-160CP	32mm	160	44	53	58.85	57.18

Standard: DIN Form B (Plugged)
 Material: H11 High Alloy Steel
 Hardness: 52 HRC tempered
 Runout: .000040" to .00012" at 3 X Diameter of Tool
 Balancing: <3g.mm at 20,000 RPM (CAT40)
 <10g.mm at 15,000 RPM (CAT50)
 Cooling: Center-thru and Flange Thru Coolant (plugged)
 Face Coolant (CAT40 Standard and Extended only)

Features: All shrink fit holders 6 mm (1/4") and above include a backup screw.
 Application: Compatible with h6 tolerance Steel, HSS, Carbide
 Accessories: **Compatible with Part# RE011 shrink fit reductions and shrink fit extensions (see pages 36-37). Replacement Backup Screw (see page 37).**



MOLD TYPE

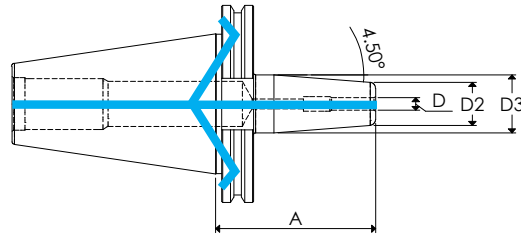

INCH

Part Number	D	A	D2	D3
CAT50-SF0125-3.15*	1/8"	3.15"	0.39"	0.71"
CAT50-SF0125-6.30MT*	1/8"	6.30"	0.35"	0.87"
CAT50-SF0250-3.15MT*	1/4"	3.15"	0.47"	0.83"
CAT50-SF0250-6.30MT*	1/4"	6.30"	0.47"	1.06"
CAT50-SF0375-3.15MT*	3/8"	3.15"	0.63"	0.98"
CAT50-SF0375-6.30MT*	3/8"	6.30"	0.63"	1.26"
CAT50-SF0500-3.15MT*	1/2"	3.15"	0.71"	1.06"
CAT50-SF0500-6.30MT*	1/2"	6.30"	0.71"	1.26"
CAT50-SF0625-3.15MT*	5/8"	3.15"	0.95"	1.30"
CAT50-SF0625-6.30MT*	5/8"	6.30"	0.95"	1.34"

*Pricing on Request

METRIC

Part Number	D	A	D2	D3
CAT50-SF3-80	3mm	80	10	18
CAT50-SF3-160MT	3mm	160	9	22
CAT50-SF6-80MT	6mm	80	12	21
CAT50-SF6-160MT	6mm	160	12	27
CAT50-SF8-80MT	8mm	80	16	25
CAT50-SF8-160MT	8mm	160	16	27
CAT50-SF10-80MT	10mm	80	16	25
CAT50-SF10-160MT	10mm	160	16	32
CAT50-SF12-80MT	12mm	80	18	27
CAT50-SF12-160MT	12mm	160	18	32
CAT50-SF16-80MT	16mm	80	24	33
CAT50-SF16-160MT	16mm	160	24	34





SHRINK FIT PACKAGES



SHRINK FIT UNIT + 10 SHRINK FIT HOLDERS

INCLUDES:

SHRINK UNIT



COOLING UNIT



10 SHRINK FIT HOLDERS



FEATURES

- Shrink and unshrink any type of tools and cutters (HSS, Carbide, Heavy Metal, Powdered Metal, etc.)
- Shrink 2- 40mm (5/64"-1.1/2" inch) shank sizes with same unit
- Inductor coil auto size detection eliminates manual parameter setting
- Easy set up to shrink sizes by quickly changing induction rings
- 200-240V/3 Phase/14 kW power required, no transformer needed
- Unique slide-out Control Module allows One-Day Service

5 PIECE INDUCTION RING SET

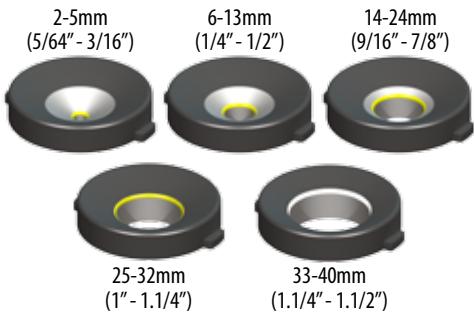

5 PIECE COOLING BRACKET SET

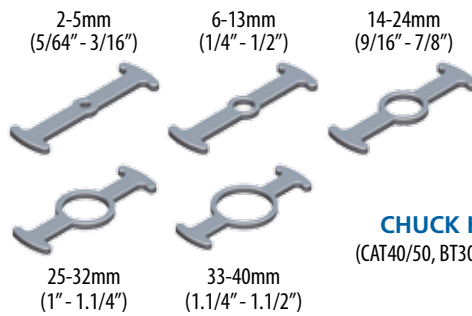

STORAGE RACKS



CHUCK HOLDERS

(CAT40/50, BT30-50, HSK25-100)



CHOOSE FROM THE TOOL PACKAGES BELOW:

STANDARD TYPE

Part Number
CAT50-SF0125-3.15
CAT50-SF0250-3.15
CAT50-SF0375-3.15
CAT50-SF0500-3.15
CAT50-SF0625-3.15
CAT50-SF0750-3.15
CAT50-SF1000-3.94
CAT50-SF1250-3.94

INCH

Part Number
CAT50-SF3-80
CAT50-SF6-80
CAT50-SF8-80
CAT50-SF10-80
CAT50-SF12-80
CAT50-SF16-80
CAT50-SF20-80
CAT50-SF25-100
CAT50-SF32-100

METRIC

MOLD TYPE

Part Number
CAT50-SF0125-3.15
CAT50-SF0250-3.15MT
CAT50-SF0375-3.15MT
CAT50-SF0500-3.15MT
CAT50-SF0625-3.15MT

INCH

Part Number
CAT50-SF3-80
CAT50-SF6-80MT
CAT50-SF8-80MT
CAT50-SF10-80MT
CAT50-SF12-80MT
CAT50-SF16-80MT

METRIC



Scan here to see current package pricing.

Standard: JIS B 6339 Form B (Plugged)
 Material: H11 High Alloy Steel
 Hardness: 52 HRC tempered
 Runout: .000040" to .00012" at 3 X Diameter of Tool
 Balancing: <1.5g.mm at 30,000 RPM (BT30)
 <3g.mm at 20,000 RPM (BT40)
 Cooling: Center-thru and Flange Thru Coolant (plugged)
 Face Coolant (BT40 Standard and Extended only)

Features: All shrink fit holders 6 mm (1/4") and above include a backup screw.
 Application: Compatible with h6 tolerance Steel, HSS, Carbide
 Accessories: **Compatible with Part# RE011 shrink fit reductions and shrink fit extensions (see pages 36-37). Replacement Backup Screw (see page 37).**

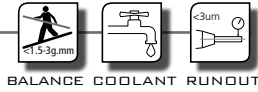

STANDARD TYPE

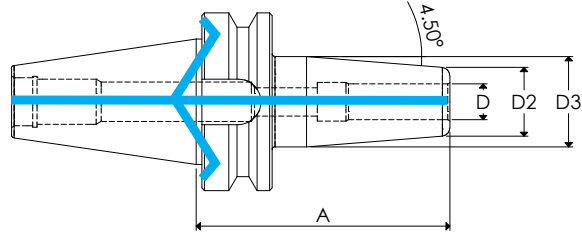

INCH

Part Number	D	A	D2	D3
BT30-SF0125-3.15	1/8"	3.15"	0.39"	0.71"
BT30-SF0250-3.15	1/4"	3.15"	0.83"	1.06"
BT30-SF0375-3.15	3/8"	3.15"	0.94"	1.22"
BT30-SF0500-3.15	1/2"	3.15"	0.94"	1.22"
BT30-SF0625-3.15	5/8"	3.15"	1.06"	1.34"
BT30-SF0750-3.15	3/4"	3.15"	1.30"	1.54"
BT40-SF0125-3.54	1/8"	3.54"	0.39"	0.71"
BT40-SF0250-3.54	1/4"	3.54"	0.79"	1.06"
BT40-SF0375-3.54	3/8"	3.54"	0.94"	1.26"
BT40-SF0500-3.54	1/2"	3.54"	0.94"	1.26"
BT40-SF0625-3.54	5/8"	3.54"	1.06"	1.34"
BT40-SF0750-3.54	3/4"	3.54"	1.30"	1.65"
BT40-SF1000-3.94	1"	3.94"	1.73"	2.09"

METRIC

Part Number	D	A	D2	D3
BT40-SF6-90	6mm	90	20	27
BT40-SF8-90	8mm	90	20	27
BT40-SF10-90	10mm	90	24	32
BT40-SF12-90	12mm	90	24	32
BT40-SF16-90	16mm	90	27	34
BT40-SF20-90	20mm	90	33	42
BT40-SF25-100	25mm	100	44	53

EXTENDED TYPE

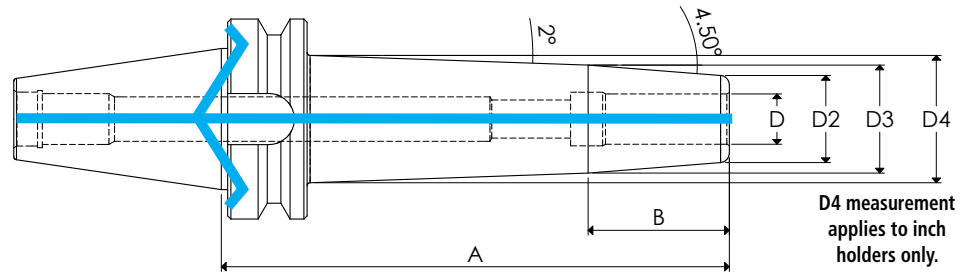

D4 measurement applies to inch holders only.

Part Number	D	A	D2	D3	D4	B
BT40-SF0125-6.30	1/8"	6.30"	0.39"	0.71"	1.32"	1.50"
BT40-SF0250-6.30	1/4"	6.30"	0.79"	1.06"	1.32"	1.50"
BT40-SF0375-6.30	3/8"	6.30"	0.94"	1.26"	1.49"	2.00"
BT40-SF0500-6.30	1/2"	6.30"	0.94"	1.26"	1.49"	2.00"
BT40-SF0625-6.30	5/8"	6.30"	1.06"	1.34"	1.58"	1.75"
BT40-SF0750-6.30	3/4"	6.30"	1.30"	1.65"	1.86"	2.25"
BT40-SF1000-6.30	1"	6.30"	1.73"	2.09"	2.30"	2.25"

Part Number	D	A	D2	D3	B
BT40-SF6-160	6mm	160	20	27	38.12
BT40-SF8-160	8mm	160	20	27	38.12
BT40-SF10-160	10mm	160	24	32	50.83
BT40-SF12-160	12mm	160	24	32	50.83
BT40-SF16-160	16mm	160	27	34	44.47
BT40-SF20-160	20mm	160	33	42	57.18
BT40-SF25-160	25mm	160	44	53	57.18



RUNDOUT COOLANT BALANCE

COOLANT PORT OPTION

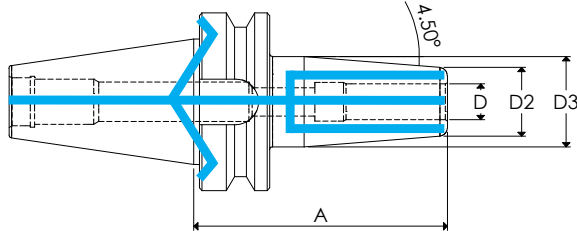

STANDARD TYPE



Part Number	D	A	D2	D3
BT40-SF0250-3.54CP	1/4"	3.54"	0.79"	1.06"
BT40-SF0375-3.54CP	3/8"	3.54"	0.94"	1.26"
BT40-SF0500-3.54CP	1/2"	3.54"	0.94"	1.26"
BT40-SF0625-3.54CP	5/8"	3.54"	1.06"	1.34"
BT40-SF0750-3.54CP	3/4"	3.54"	1.30"	1.65"
BT40-SF1000-3.94CP	1"	3.94"	1.73"	2.09"

Part Number	D	A	D2	D3
BT40-SF8-90CP	8mm	90	20	27
BT40-SF10-90CP	10mm	90	24	32
BT40-SF12-90CP	12mm	90	24	32
BT40-SF16-90CP	16mm	90	27	34
BT40-SF20-90CP	20mm	90	33	42
BT40-SF25-100CP	25mm	100	44	53

INCH

METRIC

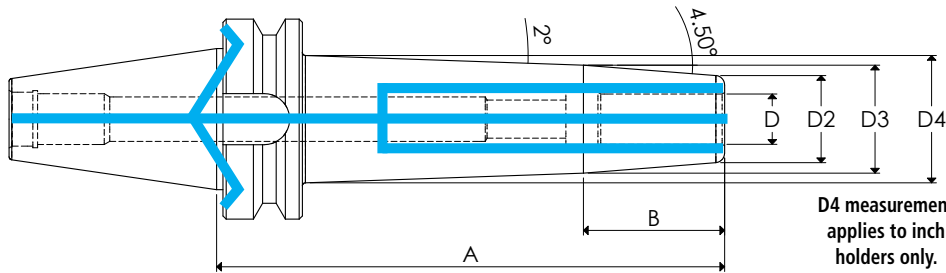

EXTENDED TYPE



D4 measurement applies to inch holders only.

Part Number	D	A	D2	D3	D4	B
BT40-SF0250-6.30CP	1/4"	6.30"	0.79"	1.06"	1.32"	1.50"
BT40-SF0375-6.30CP	3/8"	6.30"	0.94"	1.26"	1.49"	2.00"
BT40-SF0500-6.30CP	1/2"	6.30"	0.94"	1.26"	1.49"	2.00"
BT40-SF0625-6.30CP	5/8"	6.30"	1.06"	1.34"	1.58"	1.75"
BT40-SF0750-6.30CP	3/4"	6.30"	1.30"	1.65"	1.86"	2.25"
BT40-SF1000-6.30CP	1"	6.30"	1.73"	2.09"	2.30"	2.25"

Part Number	D	A	D2	D3	B
BT40-SF8-160CP	8mm	160	20	27	38.12
BT40-SF10-160CP	10mm	160	24	32	50.83
BT40-SF12-160CP	12mm	160	24	32	50.83
BT40-SF16-160CP	16mm	160	27	34	44.47
BT40-SF20-160CP	20mm	160	33	42	57.18
BT40-SF25-160CP	25mm	160	44	53	57.18

Standard: JIS B 6339 Form B (Plugged)
 Material: H11 High Alloy Steel
 Hardness: 52 HRC tempered
 Runout: .000040" to .00012" at 3 X Diameter of Tool
 Balancing: <1.5g.mm at 30,000 RPM (BT30)
 <3g.mm at 20,000 RPM (BT40)
 Cooling: Center-thru and Flange Thru Coolant (plugged)
 Face Coolant (BT40 Standard and Extended only)

Features: All shrink fit holders 6 mm (1/4") and above include a backup screw.
 Application: Compatible with h6 tolerance Steel, HSS, Carbide
 Accessories: **Compatible with Part# RE011 shrink fit reductions and shrink fit extensions (see pages 36-37). Replacement Backup Screw (see page 37).**

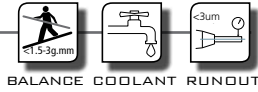

RIGIDITY TYPE

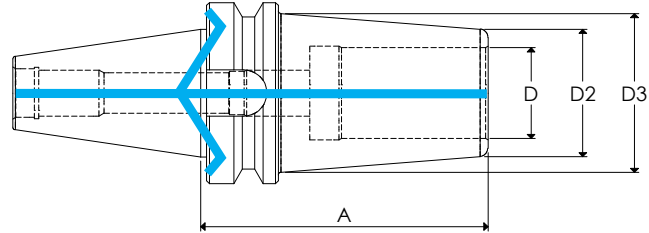

INCH

Part Number	D	A	D2	D3
BT40-SF0250-2.56RT	1/4"	2.56"	0.79"	1.02"
BT40-SF0375-2.56RT	3/8"	2.56"	0.95"	1.18"
BT40-SF0500-2.56RT	1/2"	2.56"	1.06"	1.30"
BT40-SF0625-2.76RT	5/8"	2.76"	1.30"	1.57"
BT40-SF0750-2.76RT	3/4"	2.76"	1.73"	2.00"
BT40-SF1000-2.76RT	1"	2.76"	1.81"	2.08"

*Backup screws not included or used for rigidity type

MOLD TYPE

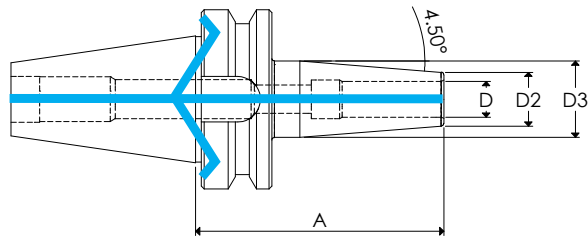

Part Number	D	A	D2	D3
BT40-SF0125-3.54	1/8"	3.54"	0.39"	0.71"
BT40-SF0125-6.30MT	1/8"	6.30"	0.35"	0.87"
BT40-SF0250-3.54MT	1/4"	3.54"	0.47"	0.83"
BT40-SF0250-6.30MT	1/4"	6.30"	0.47"	1.06"
BT40-SF0375-3.54MT	3/8"	3.54"	0.63"	0.98"
BT40-SF0375-6.30MT	3/8"	6.30"	0.63"	1.26"
BT40-SF0500-3.54MT	1/2"	3.54"	0.71"	1.06"
BT40-SF0500-6.30MT	1/2"	6.30"	0.71"	1.26"
BT40-SF0625-3.54MT	5/8"	3.54"	0.95"	1.30"
BT40-SF0625-6.30MT	5/8"	6.30"	0.95"	1.34"

Part Number	D	A	D2	D3
BT40-SF3-90MT	3mm	90	9	18
BT40-SF3-160MT	3mm	160	9	22
BT40-SF4-90MT	4mm	90	10	19
BT40-SF4-160MT	4mm	160	10	22
BT40-SF5-90MT	5mm	90	11	20
BT40-SF5-160MT	5mm	160	11	22
BT40-SF6-90MT	6mm	90	12	21
BT40-SF6-160MT	6mm	160	12	27
BT40-SF8-90MT	8mm	90	16	25
BT40-SF8-160MT	8mm	160	16	27
BT40-SF10-90MT	10mm	90	16	25
BT40-SF10-160MT	10mm	160	16	32
BT40-SF12-90MT	12mm	90	18	27
BT40-SF12-160MT	12mm	160	18	32
BT40-SF16-90MT	16mm	90	24	33
BT40-SF16-160MT	16mm	160	24	34



SHRINK FIT PACKAGES

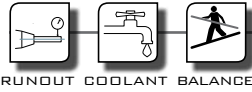

SHRINK FIT UNIT + 10 SHRINK FIT HOLDERS

INCLUDES:

SHRINK UNIT



COOLING UNIT



10 SHRINK FIT HOLDERS



FEATURES

- Shrink and unshrink any type of tools and cutters (HSS, Carbide, Heavy Metal, Powdered Metal, etc.)
- Shrink 2- 40mm (5/64"-1.1/2" inch) shank sizes with same unit
- Inductor coil auto size detection eliminates manual parameter setting
- Easy set up to shrink sizes by quickly changing induction rings
- 200-240V/3 Phase/14 kW power required, no transformer needed
- Unique slide-out Control Module allows One-Day Service

5 PIECE INDUCTION RING SET

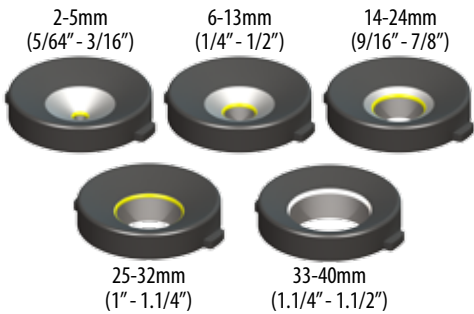

5 PIECE COOLING BRACKET SET

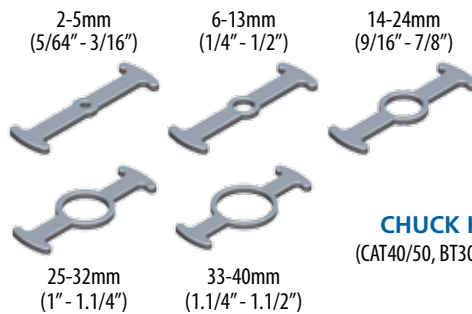

STORAGE RACKS



CHUCK HOLDERS

(CAT40/50, BT30-50, HSK25-100)



CHOOSE FROM THE TOOL PACKAGES BELOW:

STANDARD TYPE

INCH

Part Number
BT30SF-0125-3.15
BT30SF-0250-3.15
BT30SF-0375-3.15
BT30SF-0500-3.15
BT30SF-0625-3.15
BT30SF-0750-3.15
BT40-SF0125-3.54
BT40-SF0250-3.54
BT40-SF0375-3.54
BT40-SF0500-3.54
BT40-SF0625-3.54
BT40-SF0750-3.54
BT40-SF1000-3.94

METRIC

Part Number
BT40-SF6-90
BT40-SF8-90
BT40-SF10-90
BT40-SF12-90
BT40-SF16-90
BT40-SF20-90
BT40-SF25-100

RIGIDITY TYPE

INCH

Part Number
BT40-SF0250-2.56RT
BT40-SF0375-2.56RT
BT40-SF0500-2.56RT
BT40-SF0625-2.76RT
BT40-SF0750-2.76RT
BT40-SF1000-2.76RT

MOLD TYPE

Part Number
BT40-SF0125-3.54
BT40-SF0250-3.54MT
BT40-SF0375-3.54MT
BT40-SF0500-3.54MT
BT40-SF0625-3.54MT

Part Number
BT40-SF3-90MT
BT40-SF6-90MT
BT40-SF8-90MT
BT40-SF10-90MT
BT40-SF12-90MT
BT40-SF16-90MT



Scan here to see current package pricing.

Standard: JIS B 6339 Form B (Plugged)
 Material: H11 High Alloy Steel
 Hardness: 52 HRC tempered
 Runout: .000040" to .00012" at 3 X Diameter of Tool
 Balancing: <3g.mm at 20,000 RPM (BT40)
 <10g.mm at 15,000 RPM (BT50)
 Cooling: Center-thru and Flange Thru Coolant (plugged)
 Face Coolant (BT40 Standard and Extended only)

Features: All shrink fit holders 6 mm (1/4") and above include a backup screw.
 Application: Compatible with h6 tolerance Steel, HSS, Carbide
 Accessories: **Compatible with Part# RE011 shrink fit reductions and shrink fit extensions (see pages 36-37). Replacement Backup Screw (see page 37).**



STANDARD TYPE

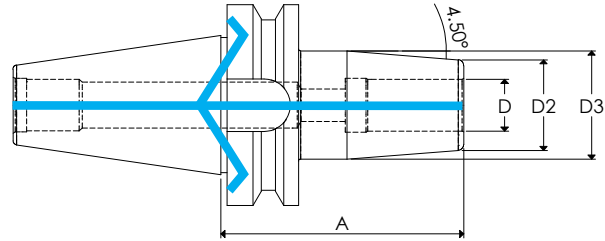

INCH

Part Number	D	A	D2	D3
BT50-SF0125-3.94*	1/8"	3.94"	0.39"	0.71"
BT50-SF0250-3.94*	1/4"	3.94"	0.79"	1.06"
BT50-SF0375-3.94*	3/8"	3.94"	0.94"	1.26"
BT50-SF0500-3.94*	1/2"	3.94"	0.94"	1.26"
BT50-SF0625-3.94*	5/8"	3.94"	1.06"	1.34"
BT50-SF0750-3.94*	3/4"	3.94"	1.30"	1.65"
BT50-SF1000-3.94*	1"	3.94"	1.73"	2.09"
BT50-SF1250-3.94*	1.1/4"	3.94"	1.73"	2.09"

METRIC

Part Number	D	A	D2	D3
BT50-SF6-100	6mm	100	20	27
BT50-SF8-100	8mm	100	20	27
BT50-SF10-100	10mm	100	24	32
BT50-SF12-100	12mm	100	24	32
BT50-SF16-100	16mm	100	27	34
BT50-SF20-100	20mm	100	33	42
BT50-SF25-100	25mm	100	44	53
BT50-SF32-100	32mm	100	44	53

*Pricing on Request

EXTENDED TYPE

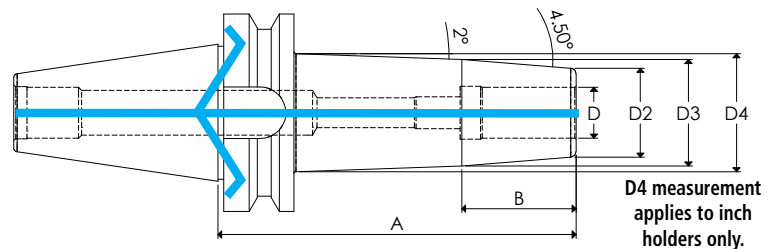

D4 measurement applies to inch holders only.

Part Number	D	A	D2	D3	D4	B
BT50-SF0125-6.30*	1/8"	6.30"	0.39"	1.15"	1.32"	1.50"
BT50-SF0250-6.30*	1/4"	6.30"	0.79"	1.06"	1.32"	1.50"
BT50-SF0375-6.30*	3/8"	6.30"	0.94"	1.26"	1.32"	1.50"
BT50-SF0500-6.30*	1/2"	6.30"	0.94"	1.26"	1.49"	2.00"
BT50-SF0625-6.30*	5/8"	6.30"	1.06"	1.34"	1.49"	2.00"
BT50-SF0750-6.30*	3/4"	6.30"	1.30"	1.65"	1.78"	1.75"
BT50-SF1000-6.30*	1"	6.30"	1.73"	2.09"	2.29"	2.25"
BT50-SF1250-6.30*	1.1/4"	6.30"	1.73"	2.09"	2.30"	2.25"

Part Number	D	A	D2	D3	B
BT50-SF6-160	6mm	160	20	27	38.12
BT50-SF8-160	8mm	160	20	27	38.12
BT50-SF10-160	10mm	160	24	32	50.83
BT50-SF12-160	12mm	160	24	32	50.83
BT50-SF16-160	16mm	160	27	34	44.47
BT50-SF20-160	20mm	160	33	42	57.18
BT50-SF25-160	25mm	160	44	53	57.18
BT50-SF32-160	32mm	160	44	53	57.18

*Pricing on Request

COOLANT PORT OPTION

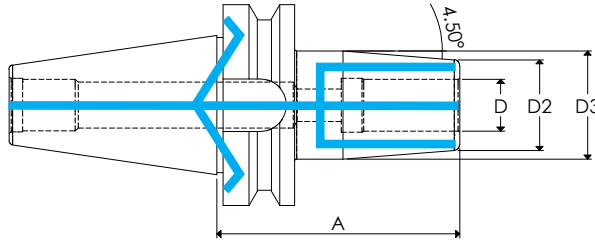

STANDARD TYPE



Part Number	D	A	D2	D3
BT50-SF0250-3.94CP*	1/4"	3.94"	0.79"	1.06"
BT50-SF0375-3.94CP*	3/8"	3.94"	0.94"	1.26"
BT50-SF0500-3.94CP*	1/2"	3.94"	0.94"	1.26"
BT50-SF0625-3.94CP*	5/8"	3.94"	1.06"	1.34"
BT50-SF0750-3.94CP*	3/4"	3.94"	1.30"	1.65"
BT50-SF1000-3.94CP*	1"	3.94"	1.73"	2.09"
BT50-SF1250-3.94CP*	1.1/4"	3.94"	1.73"	2.09"

Part Number	D	A	D2	D3
BT50-SF8-100CP*	8mm	100	20	27
BT50-SF10-100CP*	10mm	100	24	32
BT50-SF12-100CP*	12mm	100	24	32
BT50-SF16-100CP*	16mm	100	27	34
BT50-SF20-100CP*	20mm	100	33	42
BT50-SF25-100CP*	25mm	100	44	53
BT50-SF32-100CP*	32mm	100	44	53

INCH

METRIC

*Pricing on Request

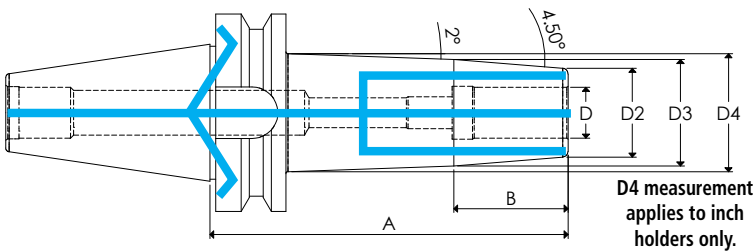

EXTENDED TYPE



Part Number	D	A	D2	D3	D4	B
BT50-SF0250-6.30CP*	1/4"	6.30"	0.79"	1.06"	1.32"	1.50"
BT50-SF0375-6.30CP*	3/8"	6.30"	0.94"	1.26"	1.32"	1.50"
BT50-SF0500-6.30CP*	1/2"	6.30"	0.94"	1.26"	1.49"	2.00"
BT50-SF0625-6.30CP*	5/8"	6.30"	1.06"	1.34"	1.49"	2.00"
BT50-SF0750-6.30CP*	3/4"	6.30"	1.30"	1.65"	1.78"	1.75"
BT50-SF1000-6.30CP*	1"	6.30"	1.73"	2.09"	2.29"	2.25"
BT50-SF1250-6.30CP*	1.1/4"	6.30"	1.73"	2.09"	2.30"	2.25"

Part Number	D	A	D2	D3	B
BT50-SF8-160CP*	8mm	160	20	27	38.12
BT50-SF10-160CP*	10mm	160	24	32	50.83
BT50-SF12-160CP*	12mm	160	24	32	50.83
BT50-SF16-160CP*	16mm	160	27	34	44.47
BT50-SF20-160CP*	20mm	160	33	42	57.18
BT50-SF25-160CP*	25mm	160	44	53	57.18
BT50-SF32-160CP*	32mm	160	44	53	57.18

*Pricing on Request

D4 measurement applies to inch holders only.

Standard: JIS B 6339 Form B (Plugged)
 Material: H11 High Alloy Steel
 Hardness: 52 HRC tempered
 Runout: .000040" to .00012" at 3 X Diameter of Tool
 Balancing: <3g.mm at 20,000 RPM (BT40)
 <10g.mm at 15,000 RPM (BT50)
 Cooling: Center-thru and Flange Thru Coolant (plugged)
 Face Coolant (BT40 Standard and Extended only)

Features: All shrink fit holders 6 mm (1/4") and above include a backup screw.
 Application: Compatible with h6 tolerance Steel, HSS, Carbide
 Accessories: **Compatible with Part# RE011 shrink fit reductions and shrink fit extensions (see pages 36-37). Replacement Backup Screw (see page 37).**



MOLD TYPE

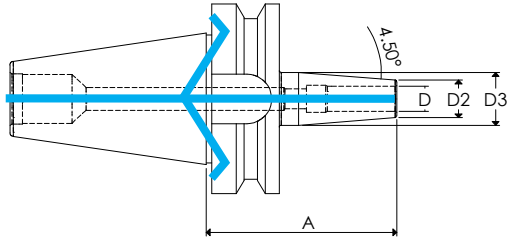

INCH

Part Number	D	A	D2	D3
BT50-SF0125-3.94*	1/8"	3.94"	0.39"	0.71"
BT50-SF0250-3.94MT*	1/4"	3.94"	0.47"	0.79"
BT50-SF0250-6.30MT*	1/4"	6.30"	0.47"	1.06"
BT50-SF0312-3.94MT*	5/16"	3.94"	0.63"	0.94"
BT50-SF0312-6.30MT*	5/16"	6.30"	0.63"	1.06"
BT50-SF0375-3.94MT*	3/8"	3.94"	0.63"	0.94"
BT50-SF0375-6.30MT*	3/8"	6.30"	0.63"	1.26"
BT50-SF0500-3.94MT*	1/2"	3.94"	0.71"	1.02"
BT50-SF0500-6.30MT*	1/2"	6.30"	0.71"	1.26"
BT50-SF0625-3.94MT*	5/8"	3.94"	0.94"	1.26"
BT50-SF0625-6.30MT*	5/8"	6.30"	0.94"	1.34"

*Pricing on Request

METRIC

Part Number	D	A	D2	D3
BT50-SF3-100MT	3mm	100	9	17
BT50-SF3-160MT	3mm	160	9	22
BT50-SF6-100MT	6mm	100	12	20
BT50-SF6-160MT	6mm	160	12	27
BT50-SF8-100MT	8mm	100	16	24
BT50-SF8-160MT	8mm	160	16	27
BT50-SF10-100MT	10mm	100	16	24
BT50-SF10-160MT	10mm	160	16	32
BT50-SF12-100MT	12mm	100	18	26
BT50-SF12-160MT	12mm	160	18	32
BT50-SF16-100MT	16mm	100	24	32
BT50-SF16-160MT	16mm	160	24	34





SHRINK FIT PACKAGES



RUNOUT COOLANT BALANCE

SHRINK FIT UNIT + 10 SHRINK FIT HOLDERS

INCLUDES:

SHRINK UNIT



COOLING UNIT



10 SHRINK FIT HOLDERS



FEATURES

- Shrink and unshrink any type of tools and cutters (HSS, Carbide, Heavy Metal, Powdered Metal, etc.)
- Shrink 2- 40mm (5/64"-1.1/2" inch) shank sizes with same unit
- Inductor coil auto size detection eliminates manual parameter setting
- Easy set up to shrink sizes by quickly changing induction rings
- 200-240V/3 Phase/14 kW power required, no transformer needed
- Unique slide-out Control Module allows One-Day Service

5 PIECE INDUCTION RING SET

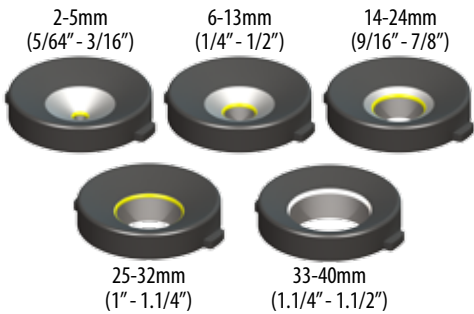

5 PIECE COOLING BRACKET SET

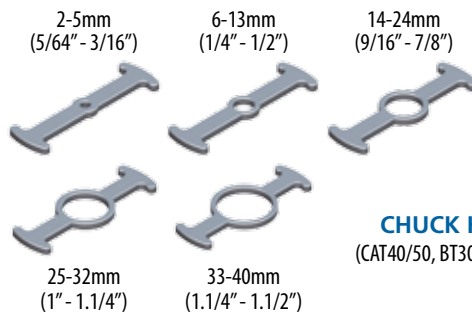

STORAGE RACKS



CHUCK HOLDERS

(CAT40/50, BT30-50, HSK25-100)



CHOOSE FROM THE TOOL PACKAGES BELOW:

STANDARD TYPE

INCH

Part Number
BT50-SF0125-3.94
BT50-SF0250-3.94
BT50-SF0375-3.94
BT50-SF0500-3.94
BT50-SF0625-3.94
BT50-SF0750-3.94
BT50-SF1000-3.94
BT50-SF1250-3.94

METRIC

Part Number
BT50-SF3-100
BT50-SF6-100
BT50-SF8-100
BT50-SF10-100
BT50-SF12-100
BT50-SF16-100
BT50-SF20-100
BT50-SF25-100
BT50-SF32-100

MOLD TYPE

INCH

Part Number
BT50-SF0125-3.94
BT50-SF0250-3.94MT
BT50-SF0312-3.94MT
BT50-SF0375-3.94MT
BT50-SF0500-3.94MT
BT50-SF0625-3.94MT

METRIC

Part Number
BT50-SF3-100MT
BT50-SF6-100MT
BT50-SF8-100MT
BT50-SF10-100MT
BT50-SF12-100MT
BT50-SF16-100MT



Scan here to see current package pricing.

Standard: DIN69893A/ DIN 69882-8
 Material: H11 High Alloy Steel
 Hardness: 52 HRC tempered
 Runout: .000040" to .00012" at 3 X Diameter of Tool
 Balancing: <3g.mm at 24,000 RPM (HSK63A)
 Cooling: Center-thru and Face Coolant (HSK63A Standard and Extended only)

Features: All shrink fit holders 6 mm (1/4") and above include a backup screw.
 Application: Compatible with h6 tolerance Steel, HSS, Carbide
 Accessories: **Compatible with Part# RE011 shrink fit reductions and shrink fit extensions (see pages 36-37). Replacement Backup Screw (see page 37). HSK63A Coolant Tube and wrench (not included, see page 37 to order).**

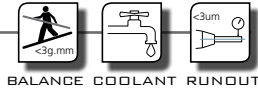

STANDARD TYPE

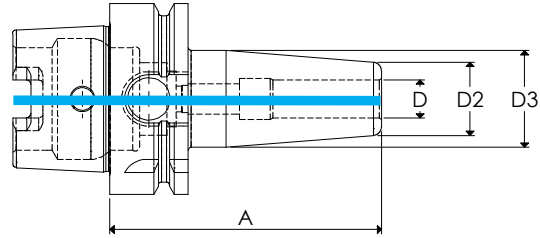

INCH

Part Number	D	A	D2	D3
H63A-SF0250-3.15	1/4"	3.15"	0.79"	1.06"
H63A-SF0312-3.15	5/16"	3.15"	0.79"	1.06"
H63A-SF0375-3.35	3/8"	3.35"	0.94"	1.26"
H63A-SF0500-3.54	1/2"	3.54"	0.94"	1.26"
H63A-SF0625-3.74	5/8"	3.74"	1.06"	1.34"
H63A-SF0750-3.94	3/4"	3.94"	1.30"	1.65"
H63A-SF1000-4.53	1"	4.53"	1.73"	2.09"

METRIC

Part Number	D	A	D2	D3
H63A-SF6-80	6mm	80	20	27
H63A-SF8-80	8mm	80	20	27
H63A-SF10-85	10mm	85	24	32
H63A-SF12-90	12mm	90	24	32
H63A-SF16-95	16mm	95	27	34
H63A-SF20-100	20mm	100	33	42
H63A-SF25-115	25mm	115	44	53

EXTENDED TYPE

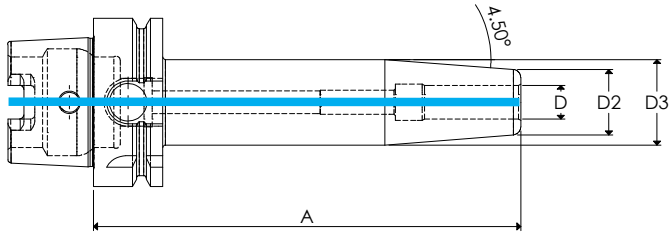

Part Number	D	A	D2	D3
H63A-SF0250-4.72	1/4"	4.72"	0.79"	1.06"
H63A-SF0250-6.30	1/4"	6.30"	0.79"	1.06"
H63A-SF0312-4.72	5/16"	4.72"	0.79"	1.06"
H63A-SF0312-6.30	5/16"	6.30"	0.79"	1.06"
H63A-SF0375-4.72	3/8"	4.72"	0.95"	1.26"
H63A-SF0375-6.30	3/8"	6.30"	0.95"	1.26"
H63A-SF0500-4.72	1/2"	4.72"	0.95"	1.26"
H63A-SF0500-6.30	1/2"	6.30"	0.95"	1.26"
H63A-SF0625-4.72	5/8"	4.72"	1.06"	1.34"
H63A-SF0625-6.30	5/8"	6.30"	1.06"	1.34"
H63A-SF0750-6.30	3/4"	6.30"	1.30"	1.65"
H63A-SF1000-6.30	1"	6.30"	1.73"	2.07"

Part Number	D	A	D2	D3
H63A-SF6-120	6mm	120	20	27
H63A-SF6-160	6mm	160	20	27
H63A-SF8-120	8mm	120	20	27
H63A-SF8-160	8mm	160	20	27
H63A-SF10-120	10mm	120	24	32
H63A-SF10-160	10mm	160	24	32
H63A-SF12-120	12mm	120	24	32
H63A-SF12-160	12mm	160	24	32
H63A-SF16-120	16mm	120	27	34
H63A-SF16-160	16mm	160	27	34
H63A-SF20-160	20mm	160	33	42
H63A-SF25-160	25mm	160	44	52.6

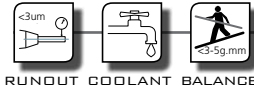

COOLANT PORT OPTION

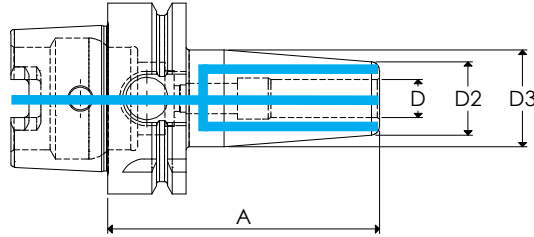

STANDARD TYPE



INCH

Part Number	D	A	D2	D3
H63A-SF0250-3.15CP	1/4"	3.15"	0.79"	1.06"
H63A-SF0312-3.15CP	5/16"	3.15"	0.79"	1.06"
H63A-SF0375-3.15CP	3/8"	3.35"	0.94"	1.26"
H63A-SF0500-3.54CP	1/2"	3.54"	0.94"	1.26"
H63A-SF0625-3.74CP	5/8"	3.74"	1.06"	1.34"
H63A-SF0750-3.94CP	3/4"	3.94"	1.30"	1.65"
H63A-SF1000-4.53CP	1"	4.53"	1.73"	2.09"

METRIC

Part Number	D	A	D2	D3
H63A-SF8-80CP	8mm	80	20	27
H63A-SF10-85CP	10mm	85	24	32
H63A-SF12-90CP	12mm	90	24	32
H63A-SF16-95CP	16mm	95	27	34
H63A-SF20-100CP	20mm	100	33	42
H63A-SF25-115CP	25mm	115	44	53

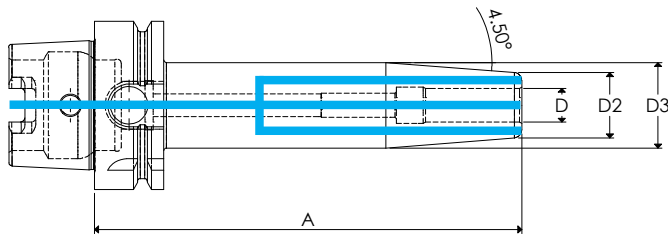

EXTENDED TYPE



Part Number	D	A	D2	D3
H63A-SF0250-4.72CP	1/4"	4.72"	0.79"	1.06"
H63A-SF0250-6.30CP	1/4"	6.30"	0.79"	1.06"
H63A-SF0312-4.72CP	5/16"	4.72"	0.79"	1.06"
H63A-SF0312-6.30CP	5/16"	6.30"	0.79"	1.06"
H63A-SF0375-4.72CP	3/8"	4.72"	0.95"	1.26"
H63A-SF0375-6.30CP	3/8"	6.30"	0.95"	1.26"
H63A-SF0500-4.72CP	1/2"	4.72"	0.95"	1.26"
H63A-SF0500-6.30CP	1/2"	6.30"	0.95"	1.26"
H63A-SF0625-4.72CP	5/8"	4.72"	1.06"	1.34"
H63A-SF0625-6.30CP	5/8"	6.30"	1.06"	1.34"
H63A-SF0750-6.30CP	3/4"	6.30"	1.30"	1.65"
H63A-SF1000-6.30CP	1"	6.30"	1.73"	2.07"

Part Number	D	A	D2	D3
H63A-SF8-120CP	8mm	120	20	27
H63A-SF8-160CP	8mm	160	20	27
H63A-SF10-120CP	10mm	120	24	32
H63A-SF10-160CP	10mm	160	24	32
H63A-SF12-120CP	12mm	120	24	32
H63A-SF12-160CP	12mm	160	24	32
H63A-SF16-120CP	16mm	120	27	34
H63A-SF16-160CP	16mm	160	27	34
H63A-SF20-160CP	20mm	160	33	42
H63A-SF25-160CP	25mm	160	44	52.6

Standard: DIN69893A
 Material: H11 High Alloy Steel
 Hardness: 52 HRC tempered
 Runout: .000040" to .00012" at 3 X Diameter of Tool
 Balancing: <3g.mm at 24,000 RPM (HSK63A)
 <3g.mm at 33,000 RPM (HSK80F)
 <5g.mm at 15,000 RPM (HSK100A)
 Cooling: Center-thru and Face Coolant (HSK63A Standard and Extended only)

Features: All shrink fit holders 6 mm (1/4") and above include a backup screw.
 Application: Compatible with h6 tolerance Steel, HSS, Carbide
 Accessories: **Compatible with Part# RE011 shrink fit reductions and shrink fit extensions (see pages 36-37). Replacement Backup Screw (see page 37). HSK63A Coolant Tube and wrench (not included, see page 37 to order).**

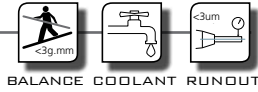

RIGIDITY TYPE

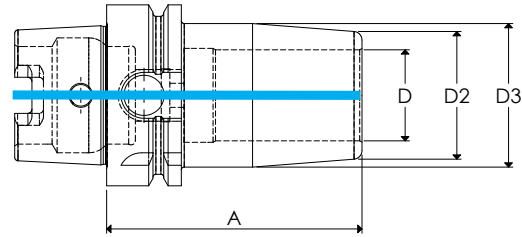

INCH

Part Number	D	A	D2	D3
H63A-SF0250-2.56RT	1/4"	2.56"	0.79"	1.03"
H63A-SF0375-2.56RT	3/8"	2.56"	0.95"	1.19"
H63A-SF0500-2.95RT	1/2"	2.95"	1.06"	1.37"
H63A-SF0625-2.95RT	5/8"	2.95"	1.30"	1.60"
H63A-SF0750-2.95RT	3/4"	2.95"	1.73"	2.04"
H63A-SF1000-3.35RT	1"	3.35"	1.81"	2.18"

*Backup screws not included or used for rigidity type

MOLD TYPE

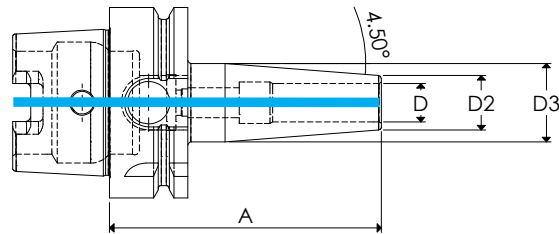

Part Number	D	A	D2	D3
H63A-SF0125-3.15MT	1/8"	3.15"	0.35"	0.63"
H63A-SF0125-6.30MT	1/8"	6.30"	0.35"	0.87"
H63A-SF0250-3.15MT	1/4"	3.15"	0.47"	0.75"
H63A-SF0250-6.30MT	1/4"	6.30"	0.47"	1.06"
H63A-SF0375-3.15MT	3/8"	3.15"	0.63"	0.91"
H63A-SF0375-6.30MT	3/8"	6.30"	0.63"	1.26"
H63A-SF0500-3.15MT	1/2"	3.15"	0.71"	1.02"
H63A-SF0500-6.30MT	1/2"	6.30"	0.71"	1.26"
H63A-SF0625-3.15MT	5/8"	3.15"	0.95"	1.30"
H63A-SF0625-6.30MT	5/8"	6.30"	0.95"	1.34"

Part Number	D	A	D2	D3
H63A-SF3-80MT	3mm	80	9	16
H63A-SF3-160MT	3mm	160	9	22
H63A-SF6-80MT	6mm	80	12	19
H63A-SF6-160MT	6mm	160	12	27
H63A-SF10-80MT	10mm	80	16	23
H63A-SF10-160MT	10mm	160	16	32
H63A-SF12-80MT	12mm	80	18	26
H63A-SF12-160MT	12mm	160	18	32
H63A-SF16-80MT	16mm	80	24	33
H63A-SF16-160MT	16mm	160	24	34



SHRINK FIT PACKAGES

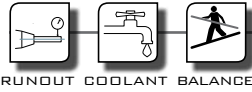

RUNOUT COOLANT BALANCE

SHRINK FIT UNIT + 10 SHRINK FIT HOLDERS

INCLUDES:

SHRINK UNIT



COOLING UNIT



10 SHRINK FIT HOLDERS



FEATURES

- Shrink and unshrink any type of tools and cutters (HSS, Carbide, Heavy Metal, Powdered Metal, etc.)
- Shrink 2- 40mm (5/64"-1.1/2" inch) shank sizes with same unit
- Inductor coil auto size detection eliminates manual parameter setting
- Easy set up to shrink sizes by quickly changing induction rings
- 200-240V/3 Phase/14 kW power required, no transformer needed
- Unique slide-out Control Module allows One-Day Service

5 PIECE INDUCTION RING SET

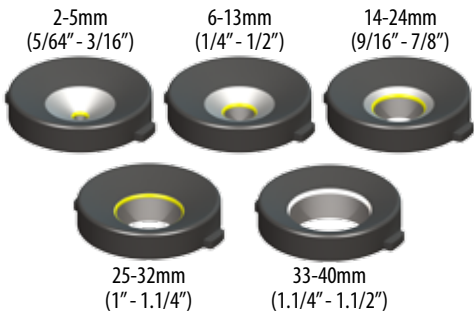

5 PIECE COOLING BRACKET SET

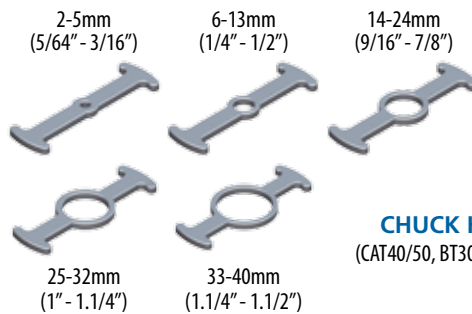

STORAGE RACKS



CHUCK HOLDERS

(CAT40/50, BT30-50, HSK25-100)



CHOOSE FROM THE TOOL PACKAGES BELOW:

STANDARD TYPE

Part Number
H63A-SF0250-3.15
H63A-SF0375-3.35
H63A-SF0500-3.54
H63A-SF0625-3.74
H63A-SF0750-3.94
H63A-SF1000-4.53

INCH

Part Number
H63A-SF6-80
H63A-SF10-85
H63A-SF12-90
H63A-SF16-95
H63A-SF20-100
H63A-SF25-115

METRIC

RIGIDITY TYPE

Part Number
H63A-SF0250-2.56
H63A-SF0375-2.56
H63A-SF0500-2.95
H63A-SF0625-2.95
H63A-SF0750-2.95
H63A-SF1000-3.35

INCH

MOLD TYPE

Part Number
H63A-SF0125-3.15
H63A-SF0250-3.15
H63A-SF0375-3.15
H63A-SF0500-3.15
H63A-SF0625-3.15

Part Number
H63A-SF3-80
H63A-SF6-80
H63A-SF10-80
H63A-SF12-80
H63A-SF16-80



Scan here to see current package pricing.

Standard: DIN69893A/ DIN 69882-8
 Material: H11 High Alloy Steel
 Hardness: 52 HRC tempered
 Runout: .000040" to .00012" at 3 X Diameter of Tool
 Balancing: <5g.mm at 15,000 RPM (HSK100A)
 Cooling: Center-thru and Face Coolant (HSK100A Standard and Extended only)

Features: All shrink fit holders 6 mm (1/4") and above include a backup screw.
 Application: Compatible with h6 tolerance Steel, HSS, Carbide
 Accessories: **Compatible with Part# RE011 shrink fit reductions and shrink fit extensions (see pages 36-37). Replacement Backup Screw (see page 37). HSK100A Coolant Tube and wrench (not included, see page 37 to order).**

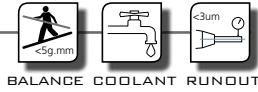

STANDARD TYPE

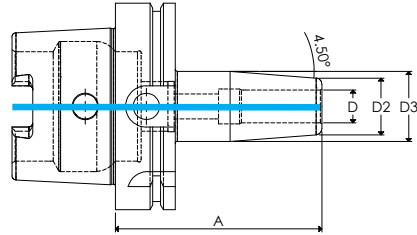

INCH

Part Number	D	A	D2	D3
H100A-SF0250-3.54	1/4"	3.54"	0.83"	1.14"
H100A-SF0375-3.54	3/8"	3.54"	0.94"	1.26"
H100A-SF0500-3.74	1/2"	3.74"	0.94"	1.26"
H100A-SF0625-3.94	5/8"	3.94"	1.06"	1.34"
H100A-SF0750-4.13	3/4"	4.13"	1.30"	1.65"
H100A-SF1000-4.53	1"	4.53"	1.73"	2.09"
H100A-SF1250-4.72	1.1/4"	4.72"	1.73"	2.09"

METRIC

Part Number	D	A	D2	D3
H100A-SF6-85	6mm	85	21	27
H100A-SF10-90	10mm	90	24	32
H100A-SF12-95	12mm	95	24	32
H100A-SF16-100	16mm	100	27	34
H100A-SF20-105	20mm	105	33	42
H100A-SF25-115	25mm	115	44	53
H100A-SF32-120	32mm	120	44	53

EXTENDED TYPE

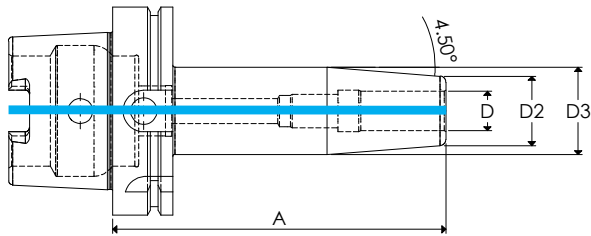

Part Number	D	A	D2	D3
H100A-SF0250-6.30	1/4"	6.30"	0.83"	1.06"
H100A-SF0375-6.30	3/8"	6.30"	0.94"	1.26"
H100A-SF0500-6.30	1/2"	6.30"	0.94"	1.26"
H100A-SF0625-6.30	5/8"	6.30"	1.06"	1.34"
H100A-SF0750-6.30	3/4"	6.30"	1.30"	1.65"
H100A-SF1000-6.30	1"	6.30"	1.73"	2.09"
H100A-SF1250-6.30	1.1/4"	6.30"	1.73"	2.09"

Part Number	D	A	D2	D3
H100A-SF6-160	6mm	160	21	27
H100A-SF10-160	10mm	160	24	32
H100A-SF12-160	12mm	160	24	32
H100A-SF16-160	16mm	160	27	34
H100A-SF20-160	20mm	160	33	42
H100A-SF25-160	25mm	160	44	53
H100A-SF32-160	32mm	160	44	53



RUNOUT COOLANT BALANCE

COOLANT PORT OPTION

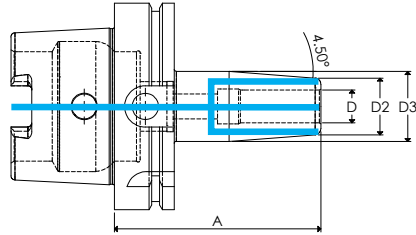

STANDARD TYPE



Part Number	D	A	D2	D3
H100A-SF0250-3.54CP	1/4"	3.54"	0.83"	1.14"
H100A-SF0375-3.54CP	3/8"	3.54"	0.94"	1.26"
H100A-SF0500-3.74CP	1/2"	3.74"	0.94"	1.26"
H100A-SF0625-3.94CP	5/8"	3.94"	1.06"	1.34"
H100A-SF0750-4.13CP	3/4"	4.13"	1.30"	1.65"
H100A-SF1000-4.53CP	1"	4.53"	1.73"	2.09"
H100A-SF1250-4.72CP	1.1/4"	4.72"	1.73"	2.09"

Part Number	D	A	D2	D3
H100A-SF10-90CP	10mm	90	24	32
H100A-SF12-95CP	12mm	95	24	32
H100A-SF16-100CP	16mm	100	27	34
H100A-SF20-105CP	20mm	105	33	42
H100A-SF25-115CP	25mm	115	44	53
H100A-SF32-120CP	32mm	120	44	53

INCH

METRIC

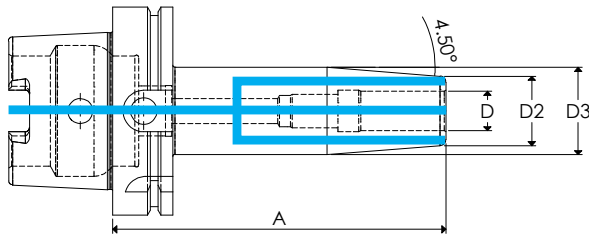

EXTENDED TYPE



Part Number	D	A	D2	D3
H100A-SF0250-6.30CP	1/4"	6.30"	0.83"	1.06"
H100A-SF0375-6.30CP	3/8"	6.30"	0.94"	1.26"
H100A-SF0500-6.30CP	1/2"	6.30"	0.94"	1.26"
H100A-SF0625-6.30CP	5/8"	6.30"	1.06"	1.34"
H100A-SF0750-6.30CP	3/4"	6.30"	1.30"	1.65"
H100A-SF1000-6.30CP	1"	6.30"	1.73"	2.09"
H100A-SF1250-6.30CP	1.1/4"	6.30"	1.73"	2.09"

Part Number	D	A	D2	D3
H100A-SF10-160CP	10mm	160	24	32
H100A-SF12-160CP	12mm	160	24	32
H100A-SF16-160CP	16mm	160	27	34
H100A-SF20-160CP	20mm	160	33	42
H100A-SF25-160CP	25mm	160	44	53
H100A-SF32-160CP	32mm	160	44	53

Standard: DIN69893A
 Material: H11 High Alloy Steel
 Hardness: 52 HRC tempered
 Runout: .000040" to .00012" at 3 X Diameter of Tool
 Balancing: <5g.mm at 15,000 RPM (HSK100A)
 Cooling: Center-thru and Face Coolant (HSK100A Standard and Extended only)

Features: All shrink fit holders 6 mm (1/4") and above include a backup screw.
 Application: Compatible with h6 tolerance Steel, HSS, Carbide
 Accessories: **Compatible with Part# RE011 shrink fit reductions and shrink fit extensions (see pages 36-37). Replacement Backup Screw (see page 37). HSK100A Coolant Tube and wrench (not included, see page 37 to order).**

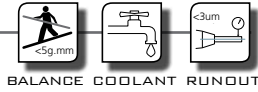

MOLD TYPE

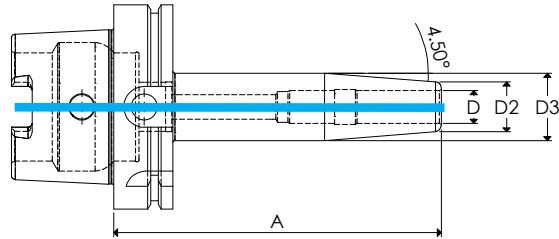

INCH

Part Number	D	A	D2	D3
H100A-SF0250-3.35MT	1/4"	3.35"	0.47"	0.75"
H100A-SF0375-3.54MT	3/8"	3.54"	0.63"	0.91"
H100A-SF0500-3.74MT	1/2"	3.74"	0.71"	1.02"
H100A-SF0625-3.94MT	5/8"	3.94"	0.95"	1.30"

METRIC

Part Number	D	A	D2	D3
H100A-SF6-85MT	6mm	85	12	19
H100A-SF10-90MT	10mm	90	16	23
H100A-SF12-95MT	12mm	95	18	26
H100A-SF16-100MT	16mm	100	24	33





SHRINK FIT PACKAGES



SHRINK FIT UNIT + 10 SHRINK FIT HOLDERS

INCLUDES:

SHRINK UNIT



COOLING UNIT



10 SHRINK FIT HOLDERS



FEATURES

- Shrink and unshrink any type of tools and cutters (HSS, Carbide, Heavy Metal, Powdered Metal, etc.)
- Shrink 2- 40mm (5/64"-1.1/2" inch) shank sizes with same unit
- Inductor coil auto size detection eliminates manual parameter setting
- Easy set up to shrink sizes by quickly changing induction rings
- 200-240V/3 Phase/14 kW power required, no transformer needed
- Unique slide-out Control Module allows One-Day Service

5 PIECE INDUCTION RING SET

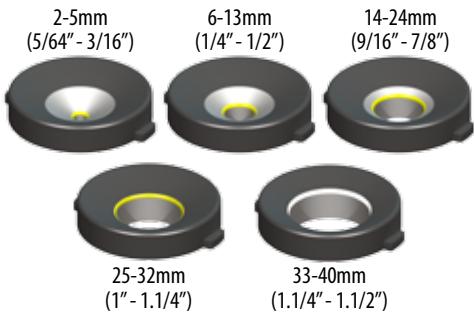

5 PIECE COOLING BRACKET SET

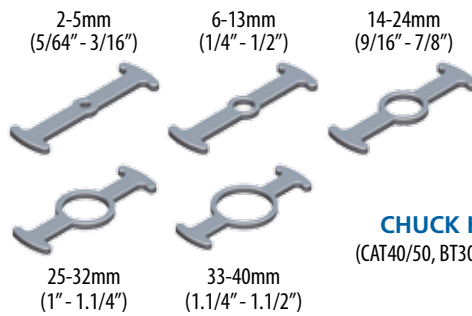

STORAGE RACKS

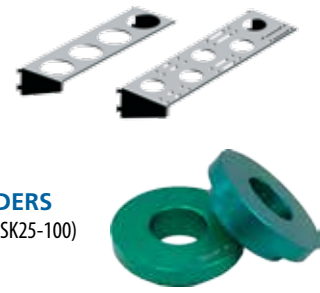

CHUCK HOLDERS (CAT40/50, BT30-50, HSK25-100)

CHOOSE FROM THE TOOL PACKAGES BELOW:

STANDARD TYPE

INCH	Part Number
	H100A-SF0250-3.54
	H100A-SF0375-3.54
	H100A-SF0500-3.74
	H100A-SF0625-3.94
	H100A-SF0750-4.13
	H100A-SF1000-4.53
	H100A-SF1250-4.72

METRIC	Part Number
	H100A-SF6-85
	H100A-SF10-90
	H100A-SF12-95
	H100A-SF16-100
	H100A-SF20-105
	H100A-SF25-115
	H100A-SF32-120

MOLD TYPE

INCH	Part Number
	H100A-SF0250-3.35MT
	H100A-SF0375-3.54MT
	H100A-SF0500-3.74MT
	H100A-SF0625-3.94MT

METRIC	Part Number
	H100A-SF6-85MT
	H100A-SF10-90MT
	H100A-SF12-95MT
	H100A-SF16-100MT



Scan here to see current package pricing.

Standard: DIN69893 HSK E
 Material: H11 High Alloy Steel
 Hardness: 52 HRC tempered
 Runout: .000040" to .00012" at 3 X Diameter of Tool
 Balancing: <1g.mm (HSK32E and 40E) - <1.5g (HSK50E) at 42,000 RPM
 Cooling: Center-thru

Features: All shrink fit holders 6 mm (1/4") and above include a backup screw.
 Application: Compatible with h6 tolerance Steel, HSS, Carbide
 Accessories: **Compatible with Part# RE011 shrink fit reductions and shrink fit extensions (see pages 36-37). Replacement Backup Screw (see page 37). HSK32/40/50E Coolant Tube and wrench (not included, see page 37 to order).**

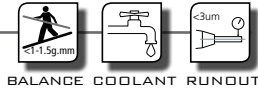

STANDARD TYPE

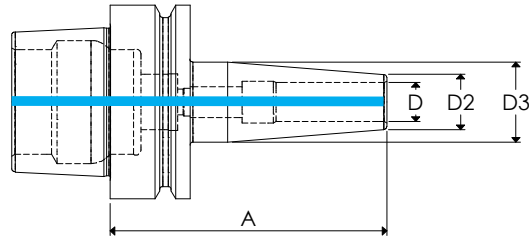

INCH

Part Number	D	A	D2	D3
H32E-SF0125-2.76	1/8"	2.76"	0.35"	-
H32E-SF0250-2.76	1/4"	2.76"	0.79"	1.06"
H32E-SF0375-2.95	3/8"	2.95"	0.95"	1.26"
H40E-SF0250-3.15	1/4"	3.15"	0.79"	1.06"
H40E-SF0375-3.15	3/8"	3.15"	0.95"	1.26"
H40E-SF0500-3.54	1/2"	3.54"	0.95"	1.26"
H40E-SF0625-3.54	5/8"	3.54"	1.06"	1.34"
H50E-SF0250-3.15	1/4"	3.15"	0.79"	1.06"
H50E-SF0375-3.35	3/8"	3.35"	0.95"	1.26"
H50E-SF0500-3.54	1/2"	3.54"	0.95"	1.26"
H50E-SF0625-3.54	5/8"	3.54"	1.06"	1.34"

METRIC

Part Number	D	A	D2	D3
H32E-SF3-70	3mm	70	9	-
H32E-SF6-70	6mm	70	20	27
H32E-SF10-75	10mm	75	24	32
H40E-SF4-70	4mm	70	10	-
H40E-SF6-80	6mm	80	20	27
H40E-SF10-80	10mm	80	24	32
H40E-SF12-90	12mm	90	24	32
H40E-SF16-90	16mm	90	27	34
H50E-SF4-80	4mm	80	10	22
H50E-SF6-80	6mm	80	20	27
H50E-SF10-85	10mm	85	24	32
H50E-SF12-90	12mm	90	24	32
H50E-SF16-90	16mm	90	27	34

MOLD TYPE

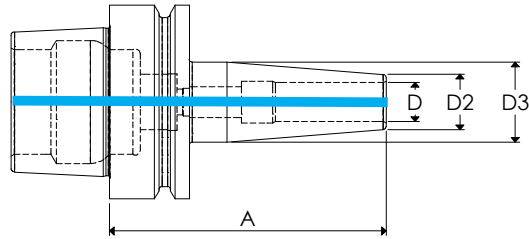

Part Number	D	A	D2	D3
H50E-SF0125-6.30MT	1/8"	6.30"	0.35"	0.87"
H50E-SF0250-6.30MT	1/4"	6.30"	0.47"	1.06"
H50E-SF0375-6.30MT	3/8"	6.30"	0.63"	1.26"
H50E-SF0500-6.30MT	1/2"	6.30"	0.71"	1.26"
H50E-SF0625-6.30MT	5/8"	6.30"	0.95"	1.34"

Part Number	D	A	D2	D3
H50E-SF3-160MT	3mm	160	9	22
H50E-SF6-160MT	6mm	160	12	27
H50E-SF10-160MT	10mm	160	16	32
H50E-SF12-160MT	12mm	160	18	32
H50E-SF16-160MT	16mm	160	24	34

Standard: DIN69893A/ DIN 69882-8
 Material: H11 High Alloy Steel
 Hardness: 52 HRC tempered
 Runout: .000040" to .00012" at 3 X Diameter of Tool
 Balancing: <3g.mm at 24,000 RPM (HSK63F)
 <3g.mm at 25,000 RPM (HSK80F)
 Cooling: Center-thru and Face Coolant (HSK63F/80F Standard only)

Features: All shrink fit holders 6 mm (1/4") and above include a backup screw.
 Application: Compatible with h6 tolerance Steel, HSS, Carbide
 Accessories: **Compatible with Part# RE011 shrink fit reductions and shrink fit extensions (see pages 36-37). Replacement Backup Screw (see page 37). HSK63F/83F Coolant Tube and wrench (not included, see page 37 to order).**

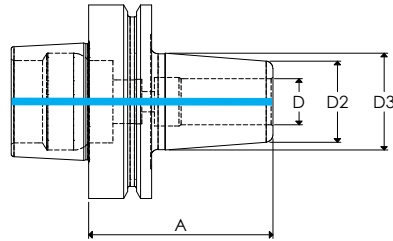
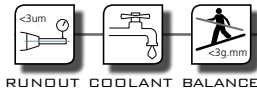

STANDARD TYPE



INCH

Part Number	D	A	D2	D3
H63F-SF0125-3.15	1/8"	3.15"	0.35"	0.63"
H63F-SF0250-3.15	1/4"	3.15"	0.79"	1.06"
H63F-SF0375-3.15	3/8"	3.15"	0.94"	1.26"
H63F-SF0500-3.54	1/2"	3.54"	0.94"	1.26"
H63F-SF0625-3.74	5/8"	3.74"	1.06"	1.34"
H63F-SF0750-3.94	3/4"	3.94"	1.30"	1.65"

METRIC

Part Number	D	A	D2	D3
H63F-SF3-80	3mm	80	9	16
H63F-SF6-80	6mm	80	20	27
H63F-SF10-85	10mm	85	24	32
H63F-SF12-90	12mm	90	24	32
H63F-SF16-95	16mm	95	27	34
H63F-SF20-100	20mm	100	33	42

HSK80F

Part Number	D	A	D2	D3
H80F-SF0125-3.00B	1/8"	3.00"	0.39"	0.63"
H80F-SF0125-6.00B	1/8"	6.00"	0.39"	0.75"
H80F-SF0250-3.00B	1/4"	3.00"	0.83"	1.06"
H80F-SF0250-6.00B	1/4"	6.00"	0.83"	1.06"
H80F-SF0375-3.00B	3/8"	3.00"	0.94"	1.18"
H80F-SF0375-6.00B	3/8"	6.00"	0.94"	1.26"
H80F-SF0500-3.00B	1/2"	3.00"	0.94"	1.18"
H80F-SF0500-6.00B	1/2"	6.00"	0.94"	1.26"
H80F-SF0625-3.00B	5/8"	3.00"	1.06"	1.30"
H80F-SF0625-6.00B	5/8"	6.00"	1.06"	1.34"
H80F-SF0750-3.00B	3/4"	3.00"	1.30"	1.61"
H80F-SF0750-6.00B	3/4"	6.00"	1.30"	1.65"
H80F-SF1000-4.00B	1"	4.00"	1.73"	2.09"
H80F-SF1000-6.00B	1"	6.00"	1.73"	2.09"

- All HSK80F holders are balanceable as standard with tapped holes.
- All HSK80F holders come with drive pins compatible with Makino MAG machines (pins can be removed to be used as a standard HSK80F holder).

STUB LENGTH HOLDERS

Part Number	D	A	D2	D3
H80F-SF0250-2.36B	1/4"	2.36"	0.83"	0.98"
H80F-SF0375-2.56B	3/8"	2.56"	0.94"	1.14"
H80F-SF0500-2.95B	1/2"	2.95"	0.94"	1.18"
H80F-SF0625-3.15B	5/8"	3.15"	1.06"	1.34"
H80F-SF0750-3.15B	3/4"	3.15"	1.30"	1.57"
H80F-SF1000-2.75B	1"	2.75"	1.73"	1.97"

- Finer balancing can be achieved by request.



HSK63/80F

Material: H11 High Alloy Steel
 Hardness: 52 HRC tempered
 Concentricity: 1 to 2 μm between the internal and external diameter
 Cooling: Central
 Features: h6 tolerance on all the extension cylindrical length
 Application: Small-sized for difficult machining access
 Supplied without stop screws

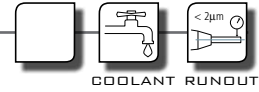

3° SLIM STYLE (LIGHT DUTY)

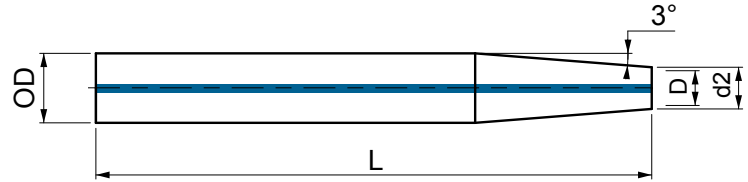

INCH

Part Number	OD	D	d2	L
ST62-SF0125-6.30	5/8"	1/8"	0.31"	6.30"
ST62-SF0187-6.30	5/8"	3/16"	0.31"	6.30"
ST62-SF0250-6.30	5/8"	1/4"	0.47"	6.30"
ST75-SF0250-6.30	3/4"	1/4"	0.47"	6.30"
ST75-SF0312-6.30	3/4"	5/16"	0.63"	6.30"
ST75-SF0375-6.30	3/4"	3/8"	0.63"	6.30"
ST75-SF0500-6.30	3/4"	1/2"	0.71"	6.30"

METRIC

Part Number	OD	D	d2	L
ST16-SF3-160	16	3	8	160
ST16-SF4-160	16	4	8	160
ST16-SF5-160	16	5	9	160
ST16-SF6-160	16	6	12	160
ST20-SF6-160	20	6	12	160
ST20-SF8-160	20	8	16	160
ST20-SF10-160	20	10	16	160
ST20-SF12-160	20	12	18	160

Material: H11 High Alloy Steel
 Hardness: 52 HRC tempered
 Concentricity: 1 to 2 µm between the internal and external diameter
 Cooling: In front - RE011

Application: Allows shrinking of several diameters with one size shrink fit holder.
 Specific diameter upon request.
 Keeps the "A" length of the basic chuck after assembling.

ONLY COMPATIBLE WITH ELCO'S SHRINK FIT UNITS

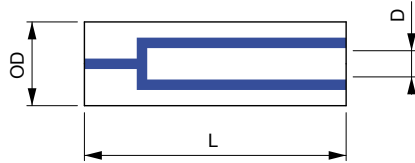

RE011





RE011

HIGH

Part Number	OD	D	L
SF-RE011-0500-0125	1/2"	0.13"	1.65"
SF-RE011-0500-0187	1/2"	0.19"	1.85"
SF-RE011-0500-0250	1/2"	0.25"	1.85"
SF-RE011-0750-0312	3/4"	0.31"	1.97"
SF-RE011-0750-0375	3/4"	0.38"	1.97"
SF-RE011-0750-0500	3/4"	0.50"	1.97"

REPLACEMENT BACKUP SCREW	
<i>Applies for all Standard, Extended & Mold Types</i>	
	
D	Code
<6mm	no screw
6mm (1/4")	SF-STOP-SCREW-6
8mm (5/16")	SF-STOP-SCREW-8
10mm (3/8")	SF-STOP-SCREW-10
12-14mm (1/2")	SF-STOP-SCREW-12-14
16-18mm (5/8")	SF-STOP-SCREW-16-18
20-32mm (3/4"-1 1/4")	SF-STOP-SCREW-20-32

COOLANT TUBE	
	
Part Number	Description
HSK32-TUBE	Coolant tube for HSK32 Holders
HSK40-TUBE	Coolant tube for HSK40 Holders
HSK50-TUBE	Coolant tube for HSK50 Holders
HSK63-TUBE	Coolant tube for HSK63 Holders
HSK100-TUBE	Coolant tube for HSK100 Holders

COOLANT TUBE WRENCH	
	
Part Number	Description
HSK32-WRENCH	Coolant wrench for HSK32 Coolant Tube
HSK40-WRENCH	Coolant wrench for HSK40 Coolant Tube
HSK50-WRENCH	Coolant wrench for HSK50 Coolant Tube
HSK63-WRENCH	Coolant wrench for HSK63 Coolant Tube
HSK100-WRENCH	Coolant wrench for HSK100 Coolant Tube

LYNDEX NIKKEN



LYNDEX
NIKKEN
1458 Armour Blvd
Mondakia, IL
(847) 367-4111

1458 Armour Blvd
Mondakia, IL
(847) 367-4111





Lyndex-Nikken website:

Be sure to check out our website

www.lyndexnikken.com

to find out more about our products,
services and all we have to offer!

This customer-friendly site provides a
complete overview of our product line,
and features technical data, videos,
CAD drawings, catalogs and more.



www.lyndexnikken.com

1468 Armour Boulevard

Mundelein, IL 60060

E-mail: sales@lyndexnikken.com

Phone: (847) 367-4800

Fax: (847) 367-4815

CAT2015-SHRINK AUG. 2017