

Including



ADVANCED PRODUCT GROUP



Where **high performance** is the **standard**®



Integrated Manufacturing Solutions



Product Catalog 2016

www.maford.com



Where **high performance** is the **standard**®



For more than 95 years, M.A. FORD® has been at the cutting edge of tooling design and manufacturing and has developed an enviable global reputation for performance and precision in advanced solid carbide tooling, serving over 60 countries worldwide.

Our innovative cutting geometries, materials and coating technologies are providing effective manufacturing solutions to an expanding and increasingly diverse range of industries from agriculture and construction to aerospace, power generation and automotive, to name but a few.

M.A. FORD® – Where high performance *is the* standard.®



Series Number by Page



Series No.	Page No.
60	409
61	409
61B	410
61T	411
64 Sets	412
67	413
71 Sets	452
78	413
79	414
79B	415
79T	416
79 Sets	417
80	424
83	421
84	421
86	422
87	422
92	418
92 Sets	418
111	253
112	248
113	249
114	259
116	268
116C	271
117	260
121	276
122	266
123	286
132	267
134	222
134N	223
134S	222
135	212
135B	218
135BN	219

Series No.	Page No.
135N	214
136	220
138 / 138R	224
138B	237
138BN	238
138CE	235
138N / 138NR	231
140	287
145	291
150	292
156	239
157	244
158	243
163	262
164	282
165	289
166	295
169	272
169C	275
177 / 177W	199
177L	204
177S	205
178 / 178W	206
178N	209
179	210
179L	211
180	194
180CB	198
180N	197
192	247
200	88
200 Sets	95
200S	68, 132
204	96
205	98
206	105

Series No.	Page No.
207	107
207CE	75
209	111
210	114
224	115
226	117
229	77
230	463
230CE	460
231	463
231B	463
231BCE	460
231CE	460
231D	463
231DCE	460
231F	463
239	457
270	376
270L	376
270P	378
272	379
277 / 277W	174
277N	178
277 Sets	180
278 / 278W	181
278N	191
279	193
2MDCL	74
2XDCE	67
2XDCL	64
2XDCCR	59
2XDCCS	55
2XDSCR	50
2XDSS	45
300	119
302	123











Series No.	Page No.
305	81
306	128
402	131
403	69, 133
404	69, 133
405	134
850	423
851	423
880 / 882 / 883	419
890 / 892 / 893	420
CDACR	41
CXDCL	37
CXDCCR	32
CXDCCS	28
CXDSCR	24
CXDSS	19
HPDCR	70
HPDSR	70
SA	429
SB	431
SC	433
SD	435
SE	437
SF	439
SG	441
SH	443
SJ	445
SK	446
SL	447
SM	449
SN	451



Edge Hog® Burs Page 427-452					
Series	Tool Illustration	Shape	Cut	Material Group	Page
SA		Cylindrical Flat End	Single Double Fine Shear	See page 428 of catalog	429-430
SB		Cylindrical Flat End with End Cut	Single Double Fine Shear	See page 428 of catalog	431-432



Edge Hog® Burs Page 427-452 (continued)

Series	Tool Illustration	Shape	Cut	Material Group	Page
SC		Cylindrical Radius End	Single Double Fine Shear	See page 428 of catalog	433-434
SD		Spherical	Single Double Fine Shear	See page 428 of catalog	435-436
SE		Elliptical	Single Double Fine Shear	See page 428 of catalog	437-438
SF		Tree Shape Radius End	Single Double Fine Shear	See page 428 of catalog	439-440
SG		Tree Shape Point End	Single Double Fine	See page 428 of catalog	441-442
SH		Flame	Single Double Fine	See page 428 of catalog	443-444
SJ		60° Angle Tool	Single Double Fine	See page 428 of catalog	445
SK		90° Angle Tool	Single Double	See page 428 of catalog	446
SL		Conical Radius End	Single Double Fine Shear	See page 428 of catalog	447-448
SM		Conical	Single Double Fine	See page 428 of catalog	449-450
SN		Back Taper	Single Double Fine	See page 428 of catalog	451
71	Bur Sets	Multiple Shapes per Set	Single Double Fine	See page 428 of catalog	452
Technical Information					453

Edge Hog® Burs

M.A. Ford® manufactures a complete line of Solid Carbide Burs available in three different cuts - Standard, Fine and Shear - to provide a range of finishes on ferrous, non-ferrous and non-metallic materials. Double Cut (Alternate Diamond Grind) Burs are available with left-hand flutes added to help break up chips. These burs are available in Standard and Fine Cut Versions. The following shapes are available:

- SA - Cylindrical Flat End
- SB - Cylindrical Flat End With End Cut
- SC - Cylindrical Radius End
- SD - Spherical
- SE - Elliptical
- SF - Tree Shape Radius End
- SG - Tree Shape Pointed End
- SH - Flame
- SJ - 60° Angle Tool
- SK - 90° Angle Tool
- SL - Conical Radius End
- SM - Conical
- SN - Back Taper
- Bur Sets



Made in USA



ISO 9001:2008 Certified



Where *high performance* is the *standard*®

Types of Cuts and Recommended Applications

Following are general guidelines for selecting the correct bur based upon material being machined.

Single (Standard)



A general-purpose right hand flute style is recommended when rapid stock removal and good workpiece finish are the parameters.

Fine



A general-purpose right hand flute style designed for producing higher quality finishes, when removing less stock, with more operator control.

Shear



A right hand flute style bur is recommended for rapid stock removal on softer, non-ferrous and non-metallic materials.

Double (Alternate Diamond Grind)



M.A. Ford® Carbide Burs are available in a Standard Alternate Diamond (Double Cut) and Fine Alternate Diamond style. An alternate diamond grind has left hand fluting added to standard or fine cut fluting. This additional fluting helps break up chips when working steel weldments or other materials that can produce small or sliver-type chips. A slight left hand cutting action typically provides the operator more control of the bur and grinder.

Optional Diamond Grind Available Upon Request



Diamond grind is left hand fluting added to single or fine cut burs. Like an alternate diamond grind, a diamond grind will also break up bothersome chips into an almost granular powder. More precise deburring is possible because of a more balanced left and right hand cutting action. The most rapid penetration achieved with a carbide bur is with diamond grind. A diamond grind will, however, reduce tool life. Recommended for ferrous and stainless steel materials.

Bur Application Chart				
Material	Type of Cut			
	Single	Double	Fine	Shear
Steel, Carbon & Alloys	x	x		
Steel, Nickel Chrome	x	x		
Steel, Stainless	x	x	x	
Steel, Weldments	x	x		
Cast Iron	x			
Titanium	x	x		
Steel, 40-60 Rc	x	x	x	
Wood				x
Aluminum	x	x		x
Brass, Bronze, Copper	x	x		
Carbon	x			
Fiberglass	x			
Hard Rubber	x			x
Magnesium				x
Masonite	x			x
Plastics	x			x
Zinc				x

All burs available with coating.

See page 472 for our coating options.

**Contact M.A. Ford at
800-553-8024 / 563-391-6220
for all your application questions.**

Specify type of cut when ordering.

Order by Tool No. / EDP or SCTI No.

SCTI No. - D Double Cut

SCTI No. - F Fine Cut

Example:

SA-41.....Single Cut

SA-41-D.....Double Cut

SA-41-F.....Fine Cut

Edge Hog® Series SA Inch

Includes Micro Sizes

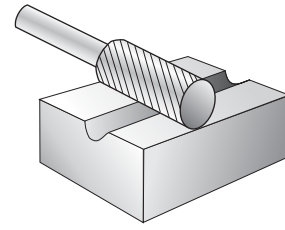

Cylindrical Flat End

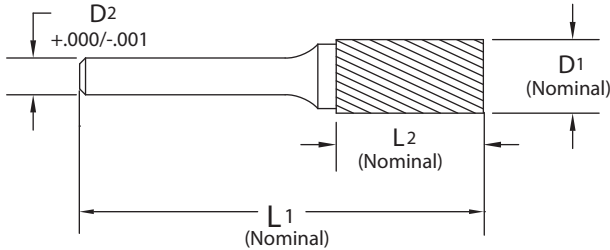

Specify type of cut when ordering.

SCTI	Type of Cut								Diameter	Shank	OAL	Flute Length
	Single		Double		Fine		Shear					
	Tool No.	EDP	Tool No.	EDP	Tool No.	EDP	Tool No.	EDP				
SA-41	69000020	69001	69000027	69009	69000030	69017			1/16	1/8	1-1/2	1/4
SA-42	69020020	69049	69020027	69057	69020030	69065			3/32	1/8	1-1/2	7/16
SA-43	69010020	69025	69010027	69033	69010030	69041			1/8	1/8	1-1/2	9/16
SA-43L3	69010020L3	69801	69010027L3	69803					1/8	1/8	3	9/16
SA-11	41125020	41037	41125027	41049	41125030	41061			1/8	1/4	2	1/2
SA-52	72010020	72001	72010027	72009	72010030	72017			5/32	1/8	1-1/2	1/2
SA-13	41156220	41073	41156227	41085	41156230	41097			5/32	1/4	2	5/8
SA-53	72030020	72049	72030027	72057	72030030	72065			3/16	1/8	1-1/2	1/2
SA-81	74010020	74001	74010027	74005	74010030	74009			3/16	3/16	2	5/8
SA-14	41187520	41109	41187527	41121	41187530	41133			3/16	1/4	2	5/8
SA-51	70010020	70013	70010027	70021	70010030	70029			1/4	1/8	2	1/2
SA-1	41250020	41145	41250027	41157	41250030	41169			1/4	1/4	2	5/8
SA-2	41312520	41181	41312527	41193	41312530	41205			5/16	1/4	2-3/4	3/4
SA-3	41375020	41217	41375027	41229	41375030	41241			3/8	1/4	2-3/4	3/4
SA-3NF							41375150	41601	3/8	1/4	2-3/4	3/4
SA-4	41437520	41273	41437527	41285	41437530	41297			7/16	1/4	3	1
SA-5	41500020	41309	41500027	41321	41500030	41333			1/2	1/4	3	1
SA-5NF							41500150	41616	1/2	1/4	3	1
SA-6	41625020	41365	41625027	41377	41625030	41389			5/8	1/4	3	1
SA-6NF							41625150	41631	5/8	1/4	3	1
SA-15	41750120	41457	41750127	41469	41750130	41481			3/4	1/4	2-1/2	1/2
SA-16	41750220	41493	41750227	41505	41750230	41517			3/4	1/4	2-3/4	3/4
SA-7	41750020	41421	41750027	41433	41750030	41445			3/4	1/4	3	1
SA-9	41100020	41001	41100027	41013	41100030	41025			1	1/4	3	1



Edge Hog® Series SA Metric

Includes Micro Sizes

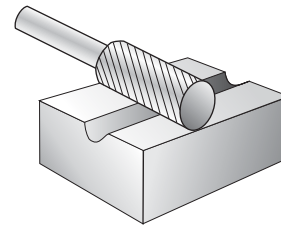

Cylindrical Flat End

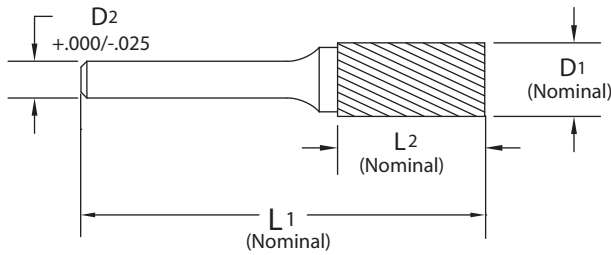

Specify type of cut when ordering.

SCTI	Type of Cut								Diameter D1	Shank D2	OAL L1	Flute Length L2
	Single		Double		Fine		Shear					
	Tool No.	EDP	Tool No.	EDP	Tool No.	EDP	Tool No.	EDP				
SA-41M	69000020M	69005	69000027M	69013	69000030M	69021			1.6	3.0	38.0	6.0
SA-42M	69020020M	69053	69020027M	69061	69020030M	69069			2.4	3.0	38.0	11.1
SA-11M	41125020M	41045	41125027M	41057	41125030M	41069			3.0	6.0	50.0	12.7
SA-43L76M	69010020L3M	69802	69010027L3M	69804					3.0	3.0	76.0	14.3
SA-43M	69010020M	69029	69010027M	69037	69010030M	69045			3.0	3.0	38.0	14.3
SA-52M	72010020M	72005	72010027M	72013	72010030M	72021			4.0	3.0	38.0	12.7
SA-13M	41156220M	41081	41156227M	41093	41156230M	41105			4.0	6.0	50.0	16.0
SA-53M	72030020M	72053	72030027M	72061	72030030M	72069			4.8	3.0	38.0	12.7
SA-14M	41187520M	41117	41187527M	41129	41187530M	41141			4.8	6.0	50.0	16.0
SA-1M	41250020M	41153	41250027M	41165	41250030M	41177			6.0	6.0	50.0	16.0
SA-51M	70010020M	70017	70010027M	70025	70010030M	70033			6.4	3.0	51.0	12.7
SA-2M	41312520M	41189	41312527M	41201	41312530M	41213			8.0	6.0	64.0	19.0
SA-3M	41375020M	41225	41375027M	41237	41375030M	41249			9.5	6.0	64.0	19.0
SA-3NFM							41375150M	41269	9.5	6.0	64.0	19.0
SA-3MZ	41393020M	41250	41393027M	41252	41393030M	41254			10.0	6.0	65.0	20.0
SA-4M	41437520M	41281	41437527M	41293	41437530M	41305			11.0	6.0	70.0	25.0
SA-5MZ	41472020M	41262	41472027M	41264	41472030M	41266			12.0	6.0	70.0	25.0
SA-5M	41500020M	41317	41500027M	41329	41500030M	41341			12.7	6.0	70.0	25.0
SA-5NFM							41500150M	41361	12.7	6.0	70.0	25.0
SA-6M	41625020M	41373	41625027M	41385	41625030M	41397			16.0	6.0	70.0	25.0
SA-6NFM							41625150M	41417	16.0	6.0	70.0	25.0
SA-15M	41750120M	41465	41750127M	41477	41750130M	41489			19.0	6.0	58.0	12.7
SA-16M	41750220M	41501	41750227M	41513	41750230M	41525			19.0	6.0	64.0	19.0
SA-7M	41750020M	41429	41750027M	41441	41750030M	41453			19.0	6.0	70.0	25.0
SA-9M	41100020M	41009	41100027M	41021	41100030M	41033			25.0	6.0	70.0	25.0



Edge Hog® Series SB Inch

Includes Micro Sizes

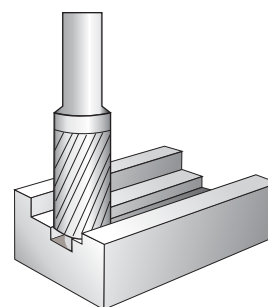

Cylindrical Flat End
End Cut

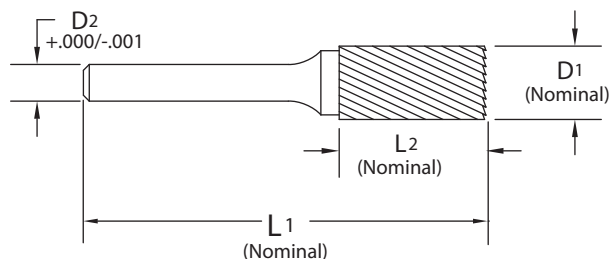

SA - Metric / SB - Inch
Edge Hog® Burs



Specify type of cut
when ordering.

SCTI	Type of Cut								Diameter	Shank	OAL	Flute Length
	Single		Double		Fine		Shear					
	Tool No.	EDP	Tool No.	EDP	Tool No.	EDP	Tool No.	EDP				
SB-11	41125020E	41041	41125027E	41053	41125030E	41065			1/8	1/4	2	1/2
SB-13	41156220E	41077	41156227E	41089	41156230E	41101			5/32	1/4	2	5/8
SB-14	41187520E	41113	41187527E	41125	41187530E	41137			3/16	1/4	2	5/8
SB-51	70000020E	70001	70000027E	70005	70000030E	70009			1/4	1/8	1-11/16	3/16
SB-1	41250020E	41149	41250027E	41161	41250030E	41173			1/4	1/4	2	5/8
SB-2	41312520E	41185	41312527E	41197	41312530E	41209			5/16	1/4	2-3/4	3/4
SB-3	41375020E	41221	41375027E	41233	41375030E	41245			3/8	1/4	2-3/4	3/4
SB-3NF							41375150E	41606	3/8	1/4	2-3/4	3/4
SB-4	41437520E	41277	41437527E	41289	41437530E	41301			7/16	1/4	3	1
SB-5	41500020E	41313	41500027E	41325	41500030E	41337			1/2	1/4	3	1
SB-5NF							41500150E	41621	1/2	1/4	3	1
SB-6	41625020E	41369	41625027E	41381	41625030E	41393			5/8	1/4	3	1
SB-6NF							41625150E	41636	5/8	1/4	3	1
SB-15	41750120E	41461	41750127E	41473	41750130E	41485			3/4	1/4	2-1/2	1/2
SB-16	41750220E	41497	41750227E	41509	41750230E	41521			3/4	1/4	2-3/4	3/4
SB-7	41750020E	41425	41750027E	41437	41750030E	41449			3/4	1/4	3	1
SB-9	41100020E	41005	41100027E	41017	41100030E	41029			1	1/4	3	1



Edge Hog® Series SB Metric

Includes Micro Sizes

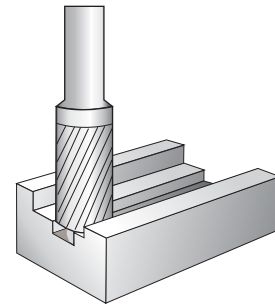
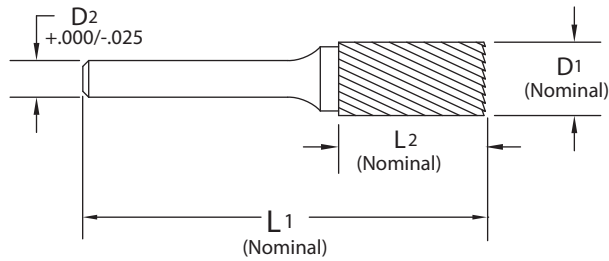

Cylindrical Flat End
End Cut



Specify type of cut
when ordering.

SCTI	Type of Cut								Dia.	Shank	OAL	Flute Length
	Single		Double		Fine		Shear					
	Tool No.	EDP	Tool No.	EDP	Tool No.	EDP	Tool No.	EDP				
SB-11M	41125020EM	41042	41125027EM	41054	41125030EM	41066			3.0	6.0	50.0	12.7
SB-13M	41156220EM	41078	41156227EM	41090	41156230EM	41102			4.0	6.0	50.0	16.0
SB-14M	41187520EM	41114	41187527EM	41126	41187530EM	41138			4.8	6.0	50.0	16.0
SB-1M	41250020EM	41150	41250027EM	41162	41250030EM	41174			6.0	6.0	50.0	16.0
SB-51M	70000020EM	70003	70000027EM	70007	70000030EM	70011			6.4	3.0	43.0	4.8
SB-2M	41312520EM	41186	41312527EM	41198	41312530EM	41210			8.0	6.0	64.0	19.0
SB-3M	41375020EM	41222	41375027EM	41234	41375030EM	41246			9.5	6.0	64.0	19.0
SB-3NFM							41375150EM	41271	9.5	6.0	64.0	19.0
SB-3MZ	41393020EM	41256	41393027EM	41258	41393030EM	41260			10.0	6.0	65.0	20.0
SB-4M	41437520EM	41278	41437527EM	41290	41437530EM	41302			11.0	6.0	70.0	25.0
SB-5MZ	41472020EM	41268	41472027EM	41270	41472030EM	41272			12.0	6.0	70.0	25.0
SB-5M	41500020EM	41314	41500027EM	41326	41500030EM	41338			12.7	6.0	70.0	25.0
SB-5NFM							41500150EM	41363	12.7	6.0	70.0	25.0
SB-6M	41625020EM	41370	41625027EM	41382	41625030EM	41394			16.0	6.0	70.0	25.0
SB-6NFM							41625150EM	41419	16.0	6.0	70.0	25.0
SB-15M	41750120EM	41462	41750127EM	41474	41750130EM	41486			19.0	6.0	58.0	12.7
SB-16M	41750220EM	41498	41750227EM	41510	41750230EM	41522			19.0	6.0	64.0	19.0
SB-7M	41750020EM	41426	41750027EM	41438	41750030EM	41450			19.0	6.0	70.0	25.0
SB-9M	41100020EM	41006	41100027EM	41018	41100030EM	41030			25.0	6.0	70.0	25.0



Edge Hog® Series SC Inch

Includes Micro Sizes

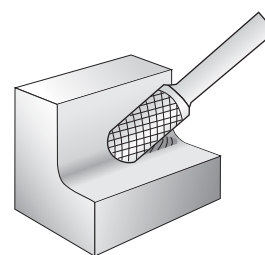

Cylindrical Radius End

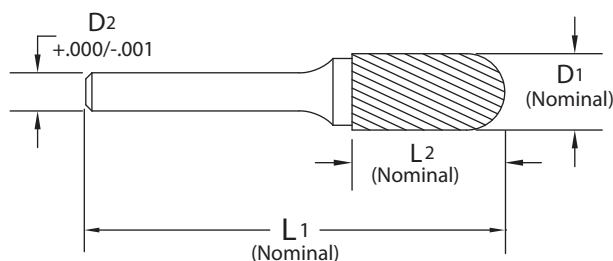

Specify type of cut when ordering.

SCTI	Type of Cut							Dia.	Shank	OAL	Flute Length	
	Single		Double		Fine		Shear					
	Tool No.	EDP	Tool No.	EDP	Tool No.	EDP	Tool No.					EDP
SC-41	69040020	69097	69040027	69105	69040030	69113			3/32	1/8	1-1/2	7/16
SC-11	42125020	42021	42125027	42029	42125030	42037			1/8	1/4	2	1/2
SC-42	69030020	69073	69030027	69081	69030030	69089			1/8	1/8	1-1/2	9/16
SC-42L3	69030020L3	69805	69030027L3	69807					1/8	1/8	3	9/16
SC-52	72020020	72025	72020027	72033	72020030	72041			5/32	1/8	1-1/2	1/2
SC-13	42156220	42045	42156227	42053	42156230	42061			5/32	1/4	2	5/8
SC-53	72040020	72073	72040027	72081	72040030	72089			3/16	1/8	1-1/2	1/2
SC-81	74020020	74013	74020027	74017	74020030	74021			3/16	3/16	2	5/8
SC-14	42187520	42069	42187527	42077	42187530	42085			3/16	1/4	2	5/8
SC-51	70020020	70037	70020027	70045	70020030	70053			1/4	1/8	2	1/2
SC-1	42250020	42093	42250027	42105	42250030	42117			1/4	1/4	2	5/8
SC-1L6	42250020L6	42801	42250027L6	42806	42250030L6	42811			1/4	1/4	6-5/8	5/8
SC-2	42312520	42129	42312527	42141	42312530	42153			5/16	1/4	2-3/4	3/4
SC-2L6	42312520L6	42816	42312527L6	42821	42312530L6	42826			5/16	1/4	6-3/4	3/4
SC-3	42375020	42165	42375027	42177	42375030	42189			3/8	1/4	2-3/4	3/4
SC-3L6	42375020L6	42831	42375027L6	42836	42375030L6	42841			3/8	1/4	6-3/4	3/4
SC-3NF							42375150	42601	3/8	1/4	2-3/4	3/4
SC-4	42437520	42213	42437527	42221	42437530	42229			7/16	1/4	3	1
SC-5	42500020	42237	42500027	42253	42500030	42265			1/2	1/4	3	1
SC-5L6	42500020L6	42846	42500027L6	42851	42500030L6	42856			1/2	1/4	7	1
SC-5NF							42500150	42621	1/2	1/4	3	1
SC-6	42625020	42289	42625027	42297	42625030	42305			5/8	1/4	3	1
SC-6NF							42625150	42641	5/8	1/4	3	1
SC-7	42750020	42325	42750027	42333	42750030	42341			3/4	1/4	3	1
SC-9	42100020	42001	42100027	42009	42100030	42017			1	1/4	3	1

SB - Metric / SC - Inch
Edge Hog® Burs



Edge Hog® Series SC Metric

Includes Micro Sizes

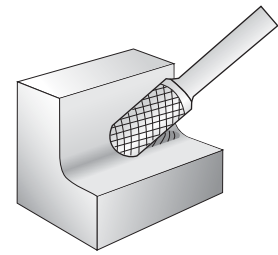

Cylindrical Radius End

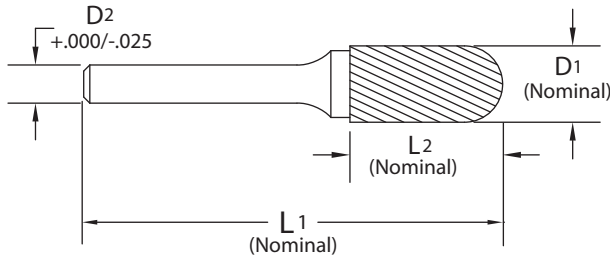

Specify type of cut when ordering.

SCTI	Type of Cut								Dia. D1	Shank D2	OAL L1	Flute Length L2
	Single		Double		Fine		Shear					
	Tool No.	EDP	Tool No.	EDP	Tool No.	EDP	Tool No.	EDP				
SC-41M	69040020M	69101	69040027M	69109	69040030M	69117			2.4	3.0	38.0	11.1
SC-11M	42125020M	42025	42125027M	42033	42125030M	42041			3.0	6.0	50.0	12.7
SC-42M	69030020M	69077	69030027M	69085	69030030M	69093			3.0	3.0	38.0	14.3
SC-42L76M	69030020L3M	69806	69030027L3M	69808					3.0	3.0	76.0	14.3
SC-52M	72020020M	72029	72020027M	72037	72020030M	72045			4.0	3.0	38.0	12.7
SC-13M	42156220M	42049	42156227M	42057	42156230M	42066			4.0	6.0	50.0	16.0
SC-53M	72040020M	72077	72040027M	72085	72040030M	72093			4.8	3.0	38.0	12.7
SC-14M	42187520M	42073	42187527M	42081	42187530M	42089			4.8	6.0	50.0	16.0
SC-1M	42250020M	42101	42250027M	42113	42250030M	42125			6.0	6.0	50.0	16.0
SC-1L6M	42250020L6M	42802	42250027L6M	42807	42250030L6M	42812			6.0	6.0	166.0	16.0
SC-51M	70020020M	70041	70020027M	70049	70020030M	70057			6.4	3.0	51.0	12.7
SC-2M	42312520M	42137	42312527M	42149	42312530M	42161			8.0	6.0	64.0	19.0
SC-2L6M	42312520L6M	42817	42312527L6M	42822	42312530L6M	42827			8.0	6.0	169.0	19.0
SC-3M	42375020M	42173	42375027M	42185	42375030M	42197			9.5	6.0	64.0	19.0
SC-3NFM							42375150M	42209	9.5	6.0	64.0	19.0
SC-3L6M	42375020L6M	42832	42375027L6M	42837	42375030L6M	42842			9.5	6.0	169.0	19.0
SC-3MZ	42393020M	42198	42393027M	42200	42393030M	42202			10.0	6.0	65.0	20.0
SC-4M	42437520M	42217	42437527M	42225	42437530M	42233			11.0	6.0	70.0	25.0
SC-5MZ	42472020M	42204	42472027M	42206	42472030M	42208			12.0	6.0	70.0	25.0
SC-5M	42500020M	42245	42500027M	42261	42500030M	42273			12.7	6.0	70.0	25.0
SC-5NFM							42500150M	42285	12.7	6.0	70.0	25.0
SC-5L6M	42500020L6M	42847	42500027L6M	42852	42500030L6M	42857			12.7	6.0	175.0	25.0
SC-6M	42625020M	42293	42625027M	42301	42625030M	42309			16.0	6.0	70.0	25.0
SC-6NFM							42625150M	42321	16.0	6.0	70.0	25.0
SC-7M	42750020M	42329	42750027M	42337	42750030M	42345			19.0	6.0	70.0	25.0
SC-9M	42100020M	42005	42100027M	42013					25.0	6.0	70.0	25.0



Edge Hog® Series SD Inch

Includes Micro Sizes

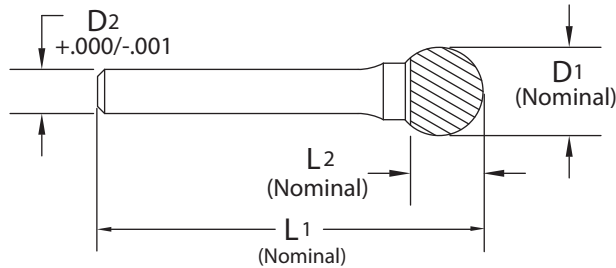
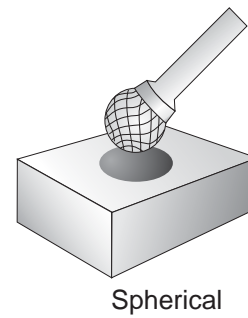

Specify type of cut when ordering.

SCTI	Type of Cut								Dia.	Shank	OAL	Flute Length
	Single		Double		Fine		Shear					
	Tool No.	EDP	Tool No.	EDP	Tool No.	EDP	Tool No.	EDP				
SD-41	69045020	69121	69045027	69129	69045030	69137			3/32	1/8	1-1/2	5/64
SD-11	43125020	43025	43125027	43033	43125030	43041			1/8	1/4	2	7/64
SD-42	69050020	69145	69050027	69153	69050030	69161			1/8	1/8	1-1/2	7/64
SD-42L3	69050020L3	69809	69050027L3	69811					1/8	1/8	3	7/64
SD-14	43187520	43049	43187527	43057	43187530	43065			3/16	1/4	2	5/32
SD-53	72050020	72097	72050027	72105	72050030	72113			3/16	1/8	1-1/2	5/32
SD-81	74030020	74025	74030027	74029	74030030	74033			3/16	3/16	2	5/32
SD-1	43250020	43073	43250027	43085	43250030	43097			1/4	1/4	2	7/32
SD-1L6	43250020L6	43801	43250027L6	43806	43250030L6	43811			1/4	1/4	6-7/32	7/32
SD-51	70030020	70061	70030027	70069	70030030	70077			1/4	1/8	1-23/32	7/32
SD-2	43312520	43109	43312527	43121	43312530	43133			5/16	1/4	2-9/32	9/32
SD-2L6	43312520L6	43816	43312527L6	43821	43312530L6	43826			5/16	1/4	6-9/32	9/32
SD-3	43375020	43145	43375027	43157	43375030	43169			3/8	1/4	2-5/16	5/16
SD-3L6	43375020L6	43831	43375027L6	43836	43375030L6	43841			3/8	1/4	6-5/16	5/16
SD-3NF							43375150	43601	3/8	1/4	2-5/16	5/16
SD-4	43437520	43189	43437527	43197	43437530	43205			7/16	1/4	2-3/8	3/8
SD-5	43500020	43213	43500027	43225	43500030	43237			1/2	1/4	2-7/16	7/16
SD-5L6	43500020L6	43846	43500027L6	43851	43500030L6	43856			1/2	1/4	6-7/16	7/16
SD-5NF							43500150	43621	1/2	1/4	2-7/16	7/16
SD-6	43625020	43257	43625027	43265	43625030	43273			5/8	1/4	2-9/16	9/16
SD-6NF							43625150	43641	5/8	1/4	2-9/16	9/16
SD-7	43750020	43289	43750027	43297	43750030	43305			3/4	1/4	2-11/16	11/16
SD-9	43100020	43001	43100027	43009	43100030	43017			1	1/4	2-15/16	15/16



Edge Hog® Series SD Metric

Includes Micro Sizes

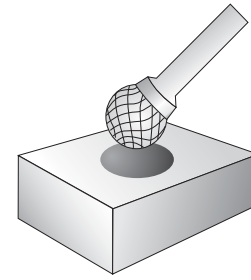

Spherical

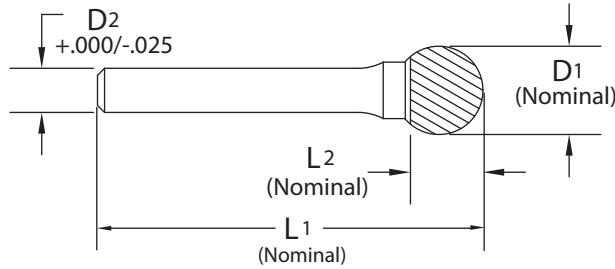

Specify type of cut when ordering.

SCTI	Type of Cut								Dia. D1	Shank D2	OAL L1	Flute Length L2
	Single		Double		Fine		Shear					
	Tool No.	EDP	Tool No.	EDP	Tool No.	EDP	Tool No.	EDP				
SD-41M	69045020M	69125	69045027M	69133	69045030M	69141			2.4	3.0	38.0	2.0
SD-11M	43125020M	43029	43125027M	43037	43125030M	43045			3.0	6.0	50.0	2.8
SD-42M	69050020M	69149	69050027M	69157	69050030M	69165			3.0	3.0	38.0	2.8
SD-42L76M	69050020L3M	69810	69050027L3M	69812					3.0	3.0	76.0	2.8
SD-14M	43187520M	43053	43187527M	43061	43187530M	43069			4.8	6.0	50.0	4.0
SD-53M	72050020M	72101	72050027M	72109	72050030M	72117			4.8	3.0	38.0	4.0
SD-1M	43250020M	43081	43250027M	43093	43250030M	43105			6.0	6.0	50.0	5.0
SD-1L6M	43250020L6M	43802	43250027L6M	43807	43250030L6M	43812			6.0	6.0	155.0	5.0
SD-51M	70030020M	70065	70030027M	70073	70030030M	70081			6.4	3.0	44.0	5.6
SD-2M	43312520M	43117	43312527M	43129	43312530M	43141			8.0	6.0	51.0	6.0
SD-2L6M	43312520L6M	43817	43312527L6M	43822	43312530L6M	43827			8.0	6.0	159.0	6.0
SD-3M	43375020M	43153	43375027M	43165	43375030M	43177			9.5	6.0	53.0	7.0
SD-3L6M	43375020L6M	43832	43375027L6M	43837	43375030L6M	43842			9.5	6.0	161.0	7.0
SD-3NFM							43375150M	43185	9.5	6.0	53.0	7.0
SD-3MZ	43393020M	43178	43393027M	43180	43393030M	43182			10.0	6.0	54.0	7.0
SD-4M	43437520M	43193	43437527M	43201	43437530M	43209			11.0	6.0	54.0	9.0
SD-5MZ	43472020M	43184	43472027M	43186	43472030M	43188			12.0	6.0	56.0	10.0
SD-5M	43500020M	43221	43500027M	43233	43500030M	43245			12.7	6.0	56.0	10.0
SD-5L6M	43500020L6M	43847	43500027L6M	43852	43500030L6M	43857			12.7	6.0	160.0	10.0
SD-5NFM							43500150M	43253	12.7	6.0	56.0	10.0
SD-6M	43625020M	43261	43625027M	43269	43625030M	43277			16.0	6.0	59.0	13.0
SD-6NFM							43625150M	43285	16.0	6.0	59.0	13.0
SD-7M	43750020M	43293	43750027M	43301	43750030M	43309			19.0	6.0	62.0	16.0
SD-9M	43100020M	43005	43100027M	43013	43100030M	43021			25.0	6.0	68.0	21.0



Edge Hog® Series SE Inch

Includes Micro Sizes

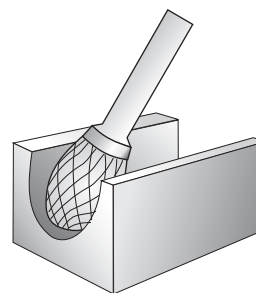

Elliptical

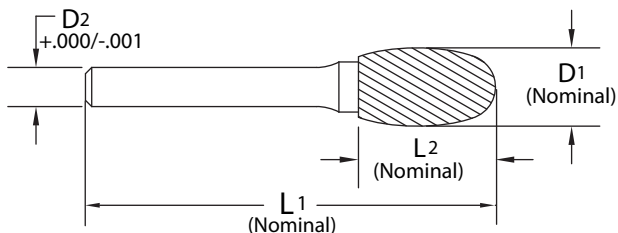

Specify type of cut when ordering.

SCTI	Type of Cut								Dia.	Shank	OAL	Flute Length
	Single		Double		Fine		Shear					
	Tool No.	EDP	Tool No.	EDP	Tool No.	EDP	Tool No.	EDP				
SE-41	69060020	69169	69060027	69177	69060030	69185			1/8	1/8	1-1/2	7/32
SE-41L3	69060020L3	69813	69060027L3	69815					1/8	1/8	3	7/32
SE-53	72060020	72121	72060027	72129	72060030	72137			3/16	1/8	1-1/2	9/32
SE-81	74040020	74037	74040027	74041	74040030	74045			3/16	3/16	2	9/32
SE-1	44250020	44001	44250027	44013	44250030	44025			1/4	1/4	2	3/8
SE-1L6	44250020L6	44801	44250027L6	44806	44250030L6	44811			1/4	1/4	6-3/8	3/8
SE-51	70040020	70085	70040027	70093	70040030	70101			1/4	1/8	1-7/8	3/8
SE-3	44375020	44073	44375027	44085	44375030	44097			3/8	1/4	2-5/8	5/8
SE-3L6	44375020L6	44831	44375027L6	44836	44375030L6	44841			3/8	1/4	6-5/8	5/8
SE-3NF							44375150	44601	3/8	1/4	2-5/8	5/8
SE-5	44500020	44117	44500027	44129	44500030	44141			1/2	1/4	2-7/8	7/8
SE-5L6	44500020L6	44846	44500027L6	44851	44500030L6	44856			1/2	1/4	6-7/8	7/8
SE-5NF							44500150	44621	1/2	1/4	2-7/8	7/8
SE-6	44625020	44161	44625027	44173	44625030	44185			5/8	1/4	3	1
SE-6NF							44625150	44641	5/8	1/4	3	1
SE-7	44750020	44205	44750027	44213	44750030	44221			3/4	1/4	3	1



Edge Hog® Series SE Metric

Includes Micro Sizes

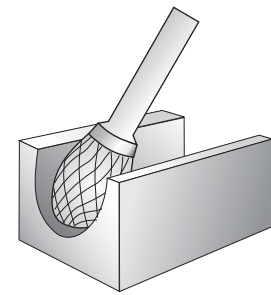
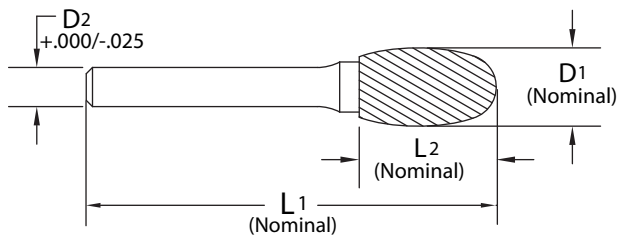

Elliptical



Specify type of cut when ordering.a

SCTI	Type of Cut								Dia.	Shank	OAL	Flute Length
	Single		Double		Fine		Shear					
	Tool No.	EDP	Tool No.	EDP	Tool No.	EDP	Tool No.	EDP				
SE-41M	69060020M	69173	69060027M	69181	69060030M	69189			3.0	3.0	38.0	5.6
SE-41L76M	69060020L3M	69814	69060027L3M	69816					3.0	3.0	76.0	5.6
SE-53M	72060020M	72125	72060027M	72133	72060030M	72141			4.8	3.0	38.0	7.0
SE-1M	44250020M	44009	44250027M	44021	44250030M	44033			6.0	6.0	50.0	9.5
SE-1L6M	44250020L6M	44802	44250027L6M	44807	44250030L6M	44812			6.0	6.0	159.0	9.5
SE-51M	70040020M	70089	70040027M	70097	70040030M	70105			6.4	3.0	48.0	9.5
SE-3M	44375020M	44081	44375027M	44093	44375030M	44105			9.5	6.0	60.0	16.0
SE-3L6M	44375020L6M	44832	44375027L6M	44837	44375030L6M	44842			9.5	6.0	166.0	16.0
SE-3NFM							44375150M	44113	9.5	6.0	60.0	16.0
SE-5M	44500020M	44125	44500027M	44137	44500030M	44149			12.7	6.0	67.0	22.0
SE-5L6M	44500020L6M	44847	44500027L6M	44852	44500030L6M	44857			12.7	6.0	172.0	22.0
SE-5NFM							44500150M	44157	12.7	6.0	67.0	22.0
SE-6M	44625020M	44169	44625027M	44181	44625030M	44193			16.0	6.0	70.0	25.0
SE-6NFM							44625150M	44201	16.0	6.0	70.0	25.0
SE-7M	44750020M	44209	44750027M	44217	44750030M	44225			19.0	6.0	70.0	25.0



Edge Hog® Series SF Inch

Includes Micro Sizes

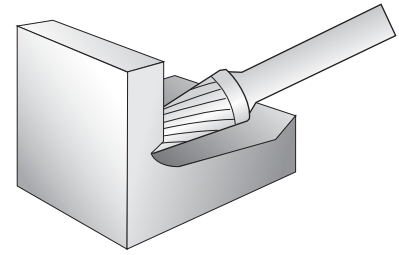

Tree Shape
Radius End

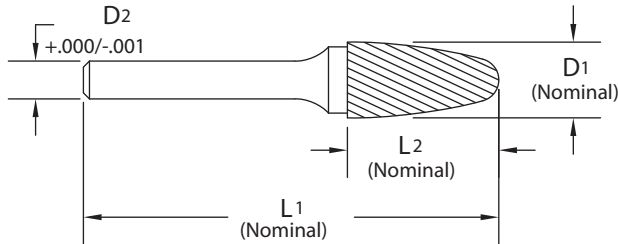

Specify type of cut
when ordering.

SCTI	Type of Cut								Dia.	Shank	OAL	Flute Length
	Single		Double		Fine		Shear					
	Tool No.	EDP	Tool No.	EDP	Tool No.	EDP	Tool No.	EDP	D1	D2	L1	L2
SF-41	69070020	69193	69070027	69201	69070030	69209			1/8	1/8	1-1/2	1/4
SF-42	69080020	69217	69080027	69225	69080030	69233			1/8	1/8	1-1/2	1/2
SF-42L3	69080020L3	69817	69080027L3	69819					1/8	1/8	3	1/2
SF-11	45125020	45001	45125027	45009	45125030	45017			1/8	1/4	2	1/2
SF-53	72080020	72169	72080027	72177	72080030	72185			3/16	1/8	1-1/2	1/2
SF-81	74060020	74061	74060027	74065	74060030	74069			3/16	3/16	2	1/2
SF-51	70050020	70109	70050027	70117	70050030	70125			1/4	1/8	2	1/2
SF-1	45250020	45025	45250027	45037	45250030	45049			1/4	1/4	2	5/8
SF-1L6	45250020L6	45801	45250027L6	45806	45250030L6	45811			1/4	1/4	6-5/8	5/8
SF-3	45375020	45097	45375027	45109	45375030	45121			3/8	1/4	2-3/4	3/4
SF-3L6	45375020L6	45831	45375027L6	45836	45375030L6	45841			3/8	1/4	6-3/4	3/4
SF-3NF							45375150	45601	3/8	1/4	2-3/4	3/4
SF-4	45437520	45145	45437527	45153	45437530	45161			7/16	1/4	3	1
SF-13	45500120	45205	45500127	45213	45500130	45221			1/2	1/4	2-3/4	3/4
SF-5	45500020	45169	45500027	45181	45500030	45193			1/2	1/4	3	1
SF-5L6	45500020L6	45846	45500027L6	45851	45500030L6	45856			1/2	1/4	7	1
SF-5NF							45500150	45621	1/2	1/4	2-3/4	1
SF-6	45625020	45241	45625027	45253	45625030	45265			5/8	1/4	3	1
SF-6NF							45625150	45641	5/8	1/4	3	1
SF-7	45750120	45313	45750127	45321	45750130	45329			3/4	1/4	3	1
SF-14	45750020	45289	45750027	45297	45750030	45305			3/4	1/4	3-1/4	1-1/4
SF-15	45750220	45337	45750227	45345	45750230	45353			3/4	1/4	3-1/2	1-1/2



Edge Hog® Series SF Metric

Includes Micro Sizes

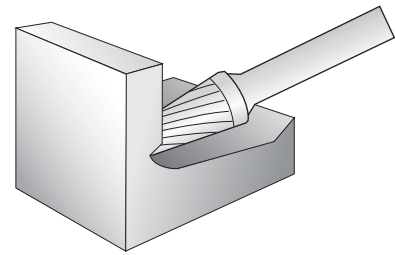
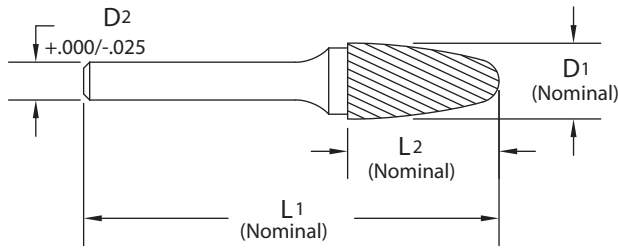

Tree Shape
Radius End



Specify type of cut
when ordering.

SCTI	Type of Cut								Dia.	Shank	OAL	Flute Length
	Single		Double		Fine		Shear					
	Tool No.	EDP	Tool No.	EDP	Tool No.	EDP	Tool No.	EDP				
SF-41M	69070020M	69197	69070027M	69205	69070030M	69213			3.0	3.0	38.0	6.0
SF-42M	69080020M	69221	69080027M	69229	69080030M	69237			3.0	3.0	38.0	12.7
SF-42L76M	69080020L3M	69818	69080027L3M	69820					3.0	3.0	76.0	12.7
SF-11M	45125020M	45005	45125027M	45013	45125030M	45021			3.0	6.0	50.0	12.7
SF-51M	70050020M	70113	70050027M	70121	70050030M	70129			6.4	3.0	51.0	12.7
SF-53M	72080020M	72173	72080027M	72181	72080030M	72189			4.8	3.0	38.0	12.7
SF-1M	45250020M	45033	45250027M	45045	45250030M	45057			6.0	6.0	50.0	16.0
SF-1L6M	45250020L6M	45802	45250027L6M	45807	45250030L6M	45812			6.0	6.0	166.0	16.0
SF-13M	45500120M	45209	45500127M	45217	45500130M	45225			12.7	6.0	64.0	19.0
SF-3M	45375020M	45105	45375027M	45117	45375030M	45129			9.5	6.0	64.0	19.0
SF-3L6M	45375020L6M	45832	45375027L6M	45837	45375030L6M	45842			9.5	6.0	169.0	19.0
SF-3NFM							45375150M	45141	9.5	6.0	64.0	19.0
SF-4M	45437520M	45149	45437527M	45157	45437530M	45165			11.0	6.0	70.0	25.0
SF-5M	45500020M	45177	45500027M	45189	45500030M	45201			12.7	6.0	70.0	25.0
SF-5L6M	45500020L6M	45847	45500027L6M	45852	45500030L6M	45857			12.7	6.0	175.0	25.0
SF-5MZ	45472020M	45130	45472027M	45132	45472030M	45134			12.0	6.0	70.0	25.0
SF-5NFM							45500150M	45237	12.7	6.0	70.0	25.0
SF-6M	45625020M	45249	45625027M	45261	45625030M	45273			16.0	6.0	70.0	25.0
SF-6NFM							45625150M	45285	16.0	6.0	70.0	25.0
SF-7M	45750120M	45317	45750127M	45325	45750130M	45333			19.0	6.0	70.0	25.0
SF-14M	45750020M	45293	45750027M	45301	45750030M	45309			19.0	6.0	76.0	31.0
SF-15M	45750220M	45341	45750227M	45349	45750230M	45357			19.0	6.0	84.0	38.0



Edge Hog® Series SG Inch

Includes Micro Sizes

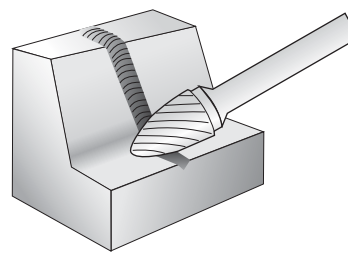

Tree Shape
Pointed End

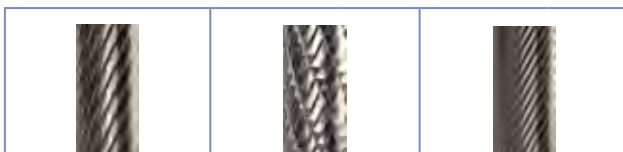
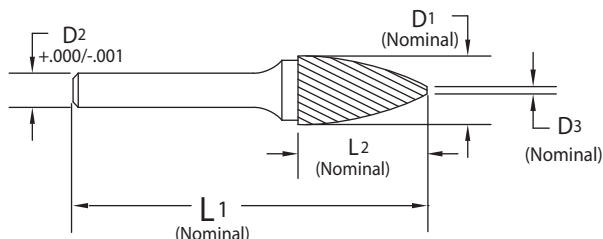

Specify type of cut
when ordering.

SCTI	Type of Cut						Dia.	Shank	End Dia.	OAL	Flute Length
	Single		Double		Fine						
	Tool No.	EDP	Tool No.	EDP	Tool No.	EDP					
SG-41	69090020	69241	69090027	69249	69090030	69257	1/8	1/8	.018	1-1/2	1/4
SG-43	69100020	69289	69100027	69297	69100030	69305	1/8	1/8	.018	1-1/2	3/8
SG-43L3	69100020L3	69825	69100027L3	69827			1/8	1/8	.018	3	3/8
SG-42	69095020	69265	69095027	69273	69095030	69281	1/8	1/8	.018	1-1/2	5/16
SG-42L3	69095020L3	69821	69095027L3	69823			1/8	1/8	.018	3	5/16
SG-53	72090020	72193	72090027	72201	72090030	72209	3/16	1/8	.025	1-1/2	1/2
SG-81	74070020	74073	74070027	74077	74070030	74081	3/16	3/16	.023	2	1/2
SG-51	70060020	70133	70060027	70141	70060030	70149	1/4	1/8	.030	2	1/2
SG-1	46250020	46001	46250027	46013	46250030	46025	1/4	1/4	.030	2	5/8
SG-1L6	46250020L6	46801	46250027L6	46806	46250030L6	46811	1/4	1/4	.030	6-5/8	5/8
SG-2	46312520	46037	46312527	46049	46312530	46061	5/16	1/4	.040	2-3/4	3/4
SG-3	46375020	46073	46375027	46085	46375030	46097	3/8	1/4	.040	2-3/4	3/4
SG-3L6	46375020L6	46831	46375027L6	46836	46375030L6	46841	3/8	1/4	.040	6-3/4	3/4
SG-5	46500020	46109	46500027	46121	46500030	46133	1/2	1/4	.050	3	1
SG-5L6	46500020L6	46846	46500027L6	46851	46500030L6	46856	1/2	1/4	.050	7	1
SG-13	46500120	46145	46500127	46153	46500130	46161	1/2	1/4	.050	2-3/4	3/4
SG-6	46625020	46169	46625027	46181	46625030	46193	5/8	1/4	.050	3	1
SG-7	46750020	46205	46750027	46213	46750030	46221	3/4	1/4	.050	3	1
SG-15	46750120	46229	46750127	46237	46750130	46245	3/4	1/4	.070	3-1/2	1-1/2



Edge Hog® Series SG Metric

Includes Micro Sizes

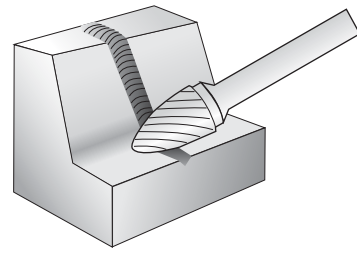

Tree Shape
Pointed End

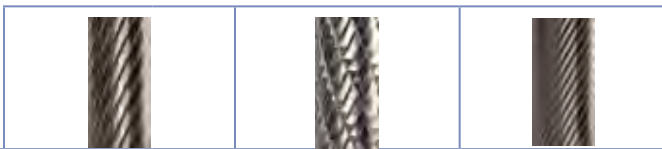
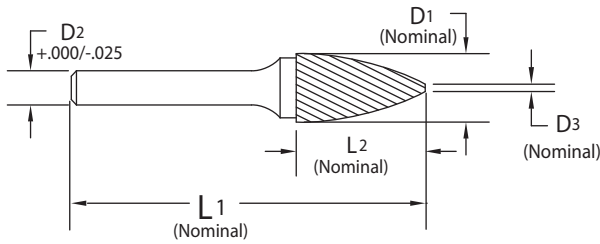

Specify type of cut
when ordering.

SCTI	Type of Cut						Dia.	Shank	End Dia.	OAL	Flute Length
	Single		Double		Fine						
	Tool No.	EDP	Tool No.	EDP	Tool No.	EDP					
SG-41M	69090020M	69245	69090027M	69253	69090030M	69261	3.0	3.0	0.46	38.0	6.0
SG-42M	69095020M	69269	69095027M	69277	69095030M	69285	3.0	3.0	0.46	38.0	8.0
SG-42L76M	69095020L3M	69822	69095027L3M	69824			3.0	3.0	0.46	76.0	8.0
SG-43M	69100020M	69293	69100027M	69301	69100030M	69309	3.0	3.0	0.46	38.0	9.5
SG-43L76M	69100020L3M	69826	69100027L3M	69828			3.0	3.0	0.46	76.0	9.5
SG-53M	72090020M	72197	72090027M	72205	72090030M	72213	4.8	3.0	0.64	38.0	12.7
SG-1M	46250020M	46009	46250027M	46021	46250030M	46033	6.0	6.0	0.76	50.0	16.0
SG-1L6M	46250020L6M	46802	46250027L6M	46807	46250030L6M	46812	6.0	6.0	0.76	166.0	16.0
SG-51M	70060020M	70137	70060027M	70145	70060030M	70153	6.4	3.0	0.76	51.0	12.7
SG-2M	46312520M	46045	46312527M	46057	46312530M	46069	8.0	6.0	1.02	64.0	19.0
SG-3M	46375020M	46081	46375027M	46093	46375030M	46105	9.5	6.0	1.02	64.0	19.0
SG-3L6M	46375020L6M	46832	46375027L6M	46837	46375030L6M	46842	9.5	6.0	1.02	169.0	19.0
SG-3MZ	46393020M	46098	46393027M	46100	46393030M	46102	10.0	6.0	1.14	65.0	20.0
SG-5MZ	46472020M	46104	46472027M	46106	46472030M	46108	12.0	6.0	1.27	70.0	25.0
SG-13M	46500120M	46149	46500127M	46157	46500130M	46165	12.7	6.0	1.27	64.0	19.0
SG-5M	46500020M	46117	46500027M	46129	46500030M	46141	12.7	6.0	1.27	70.0	25.0
SG-5L6M	46500020L6M	46847	46500027L6M	46852	46500030L6M	46857	12.7	6.0	1.27	175.0	25.0
SG-6M	46625020M	46177	46625027M	46189	46625030M	46201	16.0	6.0	1.27	70.0	25.0
SG-7M	46750020M	46209	46750027M	46217	46750030M	46225	19.0	6.0	1.27	70.0	25.0
SG-15M	46750120M	46233	46750127M	46241	46750130M	46249	19.0	6.0	1.78	84.0	38.0



Edge Hog® Series SH Inch

Includes Micro Sizes

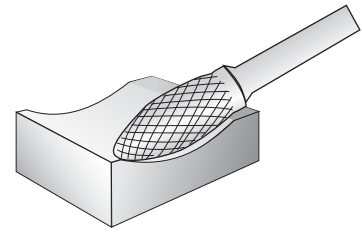

Flame

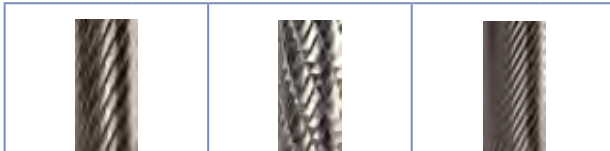
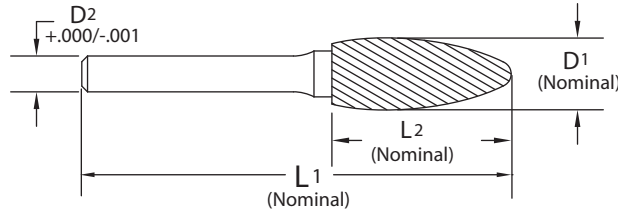

Specify type of cut when ordering.

SCTI	Type of Cut						Dia.	Shank	OAL	Flute Length
	Single		Double		Fine					
	Tool No.	EDP	Tool No.	EDP	Tool No.	EDP				
SH-41	69160020	69513	69160027	69521	69160030	69529	1/8	1/8	1-1/2	1/4
SH-41L3	69160020L3	69837	69160027L3	69839			1/8	1/8	3	1/4
SH-53	72070020	72145	72070027	72153	72070030	72161	3/16	1/8	1-1/2	3/8
SH-81	74050020	74049	74050027	74053	74050030	74057	3/16	3/16	2	3/8
SH-1	49250020	49001	49250027	49013	49250030	49025	1/4	1/4	2	5/8
SH-2	49312520	49037	49312527	49049	49312530	49061	5/16	1/4	2-3/4	3/4
SH-2L6	49312520L6	49816	49312527L6	49821	49312530L6	49826	5/16	1/4	6-3/4	3/4
SH-5	49500020	49109	49500027	49121	49500030	49133	1/2	1/4	3-1/4	1-1/4
SH-5L6	49500020L6	49846	49500027L6	49851	49500030L6	49856	1/2	1/4	7-1/4	1-1/4
SH-6	49625020	49145	49625027	49157	49625030	49169	5/8	1/4	3-7/16	1-7/16
SH-7	49750020	49181	49750027	49189	49750030	49197	3/4	1/4	3-5/8	1-5/8



Edge Hog® Series SH Metric

Includes Micro Sizes

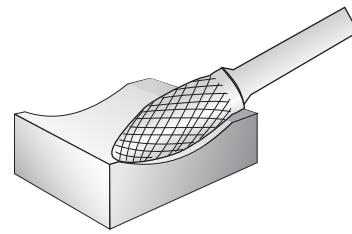

Flame

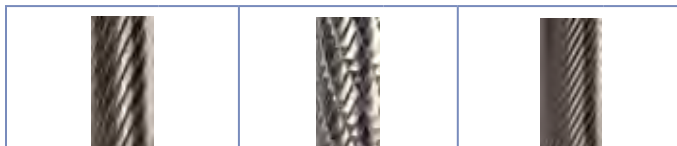
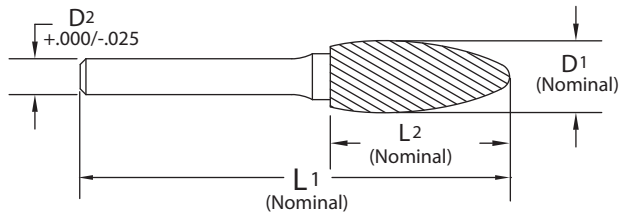

Specify type of cut
when ordering.

SCTI	Type of Cut						Dia.	Shank	OAL	Flute Length
	Single		Double		Fine					
	Tool No.	EDP	Tool No.	EDP	Tool No.	EDP				
SH-41M	69160020M	69517	69160027M	69525	69160030M	69533	3.0	3.0	38.0	6.0
SH-41L76M	69160020L3M	69838	69160027L3M	69840			3.0	3.0	76.0	6.0
SH-53M	72070020M	72149	72070027M	72157	72070030M	72165	4.8	3.0	38.0	9.5
SH-1M	49250020M	49009	49250027M	49021	49250030M	49033	6.0	6.0	50.0	16.0
SH-2M	49312520M	49045	49312527M	49057	49312530M	49069	8.0	6.0	64.0	19.0
SH-2L6M	49312520L6M	49817	49312527L6M	49822	49312530L6M	49827	8.0	6.0	169.0	19.0
SH-5M	49500020M	49117	49500027M	49129	49500030M	49141	12.7	6.0	76.0	31.0
SH-5L6M	49500020L6M	49847	49500027L6M	49852	49500030L6M	49857	12.7	6.0	181.0	31.0
SH-6M	49625020M	49153	49625027M	49165	49625030M	49177	16.0	6.0	81.0	36.0
SH-7M	49750020M	49185	49750027M	49193	49750030M	49201	19.0	6.0	86.0	41.0



Edge Hog® Series SJ Inch

Includes Micro Sizes



60° Carbide
Angle Tool

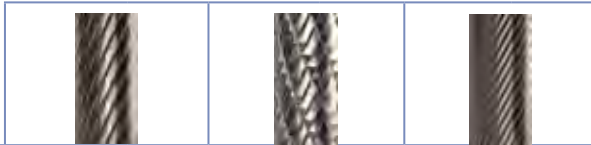
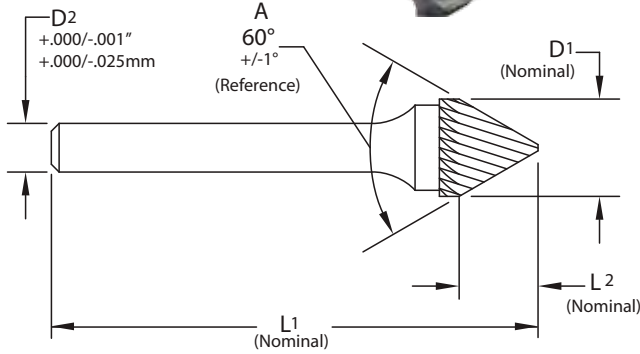
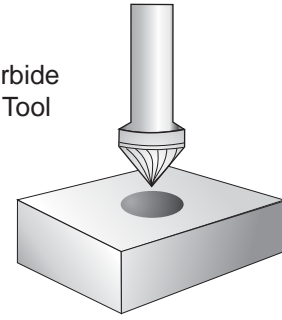

Specify type of cut
when ordering.

SCTI	Type of Cut						Dia.	Shank	OAL	Flute Length	Angle
	Single		Double		Fine						
	Tool No.	EDP	Tool No.	EDP	Tool No.	EDP	D1	D2	L1	L2	A
SJ-42	69110020	69313	69110027	69321	69110030	69329	1/8	1/8	1-1/2	3/32	60°
SJ-82*	69112520	69337	69112527	69345			1/8	1/8	1-1/2	3/32	60°
SJ-1	29602500	29601	29602507	29605			1/4	1/4	2	3/16	60°
SJ-3	29603750	29609	29603757	29613			3/8	1/4	2-7/16	5/16	60°
SJ-5	29605000	29617	29605007	29621			1/2	1/4	2-35/64	7/16	60°
SJ-6	29606250	29625	29606257	29629			5/8	1/4	2-11/16	1/2	60°
SJ-7	29607500	29633	29607507	29637			3/4	1/4	2-51/64	9/16	60°
SJ-9	29610000	29641	29610007	29645			1	1/4	2-31/32	13/16	60°

*Double End

Edge Hog® Series SJ Metric

Includes Micro Sizes

SCTI	Type of Cut						Dia.	Shank	OAL	Flute Length	Angle
	Single		Double		Fine						
	Tool No.	EDP	Tool No.	EDP	Tool No.	EDP	D1	D2	L1	L2	A
SJ-42M	69110020M	69317	69110027M	69325	69110030M	69333	3.0	3.0	38	2.4	60°
SJ-82M*	69112520M	69341	69112527M	69349			3.0	3.0	38	2.4	60°
SJ-1M	29602500M	29603	29602507M	29607			6.0	6.0	50	4.8	60°
SJ-3M	29603750M	29611	29603757M	29615			9.5	6.0	55	8.0	60°
SJ-5M	29605000M	29619	29605007M	29623			12.7	6.0	58	11.0	60°
SJ-6M	29606250M	29627	29606257M	29631			16.0	6.0	62	12.7	60°
SJ-7M	29607500M	29635	29607507M	29639			19.0	6.0	64	14.0	60°
SJ-9M	29610000M	29643	29610007M	29647			25.0	6.0	70	21.0	60°

*Double End



Edge Hog® Series SK Inch

Includes Micro Sizes

90° Carbide
Angle Tool

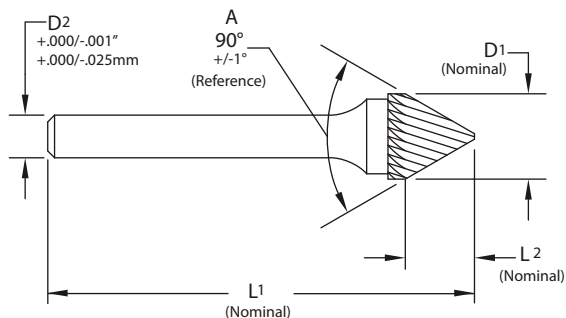
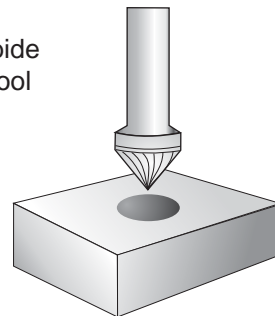

Specify type of cut
when ordering.

SCTI	Type of Cut				Dia. D1	Shank D2	OAL L1	Flute Length L2	Angle A
	Single		Double						
	Tool No.	EDP	Tool No.	EDP					
SK-42	69117520	69366	69117527	69367	1/8	1/8	1-1/2	1/16	90°
SK-82*	69115020	69353	69115027	69361	1/8	1/8	1-1/2	1/16	90°
SK-1	29702500	29701	29702507	29705	1/4	1/4	2	1/8	90°
SK-3	29703750	29709	29703757	29713	3/8	1/4	2-5/16	3/16	90°
SK-5	29705000	29717	29705007	29721	1/2	1/4	2-5/8	1/4	90°
SK-6	29706250	29725	29706257	29729	5/8	1/4	2-31/64	5/16	90°
SK-7	29707500	29733	29707507	29737	3/4	1/4	2-35/64	3/8	90°
SK-9	29710000	29741	29710007	29745	1	1/4	2-41/64	1/2	90°

*Double End

Edge Hog® Series SK Metric

Includes Micro Sizes

SCTI	Type of Cut				Dia. D1	Shank D2	OAL L1	Flute Length L2	Angle A
	Single		Double						
	Tool No.	EDP	Tool No.	EDP					
SK-42M	69117520M	69370	69117527M	69371	3.0	3.0	38.0	1.6	90°
SK-82M*	69115020M	69357	69115027M	69365	3.0	3.0	38.0	1.6	90°
SK-1M	29702500M	29703	29702507M	29707	6.0	6.0	50	3.0	90°
SK-3M	29703750M	29711	29703757M	29715	9.5	6.0	52	4.8	90°
SK-5M	29705000M	29719	29705007M	29723	12.7	6.0	53	6.4	90°
SK-6M	29706250M	29727	29706257M	29731	16.0	6.0	56	8.0	90°
SK-7M	29707500M	29735	29707507M	29739	19.0	6.0	58	9.5	90°
SK-9M	29710000M	29743	29710007M	29747	25.0	6.0	61	12.7	90°

*Double End



Edge Hog® Series SL Inch

Includes Micro Sizes

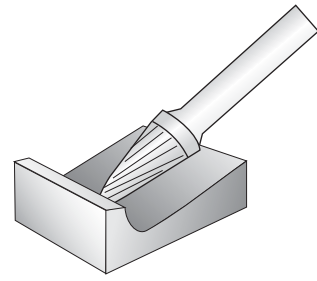

Conical Radius End

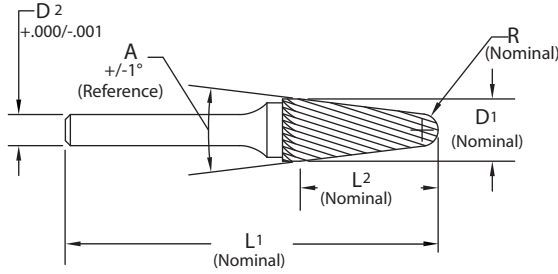

Specify type of cut when ordering.

SCTI	Type of Cut								Dia. D1	Shank D2	OAL L1	Flute Length L2	Angle A	Radius R
	Single		Double		Fine		Shear							
	Tool No.	EDP	Tool No.	EDP	Tool No.	EDP	Tool No.	EDP						
SL-42	69150020	69489	69150027	69497	69150030	69505			1/8	1/8	1-1/2	1/2	8°	.025
SL-42L3	69150020L3	69833	69150027L3	69835					1/8	1/8	3	1/2	8°	.025
SL-41	69145020	69465	69145027	69473	69145030	69481			1/8	1/8	1-1/2	3/8	8°	.039
SL-53	72120020	72265	72120027	72273	72120030	72281			3/16	1/8	1-1/2	1/2	14°	.030
SL-81	74100020	74109	74100027	74113	74100030	74117			3/16	3/16	2	1/2	14°	.030
SL-1	48250020	48001	48250027	48013	48250030	48025			1/4	1/4	2	5/8	14°	.060
SL-2	48312520	48037	48312527	48049	48312530	48061			5/16	1/4	3	15/16	14°	.060
SL-2L6	48312520L6	48816	48312527L6	48821	48312530L6	48826			5/16	1/4	7	15/16	14°	.060
SL-3	48375020	48073	48375027	48085	48375030	48097			3/8	1/4	3-3/16	1-1/8	14°	.060
SL-3L6	48375020L6	48831	48375027L6	48836	48375030L6	48841			3/8	1/4	7-3/16	1-1/8	14°	.060
SL-3NF							48375150	48601	3/8	1/4	3-3/16	1-1/8	14°	.060
SL-4	48500020	48121	48500027	48133	48500030	48145			1/2	1/4	3-1/4	1-3/16	14°	.130
SL-4L6	48500020L6	48846	48500027L6	48851	48500030L6	48856			1/2	1/4	7-1/4	1-3/16	14°	.130
SL-4NF							48500150	48621	1/2	1/4	3-1/4	1-3/16	14°	.130
SL-6	48625020	48169	48625027	48177	48625030	48185			5/8	1/4	3-7/16	1-5/16	14°	.187
SL-6NF							48625150	48641	5/8	1/4	3-7/16	1-5/16	14°	.187
SL-7	48750020	48205	48750027	48213	48750030	48221			3/4	1/4	3-5/8	1-9/16	14°	.230



Edge Hog® Series SL Metric

Includes Micro Sizes

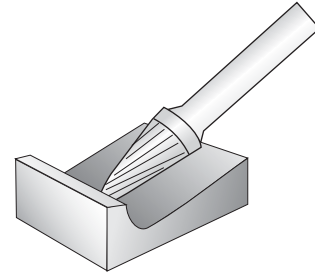
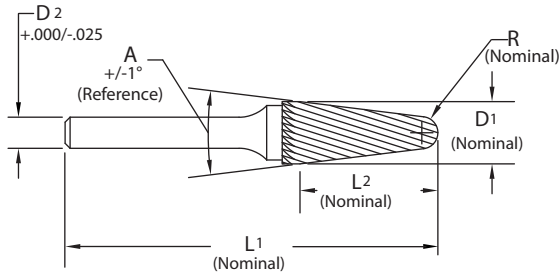

Conical Radius End



Specify type of cut when ordering.

SCTI	Type of Cut								Dia.	Shank	OAL	Flute Length	Angle	Radius
	Single		Double		Fine		Shear							
	Tool No.	EDP	Tool No.	EDP	Tool No.	EDP	Tool No.	EDP						
SL-41M	69145020M	69469	69145027M	69477	69145030M	69485			3.0	3.0	38.0	9.5	8°	0.99
SL-42M	69150020M	69493	69150027M	69501	69150030M	69509			3.0	3.0	38.0	12.7	8°	0.64
SL-42L76M	69150020L3M	69834	69150027L3M	69836					3.0	3.0	76.0	12.7	8°	0.64
SL-53M	72120020M	72269	72120027M	72277	72120030M	72285			4.8	3.0	38.0	12.7	14°	0.76
SL-1M	48250020M	48009	48250027M	48021	48250030M	48033			6.0	6.0	50.0	16.0	14°	1.52
SL-2M	48312520M	48045	48312527M	48057	48312530M	48069			8.0	6.0	71.0	24.0	14°	1.52
SL-2L6M	48312520L6M	48817	48312527L6M	48822	48312530L6M	48827			8.0	6.0	176.0	24.0	14°	1.52
SL-3M	48375020M	48081	48375027M	48093	48375030M	48105			9.5	6.0	75.0	28.0	14°	1.52
SL-3L6M	48375020L6M	48832	48375027L6M	48837	48375030L6M	48842			9.5	6.0	180.0	28.0	14°	1.52
SL-3NFM							48375150M	48117	9.5	6.0	75.0	28.0	14°	1.52
SL-4M	48500020M	48129	48500027M	48141	48500030M	48153			12.7	6.0	77.0	30.0	14°	3.30
SL-4L6M	48500020L6M	48847	48500027L6M	48852	48500030L6M	48857			12.7	6.0	182.0	30.0	14°	3.30
SL-4NFM							48500150M	48165	12.7	6.0	77.0	30.0	14°	3.30
SL-6M	48625020M	48173	48625027M	48181	48625030M	48189			16.0	6.0	80.0	33.0	14°	4.75
SL-6NFM							48625150M	48201	16.0	6.0	80.0	33.0	14°	4.75
SL-7M	48750020M	48209	48750027M	48217	48750030M	48225			19.0	6.0	86.0	39.0	14°	5.84



ISO 9001:2008 Certified

Edge Hog® Series SM Inch

Includes Micro Sizes

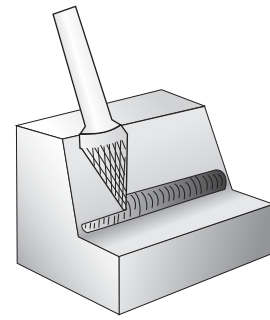

Conical

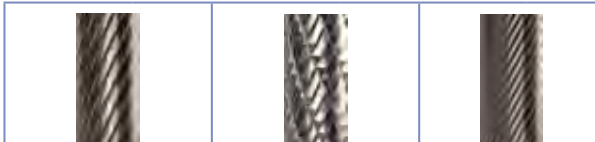
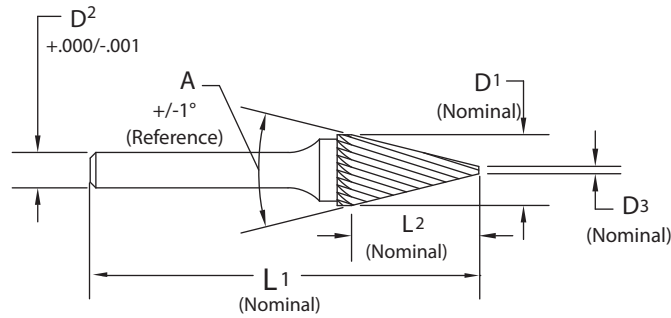

Specify type of cut when ordering.

SCTI	Type of Cut						Dia.	Shank	End Dia.	OAL	Flute Length	Angle
	Single		Double		Fine							
	Tool No.	EDP	Tool No.	EDP	Tool No.	EDP						
SM-45	69120020	69369	69120027	69377	69120030	69385	1/8	1/8	.018	1-1/2	3/16	32°
SM-41	69125020	69393	69125027	69401	69125030	69409	1/8	1/8	.043	1-1/2	3/8	12°
SM-43	69140020	69441	69140027	69449	69140030	69457	1/8	1/8	.045	1-1/2	5/8	7°
SM-42	69130020	69417	69130027	69425	69130030	69433	1/8	1/8	.014	1-1/2	7/16	14°
SM-42L3	69130020L3	69829	69130027L3	69831			1/8	1/8	.014	3	7/16	14°
SM-53	72100020	72217	72100027	72225	72100030	72233	3/16	1/8	.038	1-1/2	1/2	16°
SM-81	74080020	74085	74080027	74089	74080030	74093	3/16	3/16	.053	2	5/8	12°
SM-3	47250220	47049	47250227	47057	47250230	47065	1/4	1/4	.065	2	1	10°
SM-1	47250020	47001	47250027	47009	47250030	47017	1/4	1/4	.046	2	1/2	22°
SM-51	70070020	70157	70070027	70165	70070030	70173	1/4	1/8	.052	2-1/8	1/2	22°
SM-2	47250120	47025	47250127	47033	47250130	47041	1/4	1/4	.056	2	3/4	14°
SM-4	47375020	47073	47375027	47081	47375030	47089	3/8	1/4	.052	2-3/4	5/8	28°
SM-5	47500020	47097	47500027	47105	47500030	47113	1/2	1/4	.052	3	7/8	28°
SM-6	47625020	47121	47625027	47129	47625030	47137	5/8	1/4	.060	3-1/8	1	31°



Edge Hog® Series SM Metric

Includes Micro Sizes

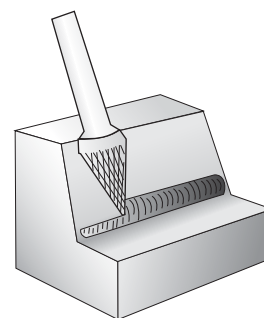

Conical

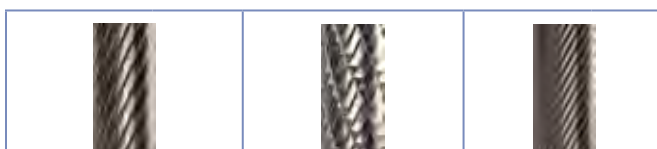
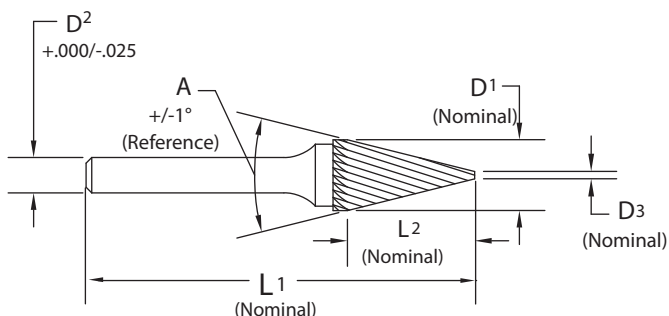

Specify type of cut when ordering.

SCTI	Type of Cut						Dia.	Shank	End Dia.	OAL	Flute Length	Angle
	Single		Double		Fine							
	Tool No.	EDP	Tool No.	EDP	Tool No.	EDP						
SM-45M	69120020M	69373	69120027M	69381	69120030M	69389	3.0	3.0	0.46	38	4.8	32°
SM-41M	69125020M	69397	69125027M	69405	69125030M	69413	3.0	3.0	1.09	38	9.5	12°
SM-42M	69130020M	69421	69130027M	69429	69130030M	69437	3.0	3.0	0.36	38	11.1	14°
SM-42L76M	69130020L3M	69830	69130027L3M	69832			3.0	3.0	0.36	76	11.1	14°
SM-43M	69140020M	69445	69140027M	69453	69140030M	69461	3.0	3.0	1.14	38	16.0	7°
SM-53M	72100020M	72221	72100027M	72229	72100030M	72237	4.8	3.0	0.97	38	12.7	16°
SM-1M	47250020M	47005	47250027M	47013	47250030M	47021	6.0	6.0	1.17	50	12.7	22°
SM-2M	47250120M	47029	47250127M	47037	47250130M	47045	6.0	6.0	1.42	50	19.0	14°
SM-3M	47250220M	47053	47250227M	47061	47250230M	47069	6.0	6.0	1.65	50	25.0	10°
SM-51M	70070020M	70161	70070027M	70169	70070030M	70177	6.4	3.0	1.32	54	12.7	22°
SM-4M	47375020M	47077	47375027M	47085	47375030M	47093	9.5	6.0	1.32	63	16.0	28°
SM-5M	47500020M	47101	47500027M	47109	47500030M	47117	12.7	6.0	1.32	69	22.0	28°
SM-6M	47625020M	47125	47625027M	47133	47625030M	47141	16.0	6.0	1.52	72	25.0	31°



Edge Hog® Series SN Inch

Includes Micro Sizes

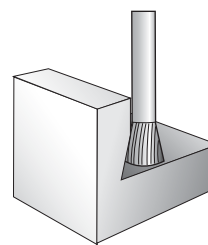

Backtaper

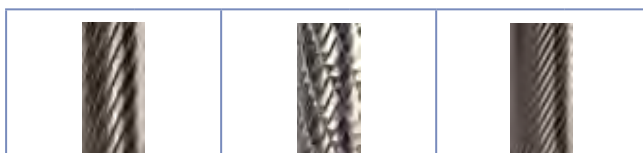
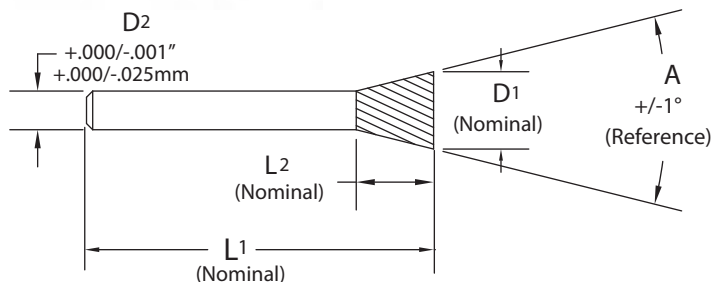

Specify type of cut
when ordering.

SCTI	Type of Cut						Dia.	Shank	OAL	Flute Length		Angle			
	Single		Double		Fine					D1	D2		L1	L2	A
	Tool No.	EDP	Tool No.	EDP	Tool No.	EDP									
SN-41	69165020	69537	69165027	69545	69165030	69553	3/32	1/8	1-1/2	1/8	10°				
SN-42*	69170020E	69561	69170027E	69565	69170030E	69569	1/8	1/8	1-1/2	3/16	10°				
SN-53	72110020	72241	72110027	72249	72110030	72257	3/16	1/8	1-1/2	1/4	10°				
SN-81	74090020	74097	74090027	74101	74090030	74105	3/16	3/16	2	1/4	10°				
SN-51	70080020	70181	70080027	70189	70080030	70197	1/4	1/8	1-3/4	1/4	10°				
SN-1	50025020	50001	50025027	50009	50025030	50017	1/4	1/4	2	5/16	10°				
SN-2	50037520	50049	50037527	50057	50037530	50065	3/8	1/4	2-3/8	3/8	13°				
SN-4	50050020	50073	50050027	50081	50050030	50089	1/2	1/4	2-1/2	1/2	28°				
SN-6	50062520	50097	50062527	50105	50062530	50113	5/8	1/4	2-3/4	3/4	18°				
SN-7	50075020	50121	50075027	50129	50075030	50137	3/4	1/4	2-5/8	5/8	30°				

*End cut

Edge Hog® Series SN Metric

Includes Micro Sizes

SCTI	Type of Cut						Dia.	Shank	OAL	Flute Length		Angle			
	Single		Double		Fine					D1	D2		L1	L2	A
	Tool No.	EDP	Tool No.	EDP	Tool No.	EDP									
SN-41M	69165020M	69541	69165027M	69549	69165030M	69557	2.4	3.0	38.0	3.0	10°				
SN-42M*	69170020EM	69563	69170027EM	69567	69170030EM	69571	3.0	3.0	38.0	4.8	10°				
SN-53M	72110020M	72245	72110027M	72253	72110030M	72261	4.8	3.0	38.0	6.4	10°				
SN-51M	70080020M	70185	70080027M	70193	70080030M	70201	6.4	3.0	44.0	6.4	10°				
SN-1M	50025020M	50005	50025027M	50013	50025030M	50021	6.0	6.0	50.0	8.0	10°				
SN-2M	50037520M	50053	50037527M	50061	50037530M	50069	9.5	6.0	55.0	9.5	13°				
SN-4M	50050020M	50077	50050027M	50085	50050030M	50093	12.7	6.0	58.0	12.7	28°				
SN-6M	50062520M	50101	50062527M	50109	50062530M	50117	16.0	6.0	64.0	19.0	18°				
SN-7M	50075020M	50125	50075027M	50133	50075030M	50141	19.0	6.0	61.0	16.0	30°				

*End cut



Edge Hog® Series 71 Sets

Inch and Millimeter sizes

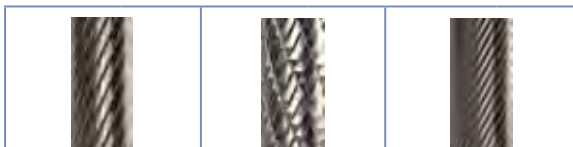

Specify type of cut when ordering.

Set No.	Type of Cut						Tools In Set
	Single		Double		Fine		
	Tool No.	EDP	Tool No.	EDP	Tool No.	EDP	
One	71010020	71001	71010027	71009	71010030	71017	SA-1, SC-1, SD-1, SG-1, SM-1
Two	71020020	71025	71020027	71033	71020030	71041	SA-43, SC-42, SD-42, SG-41, SM-45, SL-42
Three	71030020	71049	71030027	71057	71030030	71065	SA-43, SC-42, SC-41, SD-42, SE-41, SF-41, SG-41, SM-45, SL-42, SN-42
Four	71040020	71073	71040027	71081	71040030	71089	SA-51, SC-51, SD-51, SE-51, SF-51, SG-51, SM-51, SN-51

Set One

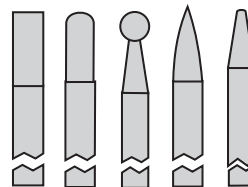

Inch: 1/4" Head/1/4" Shank

mm: 6mm Head/6mm Shank

Set No.	Type of Cut						Tools In Set (mm)
	Single		Double		Fine		
	Tool No.	EDP	Tool No.	EDP	Tool No.	EDP	
One	71010020M	71005	71010027M	71013	71010030M	71021	SA-1M, SC-1M, SD-1M, SG-1M, SM-1M
Two	71020020M	71029	71020027M	71037	71020030M	71045	SA-43M, SC-42M, SD-42M, SG-41M, SM-45M, SL-42M
Three	71030020M	71053	71030027M	71061	71030030M	71069	SA-43M, SC-41M, SC-42M, SD-42M, SE-41M, SF-41M, SG-41M, SM-45M, SL-42M, SN-42M
Four	71040020M	71077	71040027M	71085	71040030M	71093	SA-51M, SC-51M, SD-51M, SE-51M, SF-51M, SG-51M, SM-51M, SN-51M

Set Two

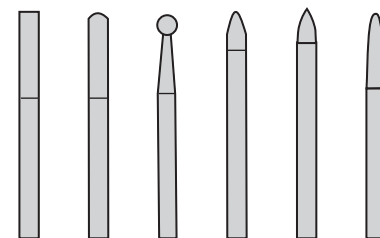

Inch: 1/8" Head/1/8" Shank

mm: 3mm Head/3mm Shank

Set Three

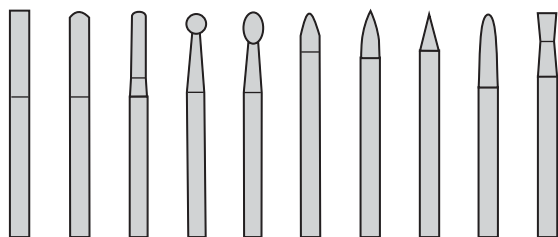

Inch: 1/8" Head/1/8" Shank

mm: 3mm Head/3mm Shank

Set Four

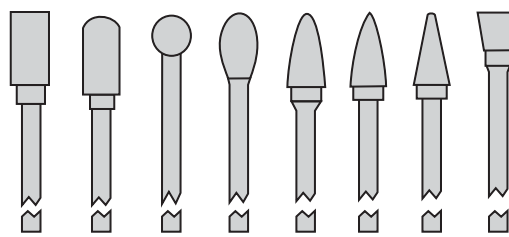

Inch: 1/4" Head/1/8" Shank

mm: 6.4mm Head/3mm Shank



Bur Troubleshooting Chart																			
Problem	Possible Solution																		
	Excessive Force	Heat From Rubbing Shank	Dull Tool	Improper Location In Collet	Bad Grinder Bearings	Bent Shank	Unstable Control of Process	Use Coarser Bur	Working in Soft Material	Use Anti-Stick Agent	Faster RPM	Slower RPM	Lighter Cuts	Switch to Fine Cut	Don't Use Double Grind	Faster Feed	Slower Feed	Cutting Abrasive Materials	Lacking Rigid Setup
Broken Braze	x	x	x																
Chatter No Control				x	x	x	x												x
Plugged Flutes								x	x	x	x	x	x						
Excessive Vibration				x	x	x	x			x	x				x	x			x
Poor Finish				x	x	x	x			x	x		x	x	x				x
Poor Life		x		x	x	x	x			x	x			x	x	x	x	x	x

Bur Fluting Chart Number of Flutes-zn (±10%)				
Tool Diameter		Single Cut	Fine Cut	Shear Cut
Inch	mm			
1/16	1.6	10	12	
5/64	2.0	10	12	
3/32	2.4	12	16	
1/8	3.0	12	20	
5/32	4.0	14	24	
3/16	4.8	15	24	
1/4	6.0	16	25	
5/16	8.0	18	30	
3/8	9.5	20	30	6
7/16	11.0	22	30	
1/2	12.7	24	35	8*
5/8	16.0	26	40	8**
3/4	19.0	30	40	
1	25.0	35	45	

Double (Alternate Diamond) Grind left hand fluting 40% of right hand fluting.
 Diamond Grind left hand fluting 80% of right hand fluting.
 *except SL-4NF and SL-4NFM 6 flutes
 **except SD-6NF, SD-6NFM, SE-6NF, SE-6NFM, SF-6NF and SF-6NFM 10 flutes

Operating Parameters			
Bur Tool Diameter		vc	
		1,500 SFM	3,000 SFM
		460 m/min.	920 m/min.
Inch	mm	RPM (n)	
1/8	3.0	45,000	90,000
1/4	6.0	23,000	45,000
3/8	9.5	15,000	30,000
1/2	12.7	11,000	22,000
3/4	19.0	7,500	15,000
1	25.0	5,500	10,000

Speeds and Feeds

Carbide burs should typically be operated between 1,500 and 3,000 SFM (460-920 m/min.). For burs ranging in size from 3/16" (4.8mm) to 3/8" (9.5mm) diameter, a 30,000 RPM (n) grinder is recommended. A 22,000 RPM (n) grinder will work effectively with burs ranging in size from 1/4" (6mm) to 1/2" (12.7mm) in diameter. Solid carbide burs that are 1/8" (3mm) diameter or less, can typically be run at speeds up to 75,000 RPM (n). However, these are general speed recommendations that may need to be adjusted.

For application questions, call **800-553-8024**.

Safety Note

Always wear the appropriate personal protective equipment such as safety glasses and protective clothing when using solid carbide or HSS cutting tools. Machines should be fully guarded. Technical data provided should be considered advisory only as variations may be necessary depending on the particular application.

Technical data provided should be considered advisory only as variations may be necessary depending on the particular application.

For product information, call your local distributor.

QUALITY



The M.A. Ford® Quality Policy is:

- Know our customers.
- Know their requirements.
- Make continual improvements in satisfying those requirements.



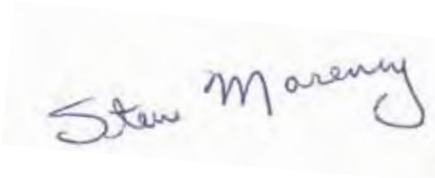





These are the responsibilities of every individual who works at M.A. Ford®.



Steve Morency, CEO











Material Conversion Chart

								
	USA	France	Brazil	German W-nr	German DIN	UK	Spain	Japan JIS
FREE MACHINING STEEL	12L13	S250Pb		1.0718	9SMnPb28		F.2112 -	
	1108	10F1		1.0721	10S20	210M15	F.2121 -	
	11L08	10PbF2		1.0722	10SPb20		F.2122 -	
	1215	S300	1215	1.0723	15S20	210A15	F.210F.	
	12L14	S300Pb		1.0736	9SMn36	240M07 EN 1B	F.2113-	
				1.0737	9MnPb36		F.2114 -	
LOW CARBON STEEL	1010	AF34C10/XC10	1010	1.0301	C10	045M10		
	1015	AF37C12/XC18	1015	1.0401	C15	080M15;040A15	F.111	
	1020	AF42C20/XC25	1020	1.0402	C22	055M15 EN2C	F.112	
	1025	AF50C30		1.0406	C25	070M26	F.221	
	1212			1.0711	9S20	220M07		
	1213	S250	1213	1.0715	9SMn28	230M07	F.2111 -	
	1010	XC10	1010	1.1121	Ck10	040A10	F.1510 -	
	1022/1518	20M5		1.1133	20Mn5	120M19	F.1515 -	
	1015	XC15 / C15E	1015	1.1141	Ck15	080M15 EN 32C	F.1511 -	
	10201023	XC25 / C22E	1020	1.1151	Ck22	050A20	F.1120 -	
	1025	XC25 / C25E		1.1158	Ck25	070M26	F.1120 -	
	A350-LF5	15Ni6 / 15Ni6		1.5622	14Ni6		F.2641 -	
	3310/9314	12NC15		1.5752	14NiCr14	655M13/A12 EN 36A		
MEDIUM CARBON STEEL	1035	AF55C35 /XC38	1035	1.0501	C35	060A35	F.113	
	1045	AF65C45 /C45	1045	1.0503	C45	080M46	F.114	
	1040	AF60C40 C40	1040	1.0511	C40		F.114.A	
	1055	C55	1055	1.0535	C55	070M55		
	1060	AF70C55 / C60	1060	1.0601	C60	080A62 EN 43D	F.115	
	1140	35MF6	1140	1.0726	35S20	212M36 EN 8M	F.210G.	
	1146	45MF4		1.0727	45S20	212M44		
	9255	51S7		1.0903	51Si7	250A53 EN 45	F.1450 -	
	9255	55S7	9254	1.0904	55Si7		F.1440-	
	9260	60S7		1.0909	60Si7	250A58	F.1441 -	
	9262	60SC7		1.0961	60SiCr7	250A61	F.1442 -	
	1330/1536	35M5 / 30Mn5		1.1165/66	30Mn5/34Mn5	120M36/150M28	F.1203	
	1335	40M5 / 36Mn5	1541	1.1167	36Mn5	150M36 EN 15	F.1203 -	
	1330	20M5 / 28Mn6	1330	1.117	28Mn6	150M28 EN 14A		
	1035	XC32 / C35R	1035	1.118	Cm35	080M36	F.1135 -	
	1040	XC42H1 / C40E	1040	1.1186	Ck40	060A40/080A40		S 40 C
	1045	XC42H1 / C45/XC45	1045	1.1191	Ck45	080M46/060A47	F.1140 -	S 45 C
	1045	XC42H1 /C45R	1045	1.1201	Cm45	080M46	F.1145 -	
	1055	XC55H1 / C55E	1055	1.1203	Ck55	060A57/070M55	F.1150 -	S55C
	1050	XC48H1 / C50E	1050	1.1206	Ck50	080M50		
1050	XC48H1TS	1050	1.1213	Cf53	060A52			
1060	XC60 / C60E/2C60	1060	1.1221	Ck60	060A62	F.511/F.512	S58C	
1070	XC68	1070	1.1231	Ck67	060A67			
ALLOY STEEL	1080/1078/1086	XC75 / C75E/XC90	1074	1.1248/1269	Ck75	060A78	F.513/514/515	
	1095	XC100	1095	1.1274	Ck101	060A96		
	4135/4142	34CD4 /42CD4		1.233	35CrMo4/47CrMo4	708A37/M40		SCM435TK
	3135/3140	35NC6		1.571/5711	36NiCr6/40NiCr6	640A35/M40 EN111A		
	8620/8720	20NCD2	8620	1.6523/43	21NiCrMo2	805M20/A20 EN 362	F.1522 -	SNCM220(H)
	8740	40NCD2	8640	1.6546	40NiCrMo22	311-Type7	F.1204 -	SNCM240
		18NCD6		1.6587	17CrNiMo8	820A16	F.1560 -	
	5132	32C4 / 34Cr4		1.7033	34Cr4	530A32 EN18B	F.8221 /F.224	SCR430(H)
	5135	38C4 / 37Cr4	5135	1.7034	37Cr4	530A36	F.1201 -	
	5140	42C4 / 41Cr4	5140	1.7035	41Cr4	530M40/A40 EN 18	F.1202 -	SCR440(H)
	5140	42C4TS	5140	1.7045	42Cr4	530A40	F.1202 -	SCR440
	5115	16MC5	5115	1.7131	16MnCr5	527M17	F.1515 -	
	5155	55C3		1.7176	55Cr3	527A60 EN 48	F.1431 -	SUP9(A)
	4130	25CD4 / 25CrMo4	4130	1.7218	25CrMo4	1717CDS110	F.8330 -	SCM420/430
	4135/4137	35CD4 / 34CrMo4		1.722	34CrMo4	708A37 EN 19B	F.8231 -	
4140/4142	42CD4 / 42CrMo4	4140	1.7225	42CrMo4	708M40 EN 19A	F.8232 -		
4150	50CrMo4	4150	1.7228	50CrMo4	708A47			
6150	50CV4 / 51CrV4	6151	1.8159	50CrV4	735A50 EN 47	F.1430 -		

Technical data provided should be considered advisory only as variations may be necessary depending on the particular application.









Material Conversion Chart

								
	USA	France	Brazil	German W-nr	German DIN	UK	Spain	Japan JIS
HIGH STRENGTH ALLOY STEEL	A355Cl.D	30CAD6.12		1.8507	34CrAlMo5	905M31	F.1741 -	
	A355Cl.A	40CAD6.12		1.8509	41CrAlMo7	905M39 EN 41B	F.1740 -	
		18NC13		1.5755	31NiCr14	653M31	F.123	
	9840	40NCD3		1.6511	36CrNiMo4	816M40 EN 110	F.1280	
	4340		4340	1.6562	40NiCrMo73	817M40		SNCM 447
		30CND8		1.658	30CrNiMo8	823M30		
	4340	35NCD6	4340	1.6582	34CrNiMo8	817M40 EN 24	F.1272	SNCM 447
		35NCD14		1.6746	32NiCrMo145	830M31	F.1262	
	35NCD16		1.6747	30NiCrMo166	835M30	F.1260		
	30CD12		1.8515	31CrMoV139	722M24 EN 40B	F.1712		
			1.8523	39CrMoV139	897M39 EN 40C			
STRUCTURAL STEEL	A570 (36)	E24-2NE / S235JRG2	A36	1.0038	RS137-2	4360-40C		STKM 12A
	A570 (40)	E28-2 / S275JR		1.0044	St44-2	4360-43A/B	A 430B	SM 400 A;B;C
	A570 (50)	A50-2 / E295		1.005	St50-2	4360-50B		SS490
		A60-2 / E335-A70-2/E360		1.006/.007	St60-2/St70-2	4360-55E		
	A284/A573/A611	E24-3;-4 / S235J2G3		1.0116	St37-3	4360-40C/D-1449-37C	A360 C;D	
	A366/1012/A619	DC01		1.033/.0333	St12/13	1449 -2/3/4CR	AP 00/02	
	A620	DC04		1.0338	St14	1449 1CR; 2CR	AP 04	
	A516Gr.65;-55;	A37CP;AP / P235GH		1.0345	H I	1501Gr.161-360/400	A 37 RC I;RA II	
		A42CP;AP / P265GH		1.0425	H II	161-400;	A42 RC I	
	A537	A52CP;AP / P335GH		1.0473	19Mn6		A 47 RB II	
	A516 (70)	A48CP;AP / P295GH		1.0481	17Mn4		A 47 RC I; RA II	
		E36-3/4 / S355J2G3		1.057	St52-3	4360-50B;50C;50D	A 510 C;D	
	A204 (A)	15D3 / 15Mo3		1.5415	15Mo3	1501-240	F.2601 -	
	4520			1.5423	16Mo5	1503-245-420	F.2602 -	
	A350-LF3	12Ni14 / 12Ni14		1.5637	10Ni14	1501-503-690	F.152	
	3115	10NC6		1.5713	13NiCr6			
	3415	14NC11		1.5732	14NiCr10		F.1540	
	A182-F11;F12	15CD3.05		1.7335	13CrMo44	620Gr.27;31	F.2631	
	A387 (12)	15CD4.5		1.7337	16CrMo44	620Gr.27		
	A182F22	10CrMo9-10		1.738	10CrMo910	622Gr.31;45	TU.H	
A633Gr.E	E420RIFP / S420N		1.8902	StE420	4360-55E	AE 420 KG		
A633Gr.E	E460RIFP / S460N		1.8905	StE460		AE 460 KG		
HIGH TEMPERATURE ALLOYS	330	Z12NCS37.18		1.4864	X12NiCrSi3616	NA17	F.3313	
				1.4865	G-X40NiCrSi3818	330C40		
	B163	Z8NC3221		1.4876	X10NiCrAlTi3320	NA15(H)	F.3545	
	4544/SB127/164	NU30		2.436	NiCu30Fe	3072-76/NA13		
	4676			2.4375	NiCu30Al	3072-76/NA18/3146		
	5388 C	NC 17 DWY		2.4602	NiCr17Mo17FeW			
		NC 20 T		2.463	Ni-Cr20Ti	HR5/203-4/703-B		
		NC 20 TA		2.4631	NiCr20TiAl	HR 401HR601/736B		
		NCKD 20 ATV		2.4634	NiCo20Cr15MoAlTi	HR 3/5007		
	687	NCKD 20 AT		2.4636	NiCo15Cr15MoAlTi			
		NCK 20 D		2.465	NiCr20Co19MoTi	HR 10		
	5660C	Z8 NCDT 42		2.4662	NiCr15MoTi			
	5536E	Nc 22 FeD		2.4665	NiCr22Fe18Mo	HR 6/204		
		NC 19 FeNb		2.4668	NiCr19Fe19NbMo	HR 8		
	5542G	NC 15 Fe TNb		2.4669	NiCr16FeTi	HR 505		
	5391A	NC 13 AD		2.467	G-NiCr13Al6MoNb	HC 203		
		NK 15 CAT		2.4674	NiCo15Cr10MoAlTi	HC 204		
	5540	NC 15 Fe		2.4816	NiCr15Fe	3072-76		
	5581	NC 22 FeDNB		2.4856	NiCr22Mo9Nb			
		NC 21 FeDU		2.4858	NiCr21Mo	3072-76		
	NC 19 KDT		2.4973	NiCr19Co11MoTi				
684	NCK 19 DAT		2.4983	NiCr18Co18MoAlTi				
TITANIUM TITANIUM ALLOYS		T-35		3.7024/25	Ti 99.8	TA.1	Ti-PO1	
		T-U2		3.7124	TiCu2	TA.21-24/52-55/58	Ti-P11	
		T-A6ZD		3.7154	TiAl6Zr5Mo0.5Si0.2	TA.43/44	Ti-P67	
		T-A4DE		3.7184	TiAl4Mo4Sn2Si0.5	TA.45-51/57	Ti-P68	
	4941/42/51/4902	T-40		3.7034/35	Ti 99.7	TA.2/3/4/5	Ti-PO2	
	4901/21	T-60		3.7064/65	Ti99.5	TA.6/7/8/9	Ti-PO4	
	491128/35/54/65/67	T-A6V		3.7164/65	TiAl6V4	TA.10-13/28/56	Ti-P63	
	4900	T-50				DTD 5023/5283		

Technical data provided should be considered advisory only as variations may be necessary depending on the particular application.









For product information, call your local distributor.

Material Conversion Chart

								
	USA	France	Brazil	German W-nr	German DIN	UK	Spain	Japan JIS
STAINLESS STEELS	410S	Z3014		1.4001	X7Cr14	403S17	F.8401	
	405	Z6CA13 / Z6CrAl13		1.4002	X6CrAl13	405S17	F.3111	
	416	Z12CF13 / Z12CrS13		1.4005	X12CrS13	416S21	F.3411	SUS 416
	410/CA-15	Z12C13 / Z12Cr13	410	1.4006	X10Cr13	410S21 ENEN 56A	F.3401	SUS 410
	430	Z8C17 / Z6Cr17		1.4016	X6Cr17	430S15 EN 60	F.3113	SUS 430
	420	Z20C13 / Z20Cr13	420	1.4021	X20Cr13	420S37	F.3402	SUS 420
		Z40C14 / Z40Cr14		1.4034	X46Cr13	420S45 EN 56D	F.3405	
	431	Z15CN16.02		1.4057	X20CrNi172	431S29 EN 57	F.3427	
	430F	Z10CF17		1.4104	X12CrMoS17		F.3117	
	434	Z8CD17.01		1.4113	X6CrMo17	434S17		
	440C	Z100CD17		1.4125	X105CrMo17			
	304/304H	Z6CN18.09	304	1.4301	X5CrNi1810	304S15 EN 58E	F.3451	SUS304
	308; 305	Z8CN18.12		1.4303	X5CrNi1812	305S19	F.3513	
	303	Z10CNF18.09	303	1.4305	X10CrNiS189	303S21 EN 58M	F.3508	SUS303
	304L	Z2CN18.10/Z3CN19.10M		1.4306	G-X2CrNi189/1911	304S12/S11/C12	F.3503	SCS19
	CF-8	Z6CN18.10M		1.4308	G-X6CrNi189	304C15		
	301	Z12CN17.07	302	1.431	X12CrNi177	301S21	F.3517	
	304LN	Z2CN18.10Az		1.4311	X2CrNi1810	304S62		
		Z10CN18.9M		1.4312	G-X10CrNi188	302C25		
	CA6-NM	Z4CND13.4M		1.4313	G-X5CrNi134	425C11		
	316/316L	Z6CND17.11	316	1.4401	X5CrNiMo17122	316S16/S31 EN 58J	F.3543	SUS316
	316L	Z2CND 18.13	316L	1.4404	X2CrNiMo17132	316S11/S12	F.3533	SUS316 L
	316LN	Z2CND 17.12Az		1.4406	2CrNiMoN17122	316S61		SUS316LN
	CF-8M			1.4408	G-X6CrNiMo1810	316C16	F.8414	
	316LN	Z2CND17.13Az		1.4429	X2CrNiMo17133	316S62		SUS316LN
	316L	Z2CND17.13		1.4435	X2CrNiMo18143	316S11/S12	F.3533	SUS316LN
	316	Z6CND17.12		1.4436	X5CrNiMo17133	316S16	F.3534	SUS316
	317L	Z2CND19.15		1.4438	X2CrNiMo18164	317S12		SUS317L
	329		329 (DUPLEx)	1.446	X8CrNiMo275		F.3309	SUS329
	XM8/430Ti	Z8CT17		1.451	X6CrTi17		F.3114	
	409	Z6CT12		1.4512	X5CrTi12	409S19		
	321	Z6CNT18.10	321	1.4541	X6CrNiTi1810	321S12/S31 EN 58B	F.3523	SUS321
	630	Z6CNU17.04		1.4542	X5CrNiCuNb1714			SUS630
	347	Z6CNCNb18.10		1.455	X6CrNiNb1810	347S17/S31 EN 58F	F.3552	SUS347
	316Ti	Z6CNDT17.12		1.4571	X6CrNiMoTi17122	320S31/S17 EN 58J	F.3552	
	316Ti			1.4573	X10CrNiMoTi1812	320S33		
	316Cb	Z6CNDNb17.12/19.13		1.458	X6CrNiMoNb17122	318S17		
	HNV3	Z45CS9		1.4718	X45CrSi93	401S45 EN52	F.3220	
		Z10C13		1.4724	X10CrAl13	403S17	F.13152	
		Z40CSD10		1.4731	X40CrSiMo102		F.3221	
	430	Z10CAS18		1.4742	X10CrAl18	430S15	F.3153	SUS430
	HNV6	Z80CSN20.02		1.4747	X80CrNiSi20	443S65 EN 59	F.3222	
	446	Z10CAS24		1.4762	X10CrAl24		F.3154	SUH446
	309	Z15CNS20.12		1.4828	X15CrNiSi2012	309S24		
	309S	Z15CN24.13		1.4833	X7CrNi2314	309S24		
	314/310	Z15CNS25.20	314	1.4841	X15CrNiSi2520		F.3310	
	310S	Z12CN25.20	310	1.4845	X12CrNi2521	310S24	F.331	
HK			1.4848	G-X40CrNiSi2520	310C40	F.8452		
EV8	Z52CMN21.09		1.4871	X53CrMnNiN219	349S54	F.3217		
	Z35CNWS14.14		1.4873	X45CrNiW189	331S40	F.3211		
321	T6CNT18.12(B)		1.4878	X12CrNiTi189	321S20	F.3523	SUS321	
A353	Z8N9		1.5662	X8Ni9	1501-509;510	F.2645		
2515	Z18N5		1.568	12Ni19				

Technical data provided should be considered advisory only as variations may be necessary depending on the particular application.









Material Conversion Chart

								
	USA	France	Brazil	German W-nr	German DIN	UK	Spain	Japan JIS
TOOL STEELS	A532IBNiCr-LC			0.962	G-X260NiCr42	Grade2A		
	A532IANiCr-HC			0.9625	G-X330NiCr42	Grade2B		
	A532IDNi-HiCr			0.963	G-X300CrNiSi952	Grade2C,D,E		
	A532IID20%CrMo-LC			0.9645	G-X260CrMoNi2021	Grade3C		
	A532IIIA25%Cr			0.965	G-X260Cr27	Grade3D		
	A532IIIA25%Cr			0.9655	G-X300CrMo271	Grade3E		
	W108	Y190;Y180		1.1525	C80W1			
	W110	Y1105		1.1545	C105W1			SK3
	W112	Y2120		1.1663	C125W			
	W1			1.175/1625	C75W/C80W1	BW1A/BW1B	F.5123	
	L3	Y100C6	52100	1.2067	100Cr6	BL3	F.5230	
	D3	Z200C12	420 (1.2083)	1.208	X210Cr12	BD3	F.5212	
	L2			1.221	115CrV3			
	H11	Z38CDV5	H11	1.2343	X38CrMoV51	BH11	F.5317	
	H13	Z40CDV5	H13	1.2344	X40CrMoV51	BH13	F.5318	SKD61
	A2	Z100CDV5	A2	1.2363	X100CrMoV51	BA2	F.5227	SKD12
	H10	32DCV28	H10	1.2365	X32CrMoV33	BH10	F.5313	
	D2	Z160CDV12	D2	1.2379	X155CrVMo121	BD2		
		105WC13		1.2419	105WCr6		F.5233	
			D6 (VC131)	1.2436	X210CrW12		F.5213	
	O1		O1 (VND)	1.251	100MnCrW4	BO1	F.5220	SKS 31
	S1		S1 (VW3)	1.2542	45WCrV7	BS1	F.5241	
		55WC20		1.255	60WCrV7			
	H21	Z30WCV9	H20/H21	1.2581	X30WCrV93	BH21	F.5323	SKD5
				1.2601	X165CrMoV12		F.5211	
	H12	Z35CWDV5	H12	1.2606	X37CrMoW51	BH12		
	L6	55NCDV7	(VMO)	1.2713	55NiCrMoV6		F.528	
	W210	Y1105V		1.2833	100V1	BW2		
	2	90MV8		1.2842	90MnCrV8	BO2		
	T15			1.3202	S12-1-4-5	BT15	F.5563	
		Z130WKCDV10-10-04-03		1.3207	S10-4-3-10		F.553	
		Z85WDKCV06-05-05-04-02	M35	1.3243	S6-5-2-5		F.5613	
	M41	Z110WKCDV07-05-04-04-02		1.3246	S7-4-2-5		F.5613	
	M42	Z110DKCWW09-08-04-02-01	M42	1.3247	S2-10-1-8	BT42	F.5615	
	M33/M34			1.3249	S2-9-2-8	BM34	F.5611	
	T4	Z80WKC18-05-04-01		1.3255	S18-1-2-5	BT4	F.5530	
	T5			1.3265	S18-1-2-10	BT5	F.5540	
	M3	Z90WDCV06-05-04-03		1.3342	SC6-5-2			
	M2	Z85WDCV06-05-04-02	M2	1.3343	S6-5-2	BM2	F.5603	
	M3Class2	Z130WDCV06-05-04-04	M3:2	1.3344	S6-5-3		F.5605	
H41/M1	Z85DCWV08-04-02-01		1.3346	S2-9-1	BM1			
M7	Z100DCWV09-04-02-02	M7	1.3348	S2-9-2		F.5607		
T1	Z80WCV18-04-01		1.3355	S18-0-1	BT1	F.5520		
A128(A)	Z120M12 / Z120Mn12		1.3401	X120Mn12		F.82551		
52100	100C6	52100	1.3505	100Cr6	534A99	F.1310		
HARDENED STEEL								
CAST ALUMINIUM	319,2	A-S5U		3.2151	G-AISI6Cu4	LM4/LM22	L-2660	
	380,1	A-S9U3		3.2161	G-AISI8Cu3	LM24	L-2630	
		A-S4G		3.2341	G-AISI5Mg	DTD716B		
	A356.2	A-S7G0,3		3.2371	G-AISI7Mg	2L99/LM25		
		A7-S10G		3.2373	G-AISI9Mg			
	A360	A-S10G		3.2381	G-AISI10Mg	LM9	L-2560	
	413,1	A-S12U		3.2583	G-AISI12Cu	LM20	L-2530	
	514,1	A-G6		3.3561	G-ALMg5	LM5		
	A413	A-S13		3.3581	G-AISI12	LM6	L-2520	
	520	A-G10-Y4		3.3591	G-ALMg10	LM10	L-2310	
	390				AISI17Cu4			
	393				AISI18-25CuNiMg	LM28/LM29		

Technical data provided should be considered advisory only as variations may be necessary depending on the particular application.

For product information, call your local distributor.

Material Conversion Chart

								
	USA	France	Brazil	German W-nr	German DIN	UK	Spain	Japan JIS
WROUGHT ALUMINIUM	1200	A4		3.0205	Al99	1C	L-3001	
	1050A	A5		3.0255	Al99,5	1B	L-3051	
	1350A	A5/L		3.0257	E-Al	1E	L-3052	
	1080A	A8		3.0285	Al99,8	1A	L-3081	
	1199	A99		3.0385	Al99,98R	1		
	3004	A-M1G		3.0526	AlMnMg1	N4	L-3820	
	2014	A-U4SG		3.1255	AlCuSiMn	H15	L-3130	
	2117	A-U2G		3.1305	AlCu2,5Mg0,5	3L86/HR13	L-3180	
	2017A	A-U4G		3.1325	AlCuMg1	H14	L-3120	
	2024	A-U4G1		3.1355	AlCuMg2	2L98	L3140	
	2003	A-U4Pb		3.1645	AlCuMgPb		L-3121	
	2011	A-U5PbBi		3.1655	AlCuBiPb	FC1	L-3182	
	6101B			3.2305	E-AlMgSi	91E	L-3431	
	6463	A85-GS		3.2307	Al99,85MGsl	BTR6		
	6181	A-SGMO,7		3.2315	Al-Si1 Mg	H30	L-3451	
	6060			3.3206	AlMGSi0,5	H9	L-3441	
	6101C	A-GS/L		3.3207	E-AlMgSi0,5	BTRE6		
	5005A	A-G0,6		3.3315	AlMg1	N41	L-3350	
	5050B	A-G1,5		3.3316	AlMg1,5	3L44	L-3380	
	5052	A-G2,5C		3.3523	AlMg2,5	N5Mg3,5	L-3360	
	5251	A-G2M		3.3525	AlMg2Mn0,3	N4		
	5754	A-G3M		3.3535	AlMg3		L-3390	
	5454	A-G2,5MC		3.3537	AlMg2,7Mn	N51		
	5083	5083		3.3547	AlMg4,5Mn	N8	L-3321	
	5056A			3.3555	AlMg5	N6	L-3320	
	7020	A-Z5G		3.4335	AlZn4,5Mg1	H17	L-3741	
7075	A-Z5GU		3.4365	AlZnMgCu1,5	2L95	L-3710		
SG / NODULAR CAST IRON	60-40-18	FGS-400-12		0.704	GGG-40	420/12		
		FGS370-17		0.7043	GGG-40.3	370/17		
	65-45-12	FGS500-7		0.705	GGG-50	500/7		FDC500
	80-55-06	FGS 600-3		0.706	GGG-60	600/3		
	100-70-03	FGS 700-2		0.707	GGG-70	700/2		FDC700
	120-90-02	FGS 800-2		0.708	GGG-80	800/2		
		MB 35-7		0.8035	GTW-35-04	W 340/3		
		MB 40-10		0.804	GTW-40-05	W 410/4		
				0.8045	GTW-45-07			
	32 510	MN 35-10		0.8135	GTS-35-10	B 340/12		
	MP 50-5		0.8145	GTS-45-06	P 440/7			
	MP 60-3		0.8155	GTS-55-04	P 540/5			
			0.8165	GTS 65-02				
70 003	MP 70-2		0.817	GTS 70-02	P 690/2			
GREY / WHITE CAST IRON	A48-40B	Ft25D / FGL250		0.6025	GG25	Grade 260	FG 25	
	A48-20B	Ft10D / FGL100		0.601	GG10		FG 10	
	A48-25B	Ft15D / FGL150		0.6015	GG15	Grade 150	FG 15	
	A48-30B	Ft20D / FGL200		0.602	GG20	Grade 220	FG20	
	A48-45B	Ft30D / FGL300		0.603	GG30	Grade 300	FG 30	
	A48-50B	Ft35D / FGL350		0.6035	GG35	Grade 350	FG35	
A48-60B	Ft40D / FGL400		0.604	GG40	Grade 400			
BRONZE ALUMINIUM- BRONZE TIN BRONZE	C 60 800	CuAl6		2.0918	CuAl5As			
	C 61 000	CuAl8		2.092	CuAl8			
	C 61 400	CuAl7Fe2		2.0932	CuAl8Fe3	CA 106		
	C 62 300	CuAl9Fe3Mn2		2.0936	CuAl10Fe3Mn2	CA 105		
	C 95 200	CuAl9Fe3		2.094	CuAl10Fe	AB 1		
	B 505	CuAl9Fe3		2.094	G-FeAlBzF50	AB 1		
		CuAl9Mn2		2.096	CuAl9Mn2			
	C 63 200	CuAl9Ni5Fe3Mn		2.0966	CuAl10Ni5Fe4	CA 104		
	C 95 800	CuAl9Ni5Fe		2.097	G-NiAlBzF50	AB 2		
		CuAl11Ni5Fe5		2.0978	CuA11Ni6Fe5			
C 94100	CuPb20Sn5		2.1188	G-CuPb20Sn	LB5			

Technical data provided should be considered advisory only as variations may be necessary depending on the particular application.

Material Conversion Chart

								
	USA	France	Brazil	German W-nr	German DIN	UK	Spain	Japan JIS
BRASS	C 21000/34500	CuZn5		2.022/2.032	CuZn5	CZ 125/101		
	C 85700	CuZn40-Y30		2.034	G-CuZn37Pb	PCB 3		
	C 28000/38500	CuZn40/44Pb2		2.036/2.041	CuZn40/44Pb2	CZ 109/CZ130		
	C 68700	CuZn22Al2		2.046	CuZn20Al2	CZ 110		
	C 44300			2.047	CuZn28Sn1	CZ 111		
	C 46400			2.053	CuZn38Sn1	CZ 112		
	C 67400			2.055	CuZn40Al2	CZ 114		
	C 86400			2.0591	G-CuZn38Al	PCB1, DCB 3		
	C 86400	CuZn40-Y30		2.0592	G-CuZn35Al1	HTB 1		
	C 86300			2.0598	G-CuZn25Al5	HTB 3		
	C 90500			2.105	G-CuSn10Zn	G1		
	C 90800	CuSn12		2.1052	G-CuSn12	Pb2		
	C 91700			2.106	G-CuSn12Ni	CT2		
	C 90250			2.1086	G-CuSn10	CT1		
	C 93200	CuSn7Pb6Zn4		2.109	G-CuSn7ZnPb			
	C 92410			2.1093	G-CuSn6ZnNi	LG4		
	C 83600	CuPb5Sn5Zn5		2.1096	G-CuSn5ZnZn/RG5	LG2		
	C 93700	CuPb10Sn10		2.1176	G-CuPb10Sn	LB2		
C 93800			2.1182	G-CuPb15Sn	LB1			
COPPER COPPER/NICKEL ALLOYS	C 96200			2.0815	G-CuNi10			
	C 71300	CiNi25		2.083	CuNi25	CN 105		
	C 96400			2.0835	G-CuNi30	CN 2		
	C 72150	CuNi44		2.0842	CuNi44Mn1			
	C 70600	CuNi10Fe1Mn		2.0872	CuNi10Fe1Mn	CN 102		
	C 71500	CuNi30Mn1Fe		2.0882	CuNi30Mn1Fe	CN 107		
	C 17000	CuBe1,7		2.1245	CuBe1,7	CB 101		
	C 17200	CuBe1,9		2.1247	CuBe2			
	C 17500			2.1285	CuCo2Be	C 112		
	C 71640	CuNi30Fe2Mn2			CuNi30Fe2Mn2	CN 108		
	OF	Cu-c1/C2		2.004	OF-Cu	Cu-OF C 103/110		
	C 11000	Cu-a1/A2		2.006	E-Cu57	Cu-ETP-2 C 101		
	C 11000	Cu-a1		2.0065	E-Cu58	Cu-ETP-2 C 101		
	C 1200	Cu-b2		2.0076	SW-Cu			
	C 12200	Cu-b1		2.009	SF-Cu	Cu-DHP C 106		

Technical data provided should be considered advisory only as variations may be necessary depending on the particular application.

For product information, call your local distributor.



Corporate
Headquarters
Davenport, Iowa



Manufacturing
Vero Beach, Florida
Leeds, UK
Nanjing, China



Sales Offices
Derby, UK
Hong Kong
Maharashtra, India

Worldwide Distribution World Class Service

Centrally located in Davenport, Iowa, with national and international distribution through an extensive network of distributors and manufacturer's representatives, M.A. Ford® responds effectively to customer tooling needs. Our extensive line of standard products are on the shelf for immediate shipping and technical support is just a phone call away.

Visit www.maford.com for your local M.A. Ford® representative.

Where *high performance* is the *standard*®

ISO 9001:2008 Certified



Made in USA



800-553-8024 • 563-391-6220
www.maford.com



Where **high performance** is the **standard**®

Also available:



M.A. Ford® Mfg. Co., Inc.

7737 Northwest Blvd.
Davenport, IA 52806 USA
Ph: 563-391-6220 or 800-553-8024
Fax: 563-386-7660 or 800-892-9522
e-mail: sales@maford.com
www.maford.com

M.A. Ford® Asia-Pacific, Ltd.

Unit 2501, 25/F
148 Electric Road
North Point
Hong Kong
Ph: + 852-2167-7150
Fax: +852-2167-8150
sales@mafordap.com

M.A. Ford Europe Ltd.

Unit 38, Royal Scot Road
Pride Park, Derby
DE24 8AJ UK
Tel: +44(0) 1332 267960
Fax: +44(0) 1332 267969
sales@mafordeurope.com
www.mafordeurope.com

M.A. Ford® Asia-Pacific Ltd. (India)

412A, Arcadia
Hiranandani Estate,
Thane (W) - 400607
Maharashtra, India
Ph: +91 22 41237421
Fax: +91 22 41233387
sales@mafordin.com