

Mitutoyo

Mitutoyo Quality

PH-A14 PROFILE PROJECTOR

High performance, horizontal-beam projector equipped with highly accurate linear glass scales

OPTICAL MEASURING

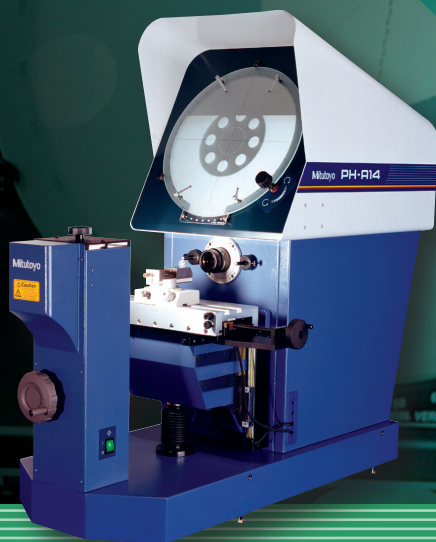

Bulletin No. 2198(2)

PH-A14 Horizontal Profile Projector

PH-A14 comes equipped with Linear Glass Scales factory mounted ready for your choice of optional display counters (shown with QM-Data 200)

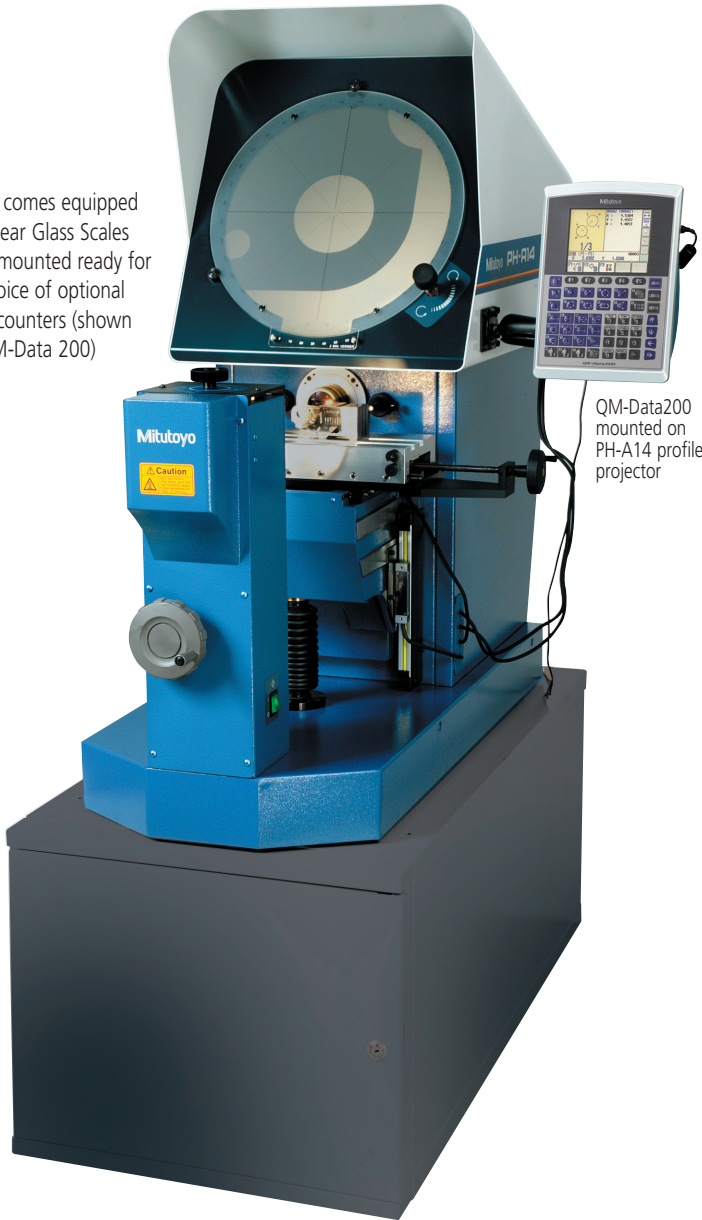

QM-Data200 mounted on PH-A14 profile projector

FEATURES

- Bench-top model that uses horizontal optical system.
- Suitable for thread pitch measurements—blurred or distorted images will not be produced when workpiece is angled.
- Inverted image on the day-bright screen.
- 14" (356mm) diameter vernier protractor screen with solid line cross-hairs for easy alignment.
- Heavy-duty workpiece table incorporates linear scales for fast, accurate measurement.
- The PH-A14's generous X, Y workstage travel (8" x 4") provides users with ample range to cover application needs.
- New location of the Y-axis handle improves ease of operation.
- The workstage provides high accuracy and can handle a workload of up to 100 lbs.
- Fiber illuminator is standard accessory.

Projection Lenses



Projection Capacity

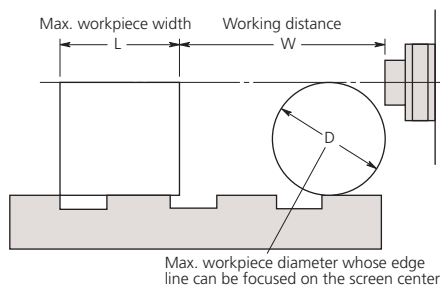

PH-A14

Unit: mm

	Magnification			
	10X	20X	50X	100X
View field	70.6	17.3	7.12	3.56
L	235	235	80	109
W	93	40	14.6	11
D	105	105	30.4	19

DIMENSIONS

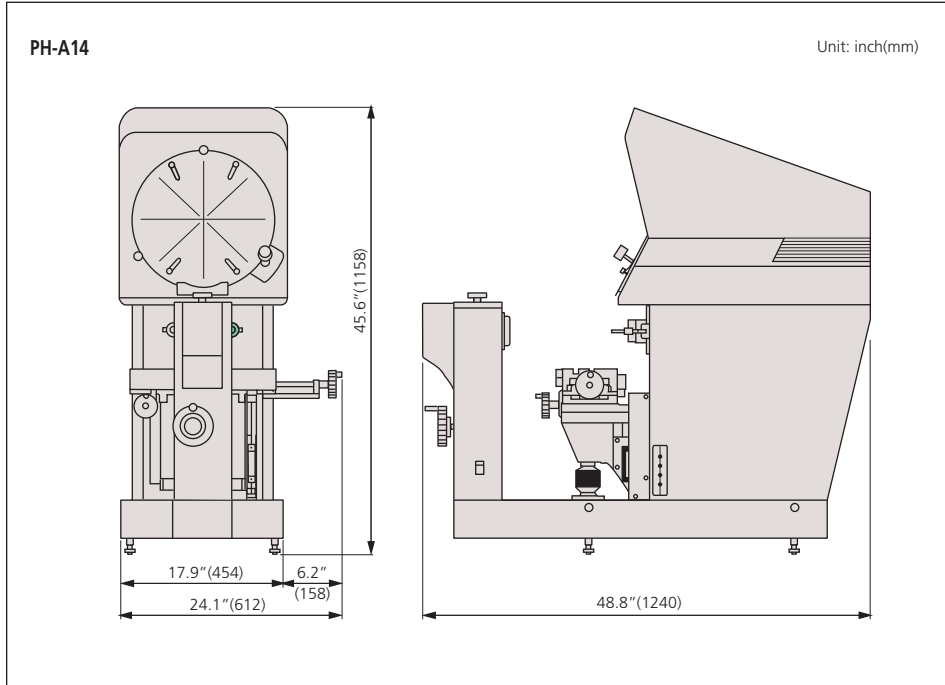

SPECIFICATIONS

Model No.	PH-A14	
Order No.	172-810-10A	
Projected Image	Inverted image	
Protractor screen	Effective diameter	14" / 356mm
	Screen material	Fine ground glass
	Reference line	Cross hair line
	Screen rotation	±360°, fine feed and clamp
	Angle display	Vernier reading, Resolution: 2'
Projection lens	Standard accessory: 10x(172-011), Optional accessories: 20X, 50X, 100X	
Magnification accuracy	Contour illumination	±0.1% or less
	Surface illumination	±0.15% or less
Contour illumination	light source	Halogen bulb(24V 150W)
	Optical system	Telecentric system
	Functions	Heat-absorbing filter, Cooling fan
Surface illumination	light source	Halogen bulb(24V 150W)
	Optical system	Twin fiber optic illumination
XY Stage	Table travel (X-axis)	8" / 203.2mm
	Table size(X, Z)	16 x 6" / 407 x 153mm
	Vertical travel (Y-axis)	4" / 101.6mm
	Resolution	.00005" / 0.001mm*
	Measuring Unit	Built in Linear scale
	Max. workpiece width	See (L) on page I-12
	Max. workpiece load	100lbs / 45kg
	Power supply	120V AC, 50/60Hz
Mass	308lbs / 140kg	
Standard accessories	10x projection lens set, work stage, power cord, halogen bulb, fuse, grounding wire, allen wrench	

*Counter not included

Standard Accessories

- 172-011:** Projection Lens 10x
- 512305:** Halogen bulb 24V 150W (500 Hours)
- 358191:** Fuse 6A (for 10-120V)
- 538815:** Hexagonal wrench 2.5
- 538616:** Hexagonal wrench 3
- 2BAC245:** Spanner wrench 2.5 1
- 99MBA051A:** Operational manual

See the backside for optional accessories



KA-200 Counter: 174-183A
64AAB149: Counter stand



QM-Data200
2-D data processing unit.
264-155A: Stand mount type
264-156A: Arm mount type



332-151: Optoeye
Edge detection system for QM-Data 200
12AAE671: Detector attachment (A)

Optional Accessories

- 172-011: 10X projection lens (standard accessory)
- 172-012: 20X projection lens
- 172-013: 50X projection lens set
- 172-014: 100X projection lens set
- 172-116: Standard scale (50mm)
- 172-117: Standard scale (2")
- 172-118: Reading scale (200mm)
- 172-161: Reading scale (300mm)
- 172-119: Reading scale (8")
- 172-162: Reading scale (12")
- 172-286: Green filter
- 512305: Halogen bulb (24V, 150W) (standard accessory)

Fixture and Stage accessories

- 172-142: Center support
- 172-143: Center support riser
- 172-144: Rotary vise
(Max. workpiece dia.: 2.4" / 60mm)
- 172-234: V-block with clamp
(Max. workpiece dia.: 2" / 50mm)
- 172-132: Vertical holder
- 64AAA129B: Machine stand 23"W x 45" D x 20" H

Reading Scales

- 172-118 (200mm)
- 172-161 (300mm)
- 172-119 (8")
- 172-162 (12")

Designed for checking the magnified image of a standard scale.



Center Support

172-142

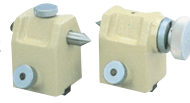

Clamps a cylindrical workpiece such as a screw
Workpiece dia.: 120mm max

Center Support Riser

172-143

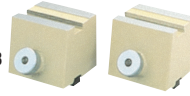

Widens the damping capacity of the center support to a maximum diameter of 240mm.

Rotary Vise

172-144



Workpiece dia.: 60mm max

Vertical Holder

172-132

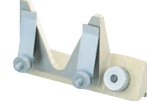

Set up a thin workpiece easily

Standard Scales

- 172-116 (50mm)
- 172-117 (2")



Used for checking magnifying accuracy.

V-Block w/ Clamp

172-234



Workpiece dia.: 50mm max

Green Filter

172-286

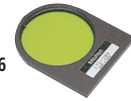

Increases the screen sharpness of the contour image.



Whatever your challenges are, Mitutoyo supports you from start to finish.

Mitutoyo is not only a manufacturer of top-quality measuring products but one that also offers qualified support for the lifetime of the equipment, backed by comprehensive services that ensure your staff can make the very best use of the investment.

Apart from the basics of calibration and repair, Mitutoyo offers product and metrology training, as well as IT support for the sophisticated software used in modern measuring technology. We can also design, build, test and deliver measuring solutions and even, if deemed cost-effective, take your critical measurement challenges in-house on a sub-contract basis.



Find additional product literature and our product catalog

www.mitutoyo.com

Mitutoyo

Mitutoyo America Corporation

www.mitutoyo.com
One Number to Serve You Better
1-888-MITUTOYO (1-888-648-8869)

M³ Solution Centers:

- Aurora, Illinois (Headquarters)
- Boston, Massachusetts
- Huntersville, North Carolina
- Mason, Ohio
- Plymouth, Michigan
- City of Industry, California
- Birmingham, Alabama
- Renton, Washington
- Houston, Texas

Note: All information regarding our products, and in particular the illustrations, drawings, dimensional and performance data contained in this printed matter as well as other technical data are to be regarded as approximate average values. We therefore reserve the right to make changes to the corresponding designs. The stated standards, similar technical regulations, descriptions and illustrations of the products were valid at the time of printing. In addition, the latest applicable version of our General Trading Conditions will apply. Only quotations submitted by ourselves may be regarded as definitive. Specifications are subject to change without notice.

Mitutoyo products are subject to US Export Administration Regulations (EAR). Re-export or relocation of our products may require prior approval by an appropriate governing authority.

Trademarks and Registrations

Designations used by companies to distinguish their products are often claimed as trademarks. In all instances where Mitutoyo America Corporation is aware of a claim, the product names appear in initial capital or all capital letters. The appropriate companies should be contacted for more complete trademark and registration information.