



Gauge Blocks



Height Master



Reference Gages



**Granite Surface
Plates & Bench
Comparator**

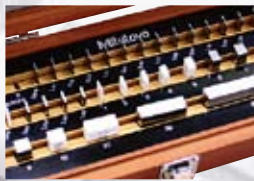

**CERA/Steel
Combination
Gauge Block Sets**



Step Master



ZERO CERA BLOCK



**Ceramic
Straight
Master**

INDEX

Gauge Blocks	
Features	E-2
Accuracies	E-4
Metric Rectangular Gauge Block Sets	E-6
Inch Rectangular Gauge Block Sets	E-11
Micrometer Inspection Gauge Block Sets	E-12
Caliper Inspection Gauge Block Sets	E-13
Individual Metric Rectangular Gauge Blocks	E-14
Individual Inch Rectangular Gauge Blocks	E-16
Rectangular Gauge Blocks with CTE	E-17
ZERO CERA BLOCKS	E-17
Rectangular Gauge Block Accessories	E-18
Metric Square Gauge Block Sets	E-20
Inch Square Gauge Block Sets	E-21
Individual Metric Square Gauge Blocks	E-22
Individual Inch Square Gauge Blocks	E-23
Square Gauge Block Accessories	E-24
Ceraston	E-26
Maintenance Kit for Gauge Blocks	E-26
Step Master	E-27
Custom-made Blocks & Gages	E-27
Gauge Block Interferometer GBI	E-28
Gauge Block Comparator GBCD-100A	E-28
Gauge Block Comparator GBCD-250	E-29
Gauge Block Comparator GBCS-250	E-29
Height Master	
Height Master	E-30
Digital Height Master	E-30
CERA Height Master	E-31
Auxiliary Block Kit	E-31
Riser Blocks	E-31
Universal Height Master	E-32
Check Master	E-33
Reference Gages	
Standard Scales	E-34
Working Standard Scales	E-34
CERA Straight Master	E-35
Snap Gage Checker	E-36
High Precision Square	E-36
Square Master	E-37
Precision Square	E-38
Precision Dial Square	E-38
Combination Square Set	E-39
Steel Rules	E-40
Thickness Gages	E-41
Radius Gages	E-42
Thread Pitch Gages	E-42
Digital Universal Protractor	E-43
Universal Bevel Protractor	E-43
Bevel Protractor	E-43
Spring Dividers and Calipers	E-44
Precision Levels	E-44
Granite Surface Plates & Bench Micrometer	
Bench Micrometer	E-45
Bench Centers	E-45
Black Granite Surface Plates	E-46

Gauge Blocks

SERIES 516

FEATURES

Precision gauge blocks are the primary standards vital to dimensional quality control in the manufacture of parts. Mitutoyo offers an extensive selection of gauge

blocks available in a choice of rectangular or square, metric or inch, and steel or ceramic types.

Accuracy

Gauge blocks offered by Mitutoyo, an all-round precision measuring machine manufacturer, guarantee such a high accuracy that users can use them without anxiety. Needless to say, Mitutoyo has established a traceability system for our measurement products, up to the Metrology Management Center of the National Institute of Advanced Industrial Science and Technology (AIST) and we have been certified by the Japanese government as an accredited laboratory.

Wringing

The lapping technique is one of Mitutoyo's specialties. Our advanced technique, developed over more than a half century, enables us to achieve the best flatness and surface roughness needed for gauge blocks and thus maximize the wringing force.

Abrasion Resistance and Dimensional Stability of Steel blocks

High-carbon high-chrome steel is employed to satisfy a variety of the material characteristics required for gauge blocks. Our advanced heat treatment technology for steel blocks, which involves repeated high and low temperature cycles, simultaneously achieves excellent abrasion resistance and reduces change in length over time to the minimum.

CERA Blocks

CERA blocks are made of a ceramic material with a superior surface finish, created by Mitutoyo's ultra-precision machining techniques, that provides a premium quality block.

1. Corrosion Resistant

Anti-corrosion treatment is not required when handled normally (i.e. with fingers), resulting in simple maintenance and storage.

2. No Burrs Caused by Dents, etc.

Since the CERA Block is very hard, it will not scratch and is highly resistant to burrs. If a burr is formed, it can easily be removed with a ceramic deburring stone (Ceraston).

3. Abrasion Resistant

CERA Blocks have 10 times the abrasion resistance of steel gauge blocks.

4. Dimensionally Stable

CERA Blocks are free from dimensional change over time.

5. Sizes Clearly Marked

Black characters, indicating the nominal length, are inscribed by laser and are clearly visible against the white surface of the block.



Selecting Gauge Blocks

- Gauge blocks are designed to offer the construction of practically any size, within the range of a set, using the minimum number of blocks. Long block sets are available if a longer length is required than is provided by the standard sets.
- Gauge block sets should be selected in accordance with the minimum length step required. Wear block sets should be used if the application is likely to involve rapid wear of the end blocks in a stack (and the minimum sizes required allow this). This will preserve the life of the set by confining wear to the wear blocks, whose cost of replacement is far less than that of a complete set.
- If a set containing a large number of gauge blocks is selected, the number of gauge blocks required for any particular length may be reduced and the number of combinations is increased. Accuracy will be retained and wear will be reduced.
- Dedicated gauge block sets for micrometer inspection and caliper inspection are available.
- If using only one length repeatedly, it is a good idea to purchase discrete gauge blocks.
- The 2mm-based gauge blocks, which take the minimum length step as 2mm, are easier to handle than 1mm-based gauge blocks.

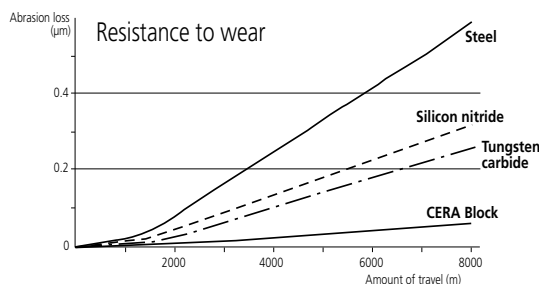

Grade and Application

The following table can be used to select the gauge block grade according to usage (specified by DIN861, BS4311, and JIS B 7506).

	Applications	Grade
Workshop use	<ul style="list-style-type: none"> Mounting tools and cutters 	2
	<ul style="list-style-type: none"> Manufacturing gages Calibrating instruments 	1 or 2
Inspection use	<ul style="list-style-type: none"> Inspecting mechanical parts, tools, etc. 	1 or 2
	<ul style="list-style-type: none"> Checking the accuracy of gages Calibrating instruments 	0 or 1
Calibration use	<ul style="list-style-type: none"> Checking the accuracy of gauge blocks for workshop 	K or 0
	<ul style="list-style-type: none"> Checking the accuracy of gauge blocks for inspection 	
	<ul style="list-style-type: none"> Checking the accuracy of instruments 	
	<ul style="list-style-type: none"> Checking the accuracy of gauge blocks for calibration For academic research 	
Reference use	<ul style="list-style-type: none"> Checking the accuracy of gauge blocks for calibration For academic research 	K

Grade 2:

These gauge blocks are intended for shop floor use to set and calibrate fixtures as well as precision instruments.

Grade 1:

This grade is used within an inspection area to verify the accuracy of plug and snap gages as well as for setting electronic measuring devices.

Grade 0:

These higher accuracy gauges are intended for use within a controlled environment by skilled inspection staff. Mainly used as reference standards for setting high precision measuring equipment and for the calibration of lower grade gauge blocks.

Grade K:

Gauge blocks of this accuracy are intended for use within a temperature controlled inspection room or calibration laboratory. They should be used as masters with certificates against other gauge blocks which are calibrated by comparison.

Constructing a Gauge Block Stack

The following points should be noted when constructing a gauge block stack:

- Use as few gauge blocks as possible to obtain the required length by selecting thick blocks wherever possible.
- Select the block for the least significant digit first, then work back through the more significant digits until the required length is attained.
- There are multiple combinations for the integer part of a length. To prevent wear as much as possible, do not always use the same gauge blocks.

Example:

Required length = 45.6785mm

For the 1mm-based gauge block set (112 pcs.)

$$\begin{array}{r}
 1.0005 \\
 1.008 \\
 1.17 \\
 17.5 \\
 + 25 \\
 \hline
 45.6785\text{mm}
 \end{array}$$

For a 2mm-based gauge block set (112 pcs.)

$$\begin{array}{r}
 2.0005 \\
 2.008 \\
 2.17 \\
 14.5 \\
 + 25 \\
 \hline
 45.6785\text{mm}
 \end{array}$$

6. Non-magnetic Nature Prevents Steel Swarf Contamination

7. High Wringing Force

Superior flatness and surface finish provides maximum wringing force.



8. Superior Material Characteristics of CERA block

Property	Material	CERA Block (ZrO ₂)	Steel (Fe)	Carbide (WC-Co)	Silicon nitride (Si ₃ N ₄)
Hardness (HV)		1350	800	1650	1500
Coefficient of thermal expansion (10 ⁻⁶ /K)		9.3±0.5	10.8±0.5	5.5±1.0	2
Flexural strength by 3-point bending (MPa)		1270	1960	1960	580
Fracture toughness K1c (MPa•m ^{1/2})		7	120	12	6.5
Young's modulus x10 ⁻⁴ (MPa)		20.6	20.6	61.8	28.4
Poisson's ratio		0.3	0.3	0.2	0.3
Specific gravity		6.0	7.8	14.8	3.2
Thermal conductivity (W/m•k)		2.9	54.4	79.5	16.7

9. Closest Expansion Coefficient to Steel

The thermal expansion coefficient of a CERA Block is quite similar to that of a steel gauge block.

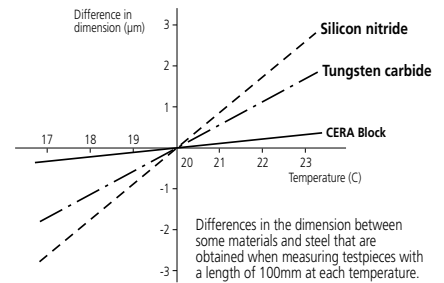

10. Highly Resistant to Dropping and Impact

The CERA Block material is one of the toughest ceramics. It is extremely difficult to crack a CERA block in normal use.

Features of Square Gauge Blocks

1. Stack can be positively clamped by using the center hole

After wringing square gauge blocks, an optional tie rod can be inserted through the center hole to clamp the blocks together using a screw.



2. A height reference standard can easily be made

A precision height reference standard can be made easily and inexpensively using accessories such as the plain jaw and block base.



3. A dedicated inspection jig can easily be made

A dedicated inspection jig for periodic inspection of instruments can be made easily and inexpensively.



4. A wide measuring surface with cross-sectional dimensions of 24.1 x 24.1mm is available.

A square gauge block retains stable orientation both longitudinally and laterally. A wide range of application are covered, including cutting tool positioning, angle measurement with a sine bar, taper measurement with a roller, and inspection of depth micrometers.



Long and Ultra-Thin Gauge Blocks

Mitutoyo offers extra-thin gauge blocks from 0.10 mm to 0.99 mm (increments of 0.01 mm) as well as long gauge blocks up to 1,000 mm as standard products.

Gauge Blocks

SERIES 516

Accuracies of Mitutoyo Gauge Blocks

Mitutoyo gauge blocks meet or exceed all known specifications. The flatness, parallelism and surface finish necessary to achieve the required accuracies are the same as, or better than, published specifications.

ACCURACY SPECIFICATIONS: JIS B 7506-2004 (JAPAN)

(at 20°C)

Nominal length (mm)		Grade K		Grade 0	
		Limit deviation of length at any point	Tolerance for the variation in length	Limit deviation of length at any point	Tolerance for the variation in length
from 0.5	up to 10	±0.20µm	0.05µm	±0.12µm	0.10µm
over 10	up to 25	±0.30µm	0.05µm	±0.14µm	0.10µm
over 25	up to 50	±0.40µm	0.06µm	±0.20µm	0.10µm
over 50	up to 75	±0.50µm	0.06µm	±0.25µm	0.12µm
over 75	up to 100	±0.60µm	0.07µm	±0.30µm	0.12µm
over 100	up to 150	±0.80µm	0.08µm	±0.40µm	0.14µm
over 150	up to 200	±1.00µm	0.09µm	±0.50µm	0.16µm
over 200	up to 250	±1.20µm	0.10µm	±0.60µm	0.16µm
over 250	up to 300	±1.40µm	0.10µm	±0.70µm	0.18µm
over 300	up to 400	±1.80µm	0.12µm	±0.90µm	0.20µm
over 400	up to 500	±2.20µm	0.14µm	±1.10µm	0.25µm
over 500	up to 600	±2.60µm	0.16µm	±1.30µm	0.25µm
over 600	up to 700	±3.00µm	0.18µm	±1.50µm	0.30µm
over 700	up to 800	±3.40µm	0.20µm	±1.70µm	0.30µm
over 800	up to 900	±3.80µm	0.20µm	±1.90µm	0.35µm
over 900	up to 1000	±4.20µm	0.25µm	±2.00µm	0.40µm

Nominal length (mm)		Grade 1		Grade 2	
		Limit deviation of length at any point	Tolerance for the variation in length	Limit deviation of length at any point	Tolerance for the variation in length
from 0.5	up to 10	±0.20µm	0.16µm	±0.45µm	0.30µm
over 10	up to 25	±0.30µm	0.16µm	±0.60µm	0.30µm
over 25	up to 50	±0.40µm	0.18µm	±0.80µm	0.30µm
over 50	up to 75	±0.50µm	0.18µm	±1.00µm	0.35µm
over 75	up to 100	±0.60µm	0.20µm	±1.20µm	0.35µm
over 100	up to 150	±0.80µm	0.20µm	±1.60µm	0.40µm
over 150	up to 200	±1.00µm	0.25µm	±2.00µm	0.40µm
over 200	up to 250	±1.20µm	0.25µm	±2.40µm	0.45µm
over 250	up to 300	±1.40µm	0.25µm	±2.80µm	0.50µm
over 300	up to 400	±1.80µm	0.30µm	±3.60µm	0.50µm
over 400	up to 500	±2.20µm	0.35µm	±4.40µm	0.60µm
over 500	up to 600	±2.60µm	0.40µm	±5.00µm	0.70µm
over 600	up to 700	±3.00µm	0.45µm	±6.00µm	0.70µm
over 700	up to 800	±3.40µm	0.50µm	±6.50µm	0.80µm
over 800	up to 900	±3.80µm	0.50µm	±7.50µm	0.90µm
over 900	up to 1000	±4.20µm	0.60µm	±8.00µm	1.00µm

ACCURACY SPECIFICATIONS: BS 4311: Part 1: 1993 (UK)

(at 20°C)

Nominal length (inch)		Grade K			Grade 0		
		Tolerance on deviation of measured central length	Parallelism	Flatness	Tolerance on deviation of measured central length	Parallelism	Flatness
over 0	up to 0.4	±5µin	2µin	2µin	±5µin	4µin	4µin
over 0.4	up to 1	±6µin	2µin	2µin	±6µin	4µin	4µin
over 1	up to 2	±8µin	3µin	2µin	±8µin	4µin	4µin
over 2	up to 3	±10µin	3µin	2µin	±10µin	5µin	4µin
over 3	up to 4	±12µin	3µin	2µin	±12µin	5µin	4µin

Nominal length (inch)		Grade 1			Grade 2		
		Tolerance on deviation of measured central length	Parallelism	Flatness	Tolerance on deviation of measured central length	Parallelism	Flatness
over 0	up to 0.4	±10µin	6µin	6µin	±20µin	12µin	10µin
over 0.4	up to 1	±12µin	6µin	6µin	±25µin	12µin	10µin
over 1	up to 2	±15µin	7µin	6µin	±30µin	12µin	10µin
over 2	up to 3	±20µin	7µin	6µin	±40µin	14µin	10µin
over 3	up to 4	±25µin	8µin	6µin	±50µin	14µin	10µin

Mitutoyo Gauge Blocks and Inspection Certificates

A Certificate of Inspection is furnished with all Mitutoyo gauge blocks with a serial number on the box (in the case of sets) and an identification number on each block. The deviation of each block from nominal length, at the time of inspection, is stated. For this inspection, each gauge block is measured relative to the upper level master using a gauge block comparator. Grade K gauge blocks are measured by a primary measurement method using an interferometer.

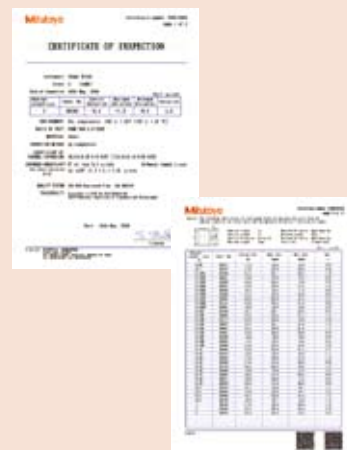

ACCURACY SPECIFICATIONS: BS 4311: Part 1: 1993 (UK)

(at 20°C)

Nominal length (mm)		Grade K			Grade 0		
		Tolerance on deviation of measured central length	Parallelism	Flatness	Tolerance on deviation of measured central length	Parallelism	Flatness
over 0	up to 10	±0.12µm	0.05µm	0.05µm	±0.12µm	0.10µm	0.10µm
over 10	up to 25	±0.15µm	0.05µm	0.05µm	±0.15µm	0.10µm	0.10µm
over 25	up to 50	±0.20µm	0.06µm	0.05µm	±0.20µm	0.10µm	0.10µm
over 50	up to 75	±0.25µm	0.06µm	0.05µm	±0.25µm	0.12µm	0.10µm
over 75	up to 100	±0.30µm	0.07µm	0.05µm	±0.30µm	0.12µm	0.10µm

Nominal length (mm)		Grade 1			Grade 2		
		Tolerance on deviation of measured central length	Parallelism	Flatness	Tolerance on deviation of measured central length	Parallelism	Flatness
over 0	up to 10	±0.25µm	0.16µm	0.15µm	±0.50µm	0.30µm	0.25µm
over 10	up to 25	±0.30µm	0.16µm	0.15µm	±0.60µm	0.30µm	0.25µm
over 25	up to 50	±0.40µm	0.18µm	0.15µm	±0.80µm	0.30µm	0.25µm
over 50	up to 75	±0.50µm	0.18µm	0.15µm	±1.00µm	0.35µm	0.25µm
over 75	up to 100	±0.60µm	0.20µm	0.15µm	±1.20µm	0.35µm	0.25µm

ACCURACY SPECIFICATIONS: ASME B89.1.9-2002 (USA)

(at 20°C)

Nominal length (inch)		Grade K		Grade 00		Grade 0		Grade 1		Grade 2	
		Limit deviations of length at any point	Tolerance for the variation in length	Limit deviations of length at any point	Tolerance for the variation in length	Limit deviations of length at any point	Tolerance for the variation in length	Limit deviations of length at any point	Tolerance for the variation in length	Limit deviations of length at any point	Tolerance for the variation in length
	up to .05	±12µm	2µm	±4µm	2µm	±6µm	4µm	±12µm	6µm	±24µm	12µm
over .05	up to .4	±10µm	2µm	±3µm	2µm	±5µm	4µm	±8µm	6µm	±18µm	12µm
over .45	up to 1	±12µm	2µm	±3µm	2µm	±6µm	4µm	±12µm	6µm	±24µm	12µm
over 1	up to 2	±16µm	2µm	±4µm	2µm	±8µm	4µm	±16µm	6µm	±32µm	12µm
over 2	up to 3	±20µm	2µm	±5µm	3µm	±10µm	4µm	±20µm	6µm	±40µm	14µm
over 3	up to 4	±24µm	3µm	±6µm	3µm	±12µm	5µm	±24µm	8µm	±48µm	14µm
over 4	up to 5	±32µm	3µm	±8µm	3µm	±16µm	5µm	±32µm	8µm	±64µm	16µm
over 5	up to 6	±32µm	3µm	±8µm	3µm	±16µm	5µm	±32µm	8µm	±64µm	16µm
over 6	up to 7	±40µm	4µm	±10µm	4µm	±20µm	6µm	±40µm	10µm	±80µm	16µm
over 7	up to 8	±40µm	4µm	±10µm	4µm	±20µm	6µm	±40µm	10µm	±80µm	16µm
over 8	up to 10	±48µm	4µm	±12µm	4µm	±24µm	6µm	±48µm	10µm	±104µm	18µm
over 10	up to 12	±56µm	4µm	±14µm	4µm	±28µm	7µm	±56µm	10µm	±112µm	20µm
over 12	up to 16	±72µm	5µm	±18µm	5µm	±36µm	8µm	±72µm	12µm	±144µm	20µm
over 16	up to 20	±88µm	6µm	±20µm	6µm	±44µm	10µm	±88µm	14µm	±176µm	24µm
over 20	up to 24	±104µm	6µm	±25µm	6µm	±52µm	10µm	±104µm	16µm	±200µm	28µm
over 24	up to 28	±120µm	7µm	±30µm	7µm	±60µm	12µm	±120µm	18µm	±240µm	28µm
over 28	up to 32	±136µm	8µm	±34µm	8µm	±68µm	12µm	±136µm	20µm	±260µm	32µm
over 32	up to 36	±152µm	8µm	±38µm	8µm	±76µm	14µm	±152µm	20µm	±300µm	36µm
over 36	up to 40	±160µm	10µm	±40µm	10µm	±80µm	16µm	±168µm	24µm	±320µm	40µm

ACCURACY SPECIFICATIONS: ASME B89.1.9-2002 (USA)

Nominal length (mm)		Grade K		Grade 00		Grade 0		Grade 1		Grade 2	
		Limit deviations of length at any point	Tolerance for the variation in length	Limit deviations of length at any point	Tolerance for the variation in length	Limit deviations of length at any point	Tolerance for the variation in length	Limit deviations of length at any point	Tolerance for the variation in length	Limit deviations of length at any point	Tolerance for the variation in length
	up to 0.5	±0.30µm	0.05µm	±0.10µm	0.05µm	±0.14µm	0.10µm	±0.30µm	0.16µm	±0.60µm	0.30µm
over 0.5	up to 10	±0.20µm	0.05µm	±0.07µm	0.05µm	±0.12µm	0.10µm	±0.20µm	0.16µm	±0.45µm	0.30µm
over 10	up to 25	±0.30µm	0.05µm	±0.07µm	0.05µm	±0.14µm	0.10µm	±0.30µm	0.16µm	±0.60µm	0.30µm
over 25	up to 50	±0.40µm	0.06µm	±0.10µm	0.06µm	±0.20µm	0.10µm	±0.40µm	0.18µm	±0.80µm	0.30µm
over 50	up to 75	±0.50µm	0.06µm	±0.12µm	0.06µm	±0.25µm	0.12µm	±0.50µm	0.18µm	±1.00µm	0.35µm
over 75	up to 100	±0.60µm	0.07µm	±0.15µm	0.07µm	±0.30µm	0.12µm	±0.60µm	0.20µm	±1.20µm	0.35µm
over 100	up to 150	±0.80µm	0.08µm	±0.20µm	0.08µm	±0.40µm	0.14µm	±0.80µm	0.20µm	±1.60µm	0.40µm
over 150	up to 200	±1.00µm	0.09µm	±0.25µm	0.09µm	±0.50µm	0.16µm	±1.00µm	0.25µm	±2.00µm	0.40µm
over 200	up to 250	±1.20µm	0.10µm	±0.30µm	0.10µm	±0.60µm	0.16µm	±1.20µm	0.25µm	±2.40µm	0.45µm
over 250	up to 300	±1.40µm	0.10µm	±0.35µm	0.10µm	±0.70µm	0.18µm	±1.40µm	0.25µm	±2.80µm	0.50µm
over 300	up to 400	±1.80µm	0.12µm	±0.45µm	0.12µm	±0.90µm	0.20µm	±1.80µm	0.30µm	±3.60µm	0.50µm
over 400	up to 500	±2.20µm	0.14µm	±0.50µm	0.14µm	±1.10µm	0.25µm	±2.20µm	0.35µm	±4.40µm	0.60µm
over 500	up to 600	±2.60µm	0.16µm	±0.65µm	0.16µm	±1.30µm	0.25µm	±2.60µm	0.40µm	±5.00µm	0.70µm
over 600	up to 700	±3.00µm	0.18µm	±0.75µm	0.18µm	±1.50µm	0.30µm	±3.00µm	0.45µm	±6.00µm	0.70µm
over 700	up to 800	±3.40µm	0.20µm	±0.85µm	0.20µm	±1.70µm	0.30µm	±3.40µm	0.50µm	±6.50µm	0.80µm
over 800	up to 900	±3.80µm	0.20µm	±0.95µm	0.20µm	±1.90µm	0.35µm	±3.80µm	0.50µm	±7.50µm	0.90µm
over 900	up to 1000	±4.20µm	0.25µm	±1.00µm	0.25µm	±2.00µm	0.40µm	±4.20µm	0.60µm	±8.00µm	1.00µm

Metric Rectangular Gauge Block Sets

SERIES 516 — 1mm Base Block Sets



SPECIFICATIONS

1mm Base Block Sets

Blocks per set	Order No.		Standard / grade available and Suffix No.*			Blocks included in set		
	Steel (Steel/CERA)	CERA	ISO/DIN/JIS	ASME	BS	Size	Step	Qty.
122	—	—	—	—	—	1.0005	—	1
	516-596	—	K: -#0	—	—	1.001 - 1.009	0.001	9
	516-597	—	O: -#0	—	—	1.01 - 1.49	0.01	49
	516-598	—	1: -#0	—	—	1.6 - 1.9	0.1	4
	516-599	—	2: -#0	—	—	0.5 - 24.5	0.5	49
112	516-531	516-541	—	—	—	25 - 100	10	8
	516-937	516-337	K: -#0	00: -#6	K: -#1	25, 75	2	2
	516-938	516-338	O: -#0	0: -#6	O: -#1	1.0005	1	1
	516-939	516-339	1: -#0	1: -#6	1: -#1	1.001 - 1.009	0.001	9
	516-940	516-340	2: -#0	2: -#6	2: -#1	1.01 - 1.49	0.01	49
103	516-533	516-542	—	—	—	1.01 - 1.49	0.01	49
	516-941	516-341	K: -#0	00: -#6	K: -#1	0.5 - 24.5	0.5	49
	516-942	516-342	O: -#0	0: -#6	O: -#1	25 - 100	25	4
	516-943	516-343	1: -#0	1: -#6	1: -#1	1.005	1	1
	516-944	516-344	2: -#0	2: -#6	2: -#1	1.01 - 1.49	0.01	49
88	516-969	516-369	—	—	—	0.5 - 24.5	0.5	49
	516-970	516-370	O: -#0	—	—	25 - 100	25	4
	516-971	516-371	1: -#0	—	—	1.0005	1	1
	516-972	516-372	2: -#0	—	—	1.001 - 1.009	0.001	9
	87	516-945	516-345	K: -#0	00: -#6	K: -#1	1.01 - 1.49	0.01
516-946 (516-946)		516-346	O: -#0 (-#3)	0: -#6	O: -#1 (-#5)	0.5 - 9.5	0.5	19
516-947 (516-947)		516-347	1: -#0 (-#3)	1: -#6	1: -#1 (-#5)	10 - 100	10	10
516-948 (516-948)		516-348	2: -#0 (-#3)	2: -#6	2: -#1 (-#5)	1.001 - 1.009	0.001	9
76		516-949	516-349	—	—	—	1.01 - 1.49	0.01
	516-950	516-350	K: -#0	—	—	0.5 - 9.5	0.5	19
	516-951	516-351	O: -#0	—	—	10 - 40	10	4
	516-952	516-352	1: -#0	—	—	50 - 100	25	3
	56	516-952	516-352	2: -#0	—	—	0.5	1
516-536		516-544	—	—	—	1.001 - 1.009	0.001	9
516-953		516-353	K: -#0	00: -#6	—	1.01 - 1.09	0.01	9
516-954		516-354	O: -#0	0: -#6	—	1.1 - 1.9	0.1	9
516-955		516-355	1: -#0	1: -#6	—	1 - 24	1	24
47	516-956	516-356	2: -#0	2: -#6	—	25 - 100	25	4
	516-537	516-545	—	—	—	1.005	1	1
	516-957	516-357	K: -#0	00: -#6	—	1.01 - 1.09	0.01	9
	516-958 (516-958N)	516-358	O: -#0 (-#3)	0: -#6 (-#7)	—	1.1 - 1.9	0.1	9
	516-959 (516-959N)	516-359	1: -#0 (-#3)	1: -#6 (-#7)	—	1 - 24	1	24
47	516-960 (516-960N)	516-360	2: -#0 (-#3)	2: -#6	—	25 - 100	25	4
	516-961	516-361	K: -#0	—	—	1.005	1	1
	516-962 (516-962N)	516-362	O: -#0 (-#3)	—	—	1.01 - 1.19	0.01	19
	516-963 (516-963N)	516-363	1: -#0 (-#3)	—	—	1.2 - 1.9	0.1	8
	516-964 (516-964N)	516-364	2: -#0 (-#3)	—	—	1 - 9	1	9

() : CERA blocks are adopted for blocks of frequently-used sizes.

87-block set: 0.5mm, 1mm, 1.1mm, 1.2mm, 1.3mm, 1.4mm, 1.5mm, 2mm, 3mm, 4mm, 5mm, 10mm, 20mm and 30mm

47-block set: 1mm, 1.5mm, 2mm, 3mm, 4mm, 5mm, 10mm and 20mm

*Suffix No. (■) for Selecting Certificate Provided

ISO/DIN/JIS		
Suffix No.	Inspection Certificate	Calibration Certificate
1	○	—
6	○	○

Suffix No. 1: Not available for Grade K sets.

ASME		
Suffix No.	Inspection Certificate	Calibration Certificate
1	○	—
6	○	○

Suffix No. 1: Not available for Grade K sets.

Suffix No. 6: Only for Grade K sets.

BS		
Suffix No.	Inspection Certificate	Calibration Certificate
1	○	—
6	○	○

Suffix No. 1: Not available for Grade K sets.

Suffix No. 7: Only for Grade K sets.

Inspection Certificate

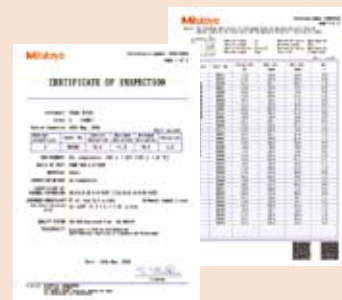

***Suffix No. (■) for Selecting Certificate Provided**

ISO/DIN/JIS

Suffix No.	Inspection Certificate	Calibration Certificate
1	○	—
6	○	○

Suffix No. 1: Not available for Grade K sets.
Suffix No. 6: Only for Grade K sets.

ASME

Suffix No.	Inspection Certificate	Calibration Certificate
1	○	—
6	○	○

Suffix No. 1: Not available for Grade K sets.
Suffix No. 6: Only for Grade K sets.

BS

Suffix No.	Inspection Certificate	Calibration Certificate
1	○	—
6	○	○

Suffix No. 1: Not available for Grade K sets.
Suffix No. 7: Only for Grade K sets.

Inspection Certificate



CERA/Steel combination 47-block set



CERA/Steel combination 32-block set



CERA/Steel combination 32-block set



CERA/Steel combination 24-block set



CERA/Steel combination 19-block set



CERA/Steel combination 10-block set

SPECIFICATIONS

1mm Base Block Sets

Blocks per set	Order No.		Standard / grade available and Suffix No.*			Blocks included in set		
	Steel (Steel/CERA)	CERA	ISO/DIN/JIS	ASME	BS	Size	Step	Qty.
46	—	—	—	—	—	1.001 - 1.009	0.001	9
	516-994	516-394	K: -■0	—	—	1.01 - 1.09	0.01	9
	516-995	516-395	0: -■0	—	—	1.1 - 1.9	0.1	9
	516-996	516-396	1: -■0	—	—	1 - 9	1	9
	516-997	516-397	2: -■0	—	—	10 - 100	10	10
34	—	—	—	—	—	1.0005	—	1
	516-128	516-178	K: -■0	—	K: -■1	1.001 - 1.009	0.001	9
	516-129	516-179	0: -■0	—	0: -■1	1.01 - 1.09	0.01	9
	516-130	516-180	1: -■0	—	1: -■1	1.1 - 1.9	0.1	9
	516-131	516-181	2: -■0	—	2: -■1	1 - 5	1	5
32	—	—	—	—	—	1.005	—	1
	516-965	516-365	K: -■0	—	K: -■1	1.01 - 1.09	0.01	9
	516-966 (516-966N)	516-366	0: -■0 (-■3)	—	0: -■1 (-■5)	1.1 - 1.9	0.1	9
	516-967 (516-967N)	516-367	1: -■0 (-■3)	—	1: -■1 (-■5)	1 - 9	1	9
	516-968 (516-968N)	516-368	2: -■0 (-■3)	—	2: -■1 (-■5)	10 - 30	10	3
24	—	—	—	—	—	1.01 - 1.09	0.01	9
	(516-488)	—	0: (-■3)	0: (-■7)	0: (-■5)	1.1 - 1.9	0.1	9
	(516-489)	—	1: (-■3)	1: (-■7)	1: (-■5)	1 - 5	1	5
	(516-490)	—	2: (-■3)	—	2: (-■5)	10	1	1
	—	—	—	—	—	—	—	—
19	—	—	—	—	—	1.1 - 1.9	0.1	9
	(516-484)	—	0: (-■3)	0: (-■7)	0: (-■5)	1 - 5	1	5
	(516-485)	—	1: (-■3)	1: (-■7)	1: (-■5)	10 - 20	10	2
	(516-486)	—	2: (-■3)	—	2: (-■5)	25, 50, 100	—	3
10	—	—	—	—	—	1 - 5	1	5
	(516-480)	—	0: (-■3)	0: (-■7)	0: (-■5)	10 - 20	10	2
	(516-481)	—	1: (-■3)	1: (-■7)	1: (-■5)	25, 50, 100	—	3
	(516-482)	—	2: (-■3)	—	2: (-■5)	—	—	—

() : CERA blocks are adopted for blocks of frequently-used sizes.
32-block set: 1mm, 1.5mm, 2mm, 3mm, 4mm, 5mm, 10mm and 20mm
24-block set: 1mm, 1.5mm, 2mm, 3mm, 5mm and 10mm
19-block set: 1mm, 2mm, 3mm, 5mm and 10mm
10-block set: 1mm, 2mm and 10mm



Metric Rectangular Gauge Block Sets

SERIES 516 — 2mm Base Block Sets, 0.001mm Step Block Sets



Steel 112-block set



Steel 88-block set



Steel 33-block set

SPECIFICATIONS

2mm Base Block Sets

Blocks per set	Order No.		Standard / grade available and Suffix No.*				Blocks included in set		
	Steel	CERA	ISO/DIN/JIS	ASME	BS	Size	Step	Qty.	
112	516-532	—	—	K: -#6	—	2.0005	—	1	
	516-513	—	K: -#0	00: -#6	K: -#1	2.001 - 2.009	0.001	9	
	516-514	—	0: -#0	0: -#6	0: -#1	2.01 - 2.49	0.01	49	
	516-515	—	1: -#0	1: -#6	1: -#1	0.5 - 24.5	0.5	49	
	516-516	—	2: -#0	2: -#6	2: -#1	25 - 100	25	4	
88	—	—	—	—	—	1.0005	—	1	
	516-501	—	K: -#0	—	K: -#1	2.001 - 2.009	0.001	9	
	516-502	—	0: -#0	—	0: -#1	2.01 - 2.49	0.01	49	
	516-503	—	1: -#0	—	1: -#1	0.5 - 9.5	0.5	19	
	516-504	—	2: -#0	—	2: -#1	10 - 100	10	10	
88	516-534	—	—	K: -#6	—	2.0005	—	1	
	516-517	—	K: -#0	00: -#6	—	2.001 - 2.009	0.001	9	
	516-518	—	0: -#0	0: -#6	—	2.01 - 2.49	0.01	49	
	516-519	—	1: -#0	1: -#6	—	0.5 - 9.5	0.5	19	
	516-520	—	2: -#0	2: -#6	—	10 - 100	10	10	
47	516-538	—	—	K: -#6	—	2.0005	—	1	
	516-521	—	K: -#0	00: -#6	—	2.001 - 2.009	0.001	9	
	516-522	—	0: -#0	0: -#6	—	2.01 - 2.09	0.01	9	
	516-523	—	1: -#0	1: -#6	—	2.1 - 2.9	0.1	9	
	516-524	—	2: -#0	2: -#6	—	1 - 9	1	9	
46	—	—	—	—	—	2.001 - 2.009	0.001	9	
	516-505	—	K: -#0	—	K: -#1	2.01 - 2.09	0.01	9	
	516-506	—	0: -#0	—	0: -#1	2.1 - 2.9	0.1	9	
	516-507	—	1: -#0	—	1: -#1	1 - 9	1	9	
	516-508	—	2: -#0	—	2: -#1	10 - 100	10	10	
33	516-539	—	—	K: -#6	—	2.005	—	1	
	516-509	—	K: -#0	00: -#6	K: -#1	2.01 - 2.09	0.01	9	
	516-510	—	0: -#0	0: -#6	0: -#1	2.1 - 2.9	0.1	9	
	516-511	—	1: -#0	1: -#6	1: -#1	1 - 9	1	9	
	516-512	—	2: -#0	2: -#6	2: -#1	10 - 30	10	3	
					60, 100		2		

*Suffix No. (■) for Selecting Certificate Provided

ISO/DIN/JIS		
Suffix No.	Inspection Certificate	Calibration Certificate JCSS
1	○	—
6	○	○

Suffix No. 1: Not available for Grade K sets.

ASME		
Suffix No.	Inspection Certificate	Calibration Certificate JCSS
1	○	—
6	○	○

Suffix No. 1: Not available for Grade K sets.

Suffix No. 6: Only for Grade K sets.

BS		
Suffix No.	Inspection Certificate	Calibration Certificate JCSS
1	○	—
6	○	○

Suffix No. 1: Not available for Grade K sets.

Suffix No. 7: Only for Grade K sets.

Inspection Certificate

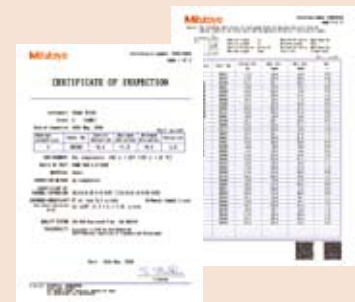

Metric Rectangular Gauge Block Sets

SERIES 516 — Thin Block Set, 0.001mm Step Block Sets

*Suffix No. (■) for Selecting Certificate Provided

ISO/DIN/JIS

Suffix No.	Inspection Certificate	Calibration Certificate
		JCSS
1	○	—
6	○	○

Suffix No. 1: Not available for Grade K sets.

BS

Suffix No.	Inspection Certificate	Calibration Certificate
		JCSS
1	○	—
6	○	○

Suffix No. 1: Not available for Grade K sets.
Suffix No. 7: Only for Grade K sets.

Inspection Certificate



Steel 9-block set

SPECIFICATIONS

Thin Block Sets

Blocks per set	Order No.		Standard / grade available and Suffix No.*			Blocks included in set		
	Steel	CERA	ISO/DIN/JIS	ASME	BS	Size	Step	Qty.
9	516-990	—	0: -■0	—	—	0.10 - 0.50	0.05	9
	516-991	—	1: -■0	—	—			
	516-992	—	2: -■0	—	—			

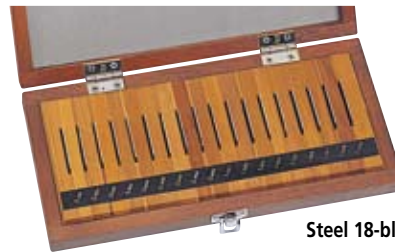

Steel 18-block set



CERA 18-block set



Steel 9-block set



CERA 9-block

SPECIFICATIONS

0.001mm Step Block Sets

Blocks per set	Order No.		Standard / grade available and Suffix No.*			Blocks included in set		
	Steel	CERA	ISO/DIN/JIS	ASME	BS	Size	Step	Qty.
18	516-973	516-373	K: -■0	—	—	0.991 - 0.999	0.001	9
	516-974	516-374	0: -■0	—	—			
	516-975	516-375	1: -■0	—	—	1.001 - 1.009	0.001	9
	516-976	516-376	2: -■0	—	—			
9	516-981	516-381	K: -■0	—	K: -■1	1.001 - 1.009	0.001	9
	516-982	516-382	0: -■0	—	0: -■1			
	516-983	516-383	1: -■0	—	1: -■1			
	516-984	516-384	2: -■0	—	2: -■1			
9	516-985	516-385	K: -■0	—	—	0.991 - 0.999	0.001	9
	516-986	516-386	0: -■0	—	—			
	516-987	516-387	1: -■0	—	—			
	516-988	516-388	2: -■0	—	—			

Metric Rectangular Gauge Block Sets

SERIES 516 — Long Block Sets, Wear Block Sets



CERA 8-block set



Steel 8-block set

SPECIFICATIONS

Long Block Sets

Blocks per set	Order No.		Standard / grade available and Suffix No.*			Blocks included in set		
	Steel	CERA	ISO/DIN/JIS	ASME	BS	Size	Step	Qty.
8	516-540	516-546	—	K: -#6	—	125 - 175	25	3
	516-701	516-731	K: -#0	00: -#6	—	200 - 250	50	2
	516-702	516-732	0: -#0	0: -#6	—	300 - 500	100	3
	516-703	516-733	1: -#0	1: -#6	—			
	516-704	516-734	2: -#0	2: -#6	—			



CERA 2-block set



Steel 2-block

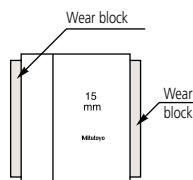

SPECIFICATIONS

Wear Block Sets

Blocks per set	Order No.		Standard / grade available and Suffix No.*			Blocks included in set		
	Carbide	CERA	ISO/DIN/JIS	ASME	BS	Size	Step	Qty.
2	516-807	516-832	0: -#0	0: -#6	—	1		2
	516-806	516-833	1: -#0	1: -#6	—			
2	516-803	516-830	0: -#0	0: -#6	—	2		2
	516-802	516-831	1: -#0	1: -#6	—			

*Suffix No. (■) for Selecting Certificate Provided

ISO/DIN/JIS		
Suffix No.	Inspection Certificate	Calibration Certificate JCSS
1	○	—
6	○	○

Suffix No. 1: Not available for Grade K sets.

ASME

ASME		
Suffix No.	Inspection Certificate	Calibration Certificate JCSS
1	○	—
6	○	○

Suffix No. 1: Not available for Grade K sets.

Suffix No. 6: Only for Grade K sets.

Inspection Certificate

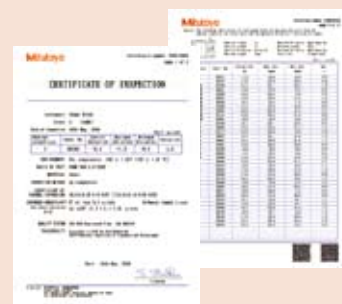

Inch Rectangular Gauge Block Sets

SERIES 516 — Inch Block Sets, Thin Block Sets, Long Block Sets, Wear Block Sets

*Suffix No. (■) for Selecting Certificate Provided

ASME

Suffix No.	Inspection Certificate	Calibration Certificate	
		JCSS	
1	○	—	—
6	○	○	○

Suffix No. 1: Not available for Grade K sets.
Suffix No. 6: Only for Grade K sets.

BS

Suffix No.	Inspection Certificate	Calibration Certificate	
		JCSS	
1	○	—	—
6	○	○	○

Suffix No. 1: Not available for Grade K sets.
Suffix No. 6: Only for Grade K sets.

Inspection Certificate



SPECIFICATIONS

Inch Block Sets

Blocks per set	Order No.		Standard / grade available and Suffix No.*			Blocks included in set		
	Steel (Steel/CERA)	CERA	ISO/DIN/JIS	ASME	BS	Size	Step	Qty.
82	516-548	516-556	—	K: -■6	—	.10005	—	1
	516-905	516-305	—	00: -■6	—	.1001 - .1009	.0001	9
	516-906	516-306	—	0: -■6	0: -■1	.101 - .149	.001	49
	516-907	516-307	—	1: -■6	1: -■1	.05 - .95	.05	19
	516-908	516-308	—	2: -■6	2: -■1	1 - 4	1	4
81	516-549	516-557	—	K: -■6	—	.1001 - .1009	.0001	9
	516-901	516-301	—	00: -■6	—	.101 - .149	.001	49
	516-902 (516-902)	516-302	—	0: -■6 (-■7)	0: -■1 (-■5)	.05 - .95	.05	19
	516-903 (516-903)	516-303	—	1: -■6 (-■7)	1: -■1 (-■5)	1 - 4	1	4
	516-904 (516-904)	516-304	—	2: -■6 (-■7)	2: -■1 (-■5)	—	—	—
49	—	—	—	—	—	.1001 - .1009	.0001	9
	—	—	—	—	—	.101 - .109	.001	9
	516-910 (516-910N)	—	—	—	0: -■1 (-■5)	.01 - .19	.01	19
	516-911 (516-911N)	—	—	—	1: -■1 (-■5)	.2 - .9	.1	8
	516-912 (516-912N)	—	—	—	2: -■1 (-■5)	1 - 4	1	4
35	516-550	516-558	—	K: -■6	—	.10005	—	1
	516-913	516-313	—	00: -■6	—	.1001 - .1009	.0001	9
	516-914 (516-914N)	516-314	—	0: -■6 (-■7)	0: -■1 (-■5)	.101 - .109	.001	9
	516-915 (516-915N)	516-315	—	1: -■6 (-■7)	1: -■1 (-■5)	.11 - .19	.01	9
	516-916 (516-916N)	516-316	—	2: -■6 (-■7)	2: -■1 (-■5)	.1 - .3	.1	3
—	—	—	—	—	.5, 1, 2, 4	—	4	

(): CERA blocks are adopted for blocks of frequently-used sizes.
81-block set: .05, .1, .11, .12, .125, .13, .14, .15, .2, .25, .3, .4, .5, 1"
49-block set: .05, .1, .15, .2, .3, .5, 1, 2"
35-block set: .1, .15, .2, .3, .5, 1, 2"

SPECIFICATIONS

Thin Block Sets

Blocks per set	Order No.		Standard / grade available and Suffix No.*			Blocks included in set		
	Steel	CERA	ISO/DIN/JIS	ASME	BS	Size	Step	Qty.
28	516-551	—	—	K: -■6	—	.02005	—	1
	516-917	—	—	00: -■6	—	.0201 - .0209	.0001	9
	516-918	—	—	0: -■6	—	.021 - .029	.001	9
	516-919	—	—	1: -■6	—	.01 - .09	.01	9
	516-920	—	—	2: -■6	—	—	—	—
10	516-926	—	—	0: -■6	0: -■1	.005 - .050	.005	10
	516-927	—	—	1: -■6	1: -■1	—	—	—
	516-928	—	—	—	2: -■1	—	—	—

SPECIFICATIONS

Long Block Sets

Blocks per set	Order No.		Standard / grade available and Suffix No.*			Blocks included in set		
	Steel	CERA	ISO/DIN/JIS	ASME	BS	Size	Step	Qty.
8	—	516-564	—	K: -■6	—	5 - 7	1	3
	—	516-741	—	00: -■6	—	8, 10, 12	2	3
	516-712	516-742	—	0: -■6	—	16, 20	4	2
	516-713	516-743	—	1: -■6	—	—	—	—

SPECIFICATIONS

Wear Block Sets

Blocks per set	Order No.		Standard / grade available and Suffix No.*			Blocks included in set		
	Carbide	CERA	ISO/DIN/JIS	ASME	BS	Size	Step	Qty.
2	516-809	516-836	—	0: -■6	—	.05	—	2
	516-808	516-837	—	1: -■6	—	—	—	—
2	516-805	516-834	—	0: -■6	—	.1	—	2
	516-804	516-835	—	1: -■6	—	—	—	—

Micrometer Inspection Gauge Block Sets

SERIES 516

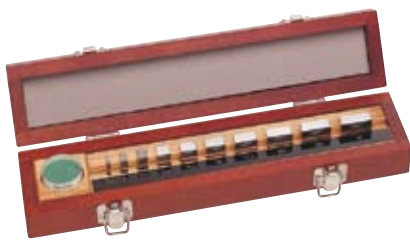

Steel 10-block set



Steel 10-block set



Steel 10-block set



Steel 8-block set



CERA 10-block set



CERA 10-block set



CERA 10-block set



CERA 8-block set

Micro Checker

- Can clamp a series of gauge blocks to be used for micrometer inspection.
- Can be used vertically and horizontally.
- Parallelism of micrometer measuring faces is checked by optical parallel which can be attached to the stand for convenience in handling.



SPECIFICATIONS

Metric <input type="checkbox"/> Micro Checker (holder only)	
Order No.	516-607
Applicable gauge block set	516-106, 516-107, 516-108, 516-156, 516-157, 516-158
Applicable gauge block size (mm)	2.5, 5.1, 7.7, 10.3, 12.9, 15, 17.6, 20.2, 22.8, 25
Inch/Metric <input type="checkbox"/> Micro Checker (holder only)	
Order No.	516-608
Applicable gauge block set	516-921, 516-922, 516-923, 516-321, 516-322, 516-323
Applicable gauge block size (inch)	.105, .210, .315, .420, .5, .605, .710, .815, .920, 1

***Suffix No. (■) for Selecting Certificate Provided**

ISO/DIN/JIS		
Suffix No.	Inspection Certificate	Calibration Certificate
1	○	—
6	○	○

Suffix No. 1: Not available for Grade K sets.

ASME		
Suffix No.	Inspection Certificate	Calibration Certificate
1	○	—
6	○	○

Suffix No. 1: Not available for Grade K sets.
Suffix No. 6: Only for Grade K sets.

BS		
Suffix No.	Inspection Certificate	Calibration Certificate
1	○	—

Inspection Certificate



***Suffix No. (■) for Selecting Certificate Provided**

ISO/DIN/JIS		
Suffix No.	Inspection Certificate	Calibration Certificate
1	○	—

SPECIFICATIONS

Metric Block Sets

Blocks per set	Order No.		Standard / grade available and Suffix No.*			Blocks included in set
	Steel	CERA	ISO/DIN/JIS	ASME	BS	
16	516-111	516-161	0: -■0	—	—	1.00, 1.25, 1.5, 2, 3, 5, 10, 15, 20, 25, 25.25, 30, 35, 40, 45, 50mm, Cerastone, Optical parallels (t = 12mm, 25mm)
	516-112	516-162	1: -■0	—	—	
	516-113	516-163	2: -■0	—	—	
10	516-977	—	K: -■0	—	—	1.00, 1.25, 1.50, 2, 3, 5, 10, 15, 20, 25mm, • Optical parallel (t = 12mm)
	516-978	516-378	0: -■0	—	—	
	516-979	516-379	1: -■0	—	—	
	516-980	516-380	2: -■0	—	—	
10	516-103	516-152	0: -■0	0: -■6	—	1.00, 1.25, 1.50, 2, 3, 5, 10, 15, 20, 25mm
	516-101	516-153	1: -■0	1: -■6	—	
	—	516-154	2: -■0	—	—	
10	516-106	516-156	0: -■0	—	—	2.5, 5.1, 7.7, 10.3, 12.9, 15, 17.6, 20.2, 22.8, 25mm, Optical parallel (t = 12mm)
	516-107	516-157	1: -■0	—	—	
	516-108	516-158	2: -■0	—	—	
10	516-132	516-182	0: -■0	—	—	1.25, 1.50, 1, 2, 3, 5, 10, 15, 20, 25mm, Micro Checker, Optical parallel (t = 12mm)
	516-133	516-183	1: -■0	—	—	
	516-134	516-184	2: -■0	—	—	
10	516-135	516-185	0: -■0	—	—	2.5, 5.1, 7.7, 10.3, 12.9, 15, 17.6, 20.2, 22.8, 25mm, Micro Checker, Optical parallel (t = 12mm)
	516-136	516-186	1: -■0	—	—	
	516-137	516-187	2: -■0	—	—	
	—	516-547	—	K: -■6	—	
8	—	516-164	K: -■0	00: -■6	—	25, 50, 75, 100, 125, 150, 175, 200mm
	516-115	516-165	0: -■0	0: -■6	—	
	516-116	516-166	1: -■0	1: -■6	—	
	516-117	516-167	2: -■0	2: -■6	—	

Inch Block Sets

Blocks per set	Order No.		Standard / grade available and Suffix No.*			Blocks included in set
	Steel	CERA	ISO/DIN/JIS	ASME	BS	
10	516-552	516-559	—	K: -■6	—	.105, .210, .315, .420, .500, .605, .710, .815, .920, 1", Optical parallel (t = .5")
	516-921	516-321	—	00: -■6	0: -■1	
	516-922	516-322	—	0: -■6	1: -■1	
	516-923	516-323	—	1: -■6	2: -■1	
10	516-553	516-560	—	K: -■6	—	.105, .210, .315, .420, .500, .605, .710, .815, .920, 1", Micro checker, Optical parallel (t = .5")
	516-138	516-188	—	00: -■6	0: -■1	
	516-139	516-189	—	0: -■6	1: -■1	
	516-140	516-190	—	1: -■6	2: -■1	
9	516-554	516-561	—	K: -■6	—	.0625, .100, .125, .200, .250, .300, .500, 1, 2", Optical parallel (t = .5")
	516-929	516-333	—	00: -■6	—	
	516-930	516-334	—	0: -■6	—	
	516-931	516-335	—	1: -■6	—	
	516-932	516-336	—	2: -■6	—	
9	516-555	516-562	—	K: -■6	—	.0625, .100, .125, .200, .250, .300, .500, 1, 2", Micro Checker, Optical parallel (t = .5")
	516-141	516-191	—	00: -■6	—	
	516-142	516-192	—	0: -■6	—	
	516-143	516-193	—	1: -■6	—	
	516-144	516-194	—	2: -■6	—	
9	—	516-563	—	K: -■6	—	.0625, .100, .125, .200, .250, .300, .500, 1, 2"
	—	516-329	—	00: -■6	—	
	516-934	516-330	—	0: -■6	—	
	516-935	516-331	—	1: -■6	—	
	516-936	516-332	—	2: -■6	—	
8	516-126	516-176	—	0: -■6	—	1, 2, 3, 4, 5, 6, 7, 8"
	516-127	516-177	—	1: -■6	—	

Caliper Inspection Gauge Block Sets

SERIES 516

SPECIFICATIONS

Metric Block Sets

Blocks per set	Order No.		Standard / grade available and Suffix No.*			Blocks included in set
	Steel	CERA	ISO/DIN/JIS	ASME	BS	
5	—	516-174	—	—	—	5 pcs.: 10.3, 24.5, 50, 75, 100mm, Ceramic plain jaws, Holder (250mm), Glove
4	516-526	516-566	1: -■0	—	—	4 pcs.: 10, 30, 50, 125mm, Setting ring (ø4mm, ø10mm), Pin gage (ø10mm), Glove
	516-527	516-567	2: -■0	—	—	
3	516-124	516-150	1: -■0	—	—	3 pcs.: 30, 41.3, 131.4mm, Setting ring (ø4mm, ø25mm), Glove
	516-125	516-151	2: -■0	—	—	
2	516-122	516-172	1: -■0	—	—	2 pcs.: 41.3, 131.4mm, Setting ring (ø20mm), Glove
	516-123	516-173	2: -■0	—	—	

Individual Metric Rectangular Gauge Blocks

FEATURES

- If using only one length repeatedly, it is a good idea to purchase discrete gauge blocks.
- Each gauge block is supplied with a Certificate of Inspection.
- Each Grade K gauge block to ISO/DIN/JIS, BS or ASME standard is supplied with a Certificate of Calibration which certifies that the gauge block was calibrated by interferometry.



SPECIFICATIONS

Metric Blocks			Metric Blocks			Metric Blocks		
Length (mm)	Order No.*		Length (mm)	Order No.*		Length (mm)	Order No.*	
	Steel	CERA		Steel	CERA		Steel	CERA
0.1	611821	—	0.53	611894	—	0.96	611937	—
0.11	611860	—	0.54	611895	—	0.97	611938	—
0.12	611861	—	0.55	611896	—	0.98	611939	—
0.13	611862	—	0.56	611897	—	0.99	611940	—
0.14	611863	—	0.57	611898	—	0.991	611551	613551
0.15	611822	—	0.58	611899	—	0.992	611552	613552
0.16	611864	—	0.59	611900	—	0.993	611553	613553
0.17	611865	—	0.6	611901	—	0.994	611554	613554
0.18	611866	—	0.61	611902	—	0.995	611555	613555
0.19	611867	—	0.62	611903	—	0.996	611556	613556
0.2	611823	—	0.63	611904	—	0.997	611557	613557
0.21	611868	—	0.64	611905	—	0.998	611558	613558
0.22	611869	—	0.65	611906	—	0.999	611559	613559
0.23	611870	—	0.66	611907	—	1	611611	613611
0.24	611871	—	0.67	611908	—	1.0005	611520	613520
0.25	611824	—	0.68	611909	—	1.001	611521	613521
0.26	611872	—	0.69	611910	—	1.002	611522	613522
0.27	611873	—	0.7	611911	—	1.003	611523	613523
0.28	611874	—	0.71	611912	—	1.004	611524	613524
0.29	611875	—	0.72	611913	—	1.005	611525	613525
0.3	611825	—	0.73	611914	—	1.006	611526	613526
0.31	611876	—	0.74	611915	—	1.007	611527	613527
0.32	611877	—	0.75	611916	—	1.008	611528	613528
0.33	611878	—	0.76	611917	—	1.009	611529	613529
0.34	611879	—	0.77	611918	—	1.01	611561	613561
0.35	611826	—	0.78	611919	—	1.02	611562	613562
0.36	611880	—	0.79	611920	—	1.03	611563	613563
0.37	611881	—	0.8	611921	—	1.04	611564	613564
0.38	611882	—	0.81	611922	—	1.05	611565	613565
0.39	611883	—	0.82	611923	—	1.06	611566	613566
0.4	611827	—	0.83	611924	—	1.07	611567	613567
0.41	611884	—	0.84	611925	—	1.08	611568	613568
0.42	611885	—	0.85	611926	—	1.09	611569	613569
0.43	611886	—	0.86	611927	—	1.1	611570	613570
0.44	611887	—	0.87	611928	—	1.11	611571	613571
0.45	611828	—	0.88	611929	—	1.12	611572	613572
0.46	611888	—	0.89	611930	—	1.13	611573	613573
0.47	611889	—	0.9	611931	—	1.14	611574	613574
0.48	611890	—	0.91	611932	—	1.15	611575	613575
0.49	611891	—	0.92	611933	—	1.16	611576	613576
0.5	611506	613506	0.93	611934	—	1.17	611577	613577
0.51	611892	—	0.94	611935	—	1.18	611578	613578
0.52	611893	—	0.95	611936	—	1.19	611579	613579

*Suffix Number (- ■■■) for Selecting Standard and Certificate Provided

ISO/DIN/JIS				
Suffix No.	Grade	Inspection Certificate	Calibration Certificate	
			JCSS	RvA
-016	K	○	○	—
-021	0	○	—	—
-026	0	○	○	—
-031	1	○	—	—
-036	1	○	○	—
-041	2	○	—	—
-046	2	○	○	—

ASME			
Suffix No.	Grade	Inspection Certificate	Calibration Certificate
			JCSS
-516	K	○	○
-521	00	○	—
-531	0	○	—
-541	1	○	—
-551	2	○	—

BS			
Suffix No.	Grade	Inspection Certificate	Calibration Certificate
			JCSS
-116	K	○	○
-121	0	○	—
-126	0	○	○
-131	1	○	—
-136	1	○	○
-141	2	○	—
-146	2	○	○



Inspection Certificate

Dimensions

Unit: mm

Nominal length:
0.1mm - 5.5mm
(.004" - .25")

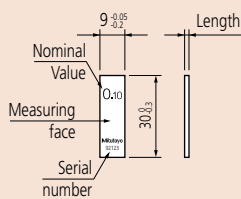

Nominal length:
6mm - 10mm
(.3" - .4")

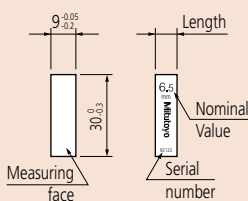

Nominal length:
10.3mm - 100mm
(.45" - 4")

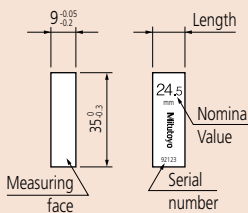

Nominal length 125mm - 1000mm (5" - 20")

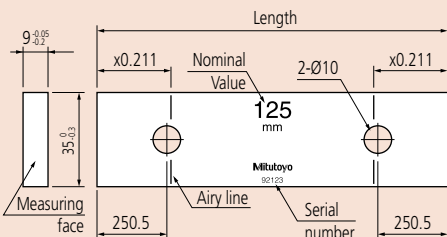

Length (mm)	Order No.*	
	Steel	CERA
1.2	611580	613580
1.21	611581	613581
1.22	611582	613582
1.23	611583	613583
1.24	611584	613584
1.25	611585	613585
1.26	611586	613586
1.27	611587	613587
1.28	611588	613588
1.29	611589	613589
1.3	611590	613590
1.31	611591	613591
1.32	611592	613592
1.33	611593	613593
1.34	611594	613594
1.35	611595	613595
1.36	611596	613596
1.37	611597	613597
1.38	611598	613598
1.39	611599	613599
1.4	611600	613600
1.41	611601	613601
1.42	611602	613602
1.43	611603	613603
1.44	611604	613604
1.45	611605	613605
1.46	611606	613606
1.47	611607	613607
1.48	611608	613608
1.49	611609	613609
1.5	611641	613641
1.6	611516	613516
1.7	611517	613517
1.8	611518	613518
1.9	611519	613519
2	611612	613612
2.0005	611690	—
2.001	611691	—
2.002	611692	—
2.003	611693	—
2.004	611694	—
2.005	611695	—
2.006	611696	—
2.007	611697	—
2.008	611698	—
2.009	611699	—
2.01	611701	—
2.02	611702	—
2.03	611703	—
2.04	611704	—
2.05	611705	—
2.06	611706	—
2.07	611707	—
2.08	611708	—
2.09	611709	—
2.1	611710	—
2.11	611711	—
2.12	611712	—
2.13	611713	—
2.14	611714	—
2.15	611715	—
2.16	611716	—

Length (mm)	Order No.*	
	Steel	CERA
2.17	611717	—
2.18	611718	—
2.19	611719	—
2.2	611720	—
2.21	611721	—
2.22	611722	—
2.23	611723	—
2.24	611724	—
2.25	611725	—
2.26	611726	—
2.27	611727	—
2.28	611728	—
2.29	611729	—
2.3	611730	—
2.31	611731	—
2.32	611732	—
2.33	611733	—
2.34	611734	—
2.35	611735	—
2.36	611736	—
2.37	611737	—
2.38	611738	—
2.39	611739	—
2.4	611740	—
2.41	611741	—
2.42	611742	—
2.43	611743	—
2.44	611744	—
2.45	611745	—
2.46	611746	—
2.47	611747	—
2.48	611748	—
2.49	611749	—
2.5	611642	613642
2.6	611750	—
2.7	611751	—
2.8	611752	—
2.9	611753	—
3	611613	613613
3.5	611643	613643
4	611614	613614
4.5	611644	613644
5	611615	613615
5.1	611850	613850
5.5	611645	613645
6	611616	613616
6.5	611646	613646
7	611617	613617
7.5	611647	613647
7.7	611851	613851
8	611618	613618
8.5	611648	613648
9	611619	613619
9.5	611649	613649
10	611671	613671
10.3	611852	613852
10.5	611650	613650
11	611621	613621
11.5	611651	613651
12	611622	613622
12.5	611652	613652
12.9	611853	613853

Length (mm)	Order No.*	
	Steel	CERA
13	611623	613623
13.5	611653	613653
14	611624	613624
14.5	611654	613654
15	611625	613625
15.5	611655	613655
16	611626	613626
16.5	611656	613656
17	611627	613627
17.5	611657	613657
17.6	611854	613854
18	611628	613628
18.5	611658	613658
19	611629	613629
19.5	611659	613659
20	611672	613672
20.2	611855	613855
20.5	611660	613660
21	611631	613631
21.5	611661	613661
22	611632	613632
22.5	611662	613662
22.8	611856	613856
23	611633	613633
23.5	611663	613663
24	611634	613634
24.5	611664	613664
25	611635	613635
25.25	611754	613754
30	611673	613673
35	611755	613755
40	611674	613674
41.3	611857	613857
45	611756	613756
50	611675	613675
60	611676	613676
70	611677	613677
75	611801	613801
80	611678	613678
90	611679	613679
100	611681	613681
125	611802	613802
131.4	611858	613858
150	611803	613803
175	611804	613804
200	611682	613682
250	611805	613805
300	611683	613683
400	611684	613684
500	611685	613685
600	611840	—
700	611841	—
750	611842	—
800	611843	—
900	611844	—
1000	611845	—

Metric Wear Blocks

Length (mm)	Order No.* Tungsten carbide
1	612611
2	612612

Individual Inch Rectangular Gauge Blocks

SPECIFICATIONS

Inch Block			Inch Block			Inch Block		
Length (inch)	Order No.*		Length (inch)	Order No.*		Length (inch)	Order No.*	
	Steel	CERA		Steel	CERA		Steel	CERA
.004	611304	—	.06	611106	—	.139	611179	613179
.005	611305	—	.0625	611303	613303	.14	611180	613180
.006	611306	—	.07	611107	—	.141	611181	613181
.007	611307	—	.078125 (5/64)	611103	613100	.142	611182	613182
.008	611308	—	.08	611108	—	.143	611183	613183
.009	611309	—	.09	611109	—	.144	611184	613184
.01	611310	—	.09375 (3/32)	611104	613101	.145	611185	613185
.011	611311	—	.1	611191	613191	.146	611186	613186
.012	611312	—	.100025	611111	613110	.147	611187	613187
.013	611313	—	.10005	611135	613135	.148	611188	613188
.014	611314	—	.100075	611112	613111	.149	611189	613189
.015	611315	—	.1001	611121	613121	.15	611115	613115
.016	611316	—	.1002	611122	613122	.16	611116	613116
.017	611317	—	.1003	611123	613123	.17	611117	613117
.018	611318	—	.1004	611124	613124	.18	611118	613118
.019	611319	—	.1005	611125	613125	.19	611119	613119
.02	611320	—	.1006	611126	613126	.2	611192	613192
.02005	611240	—	.1007	611127	613127	.21	611221	613221
.0201	611231	—	.1008	611128	613128	.25	611212	613212
.0202	611232	—	.1009	611129	613129	.3	611193	613193
.0203	611233	—	.101	611141	613141	.315	611209	613209
.0204	611234	—	.102	611142	613142	.35	611213	613213
.0205	611235	—	.103	611143	613143	.375 (3/8)	611113	613112
.0206	611236	—	.104	611144	613144	.4	611194	613194
.0207	611237	—	.105	611145	613145	.420	611210	613210
.0208	611238	—	.106	611146	613146	.45	611214	613214
.0209	611239	—	.107	611147	613147	.5	611195	613195
.021	611321	—	.108	611148	613148	.55	611215	613215
.022	611322	—	.109	611149	613149	.6	611196	613196
.023	611323	—	.109375 (7/64)	611110	613102	.605	611211	613211
.024	611324	—	.11	611150	613150	.65	611216	613216
.025	611325	—	.111	611151	613151	.7	611197	613197
.026	611326	—	.112	611152	613152	.710	611220	613220
.027	611327	—	.113	611153	613153	.75	611217	613217
.028	611328	—	.114	611154	613154	.8	611198	613198
.029	611329	—	.115	611155	613155	.815	611226	613226
.03	611330	—	.116	611156	613156	.85	611218	613218
.031	611331	—	.117	611157	613157	.9	611199	613199
.03125 (1/32)	611101	613103	.118	611158	613158	.920	611227	613227
.032	611332	—	.119	611159	613159	.95	611219	613219
.033	611333	—	.12	611160	613160	1	611201	613201
.034	611334	—	.121	611161	613161	2	611202	613202
.035	611335	—	.122	611162	613162	3	611203	613203
.036	611336	—	.123	611163	613163	4	611204	613204
.037	611337	—	.124	611164	613164	5	611205	613205
.038	611338	—	.125	611165	613165	6	611206	613206
.039	611339	—	.126	611166	613166	7	611207	613207
.04	611340	—	.127	611167	613167	8	611208	613208
.041	611341	—	.128	611168	613168	10	611222	613222
.042	611342	—	.129	611169	613169	12	611223	613223
.043	611343	—	.13	611170	613170	16	611224	613224
.044	611344	—	.131	611171	613171	20	611225	613225
.045	611345	—	.132	611172	613172			
.046	611346	—	.133	611173	613173			
.046875 (3/64)	611102	613104	.134	611174	613174			
.047	611347	—	.135	611175	613175			
.048	611348	—	.136	611176	613176			
.049	611349	—	.137	611177	613177			
.05	611105	613105	.138	611178	613178			

Inch Wear Blocks	
Length (inch)	Order No.* Tungsten carbide
.05	612105
.1	612191

*Suffix Number (-■■■) for Selecting Standard and Certificate Provided

ASME			
Suffix No.	Grade	Inspection Certificate	Calibration Certificate JCSS
-516	K	○	○
-521	00	○	—
-531	0	○	—
-541	1	○	—
-551	2	○	—

BS			
Suffix No.	Grade	Inspection Certificate	Calibration Certificate JCSS
-121	0	○	—
-131	1	○	—
-141	2	○	—



Inspection Certificate

Dimensions

Unit: mm

Nominal length:
0.1mm - 5.5mm
(.004" - .25")

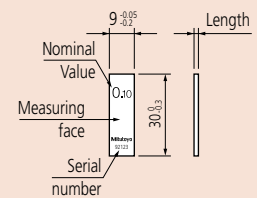

Nominal length:
6mm - 10mm
(.3" - .4")

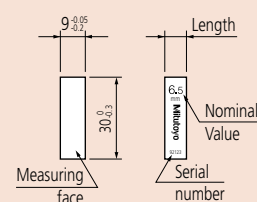

Nominal length:
10.3mm - 100mm
(.45" - 4")

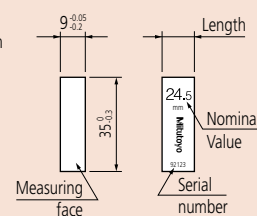

Nominal length 125mm - 1000mm (5" - 20")

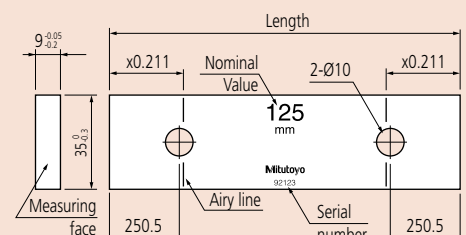

Rectangular Gauge Blocks with CTE

Gauge Blocks with a Calibrated Coefficient of Thermal Expansion

*Suffix Number (-■■■) for Selecting Standard and Certificate Provided

ISO/DIN/JIS			
Suffix No.	Grade	Inspection Certificate	Calibration Certificate
-01B	K	○	○

ASME			
Suffix No.	Grade	Inspection Certificate	Calibration Certificate
-51B	K	○	○

BS			
Suffix No.	Grade	Inspection Certificate	Calibration Certificate
-11B	K	○	○

*Only for 100mm type



Inspection Certificate

FEATURES

- Mitutoyo offers top-level gauge blocks (steel and ceramic) which are superior to K class blocks, with their quality supported by Mitutoyo's best technologies.
- Features an accurately calibrated thermal expansion coefficient measured with a proprietary double-faced interferometer (DFI).
- Each gauge block is calibrated for length on a highly accurate gauge block interferometer (GBI) system.
- Mitutoyo offers rectangular gauge blocks, having nominal values from 100 to 500mm
Grade: K class in JIS/ASME/ISO
Uncertainty of thermal expansion coefficient: $0.035 \times 10^{-6}/K$ ($k = 2$)
Uncertainty of length measurement: 30nm ($k = 2$), for 100mm block



SPECIFICATIONS

Metric Blocks with CTE		
Length (mm)	Order No. (steel)*	Order No. (CERA)*
100	611681	613681
125	611802	613802
150	611803	613803
175	611804	613804
200	611682	613682
250	611805	613805
300	611683	613683
400	611684	613684
500	611685	613685

Inch Blocks with CTE		
Length (inch)	Order No. (steel)*	Order No. (CERA)*
4	611204	613204
5	611205	613205
6	611206	613206
7	611207	613207
8	611208	613208
10	611222	613222
12	611223	613223
16	611224	613224
20	611225	613225

Technical Data

- Appearance: Rectangular black
 Material: Ultra-low thermal expansion fine ceramic
 Standards: JIS/ISO/DIN, BS, and ASME
 Grade¹: K
 Coefficient of thermal expansion²: $0 \pm 0.02 \times 10^{-6}/K$ (at 20°C)
 Density²: 2.5 g/cm³
 Vickers hardness²: 826HV10 (by JIS R 1610 "Testing Method for Vickers Hardness of High Performance Ceramics")
 Standard accessories: Inspection certificate, Calibration certificate, and custom-made aluminum case
 *1: If you require a grade other than K, please contact Mitutoyo.
 *2: Value claimed by the material supplier



ZERO CERA Blocks

Ultra-low Expansion Ceramic Gauge Blocks

FEATURES

- Thermal expansion at 20±1°C less than 1/500 that of steel
- Almost no secular change both in dimension and coefficient of thermal expansion
- Complementary ultra-low thermal expansion and high specific rigidity (Young's modulus/specific gravity)



SPECIFICATIONS

Metric Blocks with CTE			
Length (mm)	Order No.		
	JIS/ISO/DIN	BS	ASME
30	617673-016	617673-116	617673-516
50	617675-016	617675-116	617675-516
100	617681-016	617681-116	617681-516
200	617682-016	617682-116	617682-516
300	617683-016	617683-116	617683-516
400	617684-016	617684-116	617684-516
500	617685-016	617685-116	617685-516
600	617840-016	617840-116	617840-516
700	617841-016	617841-116	617841-516
800	617843-016	617843-116	617843-516
900	617844-016	617844-116	617844-516
1000	617845-016	617845-116	617845-516
Above set	516-771-60	516-771-61	516-771-66

Rectangular Gauge Block Accessories

SERIES 516

To expand the range of rectangular gauge block (steel and CERA) applications, Mitutoyo offers the gauge block accessories set. By assembling the items in the set, you can easily and quickly build up a precision measuring instrument.

SPECIFICATIONS

Order No. 516-601	Order No. 516-602	Included in set
—	1 pc.	Holder 15 - 60mm (619002)
1 pc.	1 pc.	Holder 5 - 100mm (619003)
1 pc.	1 pc.	Holder 15 - 160mm (619004)
1 pc.	1 pc.	Holder 20 - 250mm (619005)
1 pc.	1 pc.	Holder base 35mm (619009)
2 pcs.	2 pcs.	Half round jaw 2mm (619010)
2 pcs.	2 pcs.	Half round jaw 5mm (619011)
2 pcs.	2 pcs.	Half round jaw 8mm (619012)
2 pcs.	—	Half round jaw 12mm (619013)
2 pcs.	—	Half round jaw 20mm (619014)
2 pcs.	—	Plain jaw (619018)
1 pc.	1 pc.	Scriber point (619019)
1 pc.	1 pc.	Center point (619020)
2 pcs.	—	Tram point (619021)
1 pc.	1 pc.	Triangular straight edge 100mm (619022)
1 pc.	—	Triangular straight edge 160mm (619023)



516-601



516-602

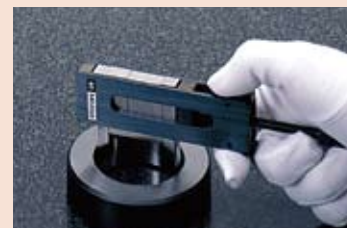

Holder base 35mm: **619009**
Establishes a height from the surface plate and scribes a workpiece if used with a holder.

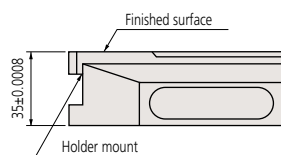

Holder:
Used as a clamp if using plain jaws, scriber point, etc.

Order No.	L
619002	15 - 60mm
619003	5 - 100mm
619004	15 - 160mm
619005	20 - 250mm

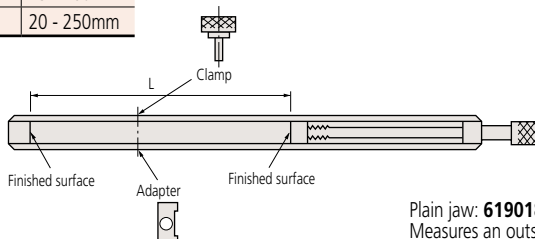
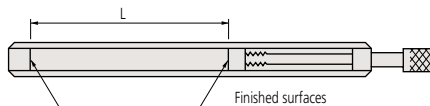

Plain jaw: **619018**
Measures an outside or inside diameter if used as a pair of jaws in the holder.

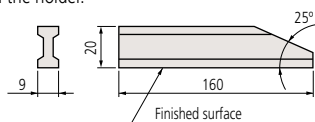

Scriber point: **619019**
Scribes a workpiece if used in a holder and holder base.

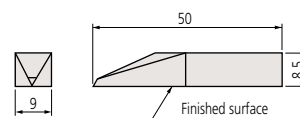

Half round jaw:
Measures an outside or inside diameter if used as a pair of jaws in the holder.

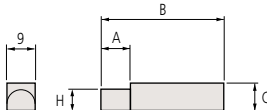
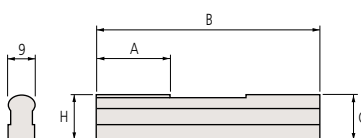

Unit: mm

Size	Order No.	H	A	B	C
2	619010	2±0.0005	5.5	40	7.5
5	619011	5±0.0005	14	45	7.5
8	619012	8±0.0005	18.5	50	8.5
12	619013	12±0.0005	25	75	13
20	619014	20±0.0005	25	125	20.5

Center point: **619020**
Scribes a workpiece if used in a holder and holder base.

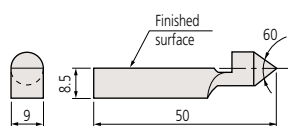

Tram point: **619021**
Inspects the scale of the height gage, etc., if used in a holder and holder base.

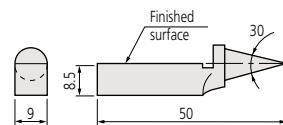

Triangular straight edge: Measures parallelism.

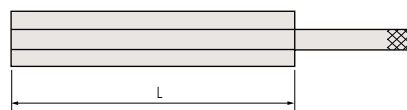
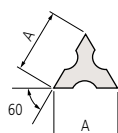

Order No.	L	A
619022	100mm	16mm
619023	160mm	19.5mm

Specially designed for long gauge blocks over 100mm which have two coupling holes on the body.



516-605

SPECIFICATIONS

Accessories for gauge blocks over 100mm

Order No. 516-605	Included in set
1 pc.	Holder A (619031)
1 pc.	Holder B (619032)
1 pc.	Holder C (619033)
1 pc.	Holder D (619034)
1 pc.	Holder E (619035)
3 pcs.	Adaptor (619036)
1 pc.	Holder base 35mm (619009)
2 pcs.	Half round jaw 12mm (619013)
2 pcs.	Plain jaw (619018)
1 pc.	Scriber point (619019)

Note: These accessories can also be used for inch rectangular gauge blocks.

Holder A: 619031

Used for coupling two long gauge blocks.

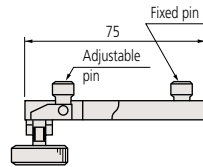

Holder B and C:

Used for coupling two long gauge blocks together with other gauge blocks up to 35mm (Holder B) or 140mm (Holder C). Also used for attaching jaws with two adaptors.

	Order No.	R (max.)	L
Holder B	619032	90mm	126mm
Holder C	619033	200mm	236mm

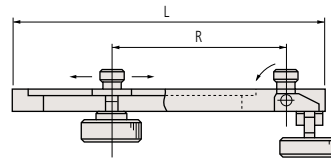

Adaptor: 619036



Holder D: 619034

Used for attaching to the holder base.

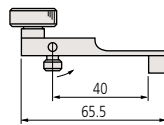

Holder E: 619035

Used for attaching to the holder base together with other gauge blocks up to 125mm. Used for attaching jaws with one adaptor.

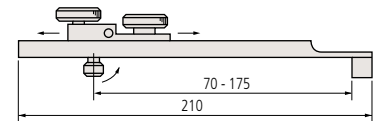

Holder base: 619009

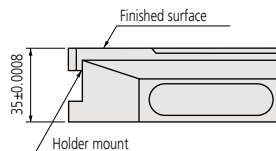

Half round jaw: 619013

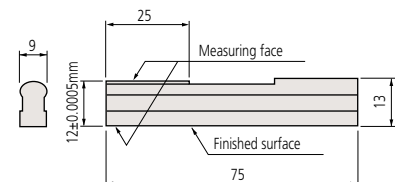

Plain jaw: 619018

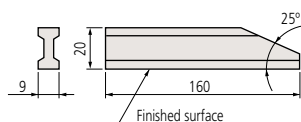

Scriber point: 619019

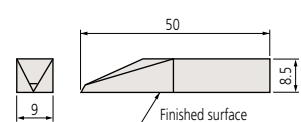

Metric Square Gauge Block Sets

SERIES 516 — Metric Block Sets, Long Block Sets, Wear Block Sets

The Square Gauge Block style provides the best stability, especially for surface plate work. A wide range of application measurements can be made, including cutting tool positioning, angle measurement with a sine bar, taper measurement with a roller, and inspection of depth micrometers.



Steel 112-block set



Steel 103-block set



Steel 76-block set

SPECIFICATIONS

Metric Block Sets							
Blocks per set	Order No.		Standard / grade available		Blocks included in set		
	Steel	CERA	ISO/DIN/JIS	ASME	Size	Step	Qty.
112	516-437	—	—	00: -H6	1.005	—	1
	516-438	—	0: -H0	0: -H6	1.001 - 1.009	0.001	9
	516-439	—	1: -H0	1: -H6	1.01 - 1.49	0.01	49
	516-440	—	2: -H0	2: -H6	0.5 - 24.5	0.5	49
	—	—	—	—	25 - 100	25	4
103	516-441	—	—	00: -H6	1.005	—	1
	516-442	—	0: -H0	0: -H6	1.01 - 1.49	0.01	49
	516-443	—	1: -H0	1: -H6	0.5 - 24.5	0.5	49
	516-444	—	2: -H0	2: -H6	0.5 - 24.5	0.5	49
	—	—	—	—	25 - 100	25	4
76	516-449	—	—	00: -H6	1.005	—	1
	516-450	—	0: -H0	0: -H6	1.01 - 1.49	0.01	49
	516-451	—	1: -H0	1: -H6	0.5 - 9.5	0.5	19
	516-452	—	2: -H0	2: -H6	10 - 40	10	4
	—	—	—	—	50 - 100	25	3
47	516-457	—	—	00: -H6	1.005	—	1
	516-458	—	0: -H0	0: -H6	1.01 - 1.09	0.01	9
	516-459	—	1: -H0	1: -H6	1.1 - 1.9	0.1	9
	516-460	—	2: -H0	2: -H6	1 - 24	1	24
	—	—	—	—	25 - 100	25	4
32	516-465	—	—	00: -H6	1.005	—	1
	516-466	—	0: -H0	0: -H6	1.01 - 1.09	0.01	9
	516-467	—	1: -H0	1: -H6	1.1 - 1.9	0.1	9
	516-468	—	2: -H0	2: -H6	1 - 9	1	9
	—	—	—	—	10 - 30	10	3
—	—	—	—	60	—	1	

Metric Long Block Sets							
Blocks per set	Order No.		Standard / grade available		Blocks included in set		
	Steel	CERA	ISO/DIN/JIS	ASME	Size	Step	Qty.
8	516-751	—	—	00: -H6	125, 150, 175	25	3
	516-752	—	0: -H0	0: -H6	200, 250	50	2
	516-753	—	1: -H0	1: -H6	300, 400, 500	100	3
	516-754	—	2: -H0	2: -H6	—	—	—
	—	—	—	—	—	—	—

Metric Wear Block Sets							
Blocks per set	Order No.		Standard / grade available		Blocks included in set		
	Steel	CERA	ISO/DIN/JIS	ASME	Size	Step	Qty.
2	516-820	—	0: -H0	—	1	—	2
	516-821	—	1: -H0	—	—	—	—
2	516-822	—	0: -H0	—	2	—	2
	516-823	—	1: -H0	—	—	—	—

*Suffix No. (■) for Selecting Certificate Provided

ISO/DIN/JIS		
Suffix No.	Inspection Certificate	Calibration Certificate JCSS
1	○	—
6	○	○

ASME		
Suffix No.	Inspection Certificate	Calibration Certificate JCSS
1	○	—

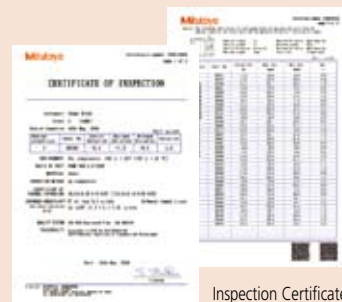

Inspection Certificate

Inch Square Gauge Block Sets

SERIES 516 — Inch Block Sets, Long Block Sets, Wear Block Sets

*Suffix No. (■) for Selecting Certificate Provided

ISO/DIN/JIS		
Suffix No.	Inspection Certificate	Calibration Certificate
1	○	—
6	○	○

ASME		
Suffix No.	Inspection Certificate	Calibration Certificate
1	○	—

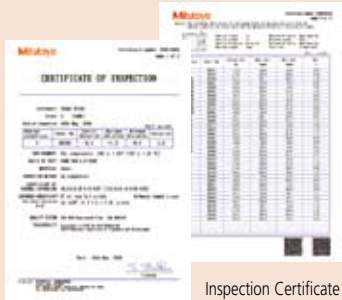

Inspection Certificate

SPECIFICATIONS

Inch Block Sets

Blocks per set	Order No.		Standard / grade available		Blocks included in set		
	Steel	CERA	ISO/DIN/JIS	ASME	Size	Step	Qty.
81	516-401	516-201	—	00: -#6	.1001 - .1009	.0001	9
	516-402	516-202	—	0: -#6	.101 - .149	.001	49
	516-403	516-203	—	1: -#6	.05 - .95	.05	19
	516-404	516-204	—	2: -#6	1 - 4	1	4
36	516-421	516-221	—	00: -#6	.05"	—	1
	516-422	516-222	—	0: -#6	.1001 - .1009	.0001	9
	516-423	516-223	—	1: -#6	.101 - .109	.001	9
	516-424	516-224	—	2: -#6	.11 - .19	.01	9
	—	—	—	—	.1 - .5	.1	5
	—	—	—	—	1, 2, 4	1	3
28	516-417	—	—	00: -#6	.02005	—	1
	516-418	—	—	0: -#6	.0201-.0209	.0001	9
	516-419	—	—	1: -#6	.021-.029	.001	9
	516-420	—	—	2: -#6	.010-.090	.01	9
	—	—	—	—	—	—	—

Inch Long Block Sets

Blocks per set	Order No.		Standard / grade available		Blocks included in set		
	Steel	CERA	ISO/DIN/JIS	ASME	Size	Step	Qty.
8	516-762	—	—	Grade 0	5 - 7	1	3
	516-763	—	—	Grade 1	8, 10, 12	2	3
	—	—	—	—	16, 20	4	2

Inch Wear Block Sets

Blocks per set	Order No.		Standard / grade available		Blocks included in set		
	Carbide	CERA	ISO/DIN/JIS	ASME	Size	Step	Qty.
2	516-824	516-846	0: -#0	—	.05	—	2
	516-825	516-847	1: -#0	—	—	—	—
2	516-826	516-844	0: -#0	—	.1	—	2
	516-827	516-845	1: -#0	—	—	—	—



Steel 47-block set



Steel 32-block set



Steel 8-block set



Steel 2-block set

Individual Metric Square Gauge Block



SPECIFICATIONS

Metric Blocks

Length (mm)	Order No.*		Length (mm)	Order No.*		Length (mm)	Order No.*	
	Steel	CERA		Steel	CERA		Steel	CERA
0.5	614506	—	1.33	614593	—	13	614623	—
1	614611	—	1.34	614594	—	13.5	614653	—
1.0005	614520	—	1.35	614595	—	14	614624	—
1.001	614521	—	1.36	614596	—	14.5	614654	—
1.002	614522	—	1.37	614597	—	15	614625	—
1.003	614523	—	1.38	614598	—	15.5	614655	—
1.004	614524	—	1.39	614599	—	16	614626	—
1.005	614525	—	1.4	614600	—	16.5	614656	—
1.006	614526	—	1.41	614601	—	17	614627	—
1.007	614527	—	1.42	614602	—	17.5	614657	—
1.008	614528	—	1.43	614603	—	18	614628	—
1.009	614529	—	1.44	614604	—	18.5	614658	—
1.01	614561	—	1.45	614605	—	19	614629	—
1.02	614562	—	1.46	614606	—	19.5	614659	—
1.03	614563	—	1.47	614607	—	20	614672	—
1.04	614564	—	1.48	614608	—	20.5	614660	—
1.05	614565	—	1.49	614609	—	21	614631	—
1.06	614566	—	1.5	614641	—	21.5	614661	—
1.07	614567	—	1.6	614516	—	22	614632	—
1.08	614568	—	1.7	614517	—	22.5	614662	—
1.09	614569	—	1.8	614518	—	23	614633	—
1.1	614570	—	1.9	614519	—	23.5	614663	—
1.11	614571	—	2	614612	—	24	614634	—
1.12	614572	—	2.5	614642	—	24.5	614664	—
1.13	614573	—	3	614613	—	25	614635	—
1.14	614574	—	3.5	614643	—	30	614673	—
1.15	614575	—	4	614614	—	40	614674	—
1.16	614576	—	4.5	614644	—	50	614675	—
1.17	614577	—	5	614615	—	60	614676	—
1.18	614578	—	5.5	614645	—	75	614801	—
1.19	614579	—	6	614616	—	100	614681	—
1.2	614580	—	6.5	614646	—	125	614802	—
1.21	614581	—	7	614617	—	150	614803	—
1.22	614582	—	7.5	614647	—	175	614804	—
1.23	614583	—	8	614618	—	200	614682	—
1.24	614584	—	8.5	614648	—	250	614805	—
1.25	614585	—	9	614619	—	300	614683	—
1.26	614586	—	9.5	614649	—	400	614684	—
1.27	614587	—	10	614671	—	500	614685	—
1.28	614588	—	10.5	614650	—			
1.29	614589	—	11	614621	—			
1.3	614590	—	11.5	614651	—			
1.31	614591	—	12	614622	—			
1.32	614592	—	12.5	614652	—			

Metric Wear Blocks

Length (mm)	Order No.
1	615611
2	615612

*Suffix Number (-■■■) for Selecting Standard and Certificate Provided

ISO/DIN/JIS

Suffix No.	Grade	Inspection Certificate	Calibration Certificate JCSS
-021	0	○	—
-026	0	○	○
-031	1	○	—
-036	1	○	○
-041	2	○	—
-046	2	○	○

ASME

Suffix No.	Grade	Inspection Certificate	Calibration Certificate JCSS
-521	00	○	—
-531	0	○	—
-541	1	○	—
-551	2	○	—

BS

Suffix No.	Grade	Inspection Certificate	Calibration Certificate JCSS
-121	0	○	—
-131	1	○	—
-141	2	○	—



Inspection Certificate

Individual Inch Square Gauge Blocks

*Suffix Number (-■■■) for Selecting Standard and Certificate Provided

ASME			
Suffix No.	Grade	Inspection Certificate	Calibration Certificate
-521	00	○	—
-531	0	○	—
-541	1	○	—
-551	2	○	—

BS			
Suffix No.	Grade	Inspection Certificate	Calibration Certificate
-121	0	○	—
-131	1	○	—
-141	2	○	—



Inspection Certificate

Dimensions

Nominal length: 0.5mm - 4.5mm
(.010" - .19") Unit: mm

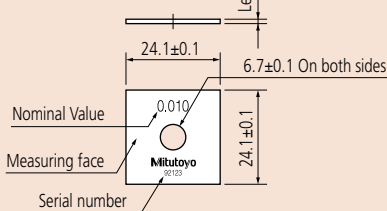

Nominal length: 5mm - 14.5mm
(.02" - .450")

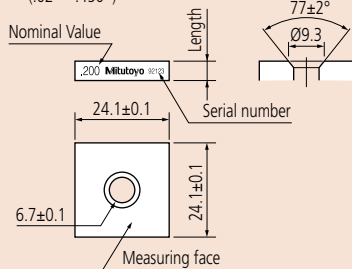

Nominal length: 15mm - 500mm
(.500" - 20")

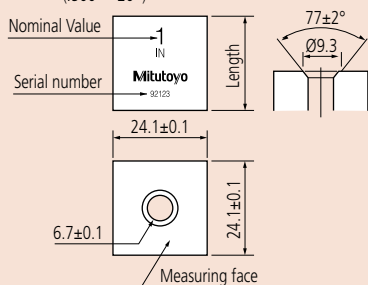

SPECIFICATIONS

Inch Blocks

Length (inch)	Order No.*	
	Steel	CERA
.01	614310	—
.02005	614240	—
.0201	614231	—
.0202	614232	—
.0203	614233	—
.0204	614234	—
.0205	614235	—
.0206	614236	—
.0207	614237	—
.0208	614238	—
.0209	614239	—
.02	614320	—
.021	614321	—
.022	614322	—
.023	614323	—
.024	614324	—
.025	614325	—
.026	614326	—
.027	614327	—
.028	614328	—
.029	614329	—
.03	614330	—
.03125 (1/32)	614301	—
.04	614340	—
.046875 (3/64)	614302	—
.05	614105	616105
.06	614106	—
.0625	614303	616303
.07	614107	—
.078125 (5/64)	614304	—
.08	614108	—
.09	614109	—
.09375 (3/32)	614305	—
.1	614191	616191
.100025	614307	—
.10005	614135	616135
.100075	614308	—
.1001	614121	616121
.1002	614122	616122
.1003	614123	616123
.1004	614124	616124
.1005	614125	616125
.1006	614126	616126
.1007	614127	616127
.1008	614128	616128
.1009	614129	616129
.101	614141	616141
.102	614142	616142
.103	614143	616143
.104	614144	616144
.105	614145	616145

Length (inch)	Order No.*	
	Steel	CERA
.106	614146	616146
.107	614147	616147
.108	614148	616148
.109	614149	616149
.109375 (7/64)	614306	—
.11	614150	616150
.111	614151	616151
.112	614152	616152
.113	614153	616153
.114	614154	616154
.115	614155	616155
.116	614156	616156
.117	614157	616157
.118	614158	616158
.119	614159	616159
.12	614160	616160
.121	614161	616161
.122	614162	616162
.123	614163	616163
.124	614164	616164
.125	614165	616165
.126	614166	616166
.127	614167	616167
.128	614168	616168
.129	614169	616169
.13	614170	616170
.131	614171	616171
.132	614172	616172
.133	614173	616173
.134	614174	616174
.135	614175	616175
.136	614176	616176
.137	614177	616177
.138	614178	616178
.139	614179	616179
.14	614180	616180
.141	614181	616181
.142	614182	616182
.143	614183	616183
.144	614184	616184
.145	614185	616185
.146	614186	616186
.147	614187	616187
.148	614188	616188
.149	614189	616189
.15	614115	616115
.16	614116	616116
.17	614117	616117
.18	614118	616118
.19	614119	616119
.2	614192	616192

Length (inch)	Order No.*	
	Steel	CERA
.25	614212	616212
.3	614193	616193
.35	614213	616213
.375 (3/8)	614309	—
.4	614194	616194
.45	614214	616214
.5	614195	616195
.55	614215	616215
.6	614196	616196
.65	614216	616216
.7	614197	616197
.75	614217	616217
.8	614198	616198
.85	614218	616218
.9	614199	616199
.95	614219	616219
1	614201	616201
2	614202	616202
3	614203	616203
4	614204	616204
5	614205	—
6	614206	—
7	614207	—
8	614208	—
10	614222	—
12	614223	—
16	614224	—
20	614225	—

Inch Wear Blocks

Length (inch)	Order No.*
	Tungsten carbide
.05	615105
.1	615191

Square Gauge Block Accessories

SERIES 516

To expand the variety of Square Gauge Block applications, Mitutoyo offers the Gauge Block Accessories Set. By assembling the items in the set, you can easily and quickly build up a precision measuring instrument.



516-611

SPECIFICATIONS

Metric	
Order No. 516-611	Included in set
2 pcs.	Half round jaw 2mm (619070)
2 pcs.	Half round jaw 5mm (619071)
2 pcs.	Plain jaw (619072)
1 pc.	Center point (619073)
1 pc.	Scriber point (619054)
1 pc.	Block base (619074)
2 pcs.	Flat head screw 1-1/4" (619057)
2 pcs.	Flat head screw 5/8" (619058)
2 pcs.	Slotted head nut (619059)
2 pcs.	Adjustable tie rod 6" (619060)
2 pcs.	Adjustable tie rod 4-1/2" (619061)
1 pc.	Tie rod 3" (619062)
1 pc.	Tie rod 2-1/4" (619063)
1 pc.	Tie rod 1-1/2" (619064)
1 pc.	Tie rod 3/4" (619065)
2 pcs.	Stud (619056)
2 pcs.	Knurled head screw (619066)

Inch	
Order No. 516-612	Included in set
2 pcs.	Half round jaw .125" (619050)
2 pcs.	Half round jaw .25" (619051)
2 pcs.	Plain jaw (619052)
1 pc.	Center point (619053)
1 pc.	Scriber point (619054)
1 pc.	Block base (619055)
2 pcs.	Flat head screw 1-1/4" (619057)
2 pcs.	Flat head screw 5/8" (619058)
2 pcs.	Slotted head nut (619059)
2 pcs.	Adjustable tie rod 6" (619060)
2 pcs.	Adjustable tie rod 4-1/2" (619061)
1 pc.	Tie rod 3" (619062)
1 pc.	Tie rod 2-1/4" (619063)
1 pc.	Tie rod 1-1/2" (619064)
1 pc.	Tie rod 3/4" (619065)
2 pcs.	Stud (619056)
2 pcs.	Knurled head screw (619066)



E

Half round jaw:
Used to measure an inside or outside diameter.

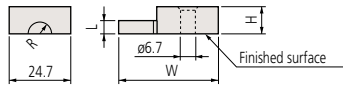

Order No.	R	L	W	H
619070	1.95mm	2mm	33.6mm	5.3mm
619071	4.95mm	5mm	39.9mm	10.3mm
619050	.123"	.125"	33.6mm	5.3mm
619051	.248"	.25"	39.9mm	10.3mm

Plain jaw: **619072** (10mm), **619052** (.5")
Used to measure an inside or outside diameter.

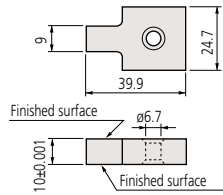

Center point: **619073** (2mm), **619053** (.1")
Used to scribe a workpiece.

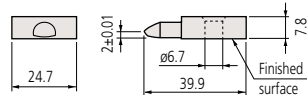

Scriber point: **619054**
Used to scribe a workpiece.

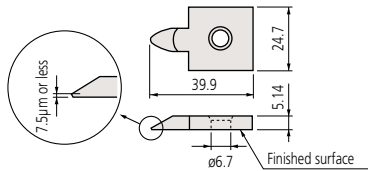

Base: **619074** (10mm), **619054** (.5")
Used as clamps by inserting them into the center hole of a square gauge block.

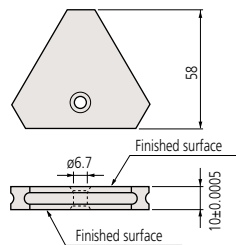

Stud: **619056**

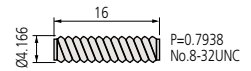

Flat head screw

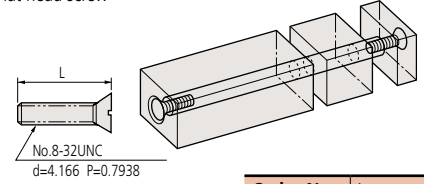

Order No.	L
619057	31.6mm
619058	15.8mm

Slotted head nut: **619059**

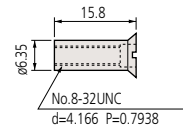

Knurled head screw: **619066**

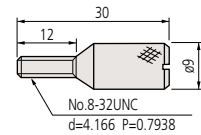

Tie rod

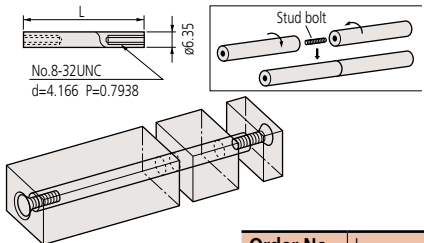

Order No.	L
619065	19mm
619064	38mm
619063	57mm
619062	76mm

Adjustable tie rod

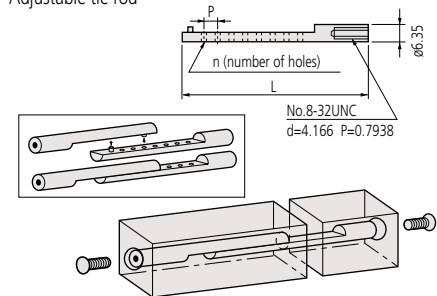

Order No.	L	P	n
619060	124.5mm	6.35mm	14
619061	86.5mm	6.35mm	8

Ceraston

Accessory for Gauge Block Maintenance

FEATURES

- Alumina-ceramic abrasive stone for removing burrs from hard materials such as ceramics that ordinary stones cannot handle.
- Can be used both for steel gauge blocks and CERA Blocks.



SPECIFICATIONS

Order No.	Dimensions (W x D x H)	Mass
601645	100 x 25 x 12mm	110g
601644	150 x 50 x 20mm	530g



Removing burrs

- (1) Wipe any dust and oil films from the gauge block and the Ceraston (or Arkansas stone) using a solvent.
- (2) Place the gauge block on the Ceraston so that the measuring face that has burrs is on the abrasive surface of the stone. While applying light pressure, move the gauge block to and fro about ten times (Fig. 1). Use a block rubber for thin gauge blocks to apply even pressure (Fig. 2).
- (3) Check the measuring face for burrs with an optical flat. If the burrs have not been removed, repeat step (2). If burrs are too large, they may not be removed with an abrasive stone. If so, discard the gauge block.

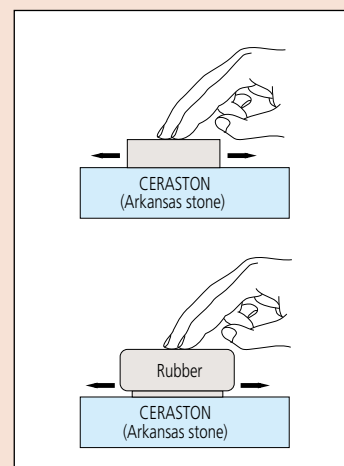

Note: The abrasive surface of a Ceraston must be made flat by lapping it from time to time. After lapping the Ceraston, the lapping powder must be completely removed from the surface to prevent the surface of the gauge block from being scratched.
Mitutoyo does not offer Arkansas stones.

Maintenance Kit for Gauge Blocks

SERIES 516

FEATURES

- Includes all necessary maintenance tools for daily care and storage of gauge blocks.
- Supplied in a fitted wooden case for portable use.



SPECIFICATIONS

Order No.	Tools and accessories included
516-650	Anti-corrosive oil (600001): Used for both steel and tungsten-carbide gauge blocks.
516-650E	Ceraston (601645): Used for removing burrs on the measuring surface
	Optical flat (600003): Used for checking whether burrs exist.
	Tweezers (600004): Used for handling thin gauge blocks.
	Blower brush (600005): Used for blowing out dust on the measuring surface.
	Cleaning paper (600006): Used for wiping off rust preventive oil and contamination.
	Artificial leather mat (600007): Used as a gauge block mat.
	Reagent bottle (600008): Bottle of wiping solution (100mL)
	Gloves

516-650E: Excluding anti-corrosive oil (600001)
516-650: including anti-corrosive oil (600001) is for domestic sales only.
In the case of order from overseas, place an order for 516-650E: excluding anti-corrosive oil and anti-corrosive oil (600001) separately.

Step Master

SERIES 516

FEATURES

Step master is a master gage used for the z-axis (vertical direction) calibration of optical instruments.

- Each adjacent step is calibrated to a resolution of $0.01\mu\text{m}$ by using an interferometer with an accuracy tolerance of $\pm 0.20\mu\text{m}$.
- Steel and ceramic types are available.



516-499 Ceramic type



516-498 Ceramic type



Dimensions

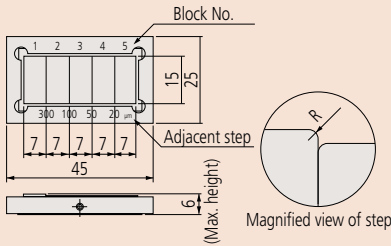

Step value between adjacent blocks



	No. 1 - 2	No. 2 - 3	No. 3 - 4	No. 4 - 5
516-198, 516-498	10 μm	5 μm	2 μm	1 μm
516-199, 516-499	300 μm	100 μm	50 μm	20 μm

SPECIFICATIONS

Metric	Order No.	Remarks
	516-198	Steel type (Step: 10 μm /5 μm /2 μm /1 μm)
	516-199	Steel type (Step: 300 μm /100 μm /50 μm /20 μm)
	516-498	Ceramic type (Step: 10 μm /5 μm /2 μm /1 μm)
	516-499	Ceramic type (Step: 300 μm /100 μm /50 μm /20 μm)

Available Dimensions

Nominal size:	0.1mm to 1000mm (steel)
	0.5mm to 500mm (ceramic)
Nominal pitch:	0.0005mm (up to 100mm)
	0.001mm (over 100mm)

Special low-expansion glass and ceramic materials are available.

Custom-made Blocks & Gages

FEATURES

- Mitutoyo can provide Gauge Blocks and reference gages to your size and design.



- O: Steel Long rectangular block (15 x 10 x 200mm)
- P: Ceramic square block (24.1 x 24.1 x 12.3mm)
- Q: Steel thin rectangular block (30 x 6 x 1.9mm)
- R: Steel square block (9 x 9 x 6mm)
- S: Steel thin rectangular block (30 x 6 x 2.1mm)
- T: Steel cylindrical Block ($\phi 13.08$ x 12mm)

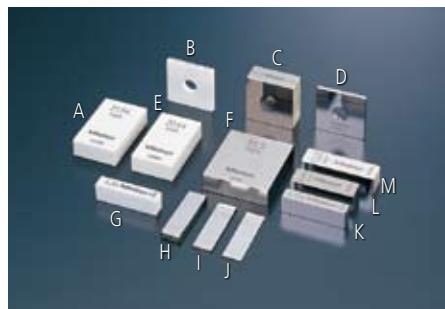

- A: Ceramic rectangular gauge block (21.94mm)
- B: Ceramic square gauge block (2.1005mm)
- C: Steel square gauge block (10.72mm)
- D: Steel square gauge block (2.2065mm)
- E: Ceramic rectangular gauge block (20.64mm)
- F: Steel rectangular gauge block (31.5mm)
- G: Ceramic rectangular gauge block (6.34mm)
- H: Steel rectangular gauge block (3.603mm)
- I: Steel rectangular gauge block (1.1505mm)
- J: Steel rectangular gauge block (0.555mm)
- K: Steel rectangular gauge block (6.156mm)
- L: Steel rectangular gauge block (9.694mm)
- M: Steel rectangular gauge block (10.02mm)



- U: Cylindrical reference block for depth micrometer ($\phi 60$ x 150mm)
- V: Ceramic reference plate (50 x 50 x 50mm, flatness 0.3 μm)
- W: Ceramic stepped block (30 x 18 x 5mm, step: 0.15mm)

Gauge Block Interferometer GBI

Automatic Gauge Block Calibration

FEATURES

- Automatic measuring instrument for primary-level gauge block length determination for blocks between 0.1mm and 250mm using optical interference.
- The intensity and wavelength of the He-Ne laser light sources are highly stable. This allows high-accuracy measurement.
- To reduce the effects of operator body heat, automatic remote measurement can be performed.
- The GBI automatically detects the distribution of interference fringes and processes the data, thus eliminating human error.
- Both the refractive index and the thermal expansion of gauge blocks are automatically compensated for by the computer which is linked to a thermometer, hygrometer, and digital barometer.



SPECIFICATIONS

Model No.	GBI
Light sources	632.8μm wavelength system He-Ne laser 543.5μm wavelength system He-Ne laser
Measuring range	0.5mm - 250mm
Accuracy (Uncertainty of measurement at the 95% confidence level)	±0.02μm (when measuring a gauge block of 100mm length), ±0.04μm (when measuring a gauge block of 200mm length)
Number of gauge blocks that can be mounted on the measuring table	12

Gauge Block Comparator GBCD-100A

SERIES 565 — Automatic Type Comparator with Dual Gauge Heads

SPECIFICATIONS

Model No.	GBCD-100A
Order No.	100V AC 565-111K
	110V AC 565-111C
	120V AC 565-111A
	240V AC 565-111E
Resolution	0.00001mm (0.01μm)
Range	0.5mm - 100mm
Measuring unit	Differential (dual-head) type Mu-Checker
Accuracy in narrow range (20°C)	±(0.03+0.3L/1000)μm* L = Gauge block length (mm) * Uncertainty of measurement at the 95% confidence level (not including the calibration error of the reference gauge block).
Measuring force	Upper gage head: 1N (100gf) Lower gage head: 0.6N (60gf)
Air requirement	400kPa (4kgf/cm ²)
Operating conditions	Temperature: 20°C ±1°C Humidity: 58%RH ±15%RH
Power supply	100-120 / 200-240 VAC, 50/60Hz
Dimensions (W x D x H)	Main unit: 710 x 366 x 783mm Electronic unit: 160 x 410 x 382mm
Mass	Main unit: 120kg Electronic unit: 14kg



The GBCD-100A Automatic Gauge Block Comparator is an easy-to-operate dual-head type gauge block inspection system. It automatically compares a test block with an appropriate reference gauge block and determines central length, maximum length, minimum length, and parallelism of the test block through the operation of the connected personal computer.

Optional Accessories

- 516-146-E2:** Gauge block set for probe calibration
- 962764:** Gauge block holder for probe calibration
- 611615-02:** 5mm gauge block (grade 0) for origin setting
- 243989:** Auxiliary stage (size: 360 x 253mm)
- 218-007:** Work bench



516-146-E2

Special bridge-type block

Gauge Block Comparator GBCD-250

SERIES 565 — Manual Comparator with Dual Gage Heads

FEATURES

- Gauge blocks between 0.1mm and 250mm can be easily compared with reference gauge blocks on the GBCD-250.
- The upper and lower gaging heads assure the operator of high-accuracy measurement with ease of use.

SPECIFICATIONS

Metric	
Model No.	GBCD-250
Order No.	100V AC 565-150
	110V AC 565-150A
	220V AC 565-150D
	240V AC 565-150E
Range	0.1mm - 250mm
Resolution	0.00001mm (0.01μm)
Accuracy in narrow range (20°C)	$\pm(0.03+0.3L/1000)\mu\text{m}^*$ L = Gauge block length (mm)
Measuring unit	Laser Hologage (upper, lower)
Measuring force	0.7N (upper), 0.2N (lower)
Operating conditions	Temperature: 20°C \pm 1°C Humidity: 58%RH \pm 15%RH
Data output	Via SPC output port
Power supply	100-120 / 200-240 VAC, 50/60Hz
Dimensions (W x D x H)	Main unit: 455 x 318 x 691mm
	Display unit: 345 x 397 x 187mm
Mass	Main unit: Approx. 50kg
	Display unit: Approx. 9kg

* Uncertainty of measurement at the 95% confidence level (not including the calibration error of the reference gauge block).

Optional Accessory

- 02ASG570:** GBPAK-ME (Software)
02ASP422: RS-232C cable
937179T: Foot switch
516-145-E2: Gauge block set for probe calibration
02ASD130: Square gauge block measuring kit
02ASF040: Heat insulation shield
02ASD100: Gauge block set for accuracy inspection



Gauge Block Comparator GBCS-250

SERIES 565 — Manual Comparator with Single Gage Head

FEATURES

- This manual comparator features a gauge block positioning unit that enables many gauge blocks to be tested efficiently within a short space of time.
- A gauge block handling arm is provided for the GBCS which does not include a gauge block positioning unit.

SPECIFICATIONS

Model No.	GBCS-250
Order No.	JIS/100V 565-140
	UL/CSA 565-140A
	CEE 565-140D
	BS 565-140E
	EK 565-140K
	China 565-140DC
Standard accessory	Gauge block positioning unit
Range	0.1mm - 250mm
Resolution	0.00001mm (0.01μm)
Accuracy in narrow range (20°C)	$\pm(0.03+0.3L/1000)\mu\text{m}^*$ L = Gauge block length (mm)
Measuring unit	Laser Hologage
Measuring force	0.4N
Operating conditions	Temperature: 20°C \pm 1°C Humidity: 58%RH \pm 15%RH
Data output	Via RS-232C interface unit
Power supply	100-120 / 200-240 VAC, 50/60Hz
Dimensions (W x D x H)	Main unit: 411 x 300 x 684mm
	Display unit: 210 x 162 x 118mm
Mass	Main unit: Approx. 60kg
	Display unit: Approx. 2.4kg

* Uncertainty of measurement at the 95% confidence level (not including the calibration error of the reference gauge block).

Optional Accessories

- 99MBD006A:** GBPAK-ME (Software)
02ASP422: RS-232C cable
937179T: Foot switch
02ASF040: Heat insulation shield
02ASD130: Square gauge block measuring kit

GBCS-250
(with Gauge Block Positioning Unit)



Height Master

SERIES 515

FEATURES

- Models with the the staggered arrangement of blocks have two measuring faces on the same level, one facing up and the other down (except for 515-310).



515-322

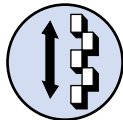

Staggered 20mm blocks (movable)

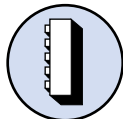

Vertical orientation

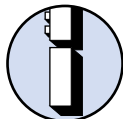

Riser block

- Each Height Master is supplied with a gauge block for reference-height setting.
- Fitted wooden case supplied.



SPECIFICATIONS

Metric		
Range (H)	Order No.	Block step
5 < H ≤ 310mm	515-322	20mm (staggered)

Inch		
Range (H)	Order No.	Block step
.2" < H ≤ 12.2"	515-310	.5" (straight)
.2" < H ≤ 12.2"	515-311	1" (staggered)



(Refer to page IX for details.)

Technical Data

Measuring range (H): Refer to the list of specifications.
 Graduation: 0.001mm or .00001"
 Block arrangement: Staggered
 (515-310: straight)
 Micrometer adjustment: 20mm or 1"
 Micrometer feed: 0.5mm/rev or .025"/rev
 Block pitch accuracy: ±1.5µm
 Parallelism of blocks: 1µm
 Feed error: ±1µm
 Retrace error: 1µm
 Mass: 23kg

Optional Accessories

- 515-112: Auxiliary block kit for bore gage (mm)
- 515-119: Auxiliary block kit for bore gage (for 515-310)
- 515-121: Auxiliary block kit for bore gage (for 515-311)
- : Riser block (see page E-31.)

Reading

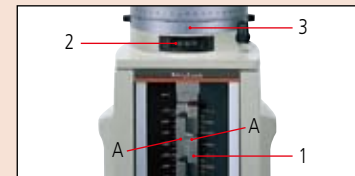

Height A

1. Scale	280. mm
2. Counter	5.67 mm
3. Thimble	0.000 mm
285.670 mm	

Digital Height Master

SERIES 515

FEATURES

- Standard model with a digital display, featuring all essential specifications required for a versatile height standard.



515-354

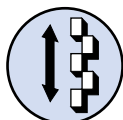

Staggered 20mm blocks (movable)

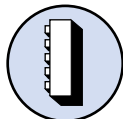

Vertical orientation

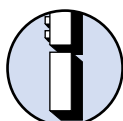

Riser block

- SPC output.
- Each Height Master is supplied with a gauge block for reference-height setting.



SPECIFICATIONS

Metric		
Range (H)	Order No.	Block step
10 < H ≤ 310mm	515-354	20mm (staggered)
10 < H ≤ 460mm	515-356	20mm (staggered)
10 < H ≤ 610mm	515-358	20mm (staggered)

Inch		
Range (H)	Order No.	Block step
.5" < H ≤ 12"	515-355	1" (staggered)
.5" < H ≤ 18"	515-357	1" (staggered)
.5" < H ≤ 24"	515-359	1" (staggered)



(Refer to page IX for details.)



Technical Data

Measuring range (H): Refer to the list of specifications.
 Graduation: 0.001mm or .00001"
 Block arrangement: Staggered
 Micrometer adjustment: 20mm or 1"
 Micrometer feed: 0.5mm/rev or .025"/rev
 Block pitch accuracy: ±1.5µm (0 < H ≤ 310mm)
 ±2.5µm (310 < H ≤ 450mm)
 ±3.5µm (450 < H ≤ 610mm)
 Parallelism of blocks: 2.0µm (0 < H ≤ 310mm)
 2.5µm (310 < H ≤ 610mm)
 Feed error: ±2.0µm (515-358, 515-359: ±2.5µm)
 Retrace error: 2.0µm (515-358, 515-359: 2.5µm)
 Display: LCD
 Battery: SR44 (2 pcs.), 938882
 Battery life: Approx. 1.8 years under normal use
 Mass: 9.5kg (515-354, 515-355)
 13.6kg (515-356, 515-357)
 16kg (515-358, 515-359)

Function

Zero setting, Presetting, ABS/INC switching, Data hold, Data output, inch/mm conversion (inch/mm models)
 Alarm: Low voltage, Counting value composition error

Optional Accessories

- 515-111: Auxiliary block kit for bore gage (mm)
- 515-120: Auxiliary block kit for bore gage (inch)
- : Riser block (see page E-31.)
- 937387: SPC cable (1m)
- 965013: SPC cable (2m)



SPC

(Refer to page IX for details.)

Technical Data

Measuring range (H): Refer to the list of specifications.
 Graduation: 0.0001mm or .000005"
 Block arrangement: Staggered
 Micrometer adjustment: 20mm or 1"
 Indication accuracy: ±1µm
 Block pitch accuracy: ±0.5µm
 Parallelism of blocks: 0.5µm
 Feed error: ±0.5µm
 Display: LED
 Power supply: Via AC adaptor
 Mass: 18kg

Function

Zero setting, Presetting, ABS/INC switching, Data hold, Data output, inch/mm conversion (inch/mm models)

Optional Accessories

- : Riser block
- 936937**: SPC cable (1m)
- 965014**: SPC cable (2m)
- 02AZD790D**: SPC cable for U-WAVE(160mm)



LED display

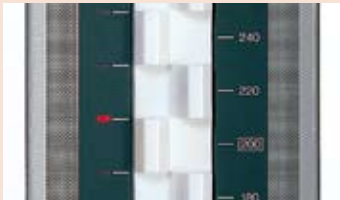

LED block indication



Fine feed wheel

Coarse feed wheel

Bore gage reference-setting



CERA Height Master

SERIES 515

FEATURES

- The measuring blocks are made from a zirconia-based ceramic material which is highly resistant to corrosion and wear, and free from deterioration over time.



515-341

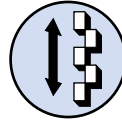

Staggered 20mm blocks (movable)

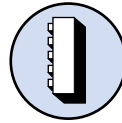

Vertical orientation

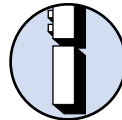

Riser block

- The CERA Height Master features the staggered arrangement of blocks which provides two measuring faces on the same level, one facing up and the other facing down.
- SPC output.
- Fitted wooden case supplied.

SPECIFICATIONS

Metric		
Range (H)	Order No.*	Block step
5 < H ≤ 310mm	515-341	20mm (staggered)

Inch		
Range (H)	Order No.*	Block step
.2" < H ≤ 12"	515-342	1" (staggered)

* To denote your AC power cable add the following suffixes to the order No.: **A** for UL/CSA, **D** for CEE, **DC** for CCC, **E** for BS, **K** for EK, **No suffix** is required for JIS/100V

Auxiliary Block Kit

SERIES 515 — for Bore Gage

FEATURES

- Used for efficient reference-setting of dial bore gages and tubular inside micrometers (18 - 150mm) on a Height Master.

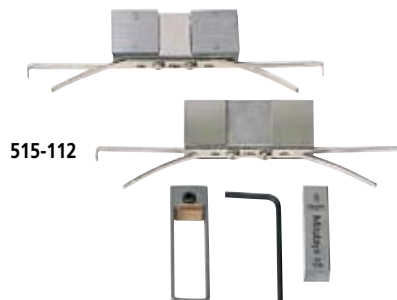

515-112

SPECIFICATIONS

Metric	
Order No.	Model
515-110	Universal Height Master
515-111	Digital Height Master
515-112	Height Master

Inch	
Order No.	Model
515-119	Universal Height Master, Height Master (515-310)
515-120	Digital Height Master
515-121	Height Master (515-310)

Riser Blocks

SERIES 515

FEATURES

- These riser blocks are specially designed for standard/Digimatic height masters.



515-113 515-114 515-115

SPECIFICATIONS

Metric			
Height	Order No.	Accuracy	Mass
150mm	515-113	±0.6µm	5.7kg
300mm	515-114	±1.0µm	11.3kg
600mm	515-115	±2.0µm	31kg

Inch			
Height	Order No.	Accuracy	Mass
6"	515-116	±20µin	12.5 lbs.
12"	515-117	±40µin	24.9 lbs.
24"	515-118	±80µin	68.2 lbs.

Universal Height Master

SERIES 515 — Usable in Vertical and Horizontal Orientations

FEATURES

- The Universal Height Master is designed for both vertical and horizontal orientations, providing a wide range of applications such as accuracy checking of machine tool table movements.
- Fitted wooden case supplied.

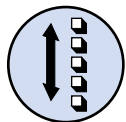

Single-row 10mm blocks (movable)

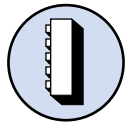

Vertical orientation

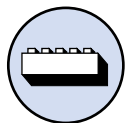

Horizontal orientation



Riser block

515-520

SPECIFICATIONS

Metric		
Range (R)	Order No.	Block step
$5 < R \leq 610\text{mm}$	515-520	10mm (straight)
$5 < R \leq 1010\text{mm}$	515-523	10mm (straight)

Inch		
Range (R)	Order No.	Block step
$.2" < R \leq 18.2"$	515-512	.5" (straight)
$.2" < R \leq 24.2"$	515-510	.5" (straight)
$.2" < R \leq 40.2"$	515-513	.5" (straight)



(Refer to page IX for details.)

Technical Data

Measuring range (R): Refer to the list of specifications.
 Graduation: 0.001mm or .00001"
 Block arrangement: Straight
 Micrometer adjustment: 20mm or 1"
 Micrometer feed: 0.5mm/rev or .025"/rev
 Block pitch accuracy: $\pm 1.5\mu\text{m}$ ($0 < R \leq 310\text{mm}$)
 $\pm 2.5\mu\text{m}$ ($310 < R \leq 610\text{mm}$)
 $\pm 3.5\mu\text{m}$ ($610 < R \leq 1010\text{mm}$)
 Parallelism of blocks: 1.5 μm ($0 < R \leq 610\text{mm}$)
 2 μm ($610 < R \leq 1010\text{mm}$)
 Feed error: $\pm 1.2\mu\text{m}$ (**515-523, 515-513**): $\pm 1.5\mu\text{m}$
 Retrace error: 1.2 μm (**515-523, 515-513**): 1.5 μm
 Mass: 42kg (**515-520, 515-512**)
 50kg (**515-510**)
 63.5kg (**515-523, 515-513**)

Optional Accessories

- 900574:** Supporting base for vertical operation
 (*supplied as a standard for **515-523** and **515-513**)
515-110: Auxiliary block kit for bore gage (mm)
515-119: Auxiliary block kit for bore gage (inch)



Using in horizontal orientation

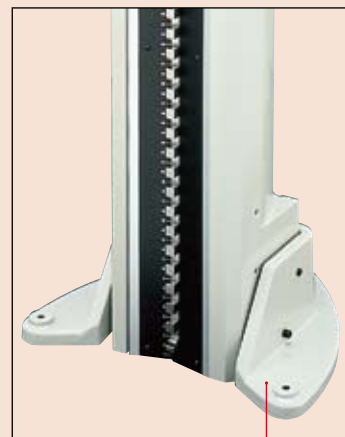

Supporting base

Check Master

SERIES 515



(Refer to page IX for details.)

Technical Data

Measuring range (R): Refer to the list of specifications.
 Block pitch accuracy: $\pm 2.5\mu\text{m}$ ($0 < R \leq 310\text{mm}$)
 $\pm 3.5\mu\text{m}$ ($310 < R \leq 610\text{mm}$)
 $\pm 5.0\mu\text{m}$ ($610 < R \leq 1010\text{mm}$)
 $\pm 8.0\mu\text{m}$ ($1010 < R \leq 1510\text{mm}$)
 Parallelism of blocks: $1.2\mu\text{m}$ ($0 < R \leq 310\text{mm}$)
 $1.5\mu\text{m}$ ($310 < R \leq 610\text{mm}$)
 $2.0\mu\text{m}$ ($610 < R \leq 1010\text{mm}$)
 $2.5\mu\text{m}$ ($1010 < R \leq 1510\text{mm}$)
 Mass: 7kg (515-720, 515-710)
 10kg (515-721, 515-711)
 13kg (515-722, 515-712)
 22kg (515-723, 515-713)
 30kg (515-724)



SPECIFICATIONS

Metric		
Range (R)	Order No.	Block step
300mm	515-720	10mm
450mm	515-721	10mm
600mm	515-722	10mm
1000mm	515-723	10mm
1500mm	515-724	10mm

Inch		
Range (H)	Order No.	Block step
12"	515-710	.5"
18"	515-711	.5"
24"	515-712	.5"
40"	515-713	.5"

High Accuracy Check Master

SERIES 515



(Refer to page IX for details.)

Technical Data

Measuring range (R): Refer to the list of specifications.
 Block pitch accuracy: $\pm 1.2\mu\text{m}$ ($0 < R \leq 310\text{mm}$)
 $\pm 1.8\mu\text{m}$ ($310 < R \leq 610\text{mm}$)
 $\pm 2.5\mu\text{m}$ ($610 < R \leq 1010\text{mm}$)
 $\pm 4.0\mu\text{m}$ ($1010 < R \leq 1510\text{mm}$)
 Parallelism of blocks: $1.0\mu\text{m}$ ($0 < R \leq 450\text{mm}$)
 $1.5\mu\text{m}$ ($450 < R \leq 1010\text{mm}$)
 $2.0\mu\text{m}$ ($1010 < R \leq 1510\text{mm}$)
 Mass: 3.6kg (515-740, 515-730)
 5.4kg (515-741, 515-731)
 7.2kg (515-742, 515-732)
 12kg (515-743, 515-733)
 18kg (515-744, 515-734)

Optional Accessories

601167: Supporting base for vertical operation



Supporting base

FEATURES

- Designed to check the accuracy of table movements of machine tools and calibrate CMMs. Permanently wrung stack of gauge blocks is housed in a rigid frame.
- Can be used in either vertical or horizontal orientation.
- Fitted wooden case supplied.

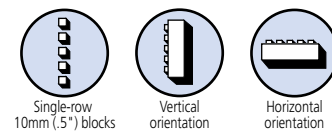

Specifications for Ceramic Check Master:

- Each measuring block is made of zirconia-based ceramic that requires no anti-corrosion treatment for measuring faces.
- Free from deterioration and dimensional changes over time.

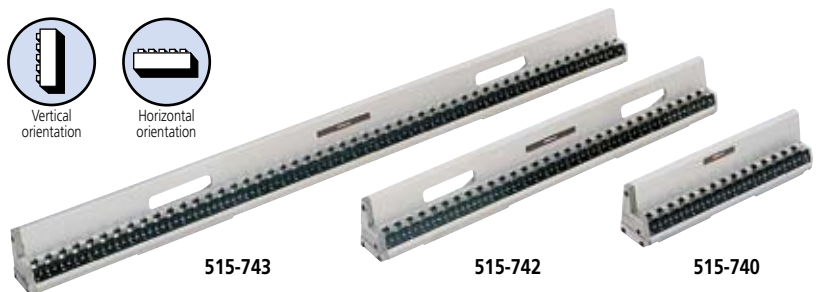

SPECIFICATIONS

Metric		
Range (R)	Order No.	Block step
300mm	515-740 / 515-760*	10mm
450mm	515-741 / 515-761*	10mm
600mm	515-742 / 515-762*	10mm
1000mm	515-743 / 515-763*	10mm
1500mm	515-744 / 515-764*	10mm

Inch		
Range (R)	Order No.	Block step
12"	515-730 / 515-750*	.5"
18"	515-731 / 515-751*	.5"
24"	515-732 / 515-752*	.5"
40"	515-733 / 515-753*	.5"
60"	515-734 / 515-754*	.5"

*Ceramic Check Master

*Ceramic Check Master

Standard Scales

SERIES 182 — Made of Low Expansion Glass

FEATURES

- High precision glass scales manufactured under Mitutoyo's leading-edge Linear Scale production technology.
- High accuracy is guaranteed for use as a standard for calibrating graduated scales.



(Refer to page IX for details.)

Technical Data

Accuracy (at 20°C): $(0.5+L/1000)\mu\text{m}$,
 L = Measured length (mm)
 Material: Low expansion glass
 Thermal expansion coefficient: $(0.00\pm 0.02)\times 10^{-6}/\text{K}$
 Graduation: 1mm
 Graduation line thickness: 4 μm
 Mass: 0.75kg (250mm), 1.8kg (500mm)

SPECIFICATIONS

Metric				
Range	Order No.	L	W	T
250mm	182-501-50	280mm	20mm	10mm
250mm	182-501-60	280mm	20mm	10mm
500mm	182-502-50	530mm	30mm	20mm
500mm	182-502-60*	530mm	30mm	20mm

*with English JCSS certificate.

Dimensions

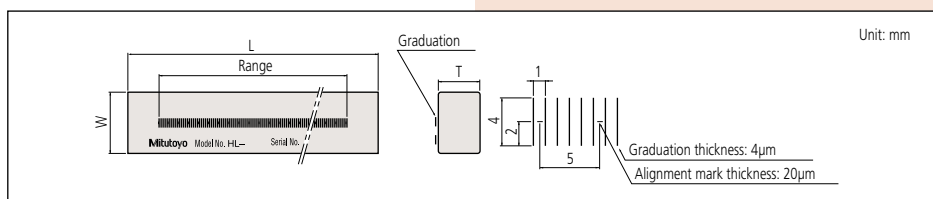

Working Standard Scales

SERIES 182

FEATURES

- High precision glass scales manufactured under Mitutoyo's leading-edge Linear Scale production technology.
- Ideal for checking magnification accuracy of profile projectors and microscopes, and the table feeding accuracy of measuring equipment.

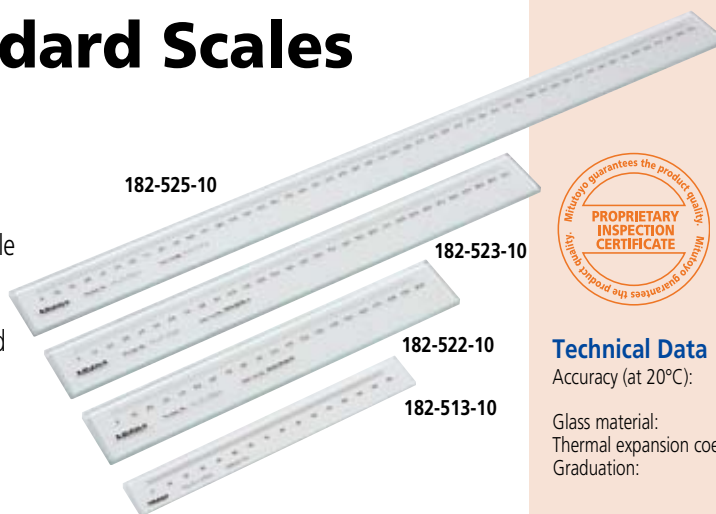

(Refer to page IX for details.)

Technical Data

Accuracy (at 20°C): $(1.5+2L/1000)\mu\text{m}$,
 L = Measured length (mm)
 Glass material: Sodium glass
 Thermal expansion coefficient: $(8\pm 1)\times 10^{-6}/\text{K}$
 Graduation: 0.1mm (thickness: 20 μm)
 0.5mm (thickness: 50 μm)
 1mm (thickness: 100 μm)
 Mass: Refer to the list of specifications.

SPECIFICATIONS

Metric				
Range	Order No.	Graduation	L	Mass
50mm	182-511-10	0.1mm	75mm	0.23kg
100mm	182-512-10	0.1mm	125mm	0.24kg
150mm	182-513-10	0.1mm	175mm	0.35kg
200mm	182-514-10	0.1mm	225mm	0.36kg
100mm	182-521-10	0.5mm	130mm	0.27kg
200mm	182-522-10	0.5mm	230mm	0.32kg
300mm	182-523-10	0.5mm	330mm	0.57kg
400mm	182-524-10	0.5mm	430mm	0.71kg
500mm	182-525-10	0.5mm	530mm	0.86kg
250mm	182-531-10	1mm	280mm	0.55kg
500mm	182-532-10	1mm	530mm	0.86kg
750mm	182-533-10	1mm	780mm	1.22kg
1000mm	182-534-10	1mm	1030mm	1.54kg

Dimensions

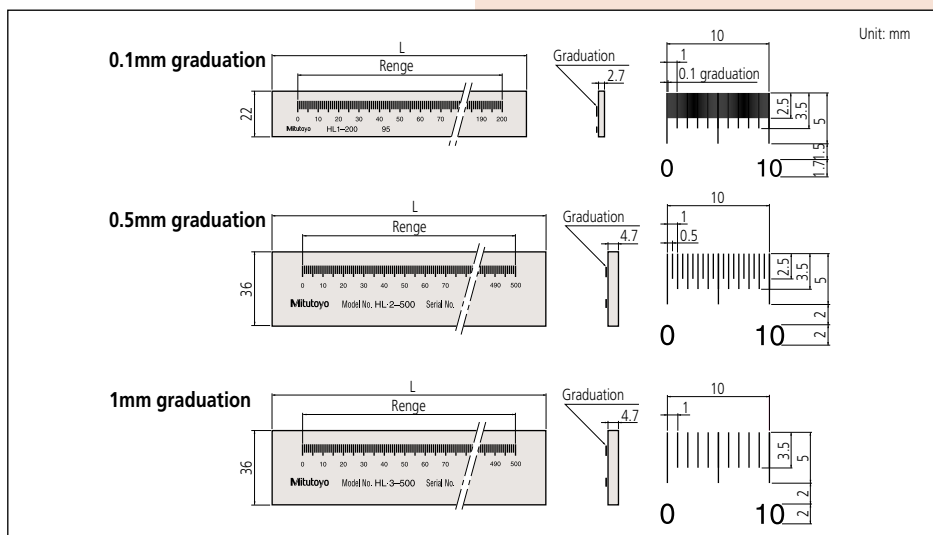

CERA Straight Master

SERIES 311 — Straightness Measuring Gage



(Refer to page IX for details.)



FEATURES

The CERA Straight master is a gage used for inspecting the straightness of travel of moving elements on equipment such as machine tools, CMMs, form measuring machines and semiconductor related equipment.

- Alumina ceramic construction.
- 50mm-pitch graduated scales.
- Precision lapped reference surfaces.
- Double faced model has two reference faces for checking straightness in two orthogonal directions.
- Little secular change.
- Lightweight.



*Suffix Number for Inspection Certificate and Calibration Certificate

Suffix No.	Certificate provided
-20	Provided with Inspection Certificate
-22	Provided with Calibration Certificate

Technical Data

Cross section

(High accuracy and ultra-high accuracy types)

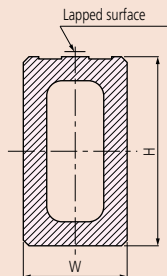

Double faced model

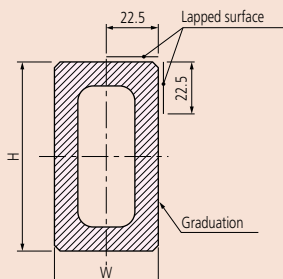

SPECIFICATIONS

Metric		Inch		High accuracy model		
Nominal length	Order No.*	Nominal length	Order No.*	Straightness	Size (L x W x H)	Mass
400mm	311-302	16"	311-322	0.3μm	440 x 35 x 50mm	1.8kg
700mm	311-305	28"	311-325	0.5μm	740 x 35 x 50mm	3kg
1000mm	311-307	40"	311-327	1.0μm	1040 x 45 x 80mm	8kg
1300mm	311-309	50"	311-329	1.5μm	1340 x 45 x 80mm	10kg

Metric		Inch		Ultra-high accuracy model		
Nominal length	Order No.*	Nominal length	Order No.*	Straightness	Size (L x W x H)	Mass
400mm	311-332	16"	311-342	0.2μm	440 x 35 x 50mm	1.8kg
700mm	311-335	28"	311-345	0.4μm	740 x 35 x 50mm	3kg
1000mm	311-337	40"	311-347	0.5μm	1040 x 45 x 80mm	8kg
1300mm	311-339	50"	311-349	0.7μm	1340 x 45 x 80mm	10kg

Double faced model



SPECIFICATIONS

Metric		Inch		Double faced model		
Nominal length	Order No.*	Nominal length	Order No.*	Straightness	Size (L x W x H)	Mass
400mm	311-352	16"	311-362	0.3μm	440 x 45 x 80mm	3.2kg
700mm	311-355	28"	311-365	0.5μm	740 x 45 x 80mm	5.5kg
1000mm	311-357	40"	311-367	1.0μm	1040 x 45 x 80mm	8kg
1300mm	311-359	50"	311-369	1.5μm	1340 x 45 x 80mm	10kg

Snap Gage Checker

SERIES 515

FEATURES

- Capable of inspecting snap gages quickly and accurately with resolution down to 0.0001mm.
- The digital display and constant-force measurement capability allow skill-free operation.
- Zirconia ceramic measuring blocks ensure a long service life with minimal maintenance.
- SPC output.



515-611

SPECIFICATIONS

Metric	
Range	Order No.*
20 - 320mm	515-611

* To denote your AC power cable add the following suffixes to the order No.: **A** for UL/CSA, **D** for CEE, **DC** for CCC, **E** for BS, **K** for EK, **No suffix** is required for JIS/100V

Inch	
Range	Order No.*
.8" - 12.8"	515-612

* To denote your AC power cable add the following suffixes to the order No.: **A** for UL/CSA, **D** for CEE, **DC** for CCC, **E** for BS, **No suffix** is required for JIS/100V

Dimensions

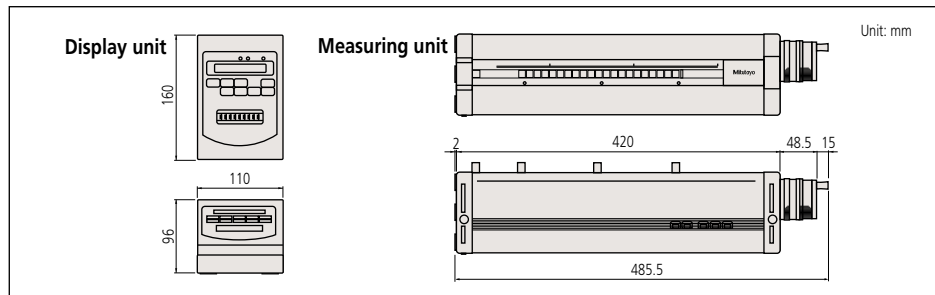

High Precision Square

SERIES 311

FEATURES

The High Precision Square is a gage used for inspecting the travel straightness and axial perpendicularity of moving elements on equipment such as machine tools, CMMs, form measuring machines and semiconductor related equipment.

- Four precision-lapped reference surfaces.
- Better than 1µm/300mm straightness and perpendicularity.

SPECIFICATIONS

Metric		
Order No.	Dimension (W x L x T)	Mass
311-101	80 x 100 x 25mm	1.1kg
311-102	160 x 200 x 25mm	3.5kg
311-103	250 x 300 x 30mm	8.6kg

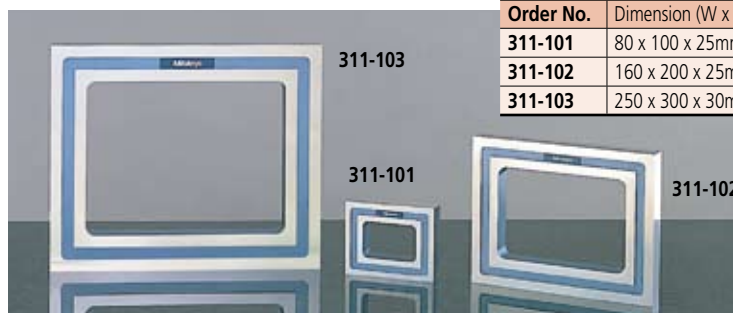

(Refer to page IX for details.)

Technical Data

Range:	20 - 320mm
Resolution:	0.0001mm/0.001mm or .00001"/.0001"
Block adjustment:	100mm
Block pitch accuracy:	±0.001mm
Parallelism of blocks*:	0.001mm (*between the anvil block and the 1st measuring block)
Feed error:	±0.002mm
Power supply:	Via AC adaptor
Mass:	12.5kg

Function

Data output

Optional Accessories

- 936937: SPC cable (1m)
- 965014: SPC cable (2m)
- 02AZD790D: SPC cable for U-WAVE(160mm)
- 990554: Workpiece rest

Square Master

SERIES 311 — Squareness / Straightness Measuring Instrument

Technical Data

Squareness:	3 μ m (311-215, 311-216)
	6 μ m (311-225, 311-226)
	9 μ m (311-245, 311-246)
Straightness:	2 μ m (311-215, 311-216)
	2.5 μ m (311-225, 311-226)
	3.5 μ m (311-245, 311-246)
Dial test indicator provided	
Range:	0.2mm or .008"
Graduation:	0.002mm or .0001"
Accuracy:	3 μ m or \pm .0001"
Dial reading:	0-100-0 (metric) or 0-4-0 (inch)
Mass:	13.7kg, 30.14 lbs (311-215, 311-216)
	16.2kg, 35.64 lbs (311-225, 311-226)
	24kg 52.8 lbs (311-245, 311-246)

Optional Accessories

_____:	Riser blocks (see page E-31.)*
900571:	Adjustable holder
900551:	Extension holder
900565:	Feeler

*Not available for 450mm (18") model.

Adjustable holder

No.900571

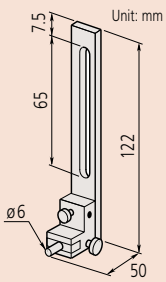

Extension holder

No.900551

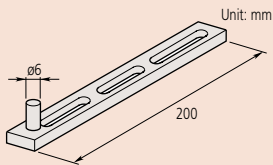

Feeler

No.900565

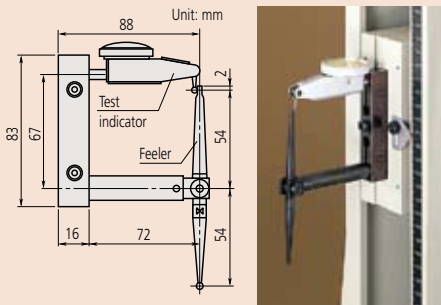

FEATURES

- Squareness (perpendicularity) and straightness measurements can be performed accurately and efficiently by just moving a lever.
- Displacements read by dial test indicator supplied.
- Instrument squareness is adjustable for high accuracy measurement.



311-215



311-225



311-245

SPECIFICATIONS

Metric			
Vertical travel	Order No.	Squareness	Straightness
150mm	311-215	3 μ m	2 μ m
250mm	311-225	6 μ m	2.5 μ m
450mm	311-245	9 μ m	3.5 μ m

Inch			
Vertical travel	Order No.	Squareness	Straightness
6"	311-216	.00012"	.00008"
10"	311-226	.00024"	.0001"
18"	311-246	.00036"	.00014"

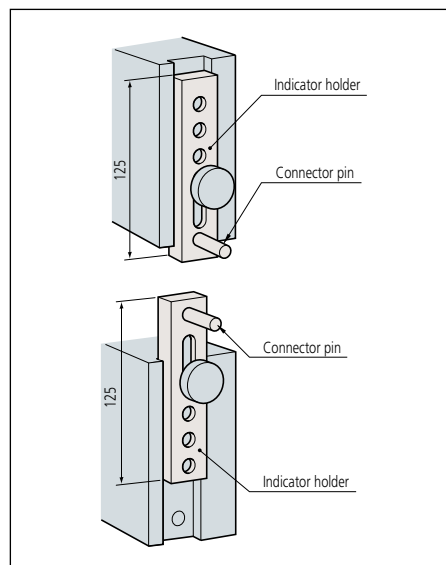

Precision Square

SERIES 916

FEATURES

- Three types of square are available.
- All edges are hardened and precision ground.

SPECIFICATIONS

Size (H x W)	Order No.	Remarks
50 x 40mm	916-211	Standard type
75 x 50mm	916-212	Standard type
100 x 70mm	916-213	Standard type
150 x 100mm	916-214	Standard type
200 x 130mm	916-215	Standard type
250 x 165mm	916-216	Standard type
300 x 200mm	916-217	Standard type
400 x 250mm	916-218	Standard type
75 x 50mm	916-401	with stand
100 x 70mm	916-402	with stand
150 x 100mm	916-403	with stand
200 x 130mm	916-404	with stand
250 x 165mm	916-405	with stand
300 x 200mm	916-406	with stand
400 x 250mm	916-407	with stand
50 x 40mm	916-100	Standard type
75 x 50mm	916-101	Standard type
100 x 70mm	916-102	Standard type
150 x 100mm	916-103	Standard type
200 x 130mm	916-104	Standard type



Technical Data

Squareness

	Outside	Inside
916-211	6μm	12.5μm
916-212	6.5μm	14μm
916-213	7μm	15μm
916-214	8μm	17.5μm
916-215	9μm	20μm
916-216	10μm	22.5μm
916-217	11μm	25μm
916-218	13μm	30μm
916-401	6.5μm	14μm
916-402	7μm	15μm
916-403	8μm	17.5μm
916-404	9μm	20μm
916-405	10μm	22.5μm
916-406	11μm	25μm
916-407	13μm	30μm
916-100	2.5μm	6μm
916-101	3μm	6.5μm
916-102	3μm	7μm
916-103	3.5μm	8μm
916-104	4μm	9μm

Precision Dial Square

SERIES 7

FEATURES

- Regular type and beveled-edge type blades are interchangeable.
- Dial indicator shows squareness directly.

SPECIFICATIONS

Size	Order No.	Range	Squareness
300mm	7911	±0.17mm	±2.5μm/300mm
600mm	7912	±0.24mm	±5μm/600mm

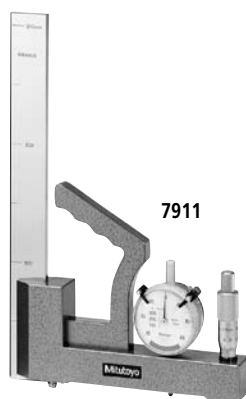

Technical Data

Range:	±0.17mm (7911) ±0.24mm (7912)
Squareness:	±2.5μm/300mm (7911) ±5μm/600mm (7912)

Combination Square Set

SERIES 180

Technical Data

Square head: Used to set the rule at 90 degrees or 45 degrees to an edge of a workpiece.
 Center head: Used to locate centers of round workpieces
 Protractor head: Used to set the rule at a desired angle to an edge of a workpiece. Also used for measuring angles.

FEATURES

- Three heads are attachable to the stainless steel rule (blade), allowing versatile measurements on various types of workpieces.
- The heads are hardened.
- Economy sets not including a protractor head are available.

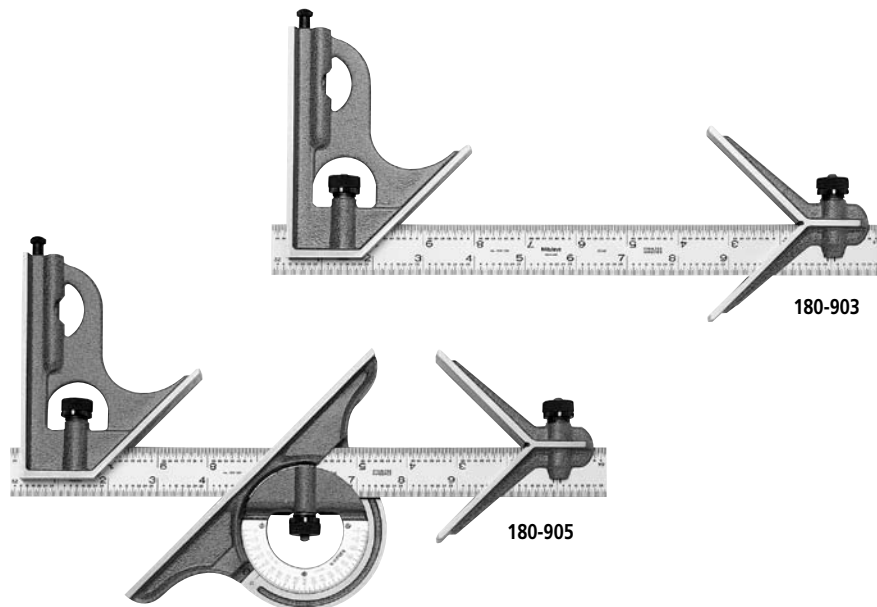

SPECIFICATIONS

Metric Combination Square Sets

Size	Order No.		Blade provided
	Complete	Semi-complete	
150mm	—	180-919	180-405
300mm	180-910	180-920	180-505

Inch/Metric Combination Square Sets

Size	Order No.		Blade provided
	Complete	Semi-complete	
6"/150mm	—	180-915	180-403
12"/300mm	180-907	180-909	180-503

Inch Combination Square Sets

Size	Order No.		Blade provided
	Complete	Semi-complete	
6"	—	180-901	180-401
6"	—	180-902	180-402
12"	180-905	180-903	180-501
12"	180-906	180-904	180-502

Blades (Individual)

Range	Order No.	Graduation
150mm	180-405	1mm, 0.5mm, 1mm, 0.5mm
300mm	180-505	1mm, 0.5mm, 1mm, 0.5mm
450mm	180-705	1mm, 0.5mm, 1mm, 0.5mm
600mm	180-605	1mm, 0.5mm, 1mm, 0.5mm
6"/150mm	180-403	1/32", 1/64", 1mm, 0.5mm
12"/300mm	180-503	1/32", 1/64", 1mm, 0.5mm
18"/450mm	180-703	1/32", 1/64", 1mm, 0.5mm
24"/600mm	180-603	1/32", 1/64", 1mm, 0.5mm
6"	180-401	1/8", 1/16", 1/32", 1/64"
6"	180-402	1/32", 1/50", 1/64", 1/100"
12"	180-501	1/8", 1/16", 1/32", 1/64"
12"	180-502	1/32", 1/50", 1/64", 1/100"
18"	180-701	1/8", 1/16", 1/32", 1/64"
18"	180-702	1/32", 1/50", 1/64", 1/100"
24"	180-601	1/8", 1/16", 1/32", 1/64"
24"	180-602	1/32", 1/50", 1/64", 1/100"

Heads (Individual)

Order No.	Description	Remarks
180-101	Square head	For 150mm (6") blades
180-102	Square head	For 300mm (12"), 450mm (18"), 600mm (24") blades
180-201	Center head	For 150mm (6") blades
180-202	Center head	For 300mm (12"), 450mm (18"), 600mm (24") blades
180-301	Protractor head	For 300mm (12"), 450mm (18"), 600mm (24") blades

Steel Rules

SERIES 182

FEATURES

- Clear graduations on satin-chrome finish.
- Stainless tempered.

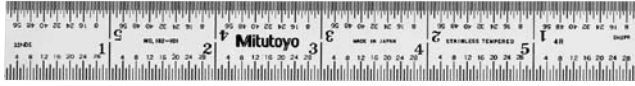

182-101



182-201



182-102



182-202



182-103



182-205



182-105



182-302

SPECIFICATIONS

Metric Wide Rigid Rules

Graduations	Range	Order No.	Width
1mm, 0.5mm (on both faces)	150mm	182-111	19mm
	300mm	182-131	25mm
	450mm	182-151	30mm
	600mm	182-171	30mm

Metric Fully-Flexible Rules

Graduations	Range	Order No.	Width
1mm, 0.5mm (on both faces)	150mm	182-211	12mm
	300mm	182-231	12mm
	450mm	182-251	18mm
	600mm	182-271	18mm

Inch/Metric Semi-Flexible Rules

Graduations*	Range	Order No.	Width
1/16", 1/32", 1/64", 1mm, 0.5mm	6"/150mm	182-302	.51"
	8"/200mm	182-303	.51"
	12"/300mm	182-305	.59"
	20"/500mm	182-307	.59"
	40"/1000mm	182-309	.59"

*Engraved on the front side only.

Inch/Metric Wide Rigid Rules

Graduations	Range	Order No.	Width
1/32", 1/64", 1mm, 0.5mm	6"/150mm	182-105	.75"
	12"/300mm	182-125	.98"
	18"/450mm	182-145	1.18"
	24"/600mm	182-165	1.18"
1/50", 1/100", 1mm, 0.5mm	6"/150mm	182-106	.75"
	12"/300mm	182-126	.98"
1/10", 1/100", 1mm, 0.5mm	6"/150mm	182-107	.75"
	6"/150mm	182-108	.75"

Inch/Metric Fully-Flexible Rules

Graduations	Range	Order No.	Width
1/32", 1/64", 1mm, 0.5mm	6"/150mm	182-205	.47"
	12"/300mm	182-225	.47"
	18"/450mm	182-245	.71"
	24"/600mm	182-265	.71"
1/50", 1/100", 1mm, 0.5mm	6"/150mm	182-206	.47"
	12"/300mm	182-226	.47"
1/10", 1/100", 1mm, 0.5mm	6"/150mm	182-207	.47"
	6"/150mm	182-208	.47"

Inch Wide Rigid Rules

Graduations	Range	Order No.	Width
1/8", 1/16", 1/32", 1/64"	6"	182-101	.75"
	12"	182-121	.98"
	18"	182-141	1.18"
	24"	182-161	1.18"
1/50", 1/100", 1/32", 1/64"	6"	182-102	.75"
	12"	182-122	.98"
	18"	182-142	1.18"
	24"	182-162	1.18"
1/10", 1/100", 1/32", 1/64"	6"	182-103	.75"
	12"	182-123	.98"
	18"	182-143	1.18"
	24"	182-163	1.18"
1/10", 1/50", 1/32", 1/64"	6"	182-104	.75"
	12"	182-124	.98"

Inch Fully-Flexible Rules

Graduations	Range	Order No.	Width
1/8", 1/16", 1/32", 1/64"	6"	182-201	.47"
	12"	182-221	.47"
	18"	182-241	.71"
	24"	182-261	.71"
1/50", 1/100", 1/32", 1/64"	6"	182-202	.47"
	12"	182-222	.47"
	18"	182-242	.71"
	24"	182-262	.71"
1/10", 1/100", 1/32", 1/64"	6"	182-203	.47"
	12"	182-223	.47"
	18"	182-243	.71"
	24"	182-263	.71"
1/10", 1/50", 1/32", 1/64"	6"	182-204	.47"
	12"	182-224	.47"

Thickness Gages

SERIES 184

FEATURES

- Metric thickness gages are available with tapered leaves.
- Each leaf is marked with its thickness.
- Each leaf is detachable if necessary.

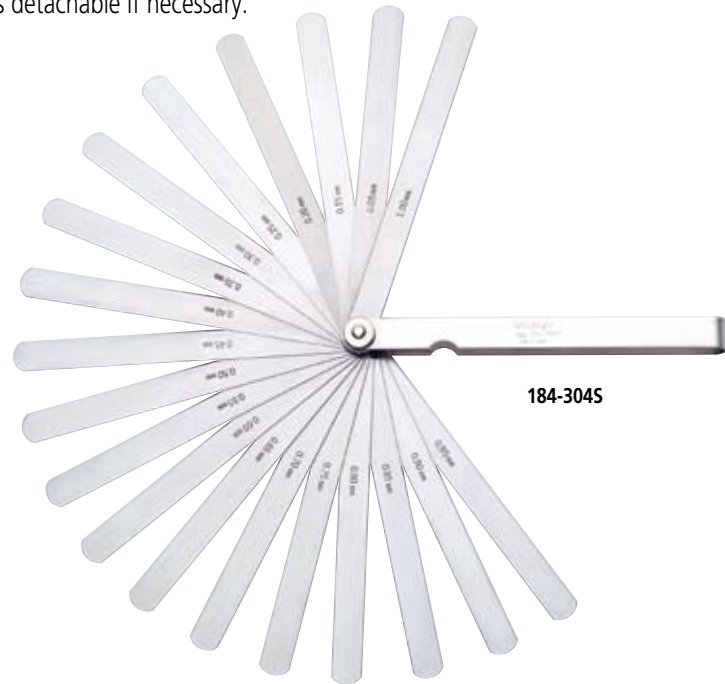

184-304S

SPECIFICATIONS

Metric

Range	Order No.	Composition of leaves	Remarks
0.05 - 1mm	184-313S	28 leaves: 0.05 - 0.15mm by 0.01mm, 0.2 - 1mm by 0.05mm	—
	184-303S	28 leaves: 0.05 - 0.15mm by 0.01mm, 0.2 - 1mm by 0.05mm	Long leaf
0.05 - 1mm	184-304S	20 leaves: 0.05 - 1mm by 0.05mm	Long leaf
0.05 - 1mm	184-305S	13 leaves: 0.05 - 0.3mm by 0.05mm, 0.4 - 1mm by 0.1mm	—
	184-301S	13 leaves: 0.05 - 0.3mm by 0.05mm, 0.4 - 1mm by 0.1mm	Long leaf
0.05 - 0.8mm	184-306S	10 leaves: 0.05 - 0.2mm by 0.05mm, 0.3 - 0.8mm by 0.1mm	—
	184-308S	10 leaves: 0.05 - 0.2mm by 0.05mm, 0.3 - 0.8mm by 0.1mm	Long leaf
0.03 - 0.5mm	184-307S	13 leaves: 0.03 - 0.1mm by 0.01mm, 0.2 - 0.5mm by 0.1mm, 0.15mm	—
	184-302S	13 leaves: 0.03 - 0.1mm by 0.01mm, 0.2 - 0.5mm by 0.1mm, 0.15mm	Long leaf

Radius Gages

SERIES 186

FEATURES

- Radius size is stamped on each gage leaf.
- Each leaf comprises an internal and an external radius gage of the same size.
- With locking clamp.

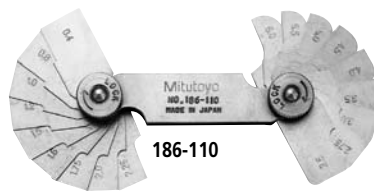
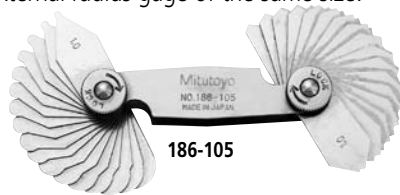

SPECIFICATIONS

Metric			
Range	Order No.	Composition of leaves	Remarks
0.4 - 6mm	186-110	18 leaves: 0.4, 0.8, 1, 1.2, 1.5, 1.6mm, 1.75 - 3mm by 0.25mm, 3.5 - 6mm by 0.5mm	90° arc
0.5 - 13mm	186-902	26 leaves: 0.5 - 13mm by 0.5mm	90° arc
1 - 7mm	186-105	34 leaves: 1 - 3mm by 0.25mm, 3.5 - 7mm by 0.5mm	180° arc
7.5 - 15mm	186-106	32 leaves: 7.5 - 15mm by 0.5mm	180° arc
15.5 - 25mm	186-107	30 leaves: 15.5 - 20mm by 0.5mm, 21 - 25mm by 1mm	180° arc

Inch			
Range	Order No.	Composition of leaves	Remarks
1/32" - 17/64"	186-103	16 leaves: 1/32" - 17/64" by 64ths	90° arc
1/32" - 1/4"	186-101	15 leaves: 1/32" - 1/4" by 64ths	180° arc
17/64" - 1/2"	186-102	16 leaves: 17/64" - 1/2" by 64ths	180° arc
9/32" - 33/64"	186-104	16 leaves: 9/32" - 33/64" by 64ths	90° arc
1/64" - 1/2"	186-901*	25 leaves: 1/64" - 17/64" by 64ths, 9/32" - 1/2" by 32nds	—

*Each gage has five measuring locations.

Thread Pitch Gages

SERIES 188

FEATURES

- Thread pitch is stamped on each gage.
- Metric, Unified, and Whitworth screw pitch gages.

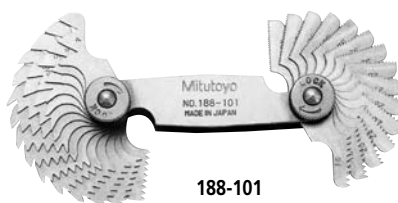

SPECIFICATIONS

Metric Screw Pitch Gages

Range	Order No.	Composition of leaves
0.35 - 6mm	188-130	22 leaves: 0.35, 0.4, 0.45, 0.5, 0.6, 0.7, 0.75, 0.8, 1, 1.25, 1.5, 1.75, 2, 2.5, 3, 3.5, 4, 4.5, 5, 5.5, 6mm and 60° angle gage
0.4 - 7mm	188-122	21 leaves: 0.4, 0.5, 0.7, 0.75, 0.8, 0.9, 1, 1.25, 1.5, 1.75, 2, 2.5, 3, 3.5, 4, 4.5, 5, 5.5, 6, 6.5, 7mm
0.4 - 7mm	188-121	18 leaves: 0.4, 0.5, 0.75, 1, 1.25, 1.5, 1.75, 2, 2.5, 3, 3.5, 4, 4.5, 5, 5.5, 6, 6.5, 7mm

Unified Screw Pitch Gages

Range	Order No.	Composition of leaves
4 - 42 TPI	188-111	30 leaves: 4, 4 1/2, 5, 5 1/2, 6, 7, 8, 9, 10, 11, 11 1/2, 12, 13, 14, 15, 16, 18, 20, 22, 24, 26, 27, 28, 30, 32, 34, 36, 38, 40, 42 TPI

Note: Metric and Unified Pitch Gage Set (**188-151**) is available. It consists of **188-122** (Metric) and **188-111** (Unified).

Metric and Unified Screw Pitch Gage Set

Range	Order No.	Composition of leaves
0.4 - 7mm/4 - 42 TPI	188-151	51 leaves: Set of 188-122 and 188-111

Whitworth Screw Pitch Gages

Range	Order No.	Composition of leaves
4 - 42 TPI	188-101	30 leaves: 4, 4 1/2, 5, 5 1/2, 6, 7, 8, 9, 10, 11, 11 1/2, 12, 13, 14, 15, 16, 18, 20, 22, 24, 26, 27, 28, 30, 32, 34, 36, 38, 40, 42 TPI
4 - 60 TPI	188-102	28 leaves: 4, 4 1/2, 5, 6, 7, 8, 9, 10, 11, 12, 13, 14, 16, 18, 19, 20, 22, 24, 25, 26, 28, 30, 32, 34, 36, 40, 48, 60 TPI

Digital Universal Protractor

SERIES 187

Technical Data

Range:	-360° to +360°
Tolerance:	±2" (±0.03°)
Repeatability:	1'
Resolution:	1' (0.01°)
Battery:	Lithium Battery
Battery life:	2,000 hours

Function

Presetting

FEATURES

- Data output function makes it easy to see statistical data.
- Can be attached to height gages using a gage holder (950750, metric)
- Setting preset value.
- Removable blade.

SPECIFICATIONS

Blade length	Order No.	Remarks (standard accessory)
150mm	187-501	Height gage holder (950750)
300mm	187-502	Height gage holder (950750)
6"	187-551	Height gage holder (950749)
12"	187-552	Height gage holder (950749)

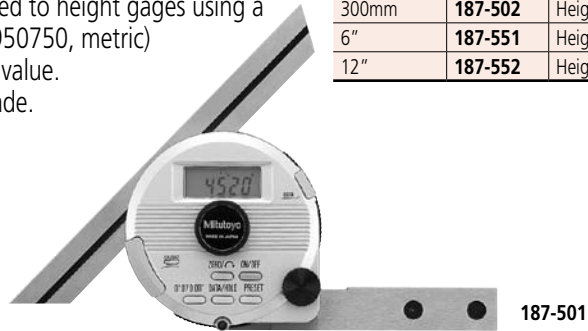

Technical Data

Graduation:	5 min. (0° - 90° - 0°)
Blade edge angle:	30°* 45° and 60°
	*187-901, 187-902 only



Universal Bevel Protractor

SERIES 187

FEATURES

- High-precision angle gage for accurate angle measurement of machines, molds, and jigs.
- Can be attached to height gages.

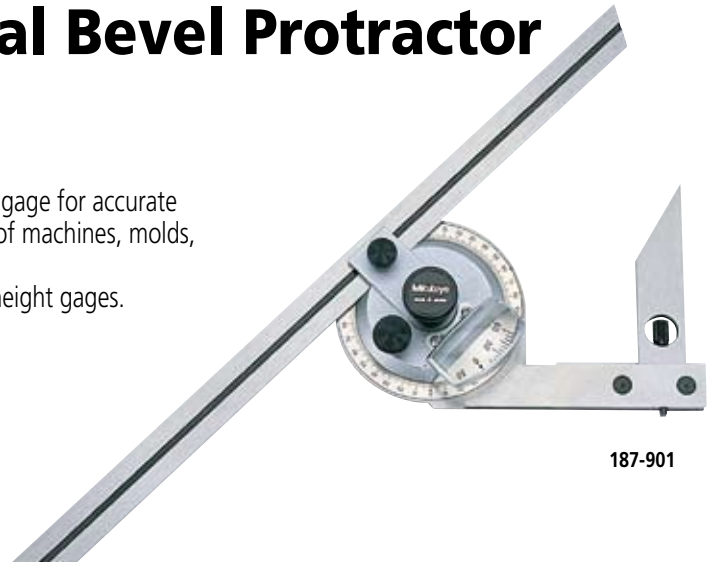

SPECIFICATIONS

Metric		
Blade length	Order No.	Remarks
150, 300mm	187-901	w/60°, 45°, 30° edges
150mm	187-907	w/60°, 45° edges
300mm	187-908	w/60°, 45° edges

Inch		
Blade length	Order No.	Remarks
6", 12"	187-902	w/60°, 45°, 30° edges
6"	187-904	w/60°, 45° edges
12"	187-906	w/60°, 45° edges

Bevel Protractor

SERIES 187

FEATURES

- Consists of three sheets of stainless steel, the middle one of which is made for angle measurements.

SPECIFICATIONS

Blade length	Order No.	Remarks
135mm	187-201	w/60°, 30° edges

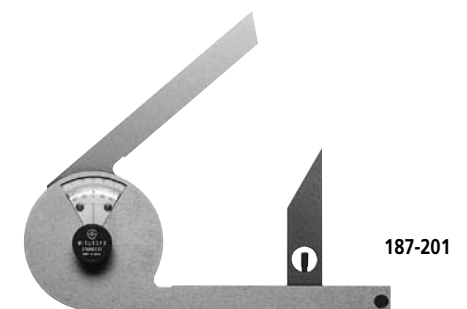

Technical Data

Graduation:	5 min. (0° - 90° - 0°)
Blade edge angle:	30° and 60°

Spring Dividers and Calipers

SERIES 950

FEATURES

- Spring Divider — Fully hardened and tempered joints, spring, washers and divider points.
- Outside Spring Caliper — Contact ends fully rounded to give good contact with a workpiece.
- Inside Spring Caliper — Ends fully rounded to give good contact with a workpiece.



950-211
Spring divider



950-221
Outside spring calipers



950-231
Inside spring calipers

SPECIFICATIONS

Range	Order No.		
	Spring divider	Outside spring calipers	Inside spring calipers
4" (100mm)	950-211	950-221	950-231
6" (150mm)	950-212	950-222	950-232
8" (200mm)	950-213	950-223	950-233

Precision Levels

SERIES 960

FEATURES

- High-precision longitudinal and transverse vials make it possible to check or level surfaces.

SPECIFICATIONS

Order No.	Sensitivity	Dimensions (W x D x H)
960-606	0.02mm/m	200 x 44 x 38.2mm
960-706	0.02mm/m	200 x 44 x 200mm

Technical Data

Accuracy of graduations: ± 0.7 DIV (**960-606**),
 ± 0.3 DIV (**960-706**)

960-606



960-706

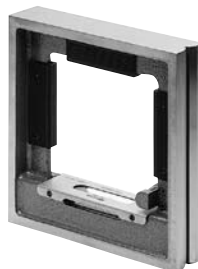

Bench Micrometer

SERIES 162

Technical Data

Micrometer head range: 25mm or 1"
Graduation: 0.001mm or .0001"
Dial indicator range: ± 0.1 mm or $\pm .005$ "
Maximum workpiece length: 100mm or 4"
Mass: 15kg

FEATURES

- 25mm/1" stroke micrometer head (Graduation: 0.001mm/.0001") is provided.
- Retractable anvil with dial indicator for high accuracy inspection of mass-produced parts.
- Anvil measuring force is variable.
- Adjustable workpiece stage height.
- Dial Indicator is shockproof.
- $\varnothing 8$ mm (or 3/8") stem probe from the Mitutoyo Mu-Checker can be attached for higher precision measurement if required.

Dimensions

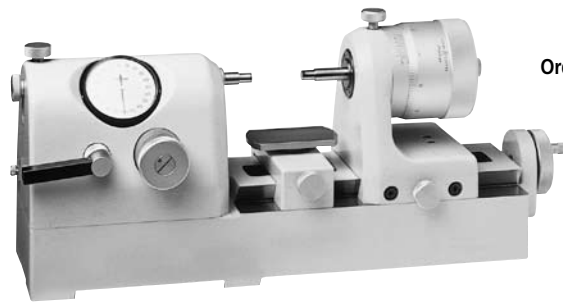
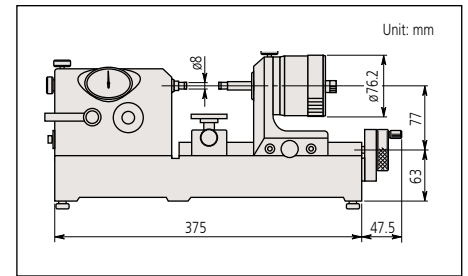

Order No.: 162-101 (metric)
162-102 (inch)

Bench Centers

SERIES 967

Technical Data

Maximum workpiece dia.: 300mm
Maximum workpiece height: 150mm
Mass: 13kg

FEATURES

- Used with a dial test indicator (optional), these Bench Centers provide precision measurement of concentricity on cylindrical workpieces.
- With an indicator clamp. (Holding stem diameter: 8mm)

Dimensions

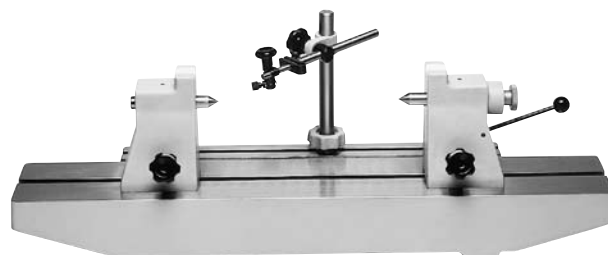
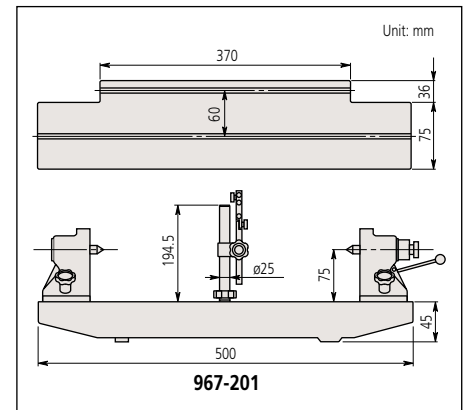

Order No.: 967-201

Black Granite Surface Plates

SERIES 517

FEATURES

- Natural granite seasoned for thousands of years is free from deterioration or dimensional change over time.
- Granite surface plates have many advantages over cast iron surface plates: Twice as hard as cast iron. Minimal change in dimensions due to temperature changes.
- Free from wringing, so there is no interruption of work.

- Free from burrs or protrusions because of the fine grain structure and insignificant stickiness; this ensures a high degree of flatness over a long service life and causes no damage workpieces or instruments.

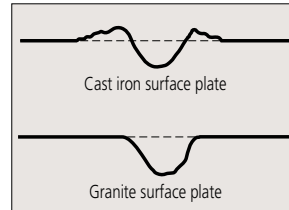

- Trouble-free operation for use with magnetic materials.
- Long life and rust-free, resulting in low maintenance costs.
- Steel stands are optional.



(Refer to page IX for details.)

1000 x 750mm



600 x 600mm



Dimensions

Unit: mm

W	D	H	w	d	Mass
300	300	100	240	240	27kg
450	300	100	390	240	40kg
600	450	100	500	370	80kg
600	600	130	500	500	140kg
750	500	130	630	420	146kg
1000	750	150	700	630	337kg
1000	1000	150	700	700	450kg
1500	1000	200	1100	700	900kg
2000	1000	250	1500	700	1500kg
2000	1500	300	1500	1100	2700kg
2000	2000	300	1500	1500	4200kg
3000	1500	400	2000	1100	5400kg
3000	2000	500	2000	1500	9000kg



Custom-made Granite Products

Mitutoyo can manufacture granite products to your design.

Mitutoyo provides products with a Certificate of Calibration and a traceability system diagram as required.

SPECIFICATIONS

Grade 00

Dimensions (W x D x H)	Order No.*	Flatness
300 x 300 x 100mm	517-401	0.002mm
450 x 300 x 100mm	517-411	0.002mm
600 x 450 x 100mm	517-414	0.0025mm
600 x 600 x 130mm	517-403	0.0025mm
750 x 500 x 130mm	517-405	0.003mm
1000 x 750 x 150mm	517-407	0.003mm
1000 x 1000 x 150mm	517-409	0.0035mm
1500 x 1000 x 200mm	517-413	0.004mm
2000 x 1000 x 250mm	517-410	0.0045mm
2000 x 1500 x 300mm	517-416	0.005mm
2000 x 2000 x 350mm	—	0.0055mm
3000 x 1500 x 400mm	—	0.0065mm
3000 x 2000 x 500mm	—	0.007mm

Grade 1

Dimensions (W x D x H)	Order No.*	Flatness
300 x 300 x 100mm	517-101	0.005mm
450 x 300 x 100mm	517-111	0.006mm
600 x 450 x 100mm	517-114	0.008mm
600 x 600 x 130mm	517-103	0.008mm
750 x 500 x 130mm	517-105	0.009mm
1000 x 750 x 150mm	517-107	0.012mm
1000 x 1000 x 150mm	517-109	0.013mm
1500 x 1000 x 200mm	517-113	0.016mm
2000 x 1000 x 250mm	517-110	0.019mm
2000 x 1500 x 300mm	517-116	0.020mm
2000 x 2000 x 350mm	517-117	0.022mm
3000 x 1500 x 400mm	517-118	0.025mm
3000 x 2000 x 500mm	517-119	0.027mm

Grade 0

Dimensions (W x D x H)	Order No.*	Flatness
300 x 300 x 100mm	517-301	0.003mm
450 x 300 x 100mm	517-311	0.003mm
600 x 450 x 100mm	517-314	0.004mm
600 x 600 x 130mm	517-303	0.005mm
750 x 500 x 130mm	517-305	0.005mm
1000 x 750 x 150mm	517-307	0.006mm
1000 x 1000 x 150mm	517-309	0.007mm
1500 x 1000 x 200mm	517-313	0.008mm
2000 x 1000 x 250mm	517-310	0.0095mm
2000 x 1500 x 300mm	517-316	0.010mm
2000 x 2000 x 350mm	—	0.011mm
3000 x 1500 x 400mm	—	0.0125mm
3000 x 2000 x 500mm	—	0.0135mm



Stand

SPECIFICATIONS: Stand

Applicable surface plate size (W x D x H)	Order No.*	Adjustable height (h) range	Remarks
300 x 300 x 100mm	—	—	—
450 x 300 x 100mm	—	—	—
600 x 450 x 100mm	517-203* / 203R / 203CR	755 - 775mm	With levelling bolt
600 x 600 x 130mm	517-204* / 204R / 204CR	755 - 775mm	With levelling bolt
750 x 500 x 130mm	517-205* / 205R / 205CR	755 - 775mm	With levelling bolt
1000 x 750 x 150mm	517-206* / 206R / 206CR	755 - 780mm	With levelling bolt
1000 x 1000 x 150mm	517-207* / 207R / 207CR	735 - 775mm	With levelling bolt
1500 x 1000 x 200mm	517-208* / 208R / 208CR	735 - 775mm	With levelling bolt
2000 x 1000 x 250mm	517-209* / 209R / 209CR	735 - 775mm	With levelling bolt
2000 x 1500 x 300mm	517-210* / 210R / 210CR	735 - 775mm	With levelling bolt
2000 x 2000 x 300mm	06AAY174	700 - 706mm	—
3000 x 1500 x 400mm	06AAY175	700 - 706mm	—
3000 x 2000 x 500mm	06AAY176	700 - 706mm	—

*Suffix "-4": Normal type, Suffix "R": with safety frame, Suffix "CR": with casters

