

# LINEAR GAGE

Catalog No. E13007(3)



Linear displacement sensors offer superb durability and environmental resistance, resistance to suit production line applications

**Mitutoyo**

# Features

## 1. A range of models available

The gage heads described offer five measuring ranges (5, 10, 25, 50 and 100mm) and six resolution settings (0.01, 0.005, 0.001, 0.0005, 0.0001 and 0.00001mm) to enable the choice of gage to be closely matched to the application requirements. Various output modes are also available, including differential square-wave, Digimatic code (SPC) and sine wave.

## 2. Suitable for production line use

The gage heads offer superb durability and environmental resistance, making them ideal for in-line measurements. Durability is ensured by strong construction and linear ball bearings in the slider unit (except for models LGS and LGB), which are designed to last up to 10 million vertical spindle strokes (according to Mitutoyo's internal tests). Moreover, excellent dust/water protection (IP66) is provided for effective use in severe in-line environments (model LGF and others).

## 3. High-density design

The slender design of the standard gages enables installation in confined spaces or where the application demands close-pitched gaging. Slim-line models with outside diameters of 8mm are also available for measurements in spaces of 10mm or less. Gages come in two different cable arrangements — vertical and horizontal — to suit the type of fixture used.

## 4. Simple mounting

All gages can be mounted by the plain section of the stem using the split-clamp method. Alternatively, some gages are threaded at the bottom and so can also be installed simply by drilling a hole of the appropriate size in a fixture and clamping the gage with a plain nut or by using a thrust stem (see page 33). Gages with a stem threaded at the top can be mounted using a thrust stem as an alternative to the split clamp.

## 5. A choice of output format

The gage head display units offer a range of output formats to best match the application requirements: I/O, BCD, RS-232C and Digimatic code (SPC) types are available. The EH/EV counter has an RS link function to be connected with multiple counters for multi-gage measurement (see page 36).



Suitable for in-line use



Suitable for close-pitched applications

## Measurement principle

The gage heads mainly use transmission-type photoelectric linear encoders, as shown below. In this type, the light source (LED) and the detector element (photodiode) face each other with the main scale and index scale (20µm pitch) positioned between them.

As the scale moves with respect to the detector, the intensity of the light passing

through the window in the index scale varies constantly. At this time, two synchronized sine-wave signals having a relative 90-degree phase difference are output. These signals are then amplified and split electrically (with additional waveforms inserted) and output as 0.1µm, 0.5µm, 1µm or 5µm square-wave signals.

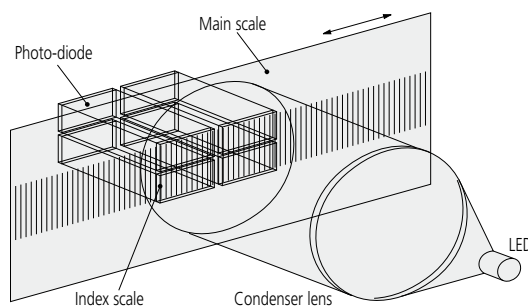

## Output

The gage head processes internally detected signals and outputs square-wave signals as shown below. These operating signals, which are square waves having a phase difference of 90 degrees, are equivalent to RS-422A signals, allowing for the independent use of the gage head. However, certain models (LGD and LGS), do not output square-wave signals but generate Digimatic code (SPC) output in order to identify the measurement position.

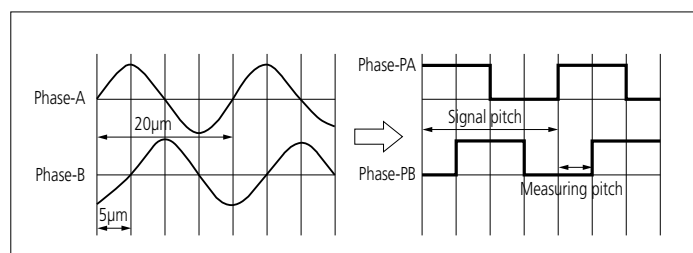

# Contents

Traceability System to National Standards		4 - 5
Applications		6 - 9
Gage Head Overview		10 - 12
Display Unit Overview		13
Gage Heads	LGK Slim Type	14
	LGF Standard Type	15
	LGF with Origin Point Mark	16
	LGF 0.1µm Resolution Type	17
	LGS Absolute Type	18
	LGD Absolute Type	19
	LGB Extremely Compact ø9.5mm Stem Type	20
	LGB Extremely Compact ø8mm Stem Type	21
	LG Long Stroke Type	22
	LGM Motor-drive, Long Stroke Type	23
	LGH High-resolution Type	24
	Litematic Head and Litematic	25
	Signal ID-C Absolute Type	26 - 27
	Output Signal Specifications	28 - 30
	Air Drive Unit	31
	Gage Head Mounting Fixtures	32 - 33
	Optional Accessories	34 - 36
Display Units	System Connection and Comparison of Counter Functions	37
	SENSORPAK	38
	EC Counter	39
	EG Counter	40 - 41
	EB Counter	42 - 45
	EH Counter	46 - 50
	D-EV Display Unit	50
	EV Counter	51 - 56
	Optional Accessories	57
	Quick Guide to Precision Measurement	58 - 61

# Traceability System to National Standards

## Traceability System of Length Standard

### Traceability of length field

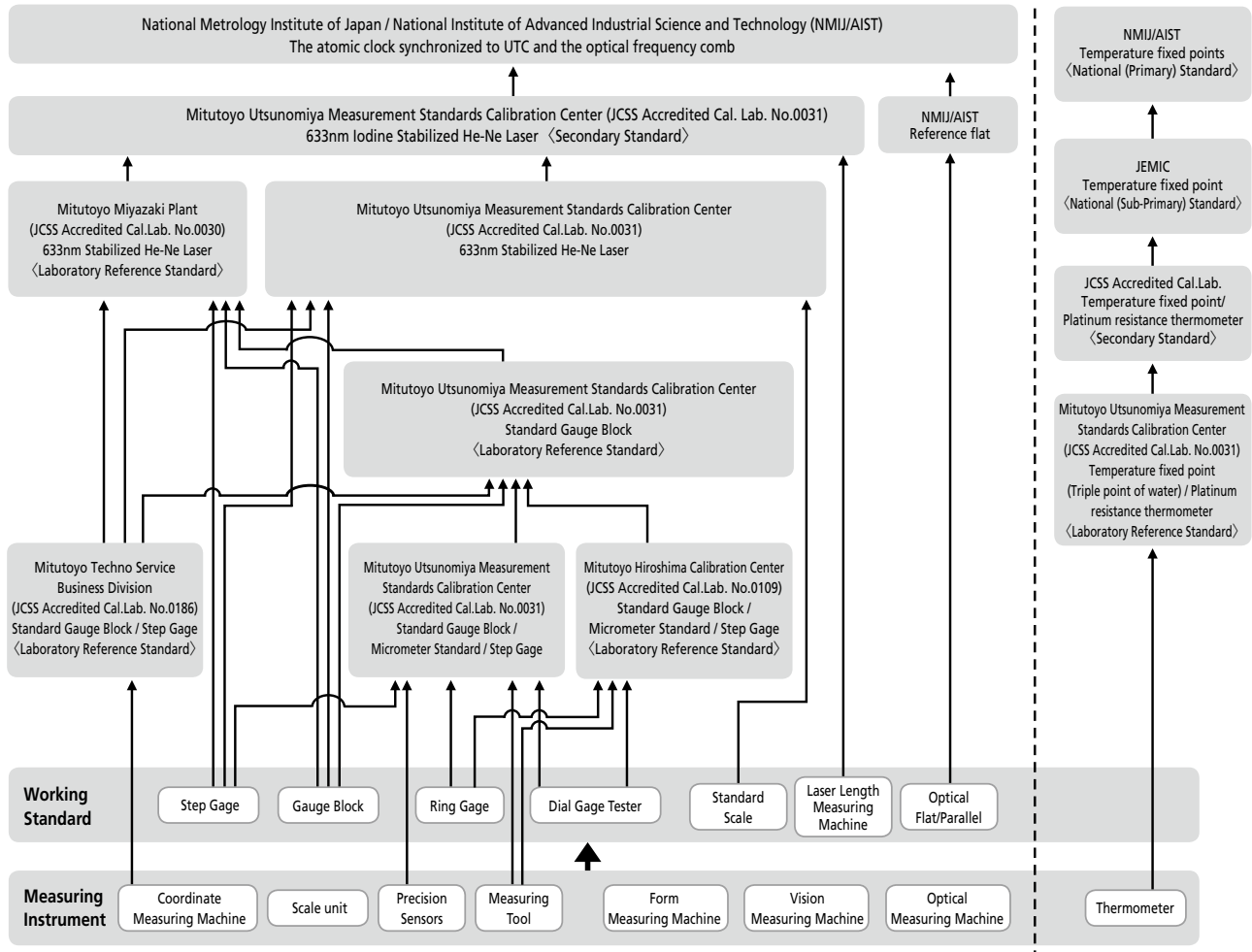

Note: This chart shows a simplified traceability system of Mitutoyo. Detailed traceability charts are published for each product.  
Information as of February 2016.

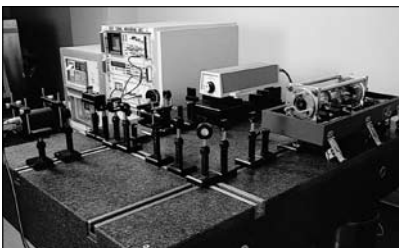

Iodine Absorption Stabilized He-Ne Laser used for calibrating length standards (Metrology Calibration Center)



Interferometer used for calibrating gauge blocks (Miyazaki Plant)

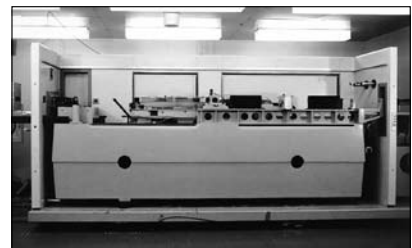

Interferometer used for calibrating linear scales (Metrology Calibration Center)

## Mitutoyo Group Accredited Calibration Laboratories

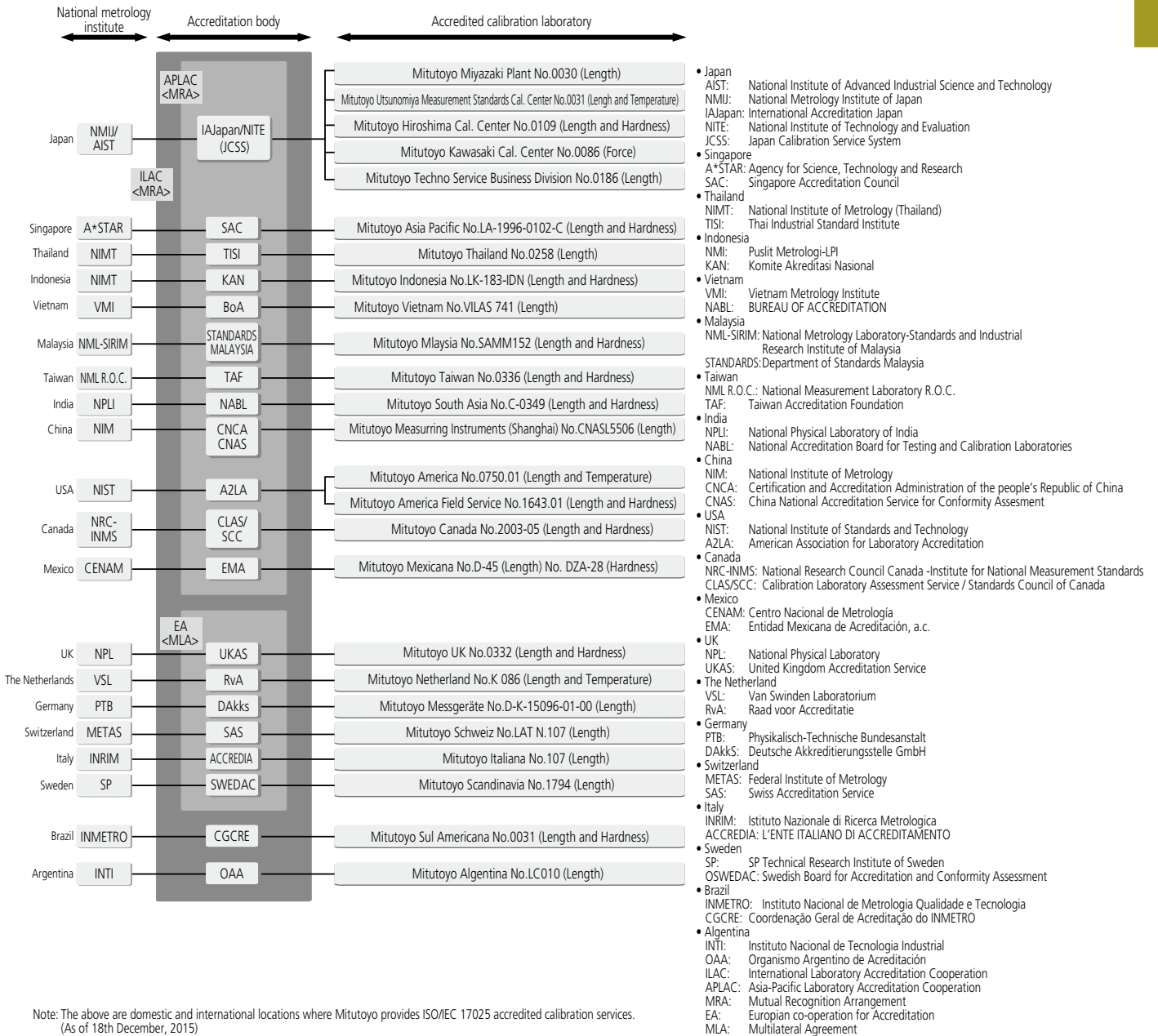

### Calibration laboratories worldwide

Mitutoyo has built a network for comprehensive support of calibration of precision measuring products in the global market. To provide calibration services on a global scale, Mitutoyo has calibration laboratories that have received ISO/IEC 17025 certification, an international standard, from accredited organizations in each of the countries in which Mitutoyo operates in Japan and abroad.

# Applications

## Multipoint measurement of automobile doors

Gage heads (LGS with EV counter) can be used to perform multi-point measurements for automobile doors and evaluate errors against the specified tolerances. When there are many points to measure, the use of the LGS gage provides higher cost-effectiveness.

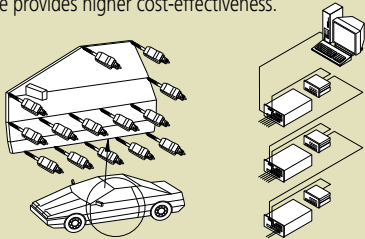

## Measurement of aircraft fuselage distortion

Gage heads (LGD with EV counter) can be used to help measure changes in stress generated in an aircraft fuselage. For the very large workpiece, the use of an absolute type gage head is recommended, since the master settings then need to be done just once.

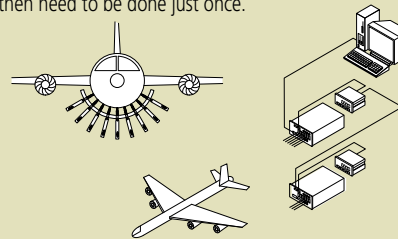

## Measurement of hydraulic coupling dimensions

Gage heads (LGF with EH counter) can be used to measure the outside diameters and thicknesses of hydraulic couplings used in mechanical diggers. The EH counter allows for the calculation of sums and differences between two gages.

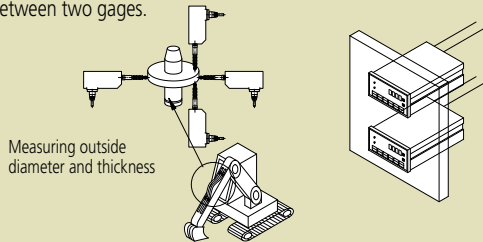

## Multipoint measurement of turbine blades

Gage heads (LGF with EV counter) can be used to perform multi-point measurements of gas turbine blades.

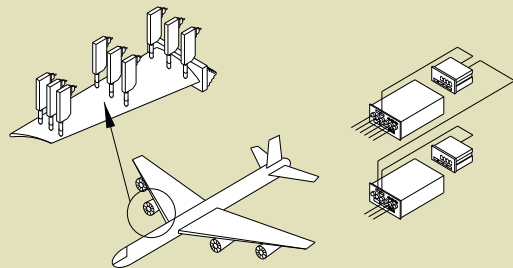

## Measurement of camshaft displacement

Gage heads (LGF with EH counter) can be used to measure camshaft lift. The EH counter is easily installed in the equipment panel.

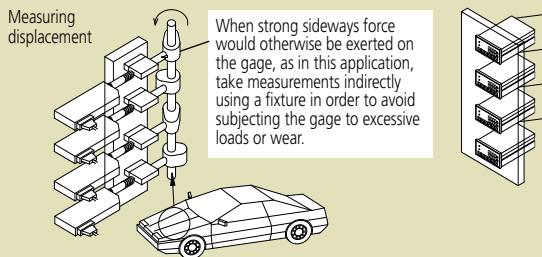

## Built-in sensor for inside diameter measurement tools

A gage head (LGF with EH counter) can be used to measure inside diameters.

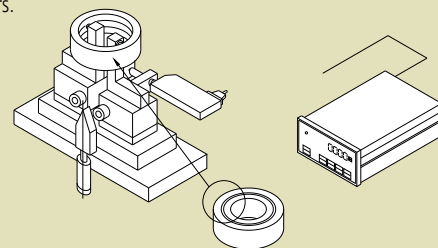

## Multipoint measurement of wheel hubs

Gage heads (LGF with EH counter) can be used to inspect a wheel hub for compliance with runout limits.

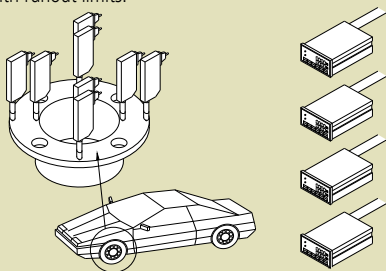

## Inspecting rivets

A gage head (LGD with EG counter) can be used to inspect the condition of fixing of a rivet or bolt. Inspection of parts press-fitted is also done in the same way.

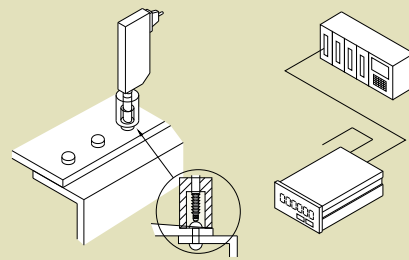

### Built-in sensor for machine tools

A gage head (LGM with EH counter) can be used to measure a workpiece which has been machined on a surface grinder.

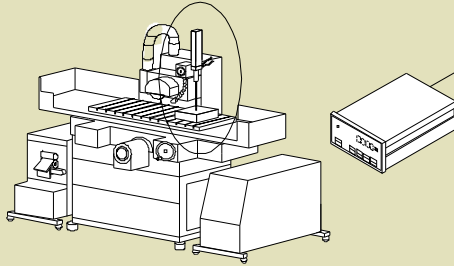

### Measurement of sash rail warp

Gage heads (LGF with EV counter) can be used to measure the warp of sash rails.

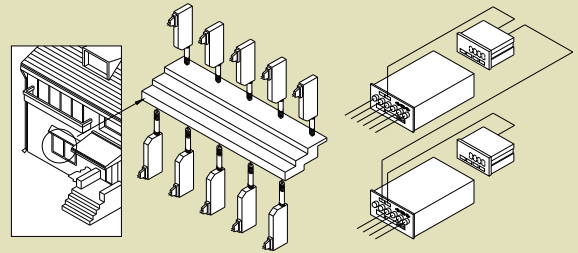

### Measurement of pipe wall thickness/outside diameter

A gage head (LGF with EH counter) can be used to measure the wall thickness or outside diameter of a pipe.

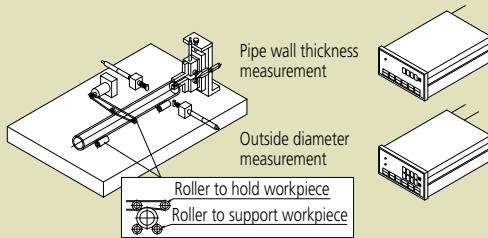

### Measurement of elevator drive-rail deflection

A gage head (LGF with EB counter) can be used to measure deflection in the drive rail of an elevator. Measured data can be output from the EB counter to a personal computer in order to plot the displacement.

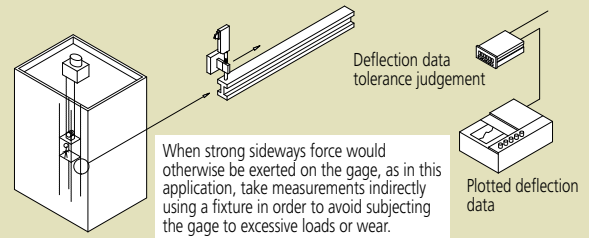

### Measurement of caulking height

A gage head (LGF with EB counter) can be used to measure the caulking height of a crimp contact, etc.

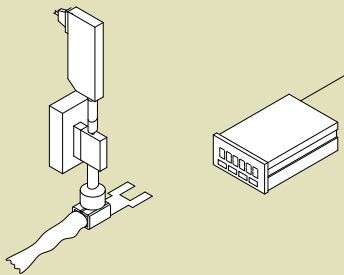

### Intake manifold flatness measurement

Flatness measurement of intake manifold can be performed by Linear Gage LGK-110 and EV Counter EV-16P. By connecting to the PC, Mitutoyo software SENORPAK can be used via RS-232C.

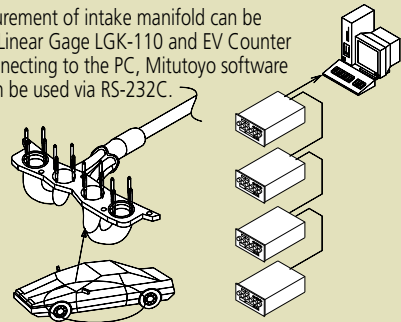

### Measurement of bridge-support joint

Gage heads (LGD with EG counter) can be used to measure the displacement of a bridge-support joint. Since this measurement is performed intermittently over a long period of time, use an absolute-type gage head that requires power only during measurement.

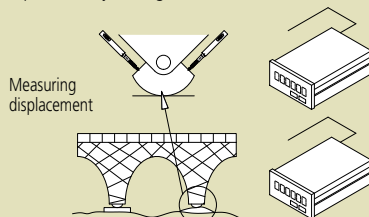

### Multipoint measurement on parabolic antenna

Gage heads (LGB with EV counter) can be used to perform multi-point measurements on a parabolic antenna surface.

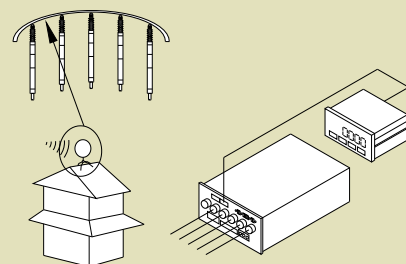

# Applications

## Screen mask multipoint measurement

Multi-point measurement of semiconductor related parts is performed with Linear Gage LGF-110L-B and EV counter EV-16P. By connecting to the PC, Mitutoyo software SENORPAK can be used via RS-232C.

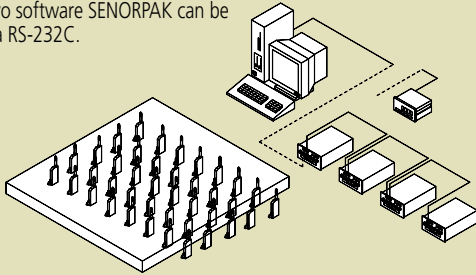

## Mobile terminal chassis multipoint measurement

Multiple point measurement of mobile terminal parts is performed with Linear Gage LGF-0510L-B and EV counter EV-16P.

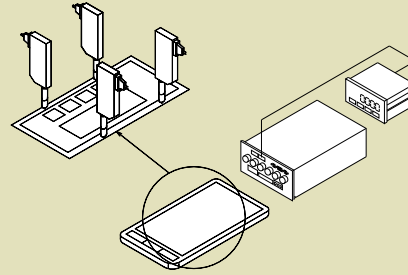

## Height and thickness measurement model

Indirect measurement is recommended for the workpiece, which is better not to contact with the Linear Gage (e.g. workpiece which rotates or slides, difficult to measure with a standard contact point).

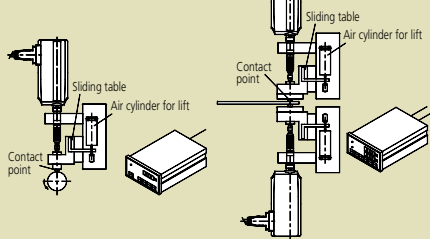

## Waterworks parts multipoint measurement

Displacement of water related parts measurement is performed with Linear Gage LGS-1012P and EV counter EV-16D. By connecting to the PC, Mitutoyo software SENORPAK can be used via RS-232C.

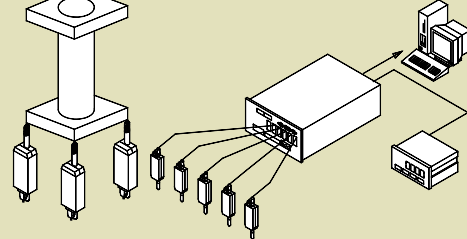

## Parallelism measurement of copying machine parts

Gage heads (LGD with EV counter) can be used to measure the parallelism of copying machine parts.

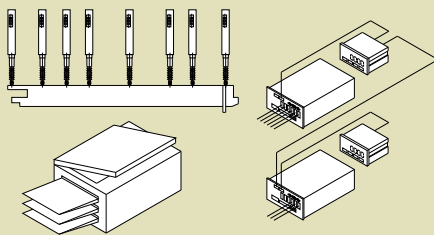

## Multipoint measurement on copying machine chassis

Gage heads (LGS with EV counter) can be used to perform multi-point measurement on a copying machine chassis. In the case of large workpieces an absolute type that eliminates the necessity of setting a master workpiece will be useful.

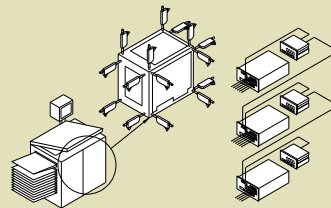

## Run-out measurement of motor shaft

Gage heads (LGF with EH counter) can be used to measure the radial and axial run-out of motor shafts. The EH counter can display both measurements simultaneously.

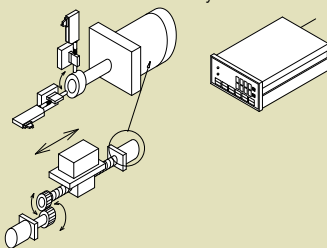

When strong sideways force would otherwise be exerted on the gage, as in this application, take measurements indirectly using a fixture in order to avoid subjecting the gage to excessive loads or wear.

## Sorting of parts

A gage head (LGF with EB counter) can be used to sort parts by size. The EB counter can divide the dimension into seven steps and output the signal for sorting.

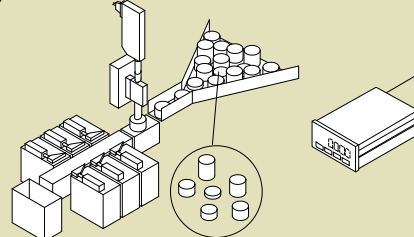



### Multipoint measurement of LCD panel

Gage heads (LGF with EH counter) can be used to measure distortion of LCD panels.

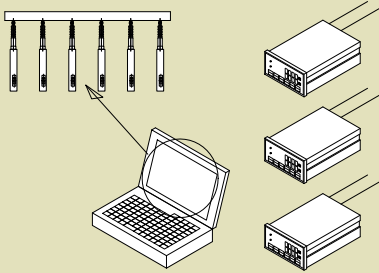

### X-Y stage positioning

Gage heads (LGF with EH counter) can be used to position a precision stage.

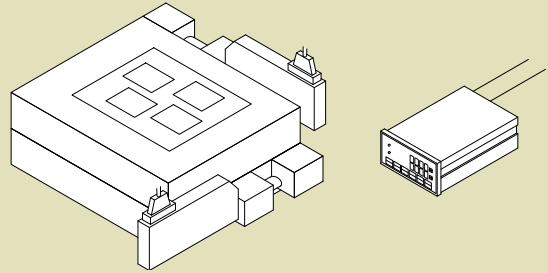

### Height measurement of cell

A gage head (LGF with EH counter) can be used to measure the height of built-in dry cells.

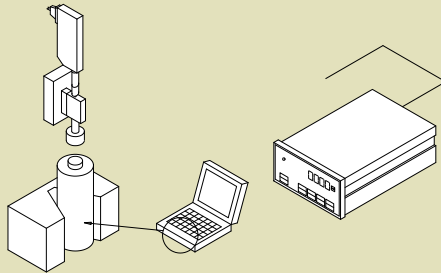

### Built-in sensor for material testing machines

A gage head (LGF with EH counter) can be used to measure the extension of a specimen during a tensile test.

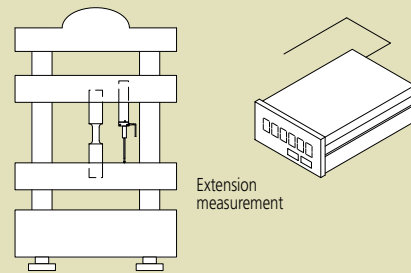

### Deformation measurement of bathtub

Gage heads (LGF with EV counter) can be used to measure the deformation of bathtubs. An origin setting when first mounting the gage head can eliminate the need for subsequent resetting with a standard.

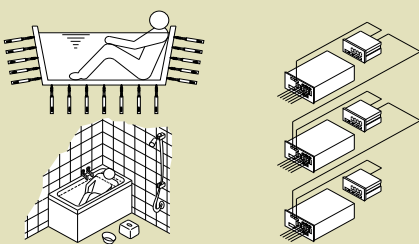

### Incorporation into auto-measurement machine

Gage heads (LGF with EH counter) can be incorporated into the auto-measurement unit for outside diameter and/or height measurement.

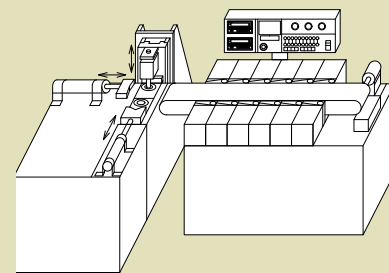

### Built-in sensor for tablet forming machine

A gage head (LGF with EH counter) can be used to measure the stroke of a tablet forming machine.

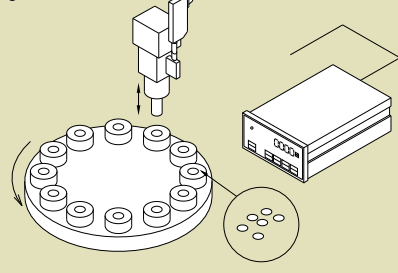

### Incorporation into vision measuring machine / microscope

A gage head (LGF with EH counter) can be incorporated into a measuring machine for height measurement.

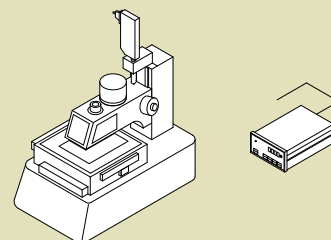

# Gage Head Overview

## Laser Hologage

- 0.01µm resolution
- Sine wave output
- ø15mm plain stem

Compatible display unit

EH-102S

Range: 10mm / .4"

Page 24

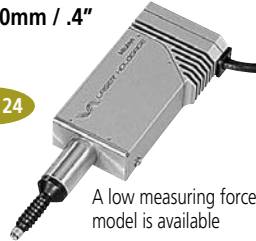

A low measuring force model is available

## LGH series

- 0.01µm resolution
- ø15mm plain stem

Compatible display unit

Exclusive Counter

Range: 10mm / .4"

Page 24



## LGB series

- 0.1µm resolution
- Square wave output
- ø9.5mm stem

Compatible display unit

EG-101P EB-11P

EH-101P EH-102P

EV-16P

Range: 5mm / .2"

Page 20



## LGB series

- 1µm resolution
- Square wave output
- ø9.5 / ø8mm stem

Compatible display unit

EG-101P EB-11P

EH-101P EH-102P

EV-16P

Range: 5mm / .2"

Page 20



ø9.5mm stem  
With stem clamp nut

Page 21



ø8mm stem

## LGB series

- 1µm resolution
- Square wave output
- ø9.5 / ø8mm stem

Compatible display unit

EG-101P EB-11P

EH-101P EH-102P

EV-16P

Range: 10mm / .4"

Page 20



ø9.5mm stem  
With stem clamp nut

Page 21



ø8mm stem

Page 20



ø9.5mm stem  
With stem clamp nut

With pneumatic cylinder

Page 21



ø8mm stem

## L GK series

- 0.1 / 0.5 / 1µm resolution
- Square wave output
- ø8mm stem

Compatible display unit

EG-101P EB-11P

EH-101P EH-102P

EV-16P

Range: 10mm / .4"

Page 14



0.1µm / 4µinch

Page 14



0.5µm / .00002"

Page 14



1µm / .00004"

## LG series

- 0.1 / 1µm resolution
- Square wave output
- ø20mm stem

Range: 100mm / 4"

Page 22

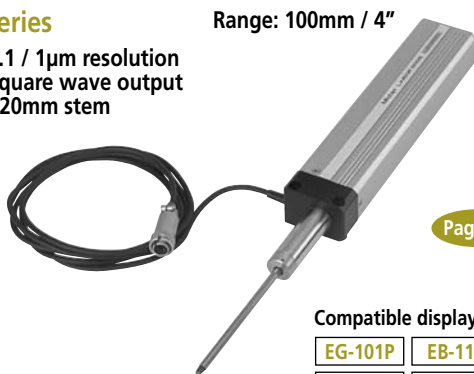

Compatible display unit

EG-101P EB-11P

EH-101P EH-102P

EV-16P

## LGM series

- 0.1 / 1µm resolution
- Square wave output
- ø20mm stem
- Motor-drive operation

Range: 100mm / 4"

Page 23

Motor-drive unit

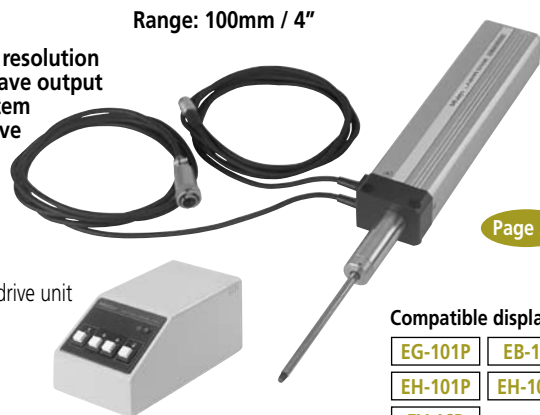

Compatible display unit

EG-101P EB-11P

EH-101P EH-102P

EV-16P

**LGF series**

- 0.5 / 1µm resolution
- Square wave output
- ø8mm / ø15mm stem

Compatible display unit

- |         |         |
|---------|---------|
| EG-101P | EB-11P  |
| EH-101P | EH-102P |
| EV-16P  |         |

Range: 10mm / .4"

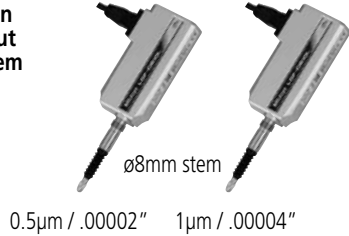

Page 15

Range: 25mm / 1"

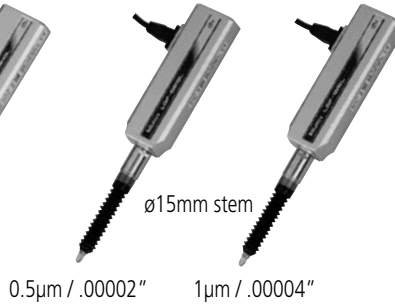

Page 15

Range: 50mm / 2"

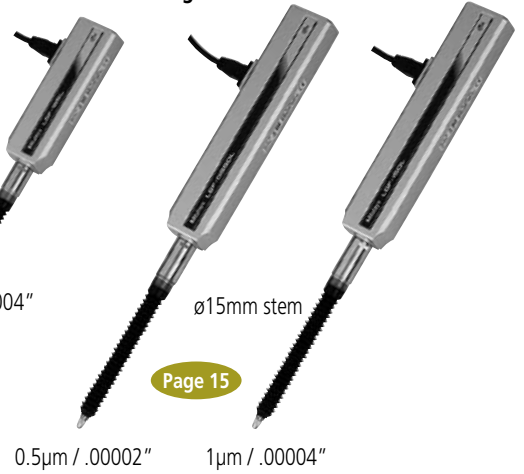

Page 15

**LGF series**

- 0.5 / 1µm resolution
- Square wave output
- ø8mm / ø15mm stem
- With origin point mark

Compatible display unit

- |         |        |
|---------|--------|
| EG-101Z | EB-11Z |
| EH-102Z | EV-16Z |

Range: 10mm / .4"

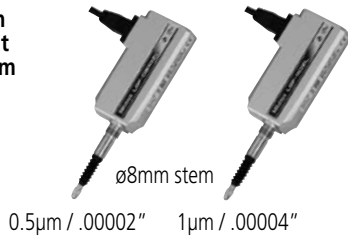

Page 16

Range: 25mm / 1"

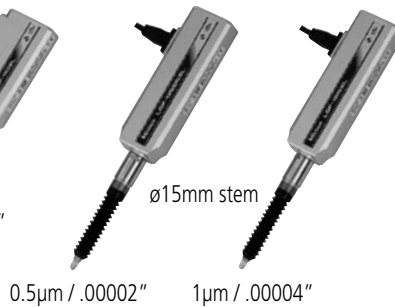

Page 16

Range: 50mm / 2"



Page 16

**LGF series**

- 0.1µm resolution
- Square wave output
- ø8mm / ø15mm stem

Compatible display unit

- |         |         |
|---------|---------|
| EG-101P | EB-11P  |
| EH-101P | EH-102P |
| EV-16P  |         |

Range: 10mm / .4"



Page 17

Range: 25mm / 1"



Page 17

0.5µm / .00002" 1µm / .00004"

**LGF series**

- 5µm resolution
- Square wave output
- ø15mm stem

Compatible display unit

- |         |         |
|---------|---------|
| EG-101P | EB-11P  |
| EH-101P | EH-102P |
| EV-16P  |         |

Range: 25mm / 1"



Page 15

Range: 50mm / 2"



Page 15

# Gage Head Overview

## LGD series

- 0.01mm resolution
- Digimatic output
- Absolute linear encoder
- ø8mm / ø15mm stem

Compatible display unit

- EC-101D
- EG-101D
- EB-11D
- EH-102D
- EV-16D

Range: 10mm / .4"

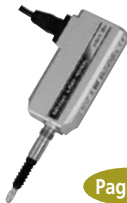

ø8mm stem

Page 19

Range: 25mm / 1"



ø15mm stem

Page 19

Range: 50mm / 2"



ø15mm stem

Page 19

## LGS series

- 0.01mm resolution
- Digimatic output
- Absolute linear encoder
- ø8mm stem

Compatible display unit

- EC-101D
- EG-101D
- EB-11D
- EH-102D
- EV-16D

Range: 12.7mm / .5"



Page 18

## Signal ID-C

- 0.001mm resolution
- Digimatic output
- Absolute linear encoder
- ø8mm stem

Compatible display unit

- EC-101D
- EG-101D
- EB-11D
- EH-102D
- EV-16D

Range: 12.7mm / .5"



Page 26

# System Connections

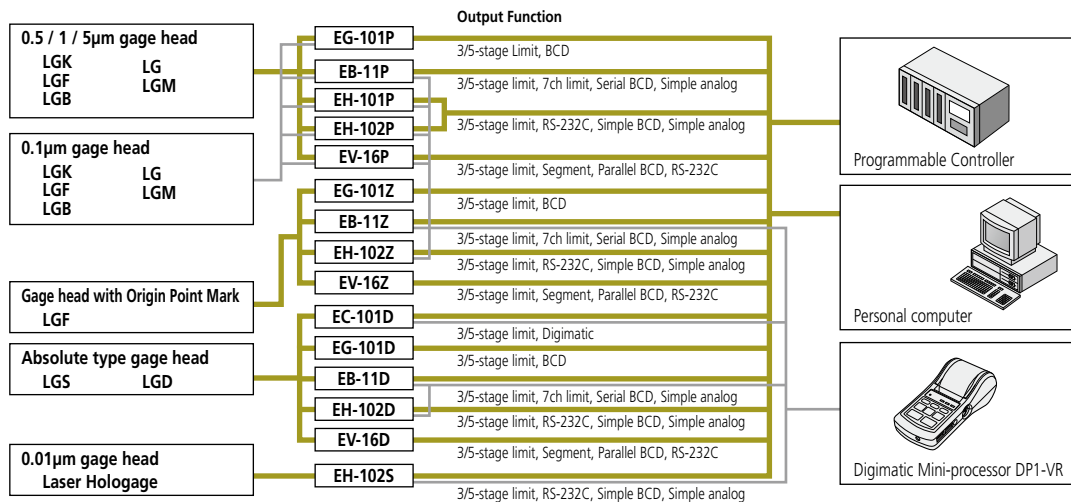

# Display Unit Overview

## EC counter

Single function type

Page 39

For Digimatic output gage heads



EC-101D

## EG counter

Single function type

Page 40

For Digimatic output gage heads



EG-101D

For square wave output gage heads



EG-101P

For square wave output gage heads with origin point mark



EG-101Z

## EB counter

Multi-function type

Page 42

For Digimatic output gage heads



EB-11D

For square wave output gage heads



EB-11P

For square wave output gage heads with origin point mark



EB-11Z

## EH counter

Multi-function type

Page 46

For Digimatic output gage heads



EH-102D

For square wave output gage heads (1-axis / 2-axis)



EH-101P

For square wave output gage heads with origin point mark



EH-102Z



EH-102P

For Sine wave output gage heads



EH-102S

## EV counter

Multi-function type for multi-gage system

Page 51

For Digimatic output gage heads



EV-16D

For square wave output gage heads



EV-16P

For square wave output gage heads with origin point mark



EV-16Z

Gage Heads

# LGK Slim Type



10mm range, 0.1 / 0.5 / 1µm resolution, Differential square-wave output

## FEATURES

- A slim-body model which has succeeded the proven LGF series in terms of vibration- and impact-resistance. The sectional area is only a 1/5 compared to that of the LGF-110L model.
- Provides a resolution of 0.1 / 0.5 / 1µm, whichever is selectable.

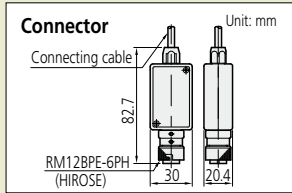

## Dimensions

Unit: mm

542-158: 0.1µm resolution model

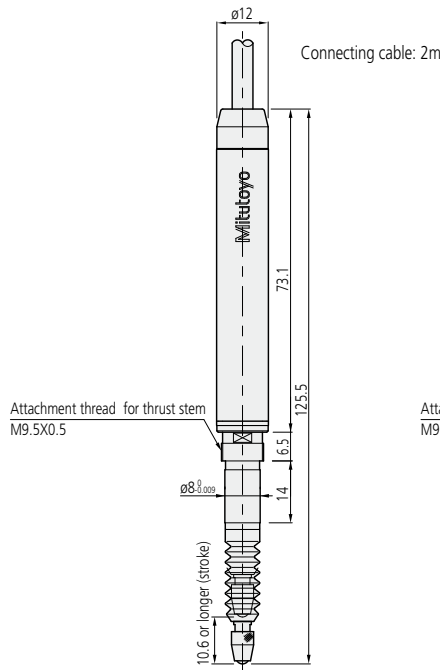

542-157: 0.5µm resolution model

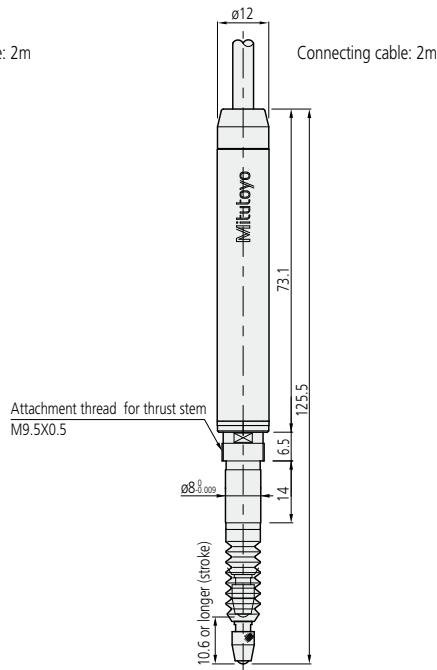

542-156: 1µm resolution model

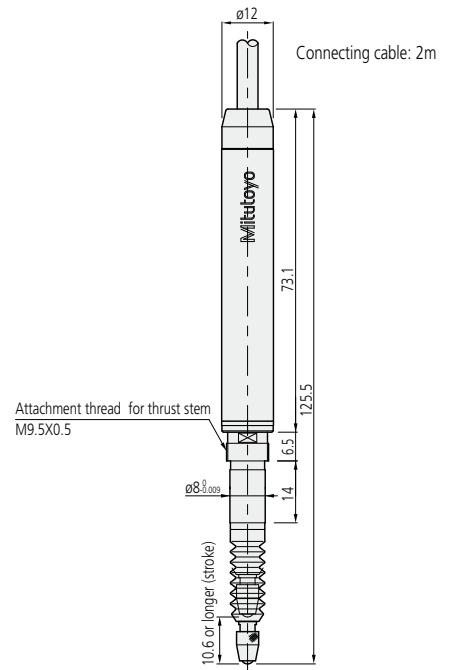

## SPECIFICATIONS

Order No.	542-158	542-157	542-156
Measuring range		10mm (.4")	
Resolution	0.1µm	0.5µm	1µm
Measuring accuracy (20°C)	(0.8+L/50) µm (L=mm)	(1.5+L/50) µm (L=mm)	
Quantizing error	±1 count		
Measuring force	Contact point upwards	0.7N or less	
	Contact point horizontal	0.75N or less	
	Contact point downwards	0.8N or less	
Position detection method	Photoelectric linear encode*3		
Response speed*1	400mm/s	1500mm/s	
Output signal	90° phase difference, differential square wave (RS-422A equivalent), minimum edge intervals: 200ns for 0.1µm model, 200ns for 0.5µm model, 500ns for 1µm model		
Output signal pitch	0.4µm	2µm	4µm
Mass	Approx. 175g		
Dust/water resistance*2	Equivalent to IP66 (only gage head)		
Contact point	ø3mm carbide-tipped (fixing screw: M2.5 (P=0.45)×5), standard contact point No.901312		
Stem dia.	ø8mm		
Bearing type	Linear ball bearing*4		
Output cable length	2m (directly from casing)		
Connector	Plug: RM12BPE-6PH (HIROSE), Compatible receptacle: RM12BRD-6S (HIROSE)		
Operating temperature (humidity) range	0 to 40°C (RH 20 to 80%, no condensation)		
Storage temperature (humidity) range	-10 to 60°C (RH 20 to 80%, no condensation)		
Standard Accessories	Wrench for contact point: No.538610		
Remarks	Gold banded	Blue banded	Green banded

\*1: When the spindle speed exceeds 1500mm/s (400mm/s for 0.1µm model), an alarm signal will be output. Also, if using Mitutoyo counter, an error message will be displayed. If using counters made by other companies, please inquire separately for the alarm signals. For the models of 0.1µm resolution, note that over-speed error may occur depending on the impact amount when releasing the contact point freely.

\*2: IP Code is a standard which classifies and rates the degree of protection provided against the intrusion of solid objects and water. This may not be applicable depending on the kind of liquid.

\*3: Patent registered (Japan, U.S.A., Germany, U.K.)

\*4: Patent registered (Japan)

## Optional Accessories

- Air lifter 10: **No.02ADE230**
- \* Required air pressure: 0.2 to 0.4MPa
- \* Spindle extends when air is supplied
- Rubber boot: **No.238772** (spare)
- Thrust stem set: **No.02ADB680**
- Thrust stem: **No.02ADB681**
- Clamp nut: **No.02ADB682**
- Spanner Wrench: **No.02ADB683**
- \* A thrust stem set is a combination of thrust stem and a clamp nut. A special spanner is required for tightening. If using multiple gages, a thrust stem set for each gage and one special spanner are required.



Gage Heads

# LGF Standard Type



10 / 25 / 50mm range, 0.5 / 1 / 5µm resolution, Differential square-wave output

## FEATURES

- Excellent protection against dust ingress and water splash (IP66) in harsh shop-floor environments.
- Uses linear stroke ball bearings on the spindle movement for resistance to external shock and vibration.
- Thrust Stem with a clamp nut is optional.

Connector

Unit: mm

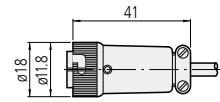

## Dimensions

Unit: mm

**542-171:** 0.5µm resolution, 10mm range model  
**542-161:** 1µm resolution, 10mm range model

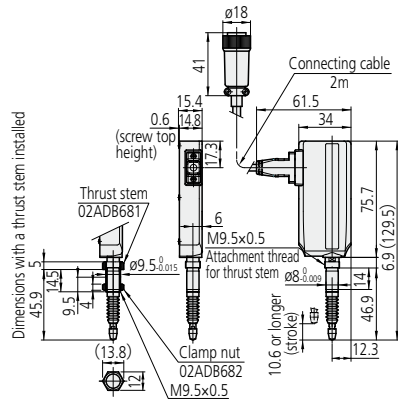

**542-172:** 0.5µm resolution, 25mm range model  
**542-162:** 1µm resolution, 25mm range model  
**542-612:** 5µm resolution, 25mm range model

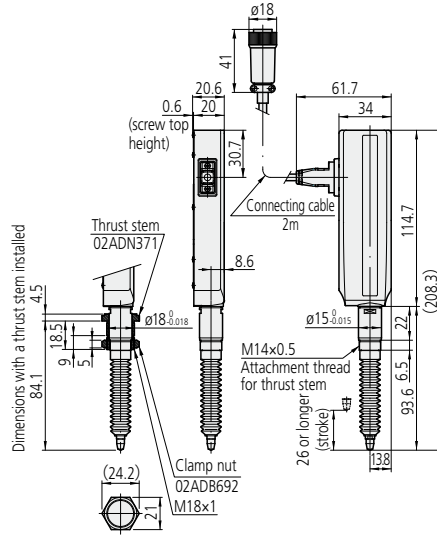

**542-173:** 0.5µm resolution, 50mm range model  
**542-163:** 1µm resolution, 50mm range model  
**542-613:** 5µm resolution, 50mm range model

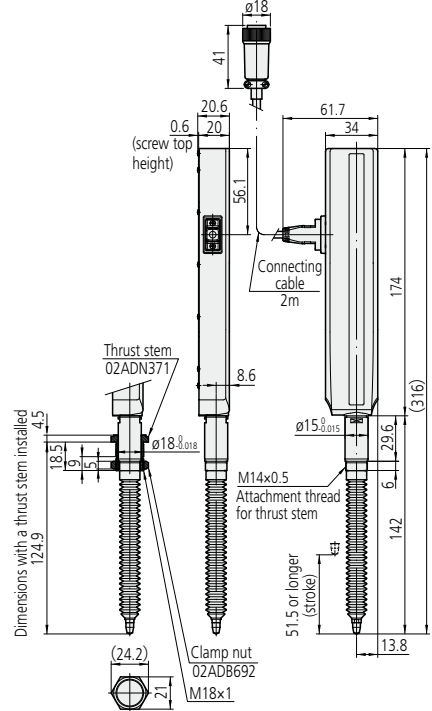

## SPECIFICATIONS

Order No.	542-171	542-161	542-172	542-162	542-612	542-173	542-163	542-613
Measuring range	10mm (.4")			25mm (1")				50mm (2")
Resolution	0.5µm	1µm	0.5µm	1µm	5µm	0.5µm	1µm	5µm
Measuring accuracy (20°C) L=arbitrary measuring length (mm)	(1.5+L/50) µm				(7.5+L/50) µm	(1.5+L/50) µm		(7.5+L/50) µm
Quantizing error	±1 count							
Measuring force	Contact point upwards	1.0N or less		4.0N or less				4.9N or less
	Contact point horizontal	1.1N or less		4.3N or less				5.3N or less
	Contact point downwards	1.2N or less		4.6N or less				5.7N or less
Position detection method	Photoelectric linear encoder*3							
Response speed*1	1500mm/s							
Output	90° phase difference, differential square wave (RS-422A equivalent), minimum edge intervals: 1000ns for 5µm model, 500ns for 1µm model, 250ns for 0.5µm model							
Output square wave pitch	2µm	4µm	2µm	4µm	20µm	2µm	4µm	20µm
Mass	Approx. 260g		Approx. 300g			Approx. 400g		
Dust/water resistance	Equivalent to IP66 (only gage head)							
Contact point	ø3mm carbide-tipped (fixing screw: M2.5 (P=0.45)×5), standard contact point No.901312							
Stem dia.	ø8mm		ø15mm					
Bearing type	Linear ball bearing*4							
Output cable length	2m (directly from casing)							
Connector	Plug: RM12BPE-6PH (HIROSE), Compatible receptacle: RM12BRD-6S (HIROSE)							
Operating temperature (humidity) range	0 to 40°C (RH 20 to 80%, no condensation)							
Storage temperature (humidity) range	-10 to 60°C (RH 20 to 80%, no condensation)							
Standard Accessories	Wrench for contact point: No.538610		Wrench for contact point: No.210187					

## Optional Accessories

- Air drive unit  
 For 10mm range models: **No.02ADE230**  
 For 25mm range models: **No.02ADE250**  
 For 50mm range models: **No.02ADE270**  
 \* Required air pressure: 0.2 to 0.4MPa  
 \* Spindle extends when air is supplied.
- Rubber boot (spare)  
 For 10mm range models: **No.238772**  
 For 25mm range models: **No.962504**  
 For 50mm range models: **No.962505**
- Thrust stem set  
 For 10mm range models: **No.02ADB680**  
 Thrust stem: **No.02ADB681**  
 Clamp nut: **No.02ADB682**  
 For 25/50mm range models: **No.02ADN370**  
 Thrust stem: **No.02ADN371**  
 Clamp nut: **No.02ADB692**
- \* External dimensions are described in the dimensional drawing of the product.
- \* A thrust stem set is a combination of thrust stem and a clamp nut.  
 A special spanner is required for tightening. If using multiple gages, a thrust stem set for each gage and one special spanner are required.
- Spanner Wrench  
 For 10mm range models: **No.02ADB683**  
 For 25/50mm range models: **No.02ADB693**

\*1: When the spindle speed exceeds 1500mm/s (400mm/s for 0.1µm model), an alarm signal will be output. Also, if using Mitutoyo counter, an error message will be displayed. If using counters made by other companies, please inquire separately for the alarm signals. For the models of 0.1µm resolution, note that over-speed error may occur depending on the impact amount when releasing the contact point freely.

\*2: IP Code is a standard which classifies and rates the degree of protection provided against the intrusion of solid objects and water. This may not be applicable depending on the kind of liquid.

\*3: Patent registered (Japan, U.S.A., Germany, U.K.)

\*4: Patent registered (Japan)





Gage Heads

# LGF 0.1µm Resolution Type

IP66

10 / 25mm range, 0.1µm resolution, Differential square-wave output

## FEATURES

- Excellent protection against dust ingress and water splash (IP66) in harsh shop-floor environments.
- Uses linear stroke ball bearings on the spindle movement for resistance to external shock and vibration.
- Thrust Stem with clamp nut is optional.

Connector

Unit: mm

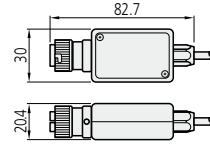

## Dimensions

Unit: mm

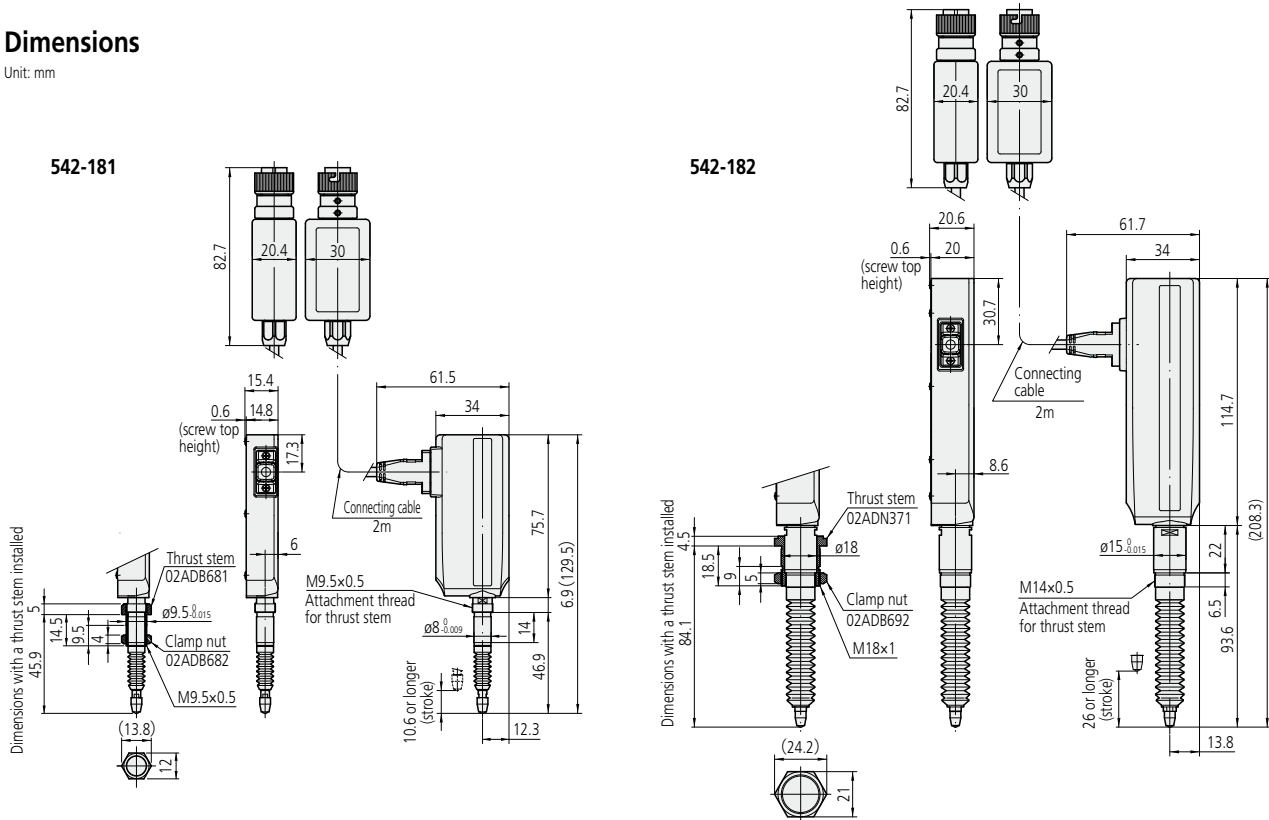

## SPECIFICATIONS

Order No.	542-181	542-182
Measuring range	10mm (.4")	25mm (1")
Resolution	0.1µm	
Measuring accuracy (20°C)	(0.8+L/50) µm (L=arbitrary measuring length (mm))	
Quantizing error	±1 count	
Measuring force	Contact point upwards: 1.0N or less Contact point horizontal: 1.1N or less Contact point downwards: 1.2N or less	4.0N or less 4.3N or less 4.6N or less
Position detection method	Photoelectric linear encoder*3	
Response speed*1	400mm/s	
Output signal	90° phase difference, differential squarewave (RS-422A equivalent) Minimum edge-to-edge interval, 200ns	
Output signal pitch	0.4µm	
Mass	Approx. 310g	Approx. 350g
Dust/water resistance*2	Equivalent to IP66 (only gage head)	
Stylus	ø3mm carbide-tipped (fixing screw: M2.5 (P=0.45)×5), standard contact point No.901312	
Stem dia.	ø8	ø15
Bearing type	Linear ball bearing*4	
Output cable length	2m (directly extended from the main unit)	
Connector	Plug: RM12BPE-6PH (HIROSE), Compatible receptacle: RM12BRD-6S (HIROSE)	
Operating temperature (humidity) range	0 to 40°C (RH 20 to 80%, no condensation)	
Storage temperature(humidity) range	-10 to 60°C (RH 20 to 80%, no condensation)	
Standard Accessories	Wrench for contact point: No.538610	Wrench for contact point: No.210187

\*1: When the spindle speed exceeds 400mm/s, an alarm signal will be output. Also, if using a Mitutoyo counter, an error message will be displayed. If using counters made by other companies, please consult your local Mitutoyo office. Note that over-speed error may occur depending on the impact amount when releasing the contact point freely.

\*2: IP Code is a standard which classifies and rates the degree of protection provided against the intrusion of solid objects and water. This may not be applicable depending on the kind of liquid.

\*3: Patent registered (Japan, U.S.A., Germany, U.K.)

\*4: Patent registered (Japan)

## Optional Accessories

- Rubber boot (spare)  
For 10mm range models: **No.238772**  
For 25mm range models: **No.962504**
- Thrust stem set  
For 10mm range models: **No.02ADB680**  
Thrust stem: **No.02ADB681**  
Clamp nut: **No.02ADB682**  
For 25mm range models: **No.02ADN370**  
Thrust stem: **No.02ADN371**  
Clamp nut: **No.02ADB692**
- \* External dimensions are described in the dimensional drawing of the product.
- \* Thrust stem set is a combination of thrust stem and a clamp nut. A special spanner is required for tightening. If using multiple gages, a thrust stem set for each gage and one special spanner are required.
- Wrench  
For 10mm range models: **No.02ADB683**  
For 25mm range models: **No.02ADB693**
- Extension cable (5m): **902434**
- Extension cable (10m): **902433**
- Extension cable (20m): **902432**

Gage  
Heads**LGS Absolute Type**

IP66

12.7mm range, 0.01 resolution, Digimatic code (SPC) output

**FEATURES**

- Employing the ABSOLUTE linear encoder, the LGS always displays the position of the spindle relative to the current origin, previously set by the user, at power-on. The unlimited response speed of the gage eliminates over-speed errors.

Connector: LGS

Unit: mm

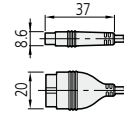
**Dimensions**

Unit: mm

575-303

Connecting cable: 2m

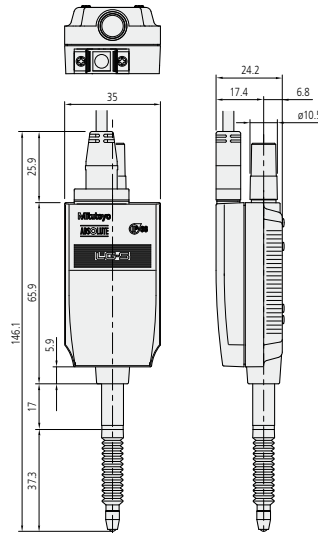
**SPECIFICATIONS****Metric**

Order No.	575-303
Measuring range	12.7mm
Resolution	10µm
Measuring accuracy (20°C)	15µm
Quantizing error	±1 count
Measuring force	Contact point upwards: 1.6N or less Contact point horizontal: 1.8N or less Contact point downwards: 2N or less
Position detection method	ABSOLUTE electrostatic capacitance type linear encoder
Response speed	Unlimited (not applicable to scanning measurement)
Output	Digimatic output
Mass	Approx. 190g
Contact point	ø3mm carbide-tipped (fixing screw: M2.5 (P=0.45)×5) Standard contact point No.901312
Stem dia.	ø8mm
Bearing type	Slide bearing
Dust/water resistance	Equivalent to IP66 (only gage head)
Output cable length	2m (directly extended from the main unit)
Operating temperature (humidity) range	0 to 40°C (RH 20 to 80%, no condensation)
Storage temperature(humidity) range	-10 to 60°C (RH 20 to 80%, no condensation)

\* IP Code is a standard which classifies and rates the degree of protection provided against the intrusion of solid objects and water. This may not be applicable depending on the kind of liquid.

**Inch**

Order No.	575-313
Measuring range	.5"
Resolution	.0005"
Measuring accuracy (20°C)	.0008"
Quantizing error	±1 count
Measuring force	Contact point upwards: 1.6N or less Contact point horizontal: 1.8N or less Contact point downwards: 2N or less
Position detection method	ABSOLUTE electrostatic capacitance type linear encoder
Response speed	Unlimited (not applicable to scanning measurement)
Output	Digimatic output
Mass	Approx. 190g
Contact point	ø3mm carbide-tipped (fixing screw: M2.5 (P=0.45)×5) Standard contact point No.901312
Stem dia.	ø9.52=3/8" DIA
Bearing type	Slide bearing
Dust/water resistance	Equivalent to IP66 (only gage head)
Output cable length	2m (directly extended from the main unit)
Operating temperature (humidity) range	0 to 40°C (RH 20 to 80%, no condensation)
Storage temperature(humidity) range	-10 to 60°C (RH 20 to 80%, no condensation)

\* IP Code is a standard which classifies and rates the degree of protection provided against the intrusion of solid objects and water. This may not be applicable depending on the kind of liquid.

**Optional Accessories**

- Rubber boot: **No.238774** (spare)
- Air drive unit (metric): **No.903594**
- Air drive unit (inch): **No.903598**
- SPC cable extension adapter:  
**No.02ADF640**
- Extension cable (0.5m):  
**No.02ADD950**
- Extension cable (1m): **No.936937**
- Extension cable (2m): **No.965014**

\* When connecting an extension cable, an SPC cable extension adapter is required.



Gage Heads

# LGB Extremely Compact ø9.5mm Stem Type

IP54

5 / 10mm range, 0.1 / 1µm resolution, Differential square-wave output\*

\*Sine-wave output: 542-421

## FEATURES

- Extremely compact design.
- The small photoelectric linear encoder assures high precision over the entire stroke range.
- The ball bearings\* used in the spindle unit ensure superb durability. \*Patent registered (Japan)

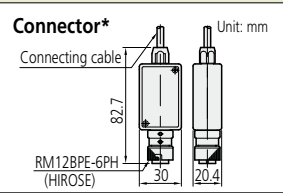

\*Differential square-wave output model

## Dimensions

Unit: mm

**542-246:** L-shape model, 0.1µm model  
**542-244:** L-shape model, 1µm model

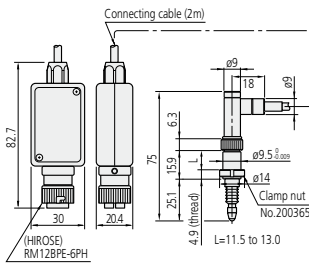

**542-262**  
**542-262H:** High accuracy model  
**542-264:** Low measuring force model

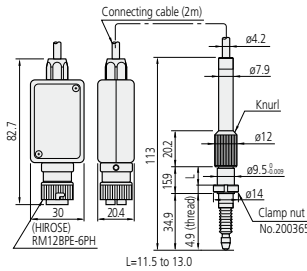

**542-270:** Air-lifter model

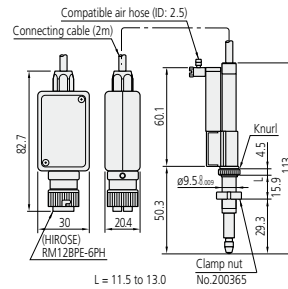

**542-421:** Sine-wave output model

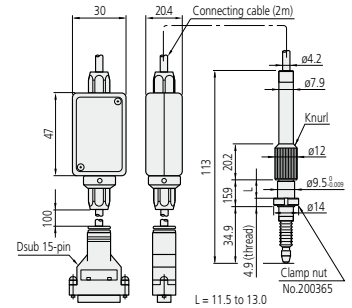

## SPECIFICATIONS

Order No.	542-246	
Measuring range	5mm (.2")	
Resolution	0.1µm	
Measuring accuracy (20°C)	0.8µm	
Measuring force	Contact point upwards	Approx. 0.55 or less
	Contact point horizontal	Approx. 0.6N or less
	Contact point downwards	Approx. 0.65 or less
Output signal	90° phase difference, differential square wave (RS-422A equivalent)	
Position detection method	Photoelectric linear encoder	
Response speed	380mm/s	
Mass	160g	
Dust/water resistance*	Equivalent to IP54 (only gage head)	
Contact point	Carbide ball (M2.5x0.45)	Steel ball (4-48UNF)
Stem dia.	ø9.5mm	
Bearing type	Linear ball bearing	
Output cable length	2m	
Connector	Plug: RM128PE-6PH (HIROSE), Compatible receptacle: RM128BRD-6S (HIROSE)	
Operating temperature (humidity) range	10 to 30°C (RH 20 to 80%, no condensation)	
Standard Accessories	Wrench for contact point: No.538610	Wrench for contact point: No.538610, Stem bushing

\*1: IP Code is a standard which classifies and rates the degree of protection provided against the intrusion of solid objects and water. This may not be applicable depending on the kind of liquid.

## Optional Accessories

- Rubber boot (spare)  
 For 5mm range models: **No.238773**  
 For 10mm range models: **No.238772**
- Extension cable (5m): **902434**
- Extension cable (10m): **902433**
- Extension cable (20m): **902432**

## SPECIFICATIONS

Type	L-shaped	Straight		Low measuring force	Air-driven contact point*1	Sine-wave output type
Order No.	542-244	542-262	542-262H	542-264	542-270*2	542-421
Measuring range	5mm (.2")			10mm (.4")		
Resolution		1µm				*3
Measuring accuracy (20°C)	2µm	1µm		2µm		
Maximum response speed	900mm/s					
Measuring force	Contact point upwards	Approx. 0.55N or less	Approx. 0.7N or less	Approx. 0.5N or less	Approx. 0.7N or less	
	Contact point horizontal	Approx. 0.6N or less	Approx. 0.75N or less	Approx. 0.55N or less	Approx. 0.75N or less	
	Contact point downwards	Approx. 0.65N or less	Approx. 0.8N or less	Approx. 0.6N or less	Approx. 0.8N or less	
Protection Level*4	IP54					
Mass	160g	170g		170g	180g	

\*1: Required air pressure: 0.3 to 0.4MPa

\*2: Spindle extends when air is supplied.

\*3: Depends on the settings of the connected counter.

\*4: IP Code is a standard which classifies and rates the degree of protection provided against the intrusion of solid objects and water. This may not be applicable depending on the kind of liquid.

# LGB Extremely Compact ø8mm Stem Type

5 / 10mm range, 1µm resolution, Differential square-wave output\*

## FEATURES

- Extremely compact design. Available with an outside diameter as small as 8mm.
- The small photoelectric linear encoder assures high precision over the entire stroke range.
- The ball bearings\* used in the spindle unit ensure superb durability. \*Patent registered (Japan)

\*Sine-wave output: 542-401

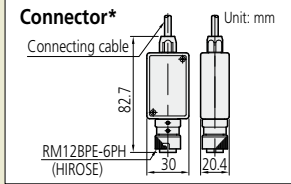

\*Differential square-wave output model

## Dimensions

Unit: mm

542-204: L-shape model

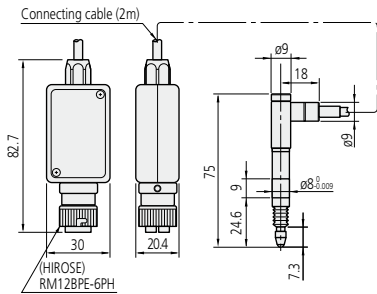

542-222  
542-222H: High accuracy model  
542-224: Low measuring force model

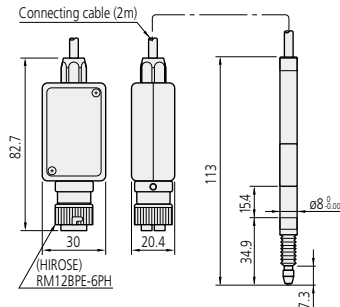

542-230: Air-lifter model

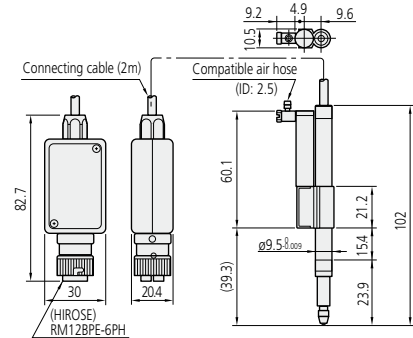

542-401: Sine-wave output model

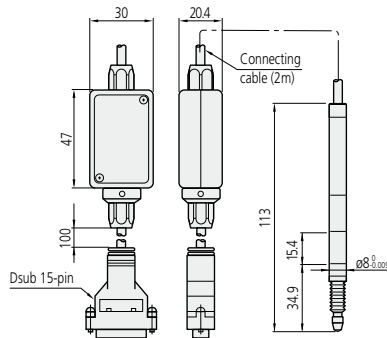

542-223: Air-lifter model

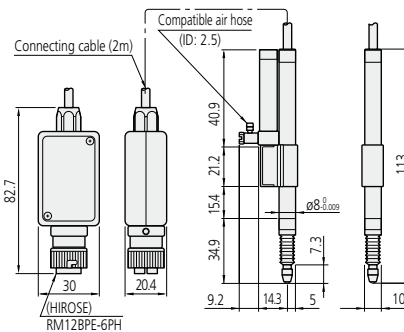

## SPECIFICATIONS

Type	L-shaped	Straight		Low measuring force	Air-driven contact point *1		Sine-wave output type
Order No.	542-204	542-222	542-222H	542-224	542-230*2	542-223*3	542-401
Measuring range	5mm (.2")				10mm (.4")		
Resolution			1µm				
Measuring accuracy (20°C)	2µm		1µm		2µm		
Quantizing error					±1 count		
Measuring force*4	Contact point upwards	Approx. 0.55N or less	Approx. 0.7N or less	Approx. 0.5N or less	Approx. 0.7N or less		
	Contact point horizontal	Approx. 0.6N or less	Approx. 0.75N or less	Approx. 0.55N or less	Approx. 0.75N or less		
	Contact point downwards	Approx. 0.65N or less	Approx. 0.8N or less	Approx. 0.6N or less	Approx. 0.8N or less		
Protection Level	Equivalent to IP54 (only gage head)						
Mass	145g	150g			165g		160g

\*1: Required air pressure: 0.3 to 0.4MPa

\*2: Spindle extends when air is supplied.

\*3: Spindle retracts when air is supplied.

\*4: Depends on the settings of the connected counter.

## Optional Accessories

- Rubber boot (spare)  
For 5mm range models: **No.238773**  
For 10mm range models: **No.238772**
- Extension cable (5m): **902434**
- Extension cable (10m): **902433**
- Extension cable (20m): **902432**

Gage Heads

# LG Long Stroke Type

IP54 IP66

100mm range, 0.1 / 1µm resolution, Differential square-wave output

## FEATURES

- There are three types including the standard model, low measuring force model, and rubber boot model ("made to order" basis) available.
- The resolution of each model can be selected to be 0.1µm or 1µm.

Connector

Unit: mm

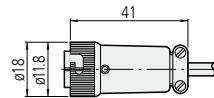

## Dimensions

Unit: mm

**542-312:** 0.1µm resolution model

**542-316:** 0.1µm resolution, low measuring force model

**542-332:** 1µm resolution model

**542-336:** 1µm resolution, low measuring force model

**542-314:** 0.1µm resolution, rubber boot model

**542-334:** 1µm resolution, rubber boot model

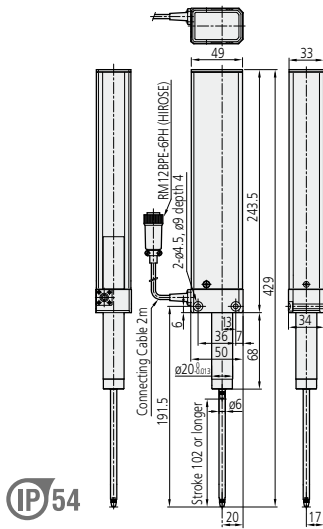

IP54

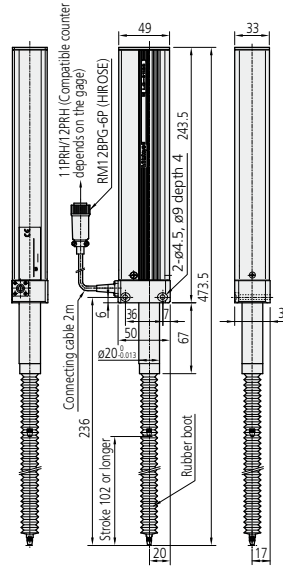

IP66

Lifting lever attachment

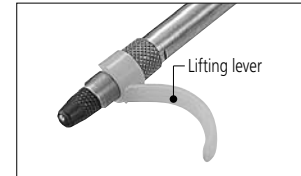

## Optional Accessories

- Rubber boot: **02ADA004** (for rubber boot type)

## SPECIFICATIONS

Type	Standard spar type	Low measuring force	Rubber boot type	Standard spar type	Low measuring force	Rubber boot type
<b>Order No.</b>	<b>542-312*</b>	<b>542-316*</b>	<b>542-314*</b>	<b>542-332*</b>	<b>542-336*</b>	<b>542-334*</b>
Measuring range	100mm (.4")					
Resolution	0.1µm			1µm		
Measuring accuracy (20°C)	(2+L/100)µm ≤ 2.5µm L=arbitrary measuring length (mm)			(2+L/100)µm ≤ 2.5µm L=arbitrary measuring length (mm)		
Quantizing error	±1 count					
Measuring force	Contact point downwards	Approx. 8.0N or less	Approx. 3.0N or less	Approx. 8.0N or less	Approx. 8.0N or less	Approx. 3.0N or less
	Contact point horizontal	Approx. 6.5N or less	—	Approx. 6.5N or less	Approx. 6.5N or less	Approx. 6.5N or less
	Contact point upwards	Approx. 5.0N or less	—	Approx. 5.0N or less	Approx. 5.0N or less	Approx. 5.0N or less
Position detection method	Photoelectric linear encoder					
Response speed*1 (max. electrical response speed)	Approx. 400mm/s			Approx. 800mm/s		
Output signal	90° phase difference, differential squarewave (RS-422A equivalent)					
Spindle drive	Helical extension spring					
Spindle guide	Bearing guide					
Stem diameter	ø20					
Contact point	ø3mm carbide-tipped (fixing screw: M2.5 (P=0.45)×5) Standard contact point No.901312					
Shock resistance	60g (in-house testing)					
Cable length	Approx. 2m (directly extended from the gage unit)					
Spindle sealing method	Scraper type		Rubber boot type	Scraper type		Rubber boot type
Dust/water resistance*2	Equivalent to IP54		Equivalent to IP66	Equivalent to IP54		Equivalent to IP66
Operating temperature (humidity) range	0 to 40°C (RH 20 to 80%, no condensation)					
Storage temperature (humidity) range	-10 to 60°C (RH 20 to 80%, no condensation)					
Input/output connector	For calculation: RM12BPE-6PH (HIROSE) Compatible receptacle: RM12BRD-6S (HIROSE)					
Mass (including cables)	Approx. 750g		Approx. 780g	Approx. 750g		Approx. 780g
Standard Accessories	Wrench for contact point: No. <b>210187</b> Hexagon socket head cap screw, M4×0.7×35, 2 pcs. (for gage fixing) Round flat washer, nominal 4, 2 pcs. (for gage fixing) Lifting lever: No. <b>137693</b> Fixing holder: <b>02ADG181</b> (for fixing lifting lever)					
Remarks	Standard	Low Measuring force	w/ rubber boot	Standard	Low Measuring force	w/ rubber boot

\*1: Note that over-speed error may occur depending on the indentation amount when releasing the contact point freely after indentation.

\*2: IP Code is a standard which classifies and rates the degree of protection provided against the intrusion of solid objects and water. This may not be applicable depending on the kind of liquid. (Only gage head)

\* To denote your AC power cable add the following suffixes to the order No.: A for UL/CSA, D for CEE, E for BS, C and No suffix are required for PSE.

Gage Heads

# LGM Motor-drive, Long Stroke Type

100mm range, 0.1 / 1µm resolution, Differential square-wave output

## FEATURES

- There are three types including the standard model, low measuring force model, and rubber boot model ("made to order" basis) available.
- The resolution of each model can be selected to be 0.1µm or 1µm.

IP54 IP66

Connector

Unit: mm

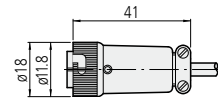

## Dimensions

Unit: mm

542-313: 0.1µm resolution model  
542-333: 1µm resolution model

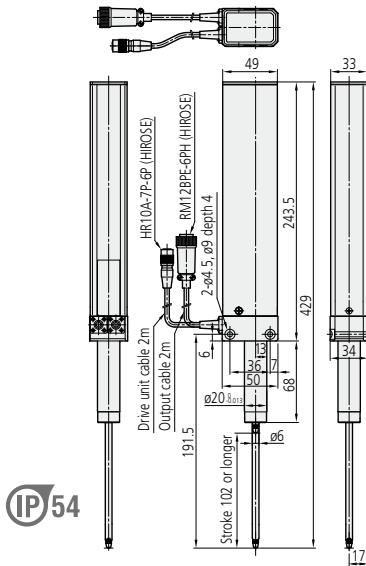

IP66

542-315: 0.1µm resolution, rubber boot model  
542-335: 1µm resolution, rubber boot model

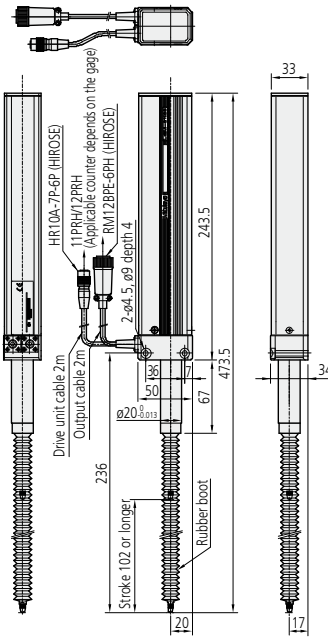

## Motor drive unit No.02ADG400

(standard accessory for LGM series main unit)



- A unit to move the spindle of the LGM series forward and backward.

### Measuring force

Can be set with the rotary switch of the main unit (to one of the combinations of H/L and a number between 0 and 9) depending on the mounting position.

### External dimensions

90 (W)×175 (D)×74 (H)mm (rubber boot excluded)

### External input signal

Spindle retract  
Spindle extend

### External output signal

Spindle stop signal at upper limit

### Mass

Approx. 700g

### Power supply

100 - 240V AC

## Optional Accessories

- Rubber boot: **02ADA004** (for rubber boot type)

## SPECIFICATIONS

Type	Standard spar type	Rubber boot type	Standard spar type	Rubber boot type
Order No.	542-313*	542-315*	542-333*	542-335*
Measuring range	100mm (.4")			
Resolution	0.1µm		1µm	
Measuring accuracy (20°C)	(2+L/100) µm ≤ 2.5µm L=arbitrary measuring length (mm)		(2.5+L/100) µm ≤ 3µm L=arbitrary measuring length (mm)	
Quantizing error	±1 count			
Measuring force	Contact point downwards	H4 (9.5N)	L9 (6.0N)	L9 (6.0N)
	Contact point horizontal	L7 (6.5N)	—	—
	Contact point upwards	L3 (3.0N)	L4 (4.5N)	L4 (4.5N)
Position detection method	Reflection type photoelectric linear encoder			
Response speed*1 (max. electrical response speed)	Approx. 400mm/s		Approx. 800mm/s	
Output signal	90° phase difference, differential squarewave (RS-422A equivalent)			
Spindle drive	Motor drive			
Spindle guide	Bearing guide			
Stem diameter	ø20			
Contact point	ø3mm carbide-tipped (fixing screw: M2.5 (P=0.45)×5) Standard contact point: No.901312			
Shock resistance	60g (in-house testing)			
Cable length	Approx. 2m (directly extended from the gage unit)			
Spindle sealing method	Scraper type	Rubber boot type	Scraper type	Rubber boot type
Dust/water resistance*2	Equivalent to IP54	Equivalent to IP66	Equivalent to IP54	Equivalent to IP66
Operating temperature (humidity) range	0 to 40°C (RH 20 to 80%, no condensation)			
Storage temperature (humidity) range	-10 to 60°C (RH 20 to 80%, no condensation)			
Input/output connector	Gage (counter output)	Connector for counter: RM12BPE-6PH (HIROSE) Compatible receptacle: RM12BRD-6S (HIROSE)		
	Gage (I/O for driving)	Gage side plug: HR10A-7P-6P (HIROSE) Receptacle on motor drive unit: HR10A-7R-6S (HIROSE)		
	Motor drive unit (for external control)	Receptacle on motor drive unit: HR10A-10R-10S (HIROSE) Motor drive unit plug: HR10A-10P-10P (HIROSE)		
Mass (including cables)	Approx. 940g	Approx. 970g	Approx. 940g	Approx. 970g
Standard Accessories	Wrench for contact point: No.210187 Hexagon socket head cap screw, M4×0.7×35, 2 pcs. (for gage fixing) Round flat washer, nominal 4, 2 pcs. (for gage fixing) Motor drive unit: No.02ADG400			
Remarks	Motor-driven Type			

\*1: The speed and measuring force are adjustable on the motor drive unit. Note that the rubber boot type cannot be used in the horizontal position.

\*2: IP Code is a standard which classifies and rates the degree of protection provided against the intrusion of solid objects and water. This may not be applicable depending on the kind of liquid.

\* To denote your AC power cable add the following suffixes to the order No.: A for UL/CSA, D for CEE, E for BS, C and No suffix are required for PSE.

# LGH High-resolution Type

10mm range, 0.01µm resolution

## FEATURES

- Excellent measuring stability — the design is also highly resistant to the unfavorable effects of environmental conditions such as air movement and atmospheric pressure changes.
- High-precision linear ball bearings are used in the guide for extremely smooth movement and exceptional durability.

The Mitutoyo LGH is a high-end digital gaging system that employs diffracted laser beam interference to make highly accurate and repeatable measurements. It features ultra-fine-pitch diffraction gratings on the scale.

## Dimensions

Unit: mm

**542-715:** Standard model  
**542-716:** Low measuring force

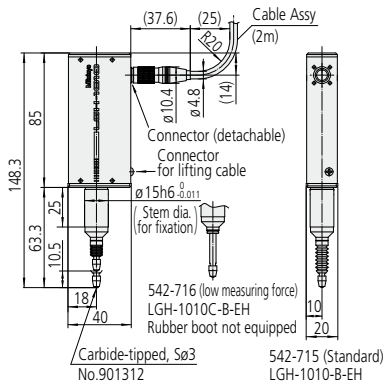

**542-925:** 0.01µm model with display unit  
**542-926:** 0.01µm and low measuring force model with display unit

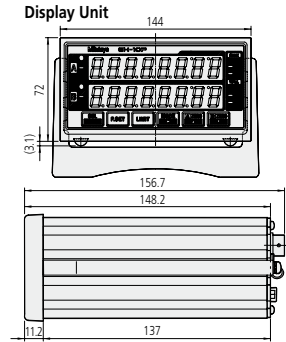
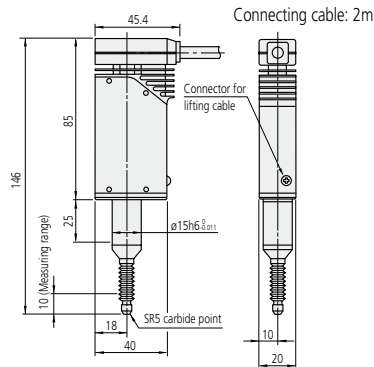

## SPECIFICATIONS

Order No.	542-715	542-716
Measuring range	10mm (.4")	
Resolution	0.01µm (0.05µm, 0.1µm, 0.5µm, 1µm can be selected from the counter)	
Measuring accuracy (20°C)	0.2µm	
Repeatability (2σ)	0.1µm (2σ)	
Retrace error	0.1µm	
Measuring force	Contact point downwards: Approx. 0.65N or less Contact point horizontal: Approx. 0.55N or less Contact point upwards: Approx. 0.45N or less	Contact point downwards: Approx. 0.12N Contact point horizontal: Not applicable Contact point upwards: Not applicable
Position detection method	Photoelectric reflection type linear encoder	
Detectable operation speed	In normal measurement: 700mm/sec; for peak detection: 120mm/sec	
Mass	220g (excluding cable of approx. 150g)	
Stylus	ø3mm carbide-tipped (fixing screw: M2.5 (P=0.45)×5)	
Stem dia.	ø15mm	
Bearing type	Linear ball bearing	
Output cable length	Approx. 2m	
Operating temperature (humidity) range	0 to 40°C/RH 20 to 80% (no condensation)	
Storage temperature(humidity) range	-10 to 60°C/RH 20 to 80% (no condensation)	

## Optional Accessories

- LGH stand: **No.971750**
- Stem fixture for fixing to top surface: **No.971751**
- Stem fixture for fixing to bottom surface: **No.971752**
- Spindle lifting cable: **No.971753**
- Rubber boot: **No.238752**  
boot (Spare for No.542-715, No.542-925, and No.542-927)
- I/O output connector (with cover): **No.02ADB440**

## Laser Beam Safety Precautions

This system uses a low-power invisible laser beam (780nm) which corresponds to a CLASS 1 (invisible radiation) of IEC60825-1 for measurement. The CLASS 1 laser warning label as shown below is attached to the main unit.

CLASS 1 LASER PRODUCT

## SPECIFICATIONS

Code No.	542-925*	542-927*	542-926*	542-928*
Configuration	Set of 1-axis Gage Head and Display Unit	Set of 2-axis Gage Head and Display Unit	Set of 1-axis Gage Head and Display Unit	Set of 2-axis Gage Head and Display Unit
Measuring range	10mm			
Measuring accuracy (20°C)	0.1µm*1			
Repeatability (2σ)	0.02µm			
Retrace error	0.05µm			
Measuring force	Contact point downwards: Approx. 0.35N or less Contact point horizontal: Approx. 0.45N or less Contact point upwards: Approx. 0.55N or less			Contact point downwards: Approx. 0.1N Contact point horizontal: — Contact point upwards: —
Stylus	ø3mm carbide-tipped (fixing screw: M2.5 (P=0.45)×5), standard contact point No.120058			
Output cable length	2m			
Display range	±999.99999mm			
Minimum reading	0.01µm			
Operating temperature (humidity) range	10 to 30°C (RH 30 to 70%, no condensation)			
Storage temperature (humidity) range	-10 to 50°C (RH 30 to 70%, no condensation) The temperature and humidity range for storage after unpacking is the same as that for operation.			
Standard Accessories	Wrench for contact point: <b>No.538610</b> , AC adapter: <b>No.02ADN460</b> AC cable (Japan): <b>No.02ZAA000*</b> , AC cable (USA): <b>No.02ZAA010*</b> , AC cable (EU): <b>No.02ZAA020*</b> AC cable (Britain): <b>No.02ZAA030*</b> , AC cable (China): <b>No.02ZAA040*</b> , AC cable (Korea): <b>No.02ZAA050*</b>			
Mass (Gage Head + Display Unit)	1400g			

\*1: Indication accuracy applies when used with counters.

\* To denote your AC power cable add the following suffixes to the order No.: A for UL/CSA, D for CEE, DC for CCC, E for BS, K for KC, C and No suffix are required for PSE.



# Litematic Head and Litematic

High resolution and low measuring force

## Litematic

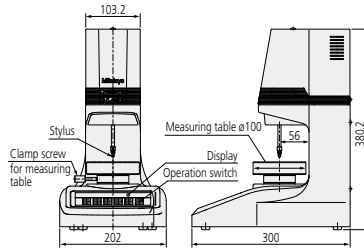

## Litematic Head

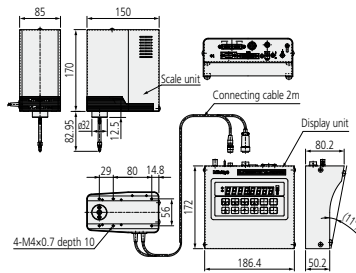

### Optional Accessories

(318-221, 318-222, 318-223, 318-226, 318-227, 318-228)

- Foot switch: **No.937179T**
- Dedicated stand: **No.957460**\*4
- SPC cable (1mm): **No.936937**\*5
- SPC cable (2m): **No.965014**\*5
- VL weight part: **No.02AZE375**\*6
- Recommended spare contact point:
  - Shell type
  - Carbide-tipped spherical contact point, ø7.5
  - Carbide-tipped spherical contact point, ø10.5
  - Carbide-tipped needle contact point, ø0.45

\*4: Only **VL-50S** is available.

\*5: Refer to page G-32 for details of the RS link.

\*6: Not applicable to **VL-50-100-B**, **VL-50S-100-B**.

### Laser Beam Safety Precautions

This system uses a low-power invisible laser beam (780nm) which corresponds to a CLASS 1 (invisible radiation) of IEC60825-1 for measurement. The CLASS 1 laser warning label as shown below is attached to the main unit.

**CLASS 1 LASER PRODUCT**

## SPECIFICATIONS

Order No.	318-221*	318-222*	318-223*	318-226*	318-227*	318-228*
Model name	Litematic			Litematic Head		
Measuring range	0-50mm (0 - 2")					
Resolution	0.01/0.1/1.0µm (.000005"/.000005"/.00005")					
Display unit	Character height 14mm (.6")/8 digits (excluding "minums" sign)					
Detection method	Reflection type linear encoder					
Stroke	51.5mm (2") With standard contact point					
Indication accuracy (20°C)*1	(0.5+L/100)µm L=arbitrary measuring length (mm)					
Accuracy guaranteed temperature*2	20 ± 1°C					
Repeatability*1	σ=0.05µm					
Measuring force*1	0.01N	0.15N*3	1N*3	0.01N	0.15N*3	1N*3
Feed speed	Approx. 2mm/s (.08"/s) or 4mm/s (.16"/s) (changeable by parameter)					
Fast feed	Approx. 8mm/s (.3"/s)					
Standard contact point	ø3mm carbide tipped (fixing screw: M2.5 (P=0.45)×5) No.901312					
Measuring table	ø100 (ceramic, grooved, removable)			—		
Input	Data can be input with the foot switch					
Output	"SPC output RS-232C output (switching by parameter)"					
Rating	85V to 264VAC (connected to AC adapter)					
Power supply	Maximum 12W (12V, 1A)					
Power consumption						
Standard Accessories	AC adapter: No.357651 Power cord Grounding wire: No.934626 Allen wrench (for replacing the interchangeable contact point)					

\*1: Normal measurement using standard contact point.

\*2: Under less temperature change, and hot or cold direct air flow should be avoided.

\*3: 0.15N, 1N types are factory-installed option.

Note: To denote your AC power cable add the following suffixes to the order No.: A for UJ/CSA, D for CEE, DC for CCC, E for BS, F for SAA, K for KC, C and No suffix are required for PSE.

Motor life is approximately 100,000 operations, after which replacement is advisable.

This maintenance factor is particularly important to bear in mind when the machine is used frequently, such as on a production line.

**FEATURES**

- Employing the ABSOLUTE linear encoder, the Signal ID-C always displays the true spindle position from the currently set origin at power on. Also, unlimited response speed eliminates over-speed errors.
- With the max./min. value holding function, the signal ID-C can output the GO/±NG judgment result against the peak values set. The judgment is carried out by calculation, within the gage, on the measurement data obtained. This provides high reliability with no concerns about deterioration of contact points as for electromechanical systems.
- The signal can be output to an external device, such as a sequencer, through the open-collector output.
- The GO/±NG judgment result is also indicated by a green/red LED and "<, O, >" symbols on the LCD.

**Dimensions**

Unit: mm

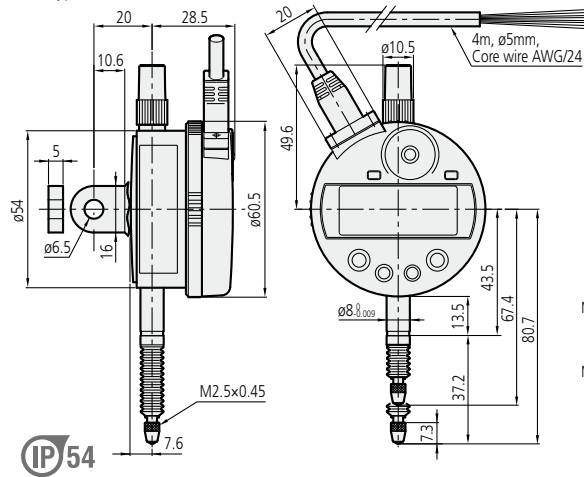
**543-280**  
ISO/JIS type

- Note 1: Dimensions of the inch (ANSI/AGD Type) dial indicator partly differ from those of the metric (ISO/JIS Type) indicator.
- Note 2: Inch (ANSI/AGD Type) dial indicator is provided with a stem of 3/8" dia. and #4-48UNF thread mount for the contact point.

**SPECIFICATIONS**

Order No.	543-280	543-280B	543-281	543-281B	543-282	543-282B	543-283	543-283B
Measuring range	12.7mm		5"					
Resolution	0.001mm		.00005" / 0.001mm				.0001" / 0.001mm	
Accuracy (20°C)*1	0.003mm		.00012"					
Measuring force	2.0N or less							
Position-detection method	Capacitance-type absolute linear encoder*3							
Response speed	Infinite (scanning measurement is not available.)							
Output signal	NPN open collector							
External input	Remote control (hold-preset, preset-recall, zero-set)							
Mass	175g							
Dust/water protection*2	IP54							
Contact point (mounting threads)	SR1.5mm carbide (M2.5X0.45mm)			SR1.5mm carbide or steel (#4-48unf)				
Stem size	ø8mm			ø9.5mm				
Type of back	Lug	Flat	Lug	Flat	Lug	Flat	Lug	Flat
Connecting cable length	4m							
Operating environment	0°C to 40°C (20%RH to 80%RH, without condensation)							
Optional accessories	<b>902011</b> : Spindle lifting lever for mm model,		<b>125317</b> : Rubber boot (spare)		<b>902794</b> : Spindle lifting lever for inch/mm model,		<b>540774</b> : Spindle lifting cable	

\*1: Excluding quantizing error of ±1 count.

\*2: IP level is the standard of protection against the ingress of solids/foreign matter and water. This may not be applicable for liquids other than water.

\*3: Patent registered (Japan, U.S.A., Germany, U.K., Switzerland, Sweden, China)

**Tolerance judgment output signals**

Wire	- NG	OK	+ NG	Error condition alert
Orange (- NG)	Low	High	High	High
Green (OK)	High	Low	High	High
Brown (+ NG)	High	High	Low	High
LED	Red	Green	Red	Red (blinking)
LCD	<	O	>	"x.xx E" indication

**I/O Specifications**

Wire	Signal	I/O	Description
Black	- V (GND)	—	Power supply return
Red	+ V (GND)	I	Power supply (12 - 24VDC)
Orange	- NG	O	Tolerance judgment result output: The signal wire corresponding to a judgment result is set to the 'Low' level.
Green	OK	O	
Brown	+ NG	O	
Yellow	PRESET_RECALL_ZERO	I	External input terminal: If the relevant terminal is set to the Low level, its signal becomes true.
Blue	HOLD_RESET	I	
Shield	FG	—	Connected to GND

## Digimatic Connection Example

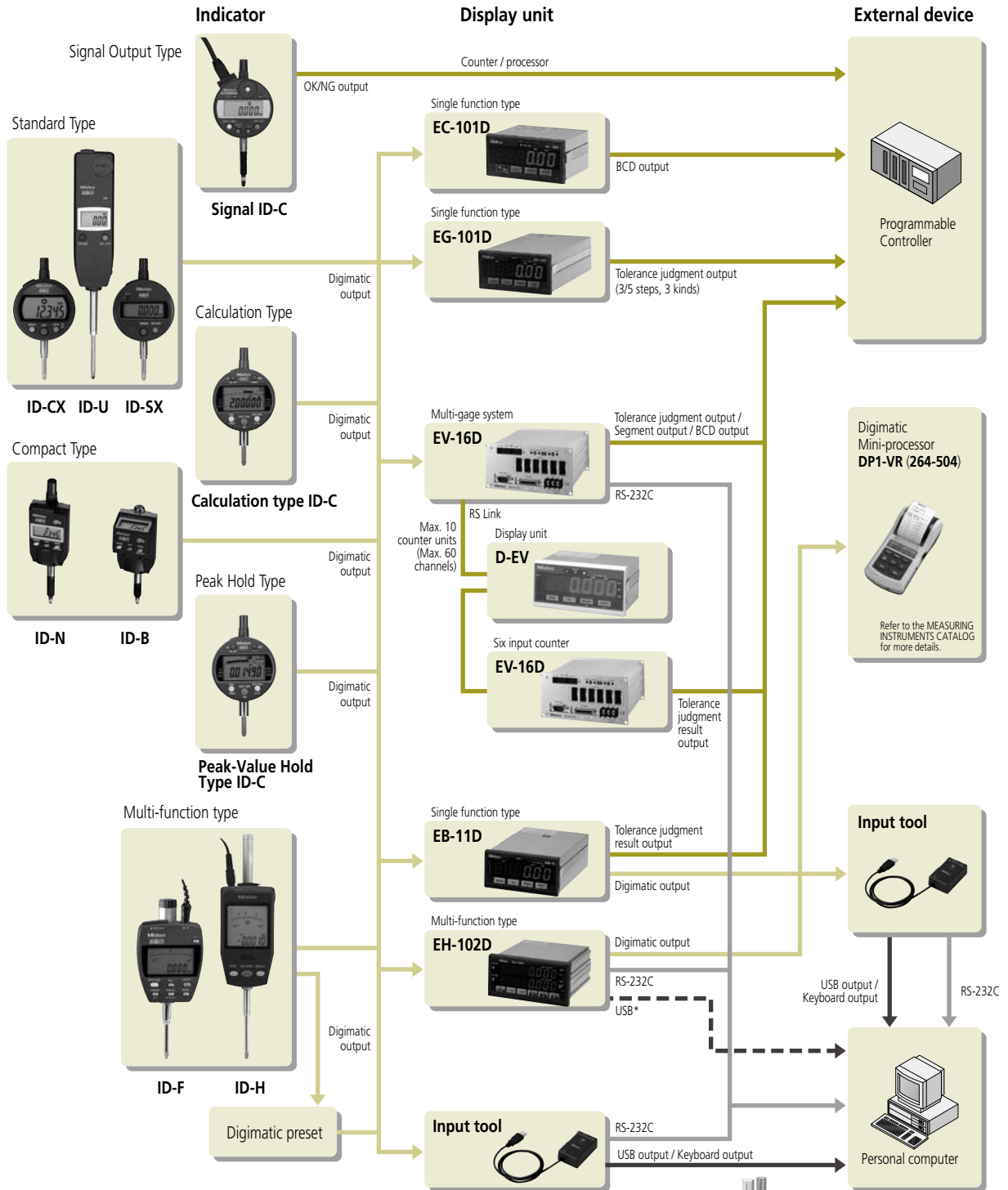

With an Input tool connected to the keyboard connector on a personal computer, measurement data from a measuring tool can be loaded directly into a spreadsheet such as Excel.



\* Can be connected to SENSORPAK (Mitutoyo software) only.

# Output Signal Specifications

## Differential square-wave

	0.1µm LGB	0.1µm LGK/LGF	0.5µm LGK/LGF	1µm LG/LGB/LGF	5µm LGF
Output signal	90° phase difference, differential square wave (RS-422A equivalent)				
Signal pitch	0.4µm		2µm	4µm	20µm
Minimum edge interval	250nsec.	200nsec.	250nsec.	500nsec.	1000nsec.
Output signal level	+5V (4.8 to 5.2V, 80mA) øA, øB, øB̄: TTL output, line driver output, AM26LS31 or equivalent				
Plug type	RM12BPE-6PH (HIROSE)				
Compatible socket	RM12BRD-6S (HIROSE)				
Recommended receiver	Differential input, line receiver, AM26LS32 or equivalent				
Gage connecting cable length	2 m; directly connected to the gage				
Maximum extension cable length	20m (extension cables of 5, 10 and 20m in length are available)				
Alarm output*1	A special signal (see the chart below) is output when an alarm condition occurs				
Power supply	+5V (120mA), power supply ripple voltage 200mV p-p max.				

\*1: With an LGF gage, a seventh signal line may be provided to output the error alarm. (Factory option).

### 1) Pin assignment

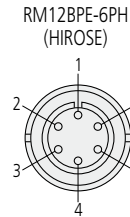

Pin No.	Assignment
1	+5V
2	øA
3	øB
4	øĀ
5	GND
6	øB̄

\*: Power supply (120mA) to a sensor (gage head)  
Power supply ripple voltage: 200mVp-p or less

### 2) Recommended processing circuit for received waveform

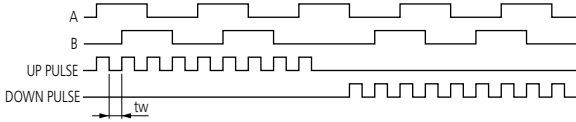
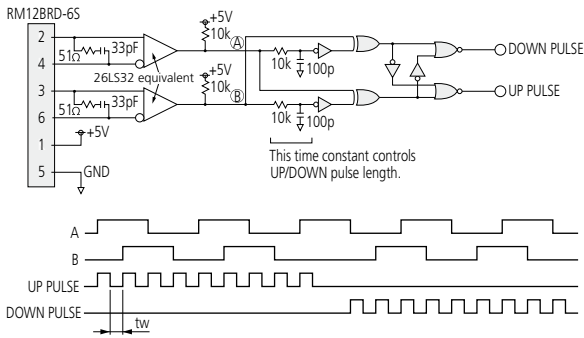

### 3) Timing chart (normal)

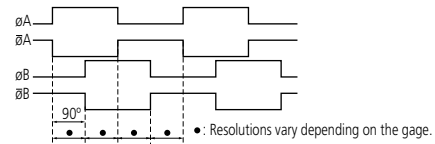

### 4) Timing chart (occurrence of gage alarm)

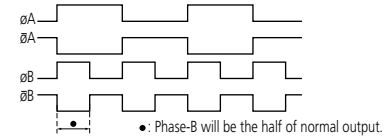

## Differential square-wave with Origin Point Mark

	0.5µm reading	1µm reading
Output signal	90° phase difference, differential square wave (RS-422A equivalent)	
Signal pitch	2µm	4µm
Minimum edge interval	250nsec.	500nsec.
Output signal level	+5V (4.8 to 5.2V, 120mA) øA, øB, øB̄, øZ̄: TTL, line driver, AM26LS31 or equivalent	
Plug type	PRC05-P8M (TAJIMI)	
Compatible socket	PRC05-R8F (TAJIMI)	
Recommended receiver	Differential input, line receiver, AM26LS32 or equivalent	
Gage connecting cable length	2 m; directly connected to the gage	
Maximum extension cable length	20m (extension cables of 5, 10 and 20m in length are available)	
Alarm output	A special signal (see the chart below) is output when an alarm detection occurs	
Power supply	+5V (120mA), power supply ripple voltage 200mV p-p max.	

PRC05-P8M (TAJIMI)

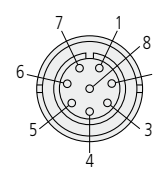

### 1) Pin assignment

Pin No.	Signal
1	+5V
2	GND
3	øA
4	øĀ
5	øB
6	øB̄
7	øZ̄
8	N.C.

\*: Power supply to a gage head  
Supply voltage: 5V (4.8-5.2V)  
Ripple voltage: 200mVp-p or less  
Current consumption: 120mA

### 2) Recommended processing circuit for received waveform

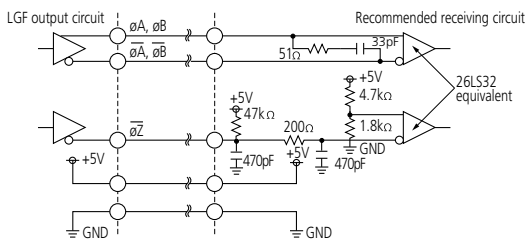

### 3) Timing chart (normal)

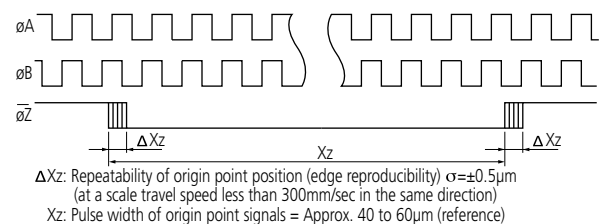

ΔXz: Repeatability of origin point position (edge reproducibility)  $\sigma = \pm 0.5\mu\text{m}$  (at a scale travel speed less than 300mm/sec in the same direction)  
Xz: Pulse width of origin point signals = Approx. 40 to 60µm (reference)

## Differential square-wave

### Data output timing: 1µm resolution LGB and 1µm / 0.5µm resolution LGF

The gages listed above use the following three output signal modes. Reception circuitry can be designed that includes an error detecting process making use of these mode patterns:

#### 1) Real-time pulse output (Phase-A wave advances when the spindle is retracted.)

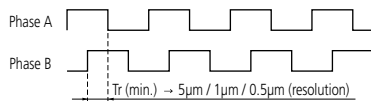

1. Output condition: Spindle speed  $\leq 250\text{mm/s}^{*2}$
2. Minimum edge-to-edge interval =  $T_r$
3. Output delay time<sup>\*1</sup>: Max. 1µs

#### 2) Burst mode output (Phase-A wave advances when the spindle is retracted.)

When the spindle speed reaches the limit of real-time pulse output, the gage head switches its signal output to burst mode. These pulse bursts are 2-phase square wave signals that are forcibly created from the internal clock with a minimum edge-to-edge interval smaller than the normal real-time pulse output. The bursts will not always be output to exactly reflect the actual spindle motion and the delay in signals also becomes larger, but the counting values will still be valid provided this output form continues.

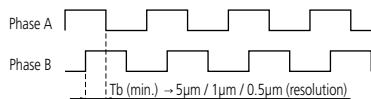

1. Output condition:  $250\text{mm/s}^{*2} < \text{Spindle speed} \leq \text{Gage response speed}^{*3}$
2. Minimum edge-to-edge interval =  $T_b$
3. Output delay time<sup>\*1</sup>:
  - At one-way displacement = Max. 5µs
  - At two-way displacement (including the reverse direction) = Max. 10µs

#### 3) Error output

The pulse generation circuit may sometimes overstep its response limit, if the output wave is subject to extreme disturbance due to vibration or impact on the gage head, or if the spindle moves faster than the output limit of burst mode. However, at this timing, as the gage head automatically switches its output signal from burst mode to error mode, in addition to synchronizing Phase A and Phase B of the 2-phase square wave signals, the user can make use of this facility for error detection.

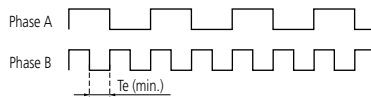

1. Output condition: LGB will identify an error under the following conditions and produce its output in one of the modes described above.
  - Gage response speed<sup>\*3</sup> < Spindle moving speed
  - At a disturbance such as interference, vibration, etc.
2. Minimum pulse width of output pulses =  $T_e$

### Data output timing: 0.1µm resolution LGB / LGF and 1µm / 0.1µm resolution LG / LGM

The gages listed above use the following two output signal modes. Reception circuitry can be designed that includes an error detecting process making use of these mode patterns:

#### 1) Real-time pulse output (Phase-A wave advances when the spindle is retracted.)

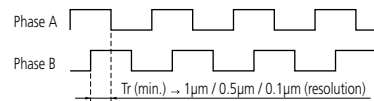

1. Output condition: Spindle speed  $\leq \text{Gage response speed}^{*3}$
2. Minimum edge-to-edge interval =  $T_r$
3. Output delay time<sup>\*1</sup>: Max. 2.5µs

#### 2) Error output

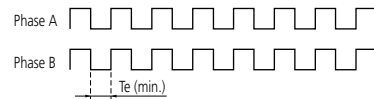

1. Output condition: Gage heads will identify an error under the following conditions and produce an output as described above.
  - Gage response speed<sup>\*3</sup> < Spindle speed
  - At a disturbance such as interference, vibration, etc.
2. Minimum width of output pulses =  $T_e$

### Minimum edge-to-edge interval / pulse width under each condition

Model	Resolution	$T_r$ (real-time output)	$T_b$ (burst output)	$T_e$ (error output)
LGB	5µm	1µs	0.5µs	0.2µs
LGF		0.4µs	—	0.4µs
LGM		0.2µs	—	0.2µs
LGF	0.5µm	1µs	0.2µs	0.2µs
LGM		0.2µs	—	0.2µs
LGB	0.1µm	0.2µs	—	0.2µs
LGF		0.2µs	—	0.2µs
LGM		0.2µs	—	0.2µs

[NOTE]

> Since any output during an error condition cannot be used as the attribute data, it is necessary to detect the error condition at the reception circuitry side.  
> It is recommended to design user circuitry based on an IC chip that is capable of counting at 5Mcps (equivalent to square wave of 1.25MHz) or greater.

- \*1 : Output delay time: Time until the counting pulse catches up to the spindle position.
- \*2 : The actual limit of real-time pulse output will be depreciated to this value. This is because actual detection signals unavoidably contain acceleration components in association with the spindle motion as well as error components from a little noise included in the signal itself. As a result, some burst pulses at a speed below the ideal conditions (i.e. ideal signal form at constant speed) may be generated.
- \*3 : Gage response speed: Refer to the specifications section in the User's Manual.

# Output Signal Specifications

## Digimatic code

### 1. Pin assignments and signals

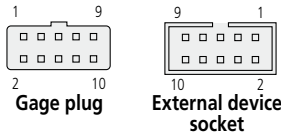

Compatible socket:  
Sumitomo 3M : V Low-Proheader  
Model: **7610-5002XX** or equivalent

Pin No.	Signal	I/O	Description
1	GND	—	Signal ground
2	DATA	Output	Measurement data-output terminal
3	CK	Output	Synchronized clock-output terminal
4*1	N.C.	—	Not used
5	REQ	Input	Input for data transmission request from external device
6*1	ORIG	Input	Input for absolute-origin setting signal
7*1	N.C.	—	Not used
8*1	N.C.	—	Not used
9*1	+5V	—	Power supply (+5V ±10%)*2
10*1	GND(F.G.)	—	Frame ground

\*1 : LGD, LGS uses a unique specification.  
All others use the common Digimatic output specification (10-pin, square).  
\*2 : Current consumption of LGD,LGS: Idd=20mA max.

### 2. I/O electrical specifications

- Output terminal format: CK, DATA  
N-channel open drain  
Maximum output current: 400µA max. (when Vol=0.4V)  
Output withstand voltage: -0.3V to 7V
- Input terminal format: REQ, ORIG  
Pull-up CMOS input  
Internal power supply voltage: Vdd= 1.35 to 1.65V  
Pull-up resistance: R1= 10 to 100KΩ  
"H" level input voltage: VIH= .1V min.:  
"L" level input voltage: VIL= 0.3V max.

#### Recommended receiving circuit

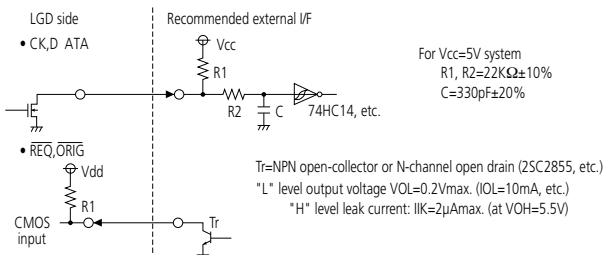

Note: Since the power supply voltages are different between the gage side and the external device side, be sure to use an open collector or open drain circuit. Do not use CMOS output or the like.

### 3. Data format

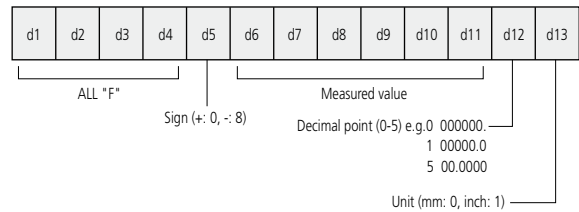

- Data is output as 13-digit (52-bit) based on 4 bits = 1 digit.
- Data is output in order from d1 to d13. Each digit is output in the order of LSB to MSB.
- Measurement data is output in the order of MSD to LSD.
- The sign, measurement data, decimal position and unit are output in BCD based on positive logic (0=L, 1=H).

### 4. Timing chart

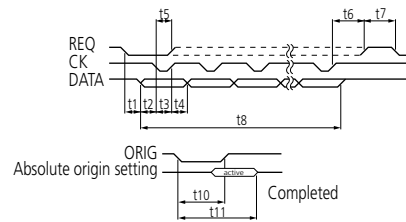

#### Standard (for reference)

Symbol	min.	max.
*t1	0µs	2sec
t2	15µs	—
t3	100µs	—
t4	100µs	—
t5	0µs	—
*t6	—	—
*t7	—	—
*t8	—	—

#### LGD

Symbol	min.	max.
*t1	30µs	95ms
t2	15µs	—
t3	100µs	—
t4	100µs	—
t5	0µs	—
*t6	—	100µs
*t7	100µs	—
*t8	—	30ms

#### LGS

Symbol	min.	max.
*t1	160µs	85ms
t2	150µs	180µs
t3	150µs	180µs
t4	300µs	330µs
t5	0µs	—
*t6	—	100µs
*t7	100µs	—
*t8	—	—

Symbol	min.	max.
*t10	1.5s	—
*t11	—	4s

- Note 1: The specifications indicated by an asterisk (\*) are applicable only to LGD, LGS. All other Digimatic output specifications are common to all models.
- Note 2: Read data only when CK is at the "L" level.
- Note 3: Do not input REQ signal (fixed at "H") while the absolute origin is being set (during t11).
- Note 4: If t5, t6 and t7 are satisfied and REQ is continuously input, an output is obtained from LGD, LGS at intervals of approximately 95ms.
- Note 5: Start inputting ORIG and REQ after two or three seconds have elapsed (the estimated time required for internal circuit/sensor to stabilize) following power-on.



# Gage Head Mounting Fixtures

Gage heads are mounted on a fixture or stand using the precision-machined cylindrical stem. Stems can be any one of several standard diameters and are either just plain or with a fixing thread at one end or the other. All gages can be mounted using the split-clamp method which is suitable for a range of applications, especially where small axial adjustments may be required. However, care is needed to avoid over-tightening the clamp, which could interfere with the spindle movement. Those stems with a thread at the spindle end can also be mounted just by using a nut to clamp them into a hole in a fixture. They can also use a 'thrust stem' (see page 33) that is clamped into a larger hole in a fixture and into which the gage is screwed. Stems with a thread at the body end can also use this method of mounting.

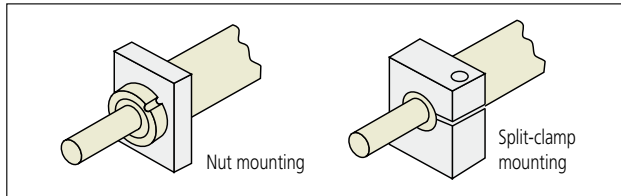

## Split-clamp mounting fixtures

- To mount a gage head with an 8mm diameter stem, use a 9.5mm diameter stem bushing.

**546288**  
ø9.5x15

**546343**  
ø9.5x8.5

Unit: mm

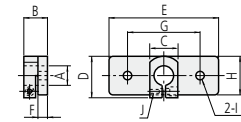
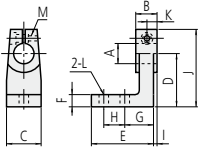

Part No.	303560	303569
A	ø9.5	ø9.5
B	9	14.5
C	15	20
D	20	30
E	23	35
F	5	7
G	11	16
H	8	12
I	1.5	3.25
J	32.5	42.5
K	4.5	7.25
L	ø3.4	ø4.5
M	M3x0.5	M3x0.5

Part No.	303562	303571
A	ø9.5	ø9.5
B	9	14.5
C	15	15
D	20	22.5
E	40	60
F	3	5
G	30	40
H	15	20
I	ø3.4	ø4.5
J	M3x0.5	M3x0.5

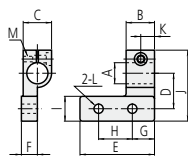
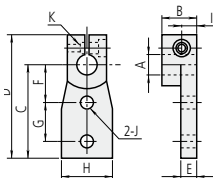

Part No.	303564	303573
A	ø9.5	ø9.5
B	9	14.5
C	30	40
D	42.5	52.5
E	4	6
F	15	18
G	10	15
H	15	20
I	4.5	7.25
J	ø3.4	ø4.5
K	M3x0.5	M3x0.5

Part No.	303566	303575
A	ø9.5	ø9.5
B	9	14.5
C	15	15
D	15	20
E	25	40
F	8.5	8.5
G	7.5	10
H	10	20
I	10	15
J	32.5	40
K	4.5	7.25
L	ø3.4	ø4.5
M	M3x0.5	M3x0.5

## Example of plain-stem mounting

The recommended clamping torque is 0.4 to 0.5Nm (LGB-0105L: 0.2 to 0.3Nm). Overly tightening the stem will prevent smooth movement of the spindle.

### Example 1

Split-clamp method

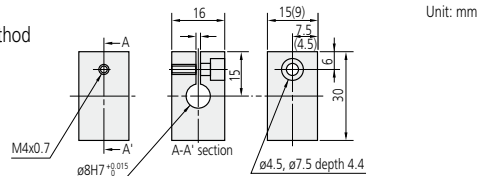

### Example 2

Setscrew method

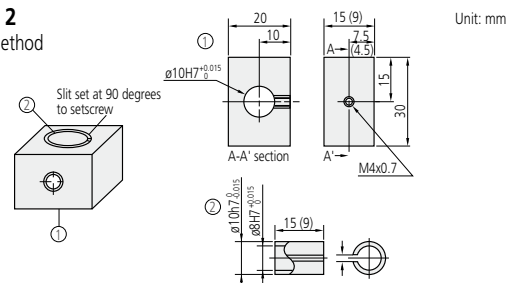

## Nut-clamp mounting fixtures

- A gage head with a 9.5mm diameter stem threaded at the bottom can be installed without additional parts or machining.

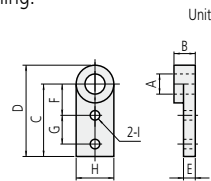
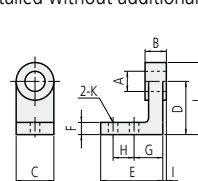

Part No.	303568
A	ø9.5
B	11.5
C	20
D	30
E	35
F	7
G	16
H	12
I	1.75
J	40
K	ø4.5

Part No.	303572
A	ø9.5
B	11.5
C	40
D	50
E	6.5
F	18
G	15
H	20
I	ø4.5

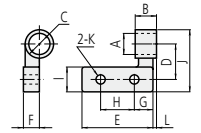
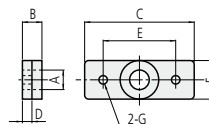

Part No.	303570
A	ø9.5
B	11.5
C	60
D	5.5
E	40
F	20
G	ø4.5

Part No.	303574
A	ø9.5
B	11.5
C	ø15
D	20
E	40
F	8.5
G	10
H	20
I	15
J	35
K	ø4.5
L	1.25



## Mounting with a thrust stem

A thrust stem is available as an option for the LGF, LGK, LGE and LGD gage heads. Installing a thrust stem on the stem allows direct mounting, simply by drilling a hole in a section of suitable thickness on the fixture.

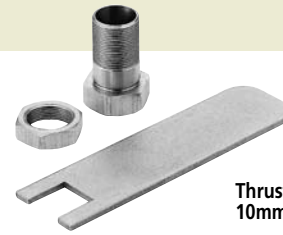

Thrust Stem for  
10mm LGD / LGF / LGK

### For 10mm LGD / LGF / LGK: 02ADB680

Unit: mm

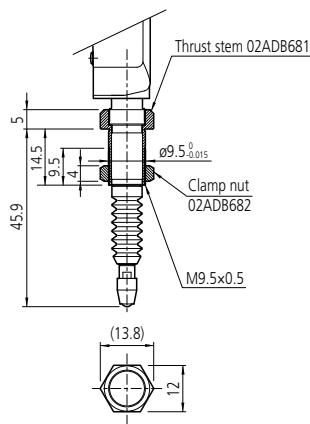

\* A mounting section with a thickness of 6 through 10.5mm is suitable.

With the use of a thrust stem and clamp nut, a gage fixture can be arranged simply by drilling a 9.5mm dia. hole. A gage can be secured firmly with ease with this arrangement.

#### IMPORTANT

In attaching a thrust stem, be sure to fix the stem first with a dedicated wrench (**02ADB683**). An excessive force applied between the gage main body and stem may cause damage to the gage.

#### NOTE

Both the dedicated wrench (**02ADB683**) and M9.5x0.5 threaded section are for mounting a thrust stem. Do not use them for other purpose than mounting a thrust stem.

### For 25mm LGD / LGF: 02ADN370

Unit: mm

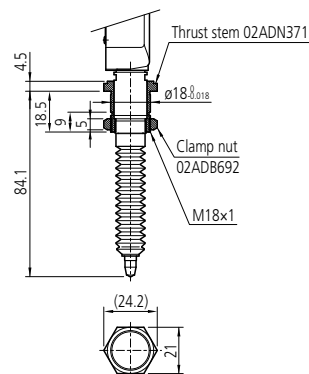

\* A mounting section with a thickness of 10 through 12mm is suitable.

With the use of a thrust stem and clamp nut, a gage fixture can be arranged simply by drilling an 18mm dia. hole. A gage can be secured firmly with ease with this arrangement.

#### IMPORTANT

In attaching a thrust stem, be sure to fix the stem first with a dedicated wrench (**02ADB693**). An excessive force applied between the gage main body and stem may cause damage to a gage.

#### NOTE

Both the dedicated wrench (**02ADB693**) and M14x0.5 threaded section are for mounting a thrust stem. Do not use them for other purpose than mounting a thrust stem.

### For 50mm LGD / LGF: 02ADN370

Unit: mm

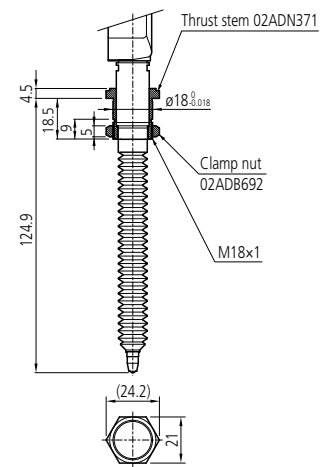

\* A mounting section with a thickness of 10 through 12mm is suitable.

With the use of a thrust stem and clamp nut, a gage fixture can be arranged simply by drilling an 18mm dia. hole. A gage can be secured firmly with ease with this arrangement.

#### IMPORTANT

In attaching a thrust stem, be sure to fix the stem first with a dedicated wrench (**02ADB693**). An excessive force applied between the gage main body and stem may cause damage to a gage.

#### NOTE

Both the dedicated wrench (**02ADB693**) and M14x0.5 threaded section are for mounting a thrust stem. Do not use them for other purpose than mounting a thrust stem.

## SPECIFICATIONS

Set order No.*	02ADB680	02ADN370
Compatible gage	10mm LGD / LGF / LGK	25 / 50mm LGD / LGF
Part No.	Thrust stem	02ADB681
	Clamp Nut	02ADB682
	Wrench	02ADB683
Gage mounting hole diameter (nominal)	ø9.5mm	ø18mm
Recommended plate thickness (mounting section)	6 to 10.5mm	10 to 12mm

\* A thrust stem set is comprised of a thrust stem and clamp nut. A dedicated wrench is required for tightening.

# Optional Accessories

## Spare rubber boot

Protects the spindle bearing of a gage head from dust.



### SPECIFICATIONS

Order No.	Compatible Gage head
238773	5mm LGB
238772	10mm LGB / LGD / LGF / LGK / Laser Hologage
962504	25mm LGD / LGE / LGF
962505	50mm LGD / LGE / LGF
02ADA004	LG / LGM
238774	LGS

## Extension signal cable for gage head with Origin Point Mark

- A signal cable from the head to the receiver circuitry can be extended.
- Maximum number of connectable cables is limited to 3, and the maximum total extension length is limited to 20m.



### SPECIFICATIONS

Order No.	Cable length
02ADF260	5m
02ADF280	10m
02ADF300	20m

## Extension signal cable

The distance between a gage head\* and display unit can be extended up to 20m by using these cables (max. 3 cables).

\*Not available for LGF with Origin Point Mark, LGS, LGD models, and Laser Hologage.



### SPECIFICATIONS

Order No.	Cable length
902434	5m
902433	10m
902432	20m

## Digimatic cable extension adapter: 02ADF640

This adapter can be used when the LGS or LGD gage head is to be connected to a display unit where the provided cable length is not sufficient for this connection.

Do not joint more than one piece of this product together for use.

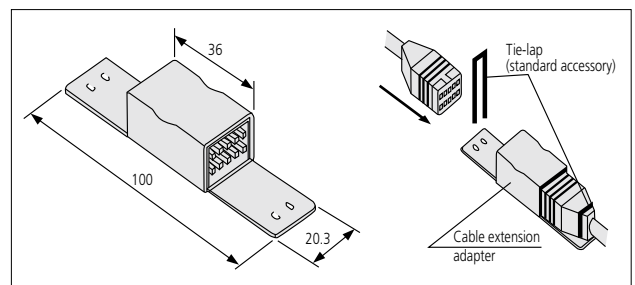

## Measuring stand

Useful for long-stroke LG / LGM models.

### Granite comparator stand



### SPECIFICATIONS

Order No.	215-156
Base material	Granite
Base size	W300 x D250 x H95
Base flatness	3.5µm
Fine adjustment	Square thread
Stem size	ø20, ø8

### Comparator stand



### SPECIFICATIONS

Order No.	215-505
Base material	Hardened steel
Base size	W150 x D150 x H64
Base flatness	2µm
Fine adjustment	Square thread
Stem size	ø20, ø8

## Measuring stand for Laser Hologage

Order No.: 971750

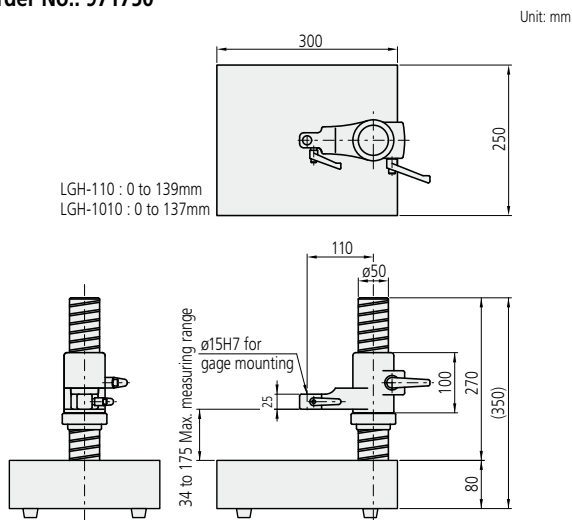

## Release with damper: 971753

Spindle-lift release for the Laser Hologage. A sudden drop of the spindle is prevented by the return-speed adjustment knob.

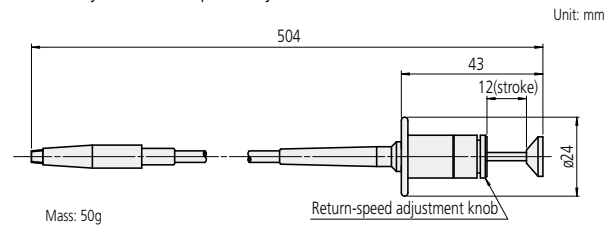

## Digimatic power supply unit

This is used to power the gage head (LGD or LGS model) when it is connected to an external device, except for a display unit (e.g. MUX-10F, DP1-VR).



### SPECIFICATIONS

Order No.	965275
Compatible gage head	LGD, LGS model
Function	External zero-set, data output,
Dimensions	W60 x D40 x H20

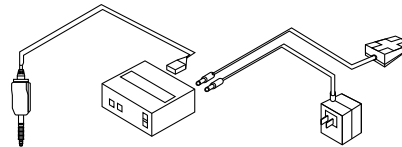

## Mounting holder A, B

Useful when the Laser Hologage is mounted on an alternate fixture rather than the regular measuring stand.

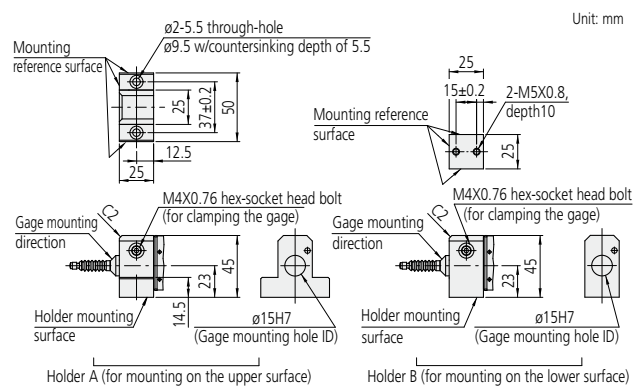

## Interchangeable contact points

- With all gage heads, the mounting-thread specification for the interchangeable contact points is M2.5x0.45x5mm, except for the inch versions of the LGS gages (**575-311** and **575-312**) which conform to the UNF thread specification (#4-48 UNF).

- After replacing a contact point, it should be tightened firmly so that it will not loosen during usage. (Recommended tightening torque=5N·cm)
- Ruby and carbide contact points show the best resistance to abrasion.

### ø3mm Ball Points

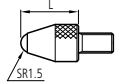

L	Material	Order No.
7.3	Carbide	901312
	Carbide	901454
	Plastic	901994
	Carbide	902018
	Ruby	120047
14	Carbide	21JAA225
15	Carbide	120049
	Ruby	120051
17	Carbide	21JAA224
20	Carbide	137391
	Ruby	137392
22	Carbide	21JAA226
25	Carbide	120053
	Ruby	120055
30	Carbide	21JAA252
	Ruby	21JAA253

### Flat Points\*

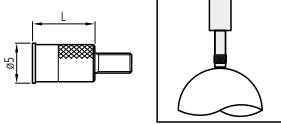

Order No.	L
131365	8
21AAA340	10

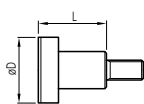

D	L	Order No.
9.53	9.53	101189
10	10	101117
12.7	9.53	101188
15	10	21AAA341
20	10	21AAA342
25	10	21AAA343
30	10	21AAA344

### Flat Points (Carbide)\*

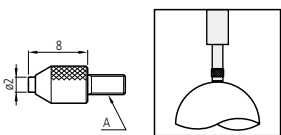

Order No.
120056

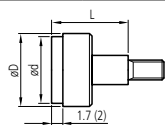

Order No.	d	D	L	Flatness
120041	4.3	5.2	5	3µm
120042	6.5	7	5	
120043	9.5	10.5	5	
21AAA345	15	17	10	5µm
21AAA346	20	22	10	
21AAA347	25	27	10	
21AAA348	30	32	10	

### Ball Points

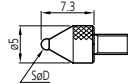

D	Order No.
1	21AAA349
1.5	21AAA350
1.8	101122
2.5	21AAA351
4	21AAA352

### Shell Type Points

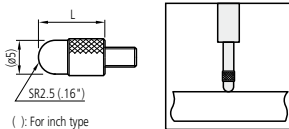

L	Order No.
3.97	101184
5	101386
10	101118
12.7	101185
15	137393
19.05	101186
20	101387
25	101388
25.4	101187
30	21AAA254

### Spherical Points

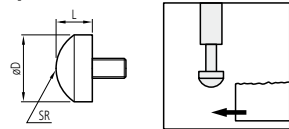

D	L	SR	Order No.
5.5	3	5	111460
8	5	5	125258
9.53	2.38	9	101204
10	5	7	101119
12.7	3.18	7	101205

### Spherical Points (Carbide)

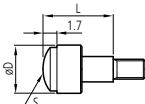

D	L	SR	Order No.
5.2	5	5	120058
7.5	10	7	120059
10.5	10	10	120060

### Roller Points

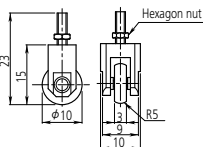

Order No.
901954
901991

### 60° Conical Points

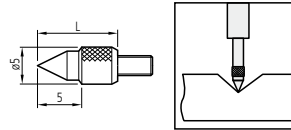

L	Order No.
10	101120
12.7	101190

### 90° Conical Points

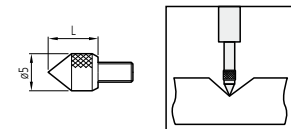

L	Order No.
5	101385
7.14	101191

### 90° Conical Points (Carbide)

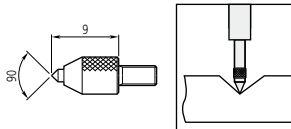

Order No.
120057

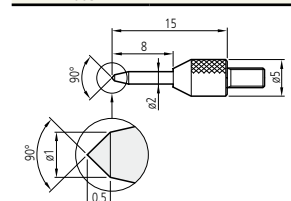

Order No.
120068

### Extension Rods

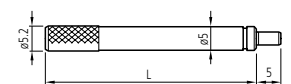

L	Order No.	L	Order No.
10	303611	55	21AAA259G
15	21AAA259A	60	304146
20	303612	65	21AAA259H
25	21AAA259B	70	21AAA259J
30	303613	75	21AAA259L
35	21AAA259C	80	21AAA259M
40	21AAA259D	90	304147
45	21AAA259E	100	303614
50	21AAA259F		

### Needle Points

Unit: mm

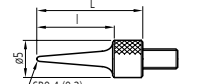

l	L	Order No.
11	15	101121
13	17	137413
21	25	21AAA255
31	35	21AAA256

### Needle Points (Carbide)

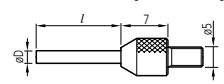

l	D	Order No.
3	0.45	120066
3	1	120065
5	0.45	21AAA329
5	1	21AAA330
5	1.5	21AAA335
8	1	21AAA331
8	2	127257
10	1	21AAA332
10	1.5	21AAA336
13	1.5	120064
18	2	21AAA257
20	1	21AAA333
20	1.5	21AAA337
28	2	21AAA258
40	1	21AAA334
40	1.5	21AAA338
40	2	21AAA339

### Blade Points (Carbide)

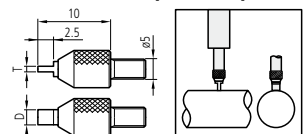

T	W	Order No.
0.4	2	120061
0.6	2	120062
1	4	120063

### Knife Edge Point (Carbide)

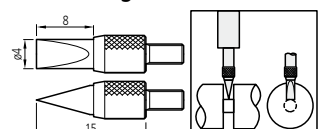

Order No.
120067

\*Note: If the perpendicularity with the stem or parallelism with the reference surface is required when using Flat Points, it is necessary to use a custom-made indicator/contact-point assembly. Consult Mitutoyo for advice.

# System Connections and Comparison of Counter Functions

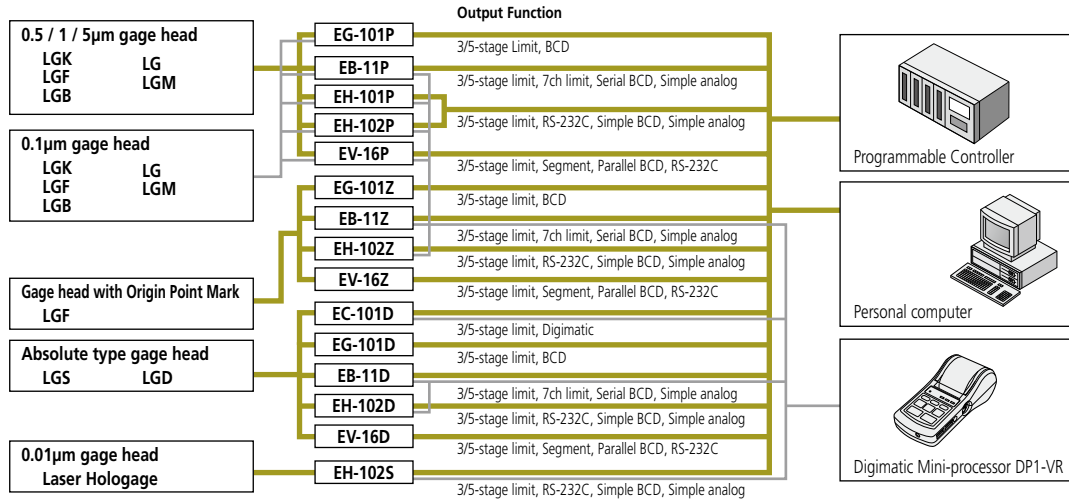

Display unit	EC Counter			EG Counter			EB Counter			EH Counter			EV Counter		
	EC-101D	EG-101P	EG-101Z	EG-101D	EB-11P	EB-11Z	EB-11D	EH-101P	EH-102P	EH-1002Z	EH-102S	EH-102D	EV-16P	EV-16D	EV-16Z
<b>Applicable gages</b>															
0.01µm Laser Hologage											✓				
0.1µm LG / LGM		✓			✓			✓	✓				✓*1		
0.1µm LGK / LGB / LGF		✓			✓			✓	✓				✓*1		
0.5µm LGK / LGF		✓			✓			✓	✓				✓		
0.5µm LGF with Origin Point Mark				✓			✓			✓					✓
1µm LGF with Origin Point Mark				✓			✓			✓					✓
1µm LG / LGM		✓			✓			✓	✓				✓		
1µm LGK / LGB / LGF		✓			✓			✓	✓				✓		
5µm LGF		✓			✓			✓	✓				✓		
0.01mm LGD / LGS	✓			✓			✓					✓		✓	
<b>Functions</b>															
Number of connectable gages	1	1	1	1	1	1	1	1	2	2	2	2	6	6	6
Display	✓	✓	✓	✓	✓	✓	✓	✓	✓	✓	✓	✓	*1	*1	*1
Zero set	✓	✓	✓	✓	✓	✓	✓	✓	✓	✓	✓	✓	*1	*1	*1
Presetting	✓	✓	✓	✓	✓	✓	✓	✓	✓	✓	✓	✓	*1	*1	*1
Direction switch	✓	✓	✓	✓	✓	✓	✓	✓	✓	✓	✓	✓	✓	✓	✓
GO/NG indication	✓	✓	✓	✓	✓	✓	✓	✓	✓	✓	✓	✓	✓	✓	✓
GO/NG output	✓	✓	✓	✓	✓	✓	✓	✓	✓	✓	✓	✓	✓	✓	✓
5-stage tolerance display/output	✓	✓	✓	✓	✓	✓	✓	✓	✓	✓	✓	✓	✓	✓	✓
3-stage tolerance display/output	✓	✓	✓	✓	✓	✓	✓	✓	✓	✓	✓	✓	✓	✓	✓
mm/inch switch	✓	✓	✓	✓	✓	✓	✓	✓	✓	✓	✓	✓	✓	✓	✓
ABS gage zero set	✓	✓		✓	✓	✓	✓					✓	✓	✓	✓
ABS/INC gage changeover	✓			✓	✓	✓	✓					✓	✓	✓	✓
Peak (max / min) hold		✓	✓	✓	✓	✓	✓	✓	✓	✓	✓	✓	✓	✓	✓
Run out (TIR) measurement		✓	✓	✓	✓	✓	✓	✓	✓	✓	✓	✓	✓	✓	✓
Double count	✓	✓	✓	✓				✓	✓	✓	✓	✓			
Sum / difference calculation								✓	✓	✓	✓	✓			
Lower digit blank-out								✓	✓	✓	✓	✓			
External zero set		*2	*2	*2	*2	*2	*2	✓	✓	✓	✓	✓	✓	✓	✓
External preset	✓	✓	✓	✓	✓	✓	✓	✓	✓	✓	✓	✓	✓	✓	✓
External hold	✓	✓	✓	✓	✓	✓	✓	✓	✓	✓	✓	✓	✓	✓	✓
External tolerance set (when a PC is used)				✓	✓	✓	✓	✓	✓	✓	✓	✓	✓	✓	✓
External tolerance memory switch (when I/O is used)		✓	✓	✓	✓	✓	✓	✓	✓	✓	✓	✓	✓	✓	✓
External peak-hold cancel		✓	✓	✓	✓	✓	✓	✓	✓	✓	✓	✓	✓	✓	✓
Inter-axial calculation function													✓	✓	✓
<b>Output</b>															
Power-supply voltage error	✓	✓	✓	✓	✓	✓	✓	✓	✓	✓	✓	✓	✓	✓	✓
Overspeed error	✓	✓	✓	✓	✓	✓	✓	✓	✓	✓	✓	✓	✓	✓	✓
Overflow error	✓	✓	✓	✓	✓	✓	✓	✓	✓	✓	✓	✓	✓	✓	✓
Gage error	✓	✓	✓	✓	✓	✓	✓	✓	✓	✓	✓	✓	✓	✓	✓
Tolerance setting error	✓	✓	✓	✓	✓	✓	✓	✓	✓	✓	✓	✓	✓	✓	✓
Communication error								✓	✓	✓	✓	✓	✓	✓	✓
Parallel BCD output		✓	✓	✓									✓	✓	✓
Serial BCD output					✓	✓	✓								
Simple BCD output					✓	✓	✓	✓	✓	✓	✓	✓			
Simple analog output					✓	✓	✓	✓	✓	✓	✓	✓			
Tolerance judgment output	*3	✓	✓	✓	✓	✓	✓	✓	✓	✓	✓	✓	✓	✓	✓
Limit output				✓	✓	✓	✓								
Segment output													✓	✓	✓
RS-232C output								*3	*3	*3	*3	*3	✓	✓	✓
Digimatic output	*5				✓	✓	✓	*4	*4	*4	*4	*4			
USB output for SESORPAK								✓	✓	✓	✓	✓			
RS link								*3	*3	*3	*3	*3	✓	✓	✓
RS link (maximum number of gages)								6	12	12	12	12	60	60	60

\*1: When an optional D-EV is connected. \*2: Enabled by setting "0" via external presetting. \*3: Switchable between the Digimatic output. \*4: Switchable between the RS-232C output. \*5: Switchable between the tolerance judgment output.

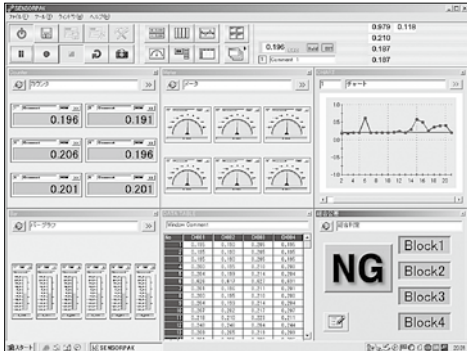

Measurement screen

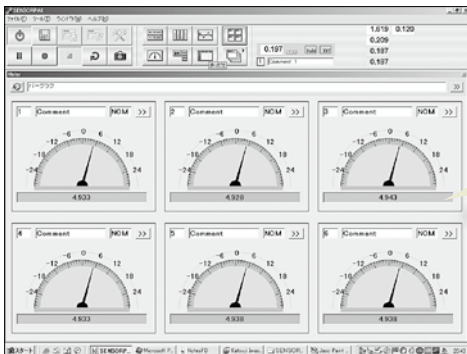

Meter screen

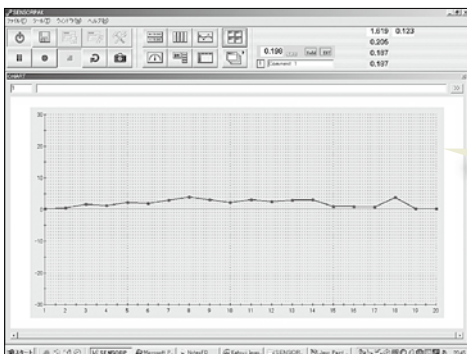

Chart screen

This software facilitates the loading of measurement data from the EH / EV counter or Litematic USB connection is possible with EH counter, too into user's personal computer.

### FEATURES

- Maximum 60 channels of measuring points can be processed.
- Arithmetical calculation and maximum width calculation using the measurement data.
- Export of measurement data into MS-Excel.
- Various graphic functions (numeric value display, meter display, bar-graph display, overall judgment display)
- Frequency of data loading: Max. 9999 times (60ch) to 60000 times (6CH)

### Real-time measurement data display

Measures the tilt of a pin in three directions to determine its reference position and inclination. With the real-time measurement data display, workpieces can be set up while positioning.

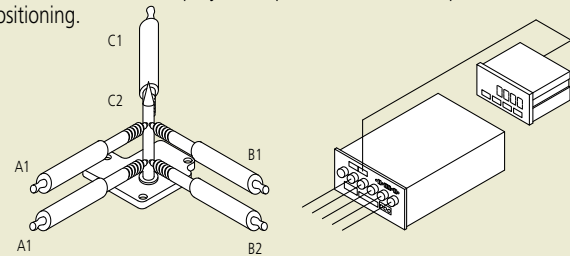

### Ongoing measurement data feedback monitoring

Monitors ongoing feedback of press work in progress. This allows confirmation of time series data.

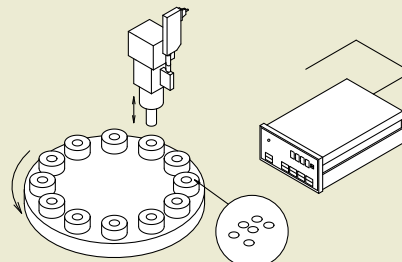

## SPECIFICATIONS

Order No.	02NGB070 (Software only)	02NGB071 (Software plus I/O cable)
Display function	Display type: Counter, bar graph, meter, chart (capable of simultaneous display) Tolerance judgment result: Color display (green/red) Connectable gages: max. 60 gages	
Calculation functions	Calculation items: Sum, difference, total, average, maximum, minimum, range (maximum–minimum), calculation with a constant Connectable gages: Max. 30 calculation functions (between two gages)	
Total tolerance judgment	GO/NG judgment (by specifying gages to be used for total tolerance judgment) GO/NG signal output with optional I/O cable	
Input function	Trigger function: by means of key, timer or external TRG (with optional I/O cable) Data input frequency: Max. 9999 times (with 60 gages connected) to 60000 times (with 6 gages connected)	
Output function	Direct output to EXCEL spreadsheet, CSV file output (compatible with MeasureLink)	
Connectable items	Various Mitutoyo counters (those compatible with RS Link)	
System Environments	Recommendation: PC/AT compatible machine, CPU: Pentium4 2GHz or higher, Memory: 2GB or more Disk: 2GB or more, OS: Windows 7/8.1(32bit/64bit)	

Currently supported languages: English, German, French, Spanish  
User's manual: English

Display Units

# EC Counter

DIN size (96 x 48mm) assembly-type display unit

## FEATURES

- Employs the DIN size (96x48mm) and mount-on-panel configuration, which greatly facilitates incorporation into a system.
- Can either produce tolerance judgment output or Digimatic output.



## Dimensions

Unit: mm

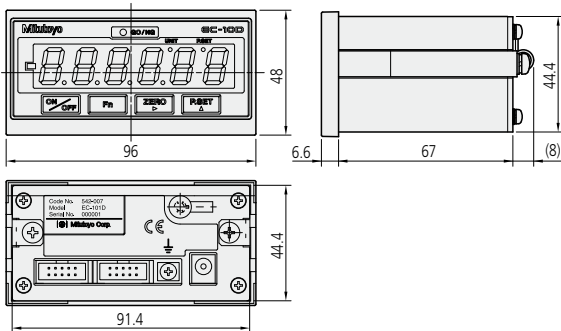

## SPECIFICATIONS

Order No.	542-007*	
Model No.	EC-101D	
Resolution	0.01mm (±9999.99) / .0005" (±99.9995") / .001" (±999.999") 0.001mm (±9999.999) / .00005" (±9.99995") / .0001" (±99.999") [automatic setting by gage]	
Display	Sign plus 6 digits (Green LED)	
Tolerance judgment display	LED display (3 steps: Amber, Green, Red)	
External output (switching type)	Tolerance judgment output	-NG, OK, +NG (open-collector)
	Data output	Digimatic output
Control input	External PRESET, external HOLD	
Rating	Power supply voltage	Supplied AC adapter, or 9 - 12V DC
	Power consumption	4.8W (max. 400mA)
Operation/storage temperature range	Operation: 0 - 40°C / Storage: -10 to 50°C	
External dimensions	96 (W) x 48 (H) x 84.6 (D) mm	
Standard Accessories	AC adapter: No.06AEG302JA	
Applicable head	LGD, LGS, ID, SD	
Applicable input	Digimatic code (SPC)	
Number of gage inputs	1	
Mass	220g	

\* To denote your AC power cable add the following suffixes to the order No.: A for UL/CSA, D for CEE, DC for CCC, E for BS, K for KC, C and No suffix are required for PSE.

## Optional Accessories

- Connecting cable for digimatic mini-processor:  
No.936937 (1m), No.965014 (2m)
- DC plug PJ-2: No.214938
- I/O cable (2m): No.C162-155

## Input / output specifications

### 1) Compatible plug

MIL type connector FAS-10-17 (YAMAICHI), XG4M-1030-T (OMRON)

### 2) Pin assignment

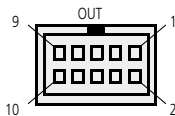

Pin No.	I/O	Description	Function	Optional I/O cable color
1		COM	Connected to the internal GND	Light brown/black
2	O	+NG	Tolerance output: The relevant output terminal falls to L.	Light brown/red
3	O	GO	At an error display [+NG=-NG=L]	Yellow/black
4	O	-NG	At an error display [+NG=-NG=L]	Yellow/red
5	I	HOLD	HOLD input	Bright green/black
6	I	P.SET	PRESET input (to cancel the error)	Bright green/red

Other than the above listed shall be unconnected.  
\* Output from each pin in the Digimatic output mode may differ from those which are described in the table above.  
\* One end of the I/O cable (2m, optional) consists of separate wires for connection as appropriate. The cable's F.G wire (with solderless terminal, green) should be connected to the grounding terminal of the main unit.

### 3) I/O circuit

#### 1. Output circuit (-NG, GO, +NG)

Transistor is "ON" when the open-collector output is "L".

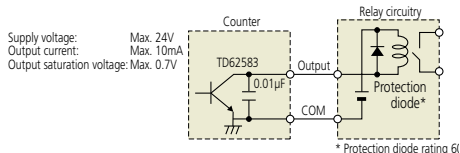

#### 2. Input circuit (PSET, HOLD)

Input is valid when the line is "L".

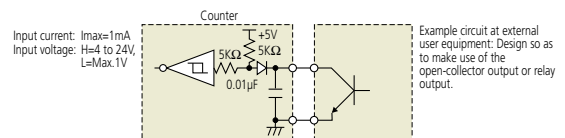

### 4) Timing chart

#### 1. Tolerance judgment output

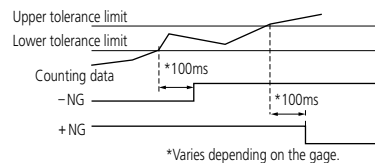

#### 2. External preset/HOLD

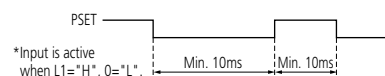

### 5) Optional I/O cable (2m)



# EG Counter

DIN size (96 x 48mm) assembly-type display unit

## FEATURES

- Possible to produce 3-step/5-step x 3 kinds of tolerance output and BCD output.
- Smoothing function can reduce fluctuation of display digits.
- Employs the DIN size (96x48mm) and mount-on-panel configuration, which greatly facilitates incorporation into a system.



542-015



542-017



542-016



For differential square-wave output gage head



For differential square-wave output gage head with Origin Point Mark



For Digimatic code output gage head

## SPECIFICATIONS

Order No.	542-015	542-017	542-016
Model No.	EG-101P	EG-101Z	EG-101D
Quantizing error	±1 count		
Maximum input frequency	1.25MHz, response speed depends on gage specification.		
Resolution	0.01mm (±9999.99mm) / .0005" (±9.9995") / .001" (±99.999") 0.005mm (±9999.995mm) / .00005" (±9.99995") / .0001" (±99.999") 0.001mm (±999.999mm) / .00005" (±9.99995") / .0001" (±99.999") 0.0005mm (±99.9995mm) / .000005" (±9.99995") / .00001" (±9.99999") 0.0001mm (±99.9999mm) / .000005" (±9.99995") / .00001" (±9.99999")		0.01mm (±9999.99mm) / .0005" (±9.9995") / .001" (±99.999") 0.001mm (±999.999mm) / .00005" (±9.99995") / .00001" (±99.999") [Automatic setting by gage]
Display	Sign plus 6 digits (Green LED)		
Tolerance judgment display	LED display (3 steps: Amber, Green, Red/ 5 steps: Amber, Amber flashing, Green, Red flashing, Red)		
Tolerance judgment output	L1 to L5 (Open-collector / Switchover between L1 to L5 and BCD output with parameter)		
Control output	Normal operation signal (NOM): open-collector		
BCD output	Open-collector / Switchover between 6-digit (positive/negative-true logic) and tolerance judgment output with parameter		
Control input	Presetting, display hold, peak value clear, tolerance judgment BANK switch		
Rating	Power supply voltage	12 - 24V DC	
	Power consumption	6W or less (500mA max.) Ensure at least 1A is available per unit.	
Operating temperature range	0 to 40°C (RH 20 to 80%, no condensation)		
Storage temperature range	-10 to 50°C (RH 20 to 80%, no condensation)		
External dimensions	96 (W) x 48 (H) x 156 (D) mm		
Applicable gage head	LGF, LGK, LGB, LGM, LG, LGH (LGH110 excluded) Models with reference point mark, sine wave output type are excluded.	LGF with reference point mark	LGD, LGS, ID, SD
Applicable input	Differential square-wave	Differential square-wave with origin point mark	Digimatic code (SPC)
Number of gage inputs	1		
Mass	Approx. 400g		

## Dimensions

Unit: mm

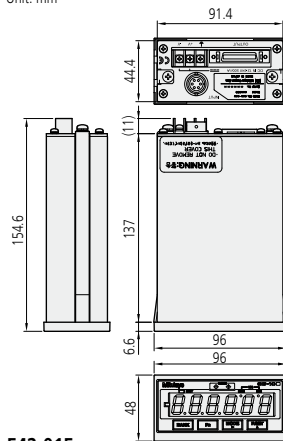

542-015

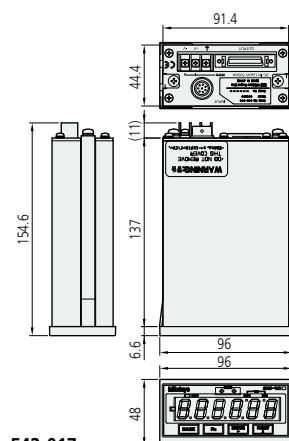

542-017

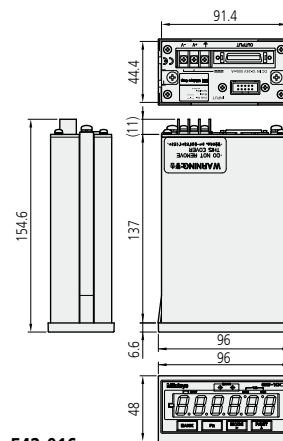

542-016

## Optional Accessories

- I/O output connector (with cover): **No.02ADB440**
- AC adapter: **No.02ADN460**
- AC cable (Japan): **02ZAA000\***
- AC cable (USA): **02ZAA010\***
- AC cable (EU): **02ZAA020\***
- AC cable (Britain): **02ZAA030\***
- AC cable (China): **02ZAA040\***
- AC cable (Korea): **02ZAA050\***
- Terminal connecting cable: **No.02ADD930\***

\* Required when using AC adapter.



## Input / output specifications

### 1) Compatible plug: 02ADB440 (with cover)

### 2) Pin assignment

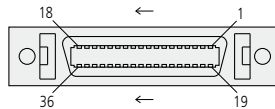

#### 1. In tolerance judgment mode

Pin No.	I/O	Description	Function
1, 2		COM	Connected to the internal GND
3	O	L1	
4	O	L2	Tolerance output: The relevant output terminal falls to L.
5	O	L3	
6	O	L4	At an error display [L1=L5=L]
7	O	L5	
10	O	NOM	Normal output
27	I	SET1	BANK, Peak mode setting: Enter the setting value with SET. Determines
28	I	SET2	the mode and bank to be used with MODE and BANK, respectively.
29	I	MODE	Determining the change of peak value: Combined operation with SET
34	I	HOLD	HOLD input
35	I	PSET	At normal measurement: Preset At peak value measurement: Peak clear
36	I	BANK	Determining the change of BANK: Combined operation with SET
		NC	Other than the above listed shall be unconnected.

#### 2. In BCD output mode

Pin No.	I/O	Description	Pin No.	I/O	Description	Pin No.	I/O	Description
1		COM	13	O	4X102	25	O	4X105
2		COM	14	O	8X102	26	O	8X105
3	O	1X100	15	O	1X103	27	I	SET1
4	O	2X100	16	O	2X103	28	I	SET2
5	O	4X100	17	O	4X103	29	I	MODE
6	O	8X100	18	O	8X103	30	—	NC
7	O	1X101	19	O	1X104	31	O	SIGN
8	O	2X101	20	O	2X104	32	O	NOM
9	O	4X101	21	O	4X104	33	O	READY
10	O	8X101	22	O	8X104	34	I	HOLD
11	O	1X102	23	O	1X105	35	I	PSET
12	O	2X102	24	O	2X105	36	I	INH

- \* Pin Nos. 3 to 26, and 31 can be logically inverted via the corresponding parameter.
- \* SIGN: Represents the sign of counting value as either "H" for positive value or "L" for negative value.
- \* READY: It will be "L" during the output data determination.
- \* INH: During input operation each output data from Pin No. 3 to 26, and 31 will be "H".
- \* External output terminal is valid at "L".
- \* NOM, HOLD, and PSET function in the same way as in the tolerance judgment mode.
- \* External input uses negative true logic as "L" corresponding to "Valid".

### 3) I/O circuit

#### 1. Output circuit (NOM, L1 to L5)

Transistor is "ON" when the open-collector output is "L".

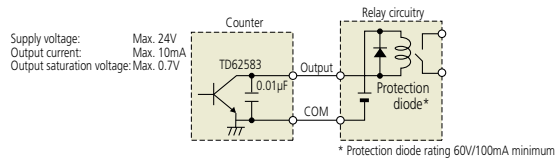

#### 2. Input circuit (SET, MODE, BANK, PSET, HOLD)

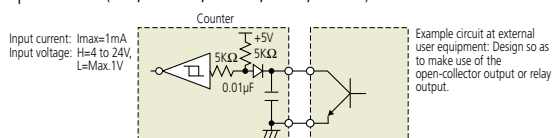

### 4) Timing chart

#### 1. Power ON characteristics

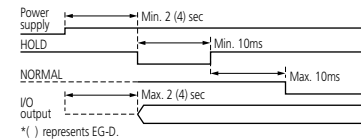

#### 2. Tolerance output

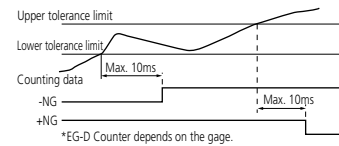

#### 3. External preset/ Peak clear

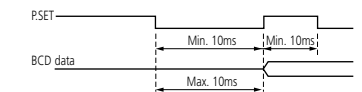

#### 4. Peak mode/BANK specification

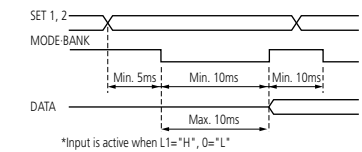

#### 5. HOLD timing

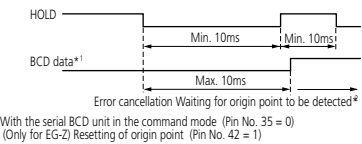

- \*1: With the serial BCD unit in the command mode (Pin No. 35 = 0)
- \*2: (Only for EG-Z) Resetting of origin point (Pin No. 42 = 1)

#### 6. Interval mode

The data will be continuously output according to the internal timing of the counter.

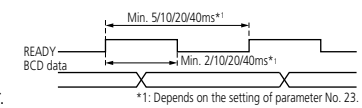

#### 7. Command mode

The data will be output with both the HOLD and READY lines being synchronized.

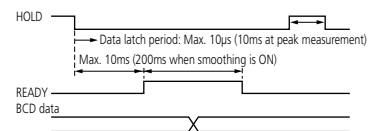

#### 8. INH input

BCD data output is OFF during the input of INH.

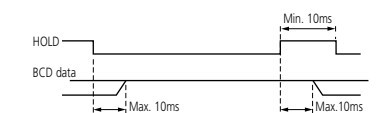

# EB Counter

DIN size (96 x 48mm) assembly-type display unit

## FEATURES

- Possible to produce 3-step/5-step x 7 kinds of tolerance output and limit value output independently for each of 7 channels.
- Provided with serial BCD output capability, which makes the connection to a programmable controller or personal computer, etc., possible with the minimum cabling requirement.
- Possible to perform dynamic measurement with the simplified analog output.



542-092-2



542-094-2



542-093-2



For differential square-wave output gage head



For differential square-wave output gage head with Origin Point Mark

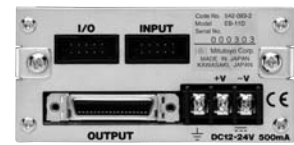

For Digimatic code output gage head

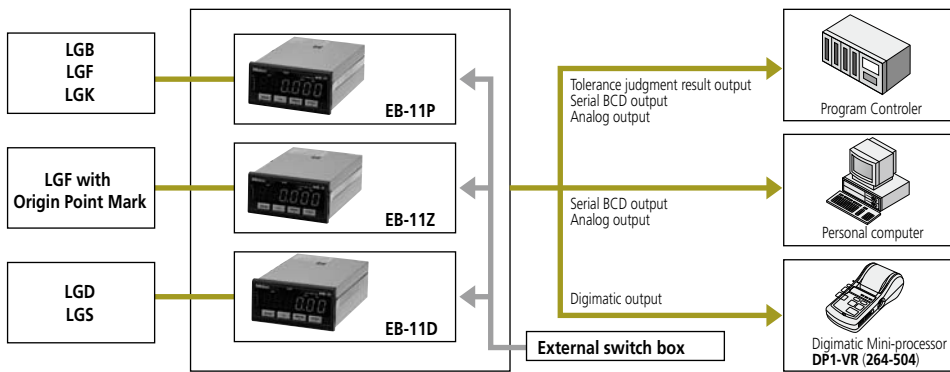

## Optional Accessories

- I/O output connector (with cover): **No.02ADB440**
- AC adapter: **No.02ADN460**
- AC cable (Japan): **02ZAA000\***
- AC cable (USA): **02ZAA010\***
- AC cable (EU): **02ZAA020\***
- AC cable (Britain): **02ZAA030\***
- AC cable (China): **02ZAA040\***
- AC cable (Korea): **02ZAA050\***
- Terminal connecting cable: **No.02ADD930\***
- \* Required when using AC adapter.
- External switch box  
The tolerance values or preset values can be easily input.
- No.02ADF180** (with 2m cable)

## SPECIFICATIONS

Order No.	542-092-2	542-094-2	542-093-2
Model No.	EB-11P	EB-11Z	EB-11D
Quantizing error	±1 count		
Maximum input frequency	1.25MHz (2-phase square wave), response speed depends on gage specification.		Response speed depends on gage specification.
Resolution	0.01mm (±9999.99mm) / .0005" (±99.9995") 0.005mm (±9999.995mm) / .00005" (±9.99995") 0.001mm (±999.999mm) / .00005" (±9.99995") 0.0005mm (±99.9995mm) / .000005" (±.999995") 0.0001mm (±9.9999mm) / .000005" (±.999995")		0.01mm (±9999.99mm) / .0005" (±99.9995") 0.005mm (±9999.995mm) / .00005" (±9.99995") 0.001mm (±999.999mm) / .00005" (±9.99995") 0.0005mm (±99.9995mm) / .000005" (±.999995") 0.0001mm (±9.9999mm) / .000005" (±.999995")
Display	Sign plus 6 digits (Green LED)		
Tolerance judgment display	LED display (3 steps: Amber, Green, Red / 5 steps: Amber, Amber flashing, Green, Red flashing, Red)		
Input/output	Tolerance judgment output	L1 to L5, open-collector	
	Control output	Normal operation signal (NOM), open-collector	
	Control input	Presetting, display hold, peak value clear, tolerance judgment BANK switch, open-collector or no-voltage contact signal (with/without contact point)	
Interface	Serial BCD	Bit serial format, open-collector	
	Analog output	2.5V+Counting value× Voltage resolution (25mV/2.5mV): Full-scale 0 to 5V	
	Digimatic input/output	<ul style="list-style-type: none"> <li>• Connecting to the external switch box (No.02ADF180) makes it easy to enter tolerance limits and preset values. (Note) This function is not available when the gage is connected to DP-1VR, Digimatic Mini-Processor.</li> <li>• It can only be connected to DP-1VR Digimatic Mini-Processor (No.264-504).</li> <li>• Number of tolerance steps can be expanded by assembling EB-D counters.</li> </ul>	
Rating	Power supply voltage	12 - 24V DC	
	Power consumption	6W or less (50mA max.) Ensure at least 1A is available per unit.	
Operating temperature range	0 to 40°C (RH 20 to 80%, no condensation)/ -10 to 50°C (RH 20 to 80%, no condensation)		
External dimensions	96(W)×48(H)×156(D)mm		
Applicable gage head	LGF, LGK, LGB Models with reference point mark, sine wave output type are excluded.	LGF with reference point mark	LGS, LGD
Applicable input	Differential square-wave	Differential square-wave with origin point mark	Digimatic code (SPC)
Number of gage inputs	1		
Mass	Approx. 400g	Approx. 400g	Approx. 400g

## Dimensions

Unit: mm

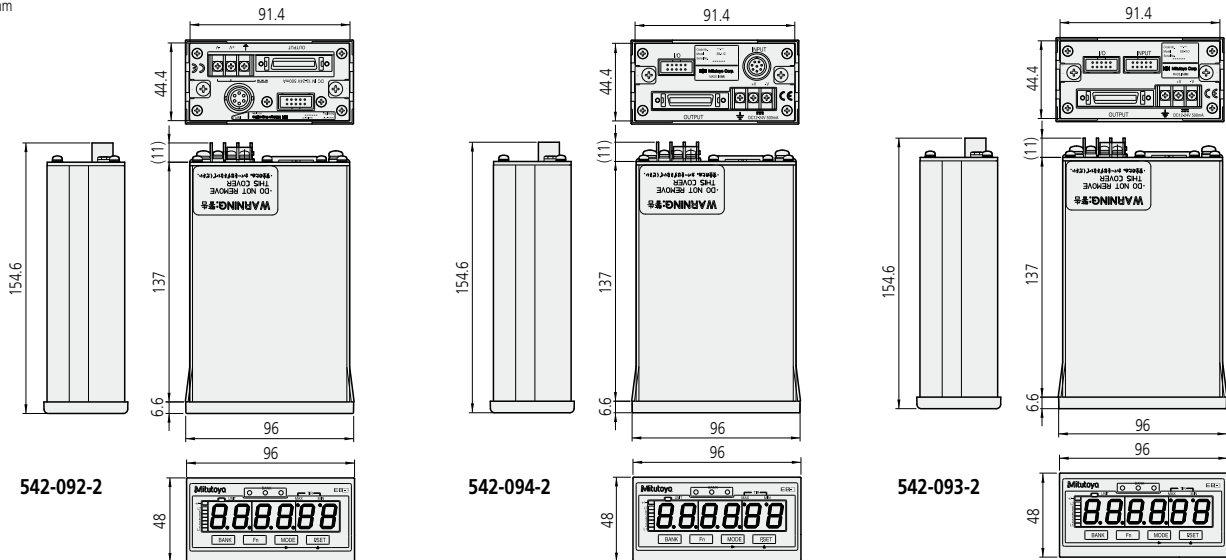

## Powerful tolerance judgment function

### 1) Keeps up to seven 3-step/5-step tolerance limits in memory.

It is possible to switch these tolerance limits with an appropriate button operation or external signal.

#### • Stop position adjustment

Adjust the stop position depending on the workpiece type. For this control use the tolerance judgment signals.

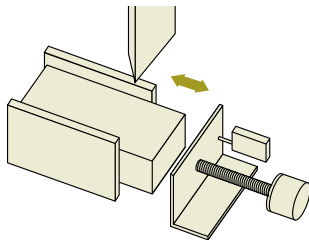

#### • Indicator display/output where 3 steps of tolerance limit are set

	GO/NG indicator	LIMIT indicator and I/O output
Measured value < S1	Amber ON	L1
S1 ≤ measured value ≤ S4	Green ON	L3
S4 ≤ measured value	Red ON	L5

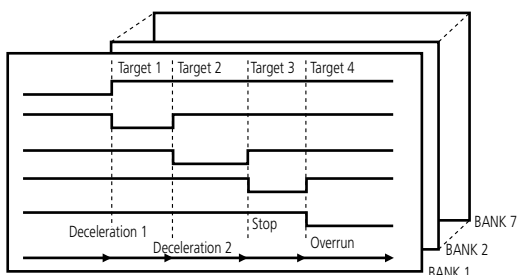

#### • Indicator display/output where 5 steps of tolerance limit are set

	GO/NG indicator	LIMIT indicator and I/O output
Measured value < S1	Amber ON	L1
S1 ≤ measured value ≤ S2	Amber flash	L2
S2 ≤ measured value ≤ S3	Green ON	L3
S3 ≤ measured value ≤ S4	Red flash	L4
S4 ≤ measured value	Red ON	L5

### 2) Possible to selectively keep two of the limit values for 7 channels.

It is possible to switch these tolerance limits with an appropriate button operation or external signal.

#### • Sorting workpieces by value

It is possible to sort workpieces according to user-defined value ranges.

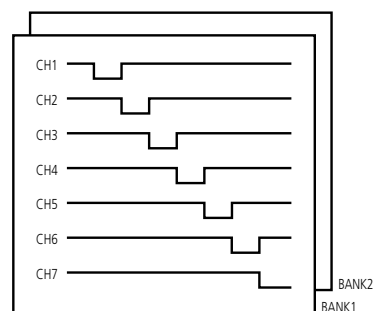

# EB Counter

DIN size (96 x 48mm) assembly-type display unit

## Input / output specifications

1) Suitable plug: 02ADB440 (with cover)

2) Pin assignment

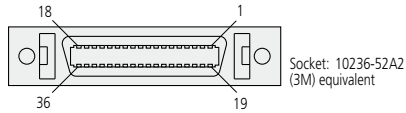

Pin No.	Description	I/O	Function	
1	COM	—	Common terminal for input/output circuit (to be connected to the internal GND)	
2	COM	—	Common terminal for input/output circuit (to be connected to the internal GND)	
3	L1	OUT	Tolerance judgment result output • At an error AL1, AL5= Output of "L" AL2, AL3, AL4 = Output of "H"	
4	L2	OUT		
5	L3	OUT		
6	L4	OUT		
7	L5	OUT		
8	L6	OUT		
9	L7	OUT		
10	NOM	OUT		Outputs "L" where counting is possible.
11 - 20	N.C.	—		Unconnected terminal
21	BCD_CK	OUT		Serial BCD output
22	BCD_ST	OUT		
23	BCD_DT	OUT		
24	ANALG	OUT	Analog output	
25	ANGND	OUT		
26	AREG	IN	Analog range changeover: Enter in combination with SET BANK: Sets the PSET tolerance to the specified bank. MODE: NOM, MAX, MIN, TIR settings AREG: Analog range specification	
27	SET1	IN		
28	SET2	IN		
29	SET3	IN		
30	MODE	IN	Peak changeover: Enter in combination with SET.	
31	N.C.	—	Unconnected terminal	
32	BANK	IN	BANK changeover: Enter in combination with SET.	
33	N.C.	—	Unconnected terminal	
34	HOLD	IN	<ul style="list-style-type: none"> <li>The display value is held during input.</li> <li>Data output proceeds while the serial BCD interface is used.</li> <li>When an error has occurred, the error will be cleared at the rise of this signal.</li> <li>Perform presetting.</li> </ul>	
35	PSET	IN	Peak clear: When entered during the peak mode, it serves as peak clear.	
36	N.C.	—	Unconnected terminal	

## 3) I/O circuit

1. Output circuit

Transistor is "ON" when the open-collector output is "L".

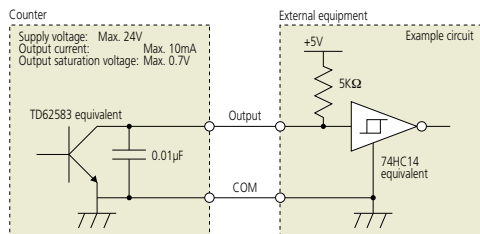

2. Input circuit (SET, MODE, BANK, PSET, HOLD)

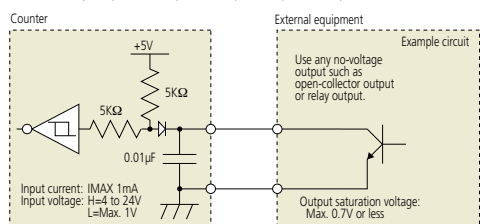

## Simple Analog Output

Output waveforms can be monitored with an analog recorder connected.

1) Output specifications

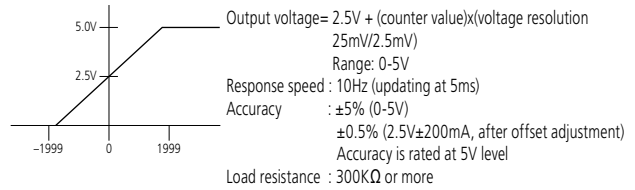

2) Measuring range

SET	Parameter	Measuring range (mm) / Resolution (mm)					Voltage		
3	2	1	No.30	10µm gage	5µm gage	1µm gage	0.5µm gage	0.1µm gage	
0	0	0	0	±0.99 / 0.01	±0.095 / 0.005	±0.099 / 0.001	±0.0095 / 0.0005	±0.0099 / 0.0001	25mV
0	0	1	1	±9.99 / 0.01	±0.995 / 0.005	±0.999 / 0.001	±0.0995 / 0.0005	±0.099 / 0.0001	2.5mV
0	1	0	2	±99.90 / 0.1	±9.950 / 0.05	±9.990 / 0.01	±0.9950 / 0.005	±0.9990 / 0.001	2.5mV
0	1	1	3	±999.00 / 1	±99.500 / 0.5	±99.900 / 0.1	±9.9500 / 0.05	±9.9900 / 0.01	2.5mV
1	0	0	4	±9990.00 / 10	±995.000 / 5	±999.000 / 1	±99.500 / 0.5	±99.900 / 0.1	2.5mV

3) Example of connection to external equipment

This is a connection example to an external programmable controller.

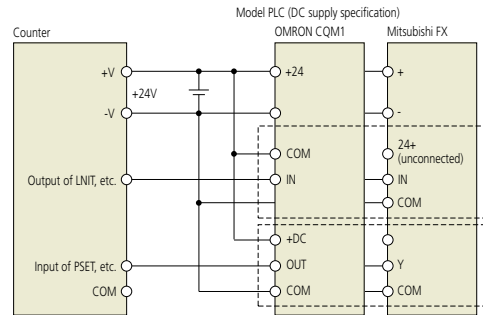

4) Sample program for collecting serial BCD outputs

For OMRON CQM1 (to connect one unit of counter)

LD NOT	0000		P0: Detecting if CK = "H".
AND	0002		
CLC (41)			P2(DATA) = L CY clear
LD NOT	0000		P0: Detecting if CK = "H".
AND NOT	0002		
STC (40)			P2(DATA) = H CY clear
LD NOT	0000		P0: Detecting the rise of CK.
@ROL (27)		DM0350	Left-rotate shift with carry
@ROL (27)		DM0351	Right-rotate shift with carry
LD NOT	0001		P1: Detecting if STB = H
@MOV (21)	DM0350	DM0360	Transfers the result.
@MOV (21)	DM0351	DM0361	Transfers the result.

## 6) Timing chart

### 1. Power ON characteristics

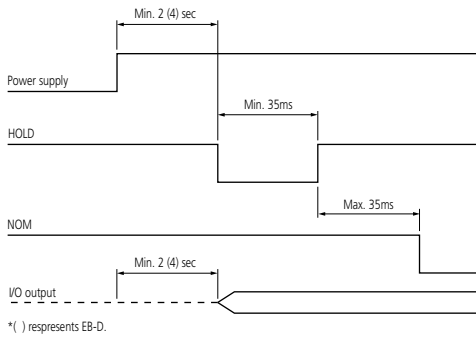

### 2. Tolerance judgment result output period

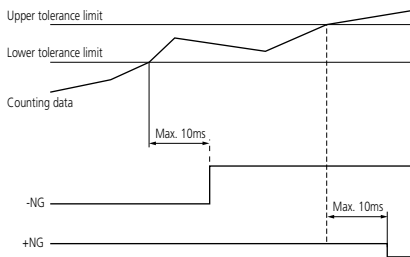

### 3. External preset/Peak clear

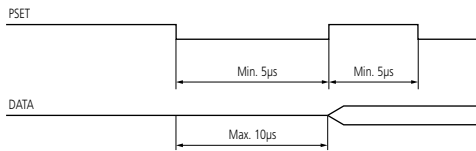

### 4. Peak mode/BANK specification

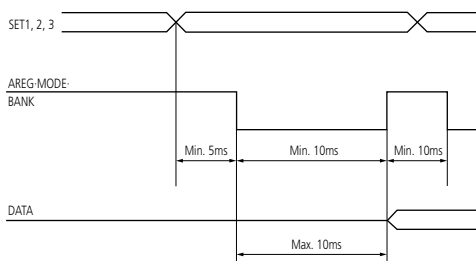

### 5. HOLD timing

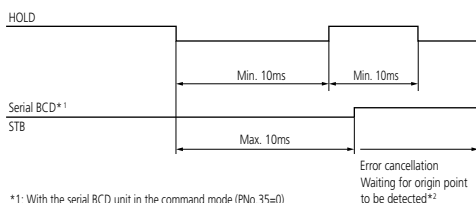

\*1: With the serial BCD unit in the command mode (PNo.35=0)

\*2: (Only for EV-Z) Resetting of origin point (PNo.42=1)

## External switch box (optional)

Makes it easy to enter tolerance settings and preset values.  
**02ADF180** (with a 2m cable)



# EH Counter

DIN size (144 x 72mm) assembly-type display unit

## FEATURES

- Multi-functional counter with functions of zero-set, preset, and tolerance judgment
- Equipped with an RS-232C interface as standard. This allows data transfer to a personal computer, etc.
- A multi-point measuring system can easily be built up with the built-in networking function (RS link). (Max. 12 points)



542-075



542-071



542-073



For differential square-wave output gage head (single axis)



For differential square-wave output gage heads (2 axes)



For differential square-wave output gage heads with Origin Point Mark (2 axes)



542-074



542-072



For differential sine-wave output gage heads (2 axes)



For Digimatic code output gage heads (2 axes)

## SPECIFICATIONS

Order No.	542-075*	542-071*	542-073*	542-074*	542-072*
Model No.	EH-101P	EH-102P	EH-102Z	EH-102S	EH-102D
Number of axes to be displayed	1 axis	2 axes			
Quantizing error	±1 count				
Maximum input frequency	2.5MHz (2-phase square wave)			1MHz (2-phase sine wave)	
Resolution	0.01mm (±9999.99mm) / .0005" (±99.9995") 0.001mm (±999.999mm) / .00005" (±9.99995") 0.0001mm (±99.9999mm) / .000005" (±.999995") [Parameter set]			0.01 / 0.001μm	
Display	Sign plus 8 digits (Green LED)				
Tolerance judgment display	LED display (3 steps: Amber, Green, Red/ 5 steps: Amber, Amber flashing, Green, Red flashing, Red)				
Interface	RS-232C/USB/parameter selection via digimatic (only DP-1VR, digimatic mini-processor can be connected) (USB used only with SENSORPAK.) Selection by parameter from 3-step, 5-step, or digit BCD Total tolerance judgment output (when tolerance function is enabled) Analog output (1V-4V)				
Input/output	Control output	Normal operation signal (NOM): open-collector			
	Control input	Display BANK switching, peak mode, presetting, display hold, hold per axis: open-collector or no-voltage contact signal (with/without contact point)			
Rating	Power supply voltage	Supplied AC adapter, or 12 - 24V DC			
	Power consumption	8.4W (max. 700mA) Ensure at least 1A is available per unit.			
Operating temperature (humidity) range	0 to 40°C (RH 20 to 80%, no condensation)				
Storage temperature(humidity) range	-10 to 50°C (RH 20 to 80%, no condensation)				
External dimensions	144 (W) x72 (H) x156.7 (D) mm				
AC adpater / AC cable	AC adapter: No.02ADN460 / AC cable: No.02ZAA000, AC cable (Japan): No.02ZAA000*, AC cable (USA): No.02ZAA010*, AC cable (EU): No.02ZAA020*, AC cable (Britain): No.02ZAA030*, AC cable (China): No.02ZAA040*, AC cable (Korea): No.02ZAA050*				
Applicable gage head	LGF, LGK, LGB, LGM, LG, LGH (LGH-110 excluded) Models with reference point mark, sine wave output type are excluded.		LGF with reference point mark	LGB sine wave output / Linear scale sine wave output	
Applicable input	Differential square-wave			Differential sine-wave	
Number of gage inputs	1		2		
Mass	Approx. 760g	Approx. 800g	Approx. 800g	Approx. 900g	Approx. 800g

\* To denote your AC power cable add the following suffixes to the order No.: A for UL/CSA, D for CEE, DC for CCC, E for BS, K for KC, C and No suffix are required for PSE. For those models of the Order No. with Suffix "1", AC adapter is not attached as a standard accessory.

## Dimensions

Unit: mm

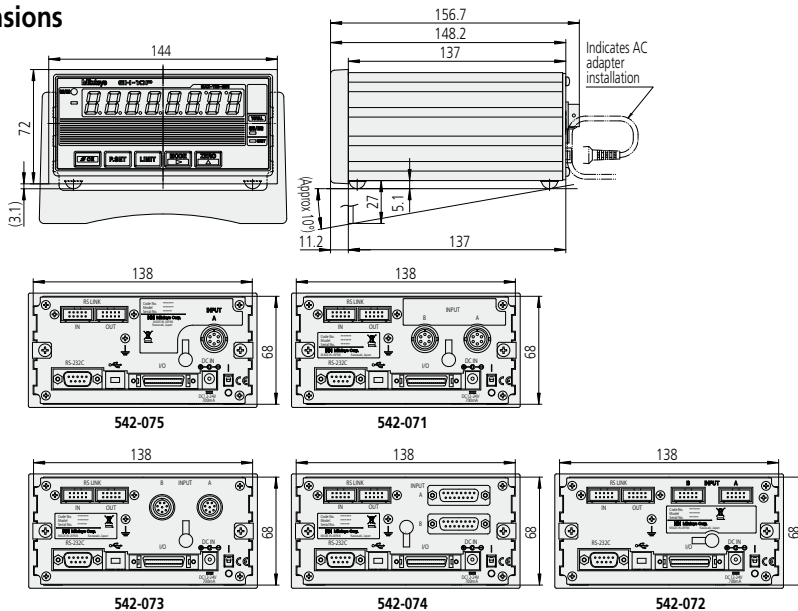

## Optional Accessories

- I/O output connector (with cover): **No.02ADB440**
- RS Link connecting cable (0.5m): **No.02ADD950**
- RS Link / SPC connecting cable (1m): **936937**
- RS Link / SPC connecting cable (2m): **965014**

## Functions

### 1. Zero-set

Sets the displayed value to 0 at any position of the spindle.

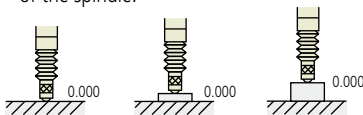

### 2. Tolerance judgment indication/output

Sets two (or four) desired tolerances for three (or five) stages. Judgment results can be output to an external device.

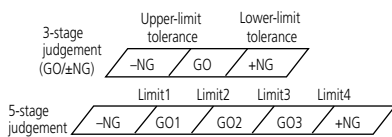

### 3. Peak hold/TIR measurement

Allows switching to the measurement mode for maximum value, minimum value, and run out value (maximum - minimum), in addition to the normal measurement mode.

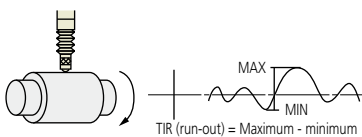

### 4. Digimatic output

Data can be output to various printers and statistical processing devices, such as DP-1VR and MUX-10LF, using Digimatic code (SPC) output.

### 5. Preset

Presets the display at any value. Counting begins at the preset value.

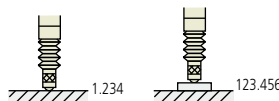

### 6. Segment output

The function used to divide the specified range into 21 equal segments and output where the measured value falls among the 23 segments, including the segments before and after the divided segments.

### 7. BCD output

The displayed value can be output as one of I/O signal to a sequence, etc.

### 8. Double count

Displays a value twice the actual count value. Allows the direct reading of diameter for cylindrical objects.

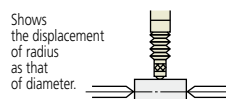

### 9. I/O output

For input/output of external control signals and tolerance judgment result to/from the PLCs or other external devices.

### 10. External control

Zero set, preset and display hold can be controlled from the I/O terminals.

### 11. Direction switch

Selects the counting direction of (+) or (-), whichever is convenient with a given direction of spindle movement.

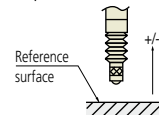

### 12. Inch/mm switch

Selects mm or inch as the unit of display, and enables the automatic conversion of displayed values according to the selected unit.

### 13. ABS gage zero set

Sets the absolute origin of an LGD gage from the counter side. Once set, the absolute origin will be maintained even during a power failure or when the counter is disconnected.

### 14. Sum/difference calculation

Enables measurement of thickness or step height using two gages.

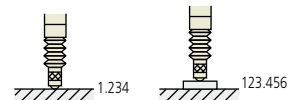

### 15. Communication via RS-232C interface

RS-232C allows communication with a personal computer. It allows not only the reading of measured values but also data transmission to the counter and remote operations, such as when changing various settings.

# EH Counter

DIN size (144 x 72mm) assembly-type display unit

## BCD Output

Simultaneously outputs at channels [A] and [B] in groups of 4 bits.

### 1) Timing chart

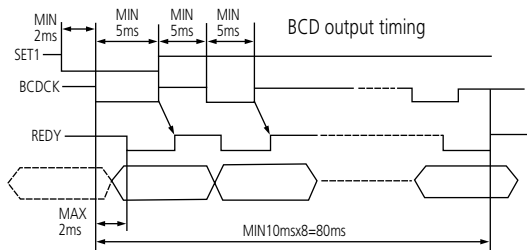

### 2) Data format

	LSD (Least significant digit)				MSD (Most significant digit)			
	D1	D2	D3	D4	D5	D6	D7	D8
A/B_bit0	1 x 10 <sup>0</sup>	1 x 10 <sup>0</sup>	.....	.....	.....	.....	.....	1 x 10 <sup>7</sup>
A/B_bit1	2 x 10 <sup>0</sup>	1 x 10 <sup>0</sup>	.....	.....	.....	.....	.....	2 x 10 <sup>7</sup>
A/B_bit2	4 x 10 <sup>0</sup>	1 x 10 <sup>0</sup>	.....	.....	.....	.....	.....	4 x 10 <sup>7</sup>
A/B_bit3	8 x 10 <sup>0</sup>	1 x 10 <sup>0</sup>	.....	.....	.....	.....	.....	8 x 10 <sup>7</sup>
A/B_SIGN	SIGN	BANK	PEAK1	PEAK2				
	+ : H				PEAK1	PEAK2		
	- : L				NOM	L	L	
					MAX	H	L	
		BANK1: L			MIN	L	H	
		BANK2: H			TIR	H	H	

Data output example

	D1	D2	D3	D4	D5	D6	D7	D8
Bits 0-3	1	0	6	5	4	3	2	1
SIGN	L							

▶ -12345601

\* Negative logic output is possible for SIGN, BANK, PEAK, DATA (PNo.21=1).

## Simple analog output

Monitoring of output waveforms is possible with an analog recorder connected.

### 1) Output specification

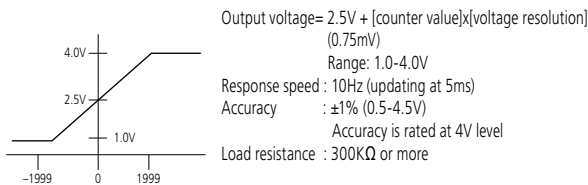

### 2) Measuring range

Parameter	Measuring range (mm) / Resolution (mm)		
No.30	10μm gage	5μm gage	1μm gage
0	±19.99(0.01)	±1.999(0.001)	±0.1999(0.0001)
1	±199.90(0.01)	±19.990(0.01)	±1.9990(0.001)
2	±1999.00(0.1)	±199.900(0.1)	±19.9900(0.01)

## RS Link\* Function

It is possible to connect a maximum of 10 counter units together to carry a maximum of 20 channels of multi-point measurement at a time.

For this connection use a dedicated RS link cable; **02ADD950** (0.5m), **936937** (1m) or **965014** (2m) (The maximum total length of RS link cables permitted for the entire system is 10m.)

\* Patent registered (Japan, U.S.), Patent pending (E.U.)

## RS-232C Communication Functions

Makes it possible not only to log measured values but also make various remote settings including the zero-setting of a counter, etc.

Command format	Corresponding output	Function
GA**CRLF	G#**, +01234.567CRLF	Outputs the [Displayed value] through RS-232C.
CN**CRLF	CH**CRLF	Switches the display to the [Current value].
CX**CRLF	CH**CRLF	Switches the display to the [Maximum value].
CM**CRLF	CH**CRLF	Switches the display to the [Minimum value].
CW**CRLF	CH**CRLF	Switches the display to the [TIR (runout)].
CR**CRLF	CH**CRLF	Zerose
CL**CRLF	CH**CRLF	Clears the peak value.
CP**, +01234567CRLF	CH**CRLF	Inputs the preset value.
CD**, +01234567CRLF	CH**CRLF	Inputs tolerance value S1.
CE**, +01234567CRLF	CH**CRLF	Inputs tolerance value S2.
CF**, +01234567CRLF	CH**CRLF	Inputs tolerance value S3.
CG**, +01234567CRLF	CH**CRLF	Inputs tolerance value S4.
CS**CRLF	CH**CRLF	Cancel the error.
CK**CRLF	CH**, \$CRLF (\$=0 or 1)	Checks the HOLD status.

\*\* : denotes a gage channel number between 01 and 99 ("00" means all channels).

# : denotes the type of data [N: Current value, X: Maximum value, M: Minimum value, W: TIR (runout)].

CRLF: CR (carriage return), LF (line feed).

Note 1: For presetting and tolerance limit setting, enter each value consisting of a sign and 8 digits of numeric value without a decimal point.

Note 2: Perform the tolerance limit setting in the order of CD and CG for the case of 3-step tolerance judgment, and in the order of CD, CE, CF, and CG for the case of 5-step tolerance judgment.

Note 3: The RS communication function will be suspended during key operation (e.g. setting parameters, preset values, or tolerance limits). It automatically resumes the command and data output operation when the gage is recovered to such a condition that the counting is possible.

Note 4: For canceling the counting-standby state, use CS00CRLF (specification of all channels).

## Digimatic Code Output Specifications

Possible to externally output the measured data and connect with a DP-1VR Digimatic Mini-Processor.

### 1) Socket to be used

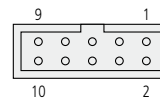

### 2) Data output format: A total of 13 digits will be output as follows.

Each digit is represented by a 4-bit binary, and will be output beginning with the LSB (least significant bit) of the least significant digit in the order of 20 - 21 - 22 - 23.

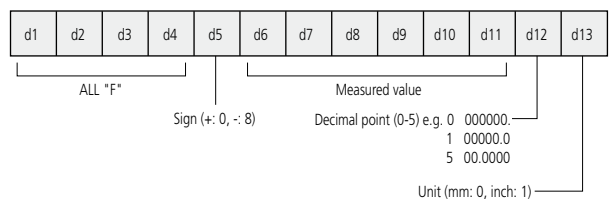



## Input / output specifications

### 1) Suitable plug: 02ADB440 (with cover)

### 2) Pin assignment

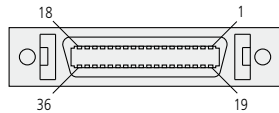

Socket: 10236-52A2 (3M) equivalent

Pin No.	I/O	Description	Tolerance judgement output mode		BCD output mode		
			Function	Description	Function	Description	
1, 2	—	COM	Internally connected to GND.	COM	Internally connected to GND.		
3	O	AL1	[A] Upper row tolerance	A_bit0	[A] Upper row data		
4	O	AL2	· Output "L" only for output-relevant terminal.	A_bit1			
5	O	AL3	· When any error is displayed,	A_bit2			
6	O	AL4	AL1 = L5 = "L"	A_bit3			
7	I/O	AL5	AL2, AL3, AL4="H"	A_SIGN			
8	O	ALLGO	Total tolerance result output "H"=OK "L"=NG	REDY	"L"= data is valid.		
9	O	RS_EXT					
10	O	NOM	Normal output "L"=Normal output, "H"=abnormal output				
11	O	BL1	[B] Lower row tolerance	B_bit1	[B] Lower row data [2-axis model]		
12	O	BL2	· Output "L" only for output-relevant terminal.	B_bit2			
13	O	BL3	· When any error is displayed,	B_bit3			
14	O	BL4	BL1, BL5="L"	B_SIGN			
15	O	BL5	BL2, BL3, BL4="H" [2-axis model]				
16 to 21			Not connected.				
22	I	A_ANG	A-ch analog output				
23	I	B_ANG	B-ch analog output [2-axis model]				
24	I	AGND	Analog GND				
25	I	SET1	Enter the setting value with SET in advance, and determine it with MODE and DISP.				
26	I	SET2					
27	I	SET3					
28	I	DISP	Specifies the BANK to be displayed: Combined operation with SET				
29	I	MODE	Switching of peak value: Combined operation with SET				
30	I	BCDCK	Specifies the BCD output: Combined operation with SET				
31	I	EXTTRG	USB trigger				
32	I	A_HOLD	[A] ch HOLD (Upper row display HOLD) *1				
33	I	B_HOLD	[B] ch HOLD (Lower row display HOLD) *1 [2-axis model]				
34	I	HOLD	HOLD/Error canceling error input *2				
35	I	PA	[A] Upper row preset/Peak clear (in the peak HOLD mode)				
36	I	PB	[B] Lower row preset/Peak clear (in the peak HOLD mode) [2-axis model]				

\*1 During input the decimal point will be flashing.

\*2 During input the UNIT indicator will be flashing.

### 3) I/O circuit

#### 1. Output circuit

NOM, AL1 to AL5, BL1 to BL5 Transistor is "ON" to drive the line to "L" (open-collector output).

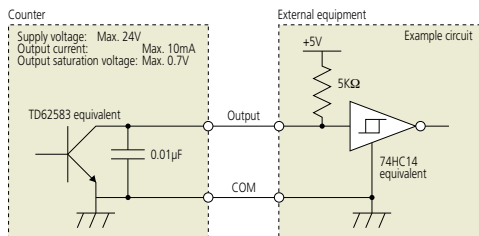

#### 2. Input circuit (SET, MODE, BANK, PSET, HOLD)

PA, PB (only with 542-062), HOLD Input is valid when the line is "L".

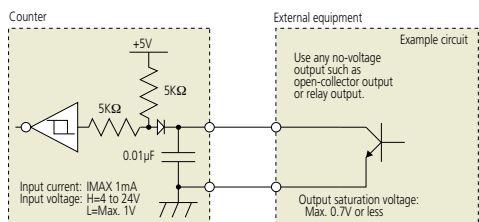

## 4) Timing chart

### 1. Power ON characteristics

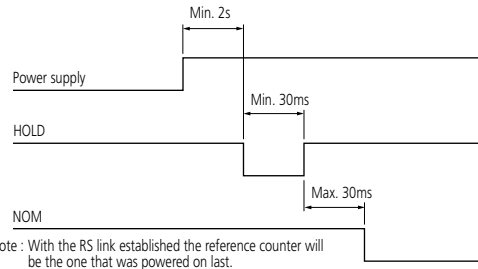

Note : With the RS link established the reference counter will be the one that was powered on last.

### 2. Tolerance judgment result output period

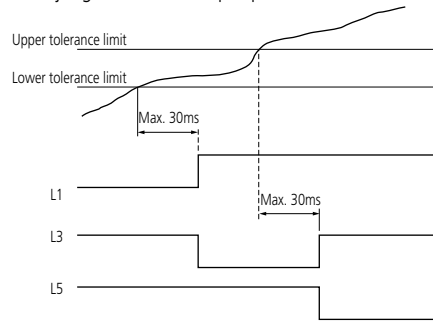

### 3. External preset (PA, PB) input

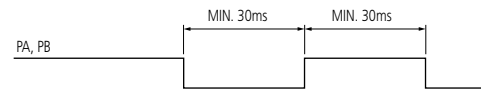

Note : Excluding the period during key input, RS-232C communication or Digimatic processing.

### 4. Peak clear input

(After inputting HOLD, or simultaneous input with the preset value)

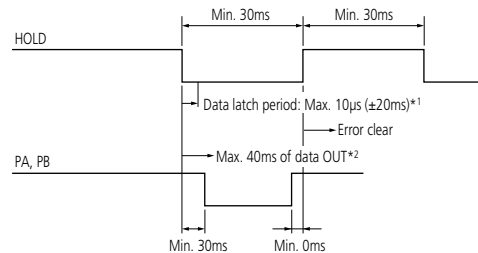

\*1: ( ) represents the case either in the peak mode or in such the mode that an input of HOLD triggers RS-232C output.

\*2: Case in such the mode that input of HOLD triggers RS-232C output.

\*3: The PRESET indicator will be flashing during the input operation of HOLD.

### 5. RS-232C command input and response output

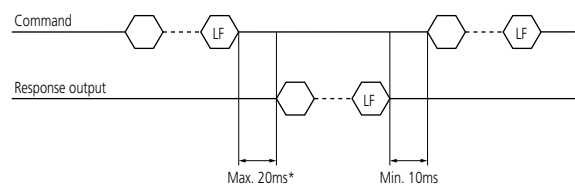

Note : Excluding the period during key input, RS-232C communication or Digimatic processing.

Display Units

# EH Counter

DIN size (144 x 72mm) assembly-type display unit

## RS-232C specifications

### 1) Compatible plug:

D-sub9 pin (female), inch thread specification

### 2) Pin assignment

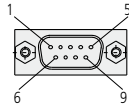

Pin No.	Description	I/O	Function
2	RXD	IN	Receive data
3	TXD	OUT	Send data
4	DTR	OUT	Data terminal ready
5	GND	—	Ground
6	DSR	IN	Data set ready
7	RTS	OUT	Request to send
8	CTS	IN	Clear to send
1, 9	N.C.	—	Connection impossible

### 3) Communication specifications (conforming to EIA RS-232C)

Home position	DTE (Data Terminal Equipment) Use a cross-type cable.
Communication method	Half-duplex, teletype protocol
Data transfer rate	4800, 9600, 19200bps
Bit configuration	Start bit: 1 Data bits: (7, 8) ASCII, upper-case characters Number of parity bits: None, even, odd Number of stop bits: 2
Setting the communication conditions	Set via parameters.

Display Units

# D-EV Display Unit

External display unit for EV counter

## FEATURES

- Display unit for the EV counter.
- Using this display allows various settings for the EV counter to be made without the need for a personal computer or other equipment.
- Able to display each axis measurement value and GO/NG judgment result, total GO/NG judgment result for all axes, setting details, and errors.
- DIN compatible compact panel-mounting - cutout dimensions 45<sup>+0.8</sup> x 92<sup>+0.8</sup>
- The required power supply is DC +12 to +24V, 200mA at the terminal block. (AC adaptor **02ADN460** is available.)



## Optional Accessories

- SPC cable (0.5m): **No.02ADD950**\*1
- SPC cable (1mm): **No.936937**\*1
- SPC cable (2m): **No.965014**\*1
- AC adaptor: **No.02ADN460**
- AC cable (Japan): **02ZAA000**\*2
- AC cable (USA): **02ZAA010**\*2
- AC cable (EU): **02ZAA020**\*2
- AC cable (Britain): **02ZAA030**\*2
- AC cable (China): **02ZAA040**\*2
- AC cable (Korea): **02ZAA050**\*2

- Terminal connecting cable: **02ADD930**\*2
- \*1: Required when connecting with **EV-16P/D/Z**.
- \*2: Required when using AC adaptor.

## SPECIFICATIONS

Order No.	<b>02ADD400</b>
Model No.	D-EV
Number of connections	1 EV counter per unit
Number of digits	Sign plus 6 digits (8 digits internal to EV counter)
LED display	Channel display (also for judgment result display): 3 (3-color LED) Measurement mode display (current data, maximum value, minimum value, runout): 2 Status display: 1 (2 colors)
Operation switches	4
Function of operation switch	Channel switching, measurement mode switching (current data, maximum value, minimum value, runout), parameter setting, presetting, tolerance setting
Input/output	RS Link connectors: 1 each for IN, OUT
Error message	Overspeed, gage error etc.
Power supply	Terminal block (M3 screw), 12 - 24V DC, 200mA
Operating temperature (humidity) range	0 to 40°C (RH 20 to 80%, no condensation)
Storage temperature (humidity) range	-10 to 50°C (RH 20 to 80%, no condensation)
External dimensions	96(W)x48(H)x84.6(D)mm

## Dimensions

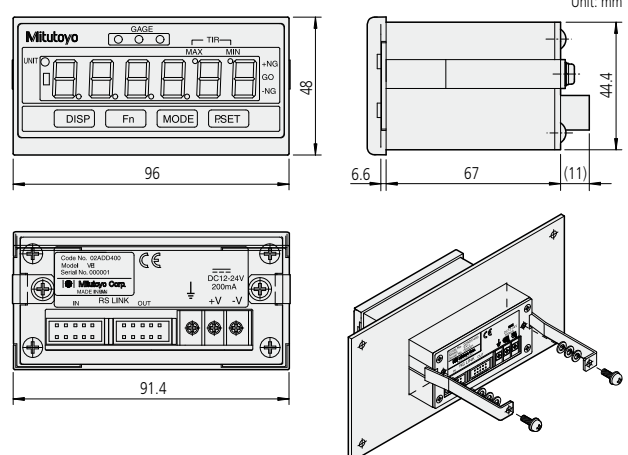

# EV Counter

DIN size (144 x 72mm) assembly-type unit for multi-gage systems

## FEATURES

- Able to connect up to 10 EV counters to one personal computer using the RS link function to facilitate the configuration of a multi-point measurement system comprising a maximum of 60 gages.
- A range of output modes to choose from; I/O output for tolerance judgment and segment output, BCD data output and RS-232 output are available.

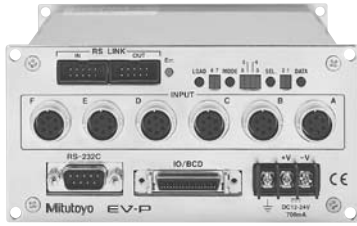

For differential square-wave output gage heads (6 axes)

542-063

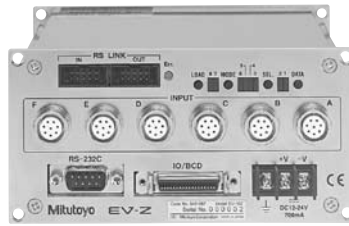

For differential square-wave output gage heads with Origin Point Mark (6 axes)

542-067



For Digimatic code output gage heads (6 axes)

542-064

## Dimensions

Unit: mm

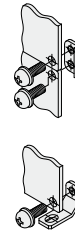
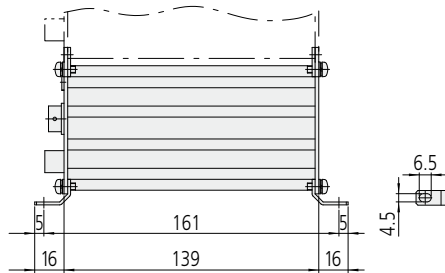
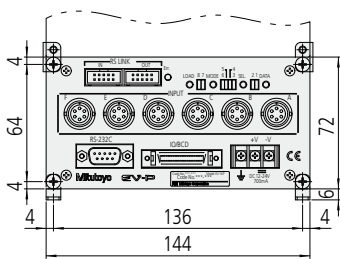

## Optional Accessories

- ID-EV External display unit: **No.02ADD400**
- SPC cable (0.5m): **No.02ADD950**
- SPC cable (1m): **No.936937**
- SPC cable (2m): **No.965014**
- AC adapter: **No.02ADN460**
- AC cable (Japan): **02ZAA000\***
- AC cable (USA): **02ZAA010\***
- AC cable (EU): **02ZAA020\***
- AC cable (Britain): **02ZAA030\***
- AC cable (China): **02ZAA040\***
- AC cable (Korea): **02ZAA050\***
- Terminal connecting cable: **No.02ADD930\***

\* Required when using AC adapter.

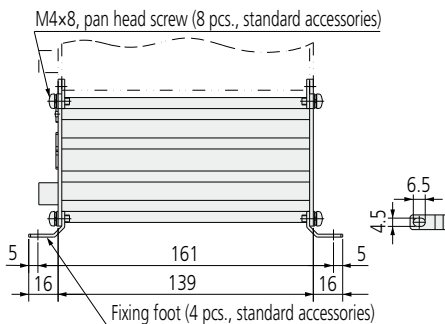
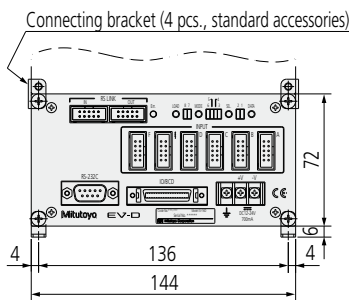
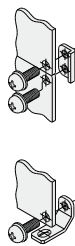
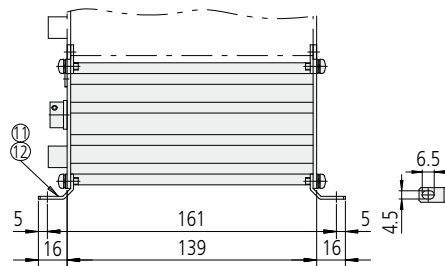
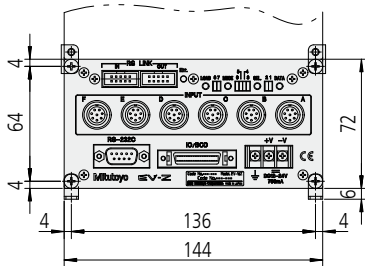
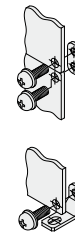

## SPECIFICATIONS

Order No.	542-063	542-067	542-064
Model No.	EV-16P	EV-16Z	EV-16D
Number of input channels	6		
Maximum input frequency	1.25MHz (2-phase square wave), response speed depends on gage specification. Max. counting speed: 5MHz	1.25MHz (2-phase square wave), response speed depends on gage specification. Max. counting speed: 5MHz	Response speed depends on gage specification.
Quantizing error	±1 count		
Resolution	10μm (±999999.99mm) / .0005" (±9999.9995") 5μm (±999999.995mm) / .00005" (±999.99995") 0.5μm (±9999.9995mm) / .000005" (±99.999995")*1 [Parameter set]	10μm (±999999.99mm) / .0005" (±9999.9995") 5μm (±999999.995mm) / .00005" (±999.99995") 1μm (±99999.999mm) / .00005" (±999.99995") 0.5μm (±9999.9995mm) / .000005" (±99.999995") [Parameter set]	Depends on gage specification.
LED display	8 digits for parameter display (displays settings), 1 for error display		
Error message	Overspeed, gage error etc.		
External display	Dedicated external display unit D-EV (optional) can be connected.		
Number of input switches	4		
Function of input switches	Measurement mode switching, parameter setting		
Input/output	Tolerance judgment output	1 to 6 channels (L1, L2, L3), open-collector	
	BCD output	Parallel BCD output (positive/negative-true logic), open-collector	
	Segment output	Function to set on only the terminals corresponding to the counting values, open-collector	
	Control output	Normal operation signal (NOM), open-collector	
	Control input	Output channel designation (segment, in the BCD mode), presetting, peak value clear, range changeover (at segment output), holding counting value open-collector or no-voltage contact signal (with/without contact point)	
Interface	RS-232C	Measurement data output and control input EIA RS-232C-compatible Use cross cables for home position, DTE (terminal definition).	
	RS link	Max. connecting unit: 10 (6 when using EF counter) Connecting cable length: Max. 10m (sum of link cable length) Data transfer time: 1sec./60ch (when transmission rate is 19200bps)	
Rating	Power supply voltage	12 - 24V DC, terminal block (M3 screw)	
	Power consumption	8.4W or less (700mA max.) Ensure at least 1A is available per unit.	
Operating temperature (humidity) range	0 to 40°C (RH 20 to 80%, no condensation)		
Storage temperature (humidity) range	-10 to 50°C (RH 20 to 80%, no condensation)		
External dimensions	144 (W) x 72 (H) x 139 (D) mm		
Mass	Approx. 910g	Approx. 910g	Approx. 830g
Standard Accessories	Fixing foot (4), connecting bracket (4), fixing screw M4x12 (8)		
Applicable input	Differential square-wave		Digimatic code (SPC)
Applicable gage head	<b>LGF, LGK, LGB, LGM, LG</b> Models with reference point mark, sine wave output type are excluded.	<b>LGF</b> with reference point mark	<b>LGD, LGS</b>

\*1: Available when using D-EV.

\*2: D-EV is required when selecting 0.1μm resolution.

## System configuration

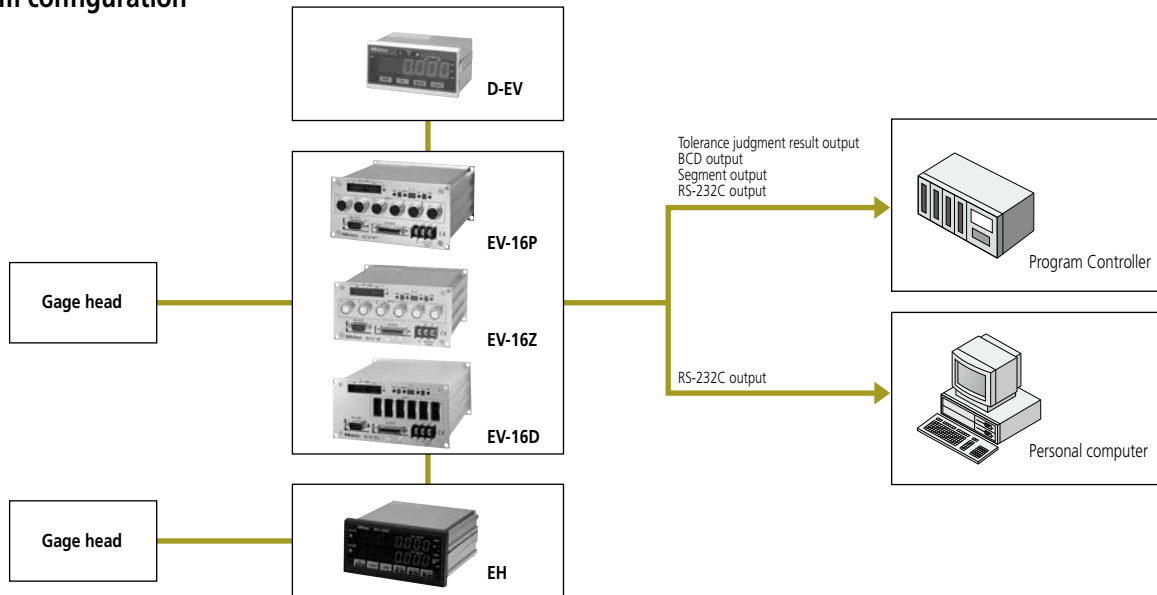

## Internal block diagram

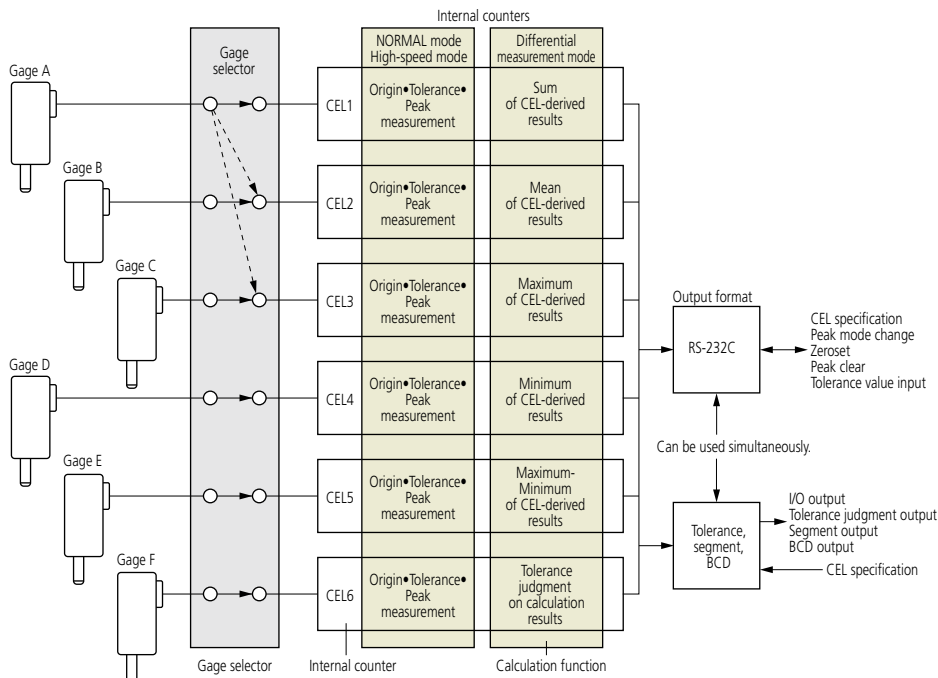

### Gage selector

It is possible to assign gage signals one-to-one or one-to-many to the internal counters through parameter settings. This allows the user to set more than one origin point and/or tolerance limit on one gage head.

### Internal counters

Using the 6 internal counters (CEL1-CEL6) it is possible to perform origin setting, peak measurement, and tolerance limit setting.

### Calculation function

Each of the internal counters is assigned a unique calculation function so that various kinds of calculation can be made between the internal counters specified with the parameters.

### Output function

The output format can be selected from among RS-232C, BCD, tolerance judgment result and segment output. The objective CEL of the output can be selected with an appropriate RS-232C command or SET signal.

# EV Counter

DIN size (144 x 72mm) assembly-type unit for multi-gage systems

## RS Link\* function

It is possible to connect a maximum of 10 counter units together to carry a maximum of 60 channels of multi-point measurement at a time.  
For this connection use the dedicated RS link cable; **02ADD950** (0.5m), **936937** (1m) or **965014** (2m) (The maximum total length of RS link cables permitted for the entire system is 10m.)

\*Patent registered (Japan, U.S.),  
Patent pending (E.U.)  
When used with an EH counter, up to 6 counter units can be connected.

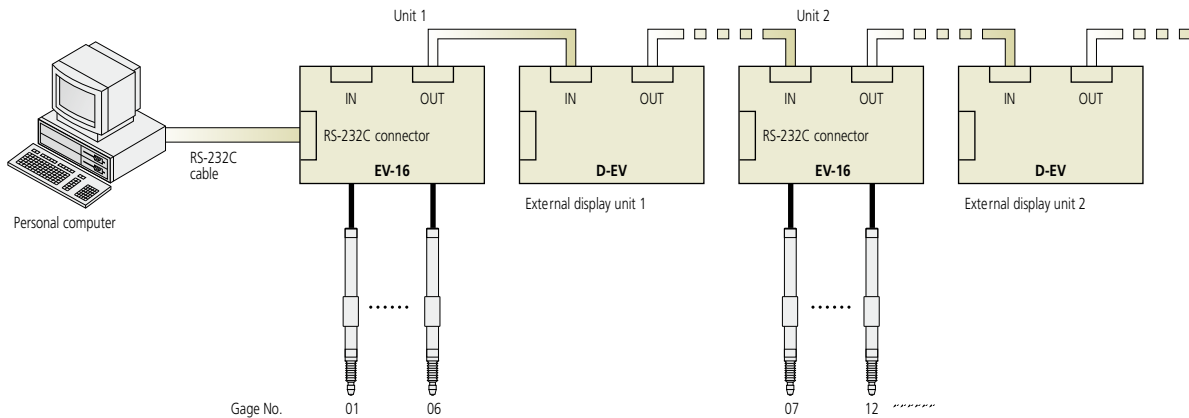

## RS-232C Communication Functions

Makes it possible not only to log measured values but also make various remote settings including the zero-setting of a counter, etc.

Command format	Corresponding output	Function
GA**CRLF	G#**, +01234.567CRLF	Outputs the [Displayed value] through RS-232C.
CN**CRLF	CH**CRLF	Switches the display to the [Current value].
CX**CRLF	CH**CRLF	Switches the display to the [Maximum value].
CM**CRLF	CH**CRLF	Switches the display to the [Minimum value].
CW**CRLF	CH**CRLF	Switches the display to the [TIR (runout)].
CR**CRLF	CH**CRLF	Zeroset
CL**CRLF	CH**CRLF	Clears the peak value.
CP**, +01234567CRLF	CH**CRLF	Inputs the preset value and performs presetting.
CD**, +01234567CRLF	CH**CRLF	Inputs tolerance value.
CG**, +01234567CRLF	CH**CRLF	Inputs tolerance value.
CS**CRLF	CH**CRLF	Cancels the error.
CK**CRLF	CH**, \$CRLF (\$=0 or 1)	Confirms the HOLD state.
CT**CRLF	CH**, +01234.567CRLF	Outputs the [Displayed value] through RS-232C.

\*\* : denotes a gage channel number between 01 and 99 ("00" means all channels).  
# : denotes the type of data [N: Current value, X: Maximum value, M: Minimum value, W: TIR (runout)].  
CRLF: CR (carriage return), LF (line feed).  
Note 1: For presetting and tolerance limit setting, enter each value consisting of a sign and 8 digits of numeric value without a decimal point.  
Note 2: Perform the tolerance limit setting in the order of CD and CG for the case of 3-step tolerance judgment, and in the order of CD, CE, CF, and CG for the case of 5-step tolerance judgment.  
Note 3: The RS communication function will be suspended during key operation (e.g. setting parameters, preset values, or tolerance limits). It automatically resumes the command and data output operation when the gage is recovered to such a condition that the counting is possible.  
Note 4: For canceling the counting-standby state, use CS00CRLF (specification of all channels).

## RS-232C specifications

- Compatible plug:**  
D-sub 9-pin (female), inch thread specification
- Pin assignment**

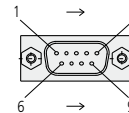

Pin No.	Description	I/O	Contents (application)
2	RXD	IN	Receive data
3	TXD	OUT	Send data
4	DTR	OUT	Data terminal ready
5	GND	—	Ground
6	DSR	IN	Data set ready
7	RTS	OUT	Request to send
8	CTS	IN	Clear to send
1, 9	N.C.	—	Connection impossible

## 3) Communication specifications (conforming to EIA RS-232C)

Home position	DTE (Data Terminal Equipment) Use a cross-type cable.
Communication method	Half-duplex, teletype protocol
Data transfer rate	4800, 9600, 19200bps
Bit configuration	Start bit: 1 Data bits: (7, 8) ASCII, upper-case characters Number of parity bits: None, even, odd Number of stop bits: 2
Setting the communication conditions	Set via parameters.

## Input / output specifications

1) Compatible plug: 02ADB440 (with cover)

2) Pin assignment

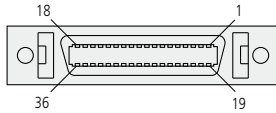

Socket: 10236-52A2 (3M) equivalent

## Output functions

Select either "Tolerance judgment result output", "Segment output", or "BCD output" depending on the application needs.

Tolerance judgment result output				Segment output				BCD output			
Pin No.	Description	Function	I/O	Description	Function	I/O	Description	Function	I/O		
1	COM	Common terminal for I/O circuit	—	COM	Common terminal for I/O circuit (to	—	COM	Common terminal for I/O circuit (to	—		
2	COM	(to be connected to the internal GND)	—	COM	be connected to the internal GND)	—	COM	be connected to the internal GND)	—		
3	CEL1_-NG	Tolerance judgment result output pin (1CH)	O	-OVER	- over-range	O	1X100	BCD output will be made through the specified channel.	O		
4	CEL1_GO		O	-L10	O	2X100					
5	CEL1_+NG		O	-L9	O	4X100					
6	CEL1_NOM	Outputs "L" where counting is possible.	O	-L8	O	8X100					
7	CEL2_-NG	Tolerance judgment result output pin (2CH)	O	-L7	O	1X101					
8	CEL2_GO		O	-L6	O	2X101					
9	CEL2_+NG		O	-L5	O	4X101					
10	CEL2_-NOM	Outputs "L" where counting is possible.	O	-L4	O	8X101					
11	CEL3_-NG	Tolerance judgment result output pin (3CH)	O	-L3	With the specified channel ranges, make output from $\pm 10$ divisions.	O	1X102				
12	CEL3_-GO		O	-L2		O	2X102				
13	CEL3_+NG		O	-L1		O	4X102				
14	CEL3_NOM	Outputs "L" where counting is possible.	O	L0		O	8X102				
15	CEL4_-NG	Tolerance judgment result output pin (4CH)	O	+L1		O	1X103				
16	CEL4_GO		O	+L2		O	2X103				
17	CEL4_+NG		O	+L3		O	4X103				
18	CEL4_NOM	Outputs "L" where counting is possible.	O	+L4		O	8X103				
19	CEL5_-NG	Tolerance judgment result output pin (5CH)	O	+L5		O	1X104				
20	CEL5_GO		O	+L6		O	2X104				
21	CEL5_+NG		O	+L7	O	4X104					
22	CEL5_NOM	Outputs "L" where counting is possible.	O	+L8	O	8X104					
23	CEL6_-NG	Tolerance judgment result output pin (6CH)	O	+L9	O	1X105					
24	CEL6_GO		O	+L10	O	2X105					
25	CEL6_+NG		O	+OVER	O	4X105					
26	CEL6_NOM	Outputs "L" where counting is possible.	O	NOM (ANG)	+ over-range	O	8X105				
27	EXTEND	Output "L" while the RS command is processed.	O	EXTEND	Output "L" while the RS command is processed.	O	SIGN	Sign of the counting value (+="H", -="L")	O		
28	READY	Data confirmation signal	O	READY	Data confirmation signal	O	READY	Data confirmation signal	O		
29	START	First CEL identification signal	O	START	First CEL identification signal	O	START	First CEL identification signal	O		
30	NORMAL	Normal signal	O	NORMAL	Normal signal	O	NORMAL	Normal signal	O		
31	P.SET	Preset	I	P.SET	Preset	I	P.SET	Preset	I		
32	OUTCEL	Set the objective CEL of output.	I	OUTCEL	Set the objective CEL of output.	I	OUTCEL	Set the objective CEL of output.	I		
33	SET1	CEL specification data or segment range data	I	SET1	CEL specification data or segment range data	I	SET1	CEL specification data or segment range data	I		
34	SET2	CEL specification data or segment range data	I	SET2	CEL specification data or segment range data	I	SET2	CEL specification data or segment range data	I		
35	SET3	CEL specification data or segment range data	I	SET3	CEL specification data or segment range data	I	SET3	CEL specification data or segment range data	I		
36	HOLD	Hold/Peak clear	I	HOLD	Hold/Peak clear	I	HOLD	Hold/Peak clear	I		

# EV Counter

DIN size (144 x 72mm) assembly-type unit for multi-gage systems

### 3) I/O circuit

#### 1. Output circuit:

Tolerance judgment result output, NOM, segment output, etc.  
Transistor is "ON" to drive the line to "L" (open-collector output).

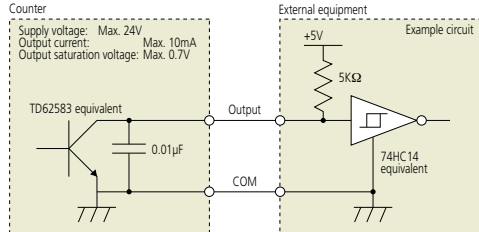

#### 2. Input circuit :

P.SET, HOLD, SET, etc. Input is valid when the line is "L".

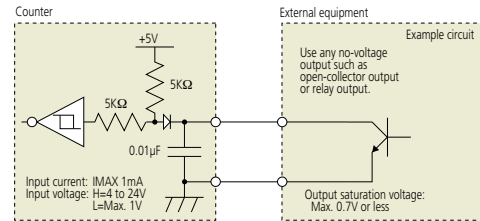

### 4) Timing chart

#### 1. Power ON characteristics

Where the RS link is established, the reference counter shall be the one that was powered last.

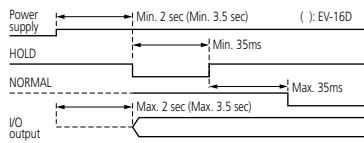

#### 2. Tolerance judgment result output period

All CELs will not output simultaneously.

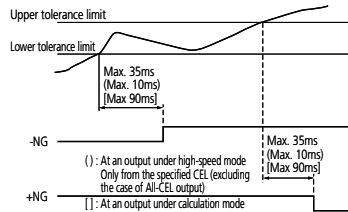

Note: The output period in the case of ED-V counter depends on the gage unit being connected.

#### 3. Data output

There are two data output methods; Command mode and Interval mode. Either of them can be set via the I/O output mode parameters.

#### a. Command mode (All-CEL output)

All-CEL data output (specified with SET1 through SET3) while the HOLD and READY lines are synchronously controlled.

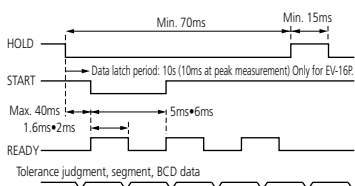

Note: During HOLD input the UNIT LED (D-EV) will be flashing.

#### b. Command mode (Individual CEL output)

Individual CEL data output (specified with SET1 through SET3) can be performed while the HOLD and READY lines are synchronously controlled.

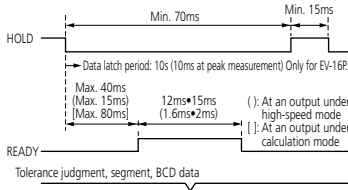

Note: When it is required to operate in the high-speed mode or All-CEL output mode, always use equipment whose input response time is 1ms or less.

#### c. Interval mode (All-CEL output)

All-CEL data (specified with SET1 through SET3) will be sequentially output according to the counter's internal timing.

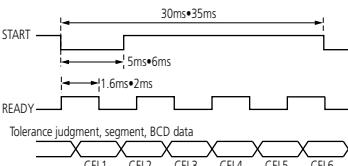

Note: When it is required to operate in the high-speed mode or All-CEL output mode, always use equipment whose input response time is 1ms or less.

#### d. Interval mode (Individual CEL output)

Individual CEL data (specified with SET1 through SET3) will be sequentially output according to the counter's internal timing.

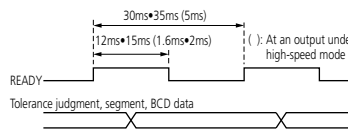

Note: The data update time in the case of 542-064 depends on the type of gage being connected. In addition, the same data may be output over multiple cycles.

#### 4. External presetting

Takes the current value of CEL (which has been specified with SET1 through SET3) as the preset value.

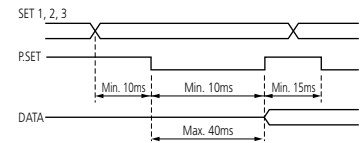

If presetting is executed, the peak value up until then will be cleared. (Max=Min=Current value, TIR=0)

#### 5. Specification of objective CEL of output/ Specification of calculation method

Assigns the CEL that has been specified with SET1 through SET3 to the data output CEL.

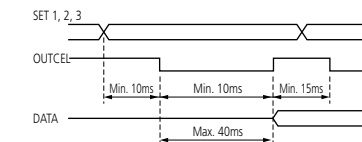

Input with SET3 through SET1 during segment output. This usually operates as the range specification data. (This acts as CEL specification when OUTCEL is input.)

- NORMAL, High-speed mode: Specification of the output CEL
- Differential calculation mode: Specification of the calculation method

#### 6. Peak clear

Clears the peak value.

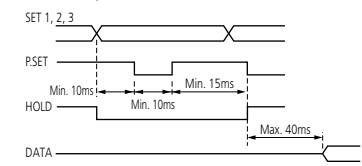

Note: Peak clear takes effect only in the peak mode. (In the case of a current value, this has the same effect as a presetting operation.)



## Input / output connector



02ADB440

This plug fits the I/O output socket on EF/EV counters. Refer to the corresponding technical explanations (page 40 and 41) for pin assignments.

## AC adaptor / AC cable



Connected to the power supply terminal

Order No.	Description
02ADN460	AC adaptor
02ZAA000 (Japan)	AC cable
02ZAA010 (USA)	
02ZAA020 (EU)	
02ZAA030 (Britain)	
02ZAA040 (China)	
02ZAA050 (Korea)	
02ADD930	Terminal connecting cable

## RS Link / SPC connecting cable



- Used to output the measured data from EC / EB / EH counters to Digimatic mini-processor DP-1VR.
- Used to interconnect EH/EV counters comprising an RS link. Same as the cable used for Digimatic code (SPC) output.

Order No.	Cable length
02ADD950	0.5m
936937	1m
965014	2m

## Connector compatibility

The connectors listed below are compatible with the specific models of counter shown for measurement, data output, and external control purposes.

Counter	Counter Order No.	Description	Connector Order No.
EC-101D	542-007	GO/NG judgment output	C162-155
EG-101P	542-015	BCD output, GO/NG judgment output	02ADB440
EG-101Z	542-017	BCD output, GO/NG judgment output	
EG-101D	542-016	BCD output, GO/NG judgment output	
EB-11P	542-092-2	GO/NG judgment output, serial BCD output, simple analog output	02ADB440
EB-11Z	542-094-2	GO/NG judgment output, serial BCD output, simple analog output	
EB-11D	542-093-2	GO/NG judgment output, serial BCD output, simple analog output	
EH-101P	542-075	Remote input, GO/NG judgment output RS-232C output	02ADB440
EH-102P	542-071	Remote input, GO/NG judgment output RS-232C output	02ADB440
EH-102Z	542-073	Remote input, GO/NG judgment output RS-232C output	02ADB440
EH-102S	542-074	Remote input, GO/NG judgment output RS-232C output	02ADB440
EH-102D	542-072	Remote input, GO/NG judgment output RS-232C output	02ADB440
EV-16P	542-063	Remote input, GO/NG judgment output Segment output, BCD output RS-232C output	02ADB440
EV-16D	542-064	Remote input, GO/NG judgment output Segment output, BCD output RS-232C output	02ADB440
EV-16Z	542-067	Remote input, GO/NG judgment output Segment output, BCD output RS-232C output	02ADB440

# Quick Guide to Precision Measurement

## Precision measuring terms

### Nut and split-clamp stem mounting

Gage heads are mounted on a fixture or stand using the precision-machined cylindrical stem. Stems can be any one of several standard diameters and are either just plain or with a fixing thread at one end or the other. All gages can be mounted using the split-clamp method which is suitable for a range of applications, especially where small axial adjustments may be required. However, care is needed to avoid over-tightening the clamp, which could interfere with the spindle movement. Those stems with a thread at the spindle end can also be mounted just by using a nut to clamp them into a hole in a fixture. They can also use a 'thrust stem' (see page 33) that is clamped into a larger hole in a fixture and into which the gage is screwed. Stems with a thread at the body end can also use this method of mounting.

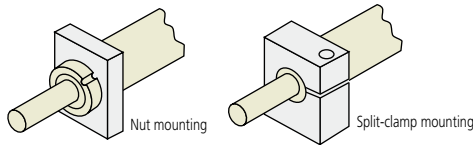

### Comparison measurement

When a measurement is required that is beyond the measuring range of a particular gage head, so that an 'absolute' measurement is impossible, a calibrated master gage (e.g. gage blocks) or master workpiece can be used to subtract the greater part of the distance involved so that the head only has to measure the difference between the workpiece and the master. This 'comparing' of the size of a workpiece with that of a master gives rise to the term 'comparison measurement'. (See page 59 for a detailed description.)

### Measuring force

A force is produced when a workpiece is brought into contact with the tip of a linear gage head and forces the spindle to retract against the action of the return spring. This is known as the measuring force and is specified in newtons (symbol N). As this force is spring-generated it increases with spindle retraction.

### IP Codes

#### IP54

Code digit	Type of protection	Degree of protection
5	Protected against dust	Ingress of dust is not totally prevented, but dust that does penetrate must not interfere with satisfactory operation of the apparatus or impair safety
4	Protected against splashing water	Water splashed against the enclosure from any direction shall have no harmful effects

#### IP66

Code digit	Type	Protection guarantee
6	Dust-proof	No ingress of dust allowed
6	Protected against powerful water jets	Water projected in powerful jets against the enclosure from any direction shall have no harmful effects

### Zero set

The action of setting the measurement display to zero at the current position of the spindle before making a measurement, which will then be made relative to zero. This function is used when making an absolute measurement relative to a reference surface, or when making a comparison measurement relative to a master gage (or workpiece), although in the latter case a calculation is necessary to add the size of the master to the displayed value to get the true measurement value.

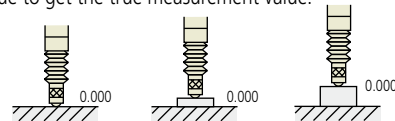

### Preset

The action of setting the measurement display to a non-zero value at the current position of the spindle before making a measurement, which will then be made relative to this 'preset' value. This function is useful in comparison measurement because it can be used to eliminate the need for calculation, which otherwise would be necessary, to get the true measurement value if the display was merely zeroed before measurement.



### Communication via RS-232C interface

RS-232C allows communication with a personal computer. It allows not only the reading of measured values but also data transmission to the counter and remote operations, such as when changing various settings.

### Direction switch

Selects the counting direction of (+) or (-), whichever is convenient with a given direction of spindle movement.

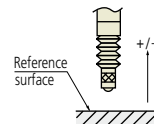

### Peak hold/TIR measurement

Allows switching to the measurement mode for maximum value, minimum value, and run out value (maximum - minimum), in addition to the normal measurement mode.

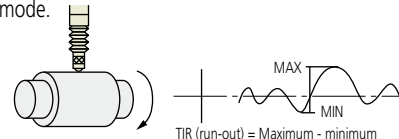

### Tolerance judgment indication/output

Sets two (or four) desired tolerances for three (or five) stages. Judgment results can be output to an external device.

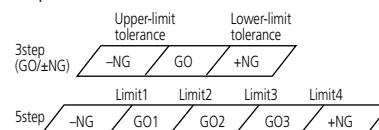

### BCD output

The displayed value can be output in Binary Coded Decimal format.

### Digimatic output

Data can be output to various printers and statistical processing devices, such as DP-1VR and MUX-10LF, using the Digimatic code (SPC) output format.

## Comparison measurements

The following is a description of the interactions that occur between Origin Point Mark detection, the Internal Counter, the Display and the Offset Register while setting up and making a comparison measurement with a linear gage head.

### The offset register

The purpose of the offset register is to supply a value to be added to the display so that it indicates the correct measurement value. When a preset value (the master gage dimension) is entered into the system the current internal counter value is subtracted from this value and the result is stored in the offset register. From then onward this resultant value is added to the internal counter to provide the display value, which then indicates the correct dimension relative to the datum surface.

$$12.000 - 4.000 = 8.000$$

The preset value is shown on the display at the time of input

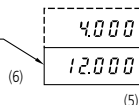

To the timing when the spindle passes over the originpoint, the counter begins counting from the offset value.

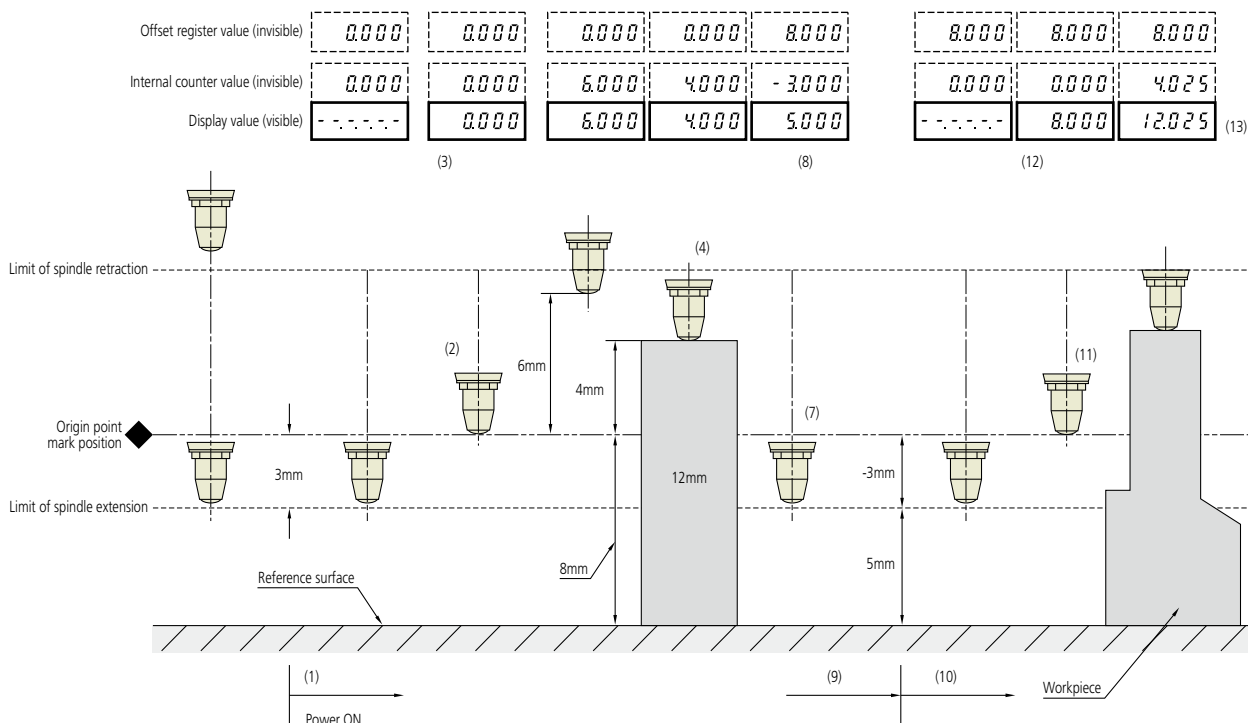

Note) The example linear gage used in the above explanation is LGF-0510 (110) ZL. This linear gage has its origin point marked at a position approximately 3mm from the limit of the spindle extension. In the case of 25/50mm-stroke types the origin point mark is positioned approximately 5mm from the spindle extension limit.

### Procedure

1. Turn the display unit connected to the gage head to ON. (The offset register is set to zero at this stage.)
2. Displace the gage head spindle approximately more than 3mm from the spindle extension limit position to make it pass over the origin point mark.
3. The display unit will automatically read the origin point and zero-set itself.
4. Bring the gage head contact point into contact with the master gage as shown.
5. The display unit indicates the displacement from the origin point position. (Offset register still contains zero.)
6. Input the preset value (the calibrated size of the master gage, 12.000).
7. Remove the master gage so that the spindle extends to its limit.
8. The display unit displays position of the contact point relative to the datum surface (-3.000 + 8.000 = 5.000)
9. Turn OFF the display unit.
10. Turn ON the display unit.
11. Displace the gage head spindle approximately more than 3mm from the spindle extension limit position to make it pass over the origin point mark.
12. The display unit will automatically read the origin point and the displayed value will effectively start from the stored offset register value (0.000 + 8.000 = 8.000).
13. The contact tip can now be brought into contact with the workpiece to make the measurement and the display will indicate the workpiece size (4.025 + 8.000 = 12.025).

# Quick Guide to Precision Measurement

## Before using the gage head

### About exporting

- Mitutoyo products are subject to Appended Table 1 of the Export Trade Control Ordinance. In order to export relevant products, an application may be required for an export license.

### Avoid installing the gage in locations where:

- The gage will be exposed to direct sunlight, or where the ambient temperature may drop below 0°C or exceed 40°C.
- The relative humidity may drop below 20%RH or exceed 80%RH, or where a sudden change in temperature may cause condensation.
- The gage would be subject to corrosive gas, or where combustible materials are placed nearby.
- The gage is subject to air containing significant amounts of dust, salt or iron powder.
- The gage is subject to direct vibration or shock.
- The gage may come in contact with splashed water, oil or chemicals. (The gage system components are not designed for protection against water, oil or chemical attack, except for the gage unit.)
- Electronic noise is likely to affect the gage.

### Conformance to EC Directive (89/336/EEC)

All Linear Gage series (gage head and display unit) conform to EN55011:1992, EN55082-2:1995, EN61000-4-2, ENV50140, ENV50204, ENV50141 and EN61000-4-4.

### Preventing electrical interference

- Bundling the sensor cable with high-voltage lines or power lines may cause the gage to malfunction. The sensor cable run should be completely separate.

### Power supply to the display unit

- If a generic switching regulator is used, provide grounding via the frame's ground terminal or ground terminal of the power supply.
- If a malfunction occurs due to superimposed noise on the power-supply line, use a DC-regulated power supply that incorporates an isolation transformer.

### About grounding

- Avoid sharing the frame ground (F.G.) terminal of this unit with the high-power line grounding but separately connect it to Class 3 Grounding.

### Handling precautions

- This product is a precision measuring instrument. Avoid dropping or otherwise subjecting it to impact.
- The spindle of the gage head is connected to the body via a spring. Be careful not to pull the spindle in the extending direction or rotate it with force. Doing so may cause permanent distortion and damage to the spring.
- The gage is shipped with a standard contact point (**901312** or **900032** for the inch version of the LGS) installed on the spindle. This contact point can be replaced with a different type that best suits the shape of workpiece. (See page 36.)

When installing or removing a contact point, place the wrench provided on the catch in order to keep the spindle from rotating. Then grip the contact point with pliers to install or remove it.

When gripping the contact point with pliers, insert a piece of felt or other soft packing between the jaws and the point to protect it from damage.

## Gage head mounting precautions

The illustrations below highlight the mounting precautions that should be observed when a gage head or counter is used.

### All models of gage head

- Mount the gage on a fixture or stand by using its stem only.
- Be careful not to over-tighten the stem. Doing so may cause problems in gage operation.
- Never fasten the gage by placing the tip of a screw directly against the stem.
- Never fasten the gage by any section other than its stem.
- Mount the gage in such a way that its stem is in line with the direction of measurement required. If installed at an angle to this direction, measurement errors will occur.
- Be careful not to exert force on the gage via the cables. Exercise due care especially when using an additional extension cable.

### Examples of the plain-stem mount

- The recommended clamping torque is 0.4 to 0.5Nm. Over-tightening the stem clamp will prevent smooth movement of the spindle. Ensure the spindle can move freely after clamping.

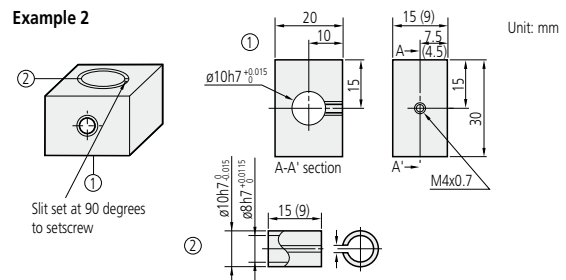
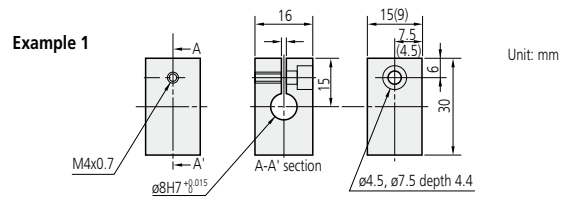

### LGK, LGF and LGD models

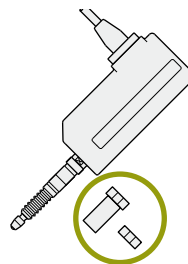

The use of a thrust stem allows a gage head to be mounted securely and easily just by drilling a  $\phi 9.5$ mm hole (or  $\phi 18$ mm for  $\phi 15$ mm stems) in a plate approximately 10mm thick (see page 33). A dedicated (optional) wrench is available that fits the wrench-seat at the top of the stem for holding the gage while the clamping nut is tightened with a spanner. Ensure that no force or torque is applied to the cable during this operation, otherwise damage may be caused.

### LGB model

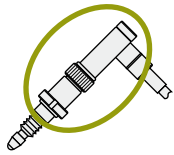

Insert a gage in the mounting hole (recommendation:  $\varnothing 9.5_{H6}$ ) and fix it with the clamp nut supplied. For this gage, be sure to hold the knurled section at the middle of the gage body by hand and tighten the clamp nut with the special wrench supplied. Ensure that no force or torque is applied to the cable during this operation, otherwise damage may be caused. Optional mounting brackets are available. Incidentally, when fabricating a mounting bracket, it is recommended that dimension 'B' (shown on page 32) is 11.5mm.

Gage heads have been widely introduced and accepted in various fields of industries. When it comes to the matter of mounting gage heads onto equipment, however, the problem encountered is a higher cost involved in fabricating mounting brackets. In order to avoid waste of this kind, Mitutoyo offers mounting brackets (material: cast iron, FC45, nickel plated) that have been fabricated with varieties of mounting methods taken into consideration in view of design and machining. (See page 32.)

### Air drive model

- Service air pressure: 0.3 to 0.4MPa
- Lubricating oil: Turbine oil class 1 (ISO VG32)
- Caution: Holding the air cylinder section while mounting gage will exert force on section A, causing a gage failure. For the same reason it is essential not to apply force to section A when connecting an air hose to the gage head.

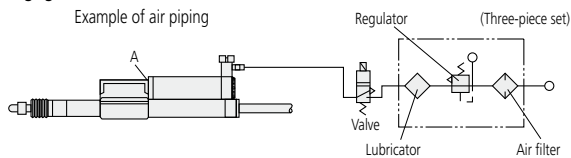

### Laser Hologage

A Laser Hologage can be mounted by inserting its stem in the mounting hole of a dedicated stand or other equipment.

Recommended mounting hole diameter in fixture:  $15\text{mm}^{+0.024}_{-0.006}$

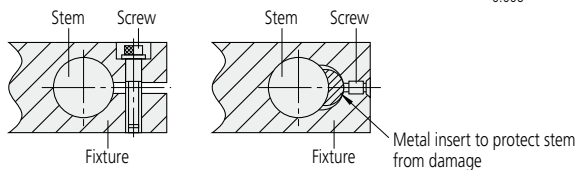

- The mounting hole shall be machined parallel with the direction of measurement. Cosine-effect measurement error will occur if the gage is misaligned with this direction.
- Excessive force in tightening the stem will affect smooth spindle motion and should be avoided.
- In applications where a Laser Hologage is subject to movement, ensure that the mounting is designed to avoid the cable being dragged when in motion.
- Precautions for measurement:
  - To help ensure accuracy, allow 30 minutes warm-up time for the system after powering ON.
  - Allow sufficient time for temperature stabilization for both the gage and workpieces to be measured.
  - Thoroughly clean the contact point and all surfaces to be measured before measurement to avoid accuracy degradation due to dust or grease.
  - Be aware of possible overspeed errors if the contact point is allowed to drop significantly from surface to surface on the workpiece. Appropriate measuring procedures should always be used with due consideration for the part features.

### Replacement of contact point

All models of gage head

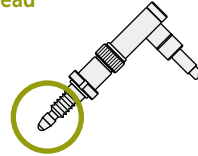

- Engage the key wrench (supplied) with the wrench-seat to prevent the spindle from rotating, grip the contact point with a pair of pliers, then loosen or tighten it as necessary. When gripping a contact point with a pair of pliers, insert a piece of felt or other soft packing between the jaws and the point to protect it from damage.
- Torque exerted via the spindle on the internal mechanism of a gage can cause damage to the gage. To avoid this problem, ensure that the spindle is firmly held with a key wrench before loosening/tightening the contact point.
- Contact points are interchangeable according to the required specification of the customer.

### Display unit mounting precautions

EC, EG, EB and EV counters

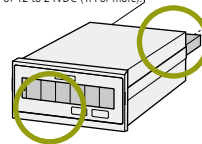
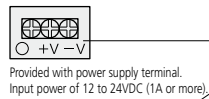

Only the optional I/O output connector **No.02ADB440** is available from Mitutoyo. This is because the number of pins and length of cable varies with application requirements and accordingly wiring is better left for customer's arrangement.

This counter is dedicated to panel-mount application and is not suited for direct bench-mount application. Choose an EH counter for bench-mount or carry-on application.

### About dust / water protection

All gage heads, excluding the LGH and 100mm gage heads, are protected to IP66 or IP54 (DIN40050/IEC529 standards).

- The preamplifiers and counters are not designed to provide dust or water protection. Install them in places where they will not come into direct contact with water or oil.
- When an extension cable is used, seal the preamplifier connection and connectors completely, making sure no portion is left exposed.
- If the cable cover is damaged, water or other liquids may enter the gage due to the capillary effect, causing gage failure. If the cable cover becomes damaged it should be repaired or replaced immediately.
- Handle the gage with due caution to make sure that the rubber boots will not be damaged by scuffing, etc. If the rubber boots are damaged, the gage can no longer be protected from dust or water. When damage is found, repair or replace the boots immediately.
- The rubber material used for the boots and seals does not provide complete protection against coolants and chemicals, which are becoming increasingly complex in composition. If rubber parts are found to have deteriorated significantly, contact your nearest Mitutoyo office.
- The gage must not be disassembled, since it will break the seals of various components. Never attempt to disassemble the gage. Doing so will prevent the gage from functioning to its original specifications.

### Low-cost type — LGS 1012P



### A slim-body model — LGK series

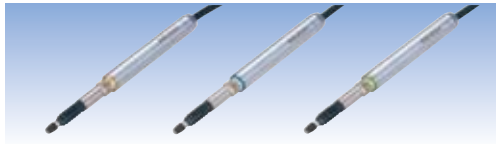

### Assembly type display unit — EG counter



### Multi-gage system — EV counter



Export permission by the Japanese government may be required for exporting our products according to the Foreign Exchange and Foreign Trade Law. Please consult our sales office near you before you export our products or you offer technical information to a nonresident.

- Coordinate Measuring Machines
- Vision Measuring Systems
- Form Measurement
- Optical Measuring
- Sensor Systems
- Test Equipment and Seismometers
- Digital Scale and DRO Systems
- Small Tool Instruments and Data Management

Note: All information regarding our products, and in particular the illustrations, drawings, dimensional and performance data contained in this pamphlet, as well as other technical data are to be regarded as approximate average values. We therefore reserve the right to make changes to the corresponding designs, dimensions and weights. The stated standards, similar technical regulations, descriptions and illustrations of the products were valid at the time of printing. Only quotations submitted by ourselves may be regarded as definitive.

Our products are classified as regulated items under Japanese Foreign Exchange and Foreign Trade Law. Please consult us in advance if you wish to export our products to any other country. If the purchased product is exported, even though it is not a regulated item (Catch-All controls item), the customer service available for that product may be affected. If you have any questions, please consult your local Mitutoyo sales office.

### Mitutoyo Corporation

20-1, Sakado 1-Chome,  
Takatsu-ku, Kawasaki-shi,  
Kanagawa 213-8533, Japan  
T +81 (0) 44 813-8230  
F +81 (0) 44 813-8231  
<http://www.mitutoyo.co.jp>

# Mitutoyo