

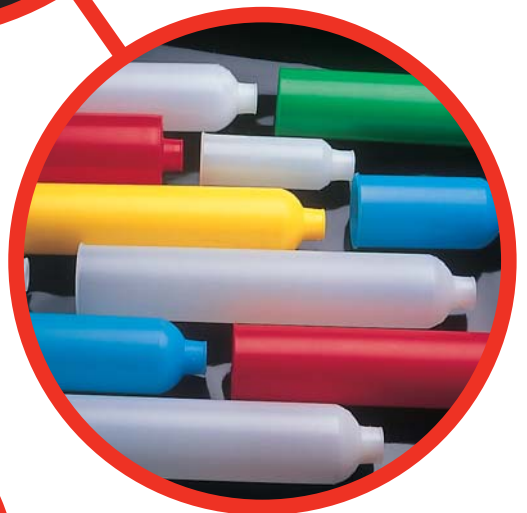

PPG Industries
Semco® Packaging &
Application Systems

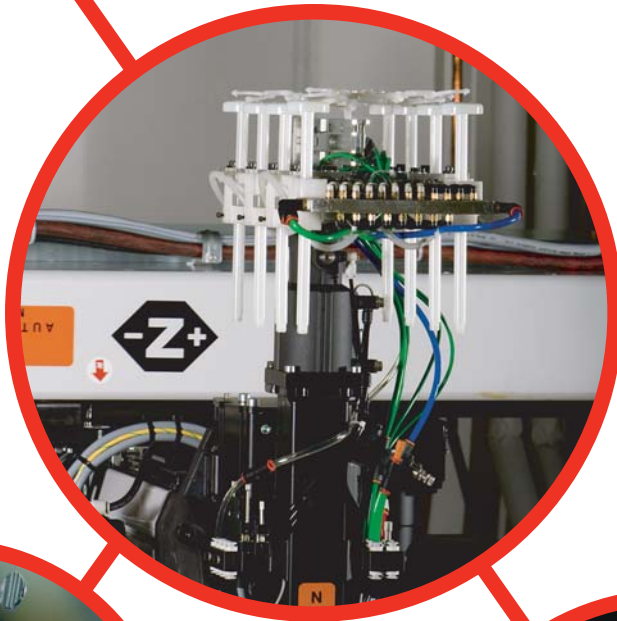

Semco®
Packaging & Application Systems



Where Smart Solutions Take Flight®



Partnership

The value of our partnership lies in our ability to listen closely to our customers and create problem-solving alternatives that improve production. Working closely with manufacturers and customers helps us to produce more effective, easier to use products. For example, working in partnership with equipment suppliers, we have introduced products such as the Pro-Flow™ Cassette and GL syringe to improve application quality and technology.



Quality

Quality is more than just a word. It's the way we make products. By instituting our 5S continuous improvement program, we have streamlined operations at our production facilities. The value of quality lies in our commitment to continuous improvement and making the best product available.



Leadership

The value of leadership is in providing solutions. Through global direct distribution, value-added packaging services, and a comprehensive range of products and services, you get consistency, clarity, and quality in all your packaging and application needs.



Ingenuity

Ingenuity is the value of thinking “outside the box” to make products more effective for customers. Through the development of the Semco® Hybrid Syringe, problems with air entrapment have been reduced and functionality has been significantly improved. And when the PRS-pressure relief plunger was introduced, stringing and dripping problems while dispensing from our cartridges became almost non-existent.



Confidence

Confidence comes through the practical application of Partnership, Quality, Leadership and Ingenuity. The Semco® brand creates confidence in our customers because we take the steps necessary to meet their needs in both product and service.

The VALUE of People and Ideas Working Together

At PPG Industries, Semco® Packaging & Application Systems, we believe value is created through the work of dedicated people using innovative ideas and technology to produce superior products. It is a formula that consistently delivers superior products and has kept the Semco® brand name recognized as the leader in dispensing and application systems for more than 45 years.

Customers around the world rely on Semco® Packaging & Application Systems to deliver value in both our products and service. They count on us to offer the widest range of dispensing guns, mixers, cartridges, nozzles, and syringes than anyone in the industry. In addition, they trust our global network of Application Support Centers and independent distributors to provide timely answers to technical questions and ensure on-time delivery. Even more, they know our reputation for superior products and premier service is backed by a history of engineering excellence. No one provides the breadth of new products or offers the in-house production and tooling capabilities for customized dispensing solutions that we can offer.

Our commitment to quality and service is evident in everything we do. From our team managing concepts to our 5S program, Semco® Packaging & Application Systems is focused on manufacturing customer value. And that's what we deliver in every Semco® product.

In the end, Semco® is more than just a brand name; and we are more than a supplier. We are partners in your business.

Our goal is to furnish packaging and application solutions that simplify the most demanding manual and automated assembly line applications as well as in-field operations. We do this by making it easy to order the right product for your needs, deliver it when you need it, and provide custom service and knowledgeable advice that goes above and beyond what you expect.

In short, it's people and ideas, working together, that get results. That's the real value you get from Semco® Packaging & Application Systems.

Table of Contents

Cartridges & Accessories 2-3

The Semkit® Package 4-5

The Sempen® Applicator 6

Nozzles 7-9

Smoothing Tools 10

Dispensing Guns / Repair Kits . . 11-15

Dispensing Options 16

Retainers / Hose Assemblies . . . 16-17

Semkit® Package Mixers 18

Miscellaneous Equipment 19

Hybrid Syringe Systems 20-22

Sem-Luer / Sem-Flex Needles 23

Luer Lock Syringes 24

Luer Slip Syringes 25

Dispensing Systems 26

Electronic Specialty Products 27

Application Support Centers 28



Cartridges

Disposable plastic cartridges are available in 1, 2.5, 6, 8, 12, 20, 32 oz. and 1/10 gallon capacities. Available in low or high-density natural polyethylene, all sizes are fit with 1/4" NPT female thread dispensing orifice. Special colors are available, however minimum order, lead time, and pricing considerations apply.

The cartridges are capable of handling a wide variety of chemical fluids for storage and application and can be easily adapted to both pneumatic and manual dispensing systems. Semco® cartridges are commonly used in single component or pre-mixed and frozen applications with polysulfides, solder pastes, adhesives, epoxies, urethanes, greases, acrylics, etc.

CP and CWP cartridges are the standard Semco® cartridge with either a P or WP plunger inserted. This inserted plunger allows for filling from the dispensing end, reducing the potential for air entrapment and improving production rates.



Cartridges with Plungers Inserted

Description	Part Number
CP 2.5 oz. LD	220323
CP 2.5 oz. HD	220324
CP 6 oz. LD	220325
CP 6 oz. HD	220326
CP 8 oz. LD	220327
CP 8 oz. HD	220328
CP 12 oz. LD	220329
CP 12 oz. HD	220330
CWP 1 oz. LD	232375
CWP 2.5 oz. LD	220331
CWP 2.5 oz. HD	220332
CWP 6 oz. LD	220333
CWP 6 oz. HD	220334
CWP 8 oz. LD	220335
CWP 8 oz. HD	220336
CWP 12 oz. LD	220337
CWP 12 oz. HD	220338
CWP 20 oz. HD	230231
CWP 32 oz. SHD white	233710
CWP 1/10 gallon HD	230268

Cartridges Only

Description	Part Number
1 oz. LD	220307
1 oz. HD	233222
2.5 oz. LD	220315
2.5 oz. HD	220316
6 oz. LD	220317
6 oz. HD	220318
8 oz. LD	220319
8 oz. HD	220320
12 oz. LD	220321
12 oz. HD	220322
20 oz. HD	229734
32 oz. LD	232921
32 oz. HD	232917
32 oz. SHD white	233656
1/10 gallon LD	230285
1/10 gallon HD	229689

CALL TO ORDER (800) 237-6649

Plungers

Precision molded plungers are available in three styles. Each style has its own functional characteristics. All are designed to fit the cartridge contour, assuring complete dispensing and the elimination of waste.

The WP or Wiper Plunger has the highest amount of interference. This provides the most complete wiping action on the cartridge inside diameter. The P-plunger has medium interference. It provides clean wiping action, inserts easily, and allows evacuation of entrapped air. The PRS or Pressure Relief Plunger has the least interference. It has been specifically designed to be easily inserted and reduce air entrapment during filling and dispensing. This dramatically reduces problems with dripping or stringing during dispensing.



Plungers Only

Description	Part Number
1 oz. WP-Plunger LD	232364
P-Plunger LD (black)	220252
WP-Plunger LD	220259
WP-Plunger HD	220260
PRS-Plunger LD	234414
20/32 oz. WP-Plunger LD	229221
20/32 oz. WP-Plunger HD	232374
1/10 gallon WP-Plunger LD	229756



P Plunger



WP Plunger



PRS Plunger

Seals and Flange Caps

Seals and Flange Caps are used to ensure retention of the plunger during shipping and storage. The standard color is red. Special colors are available, however minimum order, lead time, and pricing considerations apply.

The Flange cap or F-cap is designed to fit over the large open end of the cartridge. There are three seal styles for the dispensing end. The TC-seal is a threaded part that matches perfectly with the dispensing orifice. The TS-seal contacts on three surfaces around and inside the dispensing end of the cartridge. The S-seal fits over the outside of the dispensing orifice only.



Seals and Caps

Description	Part Number
1 oz. F-Cap (red)	232452
F-Cap (red)	220238
1/10 gallon F-Cap (red)	230502
20 & 32 oz. F-Cap (red)	230586
S Seal (red)	220257
TS Seal (red)	220245
Threaded Cap (red)	234411

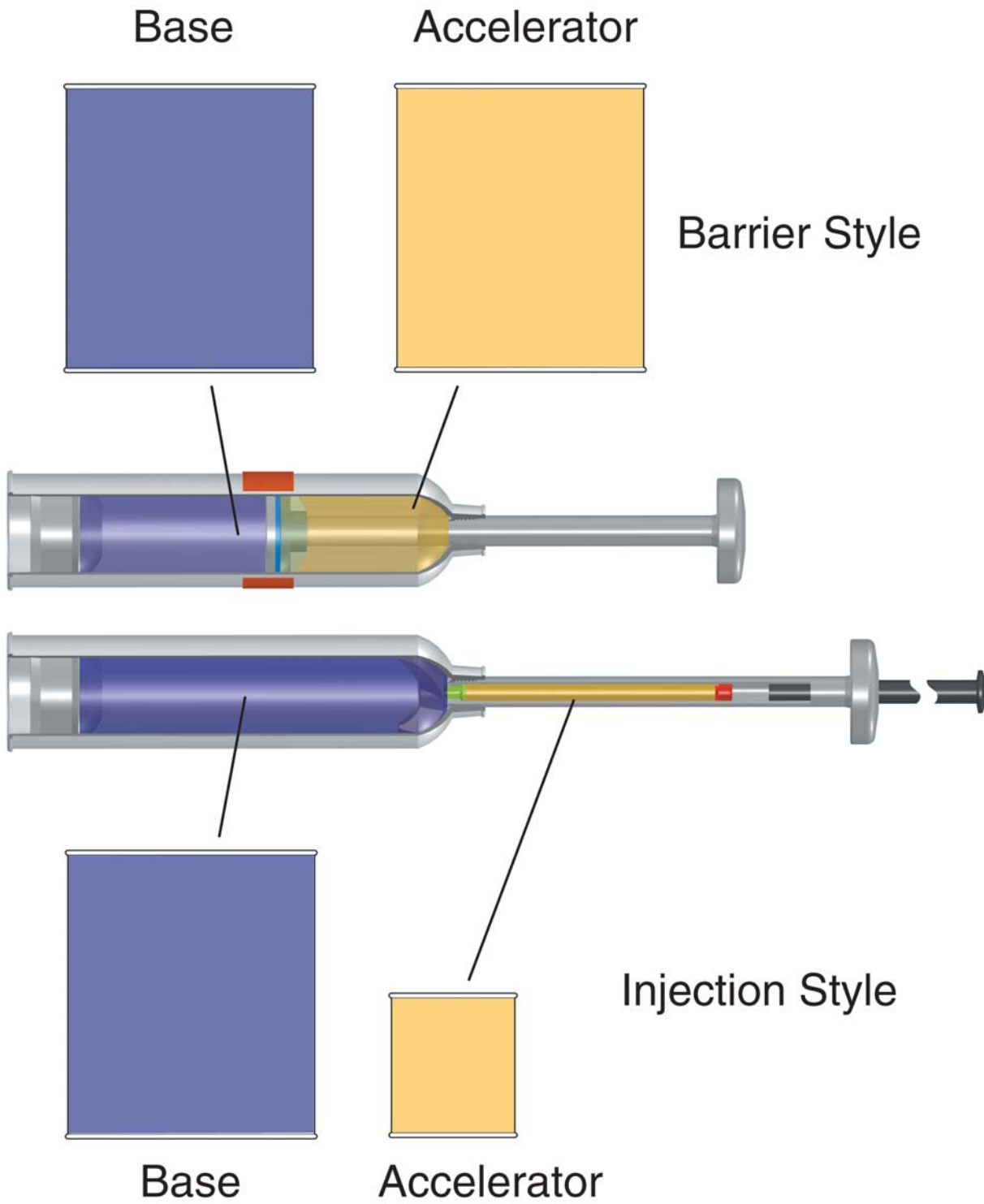

CALL TO ORDER (800)237-6649

The Semkit® Package

The Semkit® package is a complete, multi-component plastic cartridge assembly which stores, mixes, and applies multiple component adhesives, sealants, encapsulants, and other materials. It has been market tested for over 45 years and still represents the best blend of performance and safety available in the market today. Semkit® packages are ideal for epoxies, polysulfides, polyurethanes, and silicones used in the aerospace, electronics, automotive, construction, marine, and telecommunications industries. The kit assures material performance, optimum quality, and increased productivity on the production line and in the field.

The Semkit® package assures accurate proportioning of the materials since the pre-measured components are stored in separate compartments within the cartridge. It eliminates the labor-intensive tasks of measuring and handling materials while minimizing skin contact and material fumes. All the material contained inside the two-component Semkit® package is mixed within the cartridge and can be extruded with virtually nothing remaining. This configuration provides added value by eliminating material exposure and contamination, dramatically reducing waste, and ensuring the correct ratio of each material is used in every application.

There are two styles of Semkit® packages: injection and barrier. Injection kits are typically used with mix ratios of 10:1 or higher. In this kit, the base material is contained in the cartridge, while the catalyst is stored inside the injection rod. Barrier style kits are typically used with mix ratios of 1:1 to 10:1. Both materials are contained in the cartridge and are separated by a foil barrier.

Operators can mix the kit manually, semi-automatically, or automatically. It can then be fitted with a special nozzle and placed in a Semco® pneumatic or manual dispensing gun. After application, the nozzle and kit are disposable, reducing labor and production costs. The Semkit® package mixes a wide range of materials with varying viscosities. No special storage is required.



Complete Kits, Injection Style

Description	Part Number
1 oz. cartridge with 6" rod	678
2.5 oz. cartridge with 6" rod	655
6 oz. cartridge with 6" rod	654
1 oz. cartridge with 8" rod	678
2.5 oz. cartridge with 8" rod	655
6 oz. cartridge with 8" rod	654
8 oz. cartridge with 8" rod	669
1/10 gallon cartridge with 8" rod	690
20 oz. cartridge with 8" rod	689

Barrier Style

Description	Part Number
1 oz. cartridge taped	676
1 oz. cartridge untaped	676
2.5 oz. cartridge taped	653
2.5 oz. cartridge untaped	653
6 oz. cartridge taped	651
6 oz. cartridge untaped	651
8 oz. cartridge taped	668
8 oz. cartridge untaped	668
1/10 gallon cartridge taped	691
1/10 gallon cartridge untaped	691
20 oz. cartridge taped	688
20 oz. cartridge untaped	688

Due to the range of our product line, the part numbers shown are base numbers only. Please call for further assistance.

CALL TO ORDER (800) 237-6649

The Sempen® Applicator

The Sempen® Applicator

The Sempen® applicator is designed for the convenient storage, mixing, and application of pre-measured, multi-component coating materials and assembly fluids in touch up quantities. The pen assembly is supplied with two precisely metered materials that are barrier separated during storage. This system is ideal for low viscosity primers and topcoats used in the aerospace, electronics, automotive, and marine industries. The pen assures material performance, optimum quality, and increased productivity on the production line and in the field.

The Sempen® applicator provides superior coverage and material performance. Its fail-safe metering system holds a maximum of 10 ml and allows exact amounts of the material to be accurately mixed and applied to a film thickness up to 2 mils. Prior to use, the barrier disc is displaced to allow thorough mixing of the materials. After the materials have been mixed, the user can apply variable amounts of coating material to the work surface.

The Sempen® applicator works efficiently. It allows the user to apply the smallest amounts of material without the need for large containers or equipment, eliminating the risk of material contamination. It offers tremendous cost savings and no special training is required. Everything the user needs to accurately mix and apply two materials is contained in one package that conveniently fits in the user's hand.

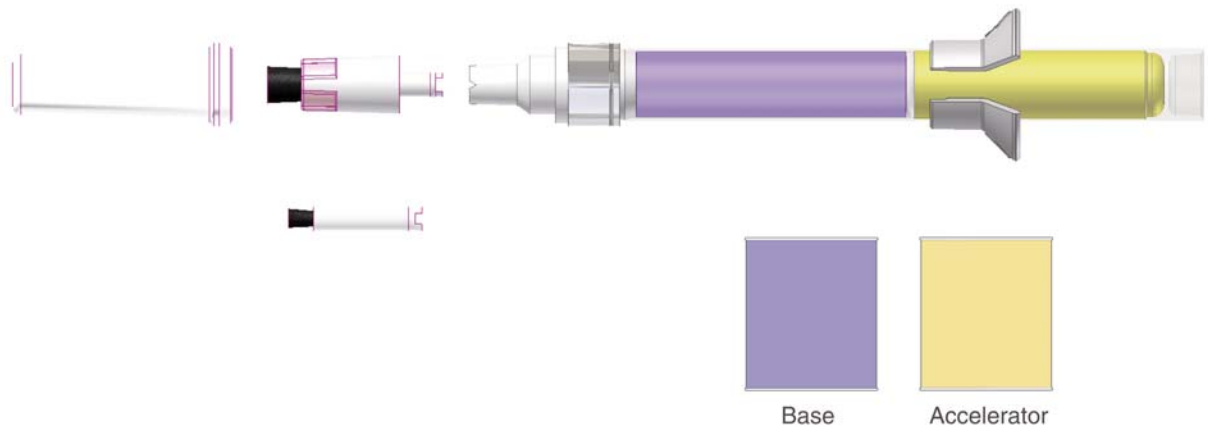

CALL TO ORDER (800) 237-6649

Semco® Standard Nozzles

These disposable nozzles are precision molded and have a 1/4" NPT male thread to fit Semco® 1, 2.5, 6, 8, 12, 20, 32 oz., and 1/10 gallon disposable cartridges. A wide range of lengths and orifice sizes are available to better meet your application needs. Nozzles can be bent to varying degrees, however minimum order, lead time, and pricing considerations apply.

Nozzles

Description	Part Number
252 Nozzle	220538
254 Nozzle	220540
255 Nozzle	233495
410 Nozzle	220542
415 Nozzle	227613
420 Nozzle	220544
430 Nozzle	220548
440 Nozzle	220550
620 Nozzle	220553
640 Nozzle	220555
650 Nozzle	224494
820 Nozzle	220557
840 Nozzle	220559
1002 Nozzle	220561
1004 Nozzle	220563
1010 Nozzle	220565

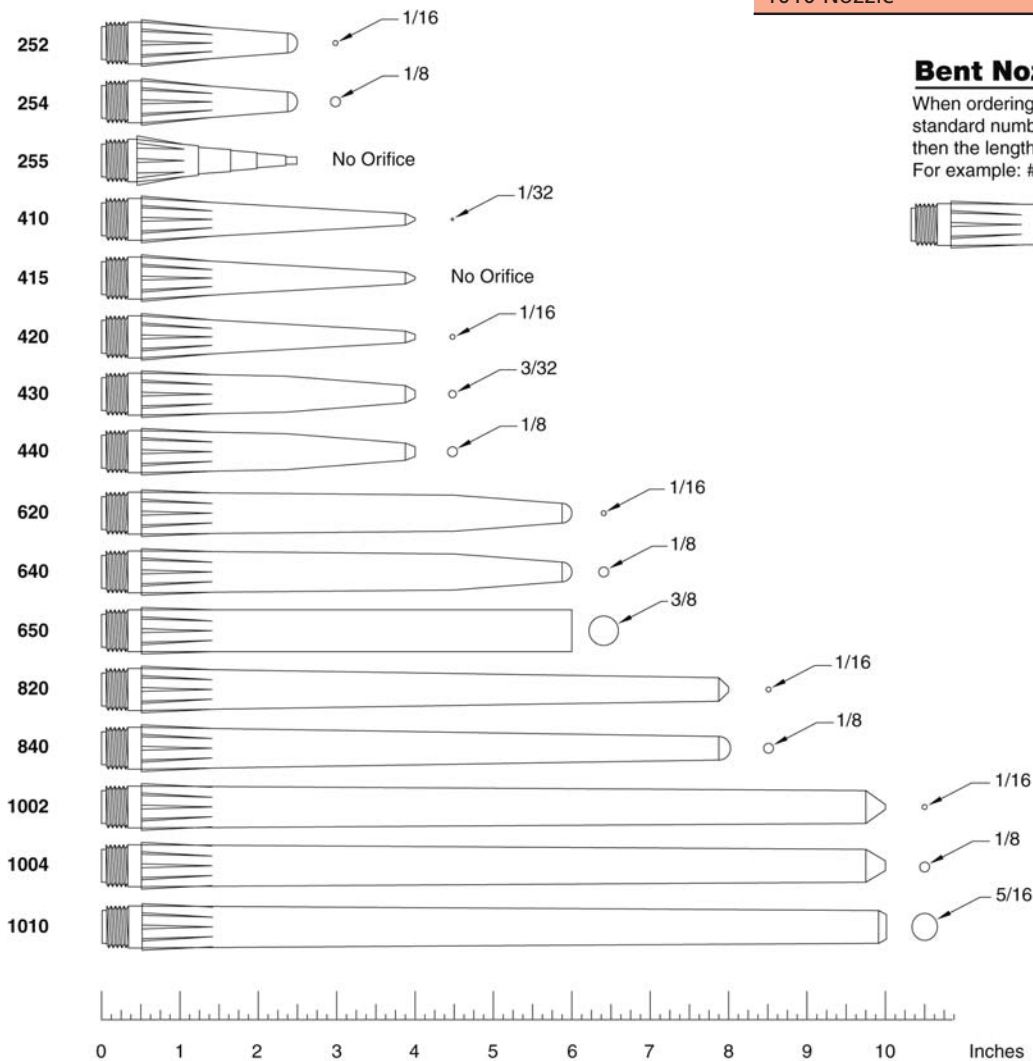

Bent Nozzles

When ordering bent nozzles, first give the standard number, then the angle of bend (D), then the length of bend from the tip (C). For example: # 640, 30°, 2"

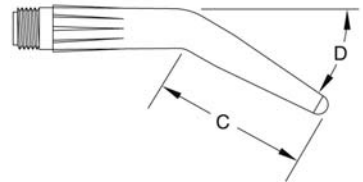

CALL TO ORDER (800) 237-6649

Semco® Fillet Nozzles

Semco® Fillet nozzles consistently apply sealant fillets over lap joints. These nozzles eliminate the need for tooling the sealant with spatulas, thereby increasing productivity.

The model 425, 426, 427, and 428 nozzles have a built-in step to guide the nozzle along the lap joint. This produces a smooth, uniform fillet. The model 429 nozzle has no step, offering versatility when used at odd angles and in confined spaces.

These disposable nozzles are precision molded and have a 1/4" NPT male thread to fit Semco® 1, 2.5, 6, 8, 12, 20, 32 oz. and 1/10 gallon disposable cartridges. When these nozzles are used in conjunction with a Semco® 250-A sealant gun, a smooth, uniform fillet can be applied each time.

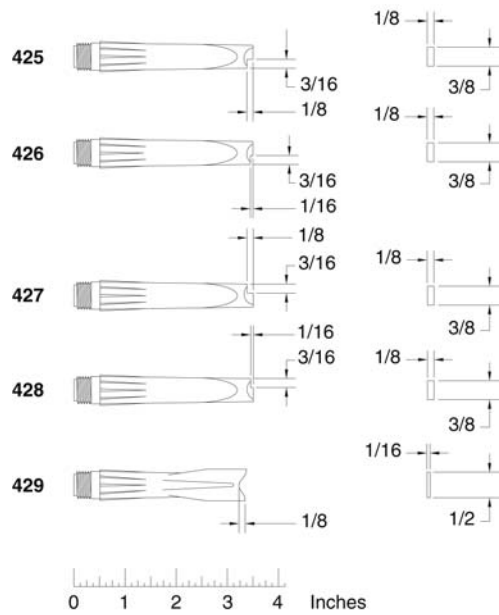

Fillet Nozzles

Description	Part Number
425 Nozzle	232499
426 Nozzle	232500
427 Nozzle	232501
428 Nozzle	232502
429 Nozzle	232590

Semco® Ribbon Nozzles

These disposable nozzles are precision molded and have a 1/4" NPT male thread to fit Semco® 1, 2.5, 6, 8, 12, 20, 32 oz., and 1/10 gallon disposable cartridges. A wide variety of specialty ribbon nozzles are available in various thicknesses and widths and are designed to better meet your application needs.

Ribbon Nozzles

Description	Part Number
8613 Nozzle	220572
8615 Nozzle	220574
8630 Nozzle	220581
8643 Nozzle	220586
8645 Nozzle	220587
8646 Nozzle	220588
8648 Nozzle	220589

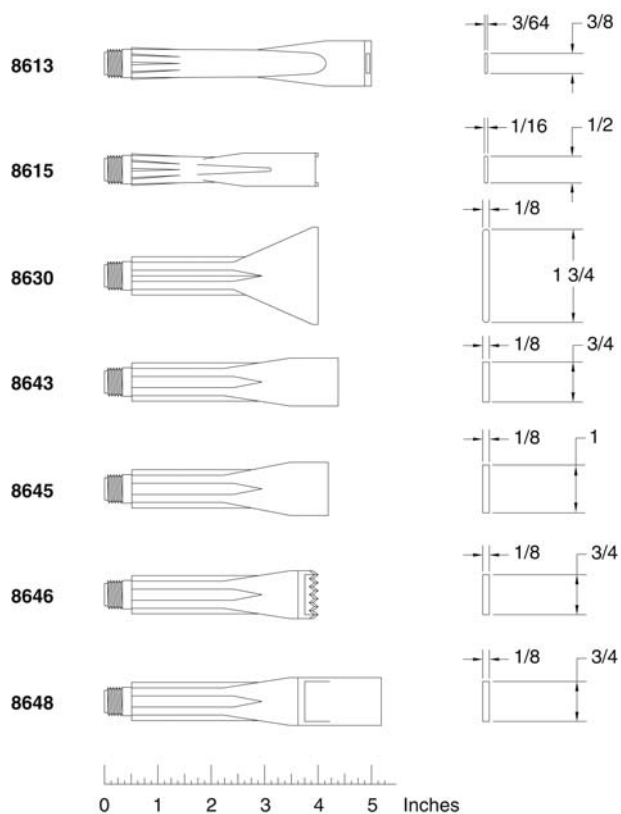

CALL TO ORDER (800)237-6649

Semco® Roller Nozzles

Semco® roller nozzles are designed to apply adhesives and sealants evenly over a wide area of substrate. They are ideal for the application of faying surface sealants. The 1/4" NPT male threaded end can be used with any of the Semco® disposable cartridges and Semkit® packages (i.e. 1, 2.5, 6, 8, 12, 20, 32 oz. and 1/10 gallon sizes). Roller nozzles are available in one and two inch widths. The roller base is precision molded of chemically resistant material and can be solvent cleaned for re-use. Replacement rollers can be purchased separately.



Roller Nozzles

Description	Part Number
1" Roller nozzle assembly	232693
2" Roller nozzle assembly	232692
1" Replacement roller	232701
2" Replacement roller	232702

Semco® Adapters

These disposable adapters are precision molded and have a 1/4" NPT male thread to fit Semco® 1, 2.5, 6, 8, 12, 20, 32 oz., and 1/10 gallon disposable cartridges. The syringe filler adapter is designed to allow easy filling of Luer Lock or Luer Slip syringes. The Sem-Luer Adapter converts the 1/4" NPT female thread of the standard Semco® cartridge to a male Luer Lock connection, allowing the easy attachment of any Luer Lock needle.

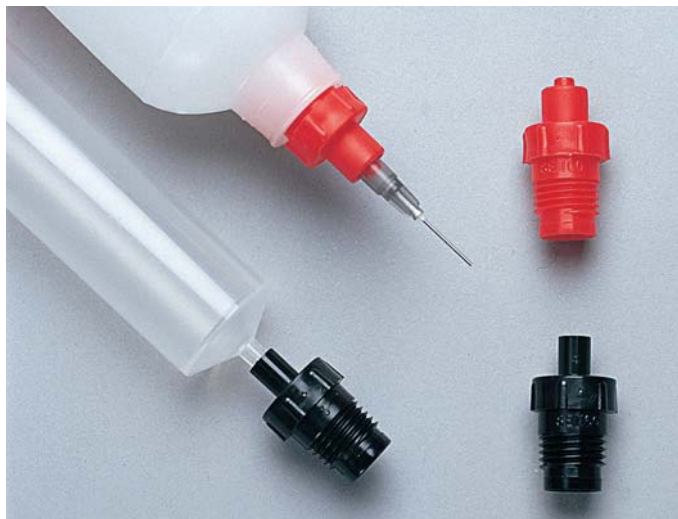

Adapters

Description	Part Number
Syringe filler adapter	310025
Sem-Luer adapter	231871

CALL TO ORDER (800) 237-6649

Semco® Sealant Smoothing Tools

These special reinforced plastic spatulas and spreaders are for tooling and smoothing sealants and adhesives.



Semco® Sealant Smoothing Tools

Description	Part Number
Spatula	231349
Spatula	226241
Spatula	226242
Spatula	226243
Scraper	234350
Sealant spreader	229394
Comb spreader	229395
Spatula kit (226241, 226242, 226243)	226244

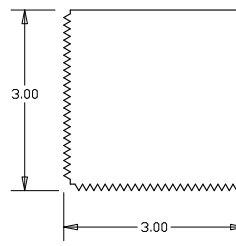
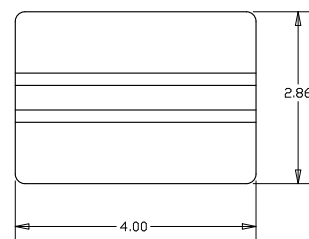
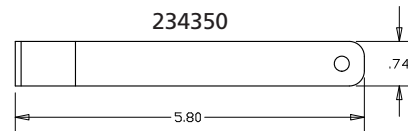
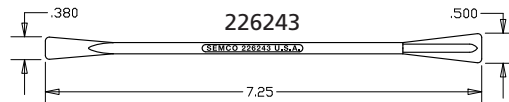
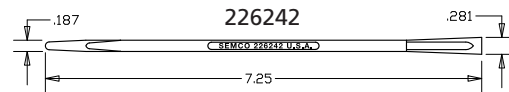
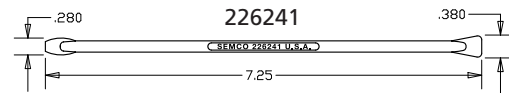
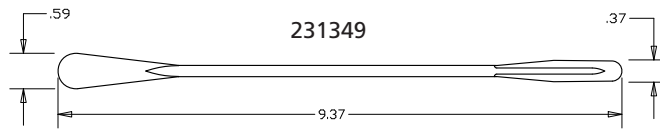

229394

229395

All Dimensions are in inches.

CALL TO ORDER (800)237-6649

Semco® 250-A GUN

The Semco® model 250-A sealant gun is the standard of the aerospace and electronics industries. It is designed for the quiet, pneumatic application of sealants, adhesives, potting compounds, and other materials packaged in Semco® disposable cartridges or Semkit® packages for multi-component materials.

The Semco® model 250-A gun is available with retainers to fit standard 1, 2.5, 6, 8, and 12 ounce disposable cartridges. Air hoses to operate the gun must be ordered separately (see page 17 for more information).

The gun is constructed of durable metal and engineered plastic parts designed to withstand the rigors of the production work place. The nickel plated retainers are affixed to the valve assembly via a quick connect, secure bayonet lock fixture, permitting easy replacement of cartridges. For use in confined locations, the handle can be easily removed to allow more clearance and better manipulation.



Model 250-A Gun (with Handle)

Description	Part Number
1 oz.	250015
2.5 oz.	250255
6 oz.	250065
8 oz.	250085
12 oz.	250125
Gun without retainer	250000

Features

- Reduces applied material cost.
- Provides accurate material control.
- Lightweight.
- Handle can be removed to facilitate application in confined areas.
- 0-100 psi (0-6.9 bar) operating range.
- Available in 1, 2.5, 6, 8, and 12 oz. sizes.
- Bayonet lock on retainer permits quick cartridge change.
- Durable, shock resistant parts.
- Touch control on trigger regulates flow.
- Positive control for smooth, even dispensing.
- Ergonomic design.
- Quiet operation.
- Hands-free/slotted retainer option.



CALL TO ORDER (800) 237-6649

Semco® Model 550 Sealant Gun

The Semco® Model 550 sealant gun is designed for the pneumatic application of sealant, caulking, adhesive, and other compounds packaged in Semco® 1/10 gallon, 20, and 32 oz. cartridges. Parts are available to convert the gun from one size to another. Air hoses to operate the gun must be ordered separately (see page 17 for more information).

These lightweight guns are constructed of cast aluminum and other durable materials. The 1/10 gallon cartridge retainer is secured to the gun via a springloaded quick-disconnect using the bayonet locking feature on the retainer. The 20 and 32 oz. retainers can be quickly and easily attached to the gun using a threaded bezel.



Features

- Reduces applied material cost.
- Provides accurate material control.
- Lightweight.
- 0-100 psi (0-6.9 bar) operating range.
- Available in 20, 32 oz. and 1/10 gallon sizes.
- Durable, shock resistant parts.
- Touch control on trigger regulates flow.
- Positive control for smooth, even dispensing.
- Quiet operation.

550 Retainers

All Semco® retainers are 100 psi pressure rated and designed for use with Semco® guns, cartridges, and dispensing systems. Retainers for the 20 and 32 oz. guns must be used with the appropriate bezel. Please contact our technical service department for more information.



Model 550 Gun

Description	Part Number
1/10 gallon	231551
20 oz.	231218
32 oz.	233688



550 Retainers

Description	Part Number
20 oz. assembly Includes bezel and retainer	229752
32 oz. assembly Includes bezel and retainer	233695
1/10 gallon	231903

CALL TO ORDER (800)237-6649

Semco® Model 850 Manual Dispensing Gun

The Semco® model 850 gun is a hand-operated, high quality dispensing gun designed to accept Semco® disposable cartridges or Semkit® packages.

It is excellent for the “in-field” application of sealants, adhesives, and other materials. The ratchet handle is made of metal for tough, durable, long-term use. A threaded retainer provides a tight fit into the ratchet handle, permitting uninterrupted operation. It also allows for the quick and easy replacement of cartridges. Custom size retainers accommodate Semco® 1, 2.5, 6, 8, 12, 20, 32 oz., and 1/10 gallon disposable cartridges. The retainers are available in metal or plastic.



Model 850 Manual Gun

Description	Part Number
1 oz. Plastic	231556
2.5 oz. Plastic	221825
2.5 oz. Metal	221824
6 oz. Plastic	221828
6 oz. Metal	221830
8 oz. Metal	221832
12 oz. Metal	221836
1/10 gallon Plastic	230273
20 oz. Metal	230274
32 oz. Metal	234054

Features

- Portable.
- Requires no air or power supply.
- Available in 1, 2.5, 6, 8, 12, 20, 32 oz. and 1/10 gallon sizes.
- Lightweight.
- Rugged, heavy gauge metal construction.
- Easy to operate.
- Dispenses a wide range of sealants, adhesives, or other materials.
- Handles thick, viscous materials.



CALL TO ORDER (800) 237-6649

Semco® Model 250-B Gun

The Semco® model 250-B handleless sealant gun is the new standard of the aerospace and electronics industries. It is designed for the quiet, pneumatic application of sealants, adhesives, potting compounds, and other materials packaged in Semco® disposable cartridges or Semkit® packages for multi-component materials.

The Semco® model 250-B gun is available with retainers to fit standard 1, 2.5, 6, 8, and 12 oz. disposable cartridges. Air hoses to operate the gun must be ordered separately (see page 17 for more information). The Semco® gun handle can not be attached to this model gun.

The gun is constructed of durable metal and engineered plastic parts designed to withstand the rigors of the production work place. The nickel plated retainers are affixed to the valve assembly via a quick connect, secure bayonet lock fixture permitting easy cartridge replacement.



Model 250-B Gun

Description	Part Number
1 oz.	250010B
2.5 oz.	250250B
6 oz.	250060B
8 oz.	250080B
12 oz.	250120B



CALL TO ORDER (800)237-6649

Features

- Reduces applied material cost.
- Provides accurate material control.
- Lightweight.
- 0-100 psi (0-6.9) bar operating range.
- Available in 1, 2.5, 6, 8, and 12 oz. sizes.
- Bayonet lock on retainer permits quick cartridge change.
- Durable, shock resistant parts.
- Touch control on trigger regulates flow.
- Positive control for smooth, even dispensing.
- Ergonomic design.
- Quiet operation.

Semco® Model 120 Mini Dispensing Gun

The Semco® model 120 mini dispensing gun is designed for the precise application of all types of viscous materials including liquids, pastes, etc. It can be used for any assembly, bonding, potting, or sealing application in the electronics, aerospace, and other industrial markets.

The Semco® model 120 mini dispensing gun's small size and light weight allow for continuous hand service at any ordinary work station or in confined areas at odd angles.



Model 120 Mini Gun

Description	Part Number
Mini 120 with hose assembly	232280

Repair Kits

All repair kits contain the most common components required to repair damage caused by normal wear and tear on our products. Please contact our technical service department for more information.

Repair Kits

Description	Part Number
Hansen connector assembly	229186
Aro connector assembly	229187
Schrader connector assembly	229188
B-Nut assembly	229189
250 A/B gun valve repair kit (shown)	240020



Dispensing Options using Retainers and Controllers



Hands-Free Dispensing Options for All Cartridge Sizes



250 Retainers

All Semco® retainers are 100 psi pressure rated and are designed for use with Semco® guns, cartridges, and dispensing systems. Please contact our technical service department for more information.

CALL TO ORDER (800)237-6649



250 Retainers

Description	Part Number
1 oz.	231611
2.5 oz.	220256
6 oz.	220928
8 oz.	220926
12 oz.	220923

850 Retainers

All Semco® retainers are designed for use with Semco® guns, cartridges, and dispensing systems. A bezel is required to attach 20 and 32 oz. cartridges to the Semco® model 850 gun series. Please contact our technical service department for more information.



850 Retainers

Description	Part Number
2.5 oz.	226819
6 oz.	226820
8 oz.	226821
12 oz.	226822
20 oz.	229740
32 oz.	233620
Bezel for 20 oz.	230209
Bezel for 32 oz.	234053
1/10 gallon	229777

Hose Assemblies

All hose assemblies come with a B-nut fitting to attach to the Semco® gun or equipment and the specified quick disconnect attachment. Other lengths and configurations are available. Please contact our technical service department for more information.



Hose Assemblies

Description	Part Number
Aro hose assembly - 5 ft.	280012
Aro hose assembly - 10 ft.	280013
Hansen hose assembly - 5 ft.	280000
Hansen hose assembly - 10 ft.	280001
Schrader hose assembly - 5 ft.	280006
Schrader hose assembly - 10 ft.	280007
Universal hose assembly - 5 ft. (with 1/4" NTP fitting)	231876
Universal hose assembly - 10 ft. (with 1/4" NTP fitting)	232649

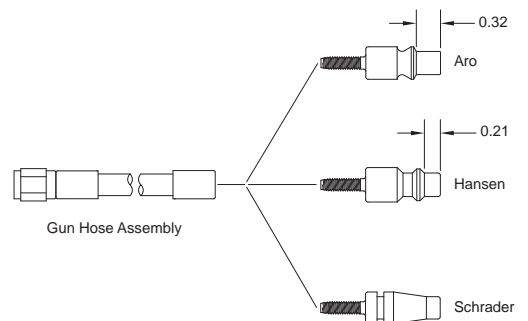

Automatic Semkit® Package Mixer

The Semco® model 388 Semkit® package mixer provides complete automatic mixing of filled Semkit® packages. Use of the mixer reduces worker fatigue and assures the user a more thorough and consistent mix, kit to kit.



Model 388 Automatic Semkit® Mixer

Description	Part Number
2.5, 6, 8 oz.	221269
1/10 gallon	230323
20 oz.	231145
1 oz.	232410
Fully pneumatic 2.5, 6, 8 oz.	232523

Features

- Automatic mixing of Semkit® packages.
- Assures consistent, thorough and uniform mixing.
- Easy to operate.
- Timer automatically shuts mixer off at pre-set mix time.
- Eliminates mixing labor and worker fatigue.
- Operates on 40 - 90 PSI, 1.2 CFM and 115 VAC.
- Shipping weight 75 lbs.

Portable Electric Semkit® Package Mixer

The Semco® model 285-A Semkit® package mixer provides semi-automatic mixing of filled Semkit® packages. Use of the mixer reduces worker fatigue and assures a more consistent, uniform mix. The drive spindle rotates the mixing rod while the operator strokes the cartridge vertically. This permits the rotating dasher to thoroughly mix the materials. The bell timer alerts the operator when the mix cycle is completed.



Semi-Automatic Electric Mixer

Description	Part Number
285-A mixer	229340

Features

- Semi-Automatic mixing of Semkit® packages.
- Easy to operate.
- Provides consistent, uniform mixing.
- Reduces time and effort for thorough mixing.
- Portable.
- Bell timer signals completion of mix.
- Operates on 115 VAC.
- Shipping weight 14 lbs.

CALL TO ORDER (800)237-6649

Semco® Model 195 Shot Meter

This positive displacement shot meter allows for precise dispensing of .1 to 20cc's of material. Ideally suited for syringe filling, this system uses the 2.5, 6, 8, 12, 20, and 32 oz. Semco® cartridges as material reservoirs. (Part numbers shown are for the 6 oz. cartridge only. Please contact your local representative for more information).



Model 195 Shot Meter

Description	Part Number
13cc piston	228953 P0006
20cc piston	228953 P2006

Features

- Positive displacement.
- All parts exposed to material are disposable.
- Handles a wide range of viscosities.
- Shot size is from 0 to 13cc, reproducible +/- 0.02cc.
- Foot valve-actuated.
- Panel mounted air pressure regulator and gauge included for reservoir.
- Dimensions: 31" x 8" x 15".
- Shipping weight: 16 lbs.



CALL TO ORDER (800) 237-6649

Hybrid Syringe Systems

Patented Hybrid Technology reduces air entrapment!
This gives our customers a technology, quality and application advantage!

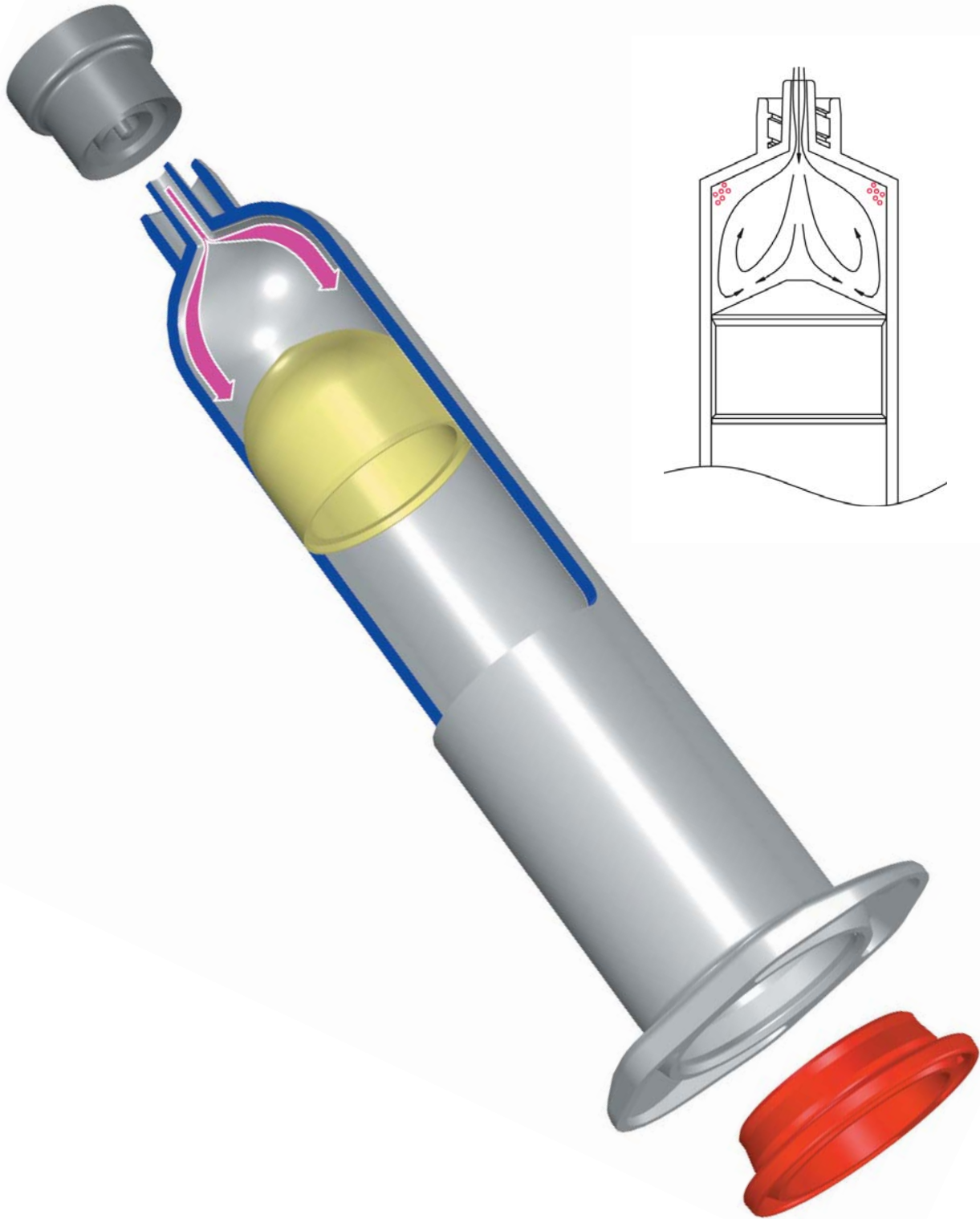

CALL TO ORDER (800)237-6649

Semco® Hybrid Syringe Barrels

The patented Semco® hybrid syringe barrels dramatically reduce air-entrapment by eliminating the sharp corners found in most traditional syringes. The radius neck reduces voids or pockets of air created during filling. All barrels are molded of polypropylene and are manufactured silicone free. The Semco® hybrid syringe range is available in natural, black and light blue UV block as standard stock items. Other colors are available but minimum order quantities, lead time, and pricing considerations do apply.



Hybrid Syringe Barrel

Description	Part Number
5cc Syringe barrel, natural	360516
10cc Syringe barrel, natural	361016
30cc Syringe barrel, natural	363016
55cc Syringe barrel, natural	365516

Semco® Hybrid Pistons

There are three different pistons to meet your application needs: A micro-interference fitting P-piston, a low friction piston (LF), and a non-interference fitting piston (NI).

The higher the interference, the cleaner the wiping action on the inner diameter of the syringe barrel. However, this increases the potential for air-entrapment. You may want to sample a variety of pistons to find the right product for your material and application. Each piston is molded from polyethylene and meets the rigid requirements of high tech industries.



Hybrid Syringe Pistons

Description	Part Number
5cc P-Piston, yellow	360505
5cc WP-Piston, red	360504
10cc P-Piston, yellow	361005
10cc LF-Piston, white	361035
10cc NI-Piston, blue	361008
30cc/55cc P-Piston, yellow	363005
30cc/55cc LF-Piston, white	363035
30cc/55cc NI-Piston, blue	363008



LF Piston



P Piston



NI Piston

CALL TO ORDER (800) 237-6649

Semco® Flange Caps

Flange caps are designed to seal the large open end of the syringe, ensuring the piston is contained and that no contaminants come in contact with material during storage and shipment. All hybrid flange caps have a special tamper evident feature. In order to remove the cap, the user must detach the safety seal, which is then used as a pull ring to remove the cap, clearly identifying if the product has been opened.



Flange Caps

Description	Part Number
5cc Flange cap	360503
10cc Flange cap	361003
30cc/55cc Flange cap	363003



Semco® Tip Caps

Tip caps are used to seal the syringe dispensing tip during storage and shipment. Three different styles are available to fit any Luer Lock or Luer Slip connection. Our patented black spike tip cap has a stem or “spike” that is inserted into the syringe dispensing tip. This helps evacuate air during and after filling. The large flat surface enables the user to store the syringe with the dispensing tip down. This allows any existing air to migrate toward the syringe piston, where it can be easily evacuated. Please contact our technical service department for more information.

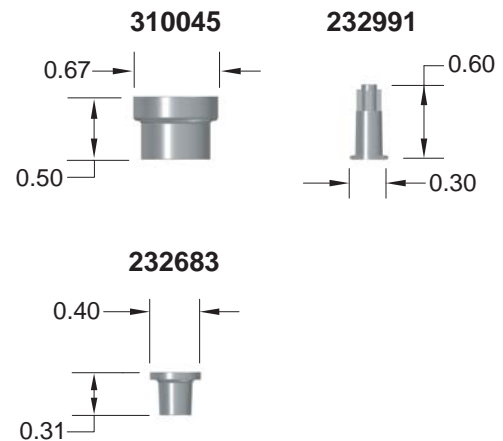

Tip Caps

Description	Part Number
Black spike tip cap	310045
Grey rubber tip cap	232683
Red plastic tip cap	232991

CALL TO ORDER (800)237-6649

Sem-Luer / Sem-Flex Needles

The Sem-Luer needles are constructed with rigid stainless steel, blunt-end tubing. The Sem-Flex needles are constructed with flexible Teflon®, blunt-end tubing. Both product lines are designed to fit all Luer Lock and Luer Slip connections. All Semco® needles are manufactured with a plastic, international color coded hub for easy size identification. These products are precision manufactured for micro-dot and bead applications. All needles are non-sterile and intended for industrial use only. The Sem-Flex needle is specifically designed for use with cyanoacralates or anaerobic materials and will not scratch or blemish sensitive surfaces.



Sem-Luer Needles

Part #	Gage	O.D.	I.D.	Length	Hub Color
231843	14	.083"	.066"	1/2"	Dark green
231844	14	.083"	.066"	1"	Dark green
231845	15	.072"	.060"	1/2"	Orange
231846	15	.072"	.060"	1"	Orange
231849	18	.049"	.038"	1/2"	Pink
231850	18	.049"	.038"	1"	Pink
231851	19	.042"	.032"	1/2"	Brown
231852	19	.042"	.032"	1"	Brown
231853	20	.035"	.026"	1/2"	Yellow
231854	20	.035"	.026"	1"	Yellow
231855	21	.032"	.023"	1/2"	Green
231856	21	.032"	.023"	1"	Green
231857	22	.028"	.020"	1/2"	Black
231858	22	.028"	.020"	1"	Black
231859	23	.025"	.017"	1/2"	Light blue
231860	23	.025"	.017"	1"	Light blue
231863	25	.020"	.012"	1/2"	Blue
231864	25	.020"	.012"	1"	Blue
231866	26	.018"	.010"	1/2"	Peach
231867	27	.016"	.009"	5/16"	Tan
231869	30	.012"	.006"	5/16"	Lavender

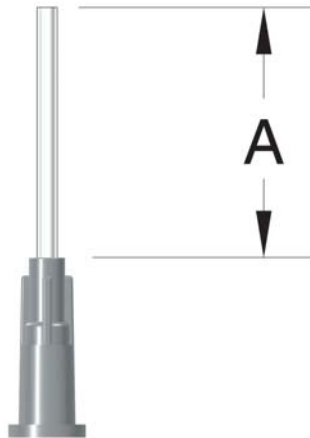

Sem-Flex Needles

Part #	Gage	O.D.	I.D.	Length	Hub Color
232728	14	.082"	.066"	1"	Dark green
232730	15	.071"	.059"	1"	Orange
232734	18	.054"	.042"	2"	Pink
232736	20	.046"	.034"	1"	Yellow
232742	23	.038"	.026"	1"	Light blue
232745	26	.030"	.018"	1/2"	Peach
232893	26	.030"	.018"	1/8"	Peach
232748	28	.027"	.015"	1"	Tan
232749	30	.024"	.012"	1/2"	Lavender

CALL TO ORDER (800) 237-6649

Luer Lock Syringes

Luer Lock Syringes

Disposable plastic Luer Lock syringes are available in 3, 6, 10, 20, 35, and 60cc capacities for both manual and pneumatic use. Luer Lock syringes are a convenient application and dispensing package. Luer Lock syringes are ideal for electronic and various other small assembly operations where adhesives, solder pastes and masks, sealants, potting compounds, greases, and many other materials are used. All barrels are molded of polypropylene. Special colors are available, however minimum order, lead time, and pricing considerations apply.



Features

- High quality, precision molded syringe barrels and plunger rods with flexible stoppers.
- Syringe barrels are translucent for excellent visibility of material level.
- All syringe components are chemical resistant.
- Ideal for pre-mixed and frozen material application.
- Non-sterile for industrial use only.
- Luer Lock tip assures secure affixing of blunt end dispensing needles.

Luer Lock Manual Assemblies

Description	Part Number
3cc	310346
6cc	310646
10cc	311046
20cc	312046
35cc	313546
60cc	316046

Manual assemblies include: barrel, plunger rod and piston.

Luer Lock Barrels

Description	Part Number
3cc	310316
6cc	310616
10cc	311016
20cc	312016
35cc	313516
60cc	316016

Luer Lock Pistons

Description	Part Number
3cc	310305
6cc	310605
10cc	311005
20cc	312005
35cc	313505
60cc	316005

Piston Material: Thermal Plastic Rubber

Luer Slip Syringes

Disposable plastic Luer Slip syringes are available in 1, 3, 6, 10, 20, 35, and 60cc capacities for both manual and pneumatic use. Luer Slip syringes are a convenient application and dispensing package and are ideal for electronic and various other small assembly operations. They facilitate the application of adhesives, solder pastes and masks, sealants, potting compounds, greases and many other materials. All barrels are molded of polypropylene. Special colors are available, however minimum order, lead time, and pricing considerations apply.



Features

- High quality, precision molded syringe barrels and plunger rods with flexible stoppers.
- Syringe barrels are translucent for excellent visibility of material level.
- All syringe components are chemical resistant.
- Ideal for pre-mixed and frozen material application.
- Non-sterile for industrial use only.
- Luer Slip tip assures interference free fit of blunt end dispensing needles.

Luer Slip Manual Assemblies

Description	Part Number
1cc	310132
3cc	310332
6cc	310632
10cc	311032
20cc	312032
35cc	313532
60cc	316032

Manual assemblies include: barrel, plunger rod and piston.

Luer Slip Barrels

Description	Part Number
3cc	310307
6cc	310607
10cc	311007
20cc	312007
35cc	313507
60cc	316007

Luer Slip Pistons

Description	Part Number
3cc	310305
6cc	310605
10cc	311005
20cc	312005
35cc	313505
60cc	316005

Piston Material: Thermal Plastic Rubber

The Semmatic® Series 2200

The Semmatic® 2200 is a precision system that applies accurate, consistent amounts of adhesives, lubricants, silicones, epoxies and other assembly fluids from controlled beads to uniform dots.

The benefits of the system's consistent fluid application include higher yields, reduced material costs, better process control, and a safer working environment. The Semmatic® 2200 features digital timer control with a range of 0.01 seconds to 31 seconds and vacuum draw back to prevent dripping when dispensing low viscosity fluids.

The unit is supplied complete with a Semco® Hybrid Syringe "starter pack" of high quality, precision molded Semco® disposable components.

Please contact your local Semco® distributor or our technical service department for more information.



The Semmatic® Series

Description	Part Number
Semmatic 2200	50000



Pneumatic Adapter Assemblies

Adapter assemblies are designed to attach syringes quickly and easily to pneumatic dispensing equipment. These assemblies allow the attachment of the Semco® Hybrid Syringe Series to all Semmatic® dispensing units. (These assemblies will not fit other Semco® syringes.)



Pneumatic Adapter Heads

Description	Part Number
5cc Adapter head assembly	360500
10cc Adapter head assembly	361000
30cc/55cc Adapter head assembly	363000

CALL TO ORDER (800)237-6649

ProFlow™ Cassette

Manufactured under license from DEK/Novatech, PPG Industries, Semco® Packaging & Application Systems has designed and produced the ProFlow™ Cassette. This product is specifically designed to be used with DEK DirEKt Imaging™ process, for screen print solder paste applications. Made from a flexi-rigid 30 percent talc-fill polypropylene, the construction incorporates an integral transition-fit piston assembly to distribute the transfer pressure from the ProFlow™ head evenly across the paste mass. The design offers a substantial reduction in waste, is easily and quickly filled with paste, and is offered in two configurations. It includes five basic components: cassette base, aluminum foil barrier, plunger, plunger seal, and snap-fit lid.



ProFlow™ Cassette

Description	Part Number
Assembly 1 Includes: base w/foil attached, piston w/gasket assembled, cap	234607
Assembly 2 Includes: base, foil, piston w/gasket assembled, cap	234608



"Green" ProFlow™ Cassette

To meet the needs of the ever-increasing lead-free solder paste market, Semco® Packaging and Application Systems now offers a "Green" identifier to minimize confusion with end users. This assembly includes a green foam diamond on the piston and a green cassette lid.



"Green" ProFlow™ Cassette

Description	Part Number
ProFlow Cassette Assembly, "Green" Includes: base w/foil attached piston w/gasket assembled, green cap	234632
"Green" foam insert (unassembled)	234635
"Green" ProFlow cap	234631

CALL TO ORDER (800) 237-6649



Application Support Centers

We have over 45 years of experience in handling the packaging and dispensing of a variety of materials. Our superior products are available through direct distributors and a global network of Application Support Centers. These facilities are strategically located to provide customers with local service and product support. In addition, each network location is stocked with an expansive inventory so that we can deliver our products to your assembly line quickly, safely, and cost-effectively.



Putting Our Expertise to the Test

Our Application Support Center network was specifically created to provide our customers with the benefit of our knowledge and experience. Let our packaging experts put these skills to work for your company. They can help find ways to improve your manufacturing process using our products and services.



We also offer a wide range of value-added packaging services through our facilities. Value-added packaging means we will either provide or receive bulk packaged materials, such as cans and drums. The bulk materials are then redistributed to your assembly line as application ready packages. Value-added packaging is currently available for these products:

- Semkit® Packages
- Syringes
- Hinge Packs
- Semco® Cartridges
- Side by Side Cartridges (for mix on demand applications)

Ask our customer service team for information on our value-added packaging services to dramatically reduce material exposure, production time, and cost.



Special Handling Instructions

Our facilities are also capable of managing a wide range of special handling instructions such as hazardous or flammable materials, foil bagging, nitrogen purging, air-free filling, and other services. Our personnel have hands on experience with the most rigorous packaging requirements.



Locations

We have seven North American Application Support Centers: Atlanta, Dallas, Indianapolis, Los Angeles, Philadelphia, Seattle and Canada. Internationally we have facilities in Australia, China, Dubai, Germany, Gonfreville, Hong Kong, Japan, Singapore, South Africa and the United Kingdom.



Independent Distribution

In areas where a direct support facility is not available, our products and services are provided through qualified independent distributors. This independent network has earned our complete support and confidence over the years because of their proven track record of customer service. To find out more about an independent distributor or authorized repackaging facility in your area, please contact our customer service department at 1-800-237-6649.

Application Support Centers



For the Application Support Center nearest you,
please visit our website at www.semcopackaging.com



Semco® Packaging & Application Systems -
The Quality, Innovation, and Service Leader.



For the Application Support Center nearest you, please visit our website at www.semcopackaging.com

All recommendations, statements, and technical data contained herein are based on test we believe to be reliable and correct, but accuracy and completeness of said tests are not guaranteed and are not to be construed as a warranty, either expressed or implied. User shall rely on his own information and tests to determine suitability of the product for the intended use and assumes all risks and liability resulting from his use of the product. Seller's and manufacturer's sole responsibility shall be to replace that portion of the product of this manufacturer which proves to be defective. Neither seller nor manufacturer shall be liable to the buyer or any third person for injury, loss, or damage directly or indirectly resulting from use of, or inability to use, the product. Recommendations or statements other than those contained in a written agreement signed by an officer of the manufacturer shall not be binding upon the manufacturer or seller.

Semco, Semkit, Semmatic and Sempen are trademarks of PRC-DeSoto International, Inc. Teflon is a registered trademark of DuPont. Proflow and DirEKt Imaging are registered trademarks of DEK Printing Machines Ltd.

 **PPG Industries**
Semco® Packaging &
Application Systems

PRC-DeSoto International, Inc.
12780 San Fernando Road
Sylmar, California 91342 USA
Telephone (818) 362-6711
Toll Free (800) 237-6649

www.semcopackaging.com

Issued : 05/10
Supersedes : 12/07
Lit# : 0600