

X 5:1

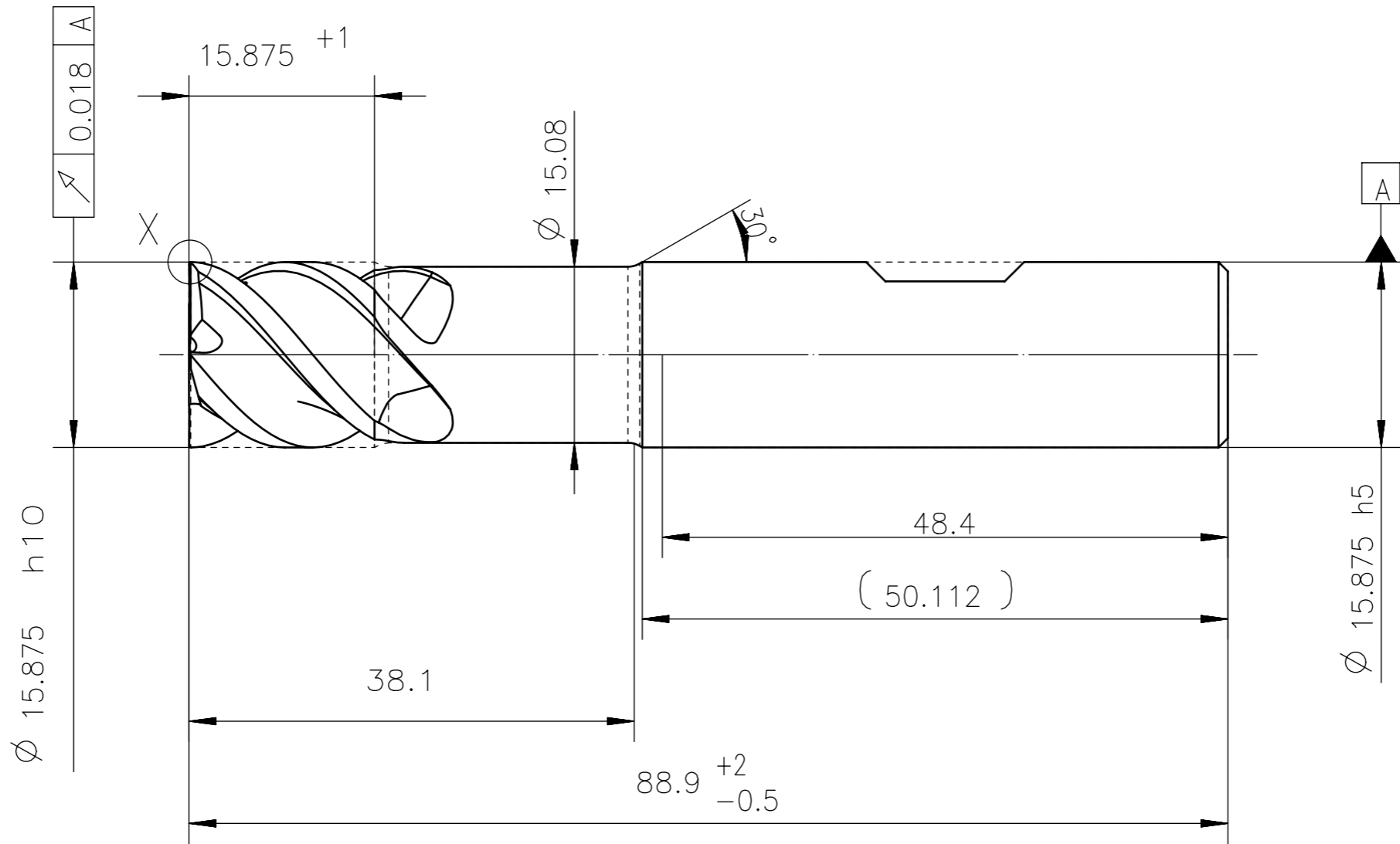

center cut

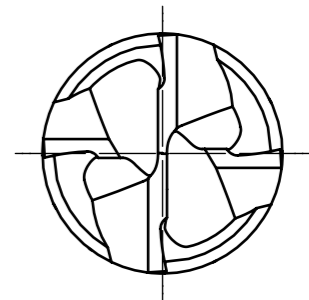

Characteristics:	
Number of teeth	4
Cutting direction	right
Spiral direction	right
Spiral angle	50
Type of face	center cut
Type of shank	DIN 6535 HB

Qty.	Description	Det.	Dwg. No.	Material
Proprietary Information DIN ISO 16016:2002-5 We reserve all Rights to this drawing including for the purpose of issuing patents and registration of petty patents. Without our written consent this drawing may not be copied, whole or partially, and may not be misused by the recipient as well as third parties. Any infraction will result in compensation for occurred damages and could lead to legal action by the author.				Scale: 2:1 Format: A3
				Grade: WK40TF
				Description: Supreme MC326
				Drawing-No.: MC326-6579317 D10
Rev.	Revision	Date	Name	Cust. No.:
				Ord.-Code: MC326.15.9W4DCJ-WK40TF

