

Compliments of Riten Industries

1-800-338-0027

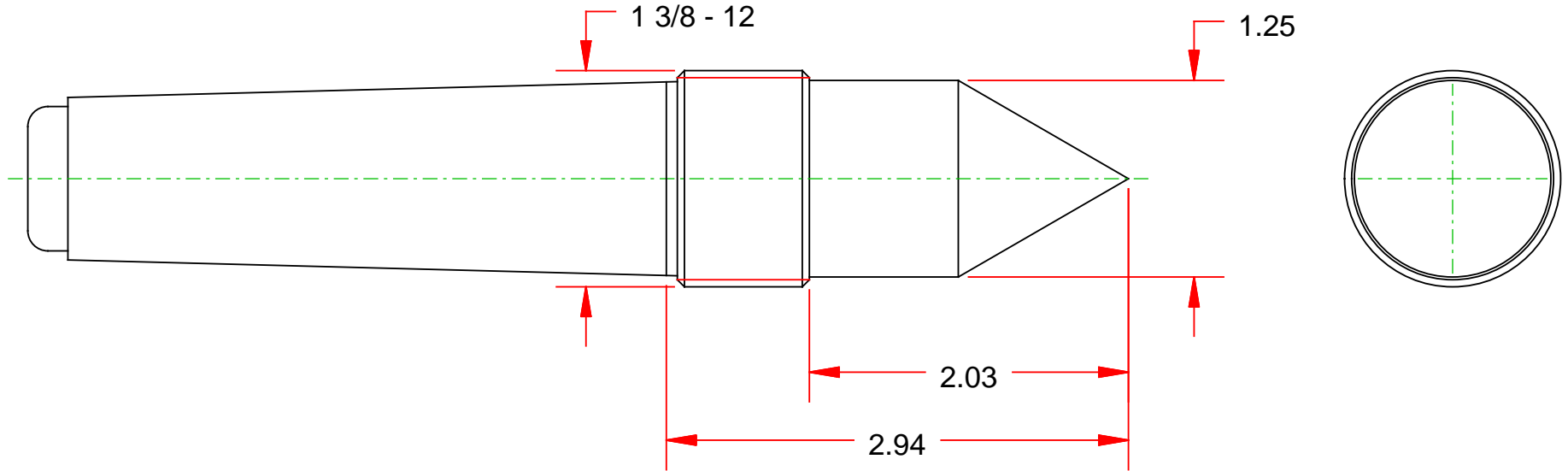

PART NAME

CNC Dead Centers - Steel

PART NUMBER

68604