

Doosan Puma 300 M/MS

Tool holder program

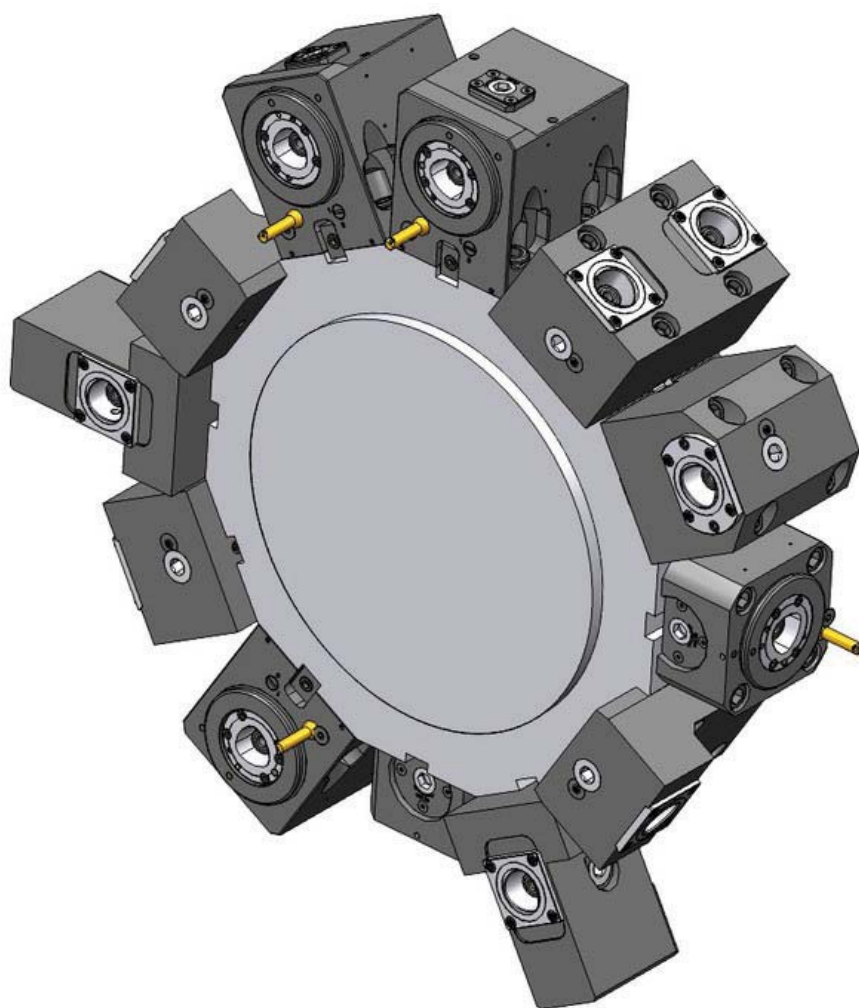

Doosan Puma 300 M/MS

Coromant Capto® Program

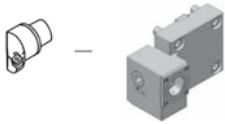

OD clamping unit

C4	C4-TRE-BT65A (343-830111C997-RC)	Standard
C4	C4-TLE-BT65A (343-830111C997-LC)	Standard

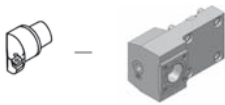

Straight clamping unit

C5	343-830111C566	Special
----	----------------	---------

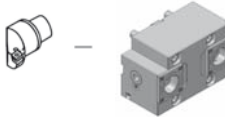

Straight clamping unit, both sides

C4	C4-TRE-BT64A-DT (343-830111C998-RC)	Standard
C4	C4-TLE-BT65A-DT (343-830111C998-LC)	Standard

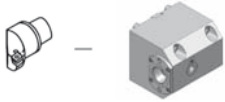

Right angle clamping unit, short

C4	343-830111C569	Special
C5	343-830111C570	Special

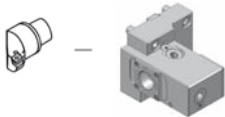

Right angle clamping unit, both sides

C4	343-830111C575	Special
----	----------------	---------

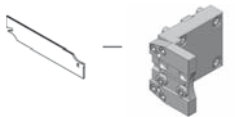

Cut-off holder, adjustable

SH 32	APB-TNE-BT65A-25	Standard
-------	------------------	----------



Straight drill/milling unit

C4	C4-DNE-BT65A-E	1:1	EC	Standard
C4	C4-DNE-BT65A-I	1:1	IC 80 bar	Standard



Right angle drill/milling unit, L2-72

C4	343-830820N2398	1:1	EC	Special
C4	343-830820N2399	1:1	IC 80 bar	Special