

Puma 400, 480 M/LM

Coromant Capto® Program

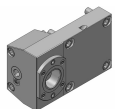
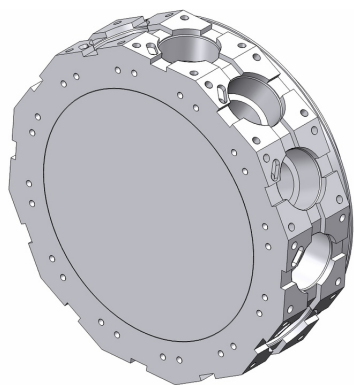

OD clamping unit

C5	C5-TRE-BT75A	Standard
C5	C5-TLE-BT75A	Standard

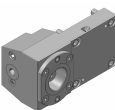

OD clamping unit

C6	C6-TRE-BT75A	Standard
C6	C6-TLE-BT75A	Standard

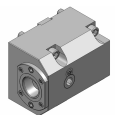

Face and ID clamping unit

C5	C5-TRI-BT75A	Standard
C5	C5-TLI-BT75A	Standard
C6	C6-TRI-BT75A	Standard
C6	C6-TLI-BT75A	Standard

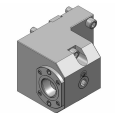

Face and ID clamping unit

C5	343-830111C582	For quotation
C6	343-830111C583	For quotation

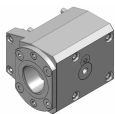

Face and ID clamping unit

C8	C8-TRI-BT75A	Standard
C8	C8-TLI-BT75A	Standard

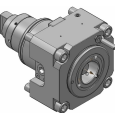

OD drill/milling unit

C5	C5-DNE-BT75A-E	1:1	EC	Standard
C5	C5-DNE-BT75A-I	1:1	IC 80 bar	Standard

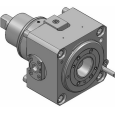

OD drill/milling unit (special offer!)

C5	343-830820N1147	1:1	EC	For quotation
C5	343-830820N911	1:1	IC 30 bar	For quotation

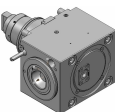

Face drill/milling unit, L2=60

C5	C5-DNI-BT75A-E	1:1	EC	Standard
C5	C5-DNI-BT75A-I	1:1	IC 80 bar	Standard

Turning applications

Tool holder	Insert/Tool	Insert
T-Max® P	 > CNMG	
CoroTurn® 107	 > CCMT	
T-Max® P	 > DNMG	
CoroTurn® 107	 > DCMT	
CoroTurn® 107	 > VBMT	
CoroThread® 266	 > 266	
CoroTurn® SL	 > CoroTurn® 107	 > TCMT
CoroTurn® 107		
CoroTurn® 107		
Silent Tools™	 > CoroTurn® 107	 > VBMT
Drill adaptor	 > CoroDrill® 870	 > Exchangeable drill tip
	 > CoroDrill® 881	 > Indexable drilling insert
	 > EasyFix	 > Boring bars
		 > Boring bars
		 > Boring bars

Rotating applications

Tool holder	Insert/Collet/Tool	Insert
Coromant EH	 > CoroMill® 316	
	 > CoroMill® 390	 > R390 
	 > CoroMill® 490	 > 490R 
	 > CoroMill® 216	 > R216 
	 > CoroMill® 300	 > R300 
	 > CoroBore® 824	 > CXS 
	 > CoroBore® 825	 > TCMT 
CoroChuck™ 930	 > Cylindrical collet	 > CoroMill® Plura 
		 > CoroDrill® 860 
ER collet chuck	 > ER collet	 > CoroMill® Plura 
		 > CoroDrill® 860 
CoroMill® 390	 > R390	