

Hwacheon VT 550 MC

Toolholder Program



VT 550 MC

Coromant Capto® Program

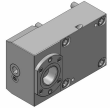
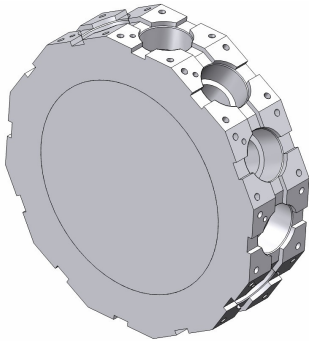

OD clamping unit

C5	C5-TRE-BT75B (343-830111C1016-RC)				Standard
C5	C5-TLE-BT75B (343-830111C1016-LC)				Standard

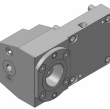

OD clamping unit

C6	343-830111C992				For quotation
----	----------------	--	--	--	---------------

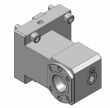

Face and ID clamping unit

C5	343-830111C1175				For quotation
----	-----------------	--	--	--	---------------

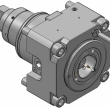

OD drill/milling unit

C5	C5-DNE-BT75A-E (410105016-75)	1:1	EC		Standard
C5	C5-DNE-BT75A-I (410105017-75)	1:1	IC 80 bar		Standard

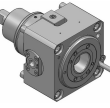

OD drill/milling unit (special offer!)

C5	343-830820N1147 (410105012-75)	1:1	EC		For quotation
C5	343-830820N911 (410105011-75)	1:1	IC 30 bar		For quotation

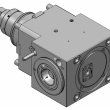

Face drill/milling unit, L2=110

C5	343-830820N2410 (410505005-75)	1:1	EC		For quotation
C5	343-830820N2411 (410505006-75)	1:1	IC 80 bar		For quotation