

# DMG MORI NT/NTX 1000, 2000

Toolholder Program



# NT/NTX 1000, 2000

Coromant Capto® Program

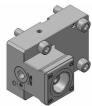
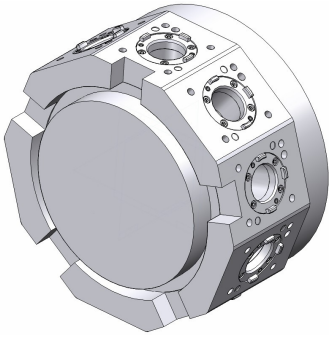

## OD clamping unit

C4	C4-TRE-MS40A	Standard
C4	C4-TLE-MS40A	Standard

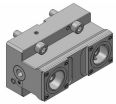

## OD clamping unit, both sides

C4	C4-TRE-MS40A-DT	Standard
C4	C4-TLE-MS40A-DT	Standard

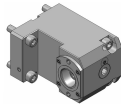

## Face and ID clamping unit

C4	C4-TRI-MS40A	Standard
C4	C4-TLI-MS40A	Standard

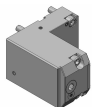

## Face and ID clamping unit, back set

C4	C4-TRI-MS40A-SS	Standard
C4	C4-TLI-MS40A-SS	Standard

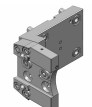

## Cut-off holder, adjustable

SH 32	APB-TNE-MS40A-25	Standard
-------	------------------	----------

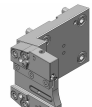

## Cut-off holder, adjustable, IC

SH 32	APBR-MS40A-25-HP IC 80 bar	Standard
SH 32	APBL-MS40A-25-HP IC 80 bar	Standard

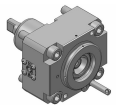

## OD drill/milling unit

C3	343-830820N1589 1:1	EC	For quotation
C3	C3-DNE-MS40A-I 1:1	IC 80 bar	Standard
C4	C4-DNE-MS40A-E 1:1	EC	Standard
C4	343-830820N2341 1:1	IC 80 bar	For quotation

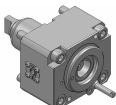

## OD drill/milling unit (12000 RPM)

C3	C3-DNE-MS40A-E-HS 1:1	EC	Standard
----	-----------------------	----	----------

# NT/NTX 1000, 2000

## Coromant Capto® Program

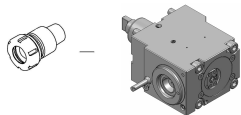

### Face drill/milling unit

C3	343-830820N2468 1:1	EC	For quotation
C3	343-830820N2469 1:1	IC 80 bar	For quotation
C4	C4-DNI-MS40A-E 1:1	EC	Standard
C4	C4-DNI-MS40A-I 1:1	IC 80 bar	Standard

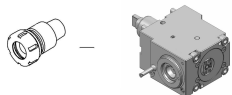

### Face drill/milling unit (12000 RPM)

C3	C3-DNI-MS40A-E-HS 1:1	EC	Standard
C3	C3-DNI-MS40A-I-HS 1:1	IC 80 bar	Standard

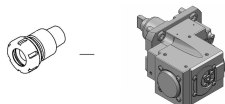

### Face back set drill/milling unit

C3	343-830820N2305 1:1	EC	For quotation
C3	343-830820N1884 1:1	IC 80 bar	For quotation

# Turning applications

Tool holder	Insert/Tool	Insert
T-Max® P	 > CNMG	
CoroTurn® 107	 > CCMT	
T-Max® P	 > DNMG	
CoroTurn® 107	 > DCMT	
CoroTurn® 107	 > VBMT	
CoroThread® 266	 > 266	
CoroTurn® SL	 > CoroTurn® 107	 > TCMT
CoroTurn® 107		
CoroTurn® 107		
Silent Tools™	 > CoroTurn® 107	 > VBMT
Drill adaptor	 > CoroDrill® 870	 > Exchangeable drill tip
	 > CoroDrill® 881	 > Indexable drilling insert
	 > EasyFix	 > Boring bars
		 > Boring bars
		 > Boring bars

## Rotating applications

Tool holder	Insert/Collet/Tool	Insert
Coromant EH	 > CoroMill® 316	
	 > CoroMill® 390	 > R390 
	 > CoroMill® 490	 > 490R 
	 > CoroMill® 216	 > R216 
	 > CoroMill® 300	 > R300 
	 > CoroBore® 824	 > CXS 
	 > CoroBore® 825	 > TCMT 
CoroChuck™ 930	 > Cylindrical collet	 > CoroMill® Plura 
		 > CoroDrill® 860 
ER collet chuck	 > ER collet	 > CoroMill® Plura 
		 > CoroDrill® 860 
CoroMill® 390	 > R390	