

Doosan Lynx 220 LMS/LY/LSY

Toolholder Program



Lynx 220 LMS/LY/LSY

Coromant Capto® Program

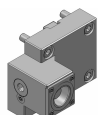
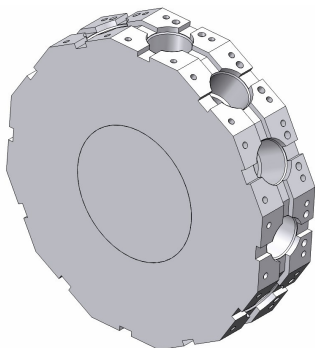

Straight clamping unit

C3	343-830111C956	For quotation
C4	C4-TRE-BT45A (343-830111C957-RC)	Standard
C4	C4-TLE-BT45A (343-830111C957-LC)	Standard

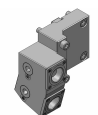

Straight clamping unit, double

C3	343-830111C1058	For quotation
----	-----------------	---------------

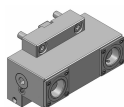

Straight clamping unit, both sides

C3	343-830111C1228	For quotation
----	-----------------	---------------

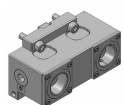

Straight clamping unit, both sides

C4	343-830111C1056	For quotation
----	-----------------	---------------

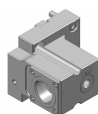

Right angle clamping unit, L2=65

C3	343-830111C958	For quotation
C4	C4-TRI-BT45A (343-830111C959-RC)	Standard
C4	C4-TLI-BT45A (343-830111C959-LC)	Standard

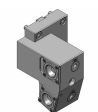

Right angle clamping unit, double

C3	343-830111C1059	For quotation
----	-----------------	---------------

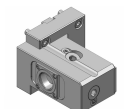

Right angle clamping unit, both sides

C3	343-830111C1229	For quotation
----	-----------------	---------------

Lynx 220 LMS/LY/LSY

Coromant Capto® Program

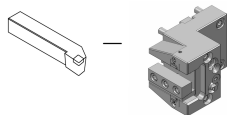

OD cutting holder, IC

20	ASH-TNE-BT45A-20HP IC 80 bar (343-810100C16)	Standard
----	---	----------

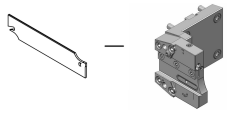

Cut-off holder, adjustable, IC

SH 26	APBR-BT45A-21-HP IC 80 bar (343-810100R21)	Standard
SH 26	APBL-BT45A-21-HP IC 80 bar (343-810100L21)	Standard

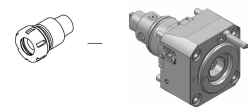

Straight drill/milling unit

C3	C3-DNE-BT45A-E 1:1 EC (410103005-45)	Standard
C3	C3-DNE-BT45A-I 1:1 IC 80 bar (410103006-45)	Standard

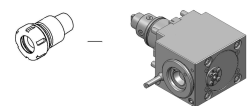

Right angle drill/milling unit

C3	C3-DNI-BT45A-E 1:1 EC (410503006-45)	Standard
C3	C3-DNI-BT45A-I 1:1 IC 80 bar (410503007-45)	Standard