

Make the most out of your holemaking operation

SANDVIK
Coromant

Cutting-edge holemaking solutions

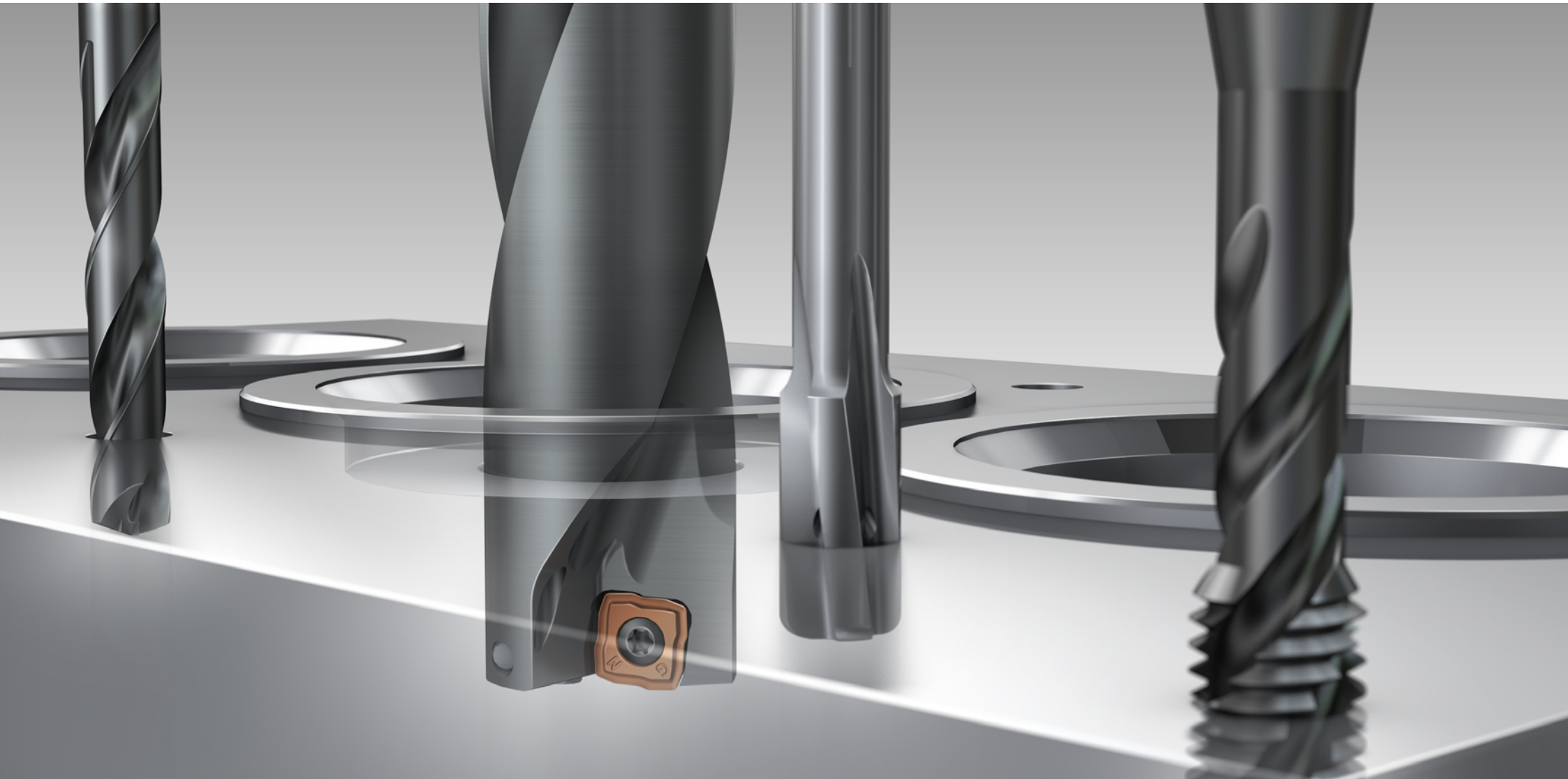

Meeting the industry needs of today with the solutions of tomorrow

We strive daily to help our customers improve manufacturing processes. Our carefully developed and unique tooling solutions help us meet today's industry needs. High-technology substrate materials, advanced cutting-edge and flute designs are among the features that will lead Sandvik Coromant toward new frontiers. Advances in research and development combined with new manufacturing processes have enabled us to surround ourselves with technology that was recently considered science fiction. Our unique design of inserts, drills, taps and reamers empower us to maximize productivity while confidently meeting holemaking demands of today and tomorrow.

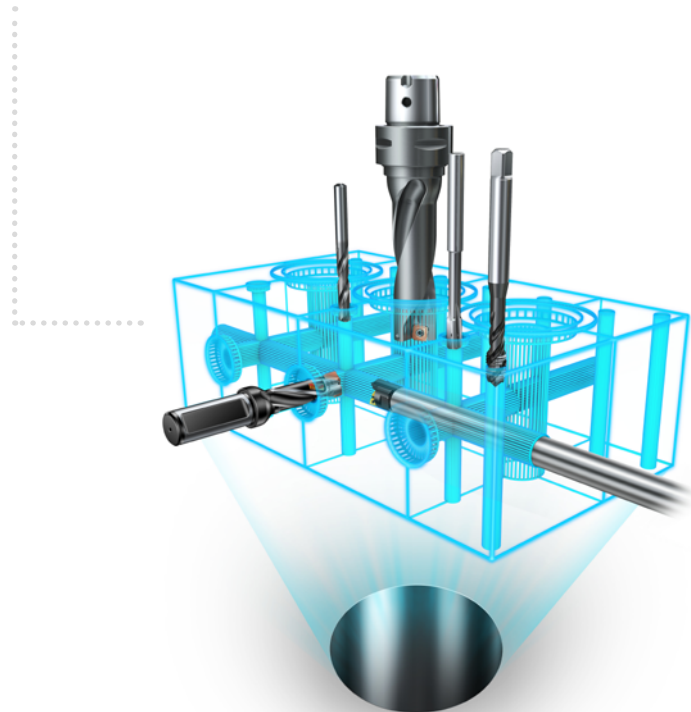

Solid carbide drills

CoroDrill® 460

Multi-material and flexible drill, X-line

High-performance drill that can be used across a wide range of materials. It provides high capacity utilization and flexibility. With one drill for all materials, stock holding can be reduced and greater machining flexibility is offered leading to reduced set-up time. The drill comes in lengths 3–8xD. Available as standard in diameters 3–20 mm (0.118–0.787 inch). Extended assortment is available as Tailor Made.

- High productivity and consistent tool life
- Excellent hole quality
- Smooth and efficient chip evacuation thanks to outstanding coating and flute design
- Low tooling costs
- Can be reground up to three times, extending tool life even further

ISO application area:

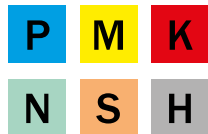

CoroDrill® 860

High-performance drill optimized for specific materials

Ensures fast, economical and problem-free drilling. Features drill geometries optimized for steel, stainless steel and aluminium. The drill comes in lengths 3–8xD. Available in diameters 3–20 mm (0.118–0.787 inch) for steel and aluminium. Diameter range for stainless steel is 3–16 mm (0.118–0.6299 inch). Extended assortment is available as Tailor Made.

- High penetration rates
- Long tool life, controlled wear formation
- Low cost per hole
- Improved performance reliability
- Optimized chip evacuation
- Excellent and consistent hole tolerance
- Dedicated geometries

ISO application area:

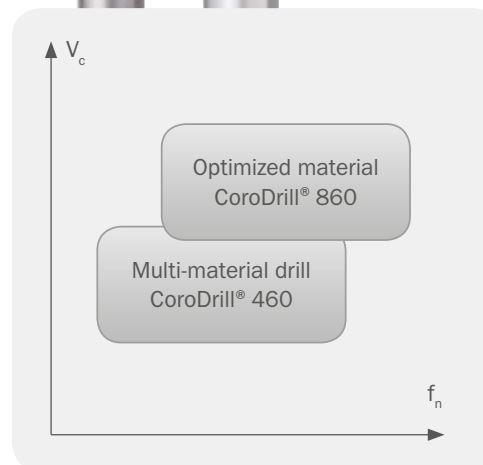

Interested in round tools?
Check out our dedicated
catalogue for more information



CoroDrill® 861

Solid carbide drill for hole depths 12–30×D

- Ensures high stability for drilling deep holes with speed and efficiency and without pecking
- Suitable for a range of materials
- Achievable hole tolerance: H9
- Flute geometry ensures small chips which are easily transported away from the cutting area

The pilot drill CoroDrill® 861 -GP is developed especially for CoroDrill® 861 -GM deep hole drill.

Pilot drill design:

- Length: 3×D
- Point angle of 150°

ISO application area:



CoroDrill® 862

Solid carbide micro-drilling concept

New micro-geometry drills offer outstanding performance for holes up to 2.95 mm (0.1161 inch) diameter. A thin, effective coating helps retain cutting edge geometry and provides a smooth surface finish for chip evacuation, while even wear formation prolongs tool life in a wide range of materials. Extended assortment is available as Tailor Made.

- High-performance micro drills with internal coolant
- Drilling depths 8–12×D

ISO application area:



CoroDrill® R846

Optimized drilling in heat resistant super alloys

- Unique drill geometry for optimized hole quality and process security
- Fine grain substrate and PVD coating for long tool life
- High edge quality and sharpness for reduced thrust force in demanding materials

ISO application area:



Product offer for composite machining

Sandvik Coromant offers an extensive range of solutions and support from dedicated application specialists globally for the machining of composite materials. Visit our website www.sandvik.coromant.com/composite or contact your local Sandvik Coromant representative for more information.

Exchangeable-tip drills

CoroDrill® 870

Exchangeable-tip drill for reliable holemaking and high productivity

This drill features a revolutionary design where the tip, interface and drill are optimized for improved machining economy. New cutting edge geometries and grades provide a safe cutting process with excellent chip control, high penetration rates and long dependable tool life.

- Easy and secure tip changing while the tool is in the machine for reduced down-time
- Hole diameter range: 10.00–33.00 mm (0.394–1.299 inch)
- Hole depths up to 10xD
- Hole tolerance: H9–H10
- Geometries and grades optimized for steel, cast iron and stainless steel
- Can be tailored to specific applications, such as chamfer drills for producing chamfered holes in one operation

ISO application area:

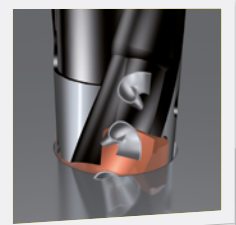

Indexable drills

CoroDrill® 880

Highly productive indexable-insert drill

Designed with a strong drill body with centre- and periphery-insert, this drill features unique Step Technology™ for perfect cutting force balance and Wiper geometry for best surface finish. CoroDrill® 880 gives high performance in most workpiece materials.

- Easy and stable, gradual cutting process when starting to drill
- Four true cutting edges due to Step Technology™
- Drill diameter: 12–63 mm (0.500–2.500 inch)
- Length: 2, 3, 4, or 5xD as standard
- Tool holding: either with cylindrical shank or directly with Coromant Capto® as standard
- More coupling types are available as Tailor Made
- Step and chamfer possibilities are available as Tailor Made

ISO application area:

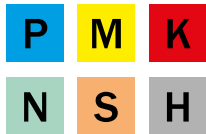

CoroDrill® 881

Secure drilling for smaller diameters

This complementary drill is optimized for unstable conditions, providing increased process security and stability for smaller hole diameters and in non-rotating applications.

- Reliable alternative for applications up to 25.99 mm (1.023 inch)
- Standard diameter range: 14–23.5 mm (0.562–0.937 inch)
- Proven drilling concept with strong and robust inserts

ISO application area:

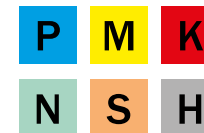



CoroDrill® 880 from diameter 65 mm (2.559 inch) with cartridge design

- For large and powerful machines
- No pre-drilled hole required
- Adjustable diameter: one drill body covers five different dimensions (e.g. 80, 81, 82, 83 and 84 mm)
- Diameter range: 65–129 mm (2.559–5.079 inch)
- Drill lengths up to 4×DC

ISO application area:

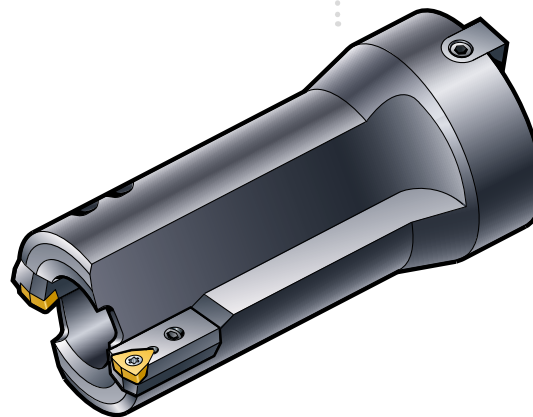
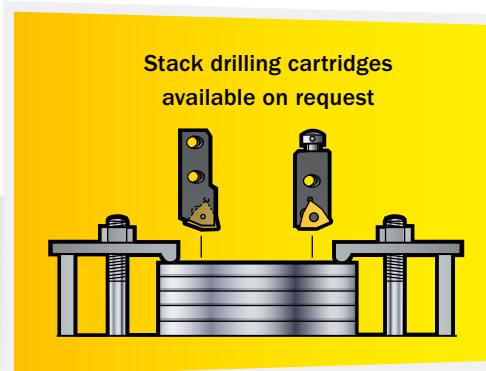

T-Max® U Trepanning tool

- Proven drilling concept for core drilling with Varilock coupling
- Diameter range: 60–110 mm (2.362–4.330 inch)
 - other diameters available upon request
- Drill depth: 2.5×D
- Good solution for large diameter drilling in less powerful machines

ISO application area:

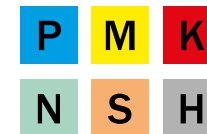



Tapping

Complete tapping programme

With a complete tapping programme covering all thread profiles and material groups, Sandvik Coromant offers two tapping ranges: one optimized for ISO-specific materials and one optimized for flexibility.

CoroTap™ – optimized for ISO-specific materials

- High productivity and long tool life
- Low machine downtime
- Highly efficient machining process
- Increased productivity through higher cutting speeds
- Optimum performance through material-specific designs and coatings

CoroTap™ – optimized for flexibility, X-line

- Suitable for a wide range of materials
- Reduces tool inventory and minimizes costs
- Provides long consistent tool life
- Offers a stable machining process due to unique cutting geometry
- Increased productivity through high machine utilization



Have you seen our thread milling solutions?

A detailed description of our solid carbide thread milling cutters and our thread milling concepts can be found on www.sandvik.coromant.com

CoroChuck™ 970

High-precision tapping chucks for synchronized tapping enable optimum results when tapping threads.

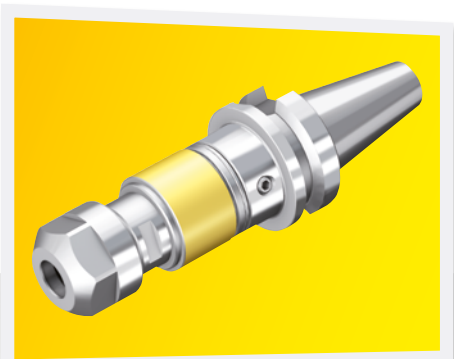

CoroTap™ 100

- Taps with straight flutes
- Mainly used for short chipping materials like cast iron
- Suitable for both through and blind holes
- Chip evacuation with internal coolant supply possible



CoroTap™ 200

- Taps with spiral point grinding
- Chips are pushed forward
- Used for through holes
- Strongest design due to shallow flutes
- Flute only used for cutting fluid, not for chip evacuation



CoroTap™ 300

- Taps with spiral flute grinding
- Spiral flute enables chip transportation
- Best option for blind holes
- Different helix angles for a wide range of applications



CoroTap™ 400

- Threads are formed rather than cut
- A chip-free solution
- Not suitable for all materials due to ductility constraints
- Recommended maximum tensile strength limit is 1200 N/mm²
- For both through and blind holes
- Available with and without oil grooves



Interested in round tools?
Check out our dedicated catalogue for more information



Reaming

CoroReamer™ 830

Modular design tool with replaceable cutting head

- High feed precision tool
- Achievable hole tolerance: H7
- Boring range: 10.00–31.75 mm (0.394–1.250 inch)
- Standard version for through holes

Other versions are available as engineered solution.

ISO application area:

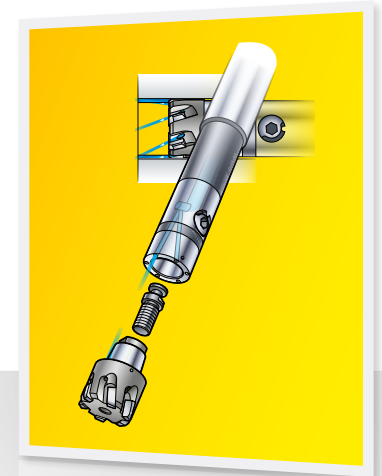

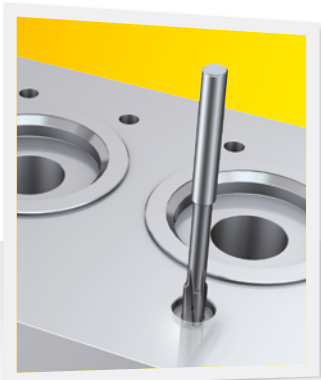

CoroReamer™ – solid carbide reamers

CoroReamer offers enhanced hole quality due to internal coolant, special cutting edge geometry and unequal spacing of cutting edges.

Features:

- Diameter range: 3.97–20.00 mm (0.156–0.787 inch)
- Internal coolant supply
- DIN 6535 HA shank for H6 tolerance
- For H7 hole tolerances

Versions:

- Spiral flutes for through holes – internal coolant supply with axial exit to the cutting edge
- Straight flutes for blind holes – with internal coolant supply

Other options available through Tailor Made and engineered solutions.

CoroReamer™ 435

A versatile and high performance reamer, suitable for a wide range of materials.

- Universal reamer designed for maximum flexibility, suitable for a wide range of applications and materials.

CoroReamer™ 835

Material-specific reamer for maximum performance

- High-performance reamer, optimized for maximum performance in specific materials.

ISO application area:





Boring

CoroBore® - the modular boring system

- Flexible solutions linking to any machine interface
- Reduce inventory and tool investment cost
- Length can be optimized through extension and reduction adaptors
- Precision and stability allow higher cutting data
- Available with Coromant Capto® and Coromant EH adaptors

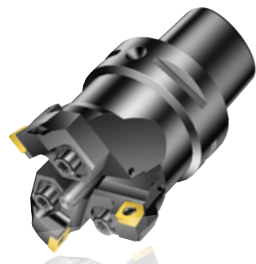

CoroBore® 820

For stable conditions when optimizing productivity with internal coolant to the cutting edge.

Roughing

- Diameter range: 35–306 mm (1.378–12.047 inch)
- Flexible boring concept for solutions with one to three cutting edges



CoroBore® 824XS/825EH, 391.37A/B

Achieves required overhang even at very small diameters

Finishing

- Diameter range: 1–19mm (0.04–0.75 inch)
- Available with Coromant Capto® and Coromant EH – the exchangeable head system
- CoroTurn® XS inserts or indexable inserts from 6 mm (0.236 inch)

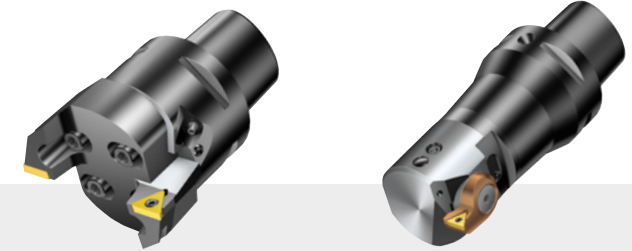

DuoBore™ 821/821D CoroBore® 825/825D

Features rough- and fine boring tools for various materials, applications and conditions with internal coolant to the cutting edge. For vibration-free machining at long overhangs there are dampened solutions available: DuoBore™ 821D and CoroBore® 825D.

Roughing

- Diameter range: 25–150 mm (1–5.9 inch)

Finishing

- Diameter range: 19–167 mm (0.75–6.58 inch)
- Diameter adjustment by nonius scale 0.002 mm (0.00008 inch)

●●●● SilentTools®



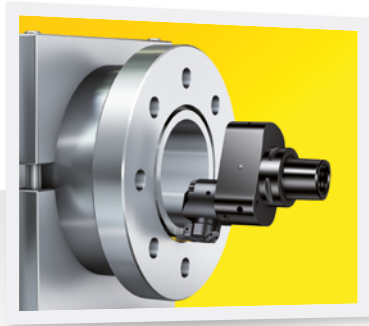

CoroBore® face grooving

CoroBore® SL can be used together with CoroCut® blades for axial face grooving applications in diameters 47–1275 mm (1.85–50.2 inch)



CoroBore® Lightweight

- Reduces tool assembly weight and tool-change time
- Makes tool handling and tool exchange easier and more secure
- Bores large diameters with increased stability without increasing the tool weight
- Features optimized solutions for horizontal boring machines and machining centres
- Available in diameters 69–315 mm (2.72–12.4 inch)



CoroBore® XL

- Roughing, finishing and face grooving for large diameters from 150–1275 mm (5.906–50.197 inch)
- Weight-reduced bridges made of high-strength, coated aluminium for diameters from 298–1275 mm (11.732–50.197 inch)
- Available as conventional, dampened or lightweight tools
- Choose between CoroBore® 825 or CoroBore® 826 fine boring head
- Internal coolant supply to the cutting edge
- Use CoroDrill® 880 inserts when roughing up to 15 mm radial depth of cut

CoroBore® 825 fine boring head

- Diameter adjustment with a nonius scale for precision 0.002 mm (0.00008 inch)

CoroBore® 826 fine boring head

- Each increment adjusts the diameter by 0.002 mm (0.00008 inch), felt by a click. This enables convenient adjustment for precision finishing.

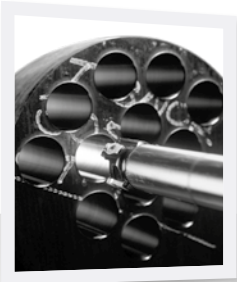

Deep hole machining

CoroDrill® 808

- First choice for the energy segment, more precisely for condensing power when drilling heat exchanger plates
- CoroDrill® 808 can also be used for drilling within primary metals, such as billet drilling for tube extrusion



Launch soon!

CoroDrill® 800

Superior productivity performance

- Wide range of stocked articles gives low downtime in production thanks to overnight overnight delivery
- Diameter range: 25–65 mm (0.984–2.559 inch)
- High process security
- Low cost per hole
- Consistent performance within a wide application area
- Excellent surface finish



CoroDrill® 801

Secure process in difficult to chip materials

- Diameter range: 65.0–165.1 mm (2.560–6.500 inch) as stocked standard. Larger diameters available as engineered solution
- High machine utilization
- Improved flexibility due to larger radial adjustability
- Superior performance within a wide application area



CoroDrill® 818

Counterboring concept

- Diameter range: 40.0–301.75 mm (1.575–11.880 inch) as stocked standard. Larger diameters available as engineered solution
- Easy to apply
- Improved flexibility due to larger radial adjustability
- Suitable for complex applications, e.g. oil exploration tools within the oil- and gas industry as well as aerospace and primary metals



Looking for more solutions?

Check-out our dedicated pages for deep hole machining on our website.



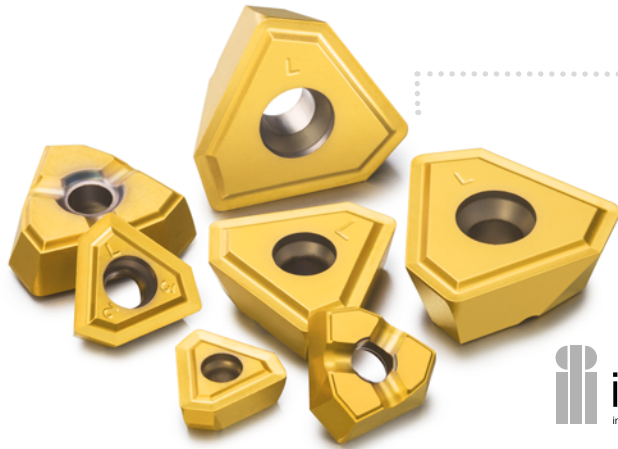

TPGX inserts

TPGX inserts feature four different grades, profiles and sizes. These versatile inserts with iLock technology are designed for a secure insert positioning.

- G- and L-geometry options
- Right- and left hand style

Application areas:

- Oil and gas
- Aerospace
- Mechanical engineering
- Primary metals

Gun drills - Easy to use. Require no pre-setting.

CoroDrill® 428.2

Twin-lip gun drill

- Hole diameter 6–26.50 mm (0.236 – 1.043 inch)
- Hole depth $\leq 100 \times D$
- Hole tolerance IT10
- Higher feed in short chipping materials

CoroDrill® 428.5

Solid carbide single-lip gun drill

- Diameter range 0.8–12 mm (0.031–0.472 inch)
- Hole ≤ 300 mm
- Hole tolerance IT8
- Gives good drilling stability in medium to large batch sizes

CoroDrill® 428.7

High feed gun drill

- Diameter range 3–12 mm (0.118–0.472 inch)
- Hole ≤ 300 mm
- Hole tolerance IT8
- Highest productivity thanks to superior chip control

CoroDrill® 428.9

Single-lip gun drill - basic choice for drilling in all materials

- Diameter range 1.90–40.50 mm (0.075–1.594 inch)
- Hole depth $\leq 100 \times D$
- Hole tolerance IT9
- Our general choice for all materials

CoroDrill® A428.91

Brazed carbide single-lip gun drill

- Stock standard inch programme
- Diameter range 0.078–1.000 inch
- Hole tolerance IT9
- PVD TiAlN coating
- Optimized dimensions for the automotive industry

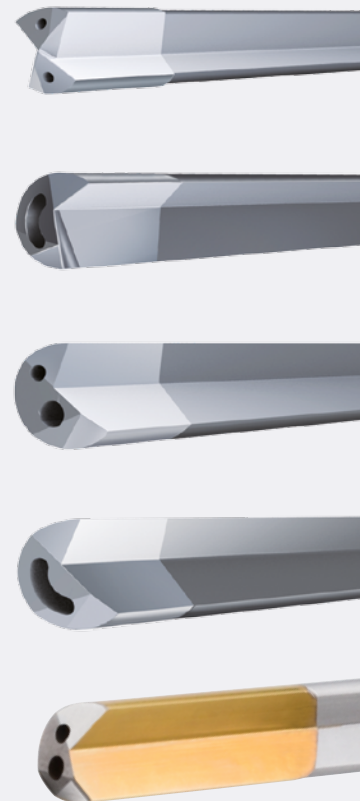

Reconditioning service

Sandvik Coromant offers a comprehensive reconditioning service for nearly all of the solid carbide drill assortment.

Reconditioning maintains the exact geometry and coating of the original tool. Tool reconditioning is a reasonably priced alternative to buying new tools while still maintaining the same performance. To this end, by the time a tool is reconditioned for the third time, tool costs are reduced by 50 percent.

The reconditioning service is available for the following drills:
CoroDrill® 460, CoroDrill® 860, CoroDrill® 861, CoroDrill® R840,
CoroDrill® R841, CoroDrill® R842, CoroDrill® R846 and
CoroDrill® R850.

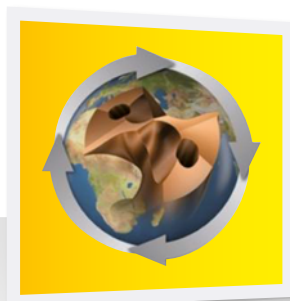

Customized solutions

Tailor Made – Your fast-track route to a customized tool.

Our Tailor Made options cover all major product groups, giving you the freedom to specify your own dimensions without having to pay the price of a special tool.

- Quick quotes
- Easy ordering
- Competitive delivery times

Engineered solutions

In the competitive world of manufacturing, the demands for shorter lead times and increasingly complex product shapes present us with the challenge of offering productive customised solutions.

Because we are able to supply such customized solutions, our customers can now reduce cycle times and increase workpiece quality. Through prompt investment in machinery, our individual tool solutions contribute to rapid profitability.

Sandvik Coromant is continuously developing its products and services further, in order to meet growing customer demands in the metal machining industry on a global level.



Notes

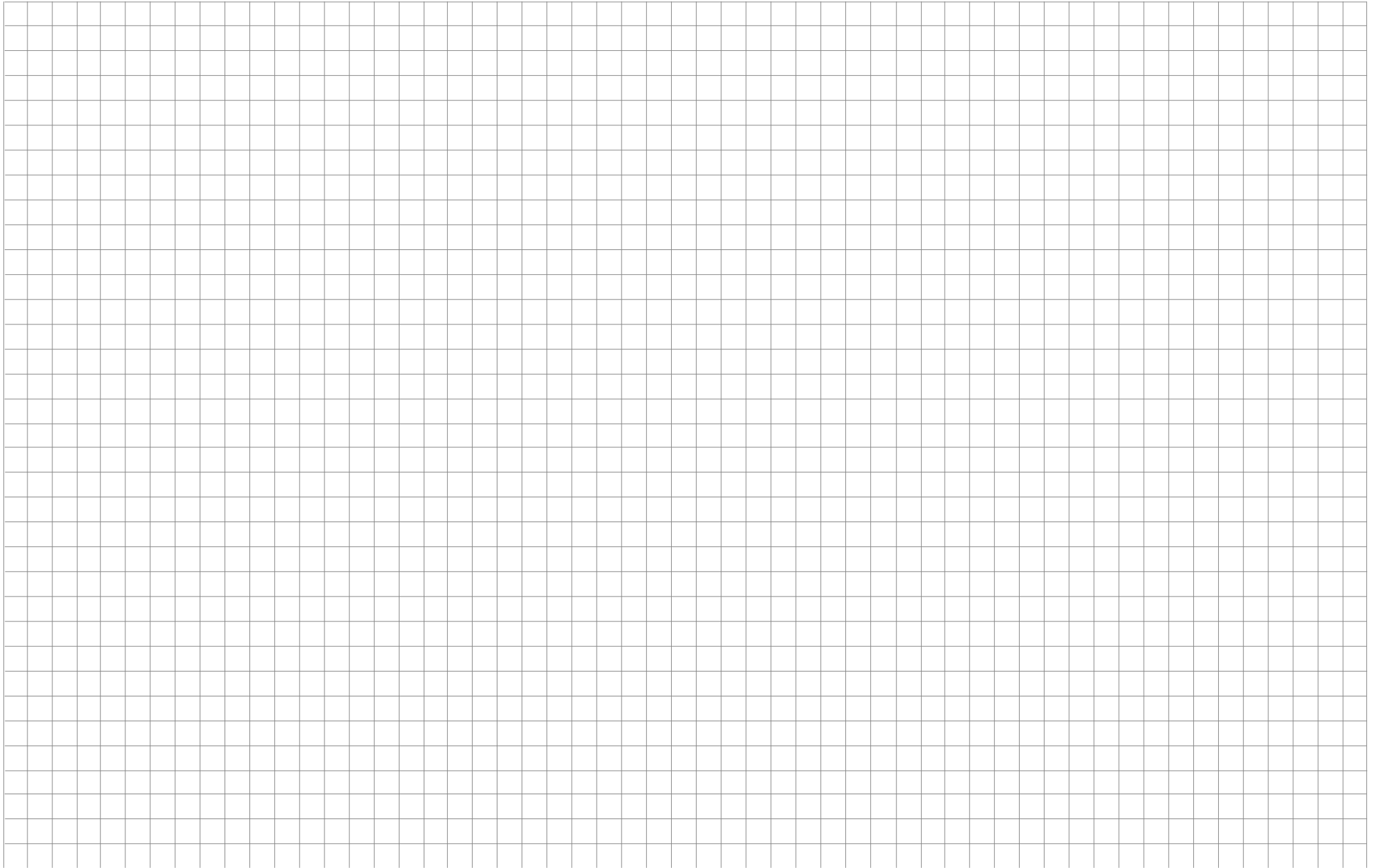



Local support is just a click away

www.sandvik.coromant.com

Head office:
AB Sandvik Coromant
SE-811 81 Sandviken, Sweden
www.sandvik.coromant.com
E-mail: info.coromant@sandvik.com

C-2940:154 ENG/01 © AB Sandvik Coromant 2014

SANDVIK
Coromant