

SHARP

RADIAL DRILLS

RD-820 OPERATION MANUAL



Section	Content	page
CHAPTER 1	Safety Guidelines	1-1
1.1	Please follow the below basic safety principles.....	1-1
1.2	Precautions for the transportation and installation.....	1-1
1.3	Precautions for operation.....	1-2
1.4	Precautions for checking and maintenance.....	1-2
1.5	Warning labels and mark on the machine.....	1-3
1.5.1	Warning labels and mark introduction	1-3
1.5.2	Labels Warning labels and mark positions	1-4
CHAPTER 2	General specifications	2-1
2.1	The anticipated machine life.....	2-1
2.2	Machine dimensions.....	2-1
2.3	The machine.....	2-2
2.3.1	Description.....	2-2
2.3.2	Parts.....	2-2
	I For TPR-720A, TPR-820A, TPR-920A	2-2
	II only for TPR-1100.....	2-3
2.4	Specifications	2-4
2.4.1	TPR-720A	2-4
2.4.2	TPR-820A Specification	2-5
2.4.3	TPR-920A specification	2-6
2.4.4	TPR-1100 specification	2-7
2.5	Standard and Option Accessories.....	2-8
2.6	Operation position and noise level.....	2-8
2.6.1	Operation position.....	2-8
2.6.2	The noise level.....	2-8
CHAPTER 3	Preparation to install	3-1
3.1	Space and room requirement.....	3-1
3.1.1	Floor requirement.....	3-1
3.1.2	Space requirement.....	3-2
3.2	Environment requirement.....	3-3
3.3	Power supply requirement.....	3-3
3.4	Electric system calculation.....	3-4
CHAPTER 4	Transportation and Installation	4-1
4.1	Disassembly and packaging.....	4-1
4.1.1	General.....	4-1
4.1.2	Packaging.....	4-1

Section	Content	page
4.2	Transportation.....	4-2
4.2.1	The diagram of the machine weight and its gravity center.....	4-2
4.2.2	The movement of the machine.....	4-2
4.2.3	The order to pack.....	4-3
4.3	Installation of the machine.....	4-4
4.3.1	Have the machine set onto the fastening bolts of the crate base.....	4-4
4.3.2	Level adjusting.....	4-5
4.3.3	The installation of the electricity.....	4-5
4.4	The test after installation.....	4-6
4.5	The procedure for dismantling the machine.....	4-6
CHAPTER 5	Operation.....	5-1
5.1	A brief introduction to the relevant operation hardware.....	5-1
5.1.1	(For TPR-720A, TPR-820A, TPR-920A).....	5-1
5.1.2	(For TPR-1100).....	5-4
5.1.3	Safty protective device.....	5-7
5.2	Instruction to switches.....	5-8
	I (For TPR-720A, TPR-820A, TPR-920A).....	5-8
	II (For TPR-1100).....	5-11
5.3	Installation of the clamp (work piece.....	5-12
5.3.1	General.....	5-12
5.3.2	Introduction of the vise and the clamping of the work piece.....	5-12
5.3.3	Universal clamp and the clamping of the work piece.....	5-13
5.4	Installation and change of the drilling bit.....	5-15
5.4.1	The assembly and disassembly of the drilling head and clamp.....	5-16
5.4.2	The assembly and disassembly of the straight handle drill bit.....	5-18
5.5	Power on and off.....	5-19
5.5.1	Power on.....	5-19
5.5.2	Power off.....	5-19
5.6	Work light.....	5-19
5.7	Cutting fluids.....	5-19
5.8	Elevating the arm.....	5-20
5.9	Rotate the arm right or leftwards.....	5-21
5.10	Rotate the arm to or backwards.....	5-22
5.11	Change the spindle speed.....	5-23
5.11.1	For TPR-720A, TPR-820A, TPR-920A.....	5-23
	I Speedometer.....	5-23
	II Change spindle speed.....	5-24
5.11.2	For TPR-1100.....	5-25
	I The speedometer at the time when the pole switch is in high position....	5-25
	II Change spindle speed.....	5-26
	III The speedometer at the time when the pole switch is in low position....	5-27

Section	Content	page
5.12	Automatic Feed.....	5-28
5.12.1	Automatic feed rate table.....	5-28
5.12.2	Change the feed rate as the following way.....	5-28
5.12.3	Suppose that the work piece is by the machine.....	5-28
5.12.4	How to preset the depth of the power-feed.....	5-29
	I (For TPR-720A, TPR-820A, TPR-920A).....	5-29
	II (For TPR-1100).....	5-30
5.13	The spindle.....	5-31
5.14	Threading.....	5-31
5.15	The assembly and disassembly of the work table.....	5-32
5.16	Cutting fluids for all kinds of material.....	5-32
CHAPTER 6	Adjustment.....	6-1
6.1	General.....	6-1
6.2	The arm clamping lever.....	6-1
6.3	The gap adjustment between the gearbox and the arm rail.....	6-2
6.3.1	(For TPR-720A, TPR-820A, TPR920A).....	6-2
6.3.2	(For TPR-1100).....	6-3
6.4	Adjust the engagement between the feed trip lever and the clutch.....	6-4
CHAPTER 7	Maintenance.....	7-1
7.1	General.....	7-1
7.2	Daily Maintenance.....	7-1
7.2.1	Clearing.....	7-1
7.2.2	Please clean every parts using a metal brush and a rag, dipped with oil, to rub them	7-1
7.2.3	The way to clean iron filings.....	7-2
7.2.4	Lubrication.....	7-3
7.2.5	Change oil inside of the speed reduction of the arm elevating motor.....	7-4
7.2.6	Chang the oil inside the gearbox.....	7-5
7.3	Replace the cutting fluids.....	7-6
7.4	Maintenance and replacement period.....	7-7
7.5	Waste disposition.....	7-7
CHAPTER 8	Troubleshooting.....	8-1
8.1	The spindle overloads and the relay jumps.....	8-1
8.1.1	The cause.....	8-1
8.1.2	The solution.....	8-1
8.2	The spindle overloads and the fuse burns out.....	8-1

Section	Content	page
8.2.1	The cause.....	8-1
8.2.2	The solution.....	8-1
8.3	What if the drill bit get broken ?	8-2
8.4	What if the screw tap get broken?.....	8-2
8.5	How if a person is entangled?.....	8-2

CHAPTER 9 Annex

9.1	Electrical circuit diagram(TPR720A,TPR820A,TPR920A CE Standard).....	9-1
9.2	Electrical circuit diagram(TPR1100 CE Standard).....	9-2
9.3	Electrical main part list(TPR720A,TPR820A,TPR920A CE Standard)...	9-3
9.4	Electrical main part list (TPR1100 CE Standard).....	9-5
9.5	Earth System Diagram(TPR720A,TPR820A,TPR920A ,TPR1100 CE Standard)	9-6
9.6	Electrical circuit diagram(TPR720A,TPR820A,TPR920A Standard 24V)	9-7
9.7	Electrical circuit diagram(TPR720A,TPR820A,TPR920A Standard 110V)	9-8
9.8	Electrical main part list (TPR720A,TPR820A,TPR920A Standard).....	9-9
9.9	Electrical circuit diagram(TPR1100 Standard 24V).....	9-11
9.10	Electrical circuit diagram(TPR1100 Standard 110V).....	9-12
9.11	Electrical main part list (TPR1100 Standard).....	9-13

CHAPTR 1

Safety Guidelines

1.1 Please follow the below basic safety principles :

- (1) Have only sophisticated or experienced personal perform the machine operation or maintenance.**
- (2) Please read and understand the operation manual thoroughly before operation.**
- (3) Please place the manual close to the machine for easy access.**
- (4) Please have only authorized person keep the keys to the machine.**
- (5) All operation and maintenance personnel need to know the location of the emergency switch, its function and operation.**

1.2 Precautions for the transportation and installation.

- (1) Please make sure that the floor is solid enough to support the machine.**
- (2) Only one person is allowed to lift and move the machine for safety reason.**
- (3) When lifting and moving, Nobody is allowed to be under or near the machine.**
- (4) Please wear protective helmet when moving, installing or clearing the machine.**
- (5) All levers, which tighten, need to be tightened.**
- (6) If the moving object weighs over 25kgs, Please use only proper movement equipment for it.**
- (7) Please make sure that the slings are strong enough to lift the machine or the subjects.**
- (8) Please power off before movement and installation. If necessary to power on, please let other persons know the location of the emergent stop.**
- (9) Please put on leather gloves or similar protective equipments when moving, installing or clearing the machine.**

1.3 Precautions for operation:







- (1) Please don't remove any protection guard or any safety installation.**
- (2) Please don't remove or alter any location of the limit switches, restraint blocks or interlocking mechanisms.**
- (3) Don't touch any switch with wet hand.**
- (4) Please don't put any part of your body on the moving parts of the machine or near to them.**
- (5) The operation person have better no long hair, if it is impossible, please have it coiled in a topknot and wear a safety helmet.**
- (6) Please wear no hand ring, watch, pearls or loose clothes. Operation should wear a safety clothes.**
- (7) Please wear no slippery shoes while operating.**
- (8) Wearing gloves is needed when loading and unloading material.**
- (9) Only one person is allowed to operate the machine.**
- (10) While operation, Debris may fly off. So please wear a protective mask to prevent from being injured.**
- (11) Please power off after work.**
- (12) Please wear a gauze mask if you are working, using cutting fluids.**
- (13) Please don't use the machine in a explosive environment.**
- (14) A risk of being squeezed is composed when the gearbox and the arm are descending or the spindle is descending to the worktable. (The arm screw moves at a low speed of 0.8 m/min.)**
- (15) Operator should stand in front of the machine. That's the operation position.**

1.4 Precautions for checking and maintenance.

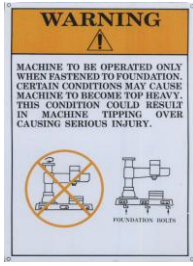
- (1) Please power off first before performing maintenance or checking job.**
- (2) Only have authorized electric technician carry out maintenance or checking job when Power-on is needed in it**
- (3) Please power off after work.**
- (4) Adding or replacing hydraulic oil or lubricant, Please use Tailift recommended oil type or its equivalent. For details, please refer to the chapter 7.**
- (5) Basically, only one person is needed to serve. If more than one person is called for, Good communications is required.**
- (6) Please power off first before getting rid of the iron filings or cleaning the machine.**

1.5 Warning labels and mark on the machine

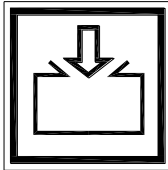
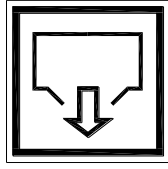
1.5.1 Warning labels and mark introduction

labels	Description
	<p>Please secure the machine with the base fixing bolts, to prevent from any risk.</p>
	<p>Model of a machine.</p>
	<p>Please watch out the running tools.</p>
	<p>Please operators wear a protective glasses during work.</p>
	<p>CE Mark (option)</p>
	<p>Oil filler position.</p>
	<p>Oil drain outlet position.</p>
	<p>Risk of high voltage.</p>

1.5.2 Warning Labels and mark positions

a. The front view.



b-1. The rear view (For TPR-720A, TPR-820A, TPR-920A)

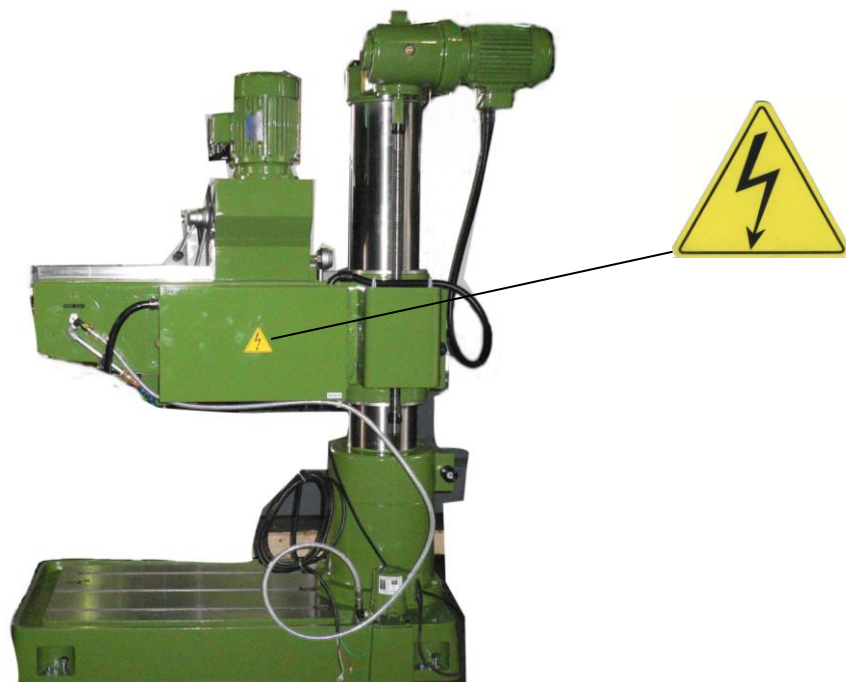

b-2. The rear view (only for TPR-1100)

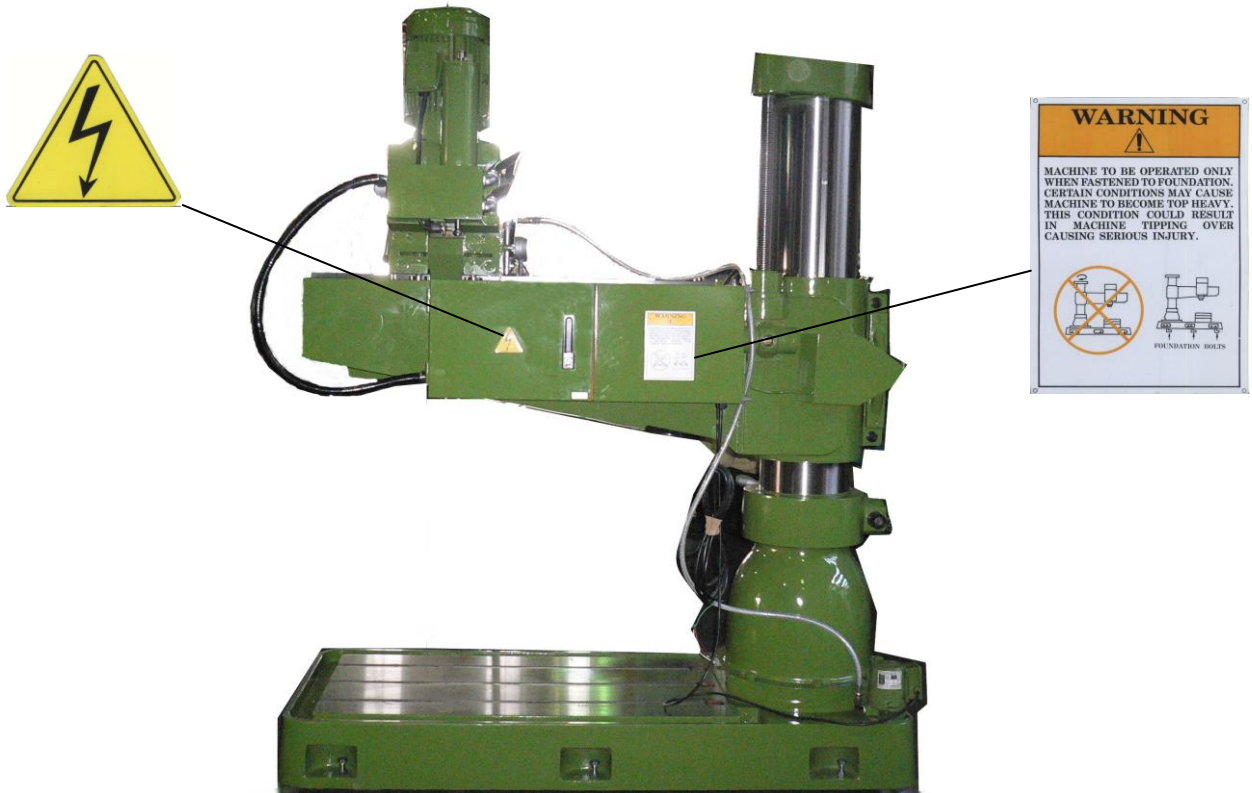

C. Oil filler position and Oil Drain outlet position

- Gearbox



- Arm elevating motor (For TPR-720A, TPR-820A, TPR-920A)



- Arm elevating motor (For TPR-1100)

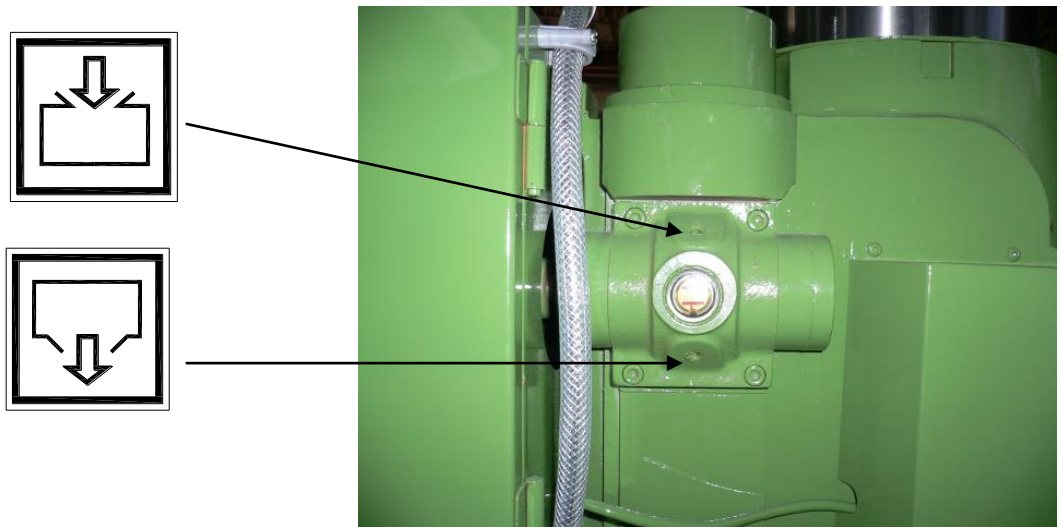

CHAPTER 2

General Specifications

2.1 The anticipated machine life.

The calculation of the anticipated machine life:

8 hours x 6 days x 50 weeks x 10 years = 24000 hours.

The above calculation is based on a sound maintenance and normal condition, excluding wearing parts.

2.2 Machine dimensions.

The following are the machines' dimensions and its diagrams.

Models	A	B	C
TPR-720A	1250mm	640mm	2170mm
TPR-820A	1250mm	640mm	2320mm
TPR-920A	1250mm	640mm	2320mm
TPR-1100	1710mm	715mm	2530mm

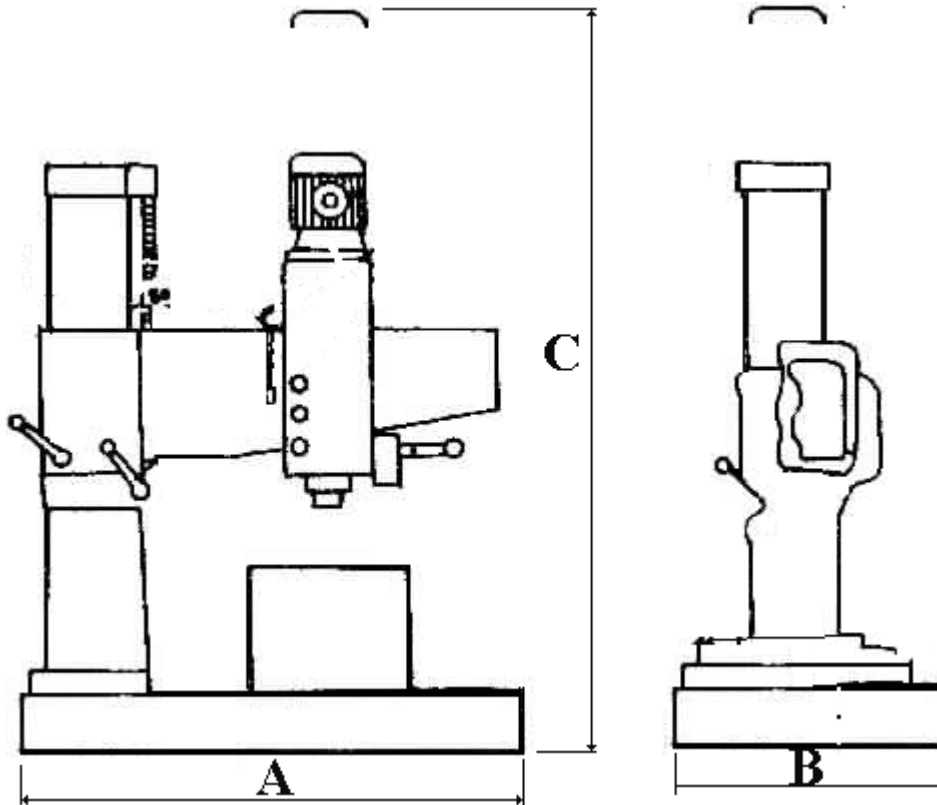

2.3 The machine

2.3.1 Description

Radial drills are purposely designed to process bulky objects. Tailift has 20 years of history and experience in behind. It knows radial drills certainly very well.

Tailift radial drills will be your best choice. The material that the machine can process on are : mild steel, metal, stainless steel, cast iron, aluminum, copper,,,, etc, except magnesium alloy. (Note 1)

Note 1: Processing magnesium alloy may cause fire.

2.3.2 Parts

I . For TPR-720A, TPR-820A, TPR-920A

There are six categories of parts on the radial drill: Gearbox, Arm, Column, Top Cover, Box Table and Base. The following are its description and locations.

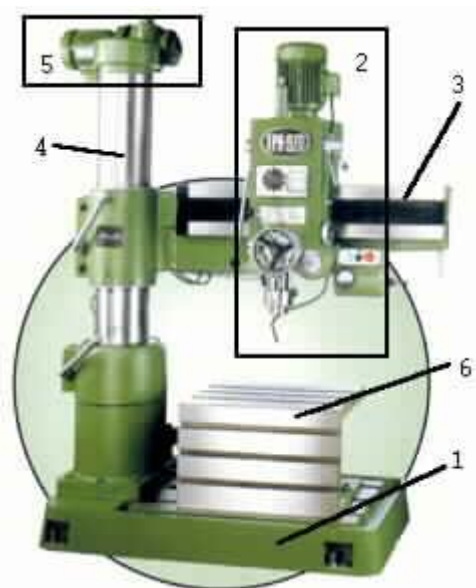

1. Base The main aim of the base is to support the whole weight of the machine. In addition, the cutting fluid is contained here and the Box Table is installed on.
2. Gear box It is the core part for the radial drill for all procession is finished here, like speed switch, auto feed, spindle,,, etc. They are inside of the gearbox.
3. Arm It is to support the gearbox and is connected with the column.
4. Column It is to support the gearbox and the arm. It connects the base.
5. Top Cover It is on the top of the machine, where there is a motor. The motor is to run the gearbox, rise and lower the arm.
6. Box table Working with clamps, it enables to reach the required accuracy.

II . only for TPR-1100

There are six categories of parts on the radial drill: Gearbox, Arm, Column, Top Cover, Box Table and Base. The following are its description and locations.

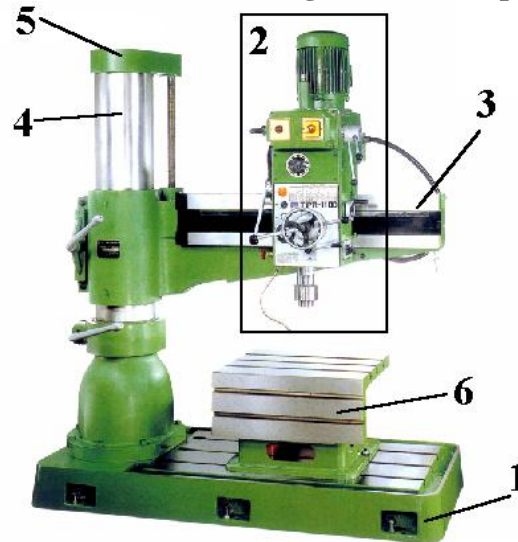

1. **Base** **The main aim of the base is to support the whole weight of the machine. In addition, the cutting fluid is contained here and the Box Table is installed on.**
2. **Gear box** **It is the core part for the radial drill for all procession is finished here, like speed switch, auto feed, spindle,, etc. They are inside of the gearbox.**
3. **Arm** **It is to support the gearbox and is connected with the column.**
4. **Column** **It is to support the gearbox and the arm. It connects the base.**
5. **Top Cover** **It is at the top end of the Column.**
6. **Box table** **Working with clamps, it enables to reach the required accuracy.**
7. **The ball screw transmission motor** **The motor is to elevate the gearbox.**

2.4 Specifications.

2.4.1 TPR-720A Specification.

TPR-720A	
The Column diameter	210mm
Distance from the column surface to the spindle center, max	750mm
Distance from the column surface to the spindle center, min	220mm
Horizontal travel of the Spindle head.	530mm
Distance from the Base surface to the Spindle end, max.	1060mm
Distance from the Base surface to the Spindle end, min.	260mm
Elevating height of the Arm.	580mm
Effective area of the Box Table.	600mm×445mm×380mm
The dimensions of the Base (L × W × H)	1250mm×640mm×160mm
Taper hole of the Spindle.	MT#4
Stroke of the Spindle.	220mm
R.P.M. of the Spindle. (rounds / min. × step)	88,154,282,455,796,1500six steps
Feed rate of the Spindle (MM / round × speed)	0.05,0.09,0.15 3 speeds.
Horse Power of the main motor.	1.5KW(2HP)
Horse Power of the elevating motor.	0.75KW(1HP)
Horse Power of the cooling pump motor.	0.1KW(1/8HP)
The machine height from floor, max.	2170mm
Height from the Column top to floor	1850mm
Net weight (approx.) kgs	1120kg
Shipping Gross weight. (approx.) kgs	1250kg
Shipping dimensions(L×W×H)	1625mm×810mm×2160mm

The max. processing capacity.

Drilling	Steel	Ø32
	Cast iron	Ø50
Tapping	Steel	Ø25
	Cast Iron	Ø32

2.4.2 TPR-820A Specification.

TPR-820A	
The Column diameter	210mm
Distance from the column surface to the spindle center, max	850mm
Distance from the column surface to the spindle center, min	220mm
Horizontal travel of the Spindle head.	630mm
Distance from the Base surface to the Spindle end, max.	1210mm
Distance from the Base surface to the Spindle end, min.	350mm
Elevating height of the Arm.	640mm
Effective area of the Box Table.	600mm×445mm×380mm
The dimensions of the Base (L × W × H)	1250mm×640mm×160mm
Taper hole of the Spindle.	MT#4
Stroke of the Spindle.	220mm
R.P.M. of the Spindle. (rounds / min. × step)	88,154,282,455,796,1500 6 steps
Feed rate of the Spindle (MM / round × speed)	0.05,0.09,0.15 3 speeds
Horse Power of the main motor.	1.5KW(2HP)
Horse Power of the elevating motor.	0.75KW(1HP)
Horse Power of the cooling pump motor.	0.1KW(1/8HP)
The machine height from floor, max.	2320mm
Height from the Column top to floor	2010mm
Net weight (approx.)kgs	1200 kg
Shipping Gross weight. (approx.)kgs	1340 kg
Shipping dimensions(L×W×H)	1680mm×810mm×2210mm

The max. processing capacity.

Drilling	Steel	Ø32
	Cast iron	Ø50
Tapping	Steel	Ø25
	Cast Iron	Ø32

2.4.3 TPR-920A specification.

TPR-920A	
The Column diameter	210mm
Distance from the Column surface to the Spindle center, max.	950mm
Distance from the Column surface to the Spindle center, min.	220mm
Horizontal travel of the Spindle head.	730mm
Distance from the Base surface to the Spindle end, max.	1210mm
Distance from the Base surface to the Spindle end, min.	350mm
Elevating height of the Arm.	640mm
Effective area of the Box Table.	600mm×445mm×380mm
The dimensions of the Base (L × W × H)	1250mm×640mm×160mm
Taper hole of the Spindle.	MT#4
Stroke of the Spindle.	220mm
R.P.M. of the Spindle. (rounds / min. × step)	88,154,282,455,796,1500 6 steps
Feed rate of the Spindle (MM / round × speed)	0.05,0.09,0.15 3 speeds
Horse Power of the main motor.	1.5KW(2HP)
Horse Power of the elevating motor.	0.75KW(1HP)
Horse Power of the cooling pump motor.	0.1KW(1/8HP)
The machine height from floor, max.	2320mm
Height from the Column top to floor	2010mm
Net weight (approx.) kgs	1250 kg
Shipping Gross weight. (approx.) kgs	1400 kg
Shipping dimensions(L×W×H)	1810mm×810mm×2210mm

The max. processing capacity.

Drilling	Steel	Ø32
	Cast iron	Ø50
Tapping	Steel	Ø25
	Cast Iron	Ø32

2.4.4 TPR-1100 specification.

TPR-1100	
The Column diameter	260mm
Distance from the Column surface to the Spindle center, max.	1100mm
Distance from the Column surface to the Spindle center, min.	280mm
Horizontal travel of the Spindle head.	820mm
Distance from the Base surface to the Spindle end, max.	1270mm
Distance from the Base surface to the Spindle end, min.	470mm
Elevating height of the Arm.	570mm
Effective area of the Box Table.	635mm×520mm×415mm
The dimensions of the Base (L × W × H)	1710mm×715mm×180mm
Taper hole of the Spindle.	MT#4
Stroke of the Spindle.	230mm
R.P.M. of the Spindle. (rounds / min. × step)	44-1500 12 steps
Feed rate of the Spindle (MM / round × speed)	0.05,0.09,0.153 3 speeds
Horse Power of the main motor.	2.25KW(3HP)
Horse Power of the elevating motor.	0.75KW(1HP)
Horse Power of the cooling pump motor.	0.1KW(1/8HP)
The machine height from floor, max.	2530mm
Height from the Column top to floor	2000mm
Net weight (approx.) kgs	1800 kg
Shipping Gross weight. (approx.) kgs	1950 kg
Shipping dimensions(L×W×H)	1880mm×870mm×2210mm

The max. processing capacity.

Drilling	Steel	Ø42
	Cast iron	Ø55
Tapping	Steel	Ø25
	Cast Iron	Ø38

2.5 Standard and Option Accessories.

(1) Standard Accessories:

- a. Adjusting tools (including tool box)
- b. Cooling equipment (including pump)
- c. Lighting installation (including fluorescent lamp)
- d. Box table

(2) Option Accessories:

- a. Tilt worktable

2.6 Operation position and noise level.

2.6. Operation position: about 1 meter far from the gearbox surface.

1

Height: 1.6 meter from the ground.

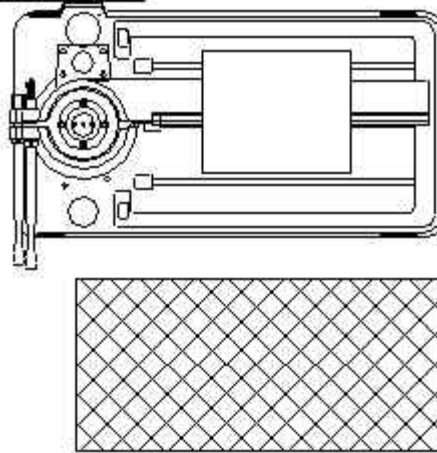

2.6.2 The noise level.

(1) Before being processed,

When the turning speed is 1500 rpm, the noise level is 73 dB(A).

When the turning speed is 88 rpm, the noise level is 70 dB(A).

(2) When processing with tools,

The test conditions are as follow:

Material : SS41

Thickness : 32mm

The tool diameter : \varnothing 32mm

When the turning speed is 88rpm and the feed rate is 0.09 mm, the noise level is 73 dB(A).

When the turning speed is 88rpm and the feed rate is 0.05 mm, the noise level is 71 dB(A).

CHAPTER 3

Preparation to Install

3.1 Space and room requirement

3.1.1 Floor requirement

Using this machine requires solid and well-structured floor and its good level.

Note:

1. For adjusting level, please refer to the chapter 6.
2. Adjusting level is needed before using this machine. The level adjusting tolerance must be within 1 mm/m.

a. For TPR-720A , TPR-820A ,TPR-920A floor diagrams. (Unit : mm)

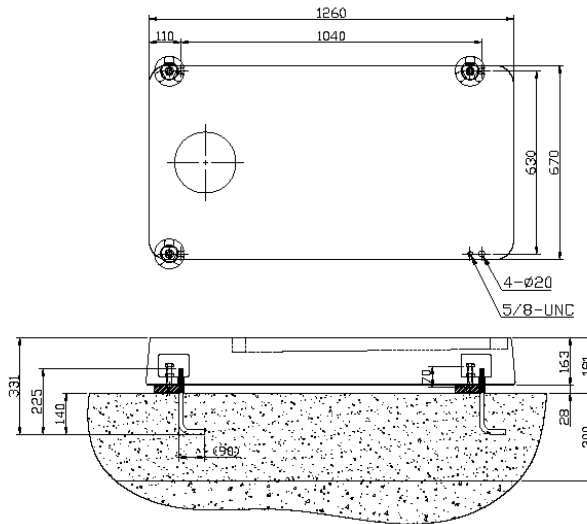

地基圖(The Ground Diagram)

The above diagrams are for the bases and ground bolts, as well as its relative positions of TPR-720A, TPR-820A and TPR-920A.

b. For TPR-1100 floor diagrams (Unit : mm)

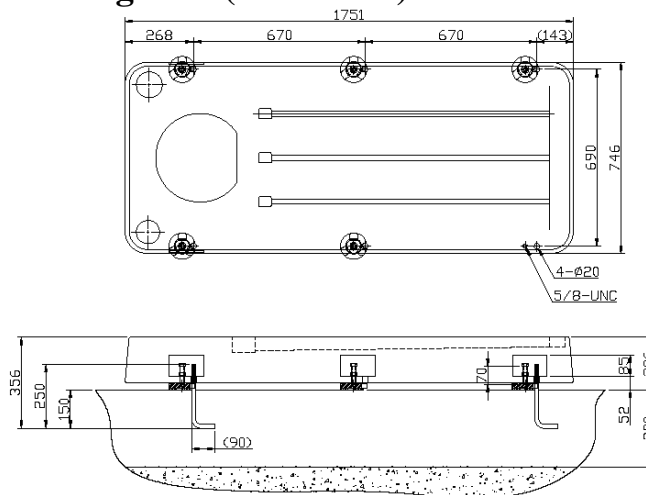

地基圖(The Ground Diagram)

The above diagrams are for the bases and ground bolts, as well as its relative positions of TPR-1100

3.1.2 Space requirement

For safety reason, Path must be considered when installing. For space, it requires:

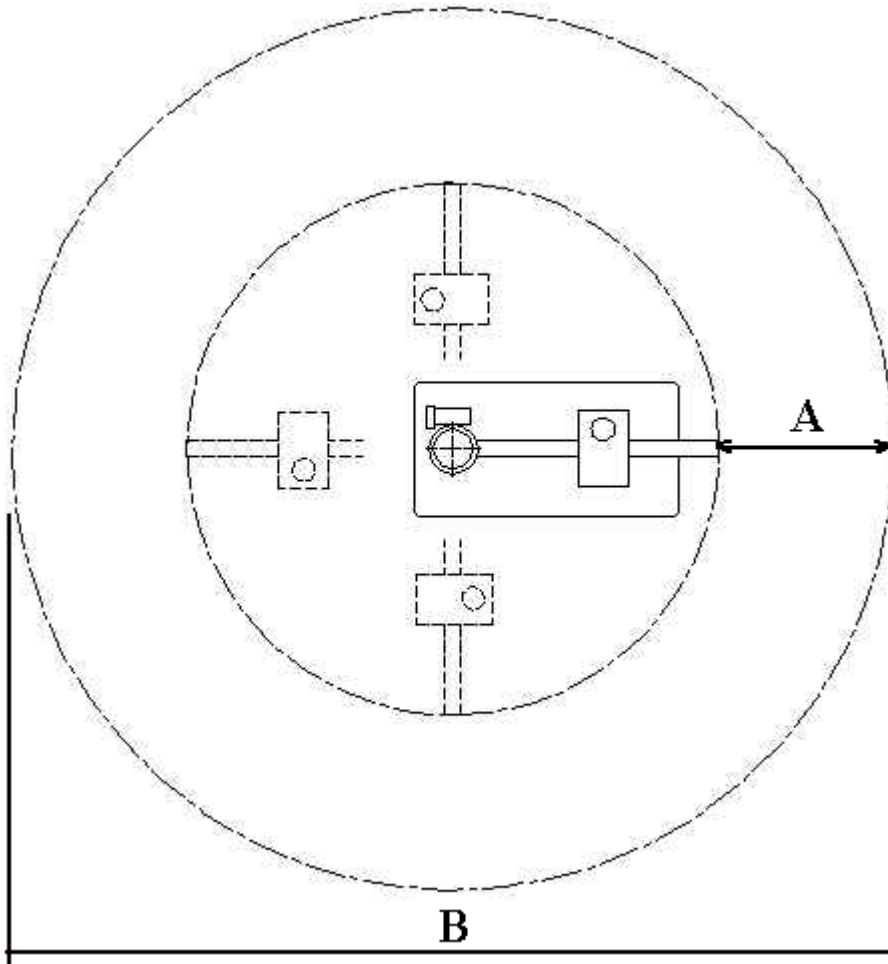

Its calculation is the area of the arm rotating 360 degree, the most outer circle and plus 1000 mm. Different models has different dimensions.

MODEL	The distance from the column center to the arm limit.	Plus maintenance area (A)	Total space requirement (B)
TPR-720A	1028 mm	1000 mm	4056 mm
TPR-820A	1128 mm	1000 mm	4256 mm
TPR-920A	1228 mm	1000 mm	4456 mm
TPR-1100	1428 mm	1000 mm	4856 mm

3.2 Environment requirement

- a. Never put the machine in the places where sun shines directly on it.
- b. Temperature: normal range is between +5°C and 40°C .
- c. Humidity: between 30% and 95%. At the max. temperature 40°C , The relative humidity should not be over 50%. And at the relative lower temperature, higher humidity is acceptable. I.g. at temperature 20°C ,humidity 90% is fine.
- d. Please keep the machine away from gasoline, chemical substances, dust, acid, sulfides, magnetic interference and explosive environment.
- e. Please keep the machine away from the electrical interference source like welding machine and EDM.
- f. The installation ground must be flat.
- g. The illumination of the work area: greater than 500lux.
- h. Good ventilation.
- i. Please take care there is no hydraulic splash to prevent from anyone slipping tripping and falling in danger.

3.3 Power supply requirement

- a. Acceptable voltage fluctuation : normally $\pm 10\%$ vlt.
- b. Acceptable frequency fluctuation : $\pm 1\text{HZ}$ (50/60HZ)
- c. Acceptable momentary power-off duration: less than 10m.sec
- d. Acceptable voltage impulse
The Peak value : 200% or less than the line voltage of the actual value(rms. value)
Duration: 1.5m.sec or less
- e. Acceptable AC voltage of the waveform distortion.
- f. Acceptable imbalance of the line voltage: 5% or less
- g. Power capacity table

I .For TPR-720A, TPR-820A, TPR-920A

Main Motor	1.5Kw
Elevating Motor	0.75Kw
Coolant Pump Motor	0.1Kw

The total power requirement should be 5.935KVA

II .Only for TPR-1100

Main Motor	2.25Kw
Elevating Motor	0.75Kw
Coolant Pump Motor	0.1Kw

The total power requirement should be 7.853KVA

3.4 Electric system calculation

3.4.1 For TPR-720A, TPR-820A, TPR-920A

Motor Part Name	Rated Power Capacity	Maximum Initiate Power
Main Motor	1.5kw	4.2kw
Elevating Motor	0.75kw	2.1kw
Coolant Pump Motor	0.1kw	0.28kw

Total Rated Power Capacity:

$$(1.5\text{kw}+0.75\text{kw}+0.1\text{kw})=2.35\text{kw}.....(1)$$

Maximum Total Initiate Power Capacity:

$$(4.2\text{kw}+2.1\text{kw}+0.28\text{kw})=6.58\text{kw}..... (2)$$

Transformer Rated Output Power Capacity for Control Circuits

	Model	
Item	100VA	
Power Supply	Input	AC200V~480V±10% 1Ø
	Output	AC24V~110V±10% 1Ø
Ambient Temperature	0°C To 55°C	

$$S=KVA$$

$$P=KW$$

$$Pf \times n = 0.75 \text{ (Correction Factors)}$$

$$S = \frac{KW}{Pf \times n (0.75)}$$

$$P = \frac{2.35KW}{0.75} = 3.133KVA..... (1)$$

$$P = \frac{6.58KW}{0.75} = 8.773KVA..... (2)$$

$$\text{Power Equipment Capacity} = \frac{3.133KVA + 8.773KVA}{2} = 5.935KVA$$

3.4.2 For TPR-1100

Motor Part Name	Rated Power Capacity	Maximum Initiate Power
Main Motor	2.25kw	6.3kw
Elevating Motor	0.75kw	2.1kw
Coolant Pump Motor	0.1kw	0.28kw

Total Rated Power Capacity:

$$(1.5kw+0.75kw+0.1kw)=3.1kw..... (1)$$

Maximum Total Initiate Power Capacity:

$$(4.2kw+2.1kw+0.28kw)=8.68kw.....(2)$$

Transformer Rated Output Power Capacity for Control Circuits

	Model	
Item	100VA	
Power Supply	Input	AC200V~480V±10% 1Ø
	Output	AC24V~110V±10% 1Ø
Ambient Temperature	0°C To 55°C	

$$S=KVA$$

$$P=KW$$

$$Pf \times n = 0.75 \text{ (Correction Factors)}$$

$$S = \frac{KW}{Pf \times n (0.75)}$$

$$P = \frac{3.1KW}{0.75} = 4.133KVA.....(1)$$

$$P = \frac{8.68KW}{0.75} = 11.573KVA.....(2)$$

$$\text{Power Equipment Capacity} = \frac{4.133KVA + 11.573KVA}{2} = 7.853KVA$$

CHAPTER 4

Transportation and Installation.

4.1 Disassembly and packaging.

4.1.1 General

Electrical equipment should be designed to stand transportation and storage under the temperature between -25°C and $+55^{\circ}\text{C}$. If this is impossible, proper measurements must be taken to endure the high temperature. The criteria for this measurement is that it can withstand the affection of the high temperature of $+70^{\circ}\text{C}$ within 24 hours. Other considerations like to prevent damage from vibration or shock must be also given.

4.1.2 Packaging.(For TPR-720A, TPR-820A, TPR-920A, TPR-1100)

When sold and being shipped to customer's plant, The machine needs to be packaged and fastened in place.

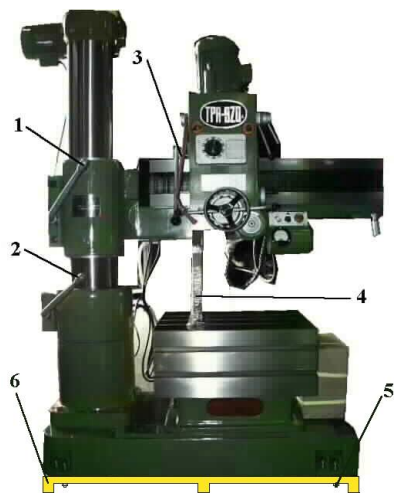

- a. The way to fasten the machine is illustrated as above diagram.
- b. 1 is the Arm tightening lever : Tight it clockwise.
- c. 2 is the Column tightening lever : Tight it clockwise.
- d. 3 is the gearbox tightening lever : Tighten it after being pulled upwards and fastened it to the speed change lever with wire, to prevent the pull lever from falling during transportation.
- e. 4 is a wooden block : Due to its weight, it might lose its accuracy during transportation. It is to support the weight of the Arm and prevent from collision each other when test running. (Please don't move it when unpacking.)
- f. The block is added to help the Column support the Gearbox.
- g. 5 is a fastening screw. : When being packaged, the machine needs to be fastened with screws. Otherwise, the machine might move during transportation and make the center of the gravity slant, therefore bring the risk that the machine falls.
- h. 6 is the wooden crate base : It will ease the movement by a forklift.

Precaution:

All levers must be tightened. Please refer to the chapter 1, regarding the transportation.

MODEL	LENGTH	WIDTH	HIGHT
TPR-720A	1625mm	810mm	2160mm
TPR-820A	1680mm	810mm	2210mm
TPR-920A	1810mm	810mm	2210mm
TPR-1100	1880mm	870mm	2210mm

4.2 Transportation.

4.2.1 The diagram of the machine weight and its gravity center.

The weight differ due to the different models. Their data is as blow:

MODEL	TPR-720A	TPR-820A	TPR-920A	TPR-1100
Total Weight	1250 kgw	1340 kgw	1400 kgw	1950 kgw
Required Forklift	2 tons	2 tons	2 tons	2.5 tons

Note:

Please make sure that the forklift tonnage is suitable for the machine.

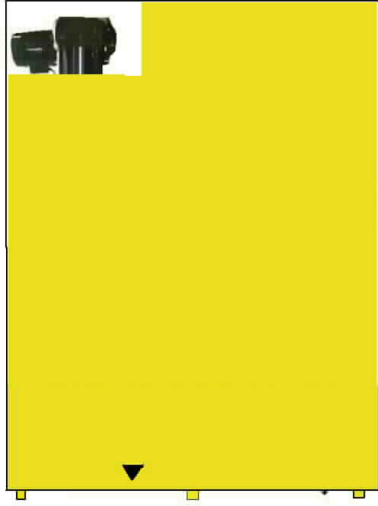

The above arrow pointed place is the machine's gravity center. It is about 200 mm far from the Column, measured from the middle of the wooden crate.

4.2.2 The movement of the machine.

The follow is using forklift to move the machine.

The following is the procedure, precaution and illustration for moving the machine with forklift.

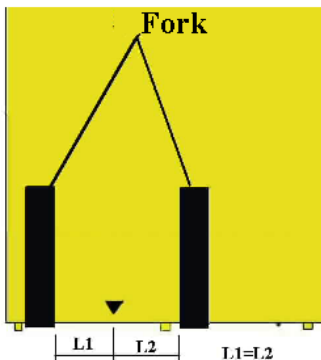

- Have a suitable forklift move to the wooden crate.
- As diagram shown, insert two forks into the underneath of the wooden crate.
- Adjust the distance from the forks to the gravity center till L1 is equal to L2. (L1 & L2=350mm)
- Have forks fully inserted into the underneath of the wooden crate.
- Have the machine fastened to the forks and forklift, using metal chain or wire.

Precaution :

- Forks must be fully inserted.
- L1 must be equal to L2 so that the machine can be in balance.

4.2.3 The order to pack

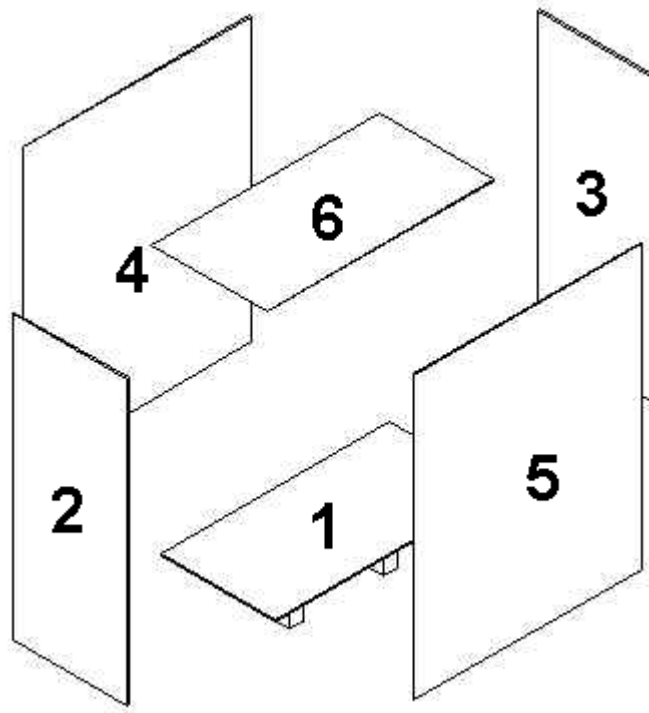

Please pack according the following procedure:

1. Place the base plate 1 under the machine and have both the plate and the machine fastened with bolts.
2. Install the side plate 2.
3. Install the side plate 3.
4. Install the side plate 4.
5. Install the side plate 5.
6. Install the top plate 6 and pack it.

4.3 Installation of the machine.

4.3.1 Have the machine set onto the fastening bolts of the crate base.

(1) Tools

Sling, lifting equipment, spanner, movement plate, insertion blocks and level adjusting blocks.

(2) Procedure

- a. After dismantling the wooden crate, get the manuals and tool box out.
- b. Remove the fastening bolts.
- c. Hook it using sling, lift it up and move to site for installation.
- d. Align the ground bolts and the base bores and set the later onto them. Meanwhile, have the level adjusting blocks inserted to the underneath of the level adjusting bolts.
- e. Remove the lifting equipment and slings.
- f. Have nuts for the ground bolts mounted.

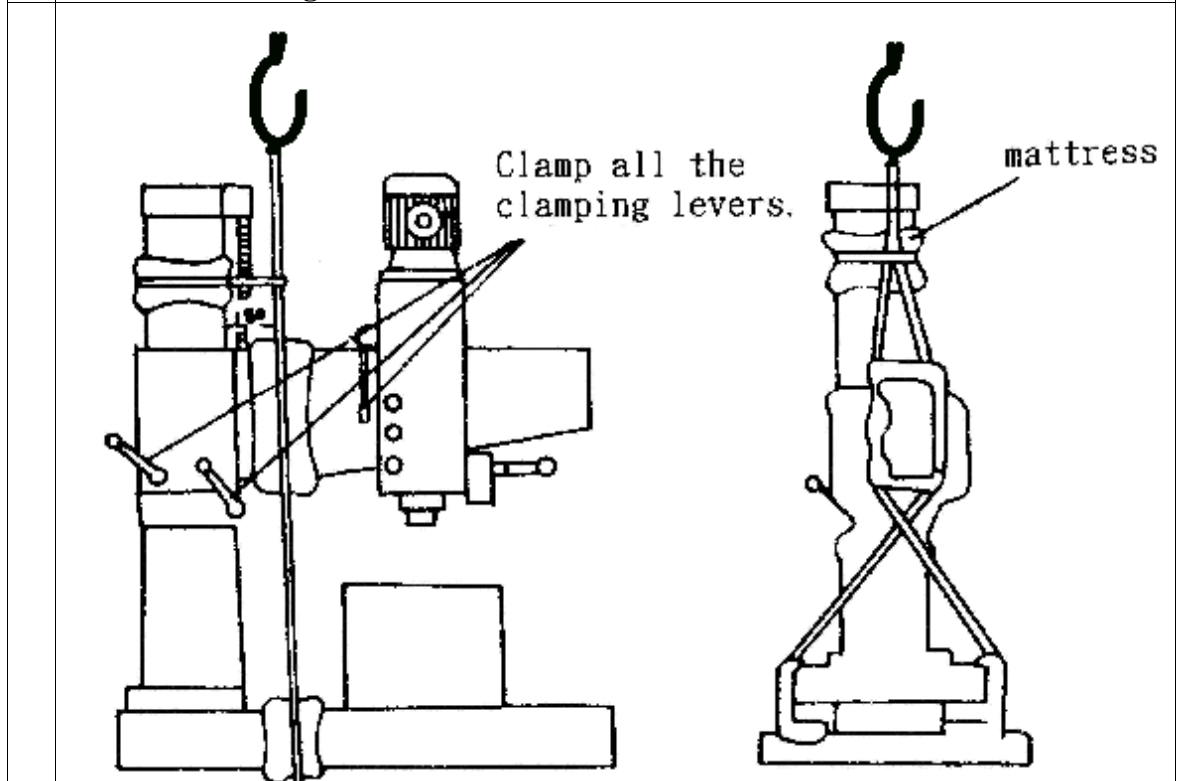

4.3.2 Level adjusting.

(1) Tools

- a. A level scale, with tolerance within 0.02mm/m
- b. Spanners, Level adjusting blocks.

(2) Procedure

- a. Please adjust the level adjusting bolts to contact the level adjusting blocks.
- b. Have the level scale put on the worktable.
- c. Locate the peak point using the level scale and make it as a reference level.
- d. Adjust the tolerance of the level adjusting bolts to be within one grad using the level adjusting scale.



1.	The level adjusting bolts.
----	----------------------------

4.3.3 The installation of the electricity.

- a. Prepare long enough wire. (about 30 meters). The diameters for all the models are as follows:
- b. Connect L1、L2 and L3 to the main power switch.
- c. Connect the ground wire to PE base.

Note: The following are the main power switches and its other relating data.

		Power supply AC±10%1Φ 50/60HZ±1HZ								Power equipment capacity (KVA)
Item Type	Cross-sectional area of phase conductors supplying the equipment` (mm ²)					Rated current (A)				
	220V	380V	415V	440V	PE	220V	380V	415V	440V	
TPR-720A	2	2	2	2	2	6.578	3.62	3.62	3.62	5.935
TPR-820A	2	2	2	2	2	6.578	3.62	3.62	3.62	5.935
TPR-920A	2	2	2	2	2	6.578	3.62	3.62	3.62	5.935
TPR-1100	3.5	3.5	3.5	3.5	3.5	16.2	9.87	9.14	8.53	7.853

4.4 The test after installation.

- a. Have the main power on.
- b. Press the emergent stop button to see whether it stops immediately.
- c. Power on again.
- d. Please check whether the motor is running smoothly. If there is any errors, Please select two of the wires L1, L2 and L3 and change its position.
- e. Check every mechanism to see whether it works normally.

4.5 The procedure for dismantling the machine.

The dismantling procedure is the reverse of the installation one.

CHAPTER 5

Operation

5.1 A brief introduction to the relevant operation hardware.

5.1.1 (For TPR-720A, TPR-820A, TPR-920A)

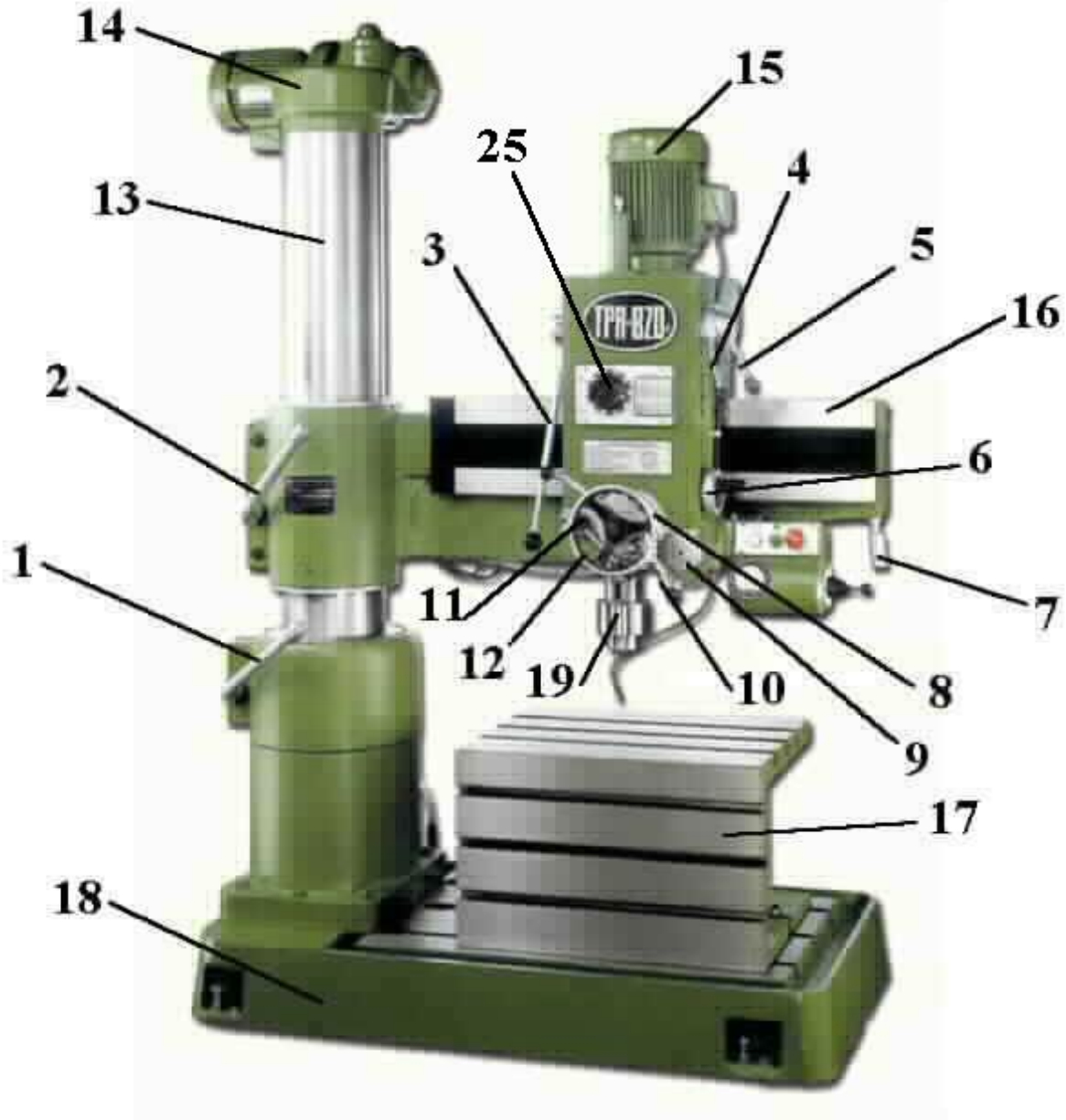

The front view of TPR-820A.

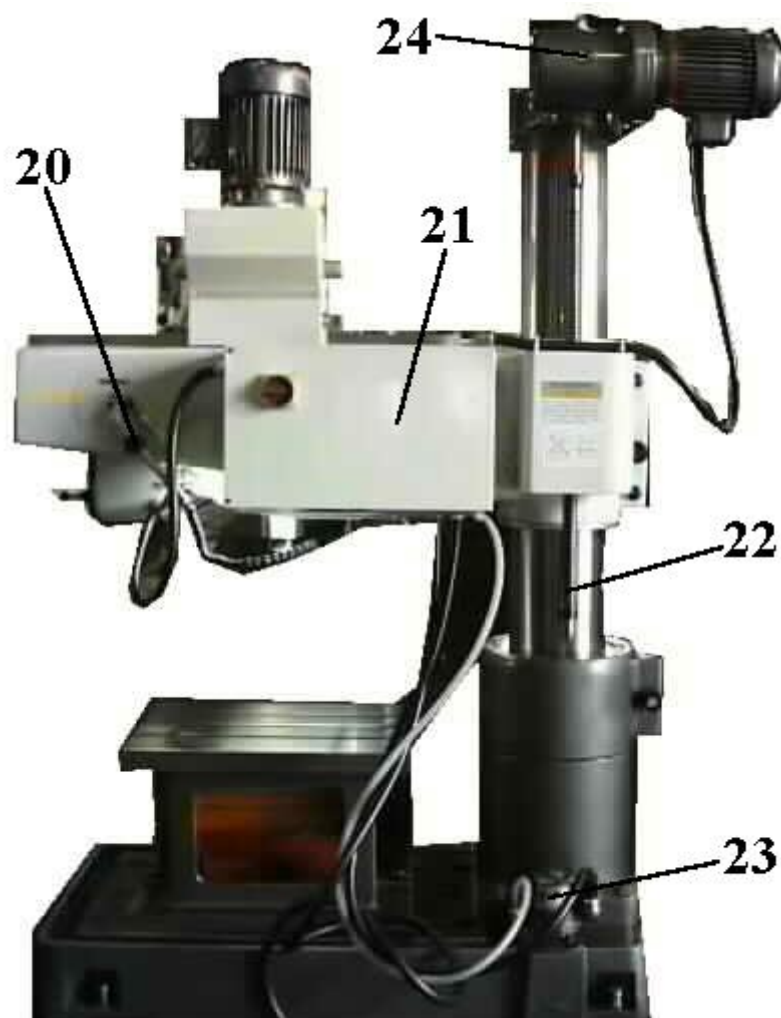

The rear view of TPR-820A.

The relevant terms. (For TPR-720A, TPR-820A, TPR-920A)

No.	Term	Description
1	Column clamping lever	It is to secure the rotation position of the Arm on the Column. e.g. after arm is rotated to a certain degree, you use this lever to secure the Arm on the Column.
2	Arm clamping lever	It is to secure the lifting or lowering position of the arm. e.g. after the arm is lifted or lowered to a certain height, you use this lever to secure the Arm on the Column.
3	Head clamping lever	It is to secure the horizontal position of the spindle and gearbox on the Arm. e.g. after the Spindle is moved leftwards or rightwards to a certain position, you use this lever to secure the Spindle on the Arm.
4	Three speeds change lever	It is to change the speed of the Spindle. There are three speeds for it.
5	Two speeds change lever	It is to change between the high and low speed. After interconnecting with three speeds change lever, there are six speeds available on the machine.
6	Hand wheel, for moving head	It is the indicator for the automatic knife feeding. It runs simultaneously with the feeding knives.
7	Handle, for rotating the Arm.	It requires the smallest strength and it is the safest way to rotate the Arm.

8	Main dial	It indicated the depth of the drilling. Its scale range is less than 100 mm.
9	Auxiliary dial	It helps you fine dial when the Main Dial is not enough precision for drilling a certain depth. Its scale range is less than 220 mm.
10	Lever, for feed trip.	It is to start or stop the automatic Knives Feeding.
11	Feed depth lever	It is to set up the position of the Main Dial and the Feed Trip.
12	Hand wheel	It is to move the head either to right or to left side.
13	Column	It is to support the Gearbox and Arm. It is connected with the Base.
14	Top Cap	There is a motor on it, which is to move the Gearbox and Arm up or downwards.
15	Main motor	It is to move the spindle.
16	Arm	It is to support the Gearbox, connecting with the Column.
17	Worktable	It features a T shape chamfer, which help clamp and position work piece. In addition, the worktable helps shorten the distance between the work piece and the drill bit.
18	Base	It is the gravity center of the machine. It stores the cutting fluids. When no worktable used, it is used to support the work piece and applied as a base for processing. It features also a T shape chamfer, which is very convenient for clamping.
19	Spindle	It is the place where drill bit, threading head, drill clamp are mounted on.
20	Cutting fluids adjusting knob	It is used to control the floating of the cutting fluids.
21	Control box	All control elements are mounted here.
22	Electric ball screw	It is the rail of the Arm, which can be lifted or lowered by an elevating motor.
23	Cutting fluids pump	It is to pump the cutting fluids from the container to lubricate the drilling or boring.
24	Elevating motor	It is to elevate up or down the Arm through ball screw.
25	Feed rate switch	When at boring and automatic feeding needed, the feed rate varies due to the different material and drilling bit used. It is used to adjust the feed rate.

5.1.2 (For TPR-1100)

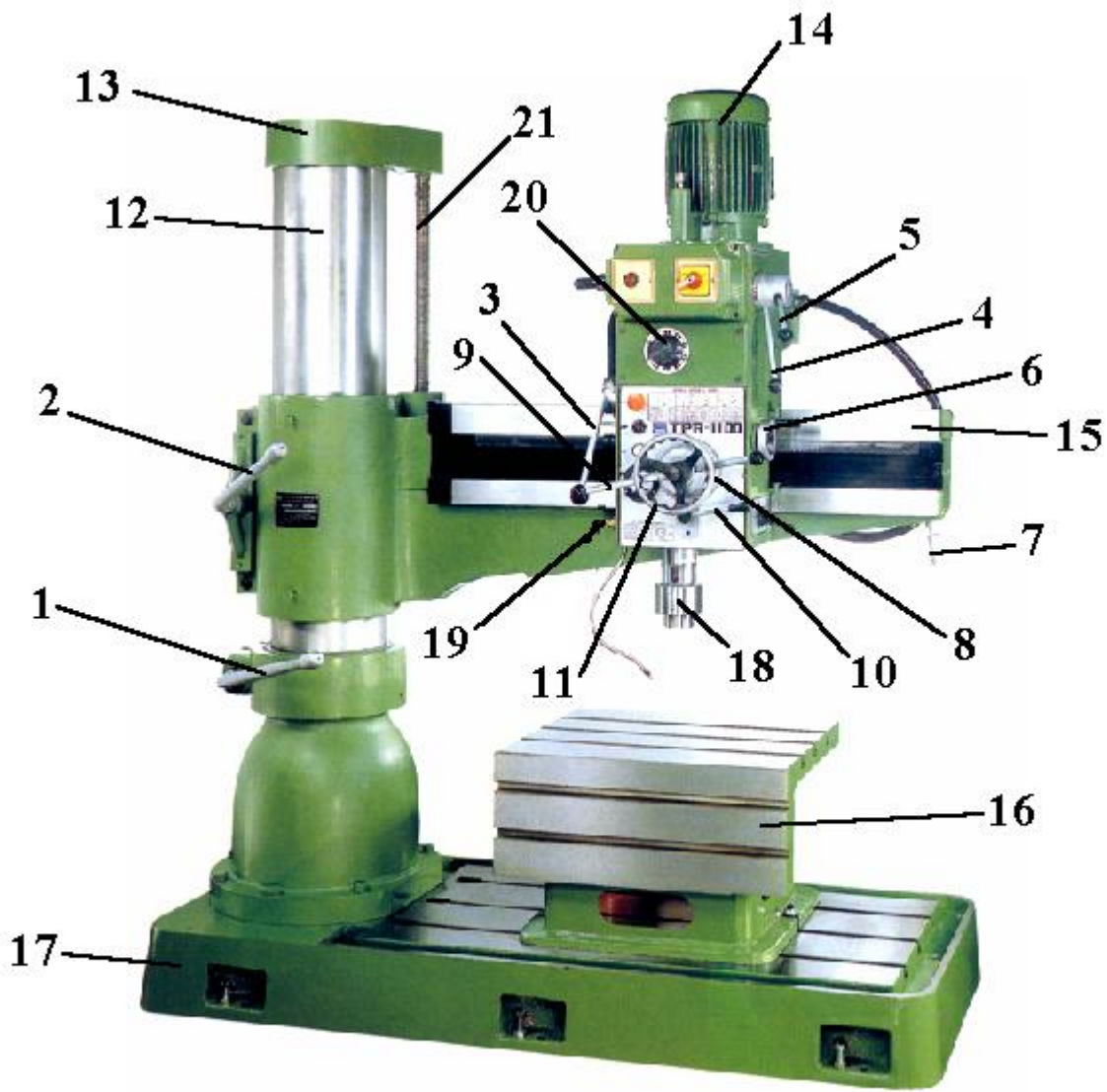

The front view of TPR-1100.

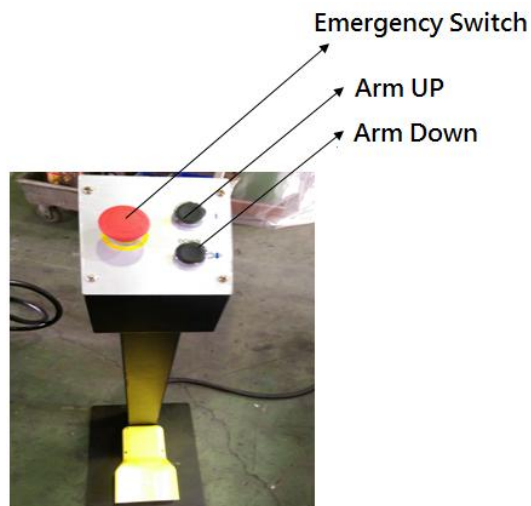

The upper map is used for special struction. (optional)

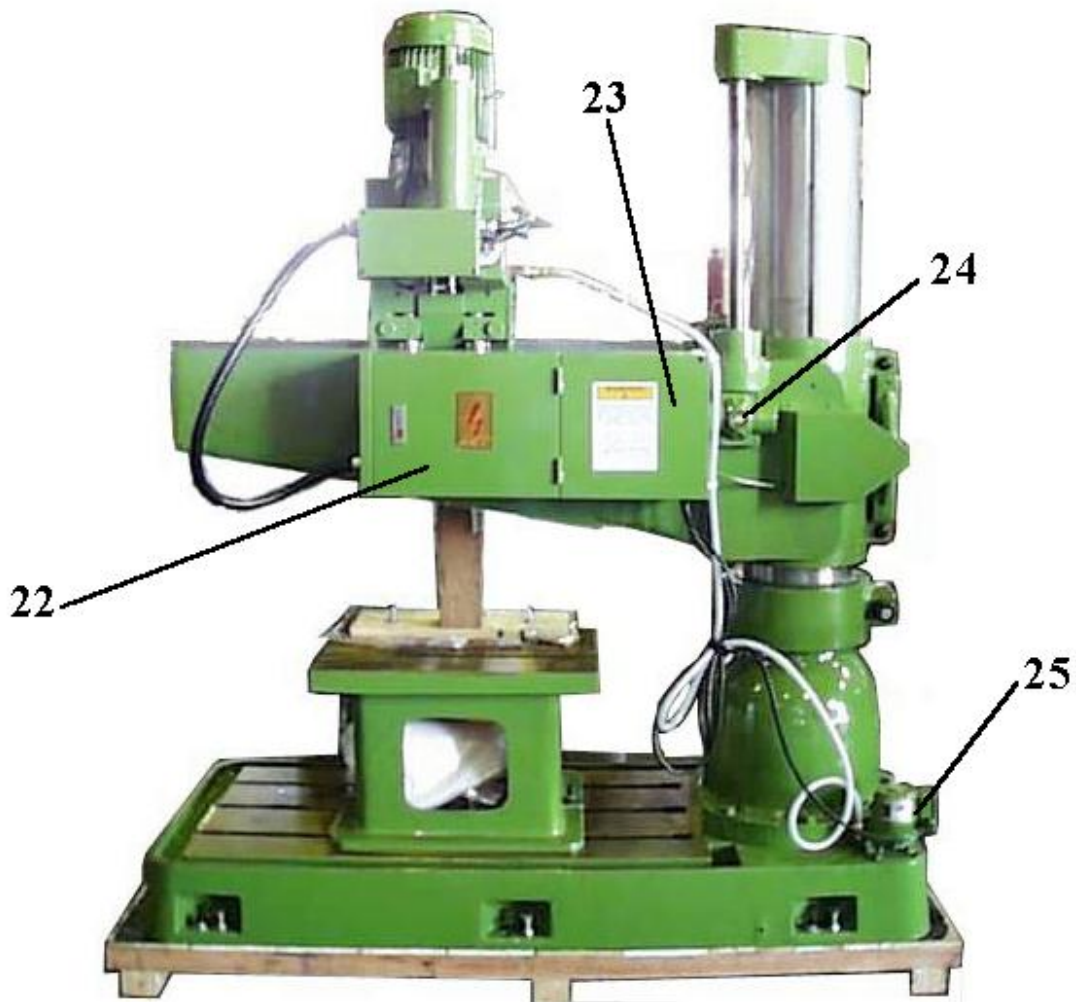

The rear view of TPR-1100

The relevant terms. (For TPR-1100)

No.	Term	Description
1	Column clamping lever	It is to secure the rotation position of the Arm on the Column. e.g. after arm is rotated to a certain degree, you use this lever to secure the Arm on the Column.
2	Arm clamping lever	It is to secure the lifting or lowering position of the arm. e.g. after the arm is lifted or lowered to a certain height, you use this lever to secure the Arm on the Column.
3	Head clamping lever	It is to secure the horizontal position of the spindle and gearbox on the Arm. e.g. after the Spindle is moved leftwards or rightwards to a certain position, you use this lever to secure the Spindle on the Arm.
4	Three speeds change lever	It is to change the speed of the Spindle. There are three speeds for it.
5	Two speeds change lever	It is to change between the high and low speed. After interconnecting with three speeds change lever, there are six speeds available on the machine.
6	Hand wheel, for moving head	It is the indicator for the automatic knife feeding. It runs simultaneously with the feeding knives.

7	Handle, for rotating the Arm.	It requires the smallest strength and it is the safest way to rotate the Arm.
8	Main dial	It indicated the depth of the drilling. Its scale range is less than 100 mm.
9	Lever, for feed trip.	It is to start or stop the automatic Knives Feeding.
10	Feed depth lever	It is to set up the position of the Main Dial and the Feed Trip.
11	Hand wheel	It is to move the head either to right or to left side.
12	Column	It is to support the Gearbox and Arm. It is connected with the Base.
13	Top Cap	There is a motor on it, which is to move the Gearbox and Arm up or downwards.
14	Main motor	It is to move the spindle.
15	Arm	It is to support the Gearbox, connecting with the Column.
16	Worktable	It features a T shape chamfer, which help clamp and position work piece. In addition, the worktable helps shorten the distance between the work piece and the drill bit.
17	Base	It is the gravity center of the machine. It stores the cutting fluids. When no worktable used, it is used to support the work piece and applied as a base for processing. It features also a T shape chamfer, which is very convenient for clamping.
18	Spindle	It is the place where drill bit, threading head, drill clamp are mounted on.
19	Cutting fluids adjusting knob	It is used to control the floating of the cutting fluids.
20	Feed rate switch	When at boring and automatic feeding needed, the feed rate varies due to the different material and drilling bit used. It is used to adjust the feed rate.
21	Electric ball screw	It is the rail of the Arm, which can be lifted or lowered by an elevating motor.
22	Control box	All control elements are mounted here.
23	Elevating speed reducer	The elevating motor rotates very fast. If the motor drives the ball screw transmission directly, it is very hard to control the elevating position. Therefore an elevating speed reducer is mounted to easily control the elevating positions.
24	Metal covering	It covers the internal Elevating motor and ball screw so that the operator or others can be safely protected.
25	Cutting fluids pump	It is to pump the cutting fluids from the container to lubricate the drilling or boring.

5.1.3 Safty protective device (suit every model)

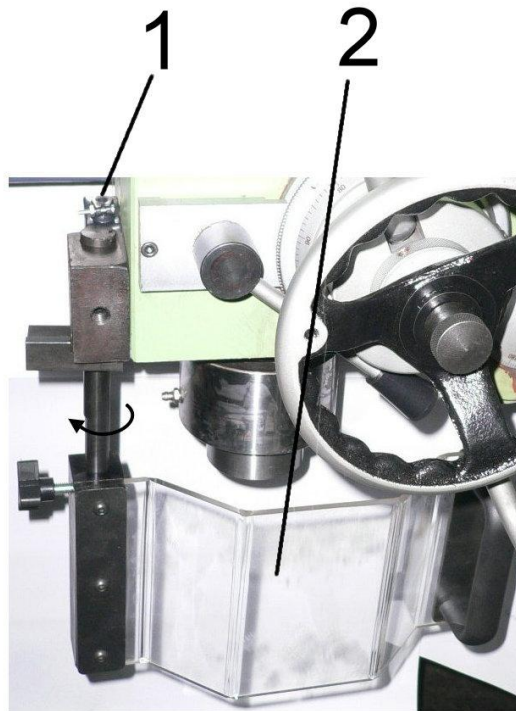

No.	Term	Description
1	Safety Protective Cover	For to avoid debris fly off. When spindle making the drilling bit,the cover must be close. Another for safety, the spindle must stop rotation, when the cover is open.
2	Limit Switch	The limit switch is controlled by safety protective cover's open or close. If safety protective cover is open,the spindle stop rotation by limit switch' single . Another,if safety protective cover is close,the spindle can rotation.

Precaution :

1.	When user close the saftety protective cover(As marked 1) , the limit switch (As marked 2)can message a signal to allow the spindle rotation.Therefore, user can operation the machine.
2.	When user open the saftety protective cover(As marked 1) , the limit switch (As marked 2)can message a signal to stop the spindle rotation immediatly.

5.2 Instruction to switches.

I .(For TPR-720A, TPR-820A, TPR-920A)(Type I)



The front view of TPR-820A

Description for Switches.

(For TPR-720A, TPR-820A, TPR-920A)(Type II)

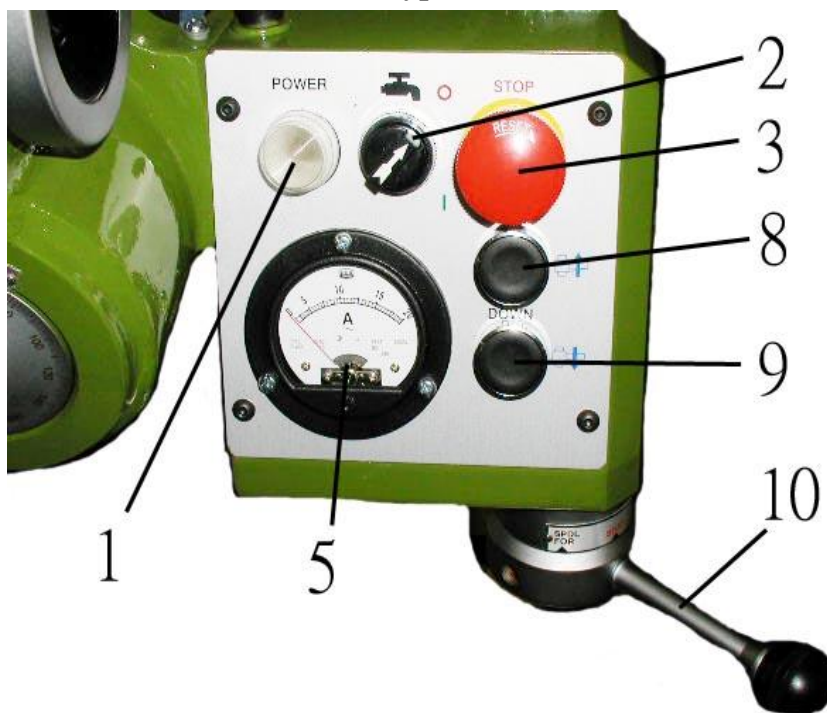

The rear view of TPR-820A

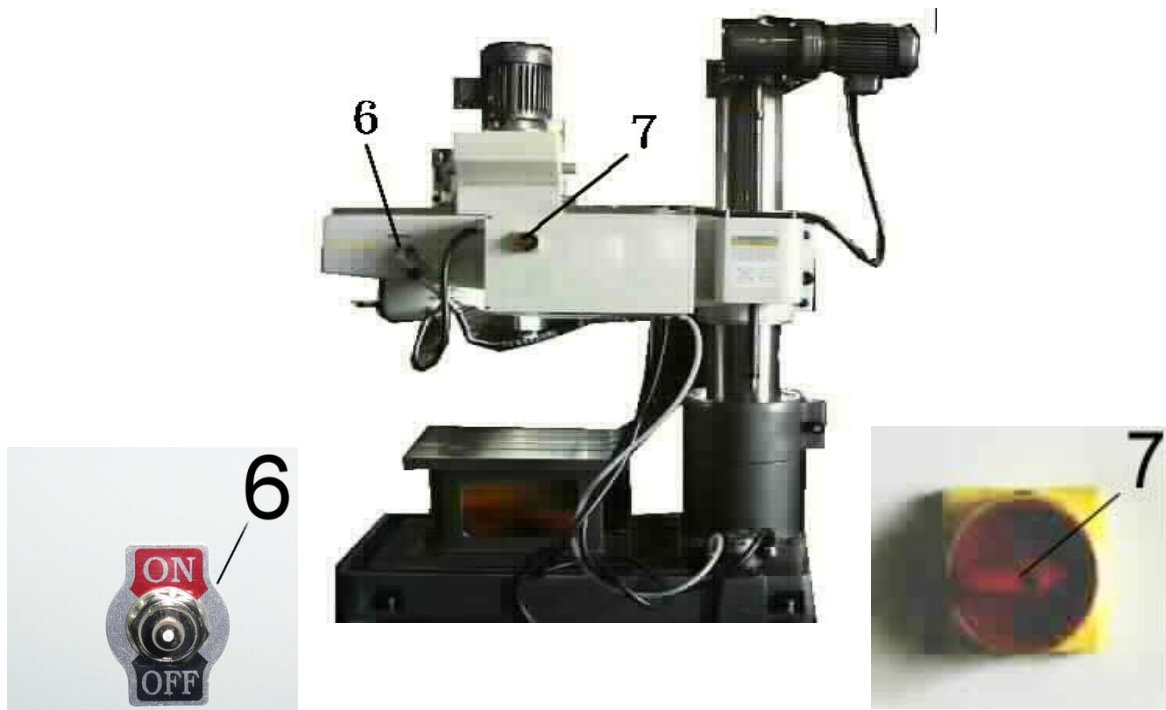

The rear view of TPR-820A

1.	Power-on light	It lights when it powers on.
2.	The cutting fluids switch	It is a switch to start on or off the lubrication when at boring, where the boring or shearing causes high temperature, making the drilling bit easy to wear. The lubrication can reduce the temperature and lengthen the life of the drilling bit. Turn on to start and off to stop the lubrication. The floating capacity is decided by another knob called the cutting fluids adjusting knob.
3.	Emergent stop	It is pressed to stop the machine when at processing and emergence occurs. Pull it again for back to release the stop.
4.	Cross switch	It is to control the elevating and revolution. There are four sign on it. When switched to “SPDL. FOR.”, the spindle revolves clockwise. When switched to “SPDL.REV.”, it revolves counter clockwise. When switched to “ARM UP”, the Arm lifts. When switched to “ARM DOWN”, the arm descends.
5.	Electric current meter	It is for operator’s understanding whether the working situation is normal.
6.	Work light switch	It is used to improve lighting where illumination is not enough.
7.	Main power switch	It is the terminator of the power connection between the machine and the power source.
8.	Arm uplift switch	The arm will uplift when pushing the “up”button.
9.	Arm downlift switch	The arm will be lowered down when pushing the “down” button.
10.	Main spindle forward -reverse switch	When switch to SPDL.FOR, The spindle will forward . When switch To SPDL.REV.the spindle will reverse.

II .FOR TPR1100(Type I)

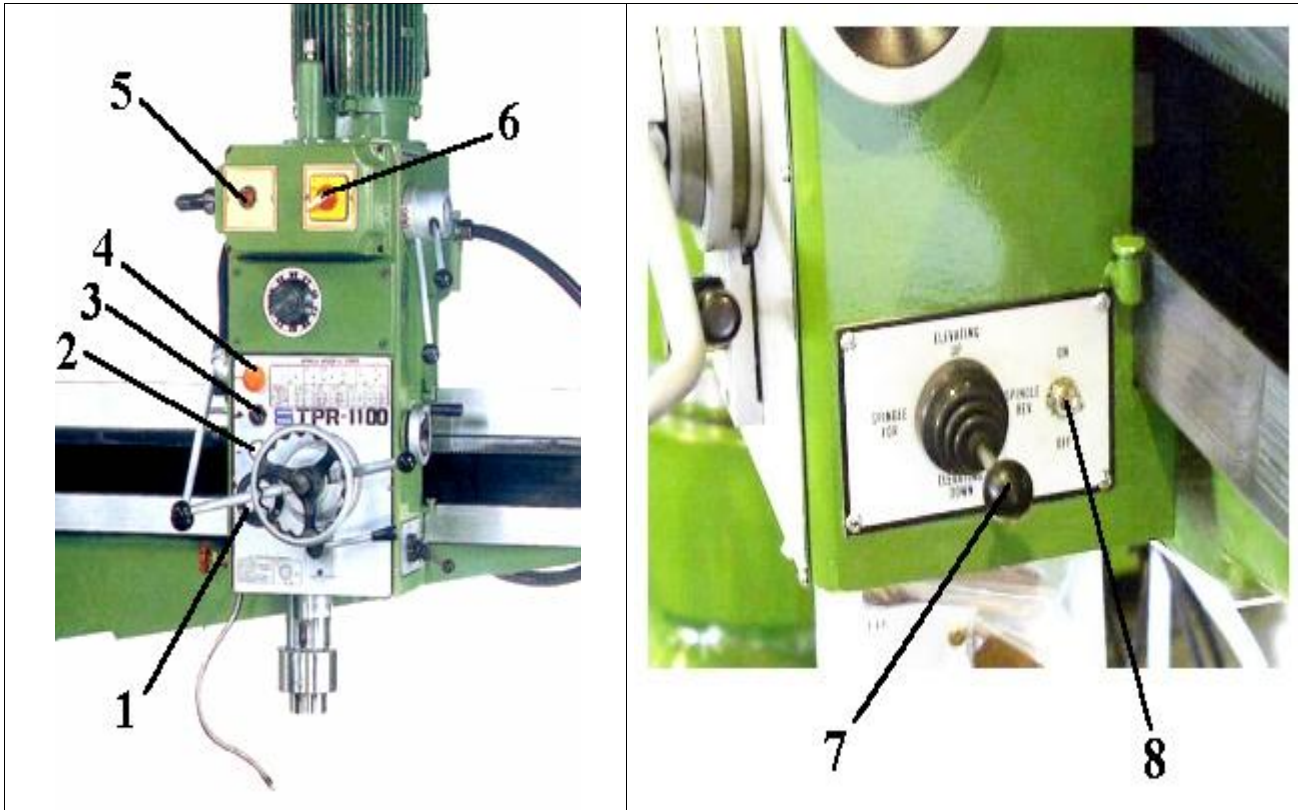

Description for Switches.

For TPR-1100 (Type I)

1.	Electric current meter	It is for operator’s understanding whether the working situation is normal.
2.	Feeding light	It lights when at feeding. After work finished and power off, it turns off .
3.	The cutting fluids switch	It is a switch to start on or off the lubrication when at boring, where the boring or shearing causes high temperature, making the drilling bit easy to wear. The lubrication can reduce the temperature and lengthen the life of the drilling bit. Turn on to start and off to stop the lubrication. The floating capacity is decided by another knob called the cutting fluids adjusting knob.
4.	Emergent stop	It is pressed to stop the machine when at processing and emergence occurs. Pull it again for back to release the stop.
5.	Power light	When the external power and the main machine power switch are on, The power light will be on ,indicating to the operator that the power is on.
6	Pole change switch	The spindle motor is a pole variable one, a regular motor has 4 pole. But this one is changeable between 4 and 8 pole . It can change the Spindle rotating speed.
7.	Cross Switch	It is to control the elevating and revolution . there are four sign on it. When switched to “SPDL.FOR.”,the spindle revolves clockwise, When switched to “SPDL.REV.”,it revolves counter clockwise, When switched to “Arm UP”, the Arm lifts, When switched to “Arm Down” , the arm descends.
8.	Work light switch	It is used to improve lighting where illumination is not enough.

II .For TPR-1100 (Type II)

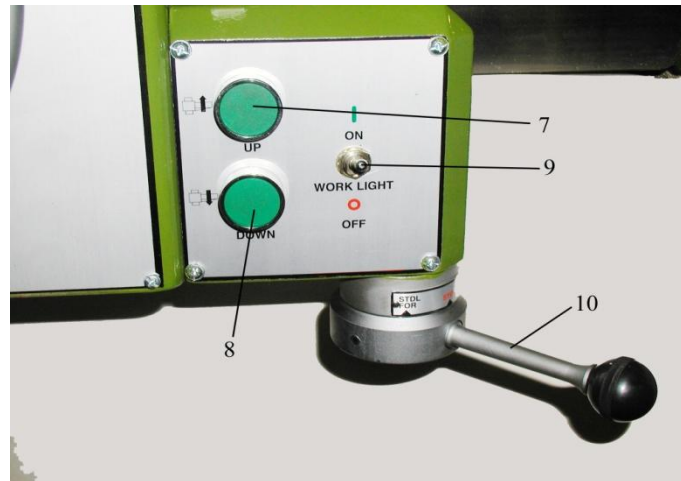

Description for Switches.

For TPR-1100 (Type II)

1.	Electric current meter	It is for operator's understanding whether the working situation is normal.
2.	Feeding light	It lights when at feeding. After work finished and power off, it turns off .
3.	The cutting fluids switch	It is a switch to start on or off the lubrication when at boring, where the boring or shearing causes high temperature, making the drilling bit easy to wear. The lubrication can reduce the temperature and lengthen the life of the drilling bit. Turn on to start and off to stop the lubrication. The floating capacity is decided by another knob called the cutting fluids adjusting knob.
4.	Emergent stop	It is pressed to stop the machine when at processing and emergence occurs. Pull it again for back to release the stop.
5.	Power light	When the external power and the main machine power switch are on, the power light will be on, indicating to the operator that the power is on.
6.	Pole change switch	The spindle motor is a pole variable one. A regular motor has 4 pole. But this one is changeable between 4 and 8 pole. It can change the spindle rotating speed.
7.	Arm uplift switch	The arm will uplift when pushing the "up"button.
8.	Arm downlift switch	The arm will be lowered down when pushing the "down" button.
9.	Working lamp switch	To lighten the working area.
10.	Main spindle forward -reverse switch	When switch to SPDL.FOR, The spindle will forward . When switch To SPDL.REV.the spindle will reverse.

5.3 Installation of the clamp (work piece)

5.3.1 General

Work piece must be placed securely and precisely on the radial drill so that precision and safe procession can be achieved. Regularly, a vise is applied. (as shown picture a). Since the vise has its range limit, universal clamp (as shown picture b) is applied for bulky work piece or any work piece which isn't easy to be clamped. The universal clamp includes T shape chamfer bolts, stacking plate, insertion blocks, which makes clamping easier.

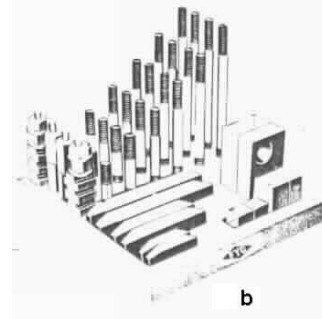
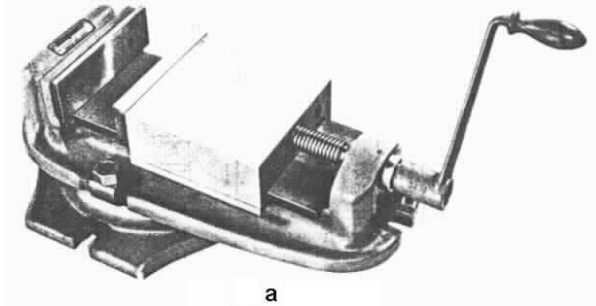

5.3.2 Introduction of the vise and the clamping of the work piece.

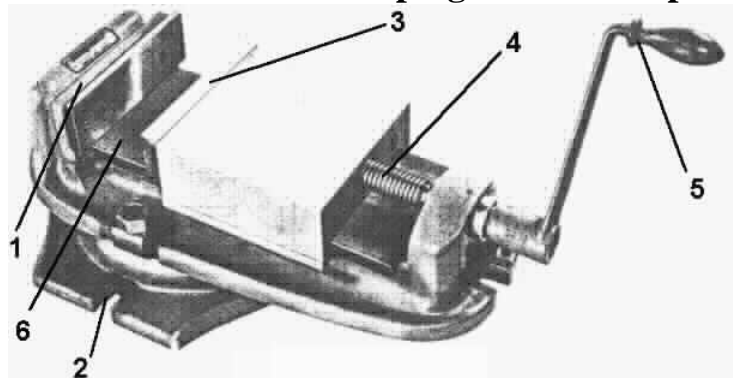

(1)	The fixed side of the vise.
(2)	The fixing side with T shape chamfer bolt and nuts
(3)	The moving side of the vise.
(4)	The screw bar.
(5)	The handle.
(6)	The surface of the vise.

Clamp work piece as the following :

a.	Move away the drilling bit or lift the gearbox to the utmost point.
b.	Using brush, clean the worktable and the vise surface.
c.	Clean the vise surface using clean rag.
d.	Position the work piece on the vise surface. If it is piercing drilling, please insert a block under the work piece so that drilling into vise can be avoided.
e.	Fasten the handle by rotating it clockwise and tighten it. While tightening it, please use plastic hammer or copper bar to hit the work piece till there is no gap between the work piece and the inserted block.

5.3.3 Universal clamp and the clamping of the work piece.

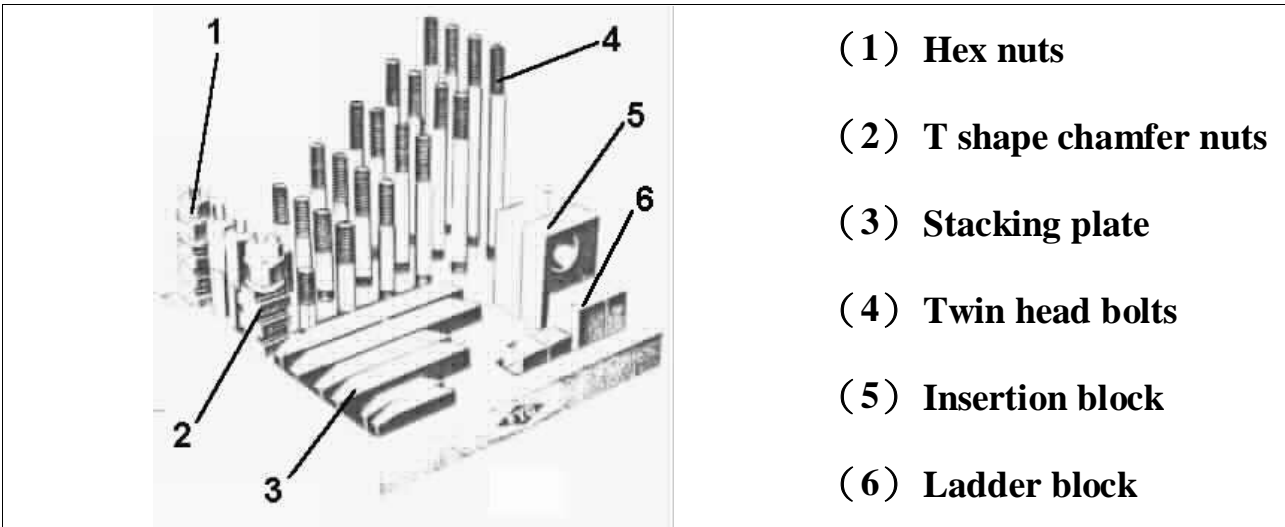

Clamp the work piece as the following : (Since the combination of the universal clamp is very flexible and abundant, The following diagram is applied as an exemplary description.

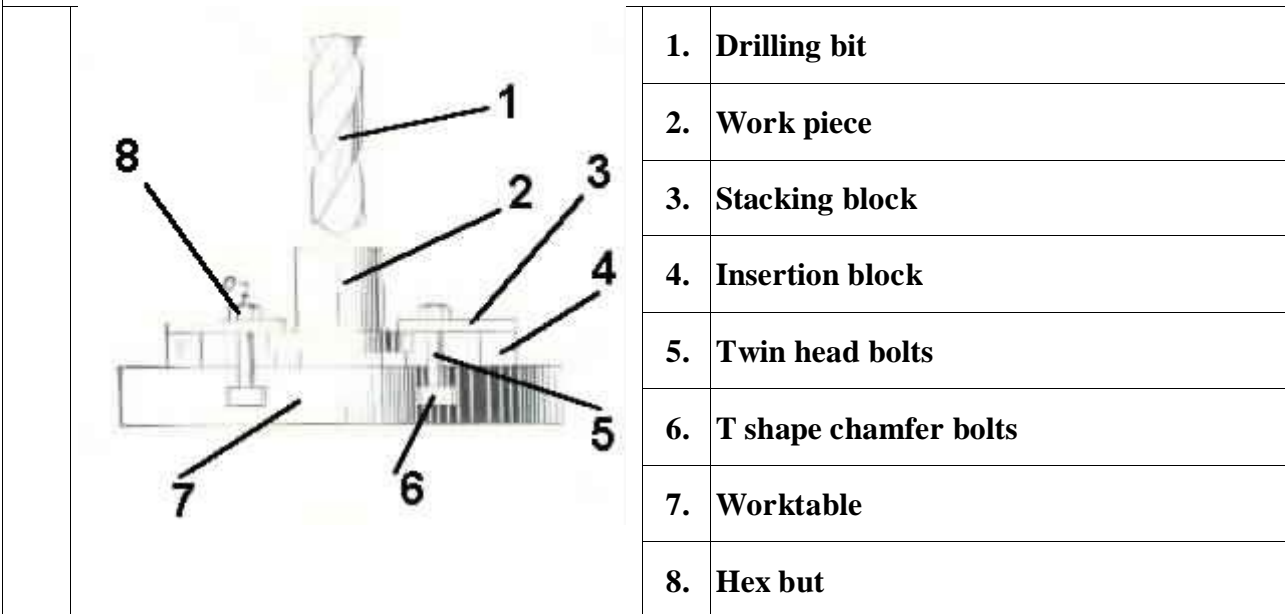

- a. Move away the drilling bit or lift the gearbox to the utmost point.
- b. Using brush, clean the worktable and the vise surface.
- c. Clean the vise surface using clean rag.
- d. Position the work piece on the vise surface. If it is piercing drilling, please insert a block under the work piece so that drilling into vise can be avoided.
- e. After screwing the T shape chamfer nut to the twin head bolts with suitable length, put it into the T shape chamfer of the worktable or the base.
- f. Choose the insertion block or ladder block that is the same high as work flange. Put them in the other side of the bolts.
- g. Using holed stacking block, place them onto the bolts, with one of its side pressing the work flange and another pressing the insertion block or ladder block, then tighten it with hex nuts.

Examples of clamping, using the universal clamp.

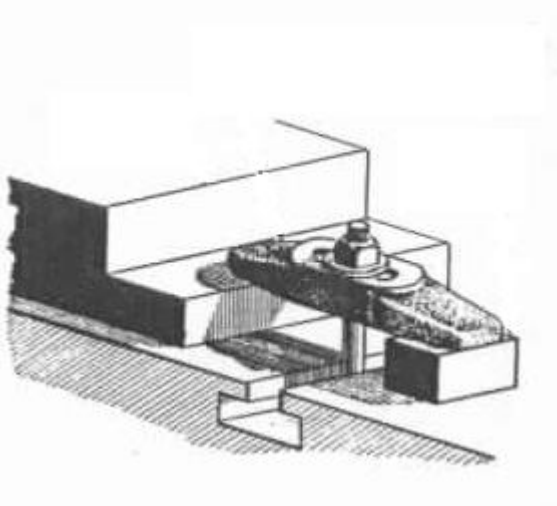
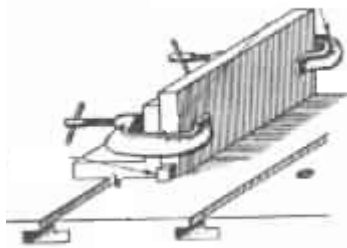
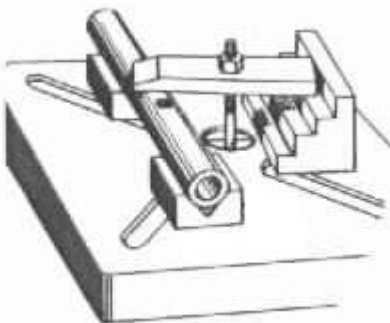
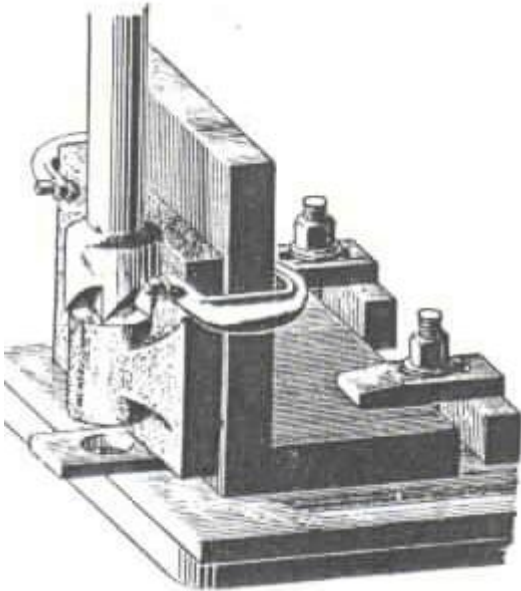
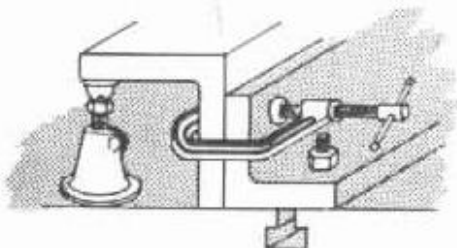
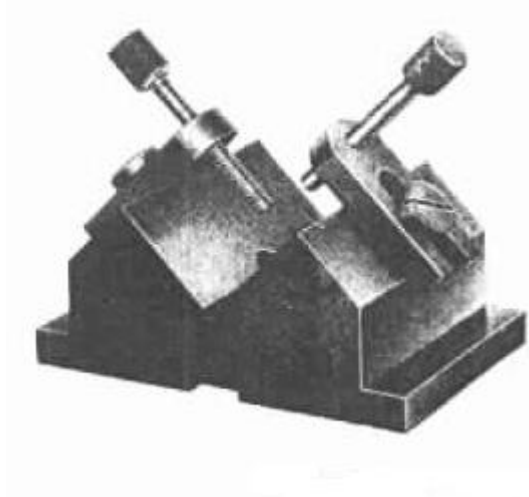
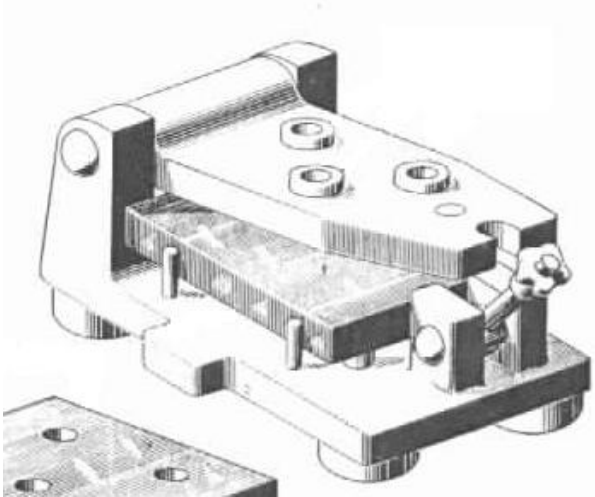

5.4 Installation and change of the drilling unit.

The radial drill is mainly used in drilling. How to clamp the drilling bit is therefore very important. Generally, drilling bits divide into two kinds, one is straight handle drilling bit, and another is tapered handle one. (as fig. A). Their clamping is very different. The straight handle one is fixed by a drilling head while the tapered handle one is fixed by a bushing.

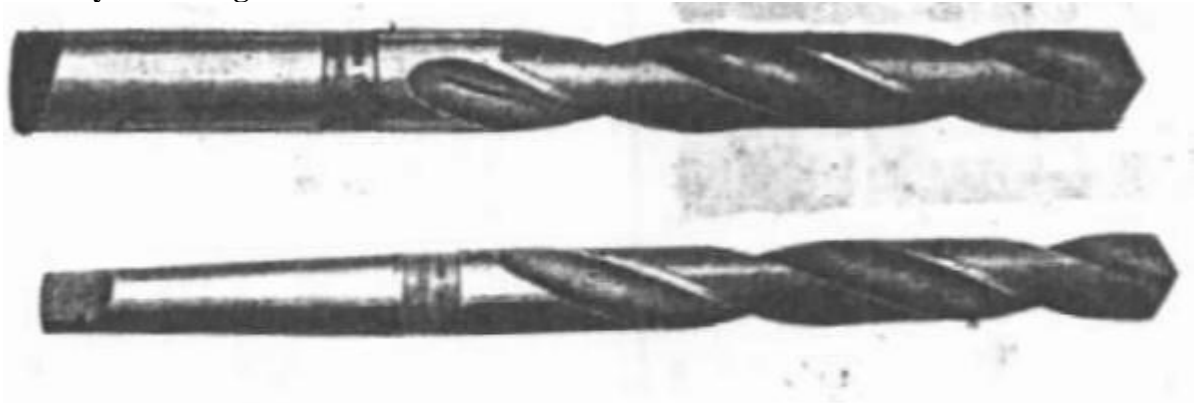

a



b

c

5.4.1 The assembly and disassembly of the drilling head and clamp

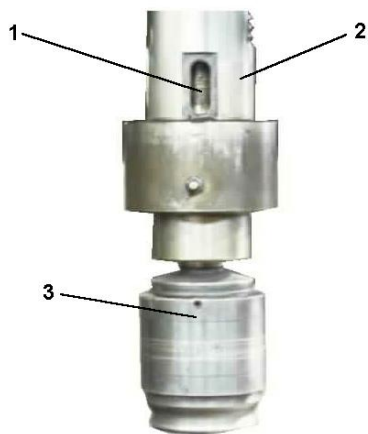

Fig. a.



Fig. b.



Fig. c.

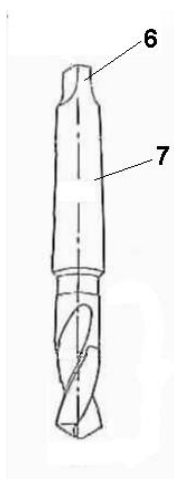

Fig. d.

No.	Term
(1)	Revolving shaft.
(2)	Shaft bushing
(3)	Speedy drill bit clamp
(4)	The stem for the speedy drill bit clamp
(5)	Pin for releasing drill bit
(6)	Drill shaft end
(7)	Drilling shaft

Disassemble the tapered handle drill bit and the drill head clamp as the following way:

a.	Move away the drilling bit or lift the gearbox to the utmost point.
b.	Power off machine.
c.	Put on gloves.
d.	Insert a thick wood plate into the underneath of the drill bit and the drill bit head.
e.	Rotate the feed trip lever clockwise and have the spindle descend about 150 to 200 mm. As fig. a.
f.	Rotate the revolving shaft from the bushing till that the drill shaft end and drill shaft are visible from the hole of releasing drill bit. as fig. b.
g.	Insert the pin for releasing the drill bit into the hole, as fig. c.
h.	Hit the end of the pin for releasing drill bit, using plastic hammer or copper bar, till the drill bit and the drill bit clamp fall onto the wood plate.

Precaution :

The distance between the thick wood plate, drill bit and the end of the drill bit clamp is about 30 mm.

Assemble the drill bit head and the drill bit clamp as the following:	
a.	Move away the drilling bit or lift the gearbox to the utmost point.
b.	Power off.
c.	Put on gloves.
d.	Insert a thick wood plate into the underneath of the drill bit and the drill bit clamp.
e.	Rotate the feed trip lever clockwise and have the spindle descend about 150 to 200 mm. As fig. a.
f.	Rotate the revolving shaft from the bushing till that thing behind the machine is visible from the hole of releasing drill bit, as fig. b.
g.	Place the drill bit clamp end up, as fig. d.
h.	Place the drill bit and its clamp end into the revolving shaft and have the drill shaft end inserted into the hole for releasing the drill bit, as fig. b.
i.	Rotate the feed trip lever counter clockwise. Make the spindle descend till the drill bit and the bottom end of the drill bit clamp head contact the wood plate. Apply a little bit force and complete it by confirming that the drill bit won't fall.
Precaution:	
	The distance between the thick wood plate, drill bit and the end of the drill bit clamp is about 30 mm.

5.4.2 The assembly and disassembly of the straight handle drill bit



Fig. a.

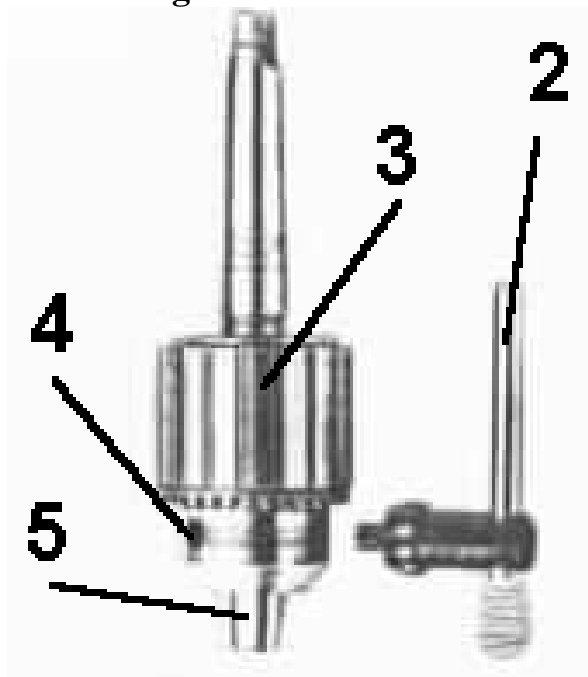

Fig. b.

No.	Term
(1)	Drill bit
(2)	Drill spanner
(3)	Tightening ring
(4)	Hole for drill spanner.
(5)	Drill bit clamp head.

Disassemble the straight drill bit as the following way:

a.	Move away the drilling bit or lift the gearbox to the utmost point.
b.	Power off.
c.	Put on gloves.
d.	Put the drill spanner into the hole for tightening.
e.	Rotate the spanner counter clockwise till the clamp head falls.

Assemble the straight handle drill bit as the following way:

a.	Move away the drilling bit or lift the gearbox to the utmost point.
b.	Power off.
c.	Put on gloves.
d.	Adjust the tightening ring till the drill bit can be inserted.
e.	Insert the drill bit into the clamp head at least 25 mm.
f.	Put the drill spanner into the hole for tightening.
g.	Rotate the spanner clockwise till the drill bit is tightened.

Precaution :

	The drill bit must be inserted at least over 25 mm, otherwise the bit get easily broken or can't drill very precisely.
--	--

5.5 Power on and off.

5.5.1 Power on

- Turn outside main switch to "ON" position.
- Turn the machine power switch to "ON" position.

5.5.2 Power off

- Turn the machine power switch to "OFF" position.
- Turn outside main switch to "OFF" position.

Precaution When at emergency, please press down the emergent stop button to shut down the power supply.

But the emergent stop button can't be used as a switch for normally stopping machine or normal power off.

5.6 Work light

Turn on the work light. Switch the work light to "ON" position.

Turn off the work light. Switch the work light to "OFF" position.



For TPR720.TPR820.TPR920.TPR1100







For TPR1100(二)

5.7 Cutting fluids

Turn on the cutting fluids.	Switch the cutting fluids to "ON" position.
Turn off the cutting fluids.	Switch the cutting fluids to "OFF" position.

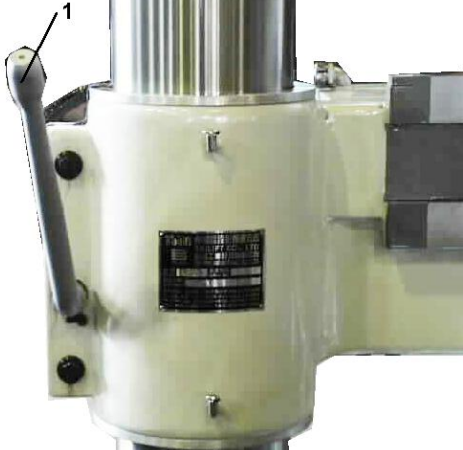
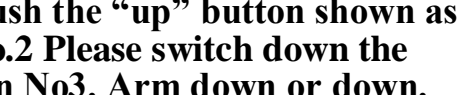
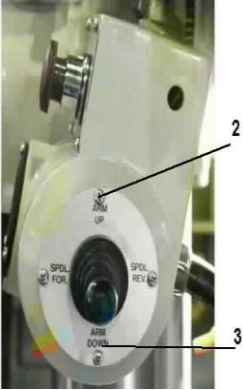

5.8 Elevating the arm.

Steps	Description	Diagrams	
1.	Revolve the arm clamping lever counter clockwise to loosen it as shown in fig. 1.		
2.	Please switch up the “cross switch” or push the “up” button shown as the Picture on the right hand . Shown No.2 Please switch down the “cross switch” or Push the “down”button No.3. Arm down or down.		
			
(For TPR-720A,TPR-820A,TPR-920A)	(For TPR1100)(Type I)	(For TPR1100)(Type I)	(For TPR1100)(Type I)
3.	Revolve the arm clamping lever clockwise to tighten it as shown in fig. 4.		
<p>Precaution You can't either ascend or descend the arm when it is clamped.</p>			

5.9 Rotate the arm right or leftwards.



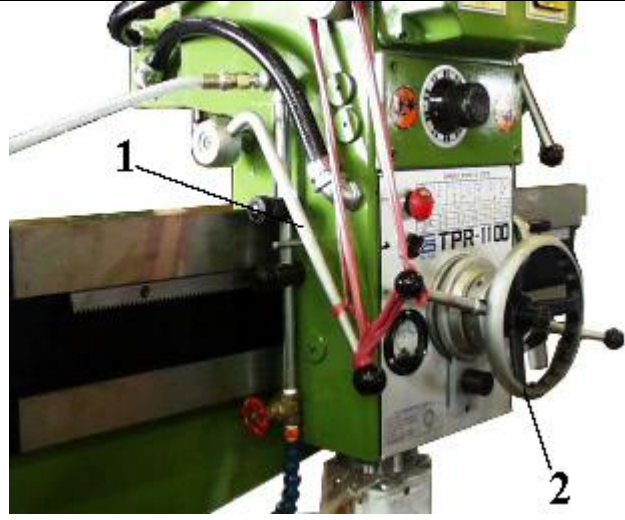

(For TPR-720A, TPR-820A, TPR-920A)



(For TPR-1100)

Steps	Description
1.	Push the head lever downwards to release, as shown in picture 1.
2.	Rotate the hand wheel clockwise to move rightwards and counter clockwise to move leftwards, as shown in picture 2.
3.	Pull the head lever upwards to tighten the head, as shown in picture 1.

5.10 Rotate the arm forward or backwards.

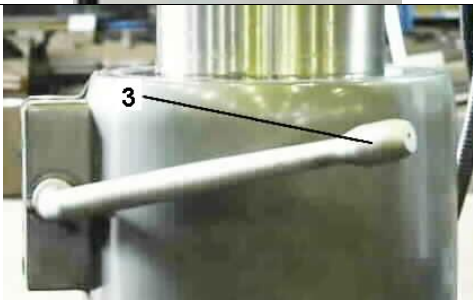
Steps	Description	Diagrams
1.	Rotate the arm clamping lever counter clockwise to release it, as shown in picture 1.	
2.	Push the arm moving lever backwards to move the arm backwards, as shown in picture 2. Pull the arm moving lever towards to move the arm towards, as shown in picture 2.	
3.	Rotate the arm-clamping lever clockwise to tighten the arm-clamping lever, as shown in picture 3.	
Precaution		
If turning 180 degree is needed, the ground base needs to be processed according to the principles of the chapter 3 and fastened with nuts.		

5.11 Change the spindle speed.

Warning :

Spindle temperature will go up making operation in trouble when the spindle speed is set at high rotation mode without movement of the quill. So please do not set the spindle speed at high rotation mode when no movement of the quill.

5.11.1 For TPR-720A, TPR-820A, TPR-920A

I . Speedometer

Two speed change lever (low speed)

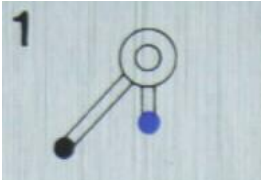
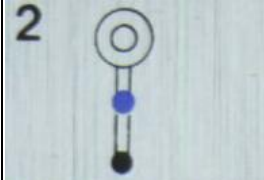
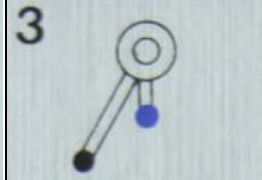
Speed change levels		1 		2 		3 	
		50Hz	60Hz	50Hz	60Hz	50Hz	60Hz
Speed (rpm)		73	88	128	154	234	282
Suitable drilling diameter mm	Mild steel	Ø25-Ø32		Ø19-Ø25		Ø12-Ø19	
	Cast iron	Ø38-Ø50		Ø28-Ø38		Ø22-Ø28	
Threading (metric)		M16-M22		M6-M16		M3-M6	
Suitable automatic feeding step.		1	2	3	1	2	3

Two speed change lever (high speed)

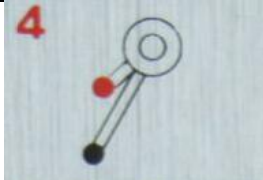
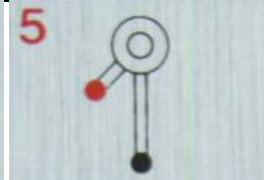
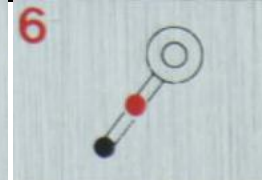
Speed change levels		4 		5 		6 	
		50Hz	60Hz	50Hz	60Hz	50Hz	60Hz
Speed (rpm)		378	455	662	796	1247	1500
Suitable drilling diameter mm	Mild steel	Ø10-Ø12		Ø6-Ø10		Ø3-Ø6	
	Cast iron	Ø19-Ø22		Ø10-Ø19		Ø3-Ø10	
threading(metric)		Not suggested.		Not suggested.		Not suggested.	
Suitable automatic feeding step.		1	2	3	1	2	3

II . Change spindle speed

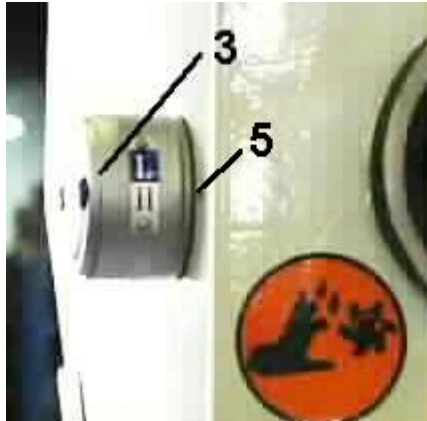

Pic. a.

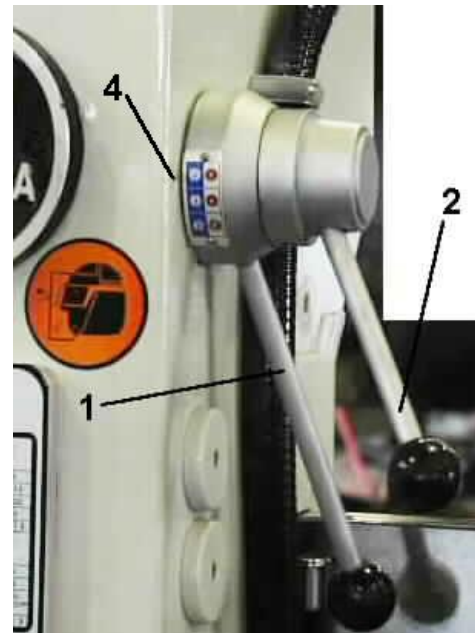

Pic. b.

No.	Term	Description
1.	Three speeds change lever	
2.	Two speeds change lever	High and low speeds change lever.
3.	Indicating ring for high and low speed.	It is to indicate the current speed.
4.	Reference point for the three speeds change lever	It refers to the current position of the three speeds change lever.
5.	Reference point for the two speeds change lever	

III . Change the spindle speed as the following way:

a.	Have spindle rotate.
b.	Look up in the speed table and choose a suitable speed rate.
c.	Turn on the switch for the feed rate.

Precaution when changing speed:

a.	Spindle rotation must be stopped when at changing speed.
b.	Please press down the emergent stop button for safety reason.
c.	Change speed only after the spindle stops completely.

5.11.2 For TPR-1100

I . The speedometer at the time

when the pole switch is in high position.

The position for the pole switch.

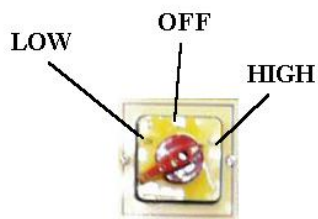

Two speed change lever (low speed)

Speed change levels		1			2			3		
		50Hz	60Hz	50Hz	60Hz	50Hz	60Hz			
Speed (rpm)		74	88	129	154	236	282			
Suitable drilling diameter mm	Mild steel	Ø25-Ø40			Ø19-Ø25			Ø12-Ø19		
	Cast iron	Ø38-Ø55			Ø28-Ø38			Ø22-Ø28		
Threading (metric)		M16-M20			M6-M16			M3-M6		
Suitable automatic feeding step.		1	2	3	1	2	3	1	2	3

Two speed change lever (high speed)

Speed change levels		4			5			6		
		50Hz	60Hz	50Hz	60Hz	50Hz	60Hz			
Speed (rpm)		381	456	665	796	1253	1500			
Suitable drilling diameter mm	Mild steel	Ø10-Ø12			Ø6-Ø10			Ø3-Ø6		
	Cast iron	Ø19-Ø22			Ø10-Ø19			Ø3-Ø10		
threading(metric)		Not suggested.			Not suggested.			Not suggested.		
Suitable automatic feeding step.		1	2	3	1	2	3	1	2	3

II . Change spindle speed

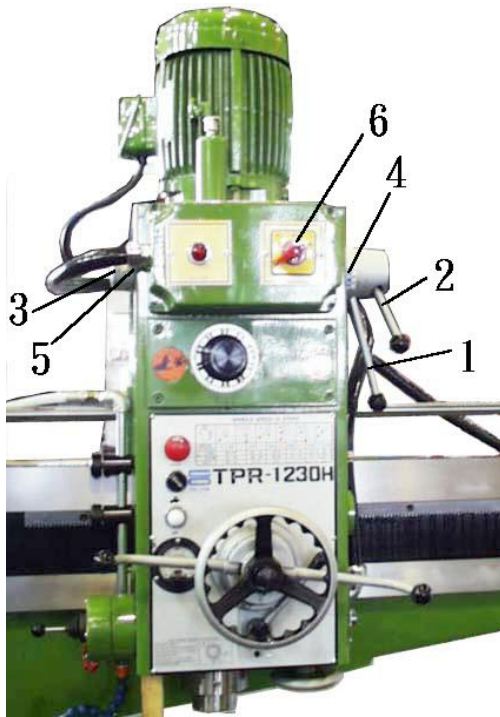

Pic. a.

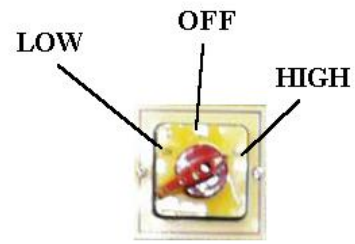

Pic. b.

Label 6 of detail	
Low	If the pole switch to high position, its 8 pole.
OFF	If the pole switch to "OFF" position, the motor can't turn run.
High	If the pole switch in high position, its 4 pole. Normal, switch to high position.

No.	Term	Description
1.	Three speeds change lever	
2.	Two speeds change lever	High and low speeds change lever.
3.	Indicating ring for high and low speed.	It is to indicate the current speed.
4.	Reference point for the three speeds change lever	It refers to the current position of the three speeds change lever.
5.	Reference point for the two speeds change lever	
6.	Pole change switch	

Change the spindle speed as the following way:

- a. Have spindle rotate.
- b. Look up in the speed table and choose a suitable speed rate.
- c. Turn on the switch for the feed rate.

Precaution when changing speed:

- a. Spindle rotation must be stopped when at changing speed.
- b. Please press down the emergent stop button for safety reason.
- c. Change speed only after the spindle stops completely.

**III. The speedometer at the time
when the pole switch is in low position.
The position for the pole switch.**

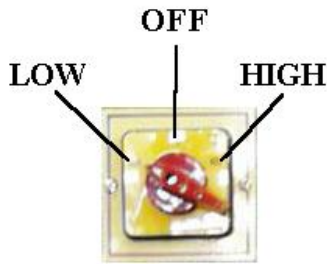

Two speed change lever (low speed)

Speed change levels		1		2		3	
Speed (rpm)		50Hz	60Hz	50Hz	60Hz	50Hz	60Hz
		37	44	64	77	118	141
Suitable drilling diameter mm	Mild steel	Ø25-Ø40		Ø25-Ø40		Ø19-Ø25	
	Cast iron	Ø38-Ø55		Ø38-Ø55		Ø28-Ø38	
Threading (metric)		M16-M20		M16-M20		M6-M16	
Suitable automatic feeding step.		1	2	3	1	2	3
		1	2	3	1	2	3
		1	2	3	1	2	3

Two speed change lever (high speed)

Speed change levels		4		5		6	
Speed (rpm)		50Hz	60Hz	50Hz	60Hz	50Hz	60Hz
		190	228	332	398	626	750
Suitable drilling diameter mm	Mild steel	Ø12-Ø19		Ø10-Ø12		Ø6-Ø10	
	Cast iron	Ø22-Ø28		Ø19-Ø22		Ø10-Ø19	
threading(metric)		M3-M6		Not suggested.		Not suggested.	
Suitable automatic feeding step.		1	2	3	1	2	3
		1	2	3	1	2	3
		1	2	3	1	2	3

5.12 Automatic Feed

5.12.1 Automatic feed rate table

Steps	N	1	2	3
Feed rate	No feed rate	0.05mm/Rev	0.09 mm/Rev	0.15 mm/Rev

5.12.2 Change the feed rate as the following way:

a.	Check the speedometer and choose a suitable rate.
b.	Switch the feed rate.

Precaution when at changing feed rate:

You can change the feed rate only when the spindle is rotating.

5.12.3 Suppose that the work piece is by the machine

The way to move (less than 25 kgs.)

Suppose that the work piece is by the machine, the way to move it is as follows:

1.	Power off.
2.	Put on gloves.
3.	Squat facing the work piece.
4.	Lift the work piece with two hands.
5.	When you are standing up, lift and move the work piece with your feet strength.
6.	Move the work piece toward the worktable.

The way to move (greater than 25 kgs.)

Suppose that the work piece is by the machine, the way to move it is as follows:

1.	Power off.
2.	Put on gloves.
3.	Push the arm backwards.
4.	Move a lifting devise close to the work piece.
5.	Place lifting ropes or slings under the work piece, (please use two ropes or slings). If the work piece has holes for lifting ropes or slings, please lock it with ring head pin, then lift and move it with a hook.
6.	Move the work piece toward the worktable.

5.12.4 How to preset the depth of the power-feed?

I .(For TPR-720A, TPR-820A, TPR-920A)

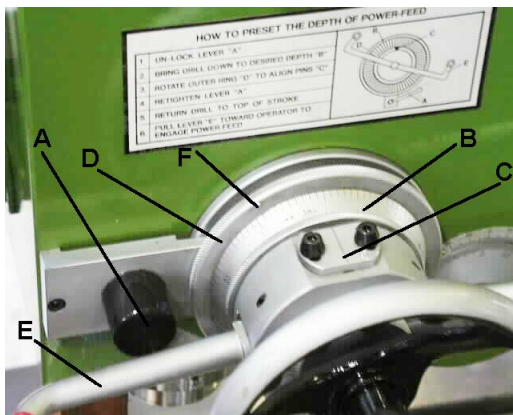

The relevant terms

NO.	Term
A	Depth controlling and fixing lever.
B	Main dial
C	Clutch adjusting block
D	Depth-setting ring
E	Feed trip lever
F	Depth reference point.

Preset the depth of the power-feed:

a.	Rotate the feed trip lever counter clockwise as shown in picture E till The drill bit contact the work piece. (At this moment, B and C shown in the pictures move simultaneously. That's the depth is zero when the bit is contacting the work piece and the dial is also at the zero position.)
b.	Release the fixing lever of the main dial. That's to release A shown in the picture.
c.	Rotate the depth setting ring as shown in picture D, referring to the depth point on the ring. To set the drilling depth is to adjust and align the gauge on the ring as shown in the picture B.
d.	Clamp the fixing lever of the main dial. That's to clamp A shown in the picture.
e.	Release the feed trip lever as shown in the picture E.
f.	Rotate the feed trip lever a little bit counter clockwise, as shown in the picture E.
g.	Turn the spindle switch to "SPDL. FOR".
h.	Pull the feed trip lever backwards as shown in the picture E, The spindle will feed at the chosen rate and stop.

Example : How to preset a depth of 30mm?

a.	Rotate E as in the picture till it contacts the work piece.
b.	Release A, as shown in the picture.
c.	Rotate D and align F as shown in the picture to the position of 30 mm on the B, as shown in the picture.
d.	Clamp A, as shown in the picture.
e.	Release E, as shown in the picture.
f.	Rotate E in the picture a little bit counter clockwise.
g.	Turn the spindle switch to SPDL. FOR
h.	Pull the feed trip lever as shown in the picture E backwards.

Precaution

a.	Auto feed will move only after the feed rate is set up.
b.	Auto feed is used only in drilling, not in threading.

II.(For TPR-1100)

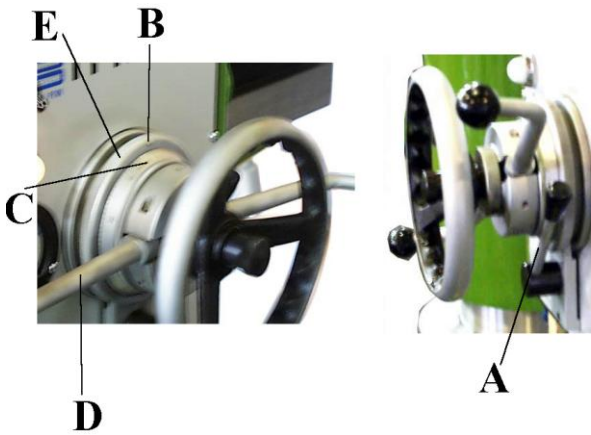

The relevant terms	
NO.	Term
A	Depth controlling and fixing lever.
B	Depth reference point.
C	Main dial
D	Feed trip lever
E	Depth-setting ring

Preset the depth of the power-feed:

a.	Rotate the feed trip lever counter clockwise as shown in label D till The drill bit contact the work piece. (At this moment, label B shown in the pictures move simultaneously. That's the depth is zero when the bit is contacting the work piece and the dial is also at the zero position.)
b.	Release the fixing lever of the main dial. That's to release label A shown in the picture.
c.	Rotate the depth setting ring as shown in label E, referring to the depth point on the ring label B. To set the drilling depth is to adjust and align the gauge on the ring as shown in the label C.
d.	Clamp the fixing lever of the main dial. That's to clamp label A shown in the picture.
e.	Release the feed trip lever as shown in the label D.
f.	Rotate the feed trip lever a little bit counter clockwise, as shown in the label D.
g.	Turn the spindle switch to "SPDL. FOR".
h.	Pull the feed trip lever backwards as shown in the label D, The spindle will feed at the chosen rate and stop

Example : How to preset a depth of 30mm?

a.	Rotate D as in the picture till it contacts the work piece.
b.	Release A, as shown in the picture.
c.	Rotate E and align C as shown in the picture to the position of 30 mm on the B, as shown in the picture.
d.	Clamp A, as shown in the picture.
e.	Release D, as shown in the picture.
f.	Rotate D in the picture a little bit counter clockwise.
g.	Turn the spindle switch to SPDL. FOR
h.	Pull the feed trip lever as shown in the picture D backwards.

Precaution

a.	Auto feed will move only after the feed rate is set up.
b.	Auto feed is used only in drilling, not in threading.

5.13 The spindle

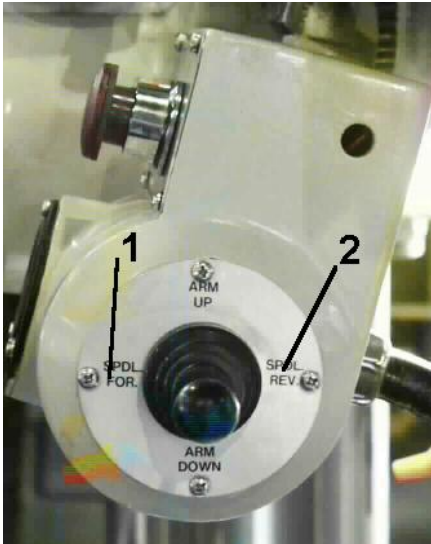

(For TPR-720A, TPR-820A, TPR-920A)



(For TPR-1100) (Type I)



(For TPR720A, TPR820A, TPR920A, TPR-1100) (Type II)

1.	Please turn on the main switch of the machine , and then lower down the Quill by 5 mm , so that the forward/reverse of the main spindle can start.
2.	The main spindle will forward when switching to SPDL.FOR.
3.	If you want to stop the rotating of the spindle, please switch to the middle Position.
4.	The main spindle will reverse when switching to SPDL.FOR.

5.14 Threading

The way to thread is as follows :

a.	Clamp the screw tap with drilling head.
b.	Move the spindle to the top of the threading.
c.	Set the feed rate at "N" °
d.	Rotate the feed trip lever a little bit counter clockwise.
e.	After the cross switch turned to "SPDL.FOR", the spindle spins clockwise.
f.	Rotate the feed trip lever counter clockwise till the threading is finished. (The operator decides the threading depth.)
g.	After the cross switch turned to "SPDL.REV.", let the spindle turn counter clockwise till the screw tap retreats completely.
h.	Turn the cross switch to the middle to stop the spindle.

5.15 The assembly and disassembly of the work table.

Disassemble it as follows:

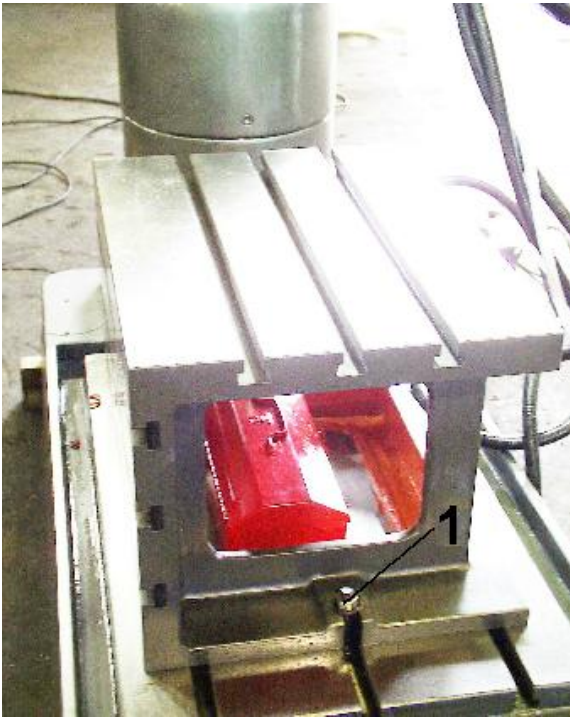

1.	Release 1, as shown in the picture, using a spanner. That's to move the spanner counter clockwise.
2.	Apply the above to the other side.

Assembly it as follows:

1.	Clean the debris from the base with a metal brush.
2.	Clean the worktable and the base with rags.
3.	Place T shape Bolts into the T shape chamfer of the base.
4.	Tighten the nuts.

5.16 Cutting fluids for all kinds of material.

Soft steel	crude oil 、 animal fat
Mild steel	crude oil 、 animal fat
High carbon steel	crude oil 、 animal fat
Stainless steel	crude oil 、 animal fat
Manganese steel	crude oil 、 animal fat
Cast iron	Without
Malleable cast iron	Crude oil
Brass, bronze	Kerosene
Aluminum and alloy	Kerosene

Precaution

When cutting fluids is not applied, Having the turning speed and the feed rate reduced is the only way to extend the tool life. If cutting fluids leaks or injects to the aisle, please clean it immediately from the floor.

CHAPTER 6

Adjustment

6.1 General

Adjustment is needed after the machine has been used a period of time for its parts will get loose or worn out, In the radial drill, there are three parts needed to be adjusted. One is the arm clamping lever, another the gap between the gearbox and the arm rail, finally the engagement between the feed trip lever and the clutch and Maximum Range for spindle adjustment.

6.2 The arm clamping lever

After the machine has been used for about 3-5 years, the position of the arm clamping lever will be descending. It is the time to adjust the position of the arm clamping lever.

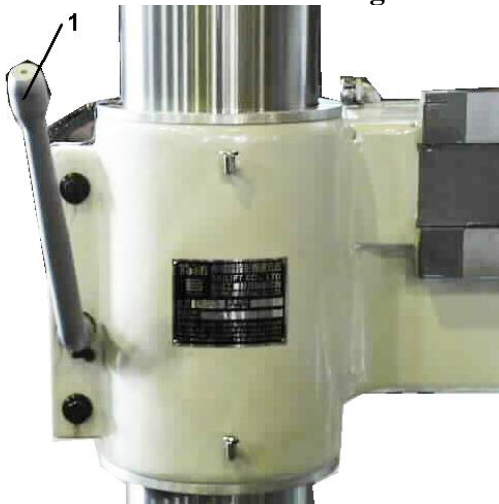

Pic. a.

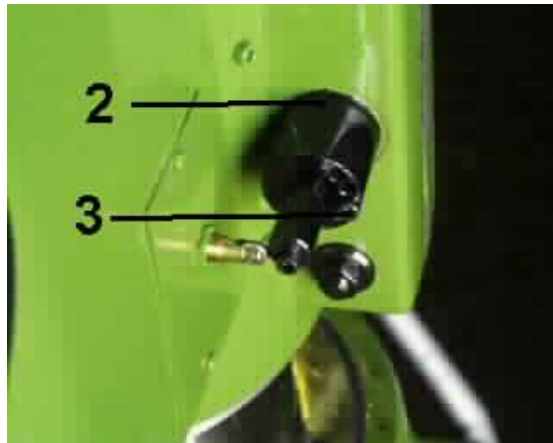

Pic. b.

No.	Term
1.	The arm clamping lever
2.	The nuts for adjusting the lever.
3.	Fixing bolts

Adjust the arm clamping lever as follows:

a.	Power off.
b.	Press down the emergent stop button.
c.	Release the arm clamping lever.(as no. 1 in the pic. a)
d.	Release the fixing bolts (as No. 3 in the pic. b.
e.	Rotate the arm adjusting nuts one turn clockwise. (as No. 2 in pic. b.)
f.	Tighten the fixing bolts (as No. 3 in the pic. b.
g.	Tighten the arm clamping lever. (as No. 1 in the pic. a.

6.3 The gap adjustment between the gearbox and the arm rail

After the machine has been used a period of time, the gap between the gearbox and the arm rail appears. It is the time to adjust its tightness between the arm rail and crank shaft bearing.

6.3.1 (For TPR-720A, TPR-820A, TPR920A)



- a. Dismantle the metal cover, as shown in the picture 1.

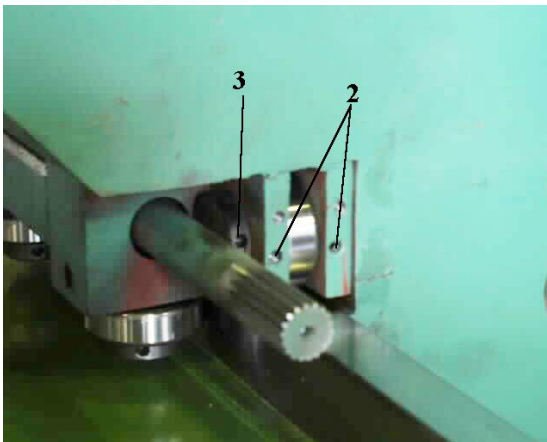

- b. Release the bolts as shown in the picture 2.

Using a hex wrench, insert it into the hole as shown in the pic. 3 and rotate it till that you can easily turn the hand wheel of the gearbox but can't move it without any force. Apply the same to the opposite site.

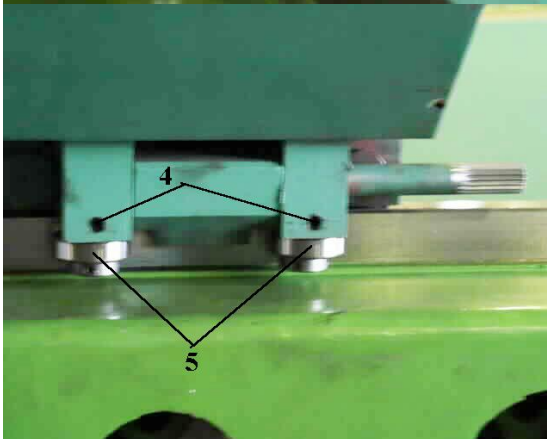

- c. Release the bolts as shown in the picture 4.

Using a hex wrench, insert it into the hole as shown in the pic. 3 and rotate it till that you can easily turn the hand wheel of the gearbox but can't move it without any force. Apply the same to the opposite site.

6.3.2 (For TPR-1100)

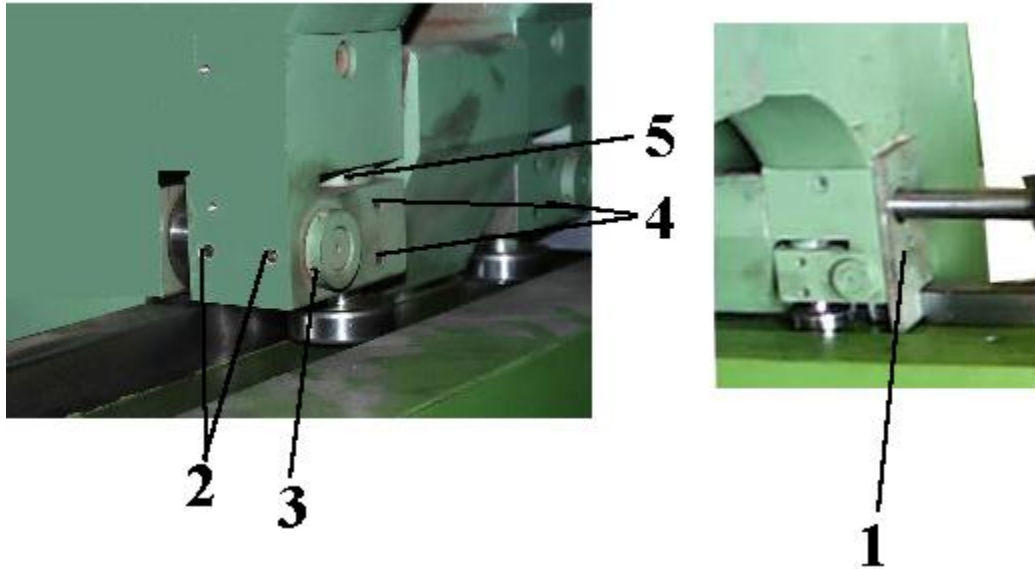

a.	Remove the side plate as the above figure 1.
b.	Release the bolts as the above figure 2. Using socket wrench, insert it into the holes as shown in the above figure 3 and rotate them. Apply the tightness as the hand wheel of the Gearbox can be turned easily but not too easily. Apply the same to the counter side.
c.	Release the bolts as shown in the right figure 4.
d.	Using socket wrench, insert it into the holes as shown in the above figure 5 and rotate them. Apply the tightness as the hand wheel of the Gearbox can be turned easily but not too easily. Apply the same to the counter side.
e.	Screw up the side plate of the above figure 1.

6.4 Adjust the engagement between the feed trip lever and the clutch

After the machine has been used a period of time, gap between the feed trip lever and the clutch will appear. It is then the time to adjust the engagement between the feed trip lever and the clutch.

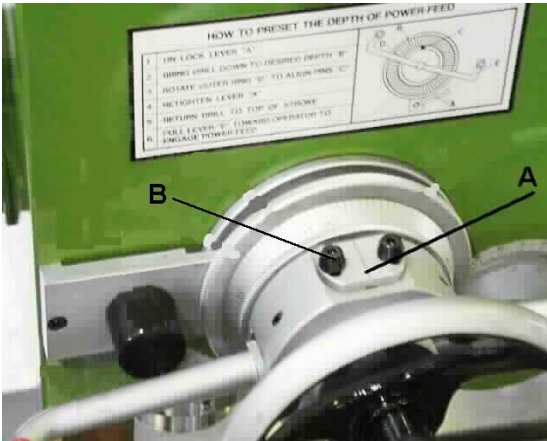

a.	Release the bolts B as shown in the right picture.
b.	Push the adjusting block forwards, using a hex wrench, as shown in the right picture.
c.	Tighten the bolts B as shown in the right picture.

6.5 Maximum Range for spindle adjustment

(For TPR-720A, TPR-820A, TPR-920A)

When you find the spindle adjustment range for maximum and minimum are different or you change the spring seat, please readjust the clearance for the spindle 3 to 5 mm to prevent the spare part get damage.

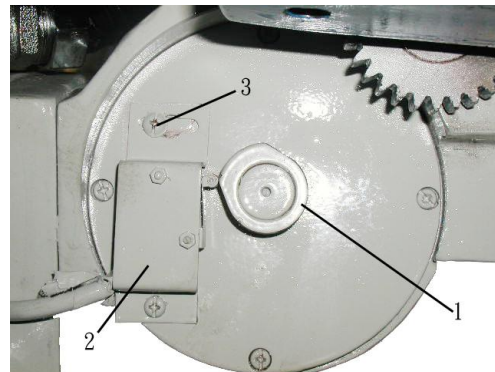
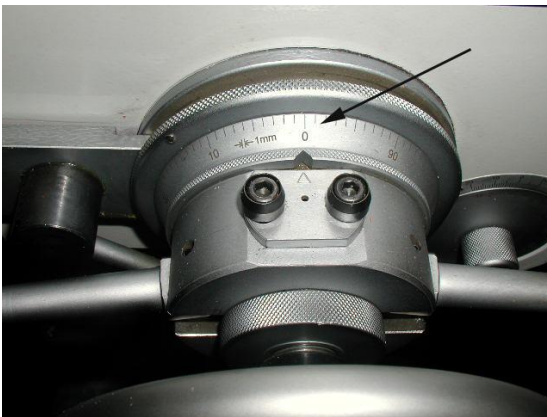

- In the left photo you will see the spindle graduation.
- First rotate the spindle to the upper maximum position. Let it has 3 to 5mm clearance. See the right photo. Rotate the CAM 1 to touch the limit switch 2. Second rotate the spindle to the lower minimum position. Let it has 3 to 5mm clearance. Tighten the CAM fix screw and screw 3.
- Rotate the CAM to touch the limit switch slowly. When you hear the crack noise, you can tighten the screw.

CHAPTER 7

Maintenance

7.1 General

Whether the machine is maintained well or not will lead to its long or short life. If well served, the machine lasts long and is easy to maintain.

7.2 Daily Maintenance.

7.2.1 Clearing

Only one person is allowed to do the clearing. Before clearing, please power off.

7.2.2 Please clean every parts using a metal brush and a rag, dipped with oil, to rub them.

(Please use CC68) After every day's work, please proceed the following maintenance.

I . (For TPR-720A, TPR-820A, TPR-920A)

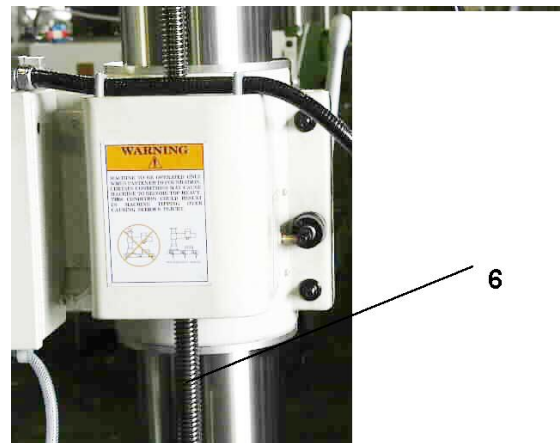
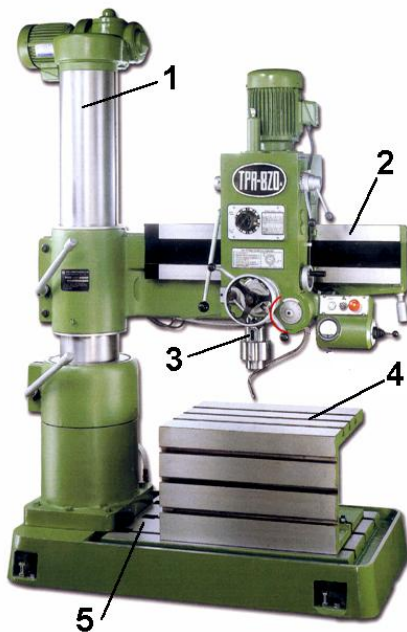

No.	Parts
1.	Column
2.	The arm rail
3.	Spindle
4.	Work table
5.	The base
6.	The ball screw

II. (For TPR-1100)



No.	Parts
1.	Column
2.	The arm rail
3.	Spindle
4.	Work table
5.	The base
6.	The ball screw

7.2.3 The way to clean iron filings:

1.	Power off.
2.	Put on gloves.
3.	Clean from upside down using a brush.
4.	When the iron filings comes down to the base, please collect it and put it at the right side of the operation position.
5.	Find a dustpan and place it under the machine.
6.	Sweep it to the dustpan using the brush.
7.	Rub every part of the machine with rags, particularly the parts where is contaminated with the cutting fluids.
8.	Rub every metal part of the machine using a oil-dipped rags.

7.2.4 Lubrication

Before every day's work, please proceed the following maintenance.

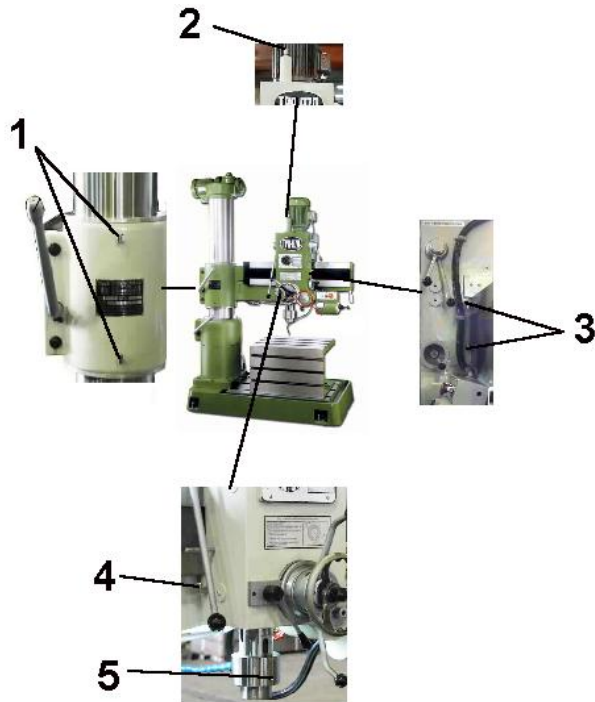

(For TPR-720A, TPR-820A, TPR-920A)



(For TPR-1100)

No.	Part	Oil type	Volume
1.	Oil filler points of the column	CC68	Full
2.	Oil filler points on top of the gearbox.	CC68	Full
3.	Oil filler points in the right side of the gearbox.	CC68	Full
4.	Oil filler points in the left side of the gearbox.	CC68	Full
5.	Oil filler points of the spindle.	XM2	Full

7.2.5 Change oil inside of the speed reduction of the arm elevating motor.

It requires only one person to do it. Please press down the emergent stop button and power off before proceeding the job.

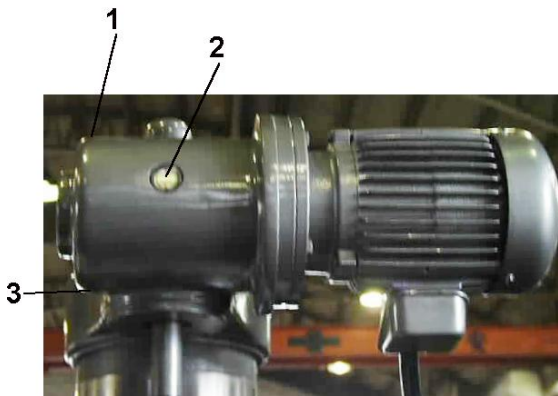

(For TPR-720A, TPR-820A, TPR-920A)

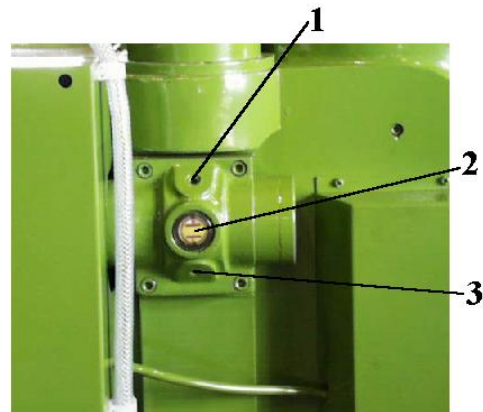

(For TPR-1100)

Instruction to the relevant parts.

1.	Oil filler points	It is the open where oil is added after the oil in the container isn't enough or needs to be replaced.
2.	Oil gauge	The volume of the oil is visible here. Generally, The oil level should be between the upper and the lower lines. If it reaches the lower limit, oil needs to be added, at the utmost to its upper line, but not over it.
3.	Drain outlet	It is to drain the oil when oil is to be replaced.

The following is the Tool to replace the oil.

Oil 2(CC68) L

Container and spanner.

The steps:

1.	Power off.
2.	Press down the emergent stop button.
3.	Place the container under the drain outlet.
4.	Release the drain plug using a spanner.
5.	After draining, tape the plug with a sheet of band and tighten it back to the drain outlet.
6.	Release the oil filler plug.
7.	Add oil to the upper limit of the oil gauge.
8.	Tighten the oil filler plug.

7.2.6 Chang the oil inside the gearbox.

It calls for only one person to do it. Please power off and press down the emergent stop button before carrying out the job.

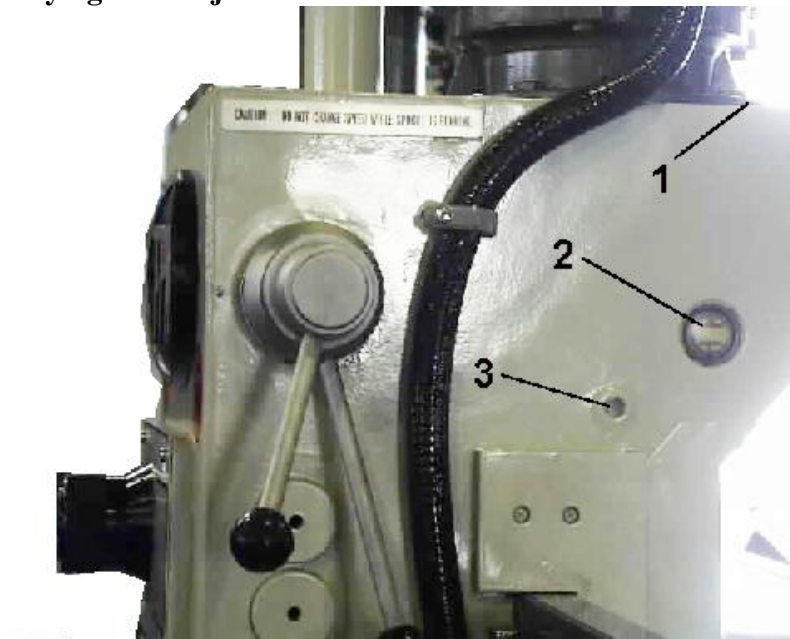

Instruction to the relevant parts.

1.	Oil filler points	It is the open where oil is added after the oil in the container isn't enough or needs to be replaced.
2.	Oil gauge	The volume of the oil is visible here. Generally, The oil level should be between the upper and the lower lines. If it reaches the lower limit, oil needs to be added, at the utmost to its upper line, but not over it.
3.	Oil drain outlet	It is to drain the oil when oil is to be replaced.

The following is the Tool for replacing the oil.

Oil (CC68) 4.5 L

Container and spanner

The Steps :

1.	Power off.
2.	Press down the emergent stop button.
3.	Place a container under the oil drain outlet.
4.	Release the drain plug using a spanner.
5.	After draining, tape the plug with a sheet of band and tighten it back to the drain outlet.
6.	Release the oil filler plug.
7.	Add oil to the upper limit of the oil gauge.
8.	Tighten the oil filler plug.

7.3 Replace the cutting fluids.

It requires only one person to do it. Please power off and press down the emergent stop power button before carrying out the job.



Instruction to the relevant parts.

1.	Oil filler points	It is the open where the cutting fluids are added when it recycles, or isn't sufficient or needs to be replaced.
2.	Oil drain outlet	It is the outlet where the cutting fluids are drained.

The following is the Tool to replace the cutting fluids.

The cutting fluids 30L
Container and spanner

The steps :

1.	Power off.
2.	Press down the emergent stop button.
3.	Place a container under the oil drain outlet.
4.	Release the drain plug using a spanner.
5.	After draining, tape the plug with a sheet of band and tighten it back to the drain outlet.
6.	Refill the cutting fluids through the oil filler inlet to the level under 5 mm under the oil filter.

7.4 Maintenance and replacement period.

No.	Position	Items.	Period
1.	Oil filler points of the column.	CC68	Once per day.
2.	Oil filler points on top of the gearbox.	CC68	Once per day.
3.	Oil filler points in the right side of the gearbox.	CC68	Once per day.
4.	Oil filler points in the left side of the gearbox.	CC68	Once per day.
5.	Oil filler points of the spindle.	XM2	Once per day.
6	Replace oil for the speed reduction of the arm elevating motor.	CC68	Once per year.
7	Change oil inside of the gearbox.	CC68	Once per year.
8	Change the cutting fluids.	The cutting fluids	Once per month.
9	The arm transmission ball screw	XM2	Once per month

A suitable Oil Type comparison:

ISO DIS-3498	SHELL	MOBIL	ESSO	CHINA
CC68	OMALA 68	MOBILGEAR 620	SPARTAN EP68	HD68
XM2	ALVANIA R2	MOBILUX 2	BEACON 2	#2

7.5 Waste disposition.

Please proceed waste disposition such as machine oil, iron filings, old machine or replaced parts according to your country's relevant legal regulation.

CHAPTER 8

Troubleshooting

8.1 The spindle overloads and the relay jumps.

8.1.1 The cause.

- a. The drill bit is too big.
- b. The feed rate is too fast.
- c. Operation not in compliance with speedometer and the automatic feed rate table.
- d. The fuse burned out.
- e. The voltage is too low.

8.1.2 The solution

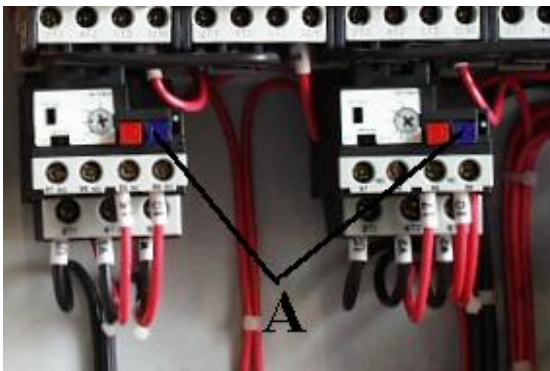

a.	Power off.
b.	Open the control box.
c.	Press the relay switch to open, as shown in the right picture, three minutes after the spindle stops. (blue Button)
d.	Close the control box.
e.	Power on.

8.2 The spindle overloads and the fuse burns out.

8.2.1 The cause

- a. The drill bit is too big.
- b. The feed rate is too fast.
- c. Operation not in compliance with speedometer and the automatic feed rate table.

8.2.2 The solution.



a.	Power on.
b.	Open the control box.
c.	Replace the fuse as shown in the picture A.
d.	Close the control box.
e.	Power on.

8.3 What if the drill bit get broken ?

- a. Stop the spindle.**
- b. Press down the emergent stop button.**
- c. Push the gearbox backwards.**
- d. Pinch the end of the broken bit with a pliers.**
- e. Rotate counter clockwise and pull it out upwards.**

8.4 What if the screw tap get broken?

- a. Stop the spindle.**
- b. Press down the emergent stop button.**
- c. Using thread releaser, rotate the screw tap counter clockwise till it comes out. If it is impossible to pull it out, you may think to melt it out with EDM or declare it unusable.**

8.5 How if a person is entangled?

- a. Press down the emergent stop button.**
- b. Power off.**
- c. Switch the speed change lever to the highest gear.**
- d. Rotate the spindle with hands counter clockwise (if the spindle moved clockwise before, then its reverse direction is counter clockwise now) till that the person is free from the machine.**

CHAPTR 9 Annex

9.1 Electrical circuit diagram (For TPR720A,TPR820A,TPR920A CE Standard)

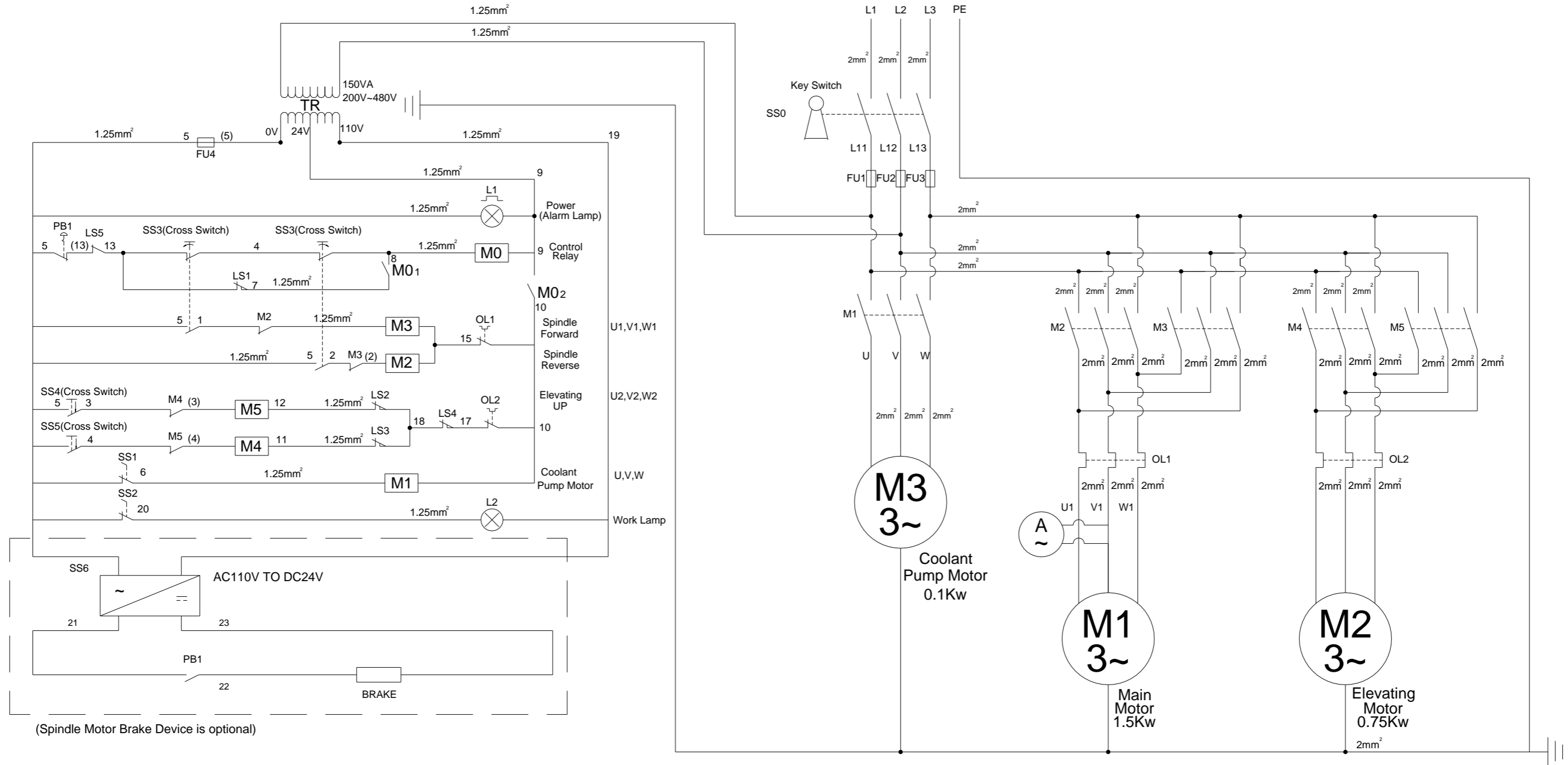



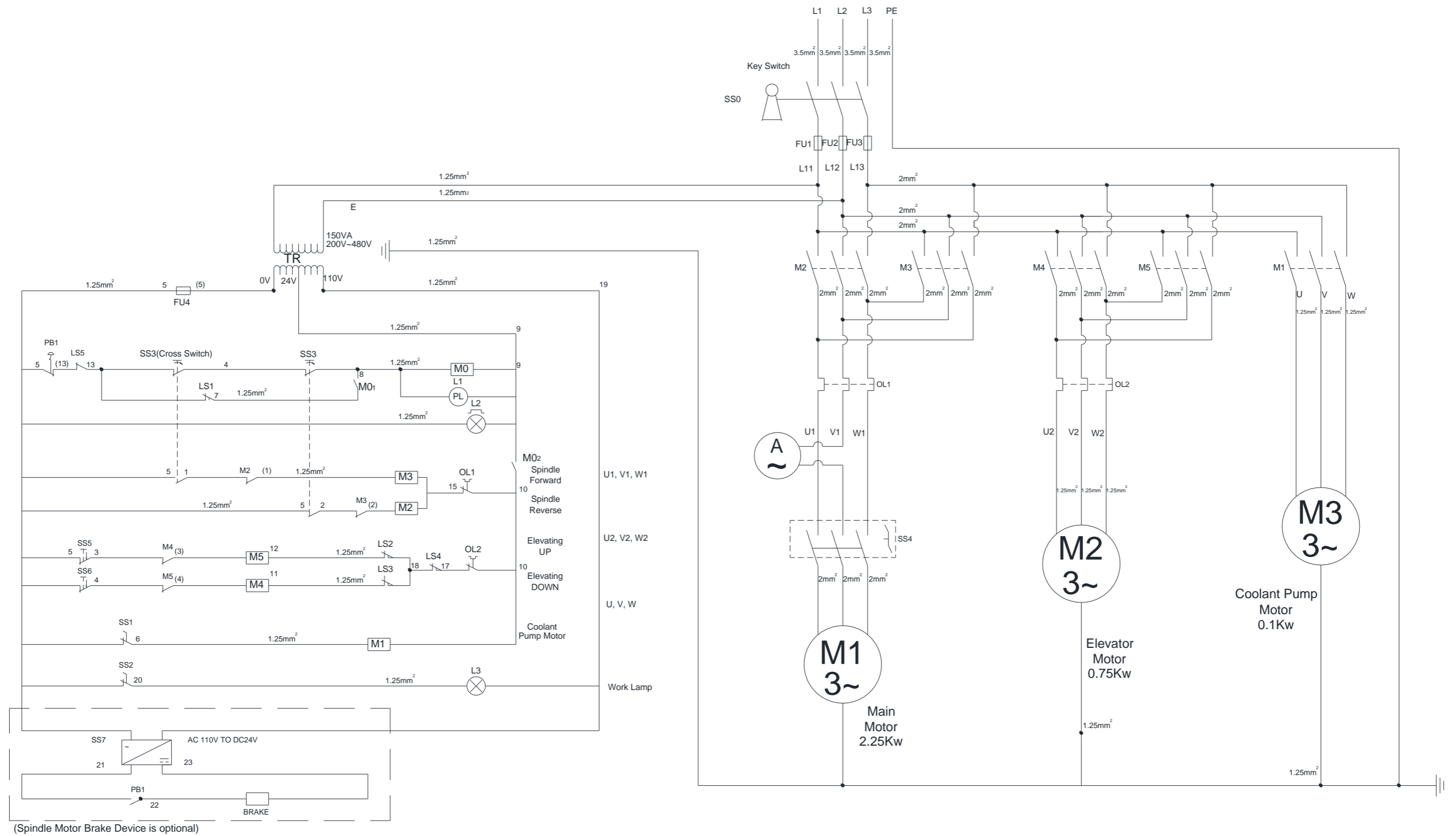



**9.2 Electrical circuit diagram
(For TPR-1100 CE Standard)**

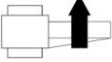
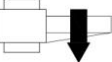

9.3 Electrical main parts list



(For TPR-720A, TPR-820A, TPR-920A CE Standard)







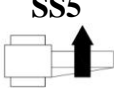
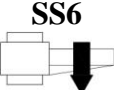

Part NO.	Symbol	Description	Specification	Q'ty	Remark
E1602004	SS0 	Key Switch	COD TF323	1	
E0703004	M1	Magnetic Contact	CU11 3a1b AC24V	1	
E0703004	M2	Magnetic Contact	CU11 3a1b AC24V	1	
E0703004	M3	Magnetic Contact	CU11 3a1b AC24V	1	
E0703004	M4	Magnetic Contact	CU11 3a1b AC24V	1	
E0703004	M5	Magnetic Contact	CU11 3a1b AC24V	1	
E0703004	M0	Magnetic Contact	CU11 3a1b AC24V	1	
E3101023	Fu1、Fu2、Fu3	Fuse	10*38*16A	1	For380V~480V
E3101028	Fu1、Fu2、Fu3	Fuse	10*38*32A	1	For200V~240V
E3101025	FU4	Fuse	10*38*6A	1	
E3101019	FU4	Fuse Seat	10*38	1	
	TR	Transformer	150VA 1:0,220,380 2:0,24,110	1	Optional
E1302004	SS1 	Selector Switch	Ø22 1A1B	1	
E1604001	SS2	Selector Switch	SN1021	1	
E0901021	SS3	Basic Switch	V-15-1E5	4	
E1202022	SS4 	Push Button	ZB4-BA2+ZB4-BZ101	1	
E1202023					
E1202022	SS5 	Push Button	ZB4-BA2+ZB4+BZ101	1	
E1202023					
E3501002	SS6	Power Supply	S-50-24	1	Optional
E1203001	PB1	Emg. Push Button Switch	Ø30 1A1B	1	
E0207054	OL1	Overload Relay	RHU-10/3.5-4.8	1	For380V~480V
E0207053	OL2	Overload Relay	RHU-10/1.8-2.5	1	For380V~480V
E0207055	OL1	Overload Relay	RHU-10/5.5-7.5	1	For200V~240V
E0207054	OL2	Overload Relay	RHU-10/3.5-4.8	1	For200V~240V
E0901021	LS1	Basic Switch	V-15-1E5	1	
E0901014	LS2	Micro Switch	1308	1	
E0901014	LS3	Micro Switch	1308	1	
E0901014	LS4	Micro Switch	1308	1	
E0901006	LS5	Micro Switch	1309	1	Optional
E3602003		AMP meter	S065 10A	1	For380V~480V
E3602002		AMP meter	S065 20A	1	For200V~240V
E2305002	L1 	Power (Alarm Lamp)	Ø22 24V(W)	1	
E1701002	L2 	Work Lamp	FS 51441 110V	1	

Part NO.	Symbol	Description	Specification	Q'ty	Remark
	Ⓜ ₁ 3~	Main Motor	1.5KW 200/400V/4P/3PH	1	Optional
	Ⓜ ₂ 3~	Elevating Motor	0.75KW 200/400V/4P/3PH	1	Optional
	Ⓜ ₃ 3~	Coolant Pump Motor	0.1KW 200/400V/2P/3PH	1	Optional

9.4 Electrical main parts list

(For TPR-1100 CE Standard)

Part NO.	Symbol	Description	Specification	Q'ty	Remark
E1602004	SS0 	Key Switch	COD TF323	1	
E0703004	M1	Magnetic Contact	CU11 3a1b AC24V	1	
E0703005	M2	Magnetic Contact	CU18 24V	1	
E0703005	M3	Magnetic Contact	CU18 24V	1	
E0703004	M4	Magnetic Contact	CU11 3a1b AC24V	1	
E0703004	M5	Magnetic Contact	CU11 3a1b AC24V	1	
E0703004	M0	Magnetic Contact	CU11 3a1b AC24V	1	
E3101023	Fu1・Fu2・Fu3	Fuse	10*38*16A	3	For380V~480V
E3101028	Fu1・Fu2・Fu3	Fuse	10*38*32A	3	For200V~240V
E3101025	FU4	Fuse	10*38*6A	1	
E3101019	FU4	Fuse Seat	10*38	1	
	TR	Transformer	150VA 1:0,220,380V 2:0,24,110V	1	Optional
E1303002	SS1 	Selector Switch	Ø30 1A1B	1	
E1604001	SS2	Selector Switch	SN1021	1	
E0901021	SS3	Basic Switch	V-15-1E5	4	
E1605001	SS3	Cross Switch	UP:1A,Down:1A,LEF T:1A1B,RIGHT:1A1B	1	
E1603001	SS4	Change Switch	A441CA10	1	
E1202022 E1202023	SS5 	Push Button	ZB4-BA2+ZB4-BZ101	1	
E1202022 E1202023	SS6 	Push Button	ZB4-BA2+ZB4-BZ101	1	
E3501002	SS7	Power Supply	S-50-24	1	Optional
E1203001	PB1	Emg. Push Button Switch	Ø30 1A1B	1	
E0207056	OL1	Overload Relay	RHU-10/9-12.5	1	For380V~480V
E0207053	OL2	Overload Relay	RHU-10/1.8-2.5	1	For380V~480V
E0207057	OL1	Overload Relay	RHU-10/11.3-16	1	For200V~240V
E0207054	OL2	Overload Relay	RHU-10/3.5-4.8	1	For200V~240V
E0901006	LS1	Micro Switch	1309	1	
E0901014	LS2	Micro Switch	1308	1	
E0901014	LS3	Micro Switch	1308	1	
E0901034	LS4	Micro Switch	MN-5311(TZ7311)	1	
E0901006	LS5	Micro Switch	1309	1	Optional

Part NO.	Symbol	Description	Specification	Q'ty	Remark
E2305001	L1 	Pilot	Ø30 24V(W)	1	
E2305001	L2 	Power (Alarm Lamp)	Ø30 24V(W)	1	
E1701002	L3 	Work Lamp	FS 51441 110V	1	
E3602002		AMP meter	S065 20A	1	For380V~480V
E3602001		AMP meter	S065 30A	1	For200V~240V
		Main Motor	2.25KW 200/400V/4P/3PH	1	Optional
		Elevating Motor	0.75KW 200/400V/4P/3PH	1	Optional
		Coolant Pump Motor	0.1KW 200/400V/2P/3PH	1	Optional

9.5 Earth System Diagram

(For TPR720A,TPR820A,TPR920A,TPR1100A CE Standard)

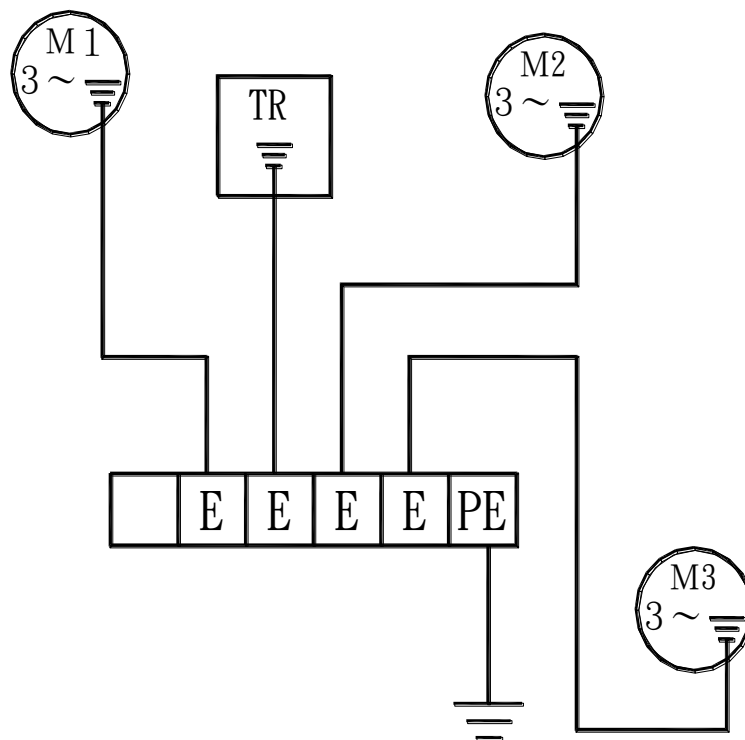

9.6 Electrical Circuit Diagram

(For TPR720A, TPR820A, TPR920A Standard 24V)

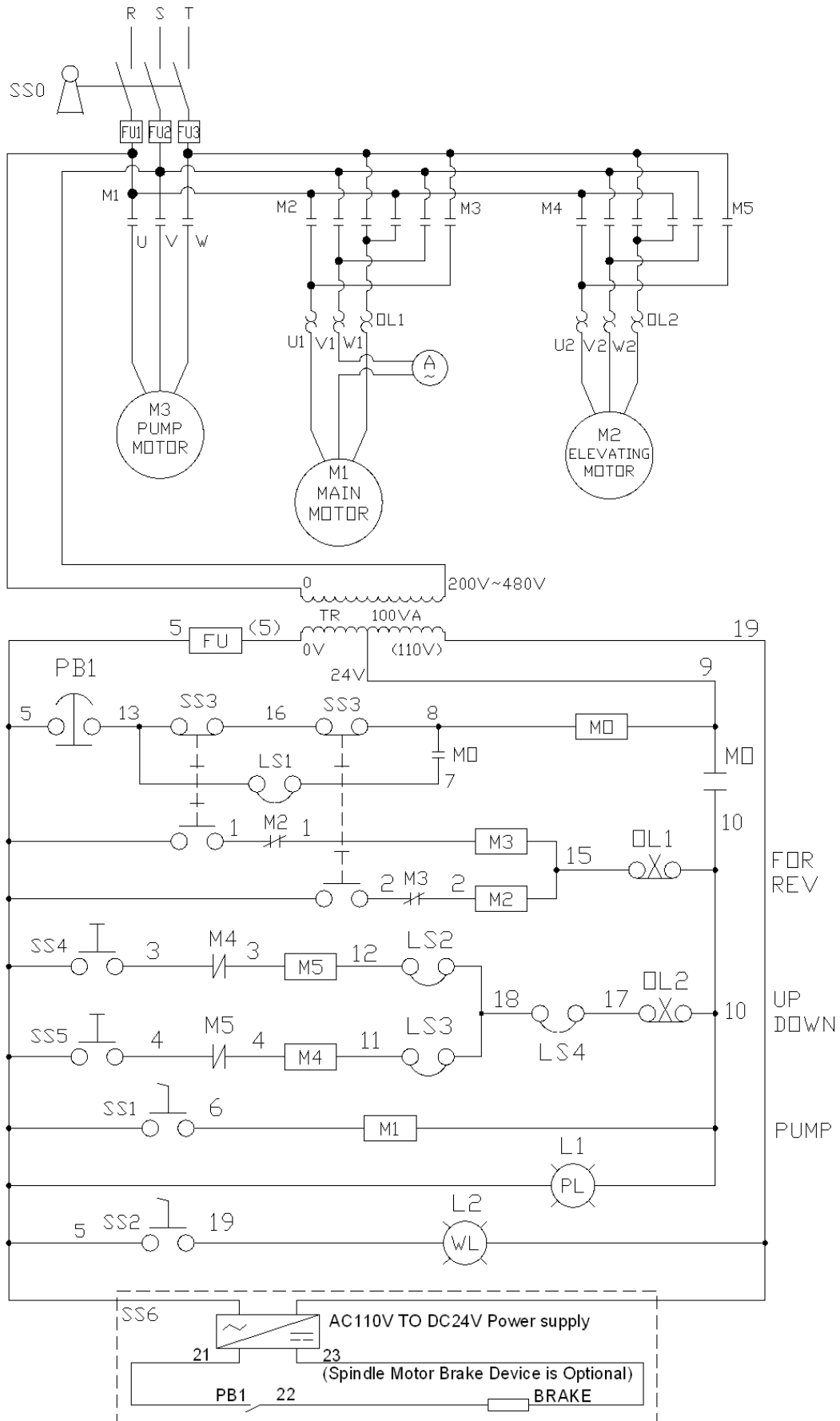





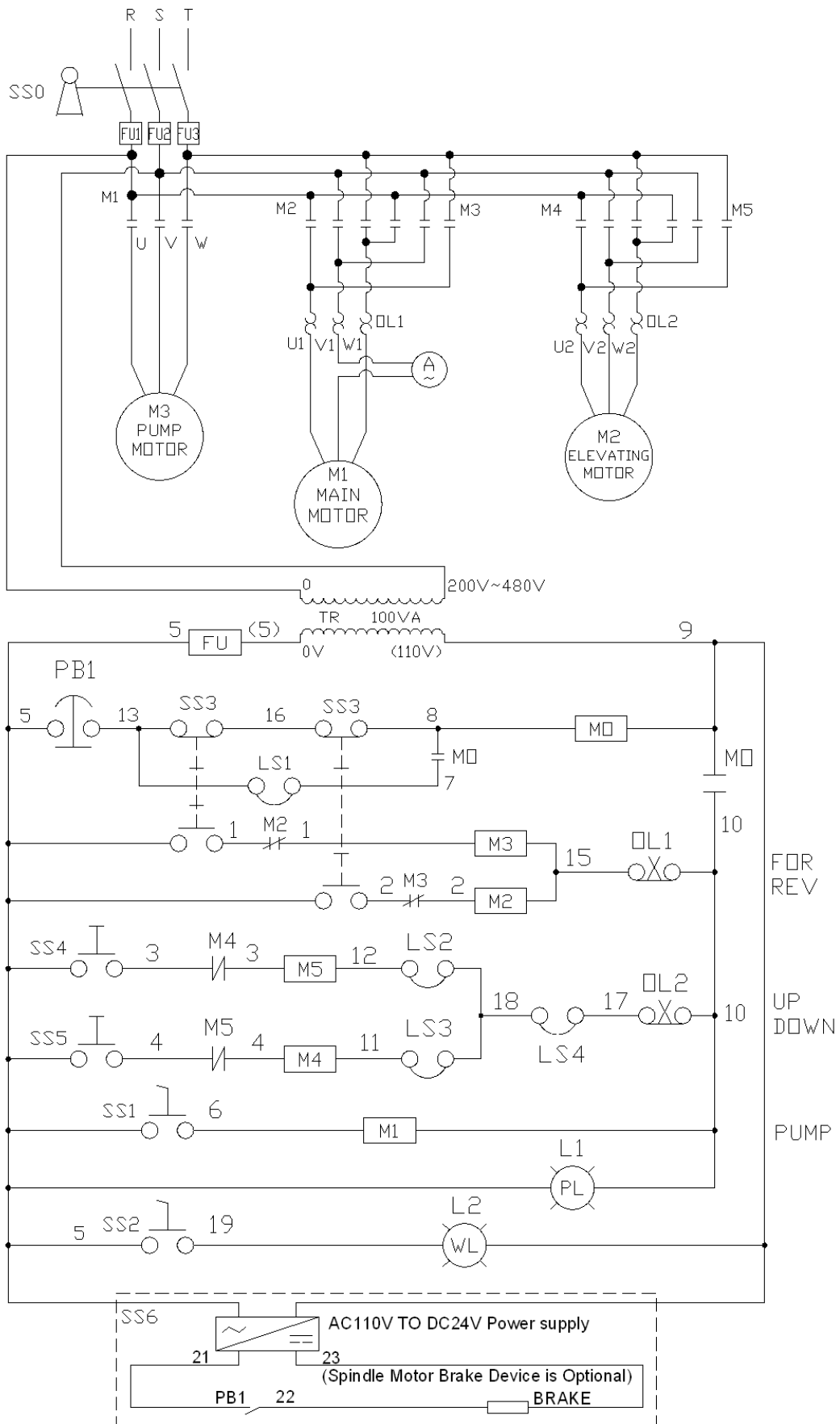



9.7 Electrical Circuit Diagram

(For TPR720A, TPR820A, TPR920A Standard 110V)

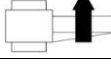

9.8 Electrical main parts list

(For TPR-720A, TPR-820A, TPR-920A Standard)

Part NO.	Symbol	Description	Specification	Q'ty	Remark
E1602004	SS0 	Key Switch	COD TF323	1	Optional
E0701020	M1	Magnetic Contact	CU11 3a1b AC110V	1	Standard
E0701020	M2	Magnetic Contact	CU11 3a1b AC110V	1	Standard
E0701020	M3	Magnetic Contact	CU11 3a1b AC110V	1	Standard
E0701020	M4	Magnetic Contact	CU11 3a1b AC110V	1	Standard
E0701020	M5	Magnetic Contact	CU11 3a1b AC110V	1	Standard
E0701020	M0	Magnetic Contact	CU11 3a1b AC110V	1	Standard
E3101009	FU 	Fuse Seat	E16	4	For Asia
E3101011	Fu1·Fu2·Fu3	Fuse	E16 16A	3	For Asia 200V~240V
E3101010	Fu1·Fu2·Fu3	Fuse	E16 30A	3	For Asia 380V~480V
E3101013	FU 	Fuse	E16 6A	1	For Asia
	TR	Transformer	100VA	1	Optional
E0207055	OL1	Overload Relay	RHU-10/5.5-7.5	1	For 220V~240V
E0207054	OL1	Overload Relay	RHU-10/3.5-4.8	1	For 380V~480V
E0207054	OL2	Overload Relay	RHU-10/3.5-4.8	1	For 220V~240V
E0207053	OL2	Overload Relay	RHU-10/1.8-2.5	1	For 380V~480V
E1203002	PB1	Emg.Push Button Switch	Ø30 1A1B SBT-307	1	Standard
E1304001	SS1 	Selector Switch	ST 251	1	Standard
E1604001	SS2	Selector Switch	SN1021	1	Standard
E1605001	SS3	Cross Switch	3Joint.UP1A.Down1A Left1A1B.Right1A1B	1	Optional
E0901021	SS3	Basic Switch	V-15-1E5	4	Standard
E1202022 E1202023	SS4 	Push Button	ZB4-BA2+ZB4-BZ101	1	Standard
E1202022 E1202023	SS5 	Push Button	ZB4-BA2+ZB4-BZ101	1	Standard
E3501002	SS6	Power Supply	S-50-24	1	Optional
E0901021	LS1	Basic Switch	V-15-1E5	1	Standard
E0901014	LS2	Micro Switch	1308	1	Standard
E0901014	LS3	Micro Switch	1308	1	Standard
E0901014	LS4	Micro Switch	1308	1	Standard
E2305002	L1 	Pilot Light	Ø22 24V(W)	1	Optional
E2305004	L1 	Pilot Light	Ø22 110V(W)	1	Standard
E1701002	L2 	Work Lamp	FS51441 110V	1	Standard

Part NO.	Symbol	Description	Specification	Q'ty	Remark
E3602002		Amp Meter	S065 20A	1	For 200V~240V
E3602003		Amp Meter	S065 10A	1	For 380V~480V
		Main Motor	Vertical 2HP/4P/3PH	1	Standard
		Elevating Motor	Horizontal 2HP/4P/3PH	1	Standard
		Coolant Pump Motor	1/HP/2P/3PH L:130mm	1	Standard
E0703004	M0	Magnetic Contact	CU11 3a1b AC24V	1	Standard
E0703004	M1	Magnetic Contact	CU11 3a1b AC24V	1	Optional
E0703004	M2	Magnetic Contact	CU11 3a1b AC24V	1	Optional
E0703004	M3	Magnetic Contact	CU11 3a1b AC24V	1	Optional
E0703004	M4	Magnetic Contact	CU11 3a1b AC24V	1	Optional
E0703004	M5	Magnetic Contact	CU11 3a1b AC24V	1	Optional
E2802013		Fuse Seat	1P(14*51)	1	For u.s.a
E3101016		Fuse	ONE-TIME 5A	1	For u.s.a
E2802003		Fuse Seat	3P(14*51)	1	For u.s.a
E3101014		Fuse	ONE-TIME 30A	3	For u.s.a 200V~240V
E3101015		Fuse	ONE-TIME 20A	3	For u.s.a 380V~480V
E3101019		Fuse Seat	10*38	1	For Europe
E3101025		Fuse	10*38*6A	1	For Europe
E3101027		Fuse	10*38*20A	3	For Europe

9.9 Electrical Circuit Diagram

(For TPR1100 Standard 24V)

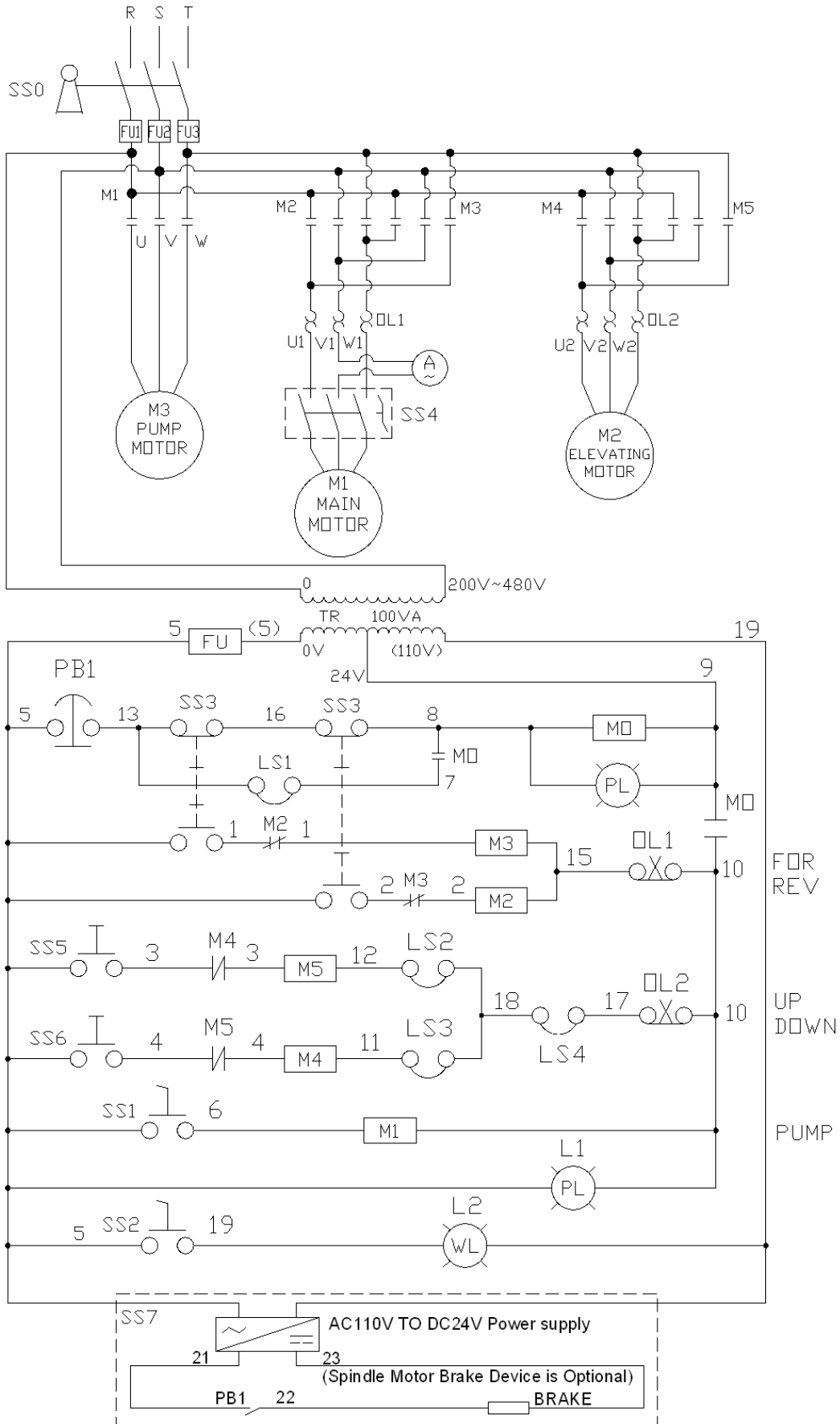





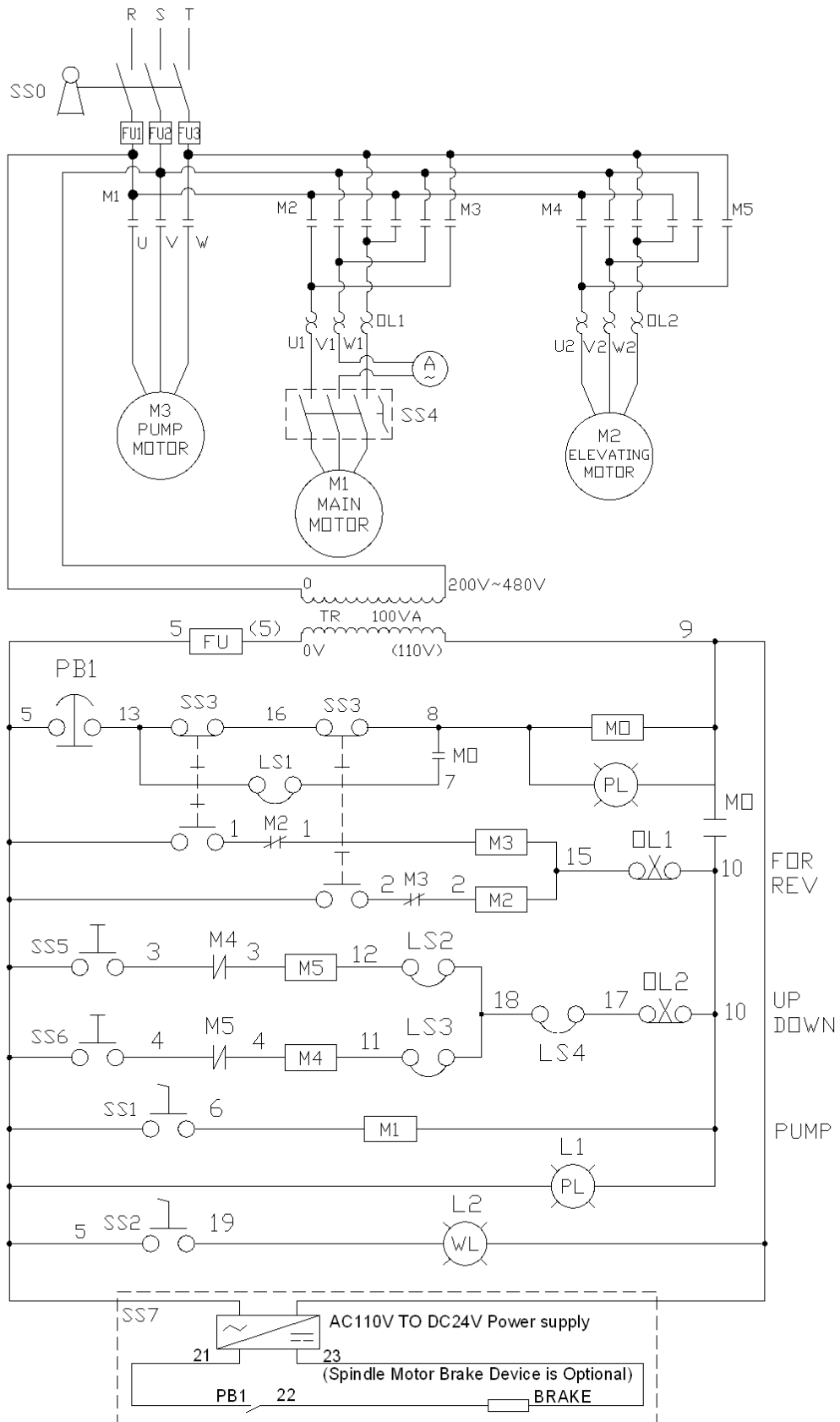

9.10 Electrical Circuit Diagram





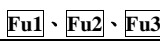
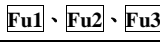

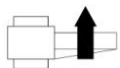



















(For TPR1100 Standard 110V)



9.11 Electrical main parts list

(For TPR1100 Standard)

Part NO.	Symbol	Description	Specification	Q'ty	Remark
E1602004	SS0 	Key Switch	COD TF323	1	Optional
E0701020	M1	Magnetic Contact	CU11 3a1b 110V	1	Standard
E0701021	M2	Magnetic Contact	CU18 110V	1	Standard
E0701021	M3	Magnetic Contact	CU18 110V	1	Standard
E0701020	M4	Magnetic Contact	CU11 3a1b 110V	1	Standard
E0701020	M5	Magnetic Contact	CU11 3a1b 110V	1	Standard
E0701020	M0	Magnetic Contact	CU11 3a1b 110V	1	Standard
E3101009	FU 	Fuse Seat	E-16	4	For Asia
E3101011	Fu1、Fu2、Fu3 	Fuse	E16 16A	3	For Asia 380V~480V
E3101010	Fu1、Fu2、Fu3 	Fuse	E16 30A	3	For Asia 200V~480V
E3101013	FU	Fuse	E16 6A	1	For Asia
	TR	Transformer	100VA	1	Optional
E0207057	OL1	Overload Relay	RHU-10/11.3-16	1	For 200V~240V
E0207056	OL1	Overload Relay	RHU-10/9-12.5	1	For 380V~480V
E0207054	OL2	Overload Relay	RHU-10/3.5-4.8	1	For 220V~240V
E0207053	OL2	Overload Relay	RHU-10/1.8-2.5	1	For 380V~480V
E1203002	PB1	Emg.Push Button Switch	Ø30 1A1B SBT-307	1	Standard
E1303001	SS1	Selector Switch	ST 302	1	Standard
E1604001	SS2 	Selector Switch	SN1021	1	Standard
E1605001	SS3	Cross Switch	3 Joint UP1A Down1A Left1A1B Right1A1B	1	Optional
E0901021	SS3	Limit Switch	V-15-1E5	4	Standard
E1603001	SS4	Pole Reversing Switch	A441 CA10	1	Standard
E1202022 E1202023	SS4 	Push Button	ZB4-BA2+ZB4-BZ101	1	Standard
E1202022 E1202023	SS6 	Push Button	ZB4-BA2+ZB4-BZ101	1	Standard
E3501002	SS7	Power Supply	S-50-24	1	Optional
E0901006	LS1	Micro Switch	1309	1	Standard
E0901014	LS2	Micro Switch	1308	1	Standard
E0901014	LS3	Micro Switch	1308	1	Standard
E0901034	LS4	Micro Switch	TZ-7311	1	Standard
E2303006	L1 	Pilot Light	Ø30 110V (W)	1	Standard

Part NO.	Symbol	Description	Specification	Q'ty	Remark
E2305001	L1 	Pilot Light	Ø30 24V(W)	1	Optional
E2303007	L2 	Pilot Light	Ø30 110V (R)	1	Standard
E2305003	L2 	Pilot Light	Ø30 24V(R)	1	Optional
E1701002	L3 	Work Lamp	FS51441	1	Standard
E3602001		Amp Meter	S065 30A	1	For 200V~240V
E3602002		Amp Meter	S065 20A	1	For 380V~480V
		Main Motor	Vertical 3HP/1.5HP/4P/8P	1	Standard
		Elevating Motor	Horizontal 1HP/4P/3PH	1	Standard
		Coolant Pump Motor	1/8HP/2P/3PH L:130mm	1	Standard
E0703004	M0	Magnetic Contact	CU11 3a1b AC24V	1	Optional
E0703004	M1	Magnetic Contact	CU11 3a1b AC24V	1	Optional
E0703005	M2	Magnetic Contact	CU18 3a1a1b AC24V	1	Optional
E0703005	M3	Magnetic Contact	CU18 3a1a1b AC24V	1	Optional
E0703004	M4	Magnetic Contact	CU11 3a1b AC24V	1	Optional
E0703004	M5	Magnetic Contact	CU11 3a1b AC24V	1	Optional
E2802003		Fuse Seat	3P(14*51)	1	For U.S.A
E2802013		Fuse Seat	1P(14*51)	1	For U.S.A
E3101016		Fuse	ONE-TIME 5A	1	For U.S.A
E3101014	 Fu1、  Fu2、  Fu3	Fuse	ONE-TIME 30A	3	For U.S.A 200~240V
E3101015	 Fu1、  Fu2、  Fu3	Fuse	ONE-TIME 20A	3	For U.S.A 380~480V
E3101019		Fuse Seat	10*38	1	For Europe
E3101025		Fuse	10*38(6A)	1	For Europe
E3101023	 Fu1、  Fu2、  Fu3	Fuse	10*38 16A	3	For U.S.A 380~480V
E3101028	 Fu1、  Fu2、  Fu3	Fuse	10*38 32A	3	For U.S.A 200~240V