

SH. 1
OF 1

CAT NO

491-24-4R

CUSTOMER DIMENSIONS

DO NOT
SEPARATE
PRINT FROM
WORK

LOT NO

OPER

TOOLS

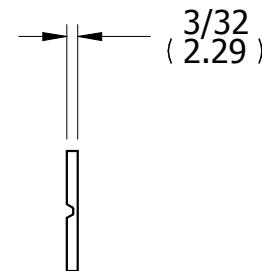
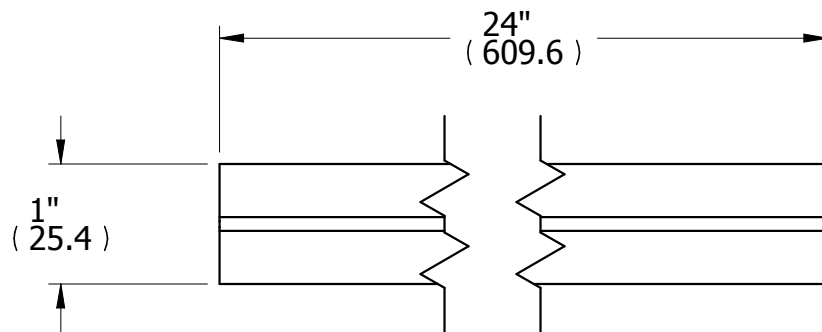
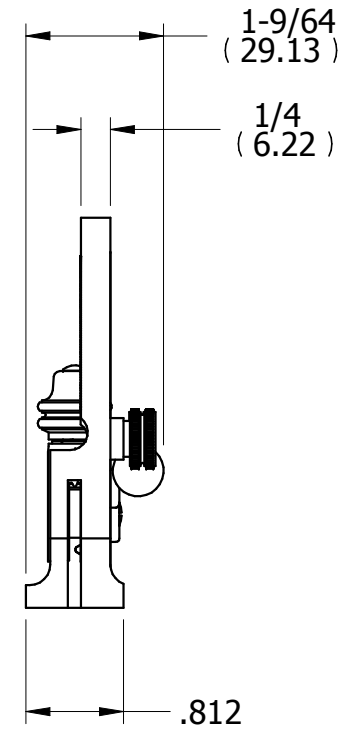
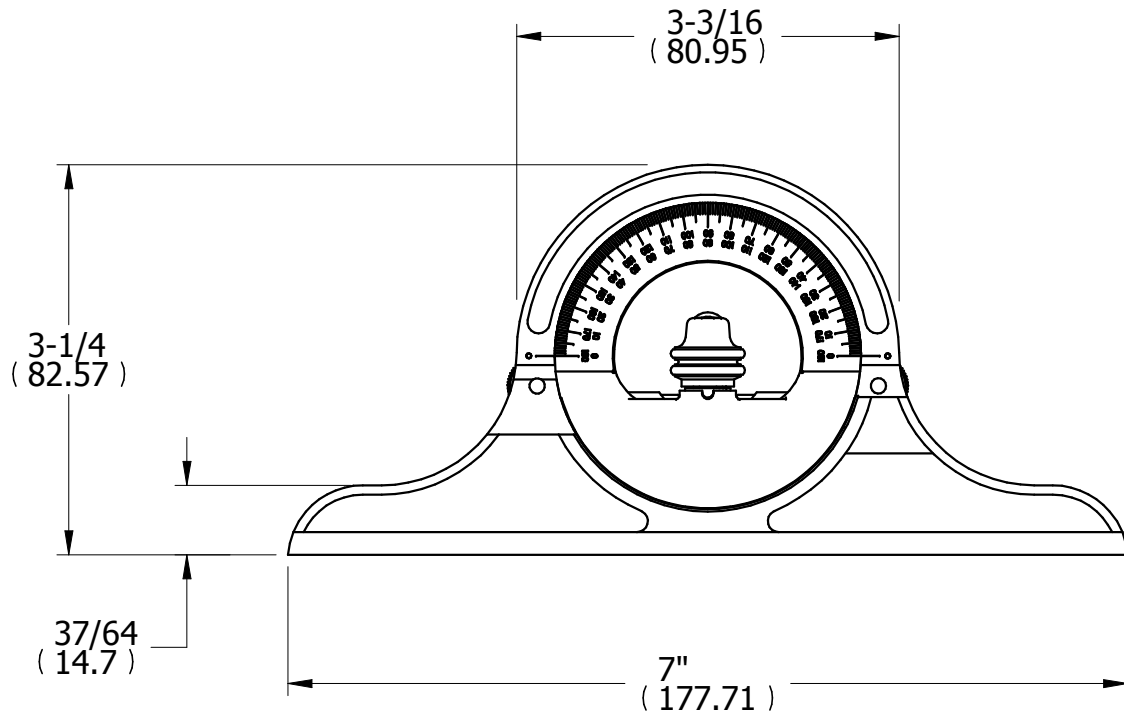

REV	DESCRIPTION	DATE	BY
-----	-------------	------	----

DR	JEG	CHK	DATE
----	-----	-----	------

REVERSIBLE BEVEL
PROTRACTOR

THE L.S. STARRETT CO.
ATHOL, MASS.

FRACTIONAL TOLERANCE +- 1/64 UNLESS OTHERWISE NOTED