

SH. 1
OF 1

CAT NO

674-3

CUSTOMER DIMENSIONS

DO NOT
SEPARATE
PRINT FROM
WORK

LOT NO

OPER

TOOLS

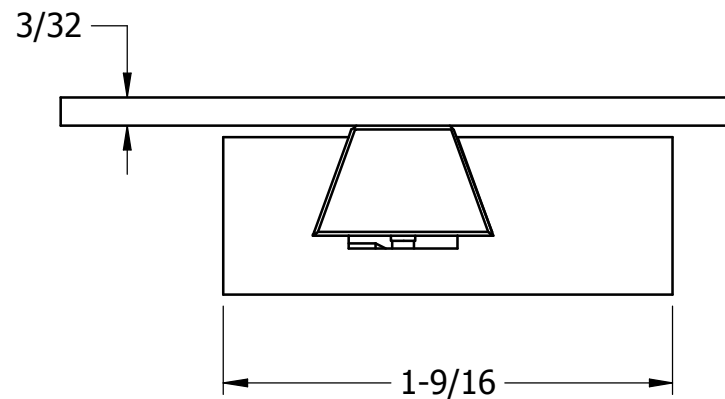
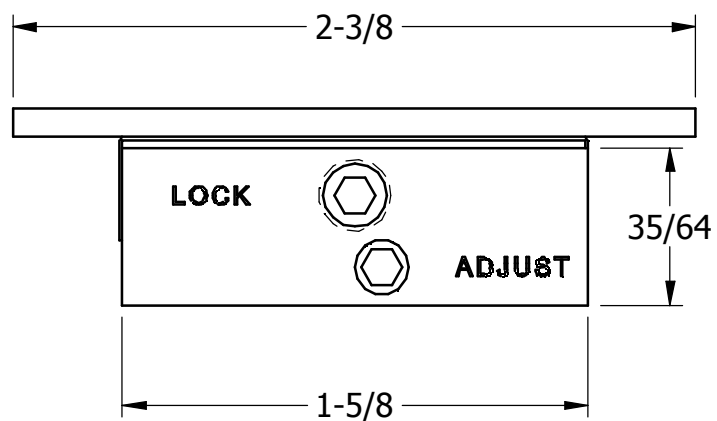
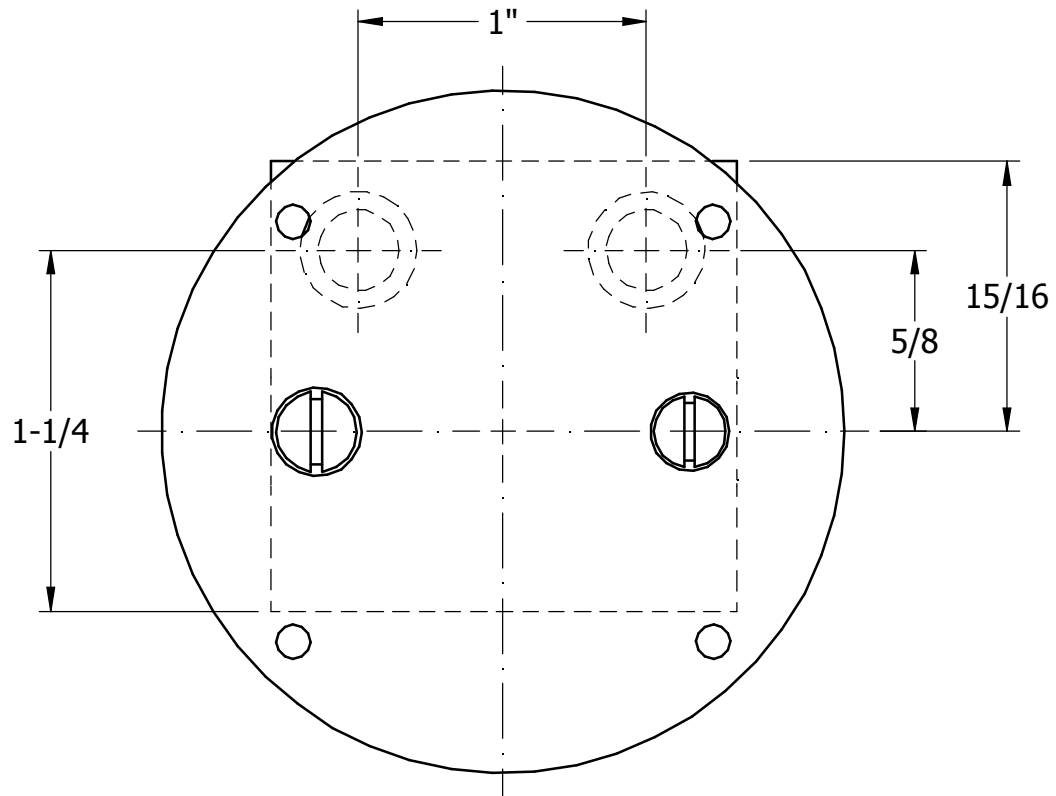

REV	DESCRIPTION	DATE	BY
DR	WRB	CHK	DATE

**DOVETAIL ADJUSTABLE
BACK INDICATOR HOLDER
ASSEMBLY**

**THE L.S. STARRETT CO.
ATHOL, MASS.**

FRACTIONAL TOLERANCE +- 1/64 UNLESS OTHERWISE NOTED